

**ENVIRONMENTAL PROTECTION AGENCY**

**40 CFR Parts 9, 22, 85, 86, 600, 1033, 1036, 1037, 1039, 1042, 1043, 1065, 1066, and 1068**

**DEPARTMENT OF TRANSPORTATION**

**National Highway Traffic Safety Administration**

**49 CFR Parts 523, 534, 535, and 538**

[EPA-HQ-OAR-2014-0827; NHTSA-2014-0132; FRL-9950-25-OAR]

RIN 2060-AS16; RIN 2127-AL52

**Greenhouse Gas Emissions and Fuel Efficiency Standards for Medium- and Heavy-Duty Engines and Vehicles—Phase 2**

**AGENCY:** Environmental Protection Agency (EPA) and National Highway Traffic Safety Administration (NHTSA), Department of Transportation (DOT).

**ACTION:** Final rule.

**SUMMARY:** EPA and NHTSA, on behalf of the Department of Transportation, are establishing rules for a comprehensive Phase 2 Heavy-Duty (HD) National Program that will reduce greenhouse gas (GHG) emissions and fuel consumption from new on-road medium- and heavy-duty vehicles and engines. NHTSA's fuel consumption standards and EPA's carbon dioxide (CO<sub>2</sub>) emission standards are tailored to each of four regulatory categories of heavy-duty vehicles: Combination tractors; trailers used in combination with those tractors; heavy-duty pickup trucks and vans; and vocational vehicles. The rule also includes separate standards for the engines that power combination tractors and vocational vehicles. Certain requirements for control of GHG emissions are exclusive to the EPA program. These include EPA's hydrofluorocarbon standards to control leakage from air conditioning systems in vocational vehicles and EPA's nitrous oxide (N<sub>2</sub>O) and methane (CH<sub>4</sub>) standards for heavy-duty engines. Additionally, NHTSA is addressing misalignment between the Phase 1 EPA

GHG standards and the NHTSA fuel efficiency standards to virtually eliminate the differences. This action also includes certain EPA-specific provisions relating to control of emissions of pollutants other than GHGs. EPA is finalizing non-GHG emission standards relating to the use of diesel auxiliary power units installed in new tractors. In addition, EPA is clarifying the classification of natural gas engines and other gaseous-fueled heavy-duty engines. EPA is also finalizing technical amendments to EPA rules that apply to emissions of non-GHG pollutants from light-duty motor vehicles, marine diesel engines, and other nonroad engines and equipment. Finally, EPA is requiring that engines from donor vehicles installed in new glider vehicles meet the emission standards applicable in the year of assembly of the new glider vehicle, including all applicable standards for criteria pollutants, with limited exceptions for small businesses and for other special circumstances.

**DATES:** This final rule is effective on December 27, 2016. The incorporation by reference of certain publications listed in this regulation is approved by the Director of the Federal Register as of December 27, 2016.

**ADDRESSES:** EPA and NHTSA have established dockets for this action under Docket ID No. EPA-HQ-OAR-2014-0827 (for EPA's docket) and NHTSA-2014-0132 (for NHTSA's docket). All documents in the docket are listed on the <https://www.regulations.gov> Web site. Although listed in the index, some information is not publicly available, e.g., CBI or other information whose disclosure is restricted by statute. Certain other material, such as copyrighted material, is not placed on the Internet and will be publicly available only in hard copy form. Publicly available docket materials are available either electronically in <https://www.regulations.gov> or in hard copy at the following locations:

**EPA:** Air and Radiation Docket and Information Center, EPA Docket Center, EPA/DC, EPA WJC West Building, 1301 Constitution Ave. NW., Room 3334, Washington, DC. The Public Reading

Room is open from 8:30 a.m. to 4:30 p.m., Monday through Friday, excluding legal holidays. The telephone number for the Public Reading Room is (202) 566-1744, and the telephone number for the Air Docket is (202) 566-1742.

**NHTSA:** Docket Management Facility, M-30, U.S. Department of Transportation, West Building, Ground Floor, Rm. W12-140, 1200 New Jersey Avenue SE., Washington, DC 20590. The telephone number for the docket management facility is (202) 366-9324. The docket management facility is open between 9 a.m. and 5 p.m. Eastern Time, Monday through Friday, except Federal Holidays.

**FOR FURTHER INFORMATION CONTACT:**

**EPA:** Tad Wysor, Office of Transportation and Air Quality, Assessment and Standards Division (ASD), Environmental Protection Agency, 2000 Traverwood Drive, Ann Arbor, MI 48105; telephone number: (734) 214-4332; email address: [wysor.tad@epa.gov](mailto:wysor.tad@epa.gov).

**NHTSA:** Ryan Hagen, Office of Chief Counsel, National Highway Traffic Safety Administration, 1200 New Jersey Avenue SE., Washington, DC 20590. Telephone: (202) 366-2992; [ryan.hagen@dot.gov](mailto:ryan.hagen@dot.gov).

**SUPPLEMENTARY INFORMATION:**

**A. Does this action apply to me?**

This action will affect companies that manufacture, sell, or import into the United States new heavy-duty engines and new Class 2b through 8 trucks, including combination tractors, all types of buses, vocational vehicles including municipal, commercial, recreational vehicles, and commercial trailers as well as ¾-ton and 1-ton pickup trucks and vans. The heavy-duty category incorporates all motor vehicles with a gross vehicle weight rating of 8,500 lbs. or greater, and the engines that power them, except for medium-duty passenger vehicles already covered by the greenhouse gas standards and corporate average fuel economy standards issued for light-duty model year 2017–2025 vehicles.<sup>1</sup> Regulated categories and entities include the following:

Category	NAICS code <sup>a</sup>	Examples of potentially affected entities
Industry .....	336111 336112 333618 336120 336212	Motor Vehicle Manufacturers, Engine Manufacturers, Truck Manufacturers, Truck Trailer Manufacturers.
Industry .....	541514 811112	Commercial Importers of Vehicles and Vehicle Components.

<sup>1</sup> As discussed in Section I.A, the term heavy-duty is generally used in this rulemaking to refer

to all vehicles with a gross vehicle weight rating above 8,500 lbs, including vehicles that are

sometimes otherwise known as medium-duty vehicles.

Category	NAICS code <sup>a</sup>	Examples of potentially affected entities
Industry .....	811198 336111 336112 422720 454312 541514 541690 811198	Alternative Fuel Vehicle Converters.

**Note:**

<sup>a</sup>North American Industry Classification System (NAICS).

This table is not intended to be exhaustive, but rather provides a guide for readers regarding entities likely covered by these rules. This table lists the types of entities that the agencies are aware may be regulated by this action. Other types of entities not listed in the table could also be regulated. To determine whether your activities are regulated by this action, you should carefully examine the applicability criteria in the referenced regulations. You may direct questions regarding the applicability of this action to the persons listed in the preceding **FOR FURTHER INFORMATION CONTACT** section.

### B. Did EPA conduct a peer review before issuing this document?

This regulatory action is supported by influential scientific information. Therefore, EPA conducted a peer review consistent with OMB's Final Information Quality Bulletin for Peer Review. As described in Section II.C, a peer review of updates to the vehicle simulation model (GEM) for the Phase 2 standards has been completed. This version of GEM is based on the model used for the Phase 1 rule, which was peer reviewed by a panel of four independent subject matter experts. The peer review report and EPA's response to the peer review comments are available in Docket ID No. EPA-HQ-OAR-2014-0827. We note that this rulemaking is based on a vast body of existing peer-reviewed work, *i.e.*, work that was peer-reviewed outside of this action, as noted in the references throughout this Preamble, the Regulatory Impacts Analysis, and the rulemaking docket. EPA also notified the SAB of its plans for this rulemaking and on June 11, 2014, the chartered SAB discussed the recommendations of its work group on the planned action and agreed that no further SAB consideration of the supporting science was merited.

### C. Executive Summary

#### (1) Commitment to Greenhouse Gas Emission Reductions and Vehicle Fuel Efficiency

In June 2013, the President announced a comprehensive Climate Action Plan for the United States to reduce carbon pollution, prepare for the impacts of climate change, and lead international efforts to address global climate change.<sup>2</sup> In this plan, President Obama reaffirmed his commitment to reduce U.S. greenhouse gas emissions in the range of 17 percent below 2005 levels by 2020. More recently, in December 2015, the U.S. was one of over 190 signatories to the Paris Climate Agreement, widely regarded as the most ambitious climate change agreement in history. The Paris agreement reaffirms the goal of limiting global temperature increase to well below 2 degrees Celsius, and for the first time urged efforts to limit the temperature increase to 1.5 degrees Celsius. The U.S. submitted a non-binding intended nationally determined contribution (NDC) target of reducing economy-wide GHG emissions by 26–28 percent below its 2005 level in 2025 and to make best efforts to reduce emissions by 28 percent.<sup>3</sup> This pace would keep the U.S. on a trajectory to achieve deep economy-wide reductions on the order of 80 percent by 2050.

As part of his Climate Action plan, the President specifically directed the Environmental Protection Agency (EPA) and the Department of Transportation's (DOT) National Highway Traffic Safety Administration (NHTSA) to set the next round of standards to reduce greenhouse gas (GHG) emissions and improve fuel efficiency for heavy-duty vehicles pursuant to and consistent with the agencies' existing statutory

authorities.<sup>4</sup> More than 70 percent of the oil used in the United States and 26 percent of GHG emissions come from the transportation sector, and since 2009 EPA and NHTSA have worked with industry, states, and other stakeholders to develop ambitious, flexible standards for both the fuel economy and GHG emissions of light-duty vehicles and the fuel efficiency and GHG emissions of heavy-duty vehicles.<sup>5 6</sup> The standards here (referred to as Phase 2) will build on the light-duty vehicle standards spanning model years 2012 to 2025 and on the initial phase of standards (referred to as Phase 1) for new medium and heavy-duty vehicles (MDVs and HDVs) and engines in model years 2014 to 2018. Throughout every stage of development for these programs, EPA and NHTSA (collectively, the agencies, or "we") have worked in close partnership not only with one another, but also with the vehicle manufacturing industry, environmental community leaders, and the State of California among other entities to create a single, effective set of national standards.

Through two previous rulemakings, EPA and NHTSA have worked with the auto industry to develop new fuel economy and GHG emission standards for light-duty vehicles. Taken together with NHTSA's 2011 CAFE standards, the light-duty vehicle standards span model years 2011 to 2025 and are the first significant improvement in fuel economy in approximately two decades. Under the final program, average new car and light truck fuel economy is expected to nearly double by 2025

<sup>4</sup> EPA's HD Phase 2 GHG emission standards are authorized under the Clean Air Act, and NHTSA's HD Phase 2 fuel consumption standards are authorized under the Energy Independence and Security Act of 2007.

<sup>5</sup> The White House, Improving the Fuel Efficiency of American Trucks—Bolstering Energy Security, Cutting Carbon Pollution, Saving Money and Supporting Manufacturing Innovation (Feb. 2014), 2.

<sup>6</sup> U.S. Environmental Protection Agency. April 2016. Inventory of U.S. Greenhouse Gas Emissions and Sinks: 1990–2012. EPA 430-R-16-002. Mobile sources emitted 28 percent of all U.S. GHG emissions in 2012. Available at <https://www3.epa.gov/climatechange/Downloads/ghgemissions/US-GHG-Inventory-2016-Main-Text.pdf>.

<sup>2</sup> The White House, The President's Climate Action Plan (June, 2013). <http://www.whitehouse.gov/share/climate-action-plan>.

<sup>3</sup> United States of America, Intended Nationally Determined Contribution, March 31, 2015, <http://www4.unfccc.int/submissions/INDC/Published%20Documents/United%20States%20of%20America/1/U.S.%20Cover%20Note%20INDC%20and%20Accompanying%20Information.pdf>.

compared to 2010 vehicles.<sup>7</sup> In the 2012 rule, the agencies projected the standards would save consumers \$1.7 trillion at the pump—roughly \$8,200 per vehicle for a MY 2025 vehicle—reducing oil consumption by 2.2 million barrels a day in 2025 and slashing GHG emissions by 6 billion metric tons over the lifetime of the vehicles sold during this period.<sup>8</sup> These fuel economy standards are already delivering savings for American drivers. Between model years 2008 and 2013, the unadjusted average test fuel economy of new passenger cars and light trucks sold in the United States has increased by about four miles per gallon. Altogether, light-duty vehicle fuel economy standards finalized after 2008 have already saved nearly one billion gallons of fuel and avoided more than 10 million tons of carbon dioxide emissions.<sup>9</sup>

Similarly, EPA and NHTSA have previously developed joint GHG emission and fuel efficiency standards for MDVs and HDVs. Prior to these Phase 1 standards, heavy-duty trucks and buses—from delivery vans to the largest tractor-trailers—were required to meet pollution standards for soot and smog-causing air pollutants, but no requirements existed for the fuel efficiency or carbon pollution from these vehicles.<sup>10</sup> By 2010, total fuel consumption and GHG emissions from MDVs and HDVs had been growing, and these vehicles accounted for 23 percent of total U.S. transportation-related GHG emissions<sup>11</sup> and about 20 percent of U.S. transportation-related energy use. In August 2011, the agencies finalized the groundbreaking Phase 1 standards for new MDVs and HDVs in model years 2014 through 2018. This program, developed with support from the trucking and engine industries, the State of California, Environment and Climate Change Canada, and leaders from the environmental community, set standards based on the use of off-the-shelf technologies. These standards are expected to save a projected 530 million barrels of oil and reduce carbon emissions by about 270 million metric tons, representing one of the most significant programs available to reduce domestic fuel consumption and emissions of GHGs.<sup>12</sup> The Phase 1 program, as well as the many additional

actions called for in the President's 2013 Climate Action Plan<sup>13</sup> including this Phase 2 rulemaking, not only result in meaningful decreases in GHG emissions and fuel consumption, but also support—indeed are critical for—United States leadership to encourage other countries to also achieve meaningful GHG reductions and fuel conservation.

This rule builds on our commitment to robust collaboration with stakeholders and the public. It follows an expansive and thorough outreach effort in which the agencies gathered input, data and views from many interested stakeholders, involving over 400 meetings with heavy-duty vehicle and engine manufacturers, technology suppliers, trucking fleets, truck drivers, dealerships, environmental organizations, and state agencies.<sup>14</sup> As with the previous light-duty rules and the heavy-duty Phase 1 rule, the agencies have consulted frequently with the California Air Resources Board (CARB) staff during the development of this rule, given California's unique ability among the states to adopt their own GHG standards for on-highway engines and vehicles. Through this close coordination, the agencies are finalizing a Phase 2 program that will be fully aligned between EPA and NHTSA, while providing CARB with the opportunity to adopt a Phase 2 program that will allow manufacturers to continue to build a single fleet of vehicles and engines.

#### *(2) Overview of Phase 1 Medium- and Heavy-Duty Vehicle Standards*

The Phase 1 program covers new trucks and heavy vehicles in model years 2014 and later. That program includes specific standards for combination tractors, heavy-duty pickup trucks and vans, and vocational vehicles and includes separate standards for both vehicles and engines. The program offers extensive flexibility, allowing manufacturers to reach standards through average fleet calculations, a mix of technologies, and the use of various credit and banking programs.

The Phase 1 program was developed by the agencies through close consultation with industry and other stakeholders, resulting in standards tailored to the specifics of each different class of vehicles and engines.

• *Heavy-duty combination tractors.* Combination tractors—semi trucks that

typically pull trailers—are regulated under nine subcategories based on weight class, cab type, and roof height. These vehicles represent approximately 60 percent of the fuel consumption and GHG emissions from MDVs and HDVs.

• *Heavy-duty pickup trucks and vans.* Heavy-duty pickup and van standards are based on a “work factor” attribute that combines a vehicle's payload, towing capabilities, and the presence of 4-wheel drive. These vehicles represent about 23 percent of the fuel consumption and GHG emissions from MDVs and HDVs.

• *Vocational vehicles.* Specialized vocational vehicles, which consist of a very wide variety of truck and bus types (e.g., delivery, refuse, utility, dump, cement, transit bus, shuttle bus, school bus, emergency vehicles, and recreational vehicles) are regulated in three subcategories based on engine classification. These vehicles represent approximately 17 percent of the fuel consumption and GHG emissions from MDVs and HDVs. The Phase 1 program includes EPA GHG standards for recreational vehicles, but not NHTSA fuel efficiency standards.<sup>15</sup>

• *Heavy-duty engines.* The Phase 1 rule has independent standards for heavy-duty engines to assure they contribute to reducing GHG emissions and fuel consumption because the Phase 1 tractor and vocational vehicle standards do not account for the contributions of engine improvements to reducing fuel consumption and GHG emissions.

The Phase 1 standards were premised on utilization of technologies that were already in production on some vehicles at the time of the Phase 1 FRM and are adaptable to the broader fleet. The Phase 1 program provides flexibilities that facilitate compliance. These flexibilities help provide sufficient lead time for manufacturers to make necessary technological improvements and reduce the overall cost of the program, without compromising overall environmental and fuel consumption objectives. The primary flexibility provisions are an engine averaging, banking, and trading (ABT) program and a vehicle ABT program. These ABT programs allow for emission and/or fuel consumption credits to be averaged, banked, or traded within each of the averaging sets.

The Phase 1 program was projected to save 530 million barrels of oil and avoid 270 million metric tons of GHG emissions.<sup>16</sup> At the same time, the

<sup>7</sup> The White House, *Improving the Fuel Efficiency of American Trucks—Bolstering Energy Security, Cutting Carbon Pollution, Saving Money and Supporting Manufacturing Innovation* (Feb. 2014), 2.

<sup>8</sup> *Id.*

<sup>9</sup> *Id.* at 3.

<sup>10</sup> *Id.*

<sup>11</sup> *Id.*

<sup>12</sup> *Id.* at 4.

<sup>13</sup> The President's Climate Action Plan calls for GHG-cutting actions including, for example, reducing carbon emissions from power plants and curbing hydrofluorocarbon and methane emissions.

<sup>14</sup> “Heavy-Duty Phase 2 Stakeholder Meeting Log”, August 2016.

<sup>15</sup> The Phase 2 program will also include NHTSA recreational vehicle fuel efficiency standards.

<sup>16</sup> The White House, *Improving the Fuel Efficiency of American Trucks—Bolstering Energy*

program was projected to produce \$50 billion in fuel savings and \$49 billion of net societal benefits. Today, the Phase 1 fuel efficiency and GHG reduction standards are already reducing GHG emissions and U.S. oil consumption, and producing fuel savings for America's trucking industry. The market appears to be very accepting of the Phase 1 technologies.

### (3) Overview of Phase 2 Medium- and Heavy-Duty Vehicle Standards

The Phase 2 GHG and fuel efficiency standards for MDVs and HDVs are a critical next step in improving fuel efficiency and reducing GHG emissions. The Phase 2 national program carries forward our commitment to meaningful collaboration with stakeholders and the public, as they build on more than 400 meetings with manufacturers, suppliers, trucking fleets, dealerships, state air quality agencies, non-governmental organizations (NGOs), and other stakeholders; over 200,000 public comments; and two public hearings to identify and understand the opportunities and challenges involved with this next level of fuel-saving technology. These meetings and public feedback, in addition to close coordination with CARB, have been invaluable to the agencies, enabling the development of a program that appropriately balances all potential impacts, effectively minimizes the possibility of unintended consequences, and allows manufacturers to continue to build a single fleet of vehicles and engines.

Phase 2 will include technology-advancing standards that will phase in over the long-term (through model year 2027) to result in an ambitious, yet achievable program that will allow manufacturers to meet standards through a mix of different technologies at reasonable cost. The terminal requirements go into effect in 2027, and would apply to MY 2027 and subsequent model year vehicles, unless modified by future rulemaking. The Phase 2 standards will maintain the underlying regulatory structure developed in the Phase 1 program, such as the general categorization of MDVs and HDVs and the separate standards for vehicles and engines. However, the Phase 2 program will build on and advance Phase 1 in a number of important ways including the following: basing standards not only on currently available technologies but also on utilization of technologies now under

development or not yet widely deployed while providing significant lead time to assure adequate time to develop, test, and phase in these controls; developing first-time GHG and fuel efficiency standards for trailers; further encouraging innovation and providing flexibility; including vehicles produced by small business manufacturers with appropriate flexibilities for these companies; incorporating enhanced test procedures that (among other things) allow individual drivetrain and powertrain performance to be reflected in the vehicle certification process; and using an expanded and improved compliance simulation model.

The Phase 2 program will provide significant GHG reductions and save fuel by:

- *Strengthening standards to account for ongoing technological advancements.* Relative to the baseline as of the end of Phase 1, these final standards are projected to achieve vehicle fuel savings as high as 25 percent, depending on the vehicle category. While costs are higher than for Phase 1, benefits greatly exceed costs, and payback periods are short, meaning that consumers will see substantial net savings over the vehicle lifetime. Payback is estimated at about two years for tractors and trailers, about four years for vocational vehicles, and about three years for heavy-duty pickups and vans. The agencies are finalizing a program that phases in the MY 2027 standards with interim standards for model years 2021 and 2024 (and for certain types of trailers, EPA is finalizing model year 2018 phase-in standards as well). The final program includes both significant strengthening of certain standards from the NPRM as well as adjustments to better align other standards with new data, analysis, and stakeholder and public feedback received since the time of the proposal.

- *Setting standards for trailers for the first time.* In addition to retaining the vehicle and engine categories covered in the Phase 1 program, the Phase 2 standards include fuel efficiency and GHG emission standards for trailers used in combination with tractors. Although the agencies are not finalizing standards for all trailer types, the majority of new trailers will be covered.

- *Encouraging technological innovation while providing flexibility and options for manufacturers.* For each category of HDVs, the standards will set performance targets that allow manufacturers to achieve reductions

through a mix of different technologies and generally leave manufacturers free to choose any means of compliance. For tractor standards, for example, different combinations of improvements like advanced aerodynamics, engine improvements and waste-heat recovery, automated transmission, lower rolling resistance tires, and automatic tire inflation can be used to meet standards. For tractors and vocational vehicles, enhanced test procedures and an expanded and improved compliance simulation model enable the vehicle standards to encompass more of the complete vehicle than the Phase 1 program and to account for engine, transmission and driveline improvements. With the addition of the powertrain and driveline to the compliance model, representative drive cycles and vehicle baseline configurations become critically important to assure the standards promote technologies that improve real world fuel efficiency and GHG emissions. This rule updates drive cycles and vehicle configurations to better reflect real world operation. The final program includes adjustments to technical elements of the proposed compliance program, e.g., test procedures, reflecting the significant amount of stakeholder and public comment the agencies received on the program. Additionally, the agencies' analyses indicate that this rule should have no adverse impact on vehicle or engine safety.

- *Providing flexibilities to help minimize effect on small businesses.* All small businesses are exempt from the Phase 1 standards. The agencies are regulating small business entities under Phase 2 (notably certain trailer manufacturers), but we have conducted extensive proceedings pursuant to section 609 of the Regulatory Flexibility Act, and engaged in extensive consultation with stakeholders, and developed an approach to provide targeted flexibilities geared toward helping small businesses comply with the Phase 2 standards. Specifically, the agencies are delaying the initial implementation of the Phase 2 standards by one year and simplifying certification requirements for small businesses. We are also adopting additional flexibilities and exemptions adapted to particular vehicle categories.

The following tables summarize the impacts of the Heavy-Duty Phase 2 rule.



**SUMMARY OF THE PHASE 2 MEDIUM- AND HEAVY-DUTY VEHICLE RULE IMPACTS TO FUEL CONSUMPTION, GHG EMISSIONS, BENEFITS AND COSTS OVER THE LIFETIME OF MODEL YEARS 2018–2029<sup>a b</sup>**

	3%	7%
Fuel Reductions (billion gallons) .....	71–82	
GHG Reductions (MMT, CO <sub>2</sub> eq) .....	959–1098	
Pre-Tax Fuel Savings (\$billion) .....	149–169	80–87
Discounted Technology Costs (\$billion) .....	24–27	16–18
Value of reduced emissions (\$billion) .....	60–69	48–52
Total Costs (\$billion) .....	29–31	19–20
Total Benefits (\$billion) .....	225–260	136–151
Net Benefits (\$billion) .....	197–229	117–131

**Notes:**

<sup>a</sup> Ranges reflect two analysis methods: Method A with the 1b baseline and Method B with the 1a baseline. For an explanation of analytical Methods A and B, please see Section I.D; for an explanation of the “flat” baseline, 1a, and the “dynamic” baseline, 1b, please see Section X.A.1.

<sup>b</sup> Benefits and net benefits (including those in the 7% discount rate column) use the 3 percent average Social Cost of CO<sub>2</sub>, the Social Cost of CH<sub>4</sub>, and the Social Cost of N<sub>2</sub>O.

**SUMMARY OF THE PHASE 2 MEDIUM- AND HEAVY-DUTY VEHICLE ANNUAL FUEL AND GHG REDUCTIONS, PROGRAM COSTS, BENEFITS AND NET BENEFITS IN CALENDAR YEARS 2040 AND 2050<sup>a</sup>**

	2040	2050
Fuel Reductions (Billion Gallons) .....	10.8	13.0
GHG Reduction (MMT, CO <sub>2</sub> eq) .....	166.8	199.3
Vehicle Program Costs (including Maintenance; Billions of 2013\$) .....	–\$6.5	–\$7.5
Fuel Savings (Pre-Tax; Billions of 2013\$) .....	\$53.1	\$63.4
Benefits (Billions of 2013\$) .....	\$24.8	\$31.7
Net Benefits (Billions of 2013\$) .....	\$71.4	\$87.6

**Note:**

<sup>a</sup> Benefits and net benefits (including those in the 7% discount rate column) use the 3 percent average Social Cost of CO<sub>2</sub>, the Social Cost of CH<sub>4</sub>, and the Social Cost of N<sub>2</sub>O. Values reflect the final program using Method B relative to the flat baseline (a reference case that projects very little improvement in new vehicle fuel economy absent new standards).

**SUMMARY OF THE PHASE 2 MEDIUM- AND HEAVY-DUTY VEHICLE PROGRAM EXPECTED PER-VEHICLE FUEL SAVINGS, GHG EMISSION REDUCTIONS, AND COST FOR KEY VEHICLE CATEGORIES**

	MY 2021	MY 2024	MY 2027
Maximum Vehicle Fuel Savings and Tailpipe GHG Reduction (%):			
Tractors <sup>b</sup> .....	13	20	25
Trailers <sup>a</sup> .....	5	7	9
Vocational Vehicles <sup>b</sup> .....	12	20	24
Pickups/Vans .....	2.5	10	16
Per Vehicle Cost (\$) <sup>c d</sup> (% Increase in Typical Vehicle Price):			
Tractors .....	\$6,400–\$6,480 (6%)	\$9,920–\$10,100 (10%)	\$12,160–\$12,440 (12%)
Trailers .....	\$850–\$870 (3%)	\$1,000–\$1,030 (4%)	\$1,070–\$1,110 (4%)
Vocational Vehicles .....	\$1,110–\$1,160 (1%)	\$1,980–\$2,020 (2%)	\$2,660–\$2,700 (3%)
Pickups/Vans .....	\$520–\$750 (1%)	\$760–\$960 (2%)	\$1,340–\$1,360 (3%)

**Notes:**

<sup>a</sup> Note that the EPA standards for trailers begin in model year 2018

<sup>b</sup> All engine costs are included

<sup>c</sup> Please refer to Preamble Chapters 6 and 10 for additional information on the reference fleet used to analyze costs and benefits of the rule. Please also refer to these chapters for impacts of the rule under more dynamic baseline assumptions for pickups and vans.

<sup>d</sup> Ranges reflect two analysis methods: Method A with the 1b baseline and Method B with the 1a baseline. For an explanation of analytical Methods A and B, please see Section I.D; for an explanation of the “flat” baseline, 1a, and the “dynamic” baseline, 1b, please see Section X.A.1.

<sup>e</sup> For this table, we use an approximate minimum vehicle price today of \$100,000 for tractors, \$25,000 for trailers, \$100,000 for vocational vehicles and \$40,000 for HD pickups/vans.

**PAYBACK PERIODS FOR MY 2027 VEHICLES UNDER THE FINAL STANDARDS, BASED ON BOTH ANALYSIS METHODS A AND B**

[Payback occurs in the year shown; using 7% discounting]

	Final standards
Tractors/Trailers .....	2nd.
Vocational Vehicles .....	4th.
Pickups/Vans <sup>a</sup> .....	3rd.

**Note:**

<sup>a</sup>Please refer to Preamble Chapters 6 and 10 for additional information on the reference fleet used to analyze costs and benefits of the rule. Please also refer to these chapters for impacts of the rule under more dynamic baseline assumptions for pickups and vans.

*(4) Issues Addressed in This Final Rule*

This Preamble contains extensive discussion of the background, elements, and implications of the Phase 2 program, as well as updates made to the final program from the proposal based on new data, analysis, stakeholder feedback and public comments. Section I includes information on the MDV and HDV industry, related regulatory and non-regulatory programs, summaries of Phase 1 and Phase 2 programs, costs and benefits of the final standards, and relevant statutory authority for EPA and NHTSA. Section II discusses vehicle simulation, engine standards, and test procedures. Sections III, IV, V, and VI detail the final standards for combination tractors, trailers, vocational vehicles, and heavy-duty pickup trucks and vans. Sections VII and VIII discuss aggregate GHG impacts, fuel consumption impacts, climate impacts, and impacts on non-GHG emissions. Section IX evaluates the economic impacts of the final program. Sections X and XI present the alternatives analyses and consideration of natural gas vehicles. Finally, Sections XII and XIII discuss the changes that the Phase 2 rules will have on Phase 1 standards and other regulatory provisions. In addition to this Preamble, the Regulatory Impact Analysis (RIA),<sup>17</sup> provides additional data, analysis and discussion of the standards, and the Response to Comments Document for Joint Rulemaking (RTC) provides responses to comments received on the Phase 2 rulemaking through the public comment process.<sup>18</sup>

**Table of Contents**

A. Does this action apply to me?

<sup>17</sup> Available on EPA and NHTSA's Web sites and in the public docket for this rulemaking.

<sup>18</sup> Available on EPA's Web site and in the public docket for this rulemaking.

- B. Did EPA conduct a peer review before issuing this document?
- C. Executive Summary
- I. Overview
  - A. Background
  - B. Summary of Phase 1 Program
  - C. Summary of the Phase 2 Standards and Requirements
  - D. Summary of the Costs and Benefits of the Final Rules
  - E. EPA and NHTSA Statutory Authorities
  - F. Other Issues
- II. Vehicle Simulation and Separate Engine Standards for Tractors and Vocational Chassis
  - A. Introduction
  - B. Phase 2 Regulatory Structure
  - C. Phase 2 GEM and Vehicle Component Test Procedures
  - D. Engine Test Procedures and Engine Standards
- III. Class 7 and 8 Combination Tractors
  - A. Summary of the Phase 1 Tractor Program
  - B. Overview of the Phase 2 Tractor Program and Key Changes From the Proposal
  - C. Phase 2 Tractor Standards
  - D. Feasibility of the Final Phase 2 Tractor Standards
  - E. Phase 2 Compliance Provisions for Tractors
  - F. Flexibility Provisions
- IV. Trailers
  - A. The Trailer Industry
  - B. Overview of the Phase 2 Trailer Program and Key Changes From the Proposal
  - C. Phase 2 Trailer Standards
  - D. Feasibility of the Trailer Standards
  - E. Trailer Standards: Compliance and Flexibilities
- V. Class 2b–8 Vocational Vehicles
  - A. Summary of Phase 1 Vocational Vehicle Standards
  - B. Phase 2 Standards for Vocational Vehicles
  - C. Feasibility of the Vocational Vehicle Standards
  - D. Compliance Provisions for Vocational Vehicles
- VI. Heavy-Duty Pickups and Vans
  - A. Summary of Phase 1 HD Pickup and Van Standards
  - B. HD Pickup and Van Final Phase 2 Standards
  - C. Use of the CAFE Model in Heavy-Duty Rulemaking
  - D. NHTSA CAFE Model Analysis of the Regulatory Alternatives for HD Pickups and Vans: Method A
  - E. Analysis of the Regulatory Alternatives for HD Pickups and Vans: Method B
  - F. Compliance and Flexibility for HD Pickup and Van Standards
- VII. Aggregate GHG, Fuel Consumption, and Climate Impacts
  - A. What methodologies did the agencies use to project GHG emissions and fuel consumption impacts?
  - B. Analysis of Fuel Consumption and GHG Emissions Impacts Resulting From Final Standards
  - C. What are the projected reductions in fuel consumption and GHG emissions?
  - D. Climate Impacts and Indicators
- VIII. How will these rules impact non-GHG emissions and their associated effects?
  - A. Health Effects of Non-GHG Pollutants
  - B. Environmental Effects of Non-GHG Pollutants
  - C. Emissions Inventory Impacts
  - D. Air Quality Impacts of Non-GHG Pollutants
- IX. Economic and Other Impacts
  - A. Conceptual Framework
  - B. Vehicle-Related Costs Associated With the Program
  - C. Changes in Fuel Consumption and Expenditures
  - D. Maintenance Expenditures
  - E. Analysis of the Rebound Effect
  - F. Impact on Class Shifting, Fleet Turnover, and Sales
  - G. Monetized GHG Impacts
  - H. Monetized Non-GHG Health Impacts
  - I. Energy Security Impacts
  - J. Other Impacts
  - K. Summary of Benefits and Costs
  - L. Employment Impacts
  - M. Cost of Ownership and Payback Analysis
  - N. Safety Impacts
- X. Analysis of the Alternatives
  - A. What are the alternatives that the agencies considered?
  - B. How do these alternatives compare in overall fuel consumption and GHG emissions reductions?
- XI. Natural Gas Vehicles and Engines
  - A. Natural Gas Engine and Vehicle Technology
  - B. GHG Lifecycle Analysis for Natural Gas Vehicles
  - C. Projected Use of LNG and CNG
  - D. Natural Gas Emission Control Measures
  - E. Dimethyl Ether
- XII. Amendments to Phase 1 Standards
  - A. EPA Amendments
  - B. Other Compliance Provisions for NHTSA
- XIII. Other Regulatory Provisions
  - A. Amendments Related to Heavy-Duty Highway Engines and Vehicles
  - B. Amendments Affecting Glider Vehicles and Glider Kits
  - C. Applying the General Compliance Provisions of 40 CFR Part 1068 to Light-Duty Vehicles, Light-Duty Trucks, Chassis-Certified Class 2b and 3 Heavy-Duty Vehicles and Highway Motorcycles
  - D. Amendments to General Compliance Provisions in 40 CFR Part 1068
  - E. Amendments to Light-Duty Greenhouse Gas Program Requirements
  - F. Amendments to Highway and Nonroad Test Procedures and Certification Requirements
  - G. Amendments Related to Locomotives in 40 CFR Part 1033
  - H. Amendments Related to Nonroad Diesel Engines in 40 CFR Part 1039
  - I. Amendments Related to Marine Diesel Engines in 40 CFR Parts 1042 and 1043
  - J. Miscellaneous EPA Amendments
  - K. Competition Vehicles
  - L. Amending 49 CFR Parts 512 and 537 To Allow Electronic Submissions and Defining Data Formats for Light-Duty Vehicle Corporate Average Fuel Economy (CAFE) Reports
- XIV. Statutory and Executive Order Reviews
  - A. Executive Order 12866: Regulatory Planning and Review and Executive

- Order 13563: Improving Regulation and Regulatory Review
- B. National Environmental Policy Act
- C. Paperwork Reduction Act
- D. Regulatory Flexibility Act
- E. Unfunded Mandates Reform Act
- F. Executive Order 13132: Federalism
- G. Executive Order 13175: Consultation and Coordination With Indian Tribal Governments
- H. Executive Order 13045: Protection of Children From Environmental Health Risks and Safety Risks
- I. Executive Order 13211: Actions Concerning Regulations That Significantly Affect Energy Supply, Distribution, or Use
- J. National Technology Transfer and Advancement Act and 1 CFR Part 51
- K. Executive Order 12898: Federal Actions To Address Environmental Justice in Minority Populations and Low-Income Populations
- L. Endangered Species Act (ESA)
- M. Congressional Review Act (CRA)
- XV. EPA and NHTSA Statutory Authorities
- A. EPA
- B. NHTSA
- List of Subjects

## I. Overview

The agencies issued a Notice of Proposed Rulemaking (NPRM) on July 13, 2015, that proposed Phase 2 GHG and fuel efficiency standards for heavy-duty engines and vehicles.<sup>19</sup> The agencies also issued a Notice of Data Availability (NODA) on March 2, 2016, to solicit comment on new material not available at the time of the NPRM.<sup>20</sup> The agencies have revised the proposed standards and related requirements to address issues raised in public comments. Nevertheless, the final rules being adopted today remain fundamentally similar to the proposed rules.

Although the agencies describe the final requirements in this document, readers are encouraged to also read supporting materials that have been placed into the public dockets for these rules. In particular, the agencies note:

- The Final Regulatory Impact Analysis (RIA), provides additional technical information and analysis
- The Response to Comments Document for Joint Rulemaking (RTC), provides a detailed summary and analysis of public comments, including comments received in response to the NODA
- The NHTSA Final Environmental Impact Statement (FEIS)

This overview of the final Phase 2 GHG emissions and fuel efficiency standards includes a description of the heavy-duty truck industry and related

regulatory and non-regulatory programs, a summary of the Phase 1 GHG emissions and fuel efficiency program, a summary of the Phase 2 standards and requirements being finalized, a summary of the costs and benefits of the Phase 2 standards, discussion of EPA and NHTSA statutory authorities, and other issues.

### A. Background

For purposes of this Preamble (and consistent with all terminology used at proposal), the terms “heavy-duty” or “HD” are used to apply to all highway vehicles and engines that are not within the range of light-duty passenger cars, light-duty trucks, and medium-duty passenger vehicles (MDPV) covered by separate GHG and Corporate Average Fuel Economy (CAFE) standards.<sup>21</sup> (The terms also do not include motorcycles). Thus, in this rulemaking, unless specified otherwise, the heavy-duty category incorporates all vehicles with a gross vehicle weight rating above 8,500 lbs, and the engines that power them, except for MDPVs.<sup>22 23 24</sup> Note also that the terms heavy-duty truck and heavy-duty vehicle are sometimes used interchangeably, even though commercially the term heavy-duty truck can have a narrower meaning.

Consistent with the President’s direction, over the past three years as we have developed this rulemaking, the agencies have met on an on-going basis with a very large number of diverse stakeholders. This includes meetings, and in many cases site visits, with truck, trailer, and engine manufacturers; technology supplier companies and their trade associations (*e.g.*, transmissions, drivelines, fuel systems, turbochargers, tires, catalysts, and many others); line haul and vocational trucking firms and trucking associations; the trucking industries

owner-operator association; truck dealerships and dealers associations; trailer manufacturers and their trade association; non-governmental organizations (NGOs, including environmental NGOs, national security NGOs, and consumer advocacy NGOs); state air quality agencies; manufacturing labor unions; and many other stakeholders. In addition, EPA and NHTSA have consulted on an on-going basis with the California Air Resources Board (CARB) over the past three years as we developed the Phase 2 rule. CARB staff and managers have also participated with EPA and NHTSA in meetings with many external stakeholders, including those with vehicle OEMs and technology suppliers.<sup>25</sup>

EPA and NHTSA staff also participated in a large number of technical and policy conferences over the past three years related to the technological, economic, and environmental aspects of the heavy-duty trucking industry. The agencies also met with regulatory counterparts from several other nations who either have already or are considering establishing fuel consumption or GHG requirements, including outreach with representatives from the governments of Canada, the European Commission, Japan, and China.

These comprehensive outreach actions by the agencies provided us with information to assist in our identification of potential technologies that can be used to reduce heavy-duty GHG emissions and improve fuel efficiency. The outreach has also helped the agencies to identify and understand the opportunities and challenges involved with these standards for the heavy-duty trucks, trailers, and engines detailed in this Preamble, including time needed for implementation of various technologies and potential costs and fuel savings. The scope of this outreach effort to gather input for the proposal and final rulemaking included well over 400 meetings with stakeholders. These meetings and conferences have been invaluable to the agencies. We believe they enabled us to refine the proposal in such a way as to appropriately consider all of the potential impacts and to minimize the possibility of unintended consequences in the final rules.

<sup>21</sup> 2017 and Later Model Year Light-Duty Vehicle Greenhouse Gas Emissions and Corporate Average Fuel Economy Standards; Final Rule, 77 FR 62623, October 15, 2012.

<sup>22</sup> The CAA defines heavy-duty as a truck, bus or other motor vehicles with a gross vehicle weight rating exceeding 6,000 lbs (CAA section 202(b)(3)). The term HD as used in this action refers to a subset of these vehicles and engines.

<sup>23</sup> The Energy Independence and Security Act of 2007 requires NHTSA to set standards for commercial medium- and heavy-duty on-highway vehicles, defined as on-highway vehicles with a GVWR of 10,000 lbs or more, and work trucks, defined as vehicles with a GVWR between 8,500 and 10,000 lbs and excluding medium duty passenger vehicles.

<sup>24</sup> The term “medium-duty” is sometimes used to refer to the lighter end of this range of vehicles. This is typically in the context of statutes or reports that use the term “medium-duty.” For example, because the term medium-duty is used in EISA, the term is also used in much of the discussion of NHTSA’s statutory authority.

<sup>25</sup> Vehicle chassis manufacturers are known in this industry as original equipment manufacturers or OEMs.

<sup>19</sup> 80 FR 40137.

<sup>20</sup> 81 FR 10824.

(1) Brief Overview of the Heavy-Duty Truck Industry

The heavy-duty sector is diverse in several respects, including the types of manufacturing companies involved, the range of sizes of trucks and engines they produce, the types of work for which the trucks are designed, and the regulatory history of different subcategories of vehicles and engines. The current heavy-duty fleet encompasses vehicles from the “18-

wheeler” combination tractor-trailers one sees on the highway to the largest pickup trucks and vans, as well as vocational vehicles covering the range between these extremes. Together, the HD sector spans a wide range of vehicles with often specialized form and function. A primary indicator of the diversity among heavy-duty trucks is the range of load-carrying capability across the industry. The heavy-duty truck sector is often subdivided by vehicle weight classifications, as

defined by the vehicle’s gross vehicle weight rating (GVWR), which is a measure of the combined curb (empty) weight and cargo carrying capacity of the truck.<sup>26</sup> Table I–1 below outlines the vehicle weight classifications commonly used for many years for a variety of purposes by businesses and by several Federal agencies, including the Department of Transportation, the Environmental Protection Agency, the Department of Commerce, and the Internal Revenue Service.

TABLE I–1—VEHICLE WEIGHT CLASSIFICATION

Class	2b	3	4	5	6	7	8
GVWR (lb.) .....	8,501–10,000	10,001–14,000	14,001–16,000	16,001–19,500	19,501–26,000	26,001–33,000	>33,000

In the framework of these vehicle weight classifications, the heavy-duty truck sector refers to “Class 2b” through “Class 8” vehicles and the engines that power those vehicles.<sup>27</sup>

Unlike light-duty vehicles, which are primarily used for transporting passengers for personal travel, heavy-duty vehicles fill much more diverse operator needs. Heavy-duty pickup trucks and vans (Classes 2b and 3) are used chiefly as work trucks and vans, and as shuttle vans, as well as for personal transportation, with an average annual mileage in the range of 15,000 miles. The rest of the heavy-duty sector is used for carrying cargo and/or performing specialized tasks. “Vocational” vehicles, which span Classes 2b through 8, vary widely in size, including smaller and larger van trucks, utility “bucket” trucks, tank trucks, refuse trucks, urban and over-the-road buses, fire trucks, flat-bed trucks, and dump trucks, among others. The annual mileage of these vehicles is as varied as their uses, but for the most part tends to fall in between heavy-duty pickups/vans and the large combination tractors, typically from 15,000 to 150,000 miles per year.

Class 7 and 8 combination tractor-trailers—some equipped with sleeper cabs and some not—are primarily used for freight transportation. They are sold as tractors and operate with one or more trailers that can carry up to 50,000 lbs or more of payload, consuming significant quantities of fuel and producing significant amounts of GHG emissions. Together, Class 7 and 8 tractors and trailers account for

approximately 60 percent of the heavy-duty sector’s total CO<sub>2</sub> emissions and fuel consumption. Trailer designs vary significantly, reflecting the wide variety of cargo types. However, the most common types of trailers are box vans (dry and refrigerated), which are a focus of this Phase 2 rulemaking. The tractor-trailers used in combination applications can and frequently do travel more than 150,000 miles per year and can operate for 20–30 years.

Heavy-duty vehicles differ significantly from light-duty vehicles in other ways. In particular, we note that heavy-duty engines are much more likely to be rebuilt. In fact, it is common for Class 8 engines to be rebuilt multiple times. Commercial heavy-duty vehicles are often resold after a few years and may be repurposed by the second or third owner. Thus issues of resale value and adaptability have historically been key concerns for purchasers.

EPA and NHTSA have designed our respective standards in careful consideration of the diversity and complexity of the heavy-duty truck industry, as discussed in Section I.C.

(2) Related Regulatory and Non-Regulatory Programs

(a) History of EPA’s Heavy-Duty Regulatory Program and Assessments of the Impacts of Greenhouse Gases on Climate Change

To provide a context for EPA’s program to reduce greenhouse gas emissions from motor vehicles, this subsection provides an overview of two important related areas. First, we summarize the history of EPA’s heavy-

duty regulatory program, which provides a basis for the compliance structure of this rulemaking. Next we summarize EPA prior assessments of the impacts of greenhouse gases on climate change, which provides a basis for much of the analysis of the environmental benefits of this rulemaking.

(i) History of EPA’s Heavy-Duty Regulatory Program

Since the 1980s, EPA has acted several times to address tailpipe emissions of criteria pollutants and air toxics from heavy-duty vehicles and engines. During the last two decades these programs have primarily addressed emissions of particulate matter (PM) and the primary ozone precursors, hydrocarbons (HC) and oxides of nitrogen (NO<sub>x</sub>). These programs, which have successfully achieved significant and cost-effective reductions in emissions and associated health and welfare benefits to the nation, were an important basis of the Phase 1 program. See *e.g.* 66 FR 5002, 5008, and 5011–5012 (January 18, 2001) (detailing substantial public health benefits of controls of criteria pollutants from heavy-duty diesel engines, including bringing areas into attainment with primary (public health) PM NAAQS, or contributing substantially to such attainment); *National Petrochemical Refiners Association v. EPA*, 287 F. 3d 1130, 1134 (D.C. Cir. 2002) (referring to the “dramatic reductions” in criteria pollutant emissions resulting from the EPA on-

<sup>26</sup> GVWR describes the maximum load that can be carried by a vehicle, including the weight of the vehicle itself. Heavy-duty vehicles (including those designed for primary purposes other than towing) also have a gross combined weight rating (GCWR),

which describes the maximum load that the vehicle can haul, including the weight of a loaded trailer and the vehicle itself.

<sup>27</sup> Class 2b vehicles manufactured as passenger vehicles (Medium Duty Passenger Vehicles,

MDPVs) are covered by the light-duty GHG and fuel economy standards and therefore are not addressed in this rulemaking.

highway heavy-duty engine standards, and upholding all of the standards).

As required by the Clean Air Act (CAA), the emission standards implemented by these programs include standards that apply at the time that the vehicle or engine is sold and continue to apply in actual use. EPA's overall program goal has always been to achieve emissions reductions from the complete vehicles that operate on our roads. The agency has often accomplished this goal for many heavy-duty truck categories by regulating heavy-duty engine emissions. A key part of this success has been the development over many years of a well-established, representative, and robust set of engine test procedures that industry and EPA now use routinely to measure emissions and determine compliance with emission standards. These test procedures in turn serve the overall compliance program that EPA implements to help ensure that emissions reductions are being achieved. By isolating the engine from the many variables involved when the engine is installed and operated in a HD vehicle, EPA has been able to accurately address the contribution of the engine alone to overall emissions.

(ii) EPA Assessment of the Impacts of Greenhouse Gases on Climate Change

In 2009, the EPA Administrator issued the document known as the Endangerment Finding under CAA section 202(a)(1).<sup>28</sup> In the Endangerment Finding, which focused on public health and public welfare impacts within the United States, the Administrator found that elevated concentrations of GHG emissions in the atmosphere may reasonably be anticipated to endanger public health and welfare of current and future generations. See also *Coalition for Responsible Regulation v. EPA*, 684 F.3d 102, 117–123 (D.C. Cir. 2012) (upholding the endangerment finding in all respects). The following sections summarize the key information included in the Endangerment Finding.

Climate change caused by human emissions of GHGs threatens public health in multiple ways. By raising average temperatures, climate change increases the likelihood of heat waves, which are associated with increased deaths and illnesses. While climate change also decreases the likelihood of cold-related mortality, evidence indicates that the increases in heat mortality will be larger than the

decreases in cold mortality in the United States. Compared to a future without climate change, climate change is expected to increase ozone pollution over broad areas of the U.S., including in the largest metropolitan areas with the worst ozone problems, and thereby increase the risk of morbidity and mortality. Other public health threats also stem from projected increases in intensity or frequency of extreme weather associated with climate change, such as increased hurricane intensity, increased frequency of intense storms and heavy precipitation. Increased coastal storms and storm surges due to rising sea levels are expected to cause increased drownings and other adverse health impacts. Children, the elderly, and the poor are among the most vulnerable to these climate-related health effects. See also 79 FR 75242 (December 17, 2014) (climate change, and temperature increases in particular, likely to increase O<sub>3</sub> (ozone) pollution “over broad areas of the U.S., including the largest metropolitan areas with the worst O<sub>3</sub> problems, increas[ing] the risk of morbidity and mortality”).

Climate change caused by human emissions of GHGs also threatens public welfare in multiple ways. Climate changes are expected to place large areas of the country at serious risk of reduced water supplies, increased water pollution, and increased occurrence of extreme events such as floods and droughts. Coastal areas are expected to face increased risks from storm and flooding damage to property, as well as adverse impacts from rising sea level, such as land loss due to inundation, erosion, wetland submergence and habitat loss. Climate change is expected to result in an increase in peak electricity demand, and extreme weather from climate change threatens energy, transportation, and water resource infrastructure. Climate change may exacerbate ongoing environmental pressures in certain settlements, particularly in Alaskan indigenous communities. Climate change also is very likely to fundamentally rearrange U.S. ecosystems over the 21st century. Though some benefits may balance adverse effects on agriculture and forestry in the next few decades, the body of evidence points towards increasing risks of net adverse impacts on U.S. food production, agriculture and forest productivity as temperature continues to rise. These impacts are global and may exacerbate problems outside the U.S. that raise humanitarian, trade, and national security issues for the U.S. See also 79 FR 75382 (December 17, 2014) (welfare effects of

O<sub>3</sub> increases due to climate change, with emphasis on increased wildfires).

As outlined in Section VIII.A of the 2009 Endangerment Finding, EPA's approach to providing the technical and scientific information to inform the Administrator's judgment regarding the question of whether GHGs endanger public health and welfare was to rely primarily upon the recent, major assessments by the U.S. Global Change Research Program (USGCRP), the Intergovernmental Panel on Climate Change (IPCC), and the National Research Council (NRC) of the National Academies. These assessments addressed the scientific issues that EPA was required to examine, were comprehensive in their coverage of the GHG and climate change issues, and underwent rigorous and exacting peer review by the expert community, as well as rigorous levels of U.S. government review. Since the administrative record concerning the Endangerment Finding closed following EPA's 2010 Reconsideration Denial, a number of new major, peer-reviewed scientific assessments have been released. These include the IPCC's 2012 “Special Report on Managing the Risks of Extreme Events and Disasters to Advance Climate Change Adaptation” (SREX) and the 2013–2014 Fifth Assessment Report (AR5), the USGCRP's 2014 “Climate Change Impacts in the United States” (Climate Change Impacts), and the NRC's 2010 “Ocean Acidification: A National Strategy to Meet the Challenges of a Changing Ocean” (Ocean Acidification), 2011 “Report on Climate Stabilization Targets: Emissions, Concentrations, and Impacts over Decades to Millennia” (Climate Stabilization Targets), 2011 “National Security Implications for U.S. Naval Forces” (National Security Implications), 2011 “Understanding Earth's Deep Past: Lessons for Our Climate Future” (Understanding Earth's Deep Past), 2012 “Sea Level Rise for the Coasts of California, Oregon, and Washington: Past, Present, and Future,” 2012 “Climate and Social Stress: Implications for Security Analysis” (Climate and Social Stress), and 2013 “Abrupt Impacts of Climate Change” (Abrupt Impacts) assessments.

EPA has reviewed these new assessments and finds that the improved understanding of the climate system they present further strengthens the case that GHG emissions endanger public health and welfare.

In addition, these assessments highlight the urgency of the situation as the concentration of CO<sub>2</sub> in the atmosphere continues to rise. Absent a reduction in emissions, a recent

<sup>28</sup> “Endangerment and Cause or Contribute Findings for Greenhouse Gases Under Section 202(a) of the Clean Air Act,” 74 FR 66496 (December 15, 2009) (“Endangerment Finding”).

National Research Council assessment projected that concentrations by the end of the century would increase to levels that the Earth has not experienced for millions of years.<sup>29</sup> In fact, that assessment stated that “the magnitude and rate of the present greenhouse gas increase place the climate system in what could be one of the most severe increases in radiative forcing of the global climate system in Earth history.”<sup>30</sup> What this means, as stated in another NRC assessment, is that:

Emissions of carbon dioxide from the burning of fossil fuels have ushered in a new epoch where human activities will largely determine the evolution of Earth’s climate. Because carbon dioxide in the atmosphere is long lived, it can effectively lock Earth and future generations into a range of impacts, some of which could become very severe. Therefore, emission reductions choices made today matter in determining impacts experienced not just over the next few decades, but in the coming centuries and millennia.<sup>31</sup>

Moreover, due to the time-lags inherent in the Earth’s climate, the Climate Stabilization Targets assessment notes that the full warming from any given concentration of CO<sub>2</sub> reached will not be realized for several centuries.

The most recent USGCRP “National Climate Assessment”<sup>32</sup> emphasizes that climate change is already happening now and is happening in the United States. The assessment documents the increases in some extreme weather and climate events in recent decades, as well as the resulting damage and disruption to infrastructure and agriculture, and projects continued increases in impacts across a wide range of peoples, sectors, and ecosystems.

These assessments underscore the urgency of reducing emissions now. Today’s emissions will otherwise lead to raised atmospheric concentrations for thousands of years, and raised Earth system temperatures for even longer. Emission reductions today will benefit the public health and public welfare of current and future generations.

Finally, it should be noted that the concentration of carbon dioxide in the atmosphere continues to rise dramatically. In 2009, the year of the Endangerment Finding, the average concentration of carbon dioxide as measured on top of Mauna Loa was 387

parts per million.<sup>33</sup> The average concentration in 2015 was 401 parts per million, the first time an annual average has exceeded 400 parts per million since record keeping began at Mauna Loa in 1958, and for at least the past 800,000 years according to ice core records.<sup>34</sup> Moreover, 2015 was the warmest year globally in the modern global surface temperature record, going back to 1880, breaking the record previously held by 2014; this now means that the last 15 years have been 15 of the 16 warmest years on record.<sup>35</sup>

#### (b) The EPA and NHTSA Light-Duty National GHG and Fuel Economy Program

On May 7, 2010, EPA and NHTSA finalized the first-ever National Program for light-duty cars and trucks, which set GHG emissions and fuel economy standards for model years 2012–2016 (see 75 FR 25324). More recently, the agencies adopted even stricter standards for model years 2017 and later (77 FR 62624, October 15, 2012). The agencies have used the light-duty National Program as a model for the HD National Program in several respects. This is most apparent in the case of heavy-duty pickups and vans, which are similar to the light-duty trucks addressed in the light-duty National Program both technologically as well as in terms of how they are manufactured (*i.e.*, the same company often makes both the vehicle and the engine, and several light-duty manufacturers also manufacture HD pickups and vans).<sup>36</sup> For HD pickups and vans, there are close parallels to the light-duty program in how the agencies have developed our respective heavy-duty standards and compliance structures. However, HD pickups and vans are true work vehicles that are designed for much higher towing and payload capabilities than are light-duty pickups and vans. The technologies applied to light-duty trucks are not all applicable to heavy-duty pickups and vans at the same adoption rates, and the technologies often produce a lower percent reduction in CO<sub>2</sub> emissions and fuel consumption when used in heavy-duty vehicles. Another difference between the light-duty and the heavy-duty standards is that each agency adopts heavy-duty

standards based on attributes other than vehicle footprint, as discussed below.

Due to the diversity of the remaining HD vehicles, there are fewer parallels with the structure of the light-duty program. However, the agencies have maintained the same collaboration and coordination that characterized the development of the light-duty program throughout the Phase 1 rulemaking and the continued efforts for Phase 2. Most notably, as with the light-duty program, manufacturers will continue to be able to design and build vehicles to meet a closely coordinated, harmonized national program, and to avoid unnecessarily duplicative testing and compliance burdens. In addition, the averaging, banking, and trading provisions in the HD program, although structurally different from those of the light-duty program, serve the same purpose, which is to allow manufacturers to achieve large reductions in fuel consumption and emissions while providing a broad mix of products to their customers. The agencies have also worked closely with CARB to provide harmonized national standards.

#### (c) EPA’s SmartWay Program

EPA’s voluntary SmartWay Transport Partnership program encourages businesses to take actions that reduce fuel consumption and CO<sub>2</sub> emissions while cutting costs by working with the shipping, logistics, and carrier communities to identify low carbon strategies and technologies across their transportation supply chains. SmartWay provides technical information, benchmarking and tracking tools, market incentives, and partner recognition to facilitate and accelerate the adoption of these strategies. Through the SmartWay program and its related technology assessment center, EPA has worked closely with truck and trailer manufacturers and truck fleets over the past 12 years to develop test procedures to evaluate vehicle and component performance in reducing fuel consumption and has conducted testing and has established test programs to verify technologies that can achieve these reductions. SmartWay partners have demonstrated these new and emerging technologies in their business operations, adding to the body of technical data and information that EPA can disseminate to industry, researchers and other stakeholders. Over the last several years, EPA has developed hands-on experience testing the largest heavy-duty trucks and trailers and evaluating improvements in tire and vehicle aerodynamic performance. In developing the Phase 1

<sup>29</sup> National Research Council, *Understanding Earth’s Deep Past*, p. 1.

<sup>30</sup> *Id.*, p.138.

<sup>31</sup> National Research Council, *Climate Stabilization Targets*, p. 3.

<sup>32</sup> U.S. Global Change Research Program, *Climate Change Impacts in the United States: The Third National Climate Assessment*, May 2014 Available at <http://nca2014.globalchange.gov/>.

<sup>33</sup> [ftp://aftp.cmdl.noaa.gov/products/trends/co2/co2\\_annmean\\_mlo.txt](ftp://aftp.cmdl.noaa.gov/products/trends/co2/co2_annmean_mlo.txt).

<sup>34</sup> <http://www.esrl.noaa.gov/gmd/ccgg/trends/>.

<sup>35</sup> <http://www.ncdc.noaa.gov/sotc/global/201513>.

<sup>36</sup> This is more broadly true for heavy-duty pickup trucks than vans because every manufacturer of heavy-duty pickup trucks also makes light-duty pickup trucks, while only some heavy-duty van manufacturers also make light-duty vans.

program, the agencies drew from this testing and from the SmartWay experience. In the same way, the agencies benefitted from SmartWay in developing the Phase 2 trailer program.

(d) DOE's SuperTruck Initiative

The U.S. Department of Energy launched its SuperTruck I initiative in 2009. SuperTruck I was a DOE partnership with four industry teams, who at this point have either met the SuperTruck I 50 percent fuel efficiency improvement goal (relative to a 2009 best-in-class truck) or have laid the groundwork to succeed. Teams from Cummins/Peterbilt, Daimler, and Volvo exceeded the 50 percent efficiency improvement goal, with Navistar on track to exceed this target later this year. Research vehicles developed under SuperTruck I are Class 8 combination tractor-trailers that have dramatically increased fuel and freight efficiency through the use of advanced technologies. These technologies include tractor and trailer aerodynamic devices, engine waste heat recovery systems, hybrids, automated transmissions and lightweight materials. In March 2016 DOE announced SuperTruck II, which is an \$80M follow-on to SuperTruck I, where DOE will continue to partner with industry teams to collaboratively fund new projects to research, develop, and demonstrate technologies to further improve heavy-truck freight efficiency—by more than 100 percent, relative to a manufacturer's best-in-class 2009 truck. Achieving these kinds of Class 8 truck efficiency increases will require an integrated systems approach to ensure that the various components of the vehicle work well together. SuperTruck II projects will utilize a wide variety of truck and trailer technology approaches to achieve performance targets, such as further improvements in engine efficiency, drivetrain efficiency, aerodynamic drag, tire rolling resistance, and vehicle weight.

The agencies leveraged the outcomes of SuperTruck I by projecting how these tractor and trailer technologies could continue to advance from this early developmental stage toward the prototype and production stages. For a number of the SuperTruck technologies, the agencies are projecting advancement into production, given appropriate lead time. For example, a number of the aerodynamic and transmission technologies are projected to be in widespread production by 2021, and the agencies are finalizing 2021 standards based in part on performance of these SuperTruck technologies. For other more advanced SuperTruck

technologies, such as organic Rankine cycle waste heat recovery systems, the agencies are projecting that additional lead time is needed to ensure that these technologies will be effective and reliable in production. For these technologies, the agencies are finalizing 2027 standards whose stringency reflects a significant market adoption rate of advanced technologies, including waste heat recovery systems. Furthermore, the agencies are encouraged by DOE's announcement of SuperTruck II. We believe that the combination of HD Phase 2 and SuperTruck II will provide both a strong motivation and a proven means for manufacturers to fully develop these technologies within the lead times we have projected.

(e) The State of California

California has established ambitious goals for reducing GHG emissions from heavy-duty vehicles and engines as part of an overall plan to reduce GHG emissions from the transportation sector in California.<sup>37</sup> Heavy-duty vehicles are responsible for one-fifth of the total GHG emissions from transportation sources in California. In the past several years, the California Air Resources Board (CARB) has taken a number of actions to reduce GHG emissions from heavy-duty vehicles and engines. For example, in 2008, CARB adopted regulations to reduce GHG emissions from heavy-duty tractors that pull box-type trailers through improvements in tractor and trailer aerodynamics and the use of low rolling resistance tires.<sup>38</sup> The tractor-trailer operators subject to the CARB regulation are required to use SmartWay-certified tractors and trailers, or retrofit their existing fleet with SmartWay-verified technologies, consistent with California's state authority to regulate both new and in-use vehicles. In December 2013, CARB adopted regulations that establish its own parallel Phase 1 program with standards consistent with EPA Phase 1 standards. On December 5, 2014, California's Office of Administrative Law approved CARB's adoption of the Phase 1 standards, with an effective date of December 5, 2014.<sup>39</sup> Complementary

<sup>37</sup> See <http://www.arb.ca.gov/cc/cc.htm> for details on the California Air Resources Board climate change actions, including a discussion of Assembly Bill 32, and the Climate Change Scoping Plan developed by CARB, which includes details regarding CARB's future goals for reducing GHG emissions from heavy-duty vehicles.

<sup>38</sup> See <http://www.arb.ca.gov/msprog/truckstop/trailers/trailers.htm> for a summary of CARB's "Tractor-Trailer Greenhouse Gas Regulation."

<sup>39</sup> See <http://www.arb.ca.gov/regact/2013/hdghg2013/hdghg2013.htm> for details regarding CARB's adoption of the Phase 1 standards.

to its regulatory efforts, CARB and other California agencies are investing significant public capital through various incentive programs to accelerate fleet turnover and stimulate technology innovation within the heavy-duty vehicle market (e.g., Air Quality Improvement, Carl Moyer, Loan Incentives, Lower-Emission School Bus and Goods Movement Emission Reduction Programs).<sup>40</sup> Recently, California Governor Jerry Brown established a target of up to 50 percent petroleum reduction by 2030.

California has long had the unique ability among states to adopt its own separate new motor vehicle standards per section 209 of the Clean Air Act (CAA). Although section 209(a) of the CAA expressly preempts states from adopting and enforcing standards relating to the control of emissions from new motor vehicles or new motor vehicle engines (such as state controls for new heavy-duty engines and vehicles), CAA section 209(b) directs EPA to waive this preemption under certain conditions. Under the waiver process set out in CAA section 209(b), EPA has granted CARB a waiver for its initial heavy-duty vehicle GHG regulation.<sup>41</sup> Even with California's ability under the CAA to establish its own emission standards, EPA and CARB have worked closely together over the past several decades to largely harmonize new vehicle criteria pollutant standard programs for heavy-duty engines and heavy-duty vehicles. In the past several years EPA and NHTSA also consulted with CARB in the development of the Federal light-duty vehicle GHG and CAFE rulemakings for the 2012–2016 and 2017–2025 model years.

As discussed above, California operates under state authority to establish its own new heavy-duty vehicle and engine emission standards, including standards for CO<sub>2</sub>, methane, N<sub>2</sub>O, and hydrofluorocarbons. EPA recognizes this independent authority, and we also recognize the potential benefits for the regulated industry if the Federal Phase 2 standards could result

<sup>40</sup> See <http://www.arb.ca.gov/ba/fininfo.htm> for detailed descriptions of CARB's mobile source incentive programs. Note that EPA works to support CARB's heavy-duty incentive programs through the West Coast Collaborative (<http://westcoastcollaborative.org/>) and the Clean Air Technology Initiative (<https://www.epa.gov/cat/>).

<sup>41</sup> See EPA's waiver of CARB's heavy-duty tractor-trailer greenhouse gas regulation applicable to new 2011 through 2013 model year Class 8 tractors equipped with integrated sleeper berths (sleeper-cab tractors) and 2011 and subsequent model year dry-can and refrigerated-van trailers that are pulled by such tractors on California highways at 79 FR 46256 (August 7, 2014).



in a single, National Program that would meet the EPA and NHTSA's statutory requirements to set appropriate and maximum feasible standards, and also be equivalent to potential future new heavy-duty vehicle and engine GHG standards established by CARB (addressing the same model years as addressed by the final Federal Phase 2 program and requiring the same technologies). In order to further the opportunity for maintaining coordinated Federal and California standards in the Phase 2 timeframe (as well as to benefit from different technical expertise and perspective), EPA and NHTSA consulted frequently with CARB while developing the Phase 2 rule. Prior to the proposal, the agencies' technical staff shared information on technology cost, technology effectiveness, and feasibility with the CARB staff. We also received information from CARB on these same topics. In addition, CARB staff and managers participated with EPA and NHTSA in meetings with many external stakeholders, in particular with vehicle OEMs and technology suppliers. The agencies continued significant consultation during the development of the final rules.

EPA and NHTSA believe that through this information sharing and dialog we have enhanced the potential for the Phase 2 program to result in a National Program that can be adopted not only by the Federal agencies, but also by the State of California, given the strong interest from the regulated industry for a harmonized State and Federal program. In its public comments, California reiterated its support for a harmonized State and Federal program, although it identified several areas in which it believed the proposed program needed to be strengthened.

(f) Environment and Climate Change Canada

On March 13, 2013, Environment and Climate Change Canada (ECCC), which is EPA's Canadian counterpart, published its own regulations to control GHG emissions from heavy-duty vehicles and engines, beginning with MY 2014. These regulations are closely aligned with EPA's Phase 1 program to achieve a common set of North American standards. ECCC has expressed its intention to amend these regulations to further limit emissions of greenhouse gases from new on-road heavy-duty vehicles and their engines for post-2018 MYs. As with the development of the current regulations, ECCC is committed to continuing to work closely with EPA to maintain a common Canada–United States approach to regulating GHG emissions

for post-2018 MY vehicles and engines. This approach will build on the long history of regulatory alignment between the two countries on vehicle emissions pursuant to the Canada–United States Air Quality Agreement.<sup>42</sup> In furtherance of this coordination, EPA participated in a workshop hosted by ECCC on March 3, 2016 to discuss Canada's Phase 2 program.<sup>43</sup>

The Government of Canada, including ECCC and Transport Canada, has also been of great assistance during the development of this Phase 2 rule. In particular, the Government of Canada supported aerodynamic testing, and conducted chassis dynamometer emissions testing.

(g) Recommendations of the National Academy of Sciences

In April 2010, as mandated by Congress in the EISA, the National Research Council (NRC) under the National Academy of Sciences (NAS) issued a report to NHTSA and to Congress evaluating medium- and heavy-duty truck fuel efficiency improvement opportunities, titled "Technologies and Approaches to Reducing the Fuel Consumption of Medium- and Heavy-duty Vehicles." That NAS report was far reaching in its review of the technologies that were available and that might become available in the future to reduce fuel consumption from medium- and heavy-duty vehicles. In presenting the full range of technical opportunities, the report included technologies that may not be available until 2020 or even further into the future. The report provided not only a valuable list of off-the-shelf technologies from which the agencies drew in developing the Phase 1 program, but also provided useful information the agencies have considered when developing this second phase of regulations.

In April 2014, the NAS issued another report: "Reducing the Fuel Consumption and Greenhouse Gas Emissions of Medium- and Heavy-Duty Vehicles, Phase Two, First Report."<sup>44</sup>

<sup>42</sup> [http://www.ijc.org/en/\\_Air\\_Quality\\_Agreement](http://www.ijc.org/en/_Air_Quality_Agreement).

<sup>43</sup> "Phase 2 of the Heavy-duty Vehicle and Engine Greenhouse Gas Emission Regulations; Pre-Consultation Session," March 3, 2016.

<sup>44</sup> National Research Council "Reducing the Fuel Consumption and Greenhouse Gas Emissions of Medium- and Heavy-Duty Vehicles, Phase Two." Washington, DC, The National Academies Press. Cooperative Agreement DTNH22–12–00389. Available electronically from the National Academy Press Web site at <http://www.nap.edu/catalog/18736/reducing-the-fuel-consumption-and-greenhouse-gas-emissions-of-medium-and-heavy-duty-vehicles-phase-two> (last accessed May 18, 2016). On September 24, 2016, NAS will release an

This study outlines a number of recommendations to the U.S. Department of Transportation and NHTSA on technical and policy matters to consider when addressing the fuel efficiency of our nation's medium- and heavy-duty vehicles. In particular, this report provided recommendations with respect to:

- The Greenhouse Gas Emission Model (GEM) simulation tool used by the agencies to assess compliance with vehicle standards
- Regulation of trailers
- Natural gas-fueled engines and vehicles
- Data collection on in-use operation

The agencies are adopting many of these recommendations into the Phase 2 program, including recommendations relating to the GEM simulation tool and to trailers.

*B. Summary of Phase 1 Program*

(1) EPA Phase 1 GHG Emission Standards and NHTSA Phase 1 Fuel Consumption Standards

The EPA Phase 1 mandatory GHG emission standards commenced in MY 2014 and include increased stringency for standards applicable to MY 2017 and later MY vehicles and engines. NHTSA's fuel consumption standards were voluntary for MYs 2014 and 2015, due to lead time requirements in EISA, and apply on a mandatory basis thereafter. They also increase in stringency for MY 2017. Both agencies allowed voluntary early compliance starting in MY 2013 and encouraged manufacturers' participation through credit incentives.

Given the complexity of the heavy-duty industry, the agencies divided the industry into three discrete categories for purposes of setting our respective Phase 1 standards—combination tractors, heavy-duty pickups and vans, and vocational vehicles—based on the relative degree of homogeneity among trucks within each category. The Phase 1 rules also include separate standards for the engines that power combination tractors and vocational vehicles. For each regulatory category, the agencies adopted related but distinct program approaches reflecting the specific challenges in these segments. In the following paragraphs, we briefly summarize EPA's Phase 1 GHG emission standards and NHTSA's Phase 1 fuel consumption standards for the three regulatory categories of heavy-duty vehicles and for the engines powering vocational vehicles and

update report, consistent with Congress' quinquennial update requirement.

tractors. See Sections II, III, V, and VI for additional details on the Phase 1 standards. To respect differences in design and typical uses that drive different technology solutions, the agencies segmented each regulatory class into subcategories. The category-specific structure enabled the agencies to set standards that appropriately reflect the technology available for each regulatory subcategory of vehicles and the engines for use in each type of vehicle. The Phase 1 program also provided several flexibilities, as summarized in Section I.B.(3).

The agencies proposed and are adopting Phase 2 standards based on test procedures that differ from those used for Phase 1, including the revised GEM simulation tool. Significant revisions to GEM are discussed in Section II and in the RIA Chapter 4, and other test procedures are discussed further in the RIA Chapter 3. The pre-proposal revisions from Phase 1 GEM reflected input from both the NAS and from industry.<sup>45</sup> Changes since the proposal generally reflect comments received from industry and other key stakeholders. It is important to note that due to these test procedure changes, the Phase 1 and Phase 2 standards are not directly comparable in an absolute sense. In particular, the revisions being made to the 55 mph and 65 mph highway cruise cycles for tractors and vocational vehicles have the effect of making the cycles more challenging (albeit more representative of actual driving conditions). We are not applying these revisions to the Phase 1 program because doing so would significantly change the stringency of the Phase 1 standards, for which manufacturers have already developed engineering plans and are now producing products to meet. Moreover, the changes to GEM address a broader range of technologies not part of the projected compliance path for use in Phase 1.

Because the numeric values of the Phase 2 tractor and vocational standards are not directly comparable to their respective Phase 1 standards, the Phase 1 numeric standards were not appropriate baseline values to use to determine Phase 2's improvements. To address this situation, the agencies applied all of the new Phase 2 test procedures and GEM software to tractors and vocational vehicles equipped with Phase 1 compliant levels of technology. The agencies used the results of this approach to establish appropriate Phase 1 baseline values,

<sup>45</sup> For further discussion of the input the agencies received from NAS, see Section XII of the Phase 2 NPRM at 80 FR 40512, July 13, 2015.

which are directly comparable to the Phase 2 standards. For example, in this rulemaking we present Phase 2 per vehicle percent reductions versus Phase 1, and for tractors and vocational vehicles these percent reductions were all calculated versus Phase 1 compliant vehicles, where we applied the Phase 2 test procedures and GEM software to determine these Phase 1 vehicles' results.

(a) Class 7 and 8 Combination Tractors

Class 7 and 8 combination tractors and their engines contribute the largest portion of the total GHG emissions and fuel consumption of the heavy-duty sector, approximately 60 percent, due to their large payloads, their high annual miles traveled, and their major role in national freight transport. These vehicles consist of a cab and engine (tractor or combination tractor) and a detachable trailer. The primary manufacturers of combination tractors in the United States are Daimler Trucks North America, Navistar, Volvo/Mack, and PACCAR. Each of the tractor manufacturers and Cummins (an independent engine manufacturer) also produce heavy-duty engines used in tractors. The Phase 1 standards require manufacturers to reduce GHG emissions and fuel consumption for these tractors and engines, which we expect them to do through improvements in aerodynamics and tires, reductions in tractor weight, reduction in idle operation, as well as engine-based efficiency improvements.<sup>46</sup>

The Phase 1 tractor standards differ depending on gross vehicle weight rating (GVWR) (*i.e.*, whether the truck is Class 7 or Class 8), the height of the roof of the cab, and whether it is a "day cab" or a "sleeping cab." The agencies created nine subcategories within the Class 7 and 8 combination tractor category reflecting combinations of these attributes. The agencies set Phase 1 standards for each of these subcategories beginning in MY 2014, with more stringent standards following in MY 2017. The standards represent an overall fuel consumption and CO<sub>2</sub> emissions reduction up to 23 percent from the tractors and the engines installed in them when compared to a baseline MY 2010 tractor and engine.

For Phase 1, tractor manufacturers demonstrate compliance with the tractor

<sup>46</sup> We note although the standards' stringency is predicated on use of certain technologies, and the agencies' assessed the cost of the rule based on the cost of use of those technologies, the standards can be met by any means. Put another way, the rules create a performance standard, and do not mandate any particular means of achieving that level of performance.

CO<sub>2</sub> and fuel consumption standards using a vehicle simulation tool described in Section II. The tractor inputs to the simulation tool in Phase 1 are the aerodynamic performance, tire rolling resistance, vehicle speed limiter, automatic engine shutdown, and weight reduction.

In addition to the Phase 1 tractor-based standards for CO<sub>2</sub>, EPA adopted a separate standard to reduce leakage of hydrofluorocarbon (HFC) refrigerant from cabin air conditioning (A/C) systems from combination tractors, to apply to the tractor manufacturer. This HFC leakage standard is independent of the CO<sub>2</sub> tractor standard. Manufacturers can choose technologies from a menu of leak-reducing technologies sufficient to comply with the standard, as opposed to using a test to measure performance. Given that HFC leakage does not relate to fuel efficiency, NHTSA did not adopt corresponding HFC standards.

(b) Heavy-Duty Pickup Trucks and Vans (Class 2b and 3)

Heavy-duty vehicles with a GVWR between 8,501 and 10,000 lb. are classified as Class 2b motor vehicles. Heavy-duty vehicles with a GVWR between 10,001 and 14,000 lb. are classified as Class 3 motor vehicles. Class 2b and Class 3 heavy-duty vehicles (referred to in these rules as "HD pickups and vans") together emit about 23 percent of today's GHG emissions from the heavy-duty vehicle sector.<sup>47</sup>

The majority of HD pickups and vans are 3/4-ton and 1-ton pickup trucks, 12- and 15-passenger vans,<sup>48</sup> and large work vans that are sold by vehicle manufacturers as complete vehicles, with no secondary manufacturer making substantial modifications prior to registration and use. These vehicles can also be sold as cab-complete vehicles (*i.e.*, incomplete vehicles that include complete or nearly complete cabs that are sold to secondary manufacturers). The majority of heavy-duty pickups and vans are produced by companies with major light-duty markets in the United States. Furthermore, the technologies available to reduce fuel consumption and GHG emissions from this segment are similar to the technologies used on light-duty pickup trucks, including both engine efficiency improvements (for gasoline and diesel engines) and vehicle efficiency improvements. For these reasons, EPA and NHTSA concluded

<sup>47</sup> EPA MOVES Model, <http://www3.epa.gov/otaq/models/moves/index.htm>.

<sup>48</sup> Note that 12-passenger vans are subject to the light-duty standards as medium-duty passenger vehicles (MDPVs) and are not subject to this proposal.

that it was appropriate to adopt GHG standards, expressed as grams per mile, and fuel consumption standards, expressed as gallons per 100 miles, for HD pickups and vans based on the whole vehicle (including the engine), consistent with the way these vehicles have been regulated by EPA for criteria pollutants and also consistent with the way their light-duty counterpart vehicles are regulated by EPA and NHTSA. This complete vehicle approach adopted by both agencies for HD pickups and vans was consistent with the recommendations of the NAS Committee in its 2010 Report.

For the light-duty GHG and fuel economy standards, the agencies based the emissions and fuel economy targets on vehicle footprint (the wheelbase times the average track width). For those standards, passenger cars and light trucks with larger footprints are assigned higher GHG and lower fuel economy target levels reflecting their inherent tendency to consume more fuel and emit more GHGs per mile. For HD pickups and vans, the agencies believe that setting standards based on vehicle attributes is appropriate, but have found that a work-based metric is a more appropriate attribute than the footprint attribute utilized in the light-duty vehicle rulemaking, given that work-based measures such as towing and payload capacities are critical elements of these vehicles' functionality. EPA and NHTSA therefore adopted standards for HD pickups and vans based on a "work factor" attribute that combines their payload and towing capabilities, with an added adjustment for 4-wheel drive vehicles.

Each manufacturer's fleet average Phase 1 standard is based on production volume-weighting of target standards for all vehicles, which in turn are based on each vehicle's work factor. These target standards are taken from a set of curves (mathematical functions), with separate curves for gasoline and diesel vehicles.<sup>49</sup> However, both gasoline and diesel vehicles in this category are included in a single averaging set. EPA phased in the CO<sub>2</sub> standards gradually starting in the 2014 MY, at 15–20–40–60–100 percent of the MY 2018 standards stringency level in MYs 2014–2015–2016–2017–2018, respectively (*i.e.*, the 2014 standards requires only 15 percent of the reduction required in 2018, etc.). The phase-in takes the form

of a set of target curves, with increasing stringency in each MY.

NHTSA allowed manufacturers to select one of two fuel consumption standard alternatives for MYs 2016 and later. The first alternative defined individual gasoline vehicle and diesel vehicle fuel consumption target curves that will not change for MYs 2016–2018, and are equivalent to EPA's 67–67–67–100 percent target curves in MYs 2016–2017–2018–2019, respectively. The second alternative defined target curves that are equivalent to EPA's 40–60–100 percent target curves in MYs 2016–2017–2018, respectively. NHTSA allowed manufacturers to opt voluntarily into the NHTSA HD pickup and van program in MYs 2014 or 2015 at target curves equivalent to EPA's target curves. If a manufacturer chose to opt in for one category, they would be required to opt in for all categories. In other words, a manufacturer would be unable to opt in for Class 2b vehicles, but opt out for Class 3 vehicles.

EPA also adopted an alternative phase-in schedule for manufacturers wanting to have stable standards for model years 2016–2018. The standards for heavy-duty pickups and vans, like those for light-duty vehicles, are expressed as set of target standard curves, with increasing stringency in each model year. The Phase 1 EPA standards for 2018 (including a separate standard to control air conditioning system leakage) are estimated to represent an average per-vehicle reduction in GHG emissions of 17 percent for diesel vehicles and 12 percent for gasoline vehicles (relative to pre-control baseline vehicles). The NHTSA standard will require these vehicles to achieve up to about 15 percent reduction in fuel consumption by MY 2018 (relative to pre-control baseline vehicles). Manufacturers demonstrate compliance based on entire vehicle chassis certification using the same duty cycles used to demonstrate compliance with criteria pollutant standards.

#### (c) Class 2b–8 Vocational Vehicles

Class 2b–8 vocational vehicles include a wide variety of vehicle types, and serve a vast range of functions. Some examples include service for parcel delivery, refuse hauling, utility service, dump, concrete mixing, transit service, shuttle service, school bus, emergency, motor homes, and tow trucks. In Phase 1, we defined Class 2b–8 vocational vehicles as all heavy-duty vehicles that are not included in either the heavy-duty pickup and van category or the Class 7 and 8 tractor category. EPA's and NHTSA's Phase 1 standards

for this vocational vehicle category generally apply at the chassis manufacturer level. Class 2b–8 vocational vehicles and their engines emit approximately 17 percent of the GHG emissions and burn approximately 17 percent of the fuel consumed by today's heavy-duty truck sector.<sup>50</sup>

The Phase 1 program for vocational vehicles has vehicle standards and separate engine standards, both of which differ based on the weight class of the vehicle into which the engine will be installed. The vehicle weight class groups mirror those used for the engine standards—Classes 2b–5 (light heavy-duty or LHD in EPA regulations), Classes 6 and 7 (medium heavy-duty or MHD in EPA regulations) and Class 8 (heavy heavy-duty or HHD in EPA regulations). Manufacturers demonstrate compliance with the Phase 1 vocational vehicle CO<sub>2</sub> and fuel consumption standards using a vehicle simulation tool described in Section II. The Phase 1 program for vocational vehicles limited the simulation tool inputs to tire rolling resistance. The model assumes the use of a typical representative, compliant engine in the simulation, resulting in one overall value for CO<sub>2</sub> emissions and one for fuel consumption.

#### (d) Engine Standards

The agencies established separate Phase 1 performance standards for the engines manufactured for use in vocational vehicles and Class 7 and 8 tractors.<sup>51</sup> These engine standards vary depending on engine size linked to intended vehicle service class. EPA's engine-based CO<sub>2</sub> standards and NHTSA's engine-based fuel consumption standards are being implemented using EPA's existing test procedures and regulatory structure for criteria pollutant emissions from heavy-duty engines. EPA also established engine-based N<sub>2</sub>O and CH<sub>4</sub> emission standards in Phase 1.

#### (e) Manufacturers Excluded From the Phase 1 Standards

Phase 1 deferred greenhouse gas emissions and fuel consumption standards for any manufacturers of heavy-duty engines, manufacturers of combination tractors, and chassis manufacturers for vocational vehicles that meet the "small business" size criteria set by the Small Business Administration (SBA). 13 CFR 121.201

<sup>50</sup> EPA MOVES model, <http://www3.epa.gov/otaq/models/moves/index.htm>.

<sup>51</sup> See 76 FR 57114 explaining why NHTSA's authority under the Energy Independence and Safety Act includes authority to establish separate engine standards.

<sup>49</sup> As explained in Section XI, as part of this rulemaking, EPA moved the Phase 1 requirements for pickups and vans from 40 CFR 1037.104 into 40 CFR part 86, which is also the regulatory part that applies for light-duty vehicles.

defines a small business by the maximum number of employees; for example, this is currently 1,500 for heavy-duty truck manufacturing and 1,000 for engine manufacturing.<sup>52</sup> In order to utilize this exemption, qualifying small businesses must submit a declaration to the agencies. See Section I.F.(1)(b) for a summary of how Phase 2 applies for small businesses.

The agencies stated that they would consider appropriate GHG and fuel consumption standards for these entities as part of a future regulatory action. This includes both U.S.-based and foreign small-volume heavy-duty manufacturers that introduce new products into the U.S.

### (2) Costs and Benefits of the Phase 1 Program

Overall, EPA and NHTSA estimated that the Phase 1 HD National Program will cost the affected industry about \$8 billion, while saving vehicle owners fuel costs of nearly \$50 billion over the lifetimes of MY 2014–2018 vehicles. The agencies also estimated that the combined standards will reduce CO<sub>2</sub> emissions by about 270 million metric tons and save about 530 million barrels of oil over the life of MY 2014 to 2018 vehicles. The agencies estimated additional monetized benefits from CO<sub>2</sub> reductions, improved energy security, reduced time spent refueling, as well as possible dis-benefits from increased driving crashes, traffic congestion, and noise. When considering all these factors, we estimated that Phase 1 of the HD National Program will yield \$49 billion in net benefits to society over the lifetimes of MY 2014–2018 vehicles.

EPA estimated the benefits of reduced ambient concentrations of particulate matter and ozone resulting from the Phase 1 program to range from \$1.3 to \$4.2 billion in 2030.<sup>53</sup>

In total, we estimated the combined Phase 1 standards will reduce GHG emissions from the U.S. heavy-duty fleet by approximately 76 million metric tons of CO<sub>2</sub>-equivalent annually by 2030. In its Environmental Impact Statement for the Phase 1 rule, NHTSA also quantified and/or discussed other potential impacts of the program, such as the health and environmental impacts associated with changes in ambient exposures to toxic air pollutants and the benefits associated with avoided non-

CO<sub>2</sub> GHGs (methane, nitrous oxide, and HFCs).

### (3) Phase 1 Program Flexibilities

As noted above, the agencies adopted numerous provisions designed to give manufacturers a degree of flexibility in complying with the Phase 1 standards. These provisions, which are essentially identical in structure and function in EPA's and NHTSA's regulations, enabled the agencies to consider overall standards that are more stringent and that will become effective sooner than we could consider with a more rigid program, one in which all of a manufacturer's similar vehicles or engines would be required to achieve the same emissions or fuel consumption levels, and at the same time.<sup>54</sup>

Phase 1 included four primary types of flexibility: Averaging, banking, and trading (ABT) provisions; early credits; advanced technology credits (including hybrid powertrains); and innovative technology credit provisions. The ABT provisions were patterned on existing EPA and NHTSA ABT programs (including the light-duty GHG and fuel economy standards) and will allow a vehicle manufacturer to reduce CO<sub>2</sub> emission and fuel consumption levels further than the level of the standard for one or more vehicles to generate ABT credits. The manufacturer can use those credits to offset higher emission or fuel consumption levels in the same averaging set, "bank" the credits for later use, or "trade" the credits to another manufacturer. As also noted above, for HD pickups and vans, we adopted a fleet averaging system very similar to the light-duty GHG and CAFE fleet averaging system. In both programs, manufacturers are allowed to carry-forward deficits for up to three years without penalty. The agencies provided in the ABT programs flexibility for situations in which a manufacturer is unable to avoid a negative credit balance at the end of the year. In such cases, manufacturers are not considered to be out of compliance unless they are unable to make up the difference in credits by the end of the third subsequent model year.

In total, the Phase 1 program divides the heavy-duty sector into 14 subcategories of vehicles and 4 subcategories of engines. These subcategories are grouped into 4 vehicle

averaging sets and 4 engine averaging sets in the ABT program. For tractors and vocational vehicles, the fleet averaging sets are: Light heavy-duty (Classes 2b–5); medium heavy-duty (Class 6–7); and heavy heavy-duty (Class 8). Complete HD pickups and vans (both spark-ignition and compression-ignition) are the final vehicle averaging set. For engines, the fleet averaging sets are spark-ignition engines, compression-ignition light heavy-duty engines, compression-ignition medium heavy-duty engines, and compression-ignition heavy heavy-duty engines. ABT allows the exchange of credits within an averaging set. This means that a Class 8 day cab tractor can exchange credits with a Class 8 sleeper tractor but not with a smaller Class 7 tractor. Also, a Class 8 vocational vehicle can exchange credits with a Class 8 tractor. However, we did not allow trading between engines and chassis (*i.e.* vehicles).

In addition to ABT, the other primary flexibility provisions in the Phase 1 program involve opportunities to generate early credits, advanced technology credits (including for use of hybrid powertrains), and innovative technology credits.<sup>55</sup> For the early credits and advanced technology credits, the agencies adopted a 1.5x multiplier, meaning that manufacturers would get 1.5 credits for each early credit and each advanced technology credit. In addition, advanced technology credits for Phase 1 can be used anywhere within the heavy-duty sector (including both vehicles and engines). Put another way, as a means of promoting these promising technologies, the Phase 1 rule does not restrict averaging or trading by averaging set in this instance.

For other vehicle or engine technologies that can reduce CO<sub>2</sub> and fuel consumption, but whose benefits are not reflected if measured using the Phase 1 test procedures, the agencies wanted to encourage the development of such innovative technologies, and therefore adopted special "innovative technology" credits. These innovative technology credits apply to technologies that are shown to produce emission and fuel consumption reductions that are not adequately recognized on the Phase 1 test procedures and that were not yet in widespread use in the heavy-duty sector before MY 2010. Manufacturers

<sup>52</sup> These thresholds were revised in early 2016. See <http://www.regulations.gov/#/documentDetail;D=SBA-2014-0011-0031>.

<sup>53</sup> Note: These calendar year benefits do not represent the same time frame as the model year lifetime benefits described above, so they are not additive.

<sup>54</sup> NHTSA explained that it has greater flexibility in the HD program to include consideration of credits and other flexibilities in determining appropriate and feasible levels of stringency than it does in the light-duty CAFE program. *Cf.* 49 U.S.C. 32902(h), which applies to light-duty CAFE but not heavy-duty fuel efficiency under 49 U.S.C. 32902(k).

<sup>55</sup> Early credits are for engines and vehicles certified before EPA standards became mandatory, advanced technology credits are for hybrids and/or Rankine cycle engines, and innovative technology credits are for other technologies not in the 2010 fleet whose benefits are not reflected using the Phase 1 test procedures.

need to quantify the reductions in fuel consumption and CO<sub>2</sub> emissions that the technology is expected to achieve, above and beyond those achieved on the Phase 1 test procedures. As with ABT, the use of innovative technology credits is allowed only among vehicles and engines of the same defined averaging set generating the credit, as described above. The credit multiplier likewise does not apply for innovative technology credits.

#### (4) Implementation of Phase 1

Manufacturers have already begun complying with the Phase 1 standards. In some cases manufacturers voluntarily chose to comply early, before compliance was mandatory. The Phase 1 rule allowed manufacturers to generate credits for such early compliance. The market appears to be very accepting of the new technologies, and the agencies have seen no evidence of “pre-buy” effects in response to the standards. In fact sales have been higher in recent years than they were before Phase 1. Moreover, manufacturers’ compliance plans indicate intention to utilize the Phase 1 flexibilities, and we have yet to see significant non-compliance with the standards.

#### (5) Litigation on Phase 1 Rule

The D.C. Circuit rejected all challenges to the agencies’ Phase 1 regulations. The court did not reach the merits of the challenges, holding that none of the petitioners had standing to bring their actions, and that a challenge to NHTSA’s denial of a rulemaking petition could only be brought in District Court. See *Delta Construction v. EPA*, 783 F. 3d 1291 (D.C. Cir. 2015).

#### C. Summary of the Phase 2 Standards and Requirements

The agencies are adopting new standards that build on and enhance existing Phase 1 standards, and are adopting as well the first-ever standards for certain trailers used in combination with heavy-duty tractors. Taken together, the Phase 2 program comprises a set of largely technology-advancing standards that will achieve greater GHG and fuel consumption savings than the Phase 1 program. As described in more detail in the following sections, the agencies are adopting these standards because, based on the information available at this time and careful consideration of all comments, we believe they best fulfill our respective statutory authorities when considered in the context of available technology, feasible reductions of emissions and fuel consumption, costs, lead time, safety, and other relevant factors.

The Phase 2 standards represent a more technology-forcing<sup>56</sup> approach than the Phase 1 approach, predicated on use of both off-the-shelf technologies and emerging technologies that are not yet in widespread use. The agencies are adopting standards for MY 2027 that we project will require manufacturers to make extensive use of these technologies. The standards increase in stringency incrementally beginning in MY 2018 for trailers and in MY 2021 for other segments, ensuring steady improvement to the MY 2027 stringency levels. For existing technologies and technologies in the final stages of development, we project that manufacturers will likely apply them to nearly all vehicles, excluding those specific vehicles with applications or uses that prevent the technology from functioning properly. We also project as one possible compliance pathway that manufacturers could apply other more advanced technologies such as hybrids and waste engine heat recovery systems, although at lower application rates than the more conventional technologies. Comments on the overall stringency of the proposed Phase 2 program were mixed. Many commenters, including most non-governmental organizations, supported more stringent standards with less lead time. Many technology and component suppliers supported more stringent standards but with the proposed lead time. Vehicle manufacturers did not support more stringent standards and emphasized the importance of lead time. To the extent these commenters provided technical information to support their comments on stringency and lead time, it is discussed in Sections II through VI.

The standards being adopted provide approximately ten years of lead time for manufacturers to meet these 2027 standards, which the agencies believe is appropriate to implement the technologies industry could use to meet these standards. For some of the more advanced technologies production prototype parts are not yet available, though they are in the research stage with some demonstrations in actual

<sup>56</sup> In this context, the term “technology-forcing” has a specific legal meaning and is used to distinguish standards that will effectively require manufacturers to develop new technologies (or to significantly improve technologies) from standards that can be met using off-the-shelf technology alone. See, e.g., *NRDC v. EPA*, 655 F. 2d 318, 328 (D.C. Cir. 1981). Technology-forcing standards do not require manufacturers to use any specific technologies. See also 76 FR 57130 (explaining that section 202(a)(2) allows EPA to adopt such technology-forcing standards, although it does not compel such standards).

vehicles.<sup>57</sup> In the respective sections of Chapter 2 of the RIA, the agencies explain what further steps are needed to successfully and reliably commercialize these prototypes in the lead time afforded by the Phase 2 standards. Additionally, even for the more developed technologies, phasing in more stringent standards over a longer timeframe will help manufacturers to ensure better reliability of the technology and to develop packages to work in a wide range of applications.

As discussed later, the agencies are also adopting new standards in MYs 2018 (trailers only), 2021, and 2024 to ensure that manufacturers make steady progress toward the 2027 standards, thereby achieving steady and feasible reductions in GHG emissions and fuel consumption in the years leading up to the MY 2027 standards.

Providing additional lead time can often enable manufacturers to resolve technological challenges or to find lower cost means of meeting new regulatory standards, effectively making them more feasible in either case. See generally *NRDC v. EPA*, 655 F. 2d 318, 329 (D.C. Cir. 1981). On the other hand, manufacturers and/or operators may incur additional costs if regulations require them to make changes to their products with less lead time than manufacturers would normally have when bringing a new technology to the market or expanding the application of existing technologies. After developing a new technology, manufacturers typically conduct extensive field tests to ensure its durability and reliability in actual use. Standards that accelerate technology deployment can lead to manufacturers incurring additional costs to accelerate this development work, or can lead to manufacturers beginning production before such testing can be completed. Some industry stakeholders have informed EPA that when manufacturers introduced new emission control technologies (primarily diesel particulate filters) in response to the 2007 heavy-duty engine standards they did not perform sufficient product development validation, which led to additional costs for operators when the technologies required repairs or resulted in other operational issues in use. Thus, the issues of costs, lead time, and reliability are intertwined for the

<sup>57</sup> “Prototype” as it is used here refers to technologies that have a potentially production-feasible design that is expected to meet all performance, functional, reliability, safety, manufacturing, cost and other requirements and objectives that is being tested in laboratories and on highways under a full range of operating conditions, but is not yet available in production vehicles already for sale in the market.

agencies' determination of whether standards are reasonable and maximum feasible, respectively.

Another important consideration was the possibility of disrupting the market, which would be a risk if compliance required application of new technologies too suddenly. Several of the heavy-duty vehicle manufacturers, fleets, and commercial truck dealerships informed the agencies that for fleet purchases that are planned more than a year in advance, *expectations* of reduced reliability, increased operating costs, reduced residual value, or of large increases in purchase prices can lead the fleets to pull-ahead by several months planned future vehicle purchases by pre-buying vehicles without the newer technology. In the context of the Class 8 tractor market, where a relatively small number of large fleets typically purchase very large volumes of tractors, such actions by a small number of firms can result in large swings in sales volumes. Such market impacts would be followed by some period of reduced purchases that can lead to temporary layoffs at the factories producing the engines and vehicles, as well as at supplier factories, and disruptions at dealerships. Such market impacts also can reduce the overall environmental and fuel consumption benefits of the standards by delaying the rate at which the fleet turns over. See *International Harvester v. EPA*, 478 F. 2d 615, 634 (D.C. Cir. 1973). A number of commenters stated that the 2007 EPA heavy-duty engine criteria pollutant standard precipitated pre-buy for the Class 8 tractor market.<sup>58</sup> The agencies understand the potential impact that fleets pulling ahead purchases can have on American manufacturing and labor, dealerships, truck purchasers, and on the program's environmental and fuel savings goals, and have taken steps in the design of the program to avoid such disruption (see also our discussion in RTC Section 11.7). These steps include the following:

- Providing considerable lead time
- Adopting standards that will result in significantly lower operating costs for vehicle owners (unlike the 2007 standard, which increased operating costs)
- Phasing in the standards
- Structuring the program so the industry will have a significant range of technology choices to be considered for compliance, rather than the one or two new technologies

<sup>58</sup> For example, see the public comments of The International Union, Volvo Trucks North America, United Automobile, Aerospace and Agricultural Implement Workers of America (UAW).

the OEMs pursued to comply with EPA's 2007 criteria pollutant standard

- Allowing manufacturers to use emissions averaging, banking and trading to phase in the technology even further

As discussed in the Phase 1 final rule, NHTSA has certain statutory considerations to take into account when determining feasibility of the preferred alternative.<sup>59</sup> EISA states that NHTSA (in consultation with EPA and the Secretary of Energy) will develop a commercial medium- and heavy-duty fuel efficiency program designed "to achieve the maximum feasible improvement."<sup>60</sup> Although there is no definition of maximum feasible standards in EISA, NHTSA is directed to consider three factors when determining what the maximum feasible standards are. Those factors are, appropriateness, cost-effectiveness, and technological feasibility,<sup>61</sup> which modify "feasible" beyond its plain meaning.

NHTSA has the broad discretion to weigh and balance the aforementioned factors in order to accomplish EISA's mandate of determining maximum feasible standards. The fact that the factors may often be at odds gives NHTSA significant discretion to decide what weight to give each of the competing factors, policies and concerns and then determine how to balance them—as long as NHTSA's balancing does not undermine the fundamental purpose of the EISA: Energy conservation, and as long as that balancing reasonably accommodates "conflicting policies that were committed to the agency's care by the statute."<sup>62</sup>

EPA also has significant discretion in assessing, weighing, and balancing the relevant statutory criteria. Section 202(a)(2) of the Clean Air Act (42 U.S.C. 7521(a)(2)) requires that the standards "take effect after such period as the Administrator finds necessary to permit the development and application of the requisite technology, giving appropriate consideration to the cost of compliance within such period." This language affords EPA considerable discretion in how to weight the critical statutory factors of emission reductions, cost, and lead time (76 FR 57129–57130). Section 202(a)(2) also allows (although it does not compel) EPA to adopt technology-forcing standards. *Id.* at 57130.

<sup>59</sup> 75 FR 57198.

<sup>60</sup> 49 U.S.C. 32902(k).

<sup>61</sup> *Id.*

<sup>62</sup> *Center for Biological Diversity v. National Highway Traffic Safety Admin.*, 538 F.3d 1172, 1195 (9th Cir. 2008).

Sections II through VI of this Preamble explain the consideration that the agencies took into account based on careful assessment and balancing of the statutory factors under Clean Air Act section 202(a)(1) and (2), and under 49 U.S.C. 32902(k).

#### (1) Carryover From Phase 1 Program and Compliance Changes

Phase 2 is carrying over many of the compliance approaches developed for Phase 1, with certain changes as described below. Readers are referred to the regulatory text for much more detail. Note that the agencies have adapted some of these Phase 1 provisions in order to address new features of the Phase 2 program, notably provisions related to trailer compliance. The agencies have also reevaluated all of the compliance provisions to ensure that they will be effective in achieving the projected reductions without placing an undue burden on manufacturers.

The agencies received significant comments from vehicle manufacturers emphasizing the potential for the structure of the compliance program to impact stringency. Although the agencies do not agree with all of these comments (which are discussed in more detail in later sections), we do agree that it is important to structure the compliance program so that the effective stringency of standards is consistent with levels established by regulation. The agencies have made appropriate improvements to the compliance structure in response to these comments.

#### (a) Certification

EPA and NHTSA are applying the same general certification procedures for Phase 2 as are currently being used for certifying to the Phase 1 standards. Tractors and vocational vehicles will continue to be certified using the vehicle simulation tool (GEM). The agencies, however, revised the Phase 1 GEM simulation tool to develop a new version, Phase 2 GEM, that more specifically reflects improvements to engines, transmissions, and drivetrains.<sup>63</sup> Rather than the GEM simulation tool using default values for engines, transmissions and drivetrains, most manufacturers will enter measured or tested values as inputs reflecting performance of the actual engine, transmission and drivetrain technologies.

<sup>63</sup> As described in Section IV, although the trailer standards were developed using the simulation tool, the agencies are adopting a compliance structure that does not require trailer manufacturers to use it.

The Phase 1 certification process for engines used in tractors and vocational vehicles was based on EPA's process for showing compliance with the heavy-duty engine criteria pollutant standards using engine dynamometer testing, and the agencies are continuing it for Phase 2. We also will continue certifying HD pickups and vans using the Phase 1 chassis dynamometer testing results and vehicle certification process, which is very similar to the light-duty vehicle certification process. The Phase 2 trailer certification process will resemble the Phase 2 tractor certification approach, but with a simplified version of Phase 2 GEM. The trailer certification process allows trailer manufacturers to use a simple equation to determine GEM-equivalent g/ton-mile emission rates without actually running GEM.

EPA and NHTSA are also clarifying provisions related to confirming a manufacturer's test data during certification (*i.e.*, confirmatory testing) and verifying a manufacturer's vehicles are being produced to perform as described in the application for certification (*i.e.*, selective enforcement audits or SEAs). The EPA confirmatory testing provisions for engines, vehicles, and components are in 40 CFR 1036.235 and 1037.235. The SEA provisions are in 40 CFR 1036.301 and 1037.301–1037.320. The NHTSA provisions are in 49 CFR 535.9(a). As we proposed, these clarifications will also apply for Phase 1 engines and vehicles.

In response to comments, we are making several changes to the proposed EPA confirmatory testing provisions. First, the regulations being adopted specify that EPA will conduct triplicate tests for engine fuel maps to minimize the impact of test-to-test variability. The final regulations also state that we will consider entire fuel maps rather than individual points. Engine manufacturers objected to EPA's proposal that individual points could be replaced based on a single test, arguing that it effectively made the vehicle standards more stringent due to point-to-point and test-to-test variability. We believe that the changes being adopted largely address these concerns. We are also applying this approach for axle and transmission maps for similar reasons.

As described in Sections III and IV, EPA has also modified the SEA regulations for verifying aerodynamic performance. These revised regulations differ somewhat from the standard SEA regulations to address the unique challenges of measuring aerodynamic drag. In particular EPA recognizes that for coastdown testing, test-to-test variability is expected to be large relative to production variability. This

differs fundamentally from traditional compliance testing, in which test-to-test variability is expected to be *small* relative to production variability. To address this difference, the modified regulations call for more repeat testing of the same vehicle, but fewer test samples. These revisions were generally supported by commenters. See Section III and IV for additional discussion.

Some commenters suggested that the agencies should apply a compliance margin to confirmatory and SEA test results to account for test variability. However, other commenters supported following EPA's past practice, which has been to base the standards on technology projections that assume manufacturers will apply compliance margins to their test results for certification. In other words, they design their products to have emissions below the standards by some small margin so that test-to-test or lab-to-lab variability would not cause them to exceed any applicable standards. Consequently, EPA has typically not set standards precisely at the lowest levels achievable, but rather at slightly higher levels—expecting manufacturers to target the lower levels to provide compliance margins for themselves. As discussed in Sections II through VI, the agencies have applied this approach to the Phase 2 standards.

#### (b) Averaging, Banking and Trading (ABT)

The Phase 1 ABT provisions were patterned on established EPA ABT programs that have proven to work well. In Phase 1, the agencies determined this flexibility would provide an opportunity for manufacturers to make necessary technological improvements and reduce the overall cost of the program without compromising overall environmental and fuel economy objectives. Commenters generally supported this approach for engines, pickups/vans, tractors, and vocational vehicles. Thus, we are generally continuing this Phase 1 approach with few revisions to the engine and vehicle segments. However, as described in Section IV, in response to comments, we are finalizing a much more limited averaging program for trailers that will not go into effect until 2027. We are adopting some other provisions for certain vocational vehicles, which are discussed in Section V.

The agencies see the overall ABT program as playing an important role in making the technology-advancing standards feasible, by helping to address many issues of technological challenges in the context of lead time and costs. It provides manufacturers flexibilities that

assist the efficient development and implementation of new technologies and therefore enable new technologies to be implemented at a more aggressive pace than without ABT.

ABT programs are more than just add-on provisions included to help reduce costs. They can be, as in EPA's Title II programs generally, an integral part of the standard setting itself. A well-designed ABT program can also provide important environmental and energy security benefits by increasing the speed at which new technologies can be implemented (which means that more benefits accrue over time than with later-commencing standards) and at the same time increase flexibility for, and reduce costs to, the regulated industry and ultimately consumers. Without ABT provisions (and other related flexibilities), standards would typically have to be numerically less stringent since the numerical standard would have to be adjusted to accommodate issues of feasibility and available lead time. See 75 FR 25412–25413. By offering ABT credits and additional flexibilities the agencies can offer progressively more stringent standards that help meet our fuel consumption reduction and GHG emission goals at a faster and more cost-effective pace.<sup>64</sup>

#### (i) Carryover of Phase 1 Credits and Credit Life

The agencies proposed to continue the five-year credit life provisions from Phase 1, and not to adopt any general restriction on the use of banked Phase 1 credits in Phase 2. In other words, Phase 1 credits in MY 2019 could be used in Phase 1 or in Phase 2 in MYs 2021–2024. CARB commented in support of a more restrictive approach for Phase 1 credits, based on the potential for manufacturers to delay implementation of technology in Phase 2 by using credits generated under Phase 1. We also received comments asking the agencies to provide a path for manufacturers to generate credits for applying technologies not explicitly included in the Phase 1 program. In response to these comments, the agencies have analyzed the potential impacts of Phase 1 credits on the Phase 2 program for each sector and made appropriate adjustments in the program. For example, as described in Section II.D.(5), the agencies are adopting some restrictions on the carryover of windfall Phase 1 engine credits that result from the Phase 1 vocational engine standards.

<sup>64</sup> See *NRDC v. Thomas*, 805 F.2d 410, 425 (D.C. Cir. 1986) (upholding averaging as a reasonable and permissible means of implementing a statutory provision requiring technology-forcing standards).



Also, as described in Section III, the agencies are projecting that Phase 1 credit balances for tractor manufacturers will enable them to meet more stringent standards for MY 2021–2023, so the agencies have increased the stringency of these standards accordingly.

In contrast to the Phase 1 tractor program, the Phase 1 vocational chassis program currently offers fewer opportunities to generate credits for potential carryover into Phase 2. To address comments related to this particular situation and also to provide a new Phase 1 incentive to voluntarily apply certain Phase 2 technologies, which are available today but currently not being adopted, the agencies are finalizing a streamlined Phase 1 off-cycle credit approval process for these Phase 2 technologies. For vocational chassis, these technologies include workday idle reduction technologies such as engine stop-start systems, automatic engine shutdown systems, shift-to-neutral at idle automatic transmissions, automated manual transmissions, and dual-clutch transmissions. The agencies are also finalizing a streamlined Phase 1 off-cycle credit approval process for Phase 2 automatic tire inflation systems (ATIS), for both tractors and vocational chassis. The purpose for offering these streamlined off-cycle approval processes for Phase 1 is to encourage more early adoption of these Phase 2 technologies during the remaining portion of the Phase 1 program (*e.g.*, model years 2018, 2019, 2020). Earlier adoption of these technologies would help demonstrate that these newer, but not advanced, technologies are effective, reliable and well-accepted into the marketplace by the time the agencies project that they would be needed for compliance with the Phase 2 standards.

The agencies are also including a provision allowing exempt small business manufacturers of vocational chassis to opt into the Phase 1 program for the purpose of generating credits which can be used throughout the Phase 2 program, as just described.

In conjunction with this provision allowing manufacturers to receive credit in Phase 1 for pulling ahead certain Phase 2 technologies, the agencies are providing an extended credit life for the Light and Medium heavy-duty vocational vehicle averaging sets (see next subsection) to provide additional Phase 2 transition flexibility for these vehicles. Unlike the HD Phase 1 pickup/van and tractor programs, where the averaging sets are broad; where manufacturers have many technology choices from which to earn credits (*e.g.*, tractor aerodynamic and idle reduction

technologies, pickup/van engine and transmission technologies); and where we project manufacturers to have sufficient pickup/van and tractor credits to manage the transition to the Phase 2 standards, transitioning to the new Light and Medium vocational vehicle standards may be more challenging. Manufacturers selling lower volumes of these lighter vehicles may find themselves with fewer overall credits to manage the transition to the new standards, especially the 2027 standards. To facilitate this transition and better assure adequate lead time, the agencies are extending the credit life for the Light and Medium heavy-duty vehicle averaging sets (typically vehicles in Classes 2b through 7) so that all credits generated in 2018 and later will last at least until 2027. We are not doing this for the Heavy heavy-duty vocational vehicle category (typically Class 8) because tractor credits may be used within this averaging set. Because we project that manufacturers will have sufficient tractor credits, we believe that they will be able to manage the Heavy vocational transition to each set of new standards, without the extended credit life that we are finalizing for Light and Medium vocational averaging sets. Nevertheless, we will continue to monitor the manufacturers' progress in transitioning to the Phase 2 standards for each category, and we may reconsider the need for additional transitional flexibilities, such as extending other categories' credit lives.

Although, as we have already noted, the numerical values of Phase 2 standards are not directly comparable in an absolute sense to the existing Phase 1 standards (in other words, a given vehicle would have a different g/ton-mile emission rate when evaluated using Phase 1 GEM than it would when evaluated using Phase 2 GEM), we believe that the Phase 1 and Phase 2 credits are largely equivalent. Because the standards and emission levels are included in a relative sense (as a difference), it is not necessary for the Phase 1 and Phase 2 standards to be directly equivalent in an absolute sense in order for the credits to be equivalent.

This is best understood by examining the way in which credits are calculated. For example, the credit equations in 40 CFR 1037.705 and 49 CFR 535.7 calculate credits as the product of the difference between the standard and the vehicle's emission level (g/ton-mile or gallon/1,000 ton-mile), the regulatory payload (tons), production volume, and regulatory useful life (miles). The Phase 2 payloads, production volumes, and useful lives for tractors, medium and heavy heavy-duty engines, or medium

and heavy heavy-duty vocational vehicles are equivalent to those of Phase 1. However, EPA is changing the regulatory useful lives of HD pickups and vans, light heavy-duty vocational vehicles, spark-ignited engines, and light heavy-duty compression-ignition engines. Because useful life is a factor in determining the value of a credit, the agencies proposed to apply interim adjustment factors to ensure banked credits maintain their value in the transition from Phase 1 to Phase 2.

For Phase 1, EPA aligned the useful life for GHG emissions with the useful life already in place for criteria pollutants. After the Phase 1 rules were finalized, EPA updated the useful life for criteria pollutants as part of the Tier 3 rulemaking.<sup>65</sup> The new useful life implemented for Tier 3 is 150,000 miles or 15 years, whichever occurs first. This same useful life is being adopted in Phase 2 for HD pickups and vans, light heavy-duty vocational vehicles, spark-ignited engines, and light heavy-duty compression-ignition engines.<sup>66</sup> The numeric value of the adjustment factor for each of these regulatory categories depends on the Phase 1 useful life. These are described in detail below in this Preamble in Sections II, V, and VI. Without these adjustment factors the changes in useful life would effectively result in a discount of banked credits that are carried forward from Phase 1 to Phase 2, which is not the intent of the changes in the useful life. With the relatively flat deterioration generally associated with CO<sub>2</sub>, EPA does not believe the changes in useful life will significantly affect the feasibility of the Phase 2 standards.

We note that the primary purpose of allowing manufacturers to bank credits is to provide flexibility in managing transitions to new standards. The five-year credit life is substantial, and allows credits generated in either Phase 1 or early in Phase 2 to be used for the intended purpose. The agencies believe a credit life longer than five years is unnecessary to accomplish this transition. Restrictions on credit life serve to reduce the likelihood that any manufacturer will be able to use banked credits to disrupt the heavy-duty vehicle market in any given year by effectively limiting the amount of credits that can be held. Without this limit, one manufacturer that saved enough credits over many years could achieve a significant cost advantage by using all the credits in a single year. The agencies

<sup>65</sup> 79 FR 23492, April 28, 2014 and 40 CFR 86.1805–17.

<sup>66</sup> NHTSA's useful life is based on mileage and years of duration.

believe that allowing a five-year credit life for all credits, and as a consequence allowing use of Phase 1 credits in Phase 2, creates appropriate flexibility and appropriately facilitates a smooth transition to each new level of standards.

(ii) Averaging Sets

EPA has historically restricted averaging to some extent for its HD emission standards to avoid creating unfair competitive advantages or environmental risks due to credits being inconsistent. It also helps to ensure a robust and manageable compliance program. Under Phase 1, averaging, banking and trading can only occur within and between specified “averaging sets” (with the exception of credits generated through use of specified advanced technologies). As proposed, we will continue this regime in Phase 2, retaining the existing vehicle and engine averaging sets, and creating new trailer averaging sets. We are also continuing the averaging set restrictions from Phase 1 in Phase 2. (See Section V for certain other provisions applicable to vehicles certified to special standards.) These general averaging sets for vehicles are:

- Complete pickups and vans
- Other light heavy-duty vehicles (Classes 2b–5)
- Medium heavy-duty vehicles (Class 6–7)
- Heavy heavy-duty vehicles (Class 8)
- Long dry and refrigerated van trailers<sup>67</sup>
- Short dry and refrigerated van trailers

We are not allowing trading between engines and chassis, even within the same vehicle class. Such trading would essentially result in double counting of emission credits, because the same engine technology would likely generate credits relative to both standards (and indeed, certain engine improvements are reflected exclusively in the vehicle standards the agencies are adopting). We similarly limit trading among engine categories to trades within the designated averaging sets:

- Spark-ignition engines
- Compression-ignition light heavy-duty engines
- Compression-ignition medium heavy-duty engines
- Compression-ignition heavy heavy-duty engines

The agencies continue to believe that maintaining trading to be only within the classes listed above will provide adequate opportunities for manufacturers to make necessary

technological improvements and to reduce the overall cost of the program without compromising overall environmental and fuel efficiency objectives, and it is therefore appropriate and reasonable under EPA’s authority and maximum feasible under NHTSA’s authority, respectively. We do not expect emissions from engines and vehicles—when restricted by weight class—to be dissimilar. We therefore expect that the lifetime vehicle performance and emissions levels will be very similar across these defined categories, and the credit calculations will fairly ensure the expected fuel consumption and GHG emission reductions.

These restrictions have generally worked well for Phase 1, and we continue to believe that these averaging sets create flexibility without creating an unfair advantage for manufacturers with integrated portfolios, including engines and vehicles. See 76 FR 57240.

(iii) Credit Deficits

The Phase 1 regulations allow manufacturers to carry-forward deficits for up to three years. This is an important flexibility because the program is designed to address the diversity of the heavy-duty industry by allowing manufacturers to sell a mix of engines or vehicles that have very different emission levels and fuel efficiencies. Under this construct, manufacturers can offset sales of engines or vehicles not meeting the standards by selling others (within the same averaging set) that perform better than the standards require. However, in any given year it is possible that the actual sales mix will not balance out, and the manufacturer may be short of credits for that model year. The three-year provision allows for this possibility and creates additional compliance flexibility to accommodate it.

(iv) Advanced Technology Credits

At the time of the proposal, the agencies believed it was no longer appropriate to provide extra credit for any of the technologies identified as advanced technologies for Phase 1, although we requested comment on this issue. The Phase 1 advanced technology credits were adopted to promote the implementation of advanced technologies that were not included in our basis of the feasibility of the Phase 1 standards. Such technologies included hybrid powertrains, Rankine cycle waste heat recovery systems on engines, all-electric vehicles, and fuel cell vehicles (see 40 CFR 86.1819–14(k)(7), 1036.150(h), and 1037.150(p)). The Phase 2 heavy-duty engine and vehicle

standards are premised on the use of some of these technologies, making them equivalent to other fuel-saving technologies in this context. We believe the Phase 2 standards themselves will provide sufficient incentive to develop those specific technologies.

Although the agencies proposed to eliminate all advanced technology incentives, we remained open to targeted incentives that would address truly advanced technology. We specifically requested comment on this issue with respect to electric vehicle, plug-in hybrid, and fuel cell technologies. Although the Phase 2 standards are premised on some use of Rankine cycle waste heat recovery systems on engines and hybrid powertrains, none of these standards are based on projected utilization of these other even more-advanced technologies (e.g., all-electric vehicles, fuel cell vehicles). 80 FR 40158. Commenters generally supported providing credit multipliers for these advanced technologies. However, Allison supported ending the incentives for hybrids, fuel cells, and electric vehicles in Phase 2. ATA, on the other hand, commented that the agencies should preserve the advanced technology credits which provide a credit multiplier of 1.5 in order to promote the use of hybrid and electric vehicles in larger vocational vehicles and tractors. ARB supported the use of credit multipliers even more strongly and provided suggestions for values larger than 1.5 that could be used to incentivize plug-in hybrids, electric vehicles, and fuel cell vehicles. Eaton recommended the continuation of advanced technology credits for hybrid powertrains until a sufficient number are in the market. Overall, the comments indicated that there is support for such incentives among operators, suppliers, and states. Upon further consideration, the agencies are adopting advanced technology credits for these three types of advanced technologies, as shown in Table I–2 below.

TABLE I–2—ADVANCED TECHNOLOGY MULTIPLIERS

Technology	Multiplier
Plug-in hybrid electric vehicles	3.5
All-electric vehicles .....	4.5
Fuel cell vehicles .....	5.5

Our intention in adopting these multipliers is to create a meaningful incentive to those considering adopting these qualifying advanced technologies into their vehicles. The values being

<sup>67</sup> Averaging for trailers does not begin until 2027.

adopted are consistent with values recommended by CARB in their supplemental comments.<sup>68</sup> CARB's values were based on a cost analysis that compared the costs of these technologies to costs of other conventional technologies. Their costs analysis showed that adopting multipliers in this range would make these technologies much more competitive with the conventional technologies and could allow manufacturers to more easily generate a viable business case to develop these technologies for heavy-duty and bring them to market at a competitive price.

Another important consideration in the adoption of these larger multipliers is the tendency of the heavy-duty sector to significantly lag the light-duty sector in the adoption of advanced technologies. There are many possible reasons for this, such as:

- Heavy-duty vehicles are more expensive than light-duty vehicles, which makes it a greater monetary risk for purchasers to invest in unproven technologies.
- These vehicles are work vehicles, which makes predictable reliability even more important than for light-duty vehicles.
- Sales volumes are much lower for heavy-duty vehicles, especially for specialized vehicles.

As a result of factors such as these, adoption rates for these advanced technologies in heavy-duty vehicles are essentially non-existent today and seem unlikely to grow significantly within the next decade without additional incentives.

The agencies believe it is appropriate to provide such large multipliers for these very advanced technologies at least in the short term, because they have the potential to provide very large reductions in GHG emissions and fuel consumption and advance technology development substantially in the long term. However, because they are so large, we also believe that we should not necessarily allow them to continue indefinitely. Therefore, the agencies are adopting them as an interim program that will continue through MY 2027. If the agencies determine that these credit multipliers should be continued beyond MY 2027, we could do so in a future rulemaking.

<sup>68</sup> Letter from Michael Carter, ARB, to Gina McCarthy, Administrator, EPA and Mark Rosekind, Administrator, NHTSA, June 16, 2016.

<sup>69</sup> Credits can be generated against these standards as well, but the life of credits generated for 2025 and 2026 would be five years. The pull ahead of the MY 2021 standards should more than

As discussed in Section I.C.(1)(d), the agencies are not specifically accounting for upstream emissions that might occur from production of electricity to power these advanced vehicles. This approach is largely consistent with the incentives offered for electric vehicles in the light-duty National Program. 77 FR 62810. For light-duty vehicles, the agencies also did not require manufacturers to account for upstream emissions during the initial years, as the technologies are being developed. While we proactively sunset this allowance for light-duty due to concerns about potential impacts from very high sales volumes, we do not have similar concerns for heavy-duty. Nevertheless, in this program we are only adopting these credit multipliers through MY 2027, and should we not promulgate a future rulemaking to extend them beyond MY 2027, these multipliers would essentially sunset in MY 2027.

One feature of the Phase 1 advanced technology program that is not being continued in Phase 2 is the allowance to use advanced technology credits across averaging sets. We believe that combined with the very large multipliers being adopted, there could be too large a risk of market distortions if we allowed the use of these credits across averaging sets.

#### (v) Transition Flexibility for Meeting the Engine Standards

Some manufacturers commented that the proposed engine regulations did not offer sufficient flexibility. Although these commenters acknowledge that the tractor and vocational *vehicle* standards will separately drive engine improvements, they nonetheless maintain that the MY 2024 *engine* standards may constrain potential compliance paths too much. Some commented that advanced technologies (such as waste heat recovery) may need to be deployed before the technologies are fully reliable for every engine manufacturer, and may lead to the development and implementation of additional engine technologies outside of scheduled engine redesign cycles, which could cause manufacturers to incur costs which were not accounted for in the agencies' analyses. These costs could include both product development and equipment costs for the engine manufacturer, and potential

balance out any slight decreases in benefits attributable to such credits.

<sup>70</sup> The final rule (40 CFR 1036.150(p)) provides that for engine manufacturers choosing this alternative option, credits generated with MY 2018–2024 engines can be used until MY 2030. Credits from later model years can be used for five years from generation under 40 CFR 1037.740(c).

increased costs for vehicle owners associated with potential reliability issues in-the-field.

The agencies have considered these comments carefully. See, e.g., RIA Section 2.3.9 and RTC Section 3.4. The agencies recognize the importance of ensuring that there is adequate lead time to develop, test, and otherwise assure reliability of the technologies projected to be needed to meet the standards and for the advanced engine technologies in particular. See Section I.C above; see also responses regarding waste heat recovery technology in RTC Section 3.4, and Response 3.4.1. The agencies are therefore adopting an alternative, optional ABT flexibility for heavy-heavy and medium-heavy engines in partial response to these comments. This optional provision would affect only the MYs 2021 and 2024 standards for these engines, not the final MY 2027 engine standards, and to the extent manufacturers elect the provision would increase fuel consumption and GHG reduction benefits, as explained below.

This optional provision has three aspects:

- A pull ahead of the engine standards to MY 2020
- Extended credit life for engine credits generated against MYs 2018–2019 Phase 1 standards, the MY 2020 pull-ahead Phase 2 engine standards, and the MYs 2021–2024 Phase 2 engine standards
- Slightly relaxed engine standards for MYs 2024–2026 tractor engine standards<sup>69</sup>

Thus, the final rule provides the option of an extended credit life for the medium heavy-duty and heavy heavy-duty engines so that all credits generated in MY 2018 and later will last at least until MY 2030.<sup>70</sup> To be eligible for this allowance, manufacturers would need to voluntarily certify all of their HHD and/or MHD MY 2020 engines (tractor and vocational) to MY 2021 standards.<sup>71</sup> Manufacturers could elect to apply this provision separately to medium heavy-duty and heavy heavy-duty engines, since these remain separate averaging sets. Credits banked by the manufacturer in Phase 1 for model year 2018 and 2019 engines would be eligible for the extended credit life for manufacturers satisfying the pull ahead requirement. Such credits could be used in any model year 2021 through

<sup>71</sup> Compliance with this requirement would be evaluated at the time of certification and when end of year ABT reports are submitted. Manufacturers that show a net credit deficit for the averaging set at the end of the year would not meet this requirement.

2030. Manufacturers that voluntarily certify their engines to MY 2021

standards early would then also be eligible for slightly less stringent engine

tractor standards in MYs 2024–2026, as shown in the following table.

TABLE I–3—OPTIONAL ABT FLEXIBILITY STANDARDS FOR HEAVY-HEAVY AND MEDIUM-HEAVY ENGINES

Model years	Medium heavy-duty—tractor		Heavy heavy-duty—tractor	
	EPA CO <sub>2</sub> standard (g/bhp-hr)	NHTSA fuel consumption standard (gal/100bhp-hr)	EPA CO <sub>2</sub> standard (g/bhp-hr)	NHTSA fuel consumption standard (gal/100bhp-hr)
2020–2023 .....	473	4.6464	447	4.3910
2024–2026 .....	467	4.5874	442	4.3418

Once having opted into this alternative compliance path, engine manufacturers would have to adhere to that path for the remainder of the Phase 2 program. The choice would be made when certifying MY 2020 engines. Instead of certifying engines to the final year of the Phase 1 engine standards, manufacturers electing the alternative would indicate that they are instead certifying to the MY 2021 Phase 2 engine standard.

Because these engine manufacturers would be reducing emissions of engines otherwise subject to the MY 2020 Phase 1 engine standards (and because engine reductions were not reflected in the Phase 1 vehicle program), there would be a net benefit to the environment. These engines would not generate credits relative to the Phase 1 standards (that is, MY 2020 engines would only use or generate credits relative to the pulled ahead MY 2021 Phase 2 engines standards) which would result in net reductions of CO<sub>2</sub> and fuel consumption of about 2 percent for each engine. Thus, if every engine manufacturer chooses to use this flexibility, there could be resulting reductions of an additional 12MMT of CO<sub>2</sub> and saving of nearly one billion gallons of diesel fuel.

This alternative also does not have adverse implications for the vehicle standards. As just noted, the vehicle standards themselves are unaffected. Thus, these voluntary standards would not reduce the GHG reductions or fuel savings of the program. Vehicle manufacturers using the alternative MYs 2024–2026 engines would need to adopt additional vehicle technology (*i.e.* technology beyond that projected to be needed to meet the standard) to meet the vehicle standards. This means the vehicles would still achieve the same fuel efficiency in use.<sup>72</sup>

<sup>72</sup>The agencies view this alternative as of reasonable cost with respect to the vehicle standards. First, where engine manufacturers and vehicle manufacturers are vertically integrated, that manufacturer would choose the alternative which is most cost advantageous. Second, where engine manufacturers and vehicle manufacturers are not

In sum, the agencies view this alternative as being positive from the environmental and energy conservation perspectives, and believe it will provide significant flexibility for manufacturers that may reduce their compliance costs. It also provides a hedge against potential premature introduction of advanced engine technologies, providing more lead time to assure in-use reliability.

(c) Innovative Technology and Off-Cycle Credits

The agencies are continuing the Phase 1 innovative technology program (reflecting certain streamlining features as just discussed), but re-designating it as an off-cycle program for Phase 2. In other words, beginning in MY 2021 technologies that are not accounted for in the GEM simulation tool, or by compliance dynamometer testing (for engines or chassis certified vehicles) will be considered “off-cycle,” including those technologies that may no longer be considered innovative technologies.

The final rules provide that in order for a manufacturer to receive these credits for Phase 2, the off-cycle technology will still need to meet the requirement that it was not in common use prior to MY 2010. Although we have not identified specific off-cycle technologies at this time that should be excluded, we believe it is prudent to continue this requirement to avoid the potential for manufacturers to receive windfall credits for technologies that they were already using before MY 2010, and that are therefore reflected in the Phase 2 (and possibly Phase 1) baselines. However, because the Phase 2 program will be implemented in MY 2021 and extend at least through MY 2027, the agencies and manufacturers may have difficulty in the future

vertically integrated, the agencies anticipate that engines certified to the alternative and the main standards will both be available for the vehicle manufacturer to purchase, so that the vehicle manufacturer would not need to incur any costs attributable to the alternative engine standard.

determining whether an off-cycle technology was in common use prior to MY 2010. In order to avoid this approach becoming an unnecessary hindrance to the off-cycle program, the agencies will presume that off-cycle technologies were not in common use in 2010 unless we have clear evidence to the contrary. Neither the agencies nor manufacturers will be required to demonstrate that the technology meets this 2010 criteria. Rather, the agencies will simply retain the authority to deny a request for off-cycle credits if it is clear that the technology was in common use in 2010 and thus part of the baseline.

Manufacturers will be able to carry over innovative technology credits from Phase 1 into Phase 2, subject to the same restrictions as other credits.

Manufacturers will also be able to carry over the improvement factor (not the credit value) of a technology, if certain criteria are met. The agencies will require documentation for all off-cycle requests similar to those required by EPA for its light-duty GHG program.

Additionally, the agencies will not grant any off-cycle credits for crash avoidance technologies. The agencies will also require manufacturers to consider the safety of off-cycle technologies and will request a safety assessment from the manufacturer for all off-cycle technologies.

Similar principles apply to off-cycle credits in this heavy-duty Phase 2 program as under the light-duty vehicle rules. Thus, technologies which are part of the basis of a Phase 2 standard would not be eligible for off-cycle credits. Their benefits have been accounted for in developing the stringency of the Phase 2 standard, as have their costs. See 77 FR 62835 (October 15, 2012). In addition, technologies which are integral or inherent to the basic vehicle design and are recognized in GEM or under the FTP (for pickups and vans), including engine, transmission, mass reduction, passive aerodynamic design, and base tires, will not be eligible for off-cycle credits. 77 FR 62836.

Technologies integral or inherent to basic vehicle design are fully functioning and are thus recognized in GEM, or operate over the entirety of the FTP/HFET and therefore are adequately captured by the test procedure.

Just as some technologies that were considered off-cycle for Phase 1 are being adopted as primary technologies in Phase 2 on whose performance standard stringency is calculated, the agencies may revise the regulation in a future rulemaking to create a more direct path to recognize technologies currently considered off-cycle. For example, although we are including specific provisions to recognize certain electrified accessories, recognizing others would require the manufacturer to go through the off-cycle process. However, it is quite possible that the agencies could gather sufficient data to allow us to adopt specific provisions in a future rulemaking to recognize other accessories in a simpler manner. Because such a change would merely represent a simpler way to receive the same credit as could be obtained under the regulations being adopted today (rather than a change in stringency), it would not require us to reconsider the standards.

#### (d) Alternative Fuels and Electric Vehicles

The agencies will largely continue the Phase 1 approach for engines and vehicles fueled by fuels other than gasoline and diesel.<sup>73</sup> Phase 1 engine emission standards applied uniquely for gasoline-fueled and diesel-fueled engines. The regulations in 40 CFR part 86 implement these distinctions for alternative fuels by dividing engines into Otto-cycle and Diesel-cycle technologies based on the combustion cycle of the engine. However, as proposed, the agencies are making a small change that is described in Section II. Under this change, we will require manufacturers to divide their natural gas engines into primary intended service classes, like the current requirement for compression-ignition engines. Any alternative fuel-engine qualifying as a heavy heavy-duty engine will be subject to all the emission standards and other requirements that apply to compression-ignition engines. Note that this small change in approach will also apply with respect to EPA's criteria pollutant program.

We are also applying the Phase 2 standards at the vehicle tailpipe. That is, compliance is based on vehicle fuel consumption and GHG emission

reductions, and does not reflect any so-called lifecycle emission properties. The agencies have explained why it is reasonable that the heavy-duty standards be fuel neutral in this manner and adhere to this reasoning here. See 76 FR 57123; see also 77 FR 51705 (August 24, 2012) and 77 FR 51500 (August 27, 2012). In particular, EPA notes that there is a separate, statutorily-mandated program under the Clean Air Act which encourages use of renewable fuels in transportation fuels, including renewable fuel used in heavy-duty diesel engines. This program considers lifecycle greenhouse gas emissions compared to petroleum fuel. NHTSA notes that the fuel efficiency standards are necessarily tailpipe-based, and that a lifecycle approach would likely render it impossible to harmonize the fuel efficiency and GHG emission standards, to the great detriment of our goal of achieving a coordinated program. 77 FR 51500–51501; see also 77 FR 51705 (similar finding by EPA); see also Section I.F.(1)(a) below, Section 1.8 of the RTC, and Section XI.B.

The agencies received mixed comments on this issue. Many commenters supported the proposed approach, generally agreeing with the agencies' arguments. However, some other commenters opposed this approach. Opposing commenters generally fell into two categories:

- Commenters concerned that upstream emissions of methane occurring during the production and distribution of natural gas would offset some or all of the GHG emission reductions observed at the tailpipe.
- Commenters concerned that tailpipe-only standards ignore the GHG benefits of using renewable fuels.

The agencies are not issuing rules that effectively would turn these rules into a fuel program, rather than an emissions reduction and fuel efficiency program. Nor will the agencies disharmonize the program by having GHG standards reflect upstream emissions having no relation to fuel efficiency. See *e.g.* 77 FR 51500–51501; see also 77 FR 51705. We thus will continue to measure compliance at the tailpipe. Issues relating to whether to consider in the emission standards upstream emissions related to natural gas exploration and production are addressed in detail in Section XI below. It is sufficient to state here that the agencies carefully investigated the potential use of natural gas in the heavy-duty sector and the impacts of such use. We do not believe that the use of natural gas is likely to become a major fuel source for heavy-duty vehicles during the Phase 2 time frame. Thus, since we project natural

gas vehicles to have little impact on both overall GHG emissions and fuel consumption during the Phase 2 time frame, the agencies see no need to make fundamental changes to the Phase 1 approach for natural gas engines and vehicles.

The agencies note further that a consequence of the tailpipe-based approach is that the agencies will treat vehicles powered by electricity the same as in Phase 1. In Phase 1, EPA treated all electric vehicles as having zero tailpipe emissions of CO<sub>2</sub>, CH<sub>4</sub>, and N<sub>2</sub>O (see 40 CFR 1037.150(f)). Similarly, NHTSA adopted regulations in Phase 1 that set the fuel consumption standards based on the fuel consumed by the vehicle. The agencies also did not require emission testing for electric vehicles in Phase 1. The agencies considered the potential unintended consequence of not accounting for upstream emissions from the charging of heavy-duty electric vehicles. In our reassessment for Phase 2, we have found only one all-electric heavy-duty vehicle manufacturer that has certified through 2016. As we look to the future, we project limited adoption of all-electric vehicles into the market. Therefore, we believe that this provision is still appropriate. Unlike the 2017–2025 light-duty rule, which included a cap whereby upstream emissions would be counted after a certain volume of sales (see 77 FR 62816–62822), we believe there is no need to establish a cap for heavy-duty vehicles because of the small likelihood of significant production of EV technologies in the Phase 2 timeframe. Commenters specifically addressing electric vehicles generally supported the agencies' proposal. However, some commenters did support accounting for emissions from the generation of electricity in the broader context of supporting full lifecycle analysis. As noted above, and in more detail in Section I.F.(2)(f) as well as Section 1.8 of the RTC, the agencies are not predicating the standards on a full life-cycle approach.

#### (e) Phase 1 Interim Provisions

EPA adopted several flexibilities for the Phase 1 program (40 CFR 86.1819–14(k), 1036.150 and 1037.150) as interim provisions. Because the existing regulations do not have an end date for Phase 1, most of these provisions did not have an explicit end date. NHTSA adopted similar provisions. With few exceptions, the agencies are not continuing these provisions for Phase 2. These will generally remain in effect for the Phase 1 program. In particular, the agencies note that we are not continuing the blanket exemption for small

<sup>73</sup> See Section XI for additional discussion of natural gas engines and vehicles.

manufacturers. Instead, in Phase 2 the agencies are providing more targeted relief for these entities.

(f) In-Use Standards and Recall

Section 202(a)(1) of the CAA specifies that EPA is to adopt emissions standards that are applicable for the useful life of the vehicle and for the engine. EPA finalized in-use standards for the Phase 1 program, whereas NHTSA's rules do not include these standards. For the Phase 2 program, EPA will carry-over its in-use provisions, and NHTSA is adopting EPA's useful life requirements for its vehicle and engine fuel consumption standards to ensure manufacturers consider in the design process the need for fuel efficiency standards to apply for the same duration and mileage as EPA standards. If EPA determines a manufacturer fails to meet its in-use standards, civil penalties may be assessed.

CAA section 207(c)(1) requires "the manufacturer" to remedy certain in-use problems. The remedy process is to recall the nonconforming vehicles and bring them into conformity with the standards and the certificate. The regulations for this process are in 40 CFR part 1068, subpart F. EPA is also adopting regulatory text addressing recall obligations for component manufacturers and other non-certifying manufacturers. We note that the CAA does not limit this responsibility to certificate holders, consistent with the definition of a "manufacturer" as "any person engaged in the manufacturing or assembling of new motor vehicles, new motor vehicle engines, new nonroad vehicles or new nonroad engines, or importing such vehicles or engines for resale, or who acts for and is under the control of any such person in connection with the distribution of new motor vehicles, new motor vehicle engines, new nonroad vehicles or new nonroad engines, but shall not include any dealer with respect to new motor vehicles, new motor vehicle engines, new nonroad vehicles or new nonroad engines received by him in commerce."

As discussed in Section I.E.(1) below, this definition was not intended to restrict the definition of "manufacturer" to a single person per vehicle. Under EPA regulations, we can require any person meeting the definition of manufacturer for a nonconforming vehicle to participate in a recall. However, we would normally presume the certificate holder to have the primary responsibility.

EPA requested comment on adding regulatory text that would explicitly apply these provisions to tire

manufacturers. Comments from the tire industry generally opposed this noting that they are not the manufacturer of the vehicle. These comments are correct that tires are not incomplete vehicles and hence that the recall authority does not apply for companies that only manufacture the tires. However, EPA remains of the view that in the event that vehicles (e.g. trailers) do not conform to the standards in-use due to nonconforming tires, tire manufacturers would have a role to play in remedying the problem. In this (hypothetical) situation, a tire manufacturer would not only have produced the part in question, but in the case of a trailer manufacturer or other small vehicle manufacturer, would have significantly more resources and knowledge regarding how to address (and redress) the problem. Accordingly, EPA would likely require that a component manufacturer responsible for the nonconformity assist in the recall to an extent and in a manner consistent with the provisions of CAA section 208(a). This section specifies that component and part manufacturers "shall establish and maintain records, perform tests where such testing is not otherwise reasonably available under this part and part C of this subchapter (including fees for testing), make reports and provide information the Administrator may reasonably require to determine whether the manufacturer or other person has acted or is acting in compliance with this part and part C of this subchapter and regulations thereunder, or to otherwise carry out the provision of this part and part C of this subchapter. . .". Any such action would be considered on a case-by-case basis, adapted to the particular circumstances at the time.

(g) Vehicle Labeling

EPA proposed to largely continue the Phase 1 engine and vehicle labeling requirements, but to eliminate the requirement for tractor and vocational vehicle manufacturers to list emission control on the label. The agencies consider it crucial that authorized compliance inspectors are able to identify whether a vehicle is certified, and if so whether it is in its certified condition. To facilitate this identification in Phase 1, EPA adopted labeling provisions for tractors that included several items. The Phase 1 tractor label must include the manufacturer, vehicle identifier such as the Vehicle Identification Number (VIN), vehicle family, regulatory subcategory, date of manufacture, compliance statements, and emission control system identifiers (see 40 CFR

1037.135). EPA proposed to apply parallel requirements for trailers.

In Phase 1, the emission control system identifiers are limited to vehicle speed limiters, idle reduction technology, tire rolling resistance, some aerodynamic components, and other innovative and advanced technologies. However, the number of emission control systems for greenhouse gas emissions in Phase 2 has increased significantly for tractors and vocational vehicles. For example, all aspects of the engine transmission and drive axle; accessories; tire radius and rolling resistance; wind averaged drag; predictive cruise control; idle reduction technologies; and automatic tire inflation systems are controls which can be evaluated on-cycle in Phase 2 (*i.e.* these technologies' performance can now be input to GEM), but could not be in Phase 1. Due to the complexity in determining greenhouse gas emissions in Phase 2, the agencies do not believe that we can unambiguously determine whether or not a vehicle is in a certified condition through simply comparing information that could be made available on an emission control label with the components installed on a vehicle. Therefore, EPA proposed to remove the requirement to include the emission control system identifiers required in 40 CFR 1037.135(c)(6) and in Appendix III to 40 CFR part 1037 from the emission control labels for vehicles certified to the Phase 2 standards. The agencies received comments on the emission control labels from Navistar, which supported the elimination of the emission control information from the vehicle GHG label.

Although we are largely finalizing the proposed labeling requirements, we remain interested in finding a better approach for labeling. Under the agencies' existing authorities, manufacturers must provide detailed build information for a specific vehicle upon our request. Our expectation is that this information should be available to us via email or other similar electronic communication on a same-day basis, or within 24 hours of a request at the latest. The agencies have started to explore ideas that would provide inspectors with an electronic method to identify vehicles and access on-line databases that would list all of the engine-specific and vehicle-specific emissions control system information. We believe that electronic and Internet technology exists today for using scan tools to read a bar code or radio frequency identification tag affixed to a vehicle that could then lead to secure on-line access to a database of manufacturers' detailed vehicle and

engine build information. Our exploratory work on these ideas has raised questions about the level of effort that would be required to develop, implement and maintain an information technology system to provide inspectors real-time access to this information. We have also considered questions about privacy and data security. We requested comment on the concept of electronic labels and database access, including any available information on similar systems that exist today and on burden estimates and approaches that could address concerns about privacy and data security.

Although we are not finalizing such a program in this rulemaking, we remain very interested in the use of electronic labels that could be used by the agencies to access vehicle information and may pursue these in a future rulemaking. Such a rulemaking would likely consider the feasibility of accessing dynamic link libraries in real-time to view each manufacturer's build records (and perhaps pending orders). The agencies envision that this could be very useful for our inspectors by providing them access to the build information by VIN to confirm that each vehicle has the proper emission control features.

#### (h) Model Year Definition

The agencies proposed to continue the Phase definitions of "model year" for compliance with GHG emissions and fuel efficiency standards. However, in response to comments, the agencies are revising the definition slightly for Phase 2 tractors and vocational vehicles to match the model years of the engines installed in them. The revised definition generally sets the vehicle model year to be the calendar year of manufacture, but allows the vehicle manufacturer the option to select the prior year if the vehicle uses an engine manufactured in the prior model year.<sup>74</sup> Because Phase 2 vehicle standards are based in part on engine performance, some commenters stated that the engine model year should dictate the vehicle's GHG and fuel efficiency compliance model year, and that the emissions and fuel efficiency compliance model year should be presented on the vehicle emissions label. This would allow manufacturers to market a vehicle and certify it to NHTSA's safety standards based on the standards applicable on the date of manufacture, but certify the vehicle for GHG emissions and fuel efficiency purposes based on the engine model

<sup>74</sup> Anti-stockpiling provisions will generally prevent vehicle manufacturers from using new engines older than the prior model year. See Section XIII.B for a discussion of EPA requirements for installing older used engines into new vehicles.

compliance year. For example, a 2023 model year tractor might have a 2022 model year engine in it. The tractor would be marketed as a model year 2023 tractor, certified as complying with NHTSA's safety standards applicable at the time when certifying the vehicle, but would have an "emissions and fuel efficiency compliance model year" of 2022 for purposes of emissions and fuel efficiency standards. In today's action, NHTSA and EPA are finalizing standards that allow for the use of an "emissions and fuel efficiency compliance model year." This is consistent with past program practice, in which certain manufacturers have been able to reclassify tractors to the previous model year for emissions purposes when the tractors use engines from the previous model year.

#### (2) Phase 2 Standards

This section briefly summarizes the Phase 2 standards for each category and identifies the technologies that the agencies project will be needed to meet the standards. Given the large number of different regulatory categories and model years for these standards, the actual numerical standards are not listed. Readers are referred to Sections II through IV for the tables of standards.

##### (a) Summary of the Engine Standards

The agencies are continuing the basic Phase 1 structure for the Phase 2 engine standards. There will be separate standards and test cycles for tractor engines, vocational diesel engines, and vocational gasoline engines. However, as described in Section II, we are adopting a revised test cycle for tractor engines to better reflect actual in-use operation. After consideration of comments, including those specifically addressing whether the agencies should adopt an alternative with accelerated stringency targets, the agencies are adopting engine standards that can generally be characterized as more stringent than the proposed alternative.

Specifically, for diesel tractor engines, the agencies are adopting standards for MY 2027 that are more stringent than the preferred alternative from the proposal, and require reductions in CO<sub>2</sub> emissions and fuel consumption that are 5.1 percent better than the 2017 baseline for tractor engines.<sup>75</sup> We are also adopting standards for MY 2021 and

<sup>75</sup> For the flat baseline referenc case, the agencies project that tractors engines will meet the Phase 1 engine standards with a small compliance margin. The Phase 1 standards for diesel engines will be fully phased-in by MY 2017, so we use MY 2017 as the baseline engine for tractors. Note that we project that vocational engines will achieve additional overcompliance with the Phase 1 vocational engine standards.

MY 2024, requiring reductions in CO<sub>2</sub> emissions and fuel consumption of 1.8 to 4.2 percent better than the 2017 baseline tractor engines. For vocational diesel engines, the new standards will require reductions of 2.3, 3.6, and 4.2 percent in MYs 2021, 2024, and 2027, respectively. These levels are more stringent than the proposed standards for these same MYs, and approximately as stringent in MY 2021 and MY 2024 as the Alternative 4 standards discussed at proposal.<sup>76</sup>

The agencies project that these reductions will be maximum feasible and reasonable for diesel engines based on technological changes that will improve combustion and reduce energy losses. For most of these improvements, the agencies project (*i.e.*, the agencies have set out a potential, but by no means mandatory, compliance path) that manufacturers will begin applying improvements to about 45 percent of their heavy-duty engines by 2021, and ultimately apply them to about 95 percent of their heavy-duty engines by 2024. However, for some of these improvements we project more limited application rates. In particular, we project a more limited use of waste exhaust heat recovery systems in 2027, projecting that about 10 percent of tractor engines will have turbo-compounding systems, and an additional 25 percent of tractor engines will employ Rankine-cycle waste heat recovery. We do not project that turbo-compounding or Rankine-cycle waste heat recovery technology will be utilized in vocational engines due to vocational vehicle drive cycles under which these technologies would not show significant benefit, and also due to low sales volumes, limiting the ability to invest in newer technologies for these vehicles.

As described in Section III.D.(1)(b)(i), the agencies project that some engine manufacturers will be able to achieve larger reductions for at least some of their tractor engines. So in developing the tractor *vehicle* standards, we projected slightly better fuel efficiency for the *average* tractor engine than is required by the engine standards. We are projecting that similar over-compliance will occur for heavy heavy-duty vocational engines.

For gasoline vocational engines, we are not adopting more stringent *engine* standards. Gasoline engines used in

<sup>76</sup> As noted in Section II, the numerical levels of the vocational engine standards also reflect an updated baseline in which Phase 1 vocational engines are more efficient than assumed for the proposal. In addition, the numerical levels of the tractor engine standards reflect an updated baseline to reflect the changes to the test cycle.



vocational vehicles are generally the same engines as are used in the complete HD pickups and vans in the Class 2b and 3 weight categories, although the operational demands of vocational vehicles often require use of the largest, most powerful SI engines, so that some engines fitted in complete pickups and vans are not appropriate for use in vocational vehicles. Given the relatively small sales volumes for gasoline-fueled vocational vehicles, manufacturers typically cannot afford to invest significantly in developing separate technology for these vocational vehicle engines. Thus, we project that in general, vocational gasoline engines will incorporate much of the technology that will be used to meet the pickup and van chassis standards, and this will result in some real world reductions in CO<sub>2</sub>

emissions and fuel consumption. The agencies received many comments suggesting that technologies be applied to increase the stringency of the SI engine standard, which technologies in fact are already presumed to be adopted at 100 percent to meet the MY 2016 engine standard. The commenters did not identify any additional engine technologies that are not already fully considered by the agencies in setting the MY 2016 engine standard, that could be recognized over the HD SI Engine FTP test cycle. We did, however, consider some additional technologies recommended by commenters, which can be recognized over the GEM vehicle cycles. As a result, the Phase 2 *vehicle* standards for gasoline-fueled vocational vehicles are predicated on adoption of engine technologies beyond what is

required to meet the separate engine standard, those additional technologies being advanced engine friction reduction and cylinder deactivation. As described in Section V, we are projecting these technologies to improve fuel consumption over the GEM cycles by nearly one percent in MY 2021, MY 2024, and MY 2027. In other words, this improvement is reflected in the vehicle standards rather than in the engine standards. To the extent any SI engines do not incorporate the projected engine technologies, manufacturers of gasoline-fueled vocational vehicles would need to achieve equivalent reductions from some other technology to meet the GEM-based vehicle standards. The engine standards are summarized in Table I-4.

TABLE I-4—SUMMARY OF PHASE 1 AND PHASE 2 REQUIREMENTS FOR ENGINES IN COMBINATION TRACTORS AND VOCATIONAL VEHICLES

	Phase 1 program	Final 2027 standards
Covered in this category .....	Engines installed in tractors and vocational chassis.	
Share of HDV fuel consumption and GHG emissions.	Combination tractors and vocational vehicles account for approximately 85 percent of fuel use and GHG emissions in the heavy duty truck sector.	
Per vehicle fuel consumption and CO <sub>2</sub> improvement.	5%–9% improvement over MY 2010 baseline, depending vehicle application. Improvements are in addition to improvements from tractor and vocational vehicle standards.	4%–5% improvement over MY 2017 for diesel engines. Note that improvements are captured in complete vehicle tractor and vocational vehicle standards, so that engine improvements and the vehicle improvement shown below are not additive.
Form of the standard .....	EPA: CO <sub>2</sub> grams/horsepower-hour and NHTSA: Gallons of fuel/horsepower-hour.	
Example technology options available to help manufacturers meet standards.	Combustion, air handling, friction and emissions after-treatment technology improvements.	Further technology improvements and increased use of all Phase 1 technologies, plus waste heat recovery systems for tractor engines (e.g., turbo-compound and Rankine-cycle).
Flexibilities .....	ABT program which allows emissions and fuel consumption credits to be averaged, banked, or traded (five year credit life). Manufacturers allowed to carry-forward credit deficits for up to three model years. Interim incentives for advanced technologies, recognition of innovative (off-cycle) technologies not accounted for by the HD Phase 1 test procedures, and credits for certifying early.	Same ABT and off-cycle program as Phase 1. Adjustment factor of 1.36 for credits carried forward from Phase 1 to Phase 2 for SI and LHD CI engines due to change in useful life. Revised multipliers for Phase 2 advanced technologies. No Phase 2 early credit multipliers.

(b) Summary of the Tractor Standards

As explained in Section III, the agencies will largely continue the structure of the Phase 1 tractor program, but adopt new standards and update test procedures, as summarized in Table I-6. The tractor standards for MY 2027 will achieve up to 25 percent lower CO<sub>2</sub> emissions and fuel consumption than a 2017 model year Phase 1 tractor. The agencies project that the 2027 tractor standards could be met through improvements in the:

- Engine<sup>77</sup> (including some use of waste heat recovery systems)
- Transmission
- Driveline
- Aerodynamic design
- Tire rolling resistance
- Idle performance
- Other accessories of the tractor.

The agencies have enhanced the Phase 2 GEM vehicle simulation tool to recognize these technologies, as

<sup>77</sup> Although the agencies are adopting new engine standards with separate engine certification, engine improvements will also be reflected in the vehicle certification process. Thus, it is appropriate to also consider engine improvements in the context of the vehicle standards.

described in Section II.C. The agencies' evaluation shows that some of these technologies are available today, but have very low adoption rates on current vehicles, while others will require some lead time for development and deployment. In addition to the proposed alternative for tractors, the agencies solicited comment on an alternative that reached similar ultimate stringencies, but at an accelerated pace.

We have also determined that there is sufficient lead time to introduce many of these tractor and engine technologies into the fleet at a reasonable cost starting in the 2021 model year. The

2021 model year standards for combination tractors and engines will achieve up to 14 percent lower CO<sub>2</sub> emissions and fuel consumption than a 2017 model year Phase 1 tractor, the 2024 model year standards will achieve up to 20 percent lower CO<sub>2</sub> emissions

and fuel consumption, and as already noted, the 2027 model year standards will achieve up to 25 percent lower CO<sub>2</sub> emissions and fuel consumption. In addition to the CO<sub>2</sub> emission standards for tractors, EPA is adopting new particulate matter (PM) standards

which effectively limit which diesel fueled auxiliary power units (APUs) can be used as emission control devices to reduce main engine idling in tractors, as shown in Table I-5. Additional details are discussed in Section III.C.3.

TABLE I-5—PM STANDARDS RELATED TO DIESEL APUS

Tractor MY	PM emission standard (g/kW-hr)	Expected control technology
2018–2023 .....	0.15	In-cylinder PM control.
2024 .....	0.02	DPF.

TABLE I-6—SUMMARY OF PHASE 1 AND PHASE 2 REQUIREMENTS FOR CLASS 7 AND CLASS 8 COMBINATION TRACTORS

	Phase 1 program	Final 2027 standards
Covered in this category .....	Tractors that are designed to pull trailers and move freight.	
Share of HDV fuel consumption and GHG emissions.	Combination tractors and their engines account for approximately sixty percent of fuel use and GHG emissions in the heavy duty vehicle sector.	
Per vehicle fuel consumption and CO <sub>2</sub> improvement.	10%–23% improvement over MY 2010 baseline, depending on tractor category. Improvements are in addition to improvements from engine standards.	19%–25% improvement over tractors meeting the MY 2017 standards.
Form of the standard .....	EPA: CO <sub>2</sub> grams/ton payload mile and NHTSA: Gallons of fuel/1,000 ton payload mile.	
Example technology options available to help manufacturers meet standards.	Aerodynamic drag improvements; low rolling resistance tires; high strength steel and aluminum weight reduction; extended idle reduction; and speed limiters.	Further technology improvements and increased use of all Phase 1 technologies, plus engine improvements, improved transmissions and axles, tire pressure systems, and predictive cruise control (depending on tractor type).
Flexibilities .....	ABT program which allows emissions and fuel consumption credits to be averaged, banked, or traded (five year credit life). Manufacturers allowed to carry-forward credit deficits for up to three model years. Interim incentives for advanced technologies, recognition of innovative (off-cycle) technologies not accounted for by the HD Phase 1 test procedures, and credits for certifying early.	Same ABT and off-cycle program as Phase 1. Revised multipliers for Phase 2 advanced technologies.

(c) Summary of the Trailer Standards

The final rules contain a set of GHG emission and fuel consumption standards for manufacturers of new trailers that are used in combination with tractors. These standards will significantly reduce CO<sub>2</sub> and fuel consumption from combination tractor-trailers nationwide over a period of several years. As described in Section IV, there are numerous aerodynamic and tire technologies available to manufacturers to achieve these standards. Many of these technologies have already been introduced into the market through EPA’s voluntary SmartWay program and California’s tractor-trailer greenhouse gas requirements.

The agencies are adopting Phase 2 standards that will phase-in beginning in MY 2018 and be fully phased-in by 2027. These standards are predicated on use of aerodynamic and tire improvements, with trailer OEMs making incrementally greater improvements in MYs 2021 and 2024 as standard stringency increases in each of those model years. EPA’s GHG emission standards will be mandatory beginning in MY 2018, while NHTSA’s fuel consumption standards will be voluntary beginning in MY 2018, and be mandatory beginning in MY 2021. In general, the trailer standards being finalized apply only for box vans, flatbeds, tankers, and container chassis.

As described in Section XIV.D and Chapter 12 of the RIA, the agencies are

adopting special provisions to minimize the impacts on small business trailer manufacturers. These provisions have been informed by and are largely consistent with recommendations from the SBAR Panel that EPA conducted pursuant to section 609(b) of the Regulatory Flexibility Act (RFA). Broadly, these provisions provide additional lead time for small business manufacturers, as well as simplified testing and compliance requirements. The agencies also are not finalizing standards for various trailer types, including most specialty types of non-box trailers. Excluding these specialty trailers also reduces the impacts on small businesses.

TABLE I-7—SUMMARY OF PHASE 2 REQUIREMENTS FOR TRAILERS

	Phase 1 program	Final 2027 standards
Covered in this category .....	All lengths of dry vans, refrigerated vans, tanks, flatbeds, and container chassis hauled by low, mid, and high roof day and sleeper cab tractors.	
Share of HDV fuel consumption and GHG emissions.	Trailers are modeled together with combination tractors and their engines. Together, they account for approximately sixty percent of fuel use and GHG emissions in the heavy duty truck sector.	
Per vehicle fuel consumption and CO <sub>2</sub> improvement.	N/A .....	Between 3% and 9% improvement over MY 2018 baseline, depending on the trailer type.
Form of the standard .....	N/A .....	EPA: CO <sub>2</sub> grams/ton payload mile and NHTSA: Gallons/1,000 ton payload mile.
Example technology options available to help manufacturers meet standards.	N/A .....	Low rolling resistance tires and tire pressure systems for most trailers, plus weight reduction and aerodynamic improvements such as side and rear fairings, gap closing devices, and undercarriage treatment for box vans (e.g., dry and refrigerated).
Flexibilities .....	N/A .....	One year delay in implementation for small businesses, trailer manufacturers may use pre-approved aerodynamic data in lieu of additional testing, averaging program available in MY 2027 for manufacturers of dry and refrigerated box vans.

(d) Summary of the Vocational Vehicle Standards

As explained in Section V, the agencies are adopting new vocational vehicle standards that expand upon the Phase 1 Program. These new standards reflect further subcategorization from Phase 1, with separate standards based on mode of operation: Urban, regional, and multi-purpose. The agencies are also adopting optional separate standards for emergency vehicles and other custom chassis vehicles.

The agencies project that the vocational vehicle standards could be met through improvements in the engine, transmission, driveline, lower rolling resistance tires, workday idle reduction technologies, weight reduction, and some application of

hybrid technology. These are described in Section V of this Preamble and in Chapter 2.9 of the RIA. These MY 2027 standards will achieve up to 24 percent lower CO<sub>2</sub> emissions and fuel consumption than MY 2017 Phase 1 standards. The agencies are also making revisions to the compliance program for vocational vehicles. These include: The addition of two idle cycles that will be weighted along with the other drive cycles for each vocational vehicle; and revisions to Phase 2 GEM to recognize improvements to the engine, transmission, and driveline.

Similar to the tractor program, we have determined that there is sufficient lead time to introduce many of these new technologies into the fleet starting in MY 2021. Therefore, we are adopting new standards for MY 2021 and 2024.

Based on our analysis, the MY 2021 standards for vocational vehicles will achieve up to 12 percent lower CO<sub>2</sub> emissions and fuel consumption than a MY 2017 Phase 1 vehicle, on average, and the MY 2024 standards will achieve up to 20 percent lower CO<sub>2</sub> emissions and fuel consumption.

In Phase 1, EPA adopted air conditioning (A/C) refrigerant leakage standards for tractors, as well as for heavy-duty pickups and vans, but not for vocational vehicles. For Phase 2, EPA believes that it will be feasible to apply similar A/C refrigerant leakage standards for vocational vehicles, beginning with the 2021 model year. The certification process for vocational vehicles to certify low-leakage A/C components is identical to that already required for tractors.

TABLE I-8—SUMMARY OF PHASE 1 AND PHASE 2 REQUIREMENTS FOR VOCATIONAL VEHICLE CHASSIS

	Phase 1 program	Final 2027 standard
Covered in this category .....	Class 2b—8 chassis that are intended for vocational services such as delivery vehicles, emergency vehicles, dump truck, tow trucks, cement mixer, refuse trucks, etc., except those qualified as off-highway vehicles. Because of sector diversity, vocational vehicle chassis are segmented into Light, Medium and Heavy Heavy-Duty vehicle categories and for Phase 2 each of these segments are further subdivided using three duty cycles: Regional, Multi-purpose, and Urban.	
Share of HDV fuel consumption and GHG emissions.	Vocational vehicles account for approximately 17 percent of fuel use and GHG emissions in the heavy duty truck sector categories.	
Per vehicle fuel consumption and CO <sub>2</sub> improvement.	2% improvement over MY 2010 baseline. Improvements are in addition to improvements from engine standards.	Up to 24% improvement over MY 2017 standards.
Form of the standard .....	EPA: CO <sub>2</sub> grams/ton payload mile and NHTSA: Gallons of fuel/1,000 ton payload mile.	
Example technology options available to help manufacturers meet standards.	Low rolling resistance tires .....	Further technology improvements and increased use of Phase 1 technologies, plus improved engines, transmissions and axles, weight reduction, hybrids, and workday idle reduction systems.

TABLE I-8—SUMMARY OF PHASE 1 AND PHASE 2 REQUIREMENTS FOR VOCATIONAL VEHICLE CHASSIS—Continued

	Phase 1 program	Final 2027 standard
Flexibilities .....	ABT program which allows emissions and fuel consumption credits to be averaged, banked, or traded (five year credit life). Manufacturers allowed to carry-forward credit deficits for up to three model years. Interim incentives for advanced technologies, recognition of innovative (off-cycle) technologies not accounted for by the HD Phase 1 test procedures, and credits for certifying early.	Same ABT and off-cycle program as Phase 1. Adjustment factor of 1.36 for credits carried forward from Phase 1 to Phase 2 due to change in useful life. Revised multipliers for Phase 2 advanced technologies. No Phase 2 early credit multipliers. Chassis intended for emergency vehicles, cement mixers, coach buses, school buses, transit buses, refuse trucks, and motor homes may optionally use application-specific Phase 2 standards using a simplified version of GEM.

(e) Summary of the Heavy-Duty Pickup and Van Standards

The agencies are adopting new Phase 2 GHG emission and fuel consumption standards for heavy-duty pickups and

vans that will be applied in largely the same manner as the Phase 1 standards. These standards are based on the extensive use of most known and proven technologies, and could result in some use of mild or strong hybrid

powertrain technology. These standards will commence in MY 2021. By 2027, these standards are projected to be 16 percent more stringent than the 2018–2019 standards.

TABLE I-9—SUMMARY OF PHASE 1 AND PHASE 2 REQUIREMENTS FOR HD PICKUPS AND VANS

	Phase 1 program	Final 2027 standard
Covered in this category .....	Class 2b and 3 complete pickup trucks and vans, including all work vans and 15-passenger vans but excluding 12-passenger vans which are subject to light-duty standards.	
Share of HDV fuel consumption and GHG emissions.	HD pickups and vans account for approximately 23% of fuel use and GHG emissions in the heavy duty truck sector.	
Per vehicle fuel consumption and CO <sub>2</sub> improvement.	15% improvement over MY 2010 baseline for diesel vehicles, and 10% improvement for gasoline vehicles.	16% improvement over MY 2018–2019 standards.
Form of the standard .....	Phase 1 standards are based upon a “work factor” attribute that combines truck payload and towing capabilities, with an added adjustment for 4-wheel drive vehicles. There are separate target curves for diesel-powered and gasoline-powered vehicles. The Phase 2 standards are based on the same approach.	
Example technology options available to help manufacturers meet standards.	Engine improvements, transmission improvements, aerodynamic drag improvements, low rolling resistance tires, weight reduction, and improved accessories.	Further technology improvements and increased use of all Phase 1 technologies, plus engine stop-start, and powertrain hybridization (mild and strong).
Flexibilities .....	Two optional phase-in schedules; ABT program which allows emissions and fuel consumption credits to be averaged, banked, or traded (five year credit life). Manufacturers allowed to carry-forward credit deficits for up to three model years. Interim incentives for advanced technologies, recognition of innovative (off-cycle) technologies not accounted for by the HD Phase 1 test procedures, and credits for certifying early.	Same as Phase 1, with phase-in schedule based on year-over-year increase in stringency. Same ABT and off-cycle program as Phase 1. Adjustment factor of 1.25 for credits carried forward from Phase 1 to Phase 2 due to change in useful life. Revised multipliers for Phase 2 advanced technologies. No Phase 2 early credit multipliers.

Similar to Phase 1, the agencies are adopting for Phase 2 a set of continuous equation-based standards for HD pickups and vans. Please refer to Section VI for a description of these standards, including associated tables and figures.

*D. Summary of the Costs and Benefits of the Final Rules*

This section summarizes the projected costs and benefits of the NHTSA fuel consumption and EPA GHG emission standards. See Sections VII through IX and the RIA for additional details about these projections.

For these rules, the agencies used two analytical methods for the heavy-duty pickup and van segment by employing both DOT’s CAFE model and EPA’s MOVES model. The agencies used EPA’s MOVES model to estimate fuel consumption and emissions impacts for tractor-trailers (including the engine that powers the tractor), and vocational vehicles (including the engine that powers the vehicle). Additional calculations were performed to determine corresponding monetized program costs and benefits. For heavy-duty pickups and vans, the agencies performed separate analyses, which we refer to as “Method A” and “Method B.”

In Method A, a new version of the CAFE model was used to project a pathway the industry could use to comply with each regulatory alternative and the estimated effects on fuel consumption, emissions, benefits and costs. In Method B, the CAFE model from the NPRM was used to project a pathway the industry could use to comply with each regulatory alternative, along with resultant impacts on per-vehicle costs. However, the MOVES model was used to calculate corresponding changes in total fuel consumption and annual emissions for pickups and vans in Method B. Additional calculations were performed to determine corresponding

monetized program costs and benefits. NHTSA considered Method A as its central analysis and Method B as a supplemental analysis. EPA considered the results of Method B. The agencies concluded that these methods led the agencies to the same conclusions and the same selection of these standards. See Section VII for additional discussion of these two methods.

#### (1) Reference Case Against Which Costs and Benefits Are Calculated

The No Action Alternatives for today's analysis, alternatively referred to as the "baselines" or "reference cases," assume that the agencies did not issue new rules regarding MD/HD fuel efficiency and GHG emissions. These are the baselines against which costs and benefits for these standards are calculated. The reference cases assume that model year 2018 engine, tractor, vocational vehicle, and HD pickup and van standards will be extended indefinitely and without change. They also assume that no new standards would be adopted for trailers.

The agencies recognize that if these Phase 2 standards had not been adopted, manufacturers would nevertheless continue to introduce new heavy-duty vehicles in a competitive market that responds to a range of factors, and manufacturers might have continued to improve technologies to reduce heavy-duty vehicle fuel consumption. Thus, as described in Section VII, both agencies fully analyzed these standards and the regulatory alternatives against two reference cases. The first case uses a baseline that projects no improvement in new vehicles in the absence of new Phase 2 standards, and the second uses a more dynamic baseline that projects some significant improvements in vehicle fuel efficiency. NHTSA considered its primary analysis to be based on the dynamic baseline, where certain cost-effective technologies are assumed to be applied by manufacturers to improve fuel efficiency beyond the Phase 1 requirements in the absence of new Phase 2 standards. EPA considered both reference cases. The results for all of the regulatory alternatives relative to both reference cases, derived via the same methodologies discussed in this section, are presented in Section X of the Preamble.

The agencies received limited comments on these reference cases. Some commenters expressed support for a flat baseline in the context of the need for the regulations, arguing that little improvement would occur without the regulations. Others supported the less dynamic baseline because they believe

it more fully captures the costs. A number of commenters expressed that purchasers are willing to and do pay for fuel efficiency improving technologies, provided the cost for the technology is paid back through fuel savings within a certain period of time; this is the premise for a dynamic baseline. Some commenters thought it reasonable that the agencies consider both baselines given the uncertainty in this area. No commenters opposed the consideration of both baselines.

The agencies have continued to analyze two different baselines for the final rules because we recognize that there are a number of factors that create uncertainty in projecting a baseline against which to compare the future effects of this action and the remaining alternatives. The composition of the future fleet—such as the relative position of individual manufacturers and the mix of products they each offer—cannot be predicted with certainty at this time. Additionally, the heavy-duty vehicle market is diverse, as is the range of vehicle purchasers. Heavy-duty vehicle manufacturers have reported that their customers' purchasing decisions are influenced by their customers' own determinations of minimum total cost of ownership, which can be unique to a particular customer's circumstances. For example, some customers (*e.g.*, less-than-truckload or package delivery operators) operate their vehicles within a limited geographic region and typically own their own vehicle maintenance and repair centers within that region. These operators tend to own their vehicles for long time periods, sometimes for the entire service life of the vehicle. Their total cost of ownership is influenced by their ability to better control their own maintenance costs, and thus they can afford to consider fuel efficiency technologies that have longer payback periods, outside of the vehicle manufacturer's warranty period. Other customers (*e.g.*, truckload or long-haul operators) tend to operate cross-country, and thus must depend upon truck dealer service centers for repair and maintenance. Some of these customers tend to own their vehicles for about four to seven years, so that they typically do not have to pay for repair and maintenance costs outside of either the manufacturer's warranty period or some other extended warranty period. Many of these customers tend to require seeing evidence of fuel efficiency technology payback periods on the order of 18 to 24 months before seriously considering evaluating a new technology for potential adoption

within their fleet (NAS 2010, Roeth et al. 2013, and Klemick et al. 2014). Purchasers of HD pickups and vans wanting better fuel efficiency tend to demand that fuel consumption improvements pay back within approximately one to three years, but some HD pickup and van owners accrue relatively few vehicle miles traveled per year, such that they may be less likely to adopt new fuel efficiency technologies, while other owners who use their vehicle(s) with greater intensity may be even more willing to pay for fuel efficiency improvements. Regardless of the type of customer, their determination of minimum total cost of ownership involves the customer balancing their own unique circumstances with a heavy-duty vehicle's initial purchase price, availability of credit and lease options, expectations of vehicle reliability, resale value and fuel efficiency technology payback periods. The degree of the incentive to adopt additional fuel efficiency technologies also depends on customer expectations of future fuel prices, which directly impacts customer payback periods. Purchasing decisions are not based exclusively on payback period, but also include the considerations discussed above and in Section X.A.1. For the baseline analysis, the agencies use payback period as a proxy for all of these considerations, and therefore the payback period for the baseline analysis is shorter than the payback period industry uses as a threshold for the further consideration of a technology. See Section X.A.1 of this Preamble and Chapter 11 of the RIA for a more detailed discussion of baselines. As part of a sensitivity analysis, additional baseline scenarios were also evaluated for HD pickups and vans, including baseline payback periods of 12, 18 and 24 months. See Section VI of this Preamble and Chapter 10 of the RIA for a detailed discussion of these additional scenarios.

#### (2) Costs and Benefits Projected for the Phase 2 Standards

The tables below summarize the benefits and costs for the program in two ways: First, from the perspective of a program designed to improve the Nation's energy security and to conserve energy by improving fuel efficiency and then from the perspective of a program designed to reduce GHG emissions. The individual categories of benefits and costs presented in the tables below are defined more fully and presented in more detail in Chapter 8 of the RIA.

Lifetime fuel savings, GHG reductions, benefits, costs and net benefits for model years 2018 through

2029 vehicles as presented below. This is consistent with the NPRM analysis and allows readers to compare the costs and benefits of the final program with those projected for the NPRM. It also includes for modeling purposes at least three model years for each standard.

Table I–10 shows benefits and costs for these standards from the perspective of a program designed to improve the Nation’s energy security and conserve energy by improving fuel efficiency. From this viewpoint, technology costs occur when the vehicle is purchased.

Fuel savings are counted as benefits that occur over the lifetimes of the vehicles produced during the model years subject to the Phase 2 standards as they consume less fuel.

TABLE I–10—LIFETIME FUEL SAVINGS, GHG REDUCTIONS, BENEFITS, COSTS, AND NET BENEFITS FOR MODEL YEARS 2018–2029 VEHICLES USING ANALYSIS METHOD A  
[Billions of 2013\$]<sup>a,b</sup>

Category	3% discount rate	7% discount rate
Fuel Reductions (Billion Gallons) .....	71.1–77.7	
GHG reductions (MMT CO <sub>2</sub> eq) .....	959–1049	
Vehicle Program: Technology and Indirect Costs, Normal Profit on Additional Investments .....	23.7 to 24.4	16.1 to 16.6
Additional Routine Maintenance .....	1.7 to 1.7	0.9 to 0.9
Congestion, Crashes, Fatalities and Noise from Increased Vehicle Use <sup>d</sup> .....	3.1 to 3.2	1.8 to 1.9
Total Costs .....	28.5 to 29.3	18.8 to 19.4
Fuel Savings (valued at pre-tax prices) .....	149.1 to 163.0	79.7 to 87.0
Savings from Less Frequent Refueling .....	3.0 to 3.2	1.6 to 1.7
Economic Benefits from Additional Vehicle Use .....	5.4 to 5.5	3.4 to 3.5
Reduced Climate Damages from GHG Emissions <sup>c</sup> .....	33.0 to 36.0	
Reduced Health Damages from Non-GHG Emissions .....	27.1 to 30.0	14.6 to 16.1
Increased U.S. Energy Security .....	7.3 to 7.9	3.9 to 4.2
Total Benefits .....	225 to 246	136 to 149
Net Benefits .....	197 to 216	117 to 129

**Notes:**

<sup>a</sup> For an explanation of analytical Methods A and B, please see Section I.D; for an explanation of the flat baseline, 1a, and dynamic baseline, 1b, please see Section X.A.1.

<sup>b</sup> Range reflects two reference case assumptions 1a and 1b.

<sup>c</sup> Benefits and net benefits use the 3 percent global average SCC value applied only to CO<sub>2</sub> emissions; GHG reductions include CO<sub>2</sub>, CH<sub>4</sub>, N<sub>2</sub>O and HFC reductions, and include benefits to other nations as well as the U.S. See Draft RIA Chapter 8.5 and Preamble Section IX.G for further discussion.

<sup>d</sup> “Congestion, Crashes, Fatalities and Noise from Increased Vehicle Use” includes NHTSA’s monetized value of estimated reductions in the incidence of highway fatalities associated with mass reduction in HD pickup and vans, but this does not include these reductions from tractor-trailers or vocational vehicles. This likely results in a conservative overestimate of these costs.

Table I–11 shows benefits and cost from the perspective of reducing GHG. As shown below in terms of MY lifetime GHG reductions, and in RIA Chapter 5 in terms of year-by-year GHG reductions, the final program is

expected to reduce more GHGs over the long run than the proposed program. In general, the greater reductions can be attributed to increased market penetration and effectiveness of key technologies, based on new data and

comments, leading to increases in stringency such as with the diesel engine standards (Section I.C.(2)(a) above).

TABLE I–11—LIFETIME FUEL SAVINGS, GHG REDUCTIONS, BENEFITS, COSTS AND NET BENEFITS FOR MODEL YEARS 2018–2029 VEHICLES USING ANALYSIS METHOD B  
[Billions of 2012\$]<sup>a,b</sup>

Category	3% discount rate	7% discount rate
Fuel Reductions (Billion Gallons) .....	73–82	
GHG reductions (MMT CO <sub>2</sub> eq) .....	976–1,098	
Vehicle Program (e.g., technology and indirect costs, normal profit on additional investments) .....	–\$26.5 to –\$26.2	–\$17.6 to –\$17.4
Additional Routine Maintenance .....	–\$1.9 to –\$1.9	–\$1.0 to –\$1.0
Fuel Savings (valued at pre-tax prices) .....	\$149.3 to \$169.1	\$76.8 to \$87.2
Energy Security .....	\$6.9 to \$7.8	\$3.5 to \$4.0
Congestion, Crashes, and Noise from Increased Vehicle Use .....	–\$3.2 to –\$3.2	–\$1.8 to –\$1.8
Savings from Less Frequent Refueling .....	\$3.4 to \$4.0	\$1.8 to \$2.1
Economic Benefits from Additional Vehicle Use .....	\$10.4 to \$10.5	\$5.7 to \$5.7
Benefits from Reduced Non-GHG Emissions <sup>c</sup> .....	\$28.3 to \$31.9	\$13.4 to \$15.0

TABLE I-11—LIFETIME FUEL SAVINGS, GHG REDUCTIONS, BENEFITS, COSTS AND NET BENEFITS FOR MODEL YEARS 2018–2029 VEHICLES USING ANALYSIS METHOD B—Continued  
[Billions of 2012\$]<sup>a,b</sup>

Category	3% discount rate	7% discount rate
Reduced Climate Damages from GHG Emissions <sup>d</sup> .....	\$33.0 to \$37.2	
Net Benefits .....	\$200 to \$229	\$114 to \$131

**Notes:**

- <sup>a</sup> For an explanation of analytical Methods A and B, please see Section I.D; for an explanation of the flat baseline, 1a, and dynamic baseline, 1b, please see Section X.A.1.
- <sup>b</sup> Range reflects two baseline assumptions 1a and 1b.
- <sup>c</sup> Range reflects both the two baseline assumptions 1a and 1b using the mid-point of the low and high \$/ton estimates for calculating benefits.
- <sup>d</sup> Benefits and net benefits use the 3 percent average directly modeled SC-GHG values applied to direct reductions of CO<sub>2</sub>, CH<sub>4</sub> and N<sub>2</sub>O emissions; GHG reductions include CO<sub>2</sub>, CH<sub>4</sub> and N<sub>2</sub>O reductions.

Table I-12 breaks down by vehicle standards using the Method A analytical vehicle break-downs of costs and category the benefits and costs for these approach. For additional detail on per- benefits, please see RIA Chapter 10.

TABLE I-12—PER VEHICLE CATEGORY LIFETIME FUEL SAVINGS, GHG REDUCTIONS, BENEFITS, COSTS AND NET BENEFITS FOR MODEL YEARS 2018–2029 VEHICLES USING ANALYSIS METHOD A (BILLIONS OF 2013\$), RELATIVE TO BASELINE 1b<sup>a</sup>

Key costs and benefits by vehicle category	3% discount rate	7% discount rate
<b>Tractors, Including Engines, and Trailers</b>		
Fuel Reductions (Billion Gallons) .....	50	
GHG Reductions (MMT CO <sub>2</sub> eq) .....	685	
Total Costs .....	13.8	9.0
Total Benefits .....	161.0	96.8
Net Benefits .....	147.2	85.5
<b>Vocational Vehicles, Including Engines</b>		
Fuel Reductions (Billion Gallons) .....	12	
GHG Reductions (MMT CO <sub>2</sub> eq) .....	162	
Total Costs .....	7.3	4.8
Total Benefits .....	37.8	22.7
Net Benefits .....	30.5	15.3
<b>HD Pickups and Vans</b>		
Fuel Reductions (Billion Gallons) .....	10	
GHG Reductions (MMT CO <sub>2</sub> eq) .....	111	
Total Costs .....	7.4	5.1
Total Benefits .....	26.0	16.7
Net Benefits .....	18.6	11.6

**Notes:**

- <sup>a</sup> For an explanation of analytical Methods A and B, please see Section I.D; for an explanation of the flat baseline, 1a, and dynamic baseline, 1b, please see Section X.A.1.

TABLE I-13—PER VEHICLE COSTS, USING METHOD A (2013\$), RELATIVE TO BASELINE 1b

	MY 2021	MY 2024	MY 2027
Per Vehicle Cost (\$): <sup>a</sup>			
Tractors .....	\$6,400	\$9,920	\$12,160
Trailers .....	850	1,000	1,070
Vocational Vehicles .....	1,110	2,020	2,660
Pickups/Vans .....	750	760	1,340

**Note:**

- <sup>a</sup> Per vehicle costs include new engine and vehicle technology only; costs associated with increased insurance, taxes and maintenance are included in the payback period values.



TABLE I-14—PER VEHICLE COSTS USING METHOD B RELATIVE TO BASELINE 1a

	MY 2021	MY 2024	MY 2027
Per Vehicle Cost (\$): <sup>a</sup>			
Tractors .....	\$6,484	\$10,101	\$12,442
Trailers .....	868	1,033	1,108
Vocational Vehicles .....	1,110	2,022	2,662
Pickups/Vans .....	524	963	1,364

**Note:**

<sup>a</sup> Per vehicle costs include new engine and vehicle technology only; costs associated with increased insurance, taxes and maintenance are included in the payback period values.

An important metric to vehicle purchasers is the payback period that can be expected on any new purchase. In other words, there is greater willingness to pay for new technology if that new technology “pays back” within an acceptable period of time. The agencies make no effort to define the acceptable period of time, but seek to estimate the payback period for others to make the decision themselves. The payback period is the point at which reduced fuel expenditures outpace increased vehicle costs, including increased maintenance, insurance premiums and taxes. The payback periods for vehicles meeting the standards considered for the final year of implementation are shown in Table I-15, and are similar for both Method A and Method B.

TABLE I-15—PAYBACK PERIODS FOR MY 2027 VEHICLES RELATIVE TO BASELINE 1a

[Payback occurs in the year shown; using 7% discounting]

Tractors/Trailers .....	2nd.
Vocational Vehicles .....	4th.
Pickups/Vans .....	3rd.

TABLE I-16—PAYBACK PERIODS FOR MY 2027 VEHICLES RELATIVE TO BASELINE 1b

[Payback occurs in the year shown; using 7% discounting]

Tractors/Trailers .....	2nd.
Vocational Vehicles .....	4th.
Pickups/Vans .....	3rd.

(3) Cost Effectiveness

These regulations implement section 32902(k) of EISA and section 202(a)(1) and (2) of the Clean Air Act. Through the 2007 EISA, Congress directed NHTSA to create a medium- and heavy-

duty vehicle fuel efficiency program designed to achieve the maximum feasible improvement by considering appropriateness, cost effectiveness, and technological feasibility to determine maximum feasible standards.<sup>78</sup> The Clean Air Act requires that any air pollutant emission standards for heavy-duty vehicles and engines take into account the costs of any requisite technology and the lead time necessary to implement such technology. Both agencies considered overall costs, overall benefits and cost effectiveness in developing the Phase 2 standards. Although there are different ways to evaluate cost effectiveness, the essence is to consider some measure of costs relative to some measure of impacts.

Considering that Congress enacted EPCA and EISA to, among other things, address the need to conserve energy, the agencies have evaluated these standards in terms of costs per gallon of fuel conserved. We also considered the similar metric of cost of technology per ton of CO<sub>2</sub>e removed, consistent with the objective of CAA section 202(a)(1) and (2) to reduce emissions of air pollutants which contribute to air pollution which endangers public health and welfare. As described in the RIA, the agencies also evaluated these standards using the same approaches employed in HD Phase 1. Together, the agencies have considered the following three ratios of cost effectiveness:

1. Total social costs per gallon of fuel conserved

<sup>78</sup> This EISA requirement applies to regulation of medium- and heavy-duty vehicles. For many years, and as reaffirmed by Congress in 2007, “economic practicability” has been among the factors EPCA requires NHTSA to consider when setting light-duty fuel economy standards at the (required) maximum feasible levels. NHTSA interprets “economic practicability” as a factor involving considerations broader than those likely to be involved in “cost effectiveness.”

2. Technology costs per ton of GHG emissions reduced (CO<sub>2</sub>eq)
3. Technology costs minus fuel savings per ton of GHG emissions reduced

By all three of these measures, the total heavy-duty program will be highly cost effective.

As discussed below, the agencies estimate that over the lifetime of heavy-duty vehicles produced for sale in the U.S. during model years 2018–2029, these standards will cost about \$30 billion and conserve about 75 billion gallons of fuel, such that the first measure of cost effectiveness will be about 40 cents per gallon. Relative to fuel prices underlying the agencies’ analysis, the agencies have concluded that today’s standards will be cost effective.

With respect to the second measure, which is useful for comparisons to other GHG rules, these standards will have overall \$/ton costs similar to the HD Phase 1 rule. As Chapter 7 of the RIA shows, social costs will amount to about \$30 per metric ton of GHG (CO<sub>2</sub>eq) for the entire HD Phase 2 program. This compares well to both the HD Phase 1 rule, which was also estimated to cost about \$30 per metric ton of GHG (without fuel savings), and to the agencies’ estimates of the social cost of carbon.<sup>79</sup> Thus, even without accounting for fuel savings, these standards will be cost-effective.

The following table include the overall per-unit costs of both gallons of fuel conserved and metric tons of GHG emissions abated using both a 3 percent and a 7 percent discount rate. Table I-16 gives these values under the Method A analysis.

<sup>79</sup> As described in Section IX.G, the social cost of carbon is a metric that estimates the monetary value of impacts associated with marginal changes in CO<sub>2</sub> emissions in a given year.

TABLE I-17—METHOD A COST PER-UNIT OF FUEL SAVINGS AND GHG EMISSION REDUCTIONS BY VEHICLE CLASS  
[Relative to the dynamic baseline]

Per-unit costs (2013\$/Unit) by vehicle category	3% Discount rate	7% Discount rate
<b>Tractors, Including Engines, and Trailers</b>		
Cost per Gallon of Fuel Saved .....	\$0.28	\$0.18
Cost per Ton of GHG Emissions Saved .....	20	13
<b>Vocational Vehicles, Including Engines</b>		
Cost per Gallon of Fuel Saved .....	0.61	0.40
Cost per Ton of GHG Emissions Saved .....	45	30
<b>HD Pickups and Vans</b>		
Cost per Gallon of Fuel Saved .....	0.76	0.52
Cost per Ton of GHG Emissions Saved .....	67	46
<b>Total Program</b>		
Cost per Gallon of Fuel Saved .....	0.40	0.26
Cost per Ton of GHG Emissions Saved .....	30	20

When considering these values, it is important to emphasize two points:

1. As is shown throughout this rulemaking, the Phase 2 standards represent the most stringent standards that are technologically feasible and reliably implementable within the lead time provided.

2. These are not the marginal cost-effectiveness values.

Without understanding these two points, some readers might assume that because the tractor-trailer standards are more cost-effective overall than the other standards that manufacturers would choose to over-comply with the more cost-effective tractor or trailer standards and do less for other vehicles.

However, the agencies believe this is not a technologically feasible option.

Because the tractor and trailer standards represent maximum feasible standards, they will effectively require manufacturers to deploy all available technology to meet the standards. The agencies do not project that manufacturers would be able to over-comply with the 2027 standards by a significant margin.

The third measure deducts fuel savings from costs, which also is useful for comparisons to other GHG rules. As shown in Table I-18, the agencies have also calculated the cost per metric ton of CO<sub>2</sub>e emission reductions including the savings associated with reduced fuel

consumption. The calculations presented here include all engine-related costs but do not include benefits associated with the final program such as those associated with criteria pollutant reductions or energy security benefits (discussed in Chapter 8 of this RIA). On this basis, net costs per ton of GHG emissions reduced will be negative under these standards. This means that the value of the fuel savings will be greater than the technology costs, and there will be a net cost saving for vehicle owners. In other words, the technologies will pay for themselves (indeed, more than pay for themselves) in fuel savings.

TABLE I-18—ANNUAL NET COST PER METRIC TON OF CO<sub>2</sub>eq EMISSIONS REDUCED IN THE FINAL PROGRAM VS. THE FLAT BASELINE AND USING METHOD B FOR CALENDAR YEAR 2030

[Dollar values are 2013\$]<sup>a</sup>

Calendar year	Vehicle & maintenance costs (\$billions)	Fuel savings (\$billions)	GHG reduced (MMT)	Net cost (\$/metric ton) <sup>b</sup>
HDE Pickups and Vans .....	1.6	3.9	15	0
Vocational Vehicles .....	1.5	3.5	14	0
Tractor-Trailers .....	2.3	16	64	0
All Vehicles .....	5.5	23	94	0

**Notes:**

<sup>a</sup>For an explanation of analytical Methods A and B, please see the beginning of this Section I.D; for an explanation of the flat baseline, 1a, and dynamic baseline, 1b, please see Section X.A.1. GHG reductions include CO<sub>2</sub> and CO<sub>2</sub> equivalents of CH<sub>4</sub>, and N<sub>2</sub>O.

<sup>b</sup>For each category, fuel savings exceed cost so there is no net cost per ton of GHG reduced.

In addition, while the net economic benefits (*i.e.*, total benefits minus total costs) of these standards is not a traditional measure of their cost effectiveness, the agencies have concluded that the total costs of these standards are justified in part by their significant economic benefits. As

discussed in the previous subsection and in Section IX, this rule will provide benefits beyond the fuel conserved and GHG emissions avoided. The rule's net benefits is a measure that quantifies each of its various benefits in economic terms, including the economic value of the fuel it saves and the climate-related

damages it avoids, and compares their sum to the rule's estimated costs. The agencies estimate that these standards will result in net economic benefits exceeding \$100 billion, making this a highly beneficial program.

EPA and NHTSA received many comments suggesting that more

stringent standards were feasible because many cost effective technologies exist for future vehicle designs. While the agencies agree that many cost effective technologies exist, and indeed, we reflect the potential for many of those technologies to be applied in our analysis for today's final rule, commenters who focused on the cost-effectiveness of technologies did not consistently recognize certain real-world constraints on technology implementation. Manufacturers and suppliers have limited research and development capacities, and although they have some ability to expand (by adding staff or building new facilities), the process of developing and applying new technologies is inherently constrained by time. Adequate lead time is also necessary to complete durability, reliability, and safety testing and ramp up production to levels that might be necessary to meet future standards. If the agencies fail to account for lead time needs in determining the stringency of the standards, we could create unintended consequences, such as technologies that are applied before they are ready and lead to maintenance and repair problems. In addition to cost-effectiveness, then, lead time constraints can also be highly relevant to feasibility of more stringent standards.

#### *E. EPA and NHTSA Statutory Authorities*

This section briefly summarizes the respective statutory authority for EPA and NHTSA to promulgate the Phase 1 and Phase 2 programs. For additional details of the agencies' authority, see Section XV of this document as well as the Phase 1 rule.<sup>80</sup>

##### (1) EPA Authority

Statutory authority for the emission standards in this rule is found in CAA section 202(a)(1) and (2) (which requires EPA to establish standards for emissions of pollutants from new motor vehicles and engines which emissions cause or

contribute to air pollution which may reasonably be anticipated to endanger public health or welfare), and in CAA sections 202(a)(3), 202(d), 203–209, 216, and 301 (42 U.S.C. 7521 (a)(1) and (2), 7521(d), 7522–7543, 7550, and 7601).

Title II of the CAA provides for comprehensive regulation of mobile sources, authorizing EPA to regulate emissions of air pollutants from all mobile source categories. When acting under Title II of the CAA, EPA considers such issues as technology effectiveness, its cost (both per vehicle, per manufacturer, and per consumer), the lead time necessary to implement the technology, and based on this the feasibility and practicability of potential standards; the impacts of potential standards on emissions reductions of both GHGs and non-GHG emissions; the impacts of standards on oil conservation and energy security; the impacts of standards on fuel savings by customers; the impacts of standards on the truck industry; other energy impacts; as well as other relevant factors such as impacts on safety.

This action implements a specific provision from Title II, section 202(a). Section 202(a)(1) of the CAA states that “the Administrator shall by regulation prescribe (and from time to time revise) . . . standards applicable to the emission of any air pollutant from any class or classes of new motor vehicles . . . , which in his judgment cause, or contribute to, air pollution which may reasonably be anticipated to endanger public health or welfare.” With EPA's December 2009 final findings that certain greenhouse gases may reasonably be anticipated to endanger public health and welfare and that emissions of GHGs from section 202(a) sources cause or contribute to that endangerment, section 202(a) requires EPA to issue standards applicable to emissions of those pollutants from new motor vehicles. See *Coalition for Responsible Regulation v. EPA*, 684 F. 3d at 116–125, 126–27 cert. granted by, in part *Util. Air Regulatory Group v. EPA*, 134 S. Ct. 418 (2013), affirmed in

part and reversed in part on unrelated grounds by *Util. Air Regulatory Group v. EPA*, 134 S. Ct. 2427 (2014) (upholding EPA's endangerment and cause and contribute findings, and further affirming EPA's conclusion that it is legally compelled to issue standards under section 202(a) to address emission of the pollutant which endangers after making the endangerment and cause or contribute findings); see also *id.* at 127–29 (upholding EPA's light-duty GHG emission standards for MYs 2012–2016 in their entirety).

Other aspects of EPA's legal authority, including its authority under section 202(a), its testing authority under section 203 of the Act, and its enforcement authorities under sections 205 and 207 of the Act are discussed fully in the Phase 1 rule, and need not be repeated here. See 76 FR 57129–57130.

In this final rule, EPA is establishing first-time CO<sub>2</sub> emission standards for trailers hauled by tractors. 80 FR 40170. Certain commenters, notably the Truck Trailer Manufacturers Association (TTMA), maintained that EPA lacks authority to adopt requirements for trailer manufacturers, and that emission standards for trailers could be implemented, if at all, by requirements applicable to the entity assembling a tractor-trailer combination. The argument is that trailers by themselves are not “motor vehicles” as defined in section 216(2) of the Act, that trailer manufacturers therefore do not manufacture motor vehicles, and that standards for trailers can be imposed, if at all, only on “the party that joined the trailer to the tractor.” Comments of TTMA, p. 4; Comments of TTMA (March 31, 2016) p. 2.

EPA also proposed a number of changes and clarifications for rules respecting glider kits and glider vehicles. 80 FR 40527–40530. As shown in Figure I.1, a glider kit is a tractor chassis with frame, front axle, interior and exterior cab, and brakes.

<sup>80</sup> 76 FR 57106–57129, September 15, 2011.



**Figure I.1 Typical Incomplete Glider Kit Configuration**

It is intended for self-propelled highway use, and becomes a glider vehicle when an engine, transmission, and rear axle are added. Engines are often salvaged from earlier model year vehicles, remanufactured, and installed in the glider kit. The final manufacturer of the glider vehicle, *i.e.* the entity that installs an engine, is typically a different manufacturer than the original manufacturer of the glider kit. The final rule contains emission standards for glider vehicles, but does not contain separate standards for glider kits.<sup>81</sup>

Many commenters to both the proposed rule and the NODA supported EPA's interpretation. However, a number of commenters, including Daimler, argued that glider kits are not motor vehicles and so EPA lacks the authority to impose any rules respecting their sale or configuration. Comments of Daimler, pp. 122–23; Comments of Daimler Trucks (April 1, 2016) pp. 2–3. We respond to these comments below, with a more detailed response appearing in RTC Section 1.3.1 and 14.2.

Under the Act, “motor vehicle” is defined as “any self-propelled vehicle designed for transporting persons or property on a street or highway.” CAA

<sup>81</sup> As discussed in sections (c) and (d) below, however, manufacturers of glider kits can, and typically are, responsible for obtaining a certificate of conformity before shipping a glider kit. This is because they are manufacturers of motor vehicles, in this case, an incomplete vehicle.

section 216(2). At proposal, EPA maintained that tractor-trailers are motor vehicles and that EPA therefore has the authority to promulgate emission standards for complete and incomplete vehicles—both the tractor and the trailer. 80 FR 40170. The same proposition holds for glider kits and glider vehicles. *Id.* at 80 FR 40528. The argument that a trailer, or a glider kit, standing alone, is not self-propelled, and therefore is not a motor vehicle, misses the key issues of authority under the Clean Air Act to promulgate emission standards for motor vehicles produced in discrete segments, and the further issue of the entities—namely “manufacturers”—to which standards and certification requirements apply. Simply put, EPA is authorized to set emission standards for complete and incomplete motor vehicles, manufacturers of complete and incomplete motor vehicles can be required to certify to those emission standards, and there can be multiple manufacturers of a motor vehicle, each of which can be required to certify.

(a) Standards for Complete Vehicles—Tractor-Trailers and Glider Vehicles

Section 202(a)(1) authorizes EPA to set standards “applicable to the emission of any air pollutant from any . . . new motor vehicles.” There is no question that EPA is authorized to establish emission standards under this

provision for complete new motor vehicles, and thus can promulgate emission standards for air pollutants emitted by tractor-trailers and by glider vehicles.

Daimler maintained in its comments that although a glider vehicle is a motor vehicle, it is not a “new” motor vehicle because “glider vehicles, when constructed retain the identity of the donor vehicle, such that the title has already been exchanged, making the vehicles not ‘new’ under the CAA.” Daimler Comments p. 121; see also the similar argument in Daimler Truck Comments (April 1, 2016), p. 4. Daimler maintains that because title to the powertrain from the donor vehicle has already been transferred, the glider vehicle to which the powertrain is added cannot be “new.” Comments of April 1, 2016 p. 4. Daimler also notes that NHTSA considers a truck to be “newly manufactured” and subject to Federal Motor Vehicle Safety Standards when a new cab is used in its assembly, “unless the engine, transmission, and drive axle(s) (as a minimum) of the assembled vehicle are not new, and at least two of these components were taken from the same vehicle.” 49 CFR 571.7(e). Daimler urges EPA to adopt a parallel provision here.

First, this argument appears to be untimely. In Phase 1, EPA already indicated that glider vehicles are new motor vehicles, at least implicitly, by

adopting an interim exemption for them. See 76 FR 57407 (adopting 40 CFR 1037.150(j) indicating that the general prohibition against introducing a vehicle not subject to current model year standards does not apply to MY 2013 or earlier engines). Assuming the argument that glider vehicles are not new can be raised in this rulemaking, EPA notes that the Clean Air Act defines “new motor vehicle” as “a motor vehicle the equitable or legal title to which has never been transferred to an ultimate purchaser” (section 216(3)). Glider vehicles are typically marketed and sold as “brand new” trucks. Indeed, one prominent assembler of glider kits and glider vehicles advertises that “Fitzgerald Glider Kits offers customers the option to purchase a *brand new 2016 tractor*, in any configuration offered by the manufacturer . . . Fitzgerald Glider Kits has mastered the process of taking the ‘Glider Kit’ and installing the components to work seamlessly *with the new truck*.”<sup>82</sup> The purchaser of a “new truck” necessarily takes initial title to that truck.<sup>83</sup> Daimler would have it that this ‘new truck’ terminology is a mere marketing ploy, but it obviously reflects reality. As shown in Figure I.1 above, the glider kit constitutes the major parts of the vehicle, lacking only the engine, transmission, and rear axle. The EPA sees nothing in the Act that compels the result that adding a used component to an otherwise new motor vehicle necessarily vitiates classification of the motor vehicle as “new.” See 80 FR 40528. Rather, reasonable judgments must be made, and in this case, the agency believes it reasonable that the tail need not wag the dog: Adding the engine and transmission to the otherwise-complete vehicle does not prevent the glider vehicle from being “new”—as marketed. The fact that this approach is reasonable, if not mandated, is confirmed by the language of the Act’s definition of “new motor vehicle engine,” which includes any “engine in a new motor vehicle” without regard to whether or not the engine was previously used. EPA has also previously addressed the issue of used components in new engines and vehicles explicitly in regulations in the context of locomotives and locomotive engines in 40 CFR part 1033. There we defined remanufactured locomotives

<sup>82</sup> Advertisement for Fitzgerald Glider kits in *Overdrive* magazine (December 2015) (emphasis added).

<sup>83</sup> Fitzgerald states “All Fitzgerald glider kits will be titled in the state of Tennessee and you will receive a title to transfer to your state.” <https://www.fitzgeraldgliderkits.com/frequently-asked-questions>. Last accessed July 9, 2016.

and locomotive engines to be “new” locomotives and locomotive engines. See 63 FR 18980; see also Summary and Analysis of Comments on Notice of Proposed Rulemaking for Emission Standards for Locomotives and Locomotive Engines (EPA-420-R-97-101 (December 1997)) at pp. 10–14. This is a further reason that the model year of the engine is not determinative of whether a glider vehicle is “new.” As to the suggestion to adopt a provision parallel to the NHTSA definition, EPA notes that the NHTSA definition was developed for different purposes using statutory authority which differs from the Clean Air Act in language and intent. There consequently is no basis for requiring EPA to adopt such a definition, and doing so would impede meaningful control of both GHG emissions and criteria pollutant emissions from glider vehicles.

#### (b) Standards for Incomplete Vehicles

Section 202(a)(1) not only authorizes EPA to set standards “applicable to the emission of any air pollutant from any . . . new motor vehicles,” but states further that these standards are applicable “whether such vehicles . . . are designed as complete systems or incorporate devices to prevent or control such pollution.” The Act in fact thus not only contemplates, but in some instances, directly commands that EPA establish standards for incomplete vehicles and vehicle components. See CAA section 202(a)(6) (standards for onboard vapor recovery systems on “new light-duty vehicles,” and requiring installation of such systems); section 202(a)(5)(A) (standards to control emissions from refueling motor vehicles, and requiring consideration of, and possible design standards for, fueling system components); 202(k) (standards to control evaporative emissions from gasoline-fueled motor vehicles). Both TTMA and Daimler argued, in effect, that these provisions are the exceptions that prove the rule and that without this type of enumerated exception, only entire, complete vehicles can be considered to be “motor vehicles.” This argument is not persuasive. Congress did not indicate that these incomplete vehicle provisions were exceptions to the definition of motor vehicle. Just the opposite. Without amending the new motor vehicle definition, or otherwise indicating that these provisions were not already encompassed within Title II authority over “new motor vehicles”, Congress required EPA to set standards for evaporative emissions from a portion of a motor vehicle. Congress thus indicated in these provisions: (1) That

standards should apply to “vehicles” whether or not the “vehicles” were designed as complete systems; (2) that some standards should explicitly apply only to certain components of a vehicle that are plainly not self-propelled. Congress thus necessarily was of the view that incomplete vehicles can be motor vehicles.

Emission standards EPA sets pursuant to this authority thus can be, and often are focused on emissions from the new motor vehicle, and from portions, systems, parts, or components of the vehicle. Standards thus apply not just to exhaust emissions, but to emissions from non-exhaust portions of a vehicle, or from specific vehicle components or parts. See the various evaporative emission standards for light duty vehicles in 40 CFR part 86, subpart B (e.g., 40 CFR 86.146–96 and 86.150–98 (refueling spitback and refueling test procedures); 40 CFR 1060.101–103 and 73 FR 59114–59115 (various evaporative emission standards for small spark ignition equipment); 40 CFR 86.1813–17(a)(2)(iii) (canister bleed evaporative emission test procedure, where testing is solely of fuel tank and evaporative canister); see also 79 FR 23507 (April 28, 2014) (incomplete heavy duty gasoline vehicles could be subject to, and required to certify compliance with, evaporative emission standards)). These standards are implemented by testing the particular vehicle component, not by whole vehicle testing, notwithstanding that the component may not be self-propelled until it is installed in the vehicle or (in the case of non-road equipment), propelled by an engine.<sup>84</sup>

EPA thus can set standards for all or just a portion of the motor vehicle notwithstanding that an incomplete motor vehicle may not yet be self-propelled. This is not to say that the Act authorizes emission standards for any part of a motor vehicle, however insignificant. Under the Act it is reasonable to consider both the significance of the components in comparison to the entire vehicle and the significance of the components for achieving emissions reductions. A vehicle that is complete except for an ignition switch can be subject to standards even though it is not self-

<sup>84</sup> “Non-road vehicles” are defined differently than “motor vehicles” under the Act, but the difference does not appear relevant here. Non-road vehicles, like motor vehicles, must be propelled by an engine. See CAA section 216(11) (“‘nonroad vehicle’ means a vehicle that is powered by a nonroad engine”). Pursuant to this authority, EPA has promulgated many emission standards applicable to components of engineless non-road equipment, for which the equipment manufacturer must certify.

propelled. Likewise, as just noted, vehicle components that are significant for controlling evaporative emissions can be subject to standards even though in isolation the components are not self-propelled. However, not every individual component of a complete vehicle can be subjected to standards as an incomplete vehicle. To reflect these considerations, EPA is adopting provisions stating that a trailer is a vehicle “when it has a frame with one or more axles attached,” and a glider kit becomes a vehicle when “it includes a passenger compartment attached to a frame with one or more axles.” Section 1037.801 definition of “vehicle,” paragraphs (1)(ii) and (iii); see also Section XIII.B below.

TTMA and Daimler each maintained that this claim of authority is open-ended, and can be extended to the least significant vehicle part. As noted above, EPA acknowledges that lines need to be drawn, but whether looking at the relation between the incomplete vehicle and the complete vehicle, or looking at the relation between the incomplete vehicle and the emissions control requirements, it is evident that trailers and glider kits should properly be treated as vehicles, albeit incomplete ones.<sup>85</sup> They properly fall on the vehicle side of the line. When one finishes assembling a whole aggregation of parts to make a finished section of the vehicle (e.g. the trailer), that is sufficient. You have an entire, complete section made up of assembled parts. Everything needed to be a trailer is complete. This is not an engine block, a wheel, or a headlight. Similarly, glider kits comprise the largely assembled tractor chassis with front axles, frame, interior and exterior cab, and brakes. This is not a few assembled components; rather, it is an assembled truck with a few components missing. See CAA section 216(9) of the Act, which defines “motor vehicle or engine part manufacturer” as “any person engaged in the manufacturing, assembling or rebuilding of any device, system, part, component or element of design which is installed in or on motor vehicles or motor vehicle engines.” Trailers and glider kits are not “installed in or on” a motor vehicle. A trailer is half of the tractor-trailer, not some component installed on the tractor. And one would more naturally refer to the donor drivetrain being installed on the glider kit than vice versa. See Figure I.1 above. Furthermore, as discussed below, the

trailer and the glider kit are significant for purposes of controlling emissions from the completed vehicle.

Incomplete vehicle standards must, of course, be reasonably designed to control emissions caused by that particular vehicle segment. The standards for trailers would do so and account for the tractor-trailer combination by using a reference tractor in the trailer test procedure (and, conversely, by use of a reference trailer in the tractor test procedure). The Phase 2 rule contains no emission standards for glider kits in isolation, but the standards for glider vehicles necessarily reflect the contribution of the glider kit.

#### (c) Application of Emission Standards to Manufacturers

In some ways, the critical issue is to whom these emission standards apply. As explained in this section, the emission standards apply to manufacturers of motor vehicles, and manufacturers thus are required to test and to certify compliance to those standards. Moreover, the Act contemplates that a motor vehicle can have multiple manufacturers. With respect to the further question of which manufacturer certifies and tests in multiple manufacturer situations, EPA rules have long contained provisions establishing responsibilities where a vehicle has multiple manufacturers. We are applying those principles in the Phase 2 rules. The overarching principle is that the entity with most control over the particular vehicle segment due to producing it is usually the most appropriate entity to test and certify.<sup>86</sup> EPA is implementing the trailer and glider vehicle emission standards in accord with this principle, so that the entities required to test and certify are the trailer manufacturer and, for glider kits and glider vehicles, either the manufacturer of the glider kit or glider vehicle, depending on which is more appropriate in individual circumstances.

<sup>85</sup> See discussion of standards applicable to small SI equipment fuel systems, implemented by standards for the manufacturers of that equipment at 73 FR 59115 (“In most cases, nonroad standards apply to the manufacturer of the engine or the manufacturer of the nonroad equipment. Here, the products subject to the standards (fuel lines and fuel tanks) are typically manufactured by a different manufacturer. In most cases the engine manufacturers do not produce complete fuel systems and therefore are not in a position to do all the testing and certification work necessary to cover the whole range of products that will be used. We are therefore providing an arrangement in which manufacturers of fuel-system components are in most cases subject to the standards and are subject to certification and other compliance requirements associated with the applicable standards”).

#### (i) Definition of Manufacturer

Emission standards are implemented through regulation of the manufacturer of the new motor vehicle. See, e.g. section 206(a)(1) (certification testing of motor vehicle submitted by “a manufacturer”); 203(a)(1) (manufacturer of new motor vehicle prohibited from introducing uncertified motor vehicles into commerce); 207(a)(1) (manufacturer of motor vehicle to provide warranty to ultimate purchaser of compliance with applicable emission standards); 207(c) (recall authority); 208(a) (recordkeeping and testing can be required of every manufacturer of new motor vehicle).

The Act further distinguishes between manufacturers of motor vehicles and manufacturers of motor vehicle parts. See, e.g. section 206(a)(2) (voluntary emission control system verification testing); 203(a)(3)(B) (prohibition on parts manufacturers and other persons relating to defeat devices); 207(a)(2) (parts manufacturer may provide warranty certification regarding use of parts); 208(a) (recordkeeping and testing requirements for manufacturers of vehicle and engine “parts or components”).

Thus, the question here is whether a trailer manufacturer or glider kit manufacturer can be a manufacturer of a new motor vehicle and thereby become subject to the certification and related requirements for manufacturers, or must necessarily be classified as a manufacturer of a motor vehicle part or component. EPA may reasonably classify trailer manufacturers and glider kit manufacturers as motor vehicle manufacturers.

Section 216(1) defines a “manufacturer” as “any person engaged in the manufacturing or assembling of new motor vehicles, new motor vehicle engines, new nonroad vehicles or new nonroad engines, or importing such vehicles or engines for resale, or who acts for and is under the control of any such person in connection with the distribution of new motor vehicles, new motor vehicle engines, new nonroad vehicles or new nonroad engines, but shall not include any dealer with respect to new motor vehicles, new motor vehicle engines, new nonroad vehicles or new nonroad engines received by him in commerce.”

It appears plain that this definition was not intended to restrict the definition of “manufacturer” to a single person per vehicle. The use of the conjunctive, specifying that a manufacturer is “any person engaged in the manufacturing or assembling of new motor vehicles . . . or who acts for and is under the control of any such person

<sup>86</sup> Cf. *Marine Shale Processors v. EPA*, 81 F. 3d 1371, 1383 (5th Cir. 1996) (“[w]e make no comment on this argument: This is simply not a thimbleful case”).

. . .” (emphasis added) indicates that Congress anticipated that motor vehicles could have more than one manufacturer, since in at least some cases those will plainly be different people. The capacious reference to “any person engaged in the manufacturing of motor vehicles” likewise allows the natural inference that it could apply to multiple entities engaged in manufacturing.<sup>87</sup>

The provision also applies both to entities that manufacture and entities that assemble, and does so in such a way as to encompass multiple parties: Manufacturers “or” (rather than “and”) assemblers are included. Nor is there any obvious reason that only one person can be engaged in vehicle manufacture or vehicle assembling.

Reading the Act to provide for multiple motor vehicle manufacturers reasonably reflects industry realities, and achieves important goals of the CAA. Since title II requirements are generally imposed on “manufacturers” it is important that the appropriate parties be included within the definition of manufacturer—“any person engaged in the manufacturing or assembling of new motor vehicles.” Indeed, as set out in Chapter 1 of the RIA, most heavy duty vehicles are manufactured or assembled by multiple entities; see also Comments of Daimler (October 1, 2015) p. 103.<sup>88</sup> One entity produces a chassis; a different entity manufactures the engine; specialized components (e.g. garbage compactors, cement mixers) are produced by still different entities. For tractor-trailers, one person manufactures the tractor, another the trailer, a third the engine, and another typically assembles the trailer to the tractor. Installation of various vehicle components occurs at different and varied points and by different entities, depending on ultimate desired configurations. See, e.g. Comments of Navistar (October 1, 2015), pp. 12–13. The heavy duty sector thus differs markedly from the light duty sector (and from manufacturing of light duty pickups and vans), where a single company designs the vehicle and engine (and many of the parts), and does all

<sup>87</sup> See *United States v. Gonzales*, 520 U.S. 1, 5, (1997) (“Read naturally the word ‘any’ has an expansive meaning, that is, ‘one or some’; and indiscriminately of whatever kind”); *New York v. EPA*, 443 F.3d 880, 884–87 (D.C. Cir. 2006).

<sup>88</sup> “The EPA should understand that vehicle manufacturing is a multi-stage process (regardless of the technologies on the vehicles) and that each stage of manufacturer has the incentive to properly complete manufacturing . . . [T]he EPA should continue the longstanding industry practice of allowing primary manufacturers to pass incomplete vehicles with incomplete vehicle documents to secondary manufacturers who complete the installation.”

assembling of components into the finished motor vehicle.

#### (ii) Controls on Manufacturers of Trailers

It is reasonable to view the trailer manufacturer as “engaged in” (section 216(1)) the manufacturing or assembling of the tractor-trailer. The trailer manufacturer designs, builds, and assembles a complete and finished portion of the tractor-trailer. All components of the trailer—the tires, axles, flat bed, outsider cover, aerodynamics—are within its control and are part of its assembling process. The trailer manufacturer sets the design specifications that affect the GHG emissions attributable to pulling the trailer. It commences all work on the trailer, and when that work is complete, nothing more is to be done. The trailer is a finished product. With respect to the trailer, the trailer manufacturer is analogous to the manufacturer of the light duty vehicle, specifying, controlling, and assembling all aspects of the product from inception to completion. GHG emissions attributable to the trailer are a substantial portion of the total GHG emissions from the tractor-trailer.<sup>89</sup> Moreover, the trailer manufacturer is not analogous to the manufacturer of a vehicle part or component, like a tire manufacturer, or to the manufacturer of a side skirt. The trailer is a significant, integral part of the finished motor vehicle, and is essential for the tractor-trailer to carry out its commercial purpose. See 80 FR 40170. Although it is true that another person may ultimately hitch the trailer to a tractor (which might be viewed as completing assembly of the tractor-trailer), as noted above, EPA does not believe that the fact that one person might qualify as a manufacturer, due to “assembling” the motor vehicle, precludes another person from qualifying as a manufacturer, due to “manufacturing” the motor vehicle. Given that section 216(1) does not restrict motor vehicle manufacturers to a single entity, it appears to be consistent with the facts and the Act to consider trailer manufacturers as persons engaged in the manufacture of a motor vehicle.

This interpretation of section 216(1) is also reasonable in light of the various provisions noted above relating to implementation of the emissions standards—certification under section 206, prohibitions on entry into

<sup>89</sup> The relative contribution of trailer controls depends on the types of tractors and trailers, as well as the tier of standards applicable; however, it can be approximately one-third of the total reduction achievable for the tractor-trailer.

commerce under section 203, warranty and recall under section 207, and recordkeeping/reporting under section 208. All of these provisions are naturally applied to the entity responsible for manufacturing the trailer, which manufacturer is likewise responsible for its GHG emissions.

TTMA maintains that if a tractor-trailer is a motor vehicle, then only the entity connecting the trailer to the tractor could be subject to regulation.<sup>90</sup> This is not a necessary interpretation of section 216(1), as explained above. TTMA does not discuss that provision, but notes that other provisions refer to “a” manufacturer (or, in one instance, “the” manufacturer), and maintains that this shows that only a single entity can be a manufacturer. See TTMA Comment pp. 4–5, citing to sections 206(a)(1), 206(b), 207, and 203(a). This reading is not compelled by the statutory text. First, the term “manufacturer” in all of these provisions necessarily reflects the underlying definition in section 216(1), and therefore is not limited to a single entity, as just discussed. Second, the interpretation makes no practical sense. An end assembler of a tractor-trailer is not in a position to certify and warrant performance of the trailer, given that the end-assembler has no control over how trailers are designed, constructed, or even which trailers are attached to the tractor. It makes little sense for the entity least able to control the outcome to be responsible for that outcome. The EPA doubts that Congress compelled such an ungainly implementation mechanism, especially given that it is well known that vehicle manufacture responsibility in the heavy duty vehicle sector is divided, and given further that title II includes requirements for EPA to promulgate emission standards for portions of vehicles.

#### (iii) Controls on Manufacturers of Glider Kits

Application of these same principles indicate that a glider kit manufacturer is a manufacturer of a motor vehicle and, as an entity responsible for assuring that glider vehicles meet the Phase 2 vehicle emission standards, can be a party in the certification process as either the certificate holder or the entity which provides essential test information to the glider vehicle manufacturer. As noted above, glider kits include the entire tractor chassis, cab, tires, body, and brakes. Glider kit manufacturers thus control critical elements of the

<sup>90</sup> Consequently, the essential issue here is not whether EPA can issue and implement emission standards for trailers, but at what point in the implementation process those standards apply.

ultimate vehicle's greenhouse gas emissions, in particular, all aerodynamic features and all emissions related to steer tire type. Glider kit manufacturers would therefore be the entity generating critical GEM inputs—at the least, those for aerodynamics and tires. Glider kit manufacturers also often know the final configuration of the glider vehicle, *i.e.* the type of engine and transmission which the final assembler will add to the glider kit.<sup>91</sup> This is because the typical glider kit contains all necessary wiring, and it is necessary, in turn, for the glider kit manufacturer to know the end configuration in order to wire the kit properly. Thus, a manufacturer of a glider kit can reasonably be viewed as a manufacturer of a motor vehicle under the same logic as above: There can be multiple manufacturers of a motor vehicle; the glider kit manufacturer designs, builds, and assembles a substantial, complete and finished portion of the motor vehicle; and that portion contributes substantially to the GHG emissions from the ultimate glider vehicle. A glider kit is not a vehicle part; rather, it is an assembled truck with a few components missing.

EPA rules have long provided provisions establishing responsibilities where there are multiple manufacturers of motor vehicles. See 40 CFR 1037.620 (responsibilities for multiple manufacturers), 40 CFR 1037.621 (delegated assembly), and 40 CFR 1037.622 (shipment of incomplete vehicles to secondary vehicle manufacturers). These provisions, in essence, allow manufacturers to determine among themselves as to which should be the certificate holder, and then assign respective responsibilities depending on that decision. The end result is that incomplete vehicles cannot be introduced into commerce without one of the manufacturers being the certificate holder.

Under the Phase 1 rules, glider kits are considered to be incomplete vehicles which may be introduced into commerce to a secondary manufacturer for final assembly. See 40 CFR

1037.622(b)(1)(i) and 1037.801 (definition of “vehicle” and “incomplete vehicle”) of the Phase 1 regulations (76 FR 57421). Note that 40 CFR 1037.622(b)(1)(i) was originally codified as 40 CFR 1037.620(b)(1)(i). EPA is expanding somewhat on these provisions, but in essence, as under Phase 1, glider kit and glider vehicle manufacturers could operate under delegated assembly provisions whereby the glider kit manufacturer would be the certificate holder. See 40 CFR 1037.621 of the final regulations. Glider kit manufacturers would also continue to be able to ship uncertified kits to secondary manufacturers, and the secondary manufacturer must assemble the vehicle into certifiable condition. 40 CFR 1037.622.<sup>92</sup>

#### (d) Additional Authorities Supporting EPA's Actions

Even if, against our view, trailers and glider kits are not considered to be “motor vehicles,” and the entities engaged in assembling trailers and glider kits are not considered to be manufacturers of motor vehicles, the Clean Air Act still provides authority for the testing requirements adopted here. Section 208 (a) of the Act authorizes EPA to require “every manufacturer of new motor vehicle or engine parts or components” to “perform tests where such testing is not otherwise reasonably available.” This testing can be required to “provide information the Administrator may reasonably require to determine whether the manufacturer . . . has acted or is acting in compliance with this part,” which includes showing whether or not the parts manufacturer is engaged in conduct which can cause a prohibited act. Testing would be required to show that the trailer will conform to the vehicle emission standards. In addition, testing for trailer manufacturers would be necessary here to show that the trailer manufacturer is not causing a violation of the combined tractor-trailer GHG emission standard either by manufacturing a trailer which fails to comply with the trailer emission standards, or by furnishing a trailer to the entity assembling tractor-trailers inconsistent with tractor-trailer certified condition. Testing for glider kit manufacturers is necessary to prevent a glider kit manufacturer furnishing a glider kit inconsistent with the tractor's certified condition. In this regard, we note that section 203 (a)(1) of the Act

not only prohibits certain acts, but also prohibits “the causing” of those acts. Furnishing a trailer not meeting the trailer standard would cause a violation of that standard, and the trailer manufacturer would be liable under section 203 (a)(1) for causing the prohibited act to occur. Similarly, a glider kit supplied in a condition inconsistent with the tractor standard would cause the manufacturer of the glider vehicle to violate the GHG emission standard, so the glider kit manufacturer would be similarly liable under section 203 (a)(1) for causing that prohibited act to occur.

In addition, section 203 (a)(3)(B) prohibits use of “defeat devices”—which include “any part or component intended for use with, or as part of, any motor vehicle . . . where a principal effect of the part or component is to . . . defeat . . . any . . . element of design installed . . . in a motor vehicle” otherwise in compliance with emission standards. Manufacturing or installing a trailer not meeting the trailer emission standard could thus be a defeat device causing a violation of the emission standard. Similarly, a glider kit manufacturer furnishing a glider kit in a configuration that would not meet the tractor standard when the specified engine, transmission, and axle are installed would likewise cause a violation of the tractor emission standard. For example, providing a tractor with a coefficient of drag or tire rolling resistance level inconsistent with tractor certified condition would be a violation of the Act because it would cause the glider vehicle assembler to introduce into commerce a new tractor that is not covered by a *valid* certificate of conformity. Daimler argued in its comments that a glider kit would not be a defeat device because glider vehicles use older engines which are more fuel efficient since they are not meeting the more rigorous standards for criteria pollutant emissions. (Daimler Truck Comment, April 1, 2016, p. 5). However, the glider kit would be a defeat device with respect to the tractor *vehicle* standard, not the separate engine standard. A non-conforming glider kit would adversely affect compliance with the vehicle standard, as just explained. Furthermore, as explained in RTC Section 14.2, Daimler is incorrect that glider vehicles are more fuel efficient than Phase 1 2017 and later vehicles, much less Phase 2 vehicles.

In the memorandum accompanying the Notice of Data Availability, EPA solicited comment on adopting additional regulations based on these principles. EPA has decided not to adopt those provisions, but again notes

<sup>91</sup> PACCAR indicated in its comments that manufacturers of glider kits may not know all details of final assembly. Provisions on delegated assembly, shipment of incomplete vehicles to secondary manufacturers, and assembly instructions for secondary vehicle manufacturers allow manufacturers of glider kits and glider vehicles to apportion responsibilities, as appropriate, including responsibility as to which entity shall be the certificate holder. See 40 CFR 1037.130, 1037.621, and 1037.622. Our point here is that both of these entities are manufacturers of the glider motor vehicle and therefore that both are within the Act's requirements for certification and testing.

<sup>92</sup> Under this provision in the Phase 2 regulations, the glider kit manufacturer would still have some responsibility to ensure that products they introduce into U.S. commerce will conform with the regulations when delivered to the ultimate purchasers.



that the authorities in CAA sections 208 and 203 support the actions EPA is taking here with respect to trailer and glider kit testing.

(e) Standards for Glider Vehicles and Lead Time for Those Standards

At proposal, EPA indicated that engines used in glider vehicles are to be certified to standards for the model year in which these vehicles are assembled. 80 FR 40528. This action is well within the agency's legal authority. As noted above, the Act's definition of "new motor vehicle engine," includes any "engine in a new motor vehicle" without regard to whether or not the engine was previously used. Given the Act's purpose of controlling emissions of air pollutants from motor vehicle engines, with special concern for pollutant emissions from heavy-duty engines (see, e.g., section 202(a)(3)(A) and (B)), it is reasonable to require engines placed in newly-assembled vehicles to meet the same standards as all other engines in new motor vehicles. Put another way, it is both consistent with the plain language of the Act and reasonable and equitable for the engines in "new trucks" (see Section I.E.(1)(a) above) to meet the emission standards for all other engines installed in new trucks.

Daimler challenged this aspect of EPA's proposal, maintaining that it amounted to regulation of vehicle rebuilding, which (according to the commenter) is beyond EPA's authority. Comments of Daimler, p. 123; Comments of Daimler Trucks (April 1, 2016) p. 3. This comment is misplaced. The EPA has authority to regulate emissions of pollutants from engines installed in new motor vehicles. As explained in subsection (a) above, glider vehicles are new motor vehicles. As also explained above, the Act's definition of "new motor vehicle engine" includes any "engine in a new motor vehicle" without regard to whether or not the engine was previously used. CAA section 216(3). Consequently, a previously used engine installed in a glider vehicle is within EPA's multiple authorities. See CAA sections 202(a)(1) (GHGs), 202(a)(3)(A) and (B)(ii) (hydrocarbon, CO, PM and NO<sub>x</sub> from heavy-duty vehicles or engines), and 202(a)(3)(D) (pollutants from rebuilt heavy duty engines).<sup>93</sup>

<sup>93</sup> Comments from, e.g. Mondial and MEMA made clear that all of the donor engines installed in glider vehicles are rebuilt. See also <http://www.truckinginfo.com/article/story/2013/04/the-return-of-the-glider.aspx> ("1999 to 2002-model diesels were known for reliability, longevity and good fuel mileage. Fitzgerald favors Detroit's 12.7-liter Series 60 from that era, but also installs pre-EGR 14-liter

As explained in more detail in Section XIII.B, the final rule requires that as of January 1, 2017, glider kit and glider vehicle production involving engines not meeting criteria pollutant standards corresponding to the year of glider vehicle assembly be allowed at the highest annual production for any year from 2010 to 2014. See section 1037.150(t)(3). (Certain exceptions to this are explained in Section XIII.B.) The rule further requires that as of January 1, 2018, engines in glider vehicles meet criteria pollutant standards and GHG standards corresponding to the year of the glider vehicle assembly, but allowing certain small businesses to introduce into commerce vehicles with engines meeting criteria pollutant standards corresponding to the year of the engine for up to 300 vehicles per year, or up to the highest annual production volume for calendar years 2010 to 2014, whichever is less. Section 1037.150(t)(1)(ii) (again subject to various exceptions explained in Section XIII.B). Glider vehicles using these exempted engines will not be subject to the Phase 1 GHG *vehicle* standards, but will be subject to the Phase 2 vehicle standards beginning with MY 2021. As explained in Section XIII.B, there are compelling environmental reasons for taking these actions in this time frame.

With regard to the issue of lead time, EPA indicated at proposal that the agency has long since justified the criteria pollutant standards for engines installed in glider kits. 80 FR 40528. EPA further proposed that engines installed in glider vehicles meet the emission standard for the year of glider vehicle assembly, as of January 1, 2018 and solicited comment on an earlier effective date. *Id.* at 40529. The agency noted that CAA section 202(a)(3)(D)<sup>94</sup> requires that standards for rebuilt heavy-duty engines take effect "after a period . . . necessary to permit the development and application of the requisite control measures." Here, no time is needed to develop and apply requisite control measures for criteria pollutants because compliant engines are immediately available. In fact, manufacturers of compliant engines, and dealers of trucks containing those compliant engines, commented that they are disadvantaged by manufacturing more costly compliant

Cummins and 15-liter Caterpillar diesels. All are rebuilt. . . .").

<sup>94</sup> The engine rebuilding authority of section 202(a)(3)(D) includes removal of an engine from the donor vehicle. See 40 CFR 86.004-40 and 62 FR 54702 (Oct. 21, 1997). EPA interprets this language as including installation of the removed engine into a glider kit, thereby assembling a glider vehicle.

engines while glider vehicles avoid using those engines. Not only are compliant engines immediately available, but (as commenters warned) there can be risk of massive pre-buys. Moreover, EPA does not envision that glider manufacturers will actually modify the older engines to meet the applicable standards. Rather, they will either choose from the many compliant engines available today, or they will seek to qualify under other flexibilities provided in the final rule. See Section XIII.B. Given that compliant engines are immediately available, the flexibilities provided in the final rule for continued use of donor engines for traditional glider vehicle functions and by small businesses, and the need to expeditiously prevent further perpetuation of use of heavily polluting engines, EPA sees a need to begin constraining this practice on January 1, 2017. However, the final rule is merely capping glider production using higher-polluting engines in 2017 at 2010-2014 production levels, which would allow for the production of thousands of glider vehicles using these higher polluting engines, and unlimited production of glider vehicles using less polluting engines.

Various commenters, however, argued that the EPA must provide four years lead-time and three-year stability pursuant to section 202(a)(3)(C) of the Act, which applies to regulations for criteria pollutant emissions from heavy duty vehicles or engines. For criteria pollutant standards, CAA section 202(a)(3)(C) establishes lead time and stability requirements for "[a]ny standard promulgated or revised under this paragraph and applicable to classes or categories of heavy duty vehicles or engines." In this rule, EPA is generally requiring large manufacturers of glider vehicles to use engines that meet the standards for the model year in which a vehicle is manufactured. EPA is not promulgating new criteria pollutant standards. The NO<sub>x</sub> and PM standards that apply to heavy duty engines were promulgated in 2001.

We are not amending these provisions or promulgating new criteria pollutant standards for heavy duty engines here. EPA interprets the phrase "classes or categories of heavy duty vehicles or engines" in CAA section 202(a)(3)(C) to refer to categories of vehicles established according to features such as their weight, functional type, (e.g. tractor, vocational vehicle, or pickup truck) or engine cycle (spark-ignition or compression-ignition), or weight class of the vehicle into which an engine is installed (LHD, MHD, or HHD). EPA has established several different categories

of heavy duty vehicles (distinguished by gross vehicle weight, engine-cycle, and other criteria related to the vehicles' intended purpose) and is establishing in this rule GHG standards applicable to each category.<sup>95</sup> By contrast, a "glider vehicle" is defined not by its weight or function but by its method of manufacture. A Class 8 tractor glider vehicle serves exactly the same function and market as a Class 8 tractor manufactured by another manufacturer. Similarly, rebuilt engines installed in glider vehicles (*i.e.* donor engines) are not distinguished by engine cycle, but rather serve the same function and market as any other HHD or MHD engine. Thus, EPA considers "glider vehicles" to be a description of a method of manufacturing new motor vehicles, not a description of a separate "class or category" of heavy duty vehicles or engines. Consequently, EPA is not adopting new standards for a class or category of heavy duty engines within the meaning of section 202(a)(3)(C) of the Act.

EPA believes this approach is most consistent with the statutory language and the goals of the Clean Air Act. The date of promulgation of the criteria pollutant standards was 2001. There has been plenty of lead time for the criteria pollutant standards and as a result, manufacturers of glider vehicles have many options for compliant engines that are available on the market today—just as manufacturers of other new heavy-duty vehicles do. We are even providing additional compliance flexibilities to glider manufacturers in recognition of the historic practice of salvaging a small number of engines from vehicles involved in crashes. See Section XIII.B. We do not believe that Congress intended to allow changes in how motor vehicles are manufactured to be a means of avoiding existing, applicable engine standards. Obviously, any industry attempts to avoid or circumvent standards will not become apparent until the standards begin to apply. The commenters' interpretation would effectively preclude EPA from curbing many types of avoidance, however dangerous, until at least four years from detection.

As to Daimler's further argument that the lead time provisions in section 202(3)(C) not only apply but also must trump those specifically applicable to heavy duty engine rebuilding, the usual rule of construction is that the more specific provision controls. See, *e.g.* *HCSC-Laundry v. U.S.*, 450 U.S.1, 6

(1981). Daimler's further argument that section 202(a)(3)(C) lead time provisions also apply to engine rebuilding because those provisions fall within the same paragraph would render the separate lead time provisions for engine rebuilding a virtual nullity. The sense of the provision is that Congress intended there to be independent lead time consideration for the distinct practice of engine rebuilding. In any case, as just explained, it is EPA's view that section 202(a)(3)(C) does not apply here.

## (2) NHTSA Authority

The Energy Policy and Conservation Act (EPCA) of 1975 mandates a regulatory program for motor vehicle fuel economy to meet the various facets of the need to conserve energy. In December 2007, Congress enacted the Energy Independence and Security Act (EISA), amending EPCA to require, among other things, the creation of a medium- and heavy-duty fuel efficiency program for the first time.

Statutory authority for the fuel consumption standards in this final rule is found in EISA section 103, 49 U.S.C. 32902(k). This section authorizes a fuel efficiency improvement program, designed to achieve the maximum feasible improvement to be created for commercial medium- and heavy-duty on-highway vehicles and work trucks, to include appropriate test methods, measurement metrics, standards, and compliance and enforcement protocols that are appropriate, cost-effective and technologically feasible.

NHTSA has responsibility for fuel economy and consumption standards, and assures compliance with EISA through rulemaking, including standard-setting; technical reviews, audits and studies; investigations; and enforcement of implementing regulations including penalty actions. This rule continues to fulfill the requirements of section 103 of EISA, which instructs NHTSA to create a fuel efficiency improvement program for "commercial medium- and heavy-duty on-highway vehicles and work trucks" by rulemaking, which is to include standards, test methods, measurement metrics, and enforcement protocols. See 49 U.S.C. 32902(k)(2).

Congress directed that the standards, test methods, measurement metrics, and compliance and enforcement protocols be "appropriate, cost-effective, and technologically feasible" for the vehicles to be regulated, while achieving the "maximum feasible improvement" in fuel efficiency. NHTSA has broad discretion to balance the statutory factors in section 103 in developing fuel consumption standards

to achieve the maximum feasible improvement.

As discussed in the Phase 1 final rule, NHTSA has determined that the five year statutory limit on average fuel economy standards that applies to passengers and light trucks is not applicable to the HD vehicle and engine standards. As a result, the Phase 1 HD engine and vehicle standards remain in effect indefinitely at their 2018 or 2019 MY levels until amended by a future rulemaking action. As was contemplated in that rule, NHTSA is finalizing a Phase 2 rulemaking action. Therefore, the Phase 1 standards will not remain in effect at their 2018 or 2019 MY levels indefinitely; they will remain in effect until the MY Phase 2 standards begin. In accordance with section 103 of EISA, NHTSA will ensure that not less than four full MYs of regulatory lead-time and three full MYs of regulatory stability are provided for in the Phase 2 standards.

With respect to the proposal, many stakeholders opined in their comments as to NHTSA's legal authority to issue the Phase 2 medium- and heavy-duty standards (Phase 2 standards), in whole or in part. NHTSA addresses these comments in the following discussion.

Allison Transmission, Inc. (Allison) questioned NHTSA's authority to issue the Phase 2 Standards. Allison stated that the Energy Independence and Security Act of 2007 (EISA)<sup>96</sup> directs NHTSA to undertake "a rulemaking proceeding," (emphasis added) predicated on a study by the National Academy of Sciences (NAS). Allison and the Truck Trailer Manufacturers Association (TTMA) asserted that because NAS has published a study on medium- and heavy duty vehicles and NHTSA promulgated the Phase 1 medium- and heavy-duty vehicle standards (Phase 1 standards), NAS and NHTSA have fulfilled their statutory duties under EISA. Thus, Allison stated, NHTSA has no authority to issue standards beyond the Phase 1 standards.

NHTSA maintains that EISA allows the agency to promulgate medium- and heavy duty fuel efficiency standards beyond the Phase 1 standards. EISA states that NHTSA:<sup>97</sup>

by regulation, shall determine in a rulemaking proceeding how to implement a commercial medium- and heavy-duty on-highway vehicle and work truck fuel

<sup>96</sup> Public Law 110-140, 121 Stat. 1492. (December 19, 2007).

<sup>97</sup> By delegation at 49 CFR 1.95(a). For purposes of this NPRM, grants of authority from EISA to the Secretary of Transportation regarding fuel efficiency will be referred to as grants of authority to NHTSA, as NHTSA has been delegated the authority to implement these programs.

<sup>95</sup> Note, however, the Phase 2 GHG standards for tractors and vocational vehicles do not apply until MY 2021.

efficiency program designed to achieve the maximum feasible improvement, and shall adopt and implement appropriate test methods, measurement metrics, fuel economy standards, and compliance and enforcement protocols . . . for commercial medium- and heavy-duty on-highway vehicles and work trucks.<sup>98</sup>

Allison equates the process by which Congress specified NHTSA promulgate standards—a rulemaking proceeding—to mean a limitation or constraint on NHTSA’s ability to create, amend, or update the medium- and heavy duty fuel efficiency program. NHTSA believes the charge in 49 U.S.C. 32902(k)(2) discusses “a rulemaking proceeding” only insofar as the statute specifies the process by which NHTSA would create a medium- and heavy-duty on-highway vehicle and work truck fuel efficiency improvement program and its associated standards.

Allison and TTMA commented that EISA only refers to an initial NAS study, meaning EISA only specified that NHTSA issue one set of standards based on that study. As NHTSA stated in the NPRM, EISA requires NAS to issue updates to the initial report every five years through 2025.<sup>99</sup> With that in mind, NAS issued an interim version of its first update to inform the Phase 2 NPRM. EISA’s requirement that NAS update its initial report, which examines existing and potential fuel efficiency technologies that can practically be integrated into medium- and heavy-duty vehicles, is consistent with the conclusion that EISA intended the medium- and heavy-duty standards to function as part of an ongoing program<sup>100</sup> and not a single rulemaking.

Allison also noted that the language in EISA discussing lead time and stability refers to a single medium- and heavy-duty on-highway vehicle and work truck fuel economy standard.<sup>101</sup> NHTSA believes the language highlighted by Allison serves the purpose of noting that each medium- and heavy-duty segment standard included in its program shall have the requisite amount of lead-time and stability. As discussed in 49 U.S.C.

32902(k)(2), “[t]he Secretary may prescribe separate standards for different classes of vehicles . . .” Since NHTSA has elected to set standards for particular classes of vehicles, this language ensures each particular standard shall have the appropriate lead-time and stability required by EISA.

TTMA asserted that NHTSA has no more than 24 months from the completion of the NAS study to issue regulations related to the medium- and heavy-duty program and therefore regulations issued after 2013 “lack congressional authorization.” This argument significantly misinterprets the Congressional purpose of this provision. Section 32902(k)(2) requires that, 24 months after the completion of the NAS study, NHTSA begin implementing through a rulemaking proceeding a commercial medium- and heavy-duty on-highway vehicle and work truck fuel efficiency improvement program. Congress therefore authorized NHTSA to implement through rulemaking a “program,” which the dictionary defines as “a plan of things that are done in order to achieve a specific result.”<sup>102</sup> Contrary to TTMA’s assertion, Congress did not limit NHTSA to the establishment of one set of regulations, nor did it in any way limit NHTSA’s ability to update and revise this program. The purpose of the 24 month period was simply to ensure that NHTSA exercised this authority expeditiously after the NAS study, which NHTSA accomplished by implementing the first phase of its fuel efficiency program in 2011.<sup>103</sup> Today’s rulemaking merely continues this program and clearly comports with the statutory language in 49 U.S.C. 32902(k). Further, the specific result sought by Congress in establishing the medium- and heavy-duty fuel efficiency program was a program focused on continuing fuel efficiency improvements. Specifically, Congress emphasized that the fuel efficiency program created by NHTSA be “designed to achieve the maximum feasible improvement,” allowing NHTSA to ensure the regulations implemented throughout the program encourage regulated entities to achieve the maximum feasible improvements. Congress did not limit, restrict, or otherwise suggest that the phrase “designed to achieve the maximum feasible improvement” be confined to the issuance of one set of standards.

NHTSA actions are, therefore, clearly consistent with the authority conferred upon it in 49 U.S.C. 32902(k).

POP Diesel stated that the word “fuel” has not been defined by Congress, and therefore NHTSA should use its authority to define the term “fuel” as “fossil fuel,” allowing the agencies to assess fuel efficiency based on the carbon content of the fuels used in an engine or vehicle. Congress has already defined the term “fuel” in 49 U.S.C. 32901(a)(10) as gasoline, diesel oil, or other liquid or gaseous fuel that the Secretary decides to include. As Congress has already spoken to the definition of fuel, it would be inappropriate for the agency to redefine “fuel” as “fossil fuel.”

Additionally, POP Diesel asserted that NHTSA’s metric for measuring fuel efficiency is contrary to the mandate in EISA. Specifically, POP Diesel stated that many dictionaries define “efficiency” as a ratio of work performed to the amount of energy used, and NHTSA’s load specific fuel consumption metric runs afoul of the plain meaning of statute the Phase 2 program implements. POP Diesel noted that Congressional debate surrounding what is now codified at 49 U.S.C. 32902(k)(2) included a discussion that envisioned NHTSA and EPA having separate regulations, despite having overlapping jurisdiction.

NHTSA continues to believe its use of load specific fuel consumption is an appropriate metric for assessing fuel efficiency as mandated by Congress. 49 U.S.C. 32902(k)(2) states, as POP Diesel noted, that NHTSA shall develop a medium- and heavy-duty fuel efficiency program. The section further states that NHTSA “. . . shall adopt and implement appropriate test methods [and] measurement metrics . . . for commercial medium- and heavy-duty on-highway vehicles and work trucks.” In the Phase 1 rulemaking, NHTSA, aided by the National Academies of Sciences (NAS) report, assessed potential metrics for evaluating fuel efficiency. NHTSA found that fuel economy would not be an appropriate metric for medium- and heavy-duty vehicles. Instead, NHTSA chose a metric that considers the amount of fuel consumed when moving a ton of freight (*i.e.*, performing work).<sup>104</sup> This metric, delegated by Congress to NHTSA to formulate, is not precluded by the text of the statute. It is a reasonable way by which to measure fuel efficiency for a program designed to reduce fuel consumption.

<sup>98</sup> Public Law 110–140, 121 Stat. 1492, Section 108. Codified at 49 U.S.C. 32902(k)(2).

<sup>99</sup> 80 FR 40512 (July 13, 2015).

<sup>100</sup> “. . . the Secretary . . . shall determine in a rulemaking proceeding how to implement a commercial medium- and heavy-duty on-highway vehicle and work truck fuel efficiency program designed to achieve the maximum feasible improvement . . .” 49 U.S.C. 42902(k)(2).

<sup>101</sup> 49 U.S.C. 32902(k)(3) states that, “The commercial medium- and heavy-duty on-highway vehicle and work truck fuel economy standard adopted pursuant to this subsection shall provide not less than—(A) 4 full model years of regulatory lead-time; and (B) 3 full model years of regulatory stability.”

<sup>102</sup> “Program.” Merriam-Webster (2016 <http://www.merriam-webster.com/dictionary/program> (last accessed July 19, 2016)).

<sup>103</sup> 76 FR 57016 (September 15, 2011).

<sup>104</sup> See: 75 FR 74180 (November 30, 2010).

## (a) NHTSA's Authority To Regulate Trailers

As contemplated in the Phase 1 proposed and final rules, the agencies proposed standards for trailers in the Phase 2 rulemaking. Because Phase 1 did not include standards for trailers, NHTSA did not discuss its authority for regulating them in the proposed or final rules; that authority is described here.

NHTSA is finalizing fuel efficiency standards applicable to heavy-duty trailers as part of the Phase 2 program. NHTSA received several comments on the proposal relating to the agency's statutory authority to issue standards for trailers as part of the Phase 2 program. In particular, TTMA commented that NHTSA does not have the authority to regulate trailers as part of the medium- and heavy-duty standards. TTMA took issue with NHTSA's use of the National Traffic and Motor Vehicle Safety Act as an aid in defining an undefined term in EISA. Additionally, TTMA stated that EISA's use of GVWR instead of gross combination weight rating (GCWR) to define the vehicles subject to these regulations was intended to exclude trailers from the regulation.

As stated in the proposal, EISA directs NHTSA to "determine in a rulemaking proceeding how to implement a commercial medium- and heavy-duty on-highway vehicle and work truck fuel efficiency improvement program designed to achieve the maximum feasible improvement . . . ." <sup>105</sup> EISA defines a commercial medium- and heavy-duty on-highway vehicle to mean "an on-highway vehicle with a GVWR of 10,000 lbs or more." A "work truck" is defined as a vehicle between 8,500 and 10,000 lbs GVWR that is not an MDPV. These definitions do not explicitly exclude trailers, in contrast to MDPVs. Because Congress did not act to exclude trailers when defining these terms by GVWRs, despite demonstrating the ability to exclude MDPVs, it is reasonable to interpret the provision to include them.

Both the tractor and the trailer are vehicles subject to regulation by NHTSA in the Phase 2 program. Although EISA does not define the term "vehicle," NHTSA's authority to regulate motor vehicles under its organic statute, the Motor Vehicle Safety Act ("Safety Act"), does. The Safety Act defines a motor vehicle as "a vehicle driven or drawn by mechanical power and manufactured primarily for use on public streets, roads, and highways. . . ." <sup>106</sup> NHTSA clearly has authority to regulate trailers

under this Act as they are vehicles that are drawn by mechanical power—in this instance, a tractor engine—and NHTSA has exercised that authority numerous times.<sup>107</sup> Given the absence of any apparent contrary intent on the part of Congress in EISA, NHTSA believes it is reasonable to interpret the term "vehicle" as used in the EISA definitions to have a similar meaning that includes trailers.

Additionally, it is worth noting that the dictionary definition of "vehicle" is "a machine used to transport goods or persons from one location to another."<sup>108</sup> A trailer is a machine designed for the purpose of transporting goods. With these foregoing considerations in mind, NHTSA interprets its authority to regulate commercial medium- and heavy-duty on-highway vehicles, including trailers.

TTMA pointed to language in the Phase 1 NPRM where the agencies stated that GCWR included the weight of a loaded trailer and the vehicle itself. TTMA interprets this language to mean that standards applicable to vehicles defined by GVWR must inherently exclude trailers. The language TTMA cited is a clarification from a footnote in an introductory section describing the heavy-duty trucking industry. This statement was not a statement of NHTSA's legal authority over medium- and heavy-duty vehicles. NHTSA continues to believe a trailer is a vehicle under EISA if its GVWR fits within the definitions in 49 U.S.C. 32901(a), and is therefore subject to NHTSA's applicable fuel efficiency regulations.

Finally, in a comment on the Notice of Data Availability, TTMA stated that because NHTSA's statutory authority instructs the agency to develop a fuel efficiency program for medium- and heavy-duty on-highway vehicles, and trailers themselves do not consume fuel, trailers cannot be regulated for fuel efficiency. The agency disagrees with this assertion. A tractor-trailer is designed for the purpose of holding and transporting goods. While heavy-duty trailers themselves do not consume fuel, they are immobile and inoperative without a tractor providing motive power. Inherently, trailers are designed to be pulled by a tractor, which in turn affects the fuel efficiency of the tractor-trailer as a whole. As previously

discussed, both a tractor and trailer are motor vehicles under NHTSA's authority. Therefore it is reasonable to consider all of a tractor-trailer's parts—the engine, the cab-chassis, and the trailer—as parts of a whole. As such they are all parts of a vehicle, and are captured within the scope of NHTSA's statutory authority. As EPA describes above, the tractor and trailer are both incomplete without the other. Neither can fulfill the function of the vehicle without the other. For this reason, and the other reasons stated above, NHTSA interprets its authority to regulate commercial medium- and heavy-duty on-highway vehicles, including tractor-trailers, as encompassing both tractors and trailers.

## (b) NHTSA's Authority To Regulate Recreational Vehicles

NHTSA did not regulate recreational vehicles as part of the Phase 1 medium- and heavy-duty fuel efficiency standards, although EPA did regulate them as vocational vehicles for GHG emissions. In the Phase 1 NPRM, NHTSA interpreted "commercial medium- and heavy duty on-road vehicle" to mean that recreational vehicles, such as motor homes, were not to be included within the program because recreational vehicles are not commercial. Following comments to the Phase 1 proposal, NHTSA reevaluated its statutory authority and proposed that recreational vehicles be included in the Phase 2 standards, and that early compliance be allowed for manufacturers who want to certify during the Phase 1 period.

The Recreational Vehicle Industry Association (RVIA) and Newell Coach Corporation (Newell) asserted that NHTSA does not have the authority to regulate recreational vehicles (RVs). RVIA and Newell stated that NHTSA's authority under EISA is limited to commercial medium- and heavy-duty vehicles and that RVs are not commercial. RVIA pointed to the fact that EISA gives NHTSA fuel efficiency authority over "commercial medium- and heavy-duty vehicles" and "work trucks," the latter of which is not prefaced with the word "commercial." Because of this difference, RVIA argued that NHTSA is ignoring a limitation on its authority—that is, that NHTSA only has authority over medium- and heavy-duty vehicles that are commercial in nature. RVIA stated that RVs are not used for commercial purposes, and are therefore not subject to Phase 2.

NHTSA's authority to regulate medium- and heavy-duty vehicles under EISA extends to "commercial medium- and heavy-duty on-highway vehicles"

<sup>107</sup> See, e.g., 49 CFR 571.106 (Standard No. 106; Brake hoses); 49 CFR 571.108 (Standard No. 108; Lamps, reflective devices, and associated equipment); 49 CFR 571.121 (Standard No. 121; Air brake systems); 49 CFR 571.223 (Standard No. 223; Rear impact guards).

<sup>108</sup> "Vehicle." Merriam-Webster (2016). <http://www.merriam-webster.com/dictionary/vehicle> (last accessed May 20, 2016).

<sup>105</sup> 49 U.S.C. 42902(k)(2).

<sup>106</sup> 49 U.S.C. 30102(a)(6).

and “work truck[s].”<sup>109</sup> If terms in the statute are defined, NHTSA must apply those definitions. Both terms highlighted by RVIA have been defined in EISA, therefore, NHTSA will use their defined meanings. “Work truck” means a vehicle that is rated between 8,500 and 10,000 pounds GVWR and is not an MDPV.<sup>110</sup> “Commercial medium- and heavy-duty on-road highway vehicle” means an on-highway vehicle with a gross vehicle weight rating (GVWR) of 10,000 pounds or more.<sup>111</sup> Based on the definitions in EISA, recreational vehicles would be regulated as class 2b–8 vocational vehicles. Neither statutory definition requires that those vehicles encompassed be commercial in nature, instead dividing the medium- and heavy-duty segments based on weight. The definitions of “work truck” and “commercial medium- and heavy-duty on-highway vehicles” collectively encompass the on-highway motor vehicles not covered in the light duty CAFE standards.

RVIA further stated that NHTSA’s current fuel efficiency regulations are not consistent with EISA and do not purport to grant NHTSA authority to regulate vehicles simply based on weight. NHTSA’s regulations at 49 CFR 523.6 define, by cross-reference the language in 49 U.S.C. 32901(a)(7) and (19), and consistent with the discussion above, include recreational vehicles.

Finally, NHTSA notes that excluding recreational vehicles in Phase 2 could create illogical results, including treating similar vehicles differently, as determinations over whether a given vehicle would be covered by the program would be based upon either its intended or actual use, rather than the actual characteristics of the vehicle. Moreover, including recreational vehicles under NHTSA regulations furthers the agencies’ goal of one national program, as EPA regulations will continue to regulate recreational vehicles. NHTSA will allow early compliance for manufacturers that want to certify during the Phase 1 period.

#### F. Other Issues

In addition to establishing new Phase 2 standards, this document addresses several other issues related to those standards. The agencies are adopting some regulatory provisions related to the Phase 1 program, as well as amendments related to other EPA and NHTSA regulations. These other issues are summarized briefly here and

discussed in greater detail in later sections.

#### (1) Opportunities for Further Oxides of Nitrogen (NO<sub>x</sub>) Reductions From Heavy-Duty On-Highway Engines and Vehicles

The EPA has the authority under section 202 of the Clean Air Act to establish, and from time to time revise, emission standards for certain air pollutants emitted from heavy-duty on-highway engines and vehicles. The emission standards that EPA has developed for heavy-duty on-highway engines have become progressively more stringent over the past 40 years, with the most recent NO<sub>x</sub> standards for new heavy-duty on-highway engines fully phased in with the 2010 model year. NO<sub>x</sub> emissions standards for heavy-duty on-highway engines have contributed significantly to the overall reduction in the national NO<sub>x</sub> emissions inventory. Nevertheless, a need for additional NO<sub>x</sub> reductions remains, particularly in areas of the country with elevated levels of air pollution. As discussed further below, in response to EPA’s responsibilities under the Clean Air Act, the significant comments we received on this topic during the public comment period, the recent publication by the California Air Resources Board (CARB) of its May 2016 Mobile Source Strategy report and Proposed 2016 Strategy for the State implementation Plan<sup>112</sup> and a recent Petition for Rulemaking,<sup>113</sup> EPA plans to further engage with stakeholders after the publication of this Final Rule to discuss the opportunities for developing more stringent federal standards to further reduce the level of NO<sub>x</sub> emissions from heavy-duty on-highway engines through a coordinated effort with CARB.

NO<sub>x</sub> is one of the major precursors of tropospheric ozone (ozone), exposure to

which is associated with a number of adverse respiratory and cardiovascular effects, as described in Section VIII.A.2 below. These effects are particularly pronounced among children, the elderly, and among people with lung disease such as asthma. NO<sub>x</sub> is also a major contributor to secondary PM<sub>2.5</sub> formation, and exposure to PM<sub>2.5</sub> itself has been linked to a number of adverse health effects (see Section VIII.A.1), such as heart attacks and premature mortality. In addition, NO<sub>2</sub> exposure is linked to asthma exacerbation and possibly to asthma development in children (see Section VIII.A.3). EPA has already adopted many emission control programs that are expected to reduce ambient ozone levels. However, the U.S. Energy Information Administration’s AEO 2015 predicts that vehicles miles travelled (VMT) for heavy-duty trucks will increase in the coming years,<sup>114</sup> and even with the implementation of all current state and federal regulations, some of the most populous counties in the United States are expected to have ozone air quality that exceeds the National Ambient Air Quality Standards (NAAQS) into the future. As of April 22, 2016, there were 44 ozone nonattainment areas for the 2008 ozone NAAQS composed of 216 full or partial counties, with a population of more than 120 million. These nonattainment areas are dispersed across the country, with counties in the west, northeastern United States, Texas, and several Great Lakes states. The geographic diversity of this problem necessitates action at the national level. In California, the San Joaquin Valley and the South Coast Air Basin are highly-populated areas classified as “extreme nonattainment” for the 2008 8-hour ozone standard, with an attainment demonstration deadline of 2031 (one year in advance of the actual 2032 attainment date). In addition, EPA lowered the level of the primary and secondary NAAQS for the 8-hour standards from 75 ppb to 70 ppb in 2015 (2015 ozone NAAQS),<sup>115</sup> with plans to finalize nonattainment designations for the 2015 ozone NAAQS in October 2017. Further NO<sub>x</sub> reductions would provide reductions in ambient ozone levels, helping to prevent adverse health impacts associated with ozone exposure and assisting states and local areas in attaining and maintaining the applicable ozone NAAQS. Reductions in NO<sub>x</sub> emissions would also improve air quality and provide

<sup>112</sup> See “Mobile Source Strategy,” May 16, 2016 from CARB. Available at: <http://www.arb.ca.gov/planning/sip/2016sip/2016mobsr.htm> and “Proposed 2016 State Strategy for the State Implementation Plan,” May 17, 2016 from CARB. Available at <http://www.arb.ca.gov/planning/sip/2016sip/2016sip.htm>.

<sup>113</sup> EPA received a Petition for Rulemaking to adopt new NO<sub>x</sub> emission standards for on-road heavy-duty trucks and engines on June 3, 2016 from the South Coast Air Quality Management District, the Arizona Pima County Department of Environmental Quality, the Bay Area Air Quality Management District, the Connecticut Department of Energy and Environmental Protection Agency, the Delaware Department of Energy and Environmental Protection, the Nevada Washoe County Health District, the New Hampshire Department of Environmental Services, the New York City Department of Environmental Protection, the Akron Regional Air Quality Management District of Akron, Ohio, the Washington State Department of Ecology, and the Puget Sound Clean Air Agency.

<sup>114</sup> US Energy Information Administration. Annual Energy Outlook 2015. April 2015. Page E–8. [http://www.eia.gov/forecasts/aeo/pdf/0383\(2015\).pdf](http://www.eia.gov/forecasts/aeo/pdf/0383(2015).pdf).

<sup>115</sup> 80 FR 65292 (Oct. 26, 2015).

<sup>109</sup> 49 U.S.C. 42902(k)(2).

<sup>110</sup> 49 U.S.C. 42901(a)(19).

<sup>111</sup> 49 U.S.C. 42901(a)(7).

public health and welfare benefits throughout the country by (1) reducing PM formed by reactions of NO<sub>x</sub> in the atmosphere; (2) reducing concentrations of the criteria pollutant NO<sub>2</sub>; (3) reducing nitrogen deposition to sensitive environments; and (4) improving visibility.

In the past year, EPA has received requests from several state and local air quality districts and other organizations asking that EPA establish more stringent NO<sub>x</sub> standards for heavy-duty on-highway engines to help reduce the public's exposure to air pollution. In its comments, CARB estimated that heavy-duty on-highway vehicles currently contribute about one-third of all NO<sub>x</sub> emissions in California. In order to achieve the 2008 ozone NAAQS, California has estimated that the state's South Coast Air Basin will need an 80 percent reduction in NO<sub>x</sub> emissions by 2031. California has the unique ability among states to adopt its own separate new motor engine and vehicle emission standards under section 209 of the CAA; however, CARB commented that EPA action to establish a new federal low-NO<sub>x</sub> standard for heavy-duty trucks is critical, since California standards alone are not sufficient to demonstrate compliance with either the 2008 ozone NAAQS or the 2015, even more stringent ozone NAAQS. CARB has developed a comprehensive mobile source strategy which for heavy-duty on-highway vehicles includes: Lowering the emissions from the in-use fleet; establishing more stringent NO<sub>x</sub> standards for new engines; and accelerating the deployment of zero and near-zero emissions technology.<sup>116</sup> In September of 2015, CARB published a draft of this strategy, *Mobile Source Strategy Discussion Draft*, after which CARB held a public workshop and provided opportunity for public comment. On May 16, 2016, CARB issued a final *Mobile Source Strategy* report.<sup>117</sup> In this report, CARB provides a comprehensive strategy plan for the future of mobile sources and goods movement in the State of California for how mobile sources in California can meet air quality and climate goals over the next fifteen years. Among the many programs discussed are plans for a future on-highway heavy-duty engine

and vehicle NO<sub>x</sub> control regulatory program for new products with implementation beginning in 2024. CARB states "*The need for timely action by U.S. EPA to establish more stringent engine performance standards in collaboration with California efforts is essential. About 60 percent of total heavy-duty truck VMT in the South Coast on any given day is accrued by trucks purchased outside of California, and are exempt from California standards. U.S. EPA action to establish a federal low-NO<sub>x</sub> standard for trucks is critical.*" CARB lays out a time line for a California specific action for new highway heavy-duty NO<sub>x</sub> standards with CARB action in 2017–2019 that would lead to new standards that could begin with the model year 2023. CARB also requests that the U.S. EPA work on a Federal rulemaking action in the 2017–2019 time frame which could result in standards that could begin with the model year 2024. The CARB Mobile Source Strategy document also states "Due to the preponderance of interstate trucking's contribution to in-state VMT, federal action would be far more effective at reducing in-state emissions than a California-only standard. However, California is prepared to develop a California-only standard, if needed, to meet federal attainment targets." CARB goes on to state "[C]ARB will begin development of new heavy-duty low NO<sub>x</sub> emission standard in 2017 with Board action expected in 2019. ARB may also petition U.S. EPA in 2016 to establish new federal heavy-duty engine emission standards . . . . If U.S. EPA begins the regulatory development process for a new federal heavy-duty emission standard by 2017, ARB will coordinate its regulatory development efforts with the federal regulation." On May 17, 2016, CARB published its "Proposed 2016 State Strategy for the State Implementation Plan."<sup>118</sup> This document contains CARB staff's proposed strategy to attain the health-based federal air quality standards over the next fifteen years. With respect to future on-highway heavy-duty NO<sub>x</sub> standards, the proposed State Implementation Plan is fully consistent with the information published by CARB in the Mobile Source Strategy report. EPA intends to work with CARB to consider the development of a new harmonized Federal and California program that would apply lower NO<sub>x</sub> emissions

standards at the national level to heavy-duty on-highway engines and vehicles.

In addition to CARB, EPA received compelling letters and comments from the National Association of Clean Air Agencies, the Northeast States for Coordinated Air Use Management, the Ozone Transport Commission, and the South Coast Air Quality Management District explaining the critical and urgent need to reduce NO<sub>x</sub> emissions that significantly contribute to ozone and fine particulate air quality problems in their represented areas. The comments describe the challenges many areas face in meeting both the 2008 and recently strengthened 2015 ozone NAAQS. These organizations point to the significant contribution of heavy-duty vehicles to NO<sub>x</sub> emissions in their areas, and call upon EPA to begin a rulemaking to require further NO<sub>x</sub> controls for the heavy-duty sector as soon as possible. Commenters such as the American Lung Association, Environmental Defense Fund, Union of Concerned Scientists, the California Interfaith Power and Light, Coalition for Clean Air/California Cleaner Freight Coalition, and the Moving Forward Network similarly describe the air quality and public health need for NO<sub>x</sub> reductions and request EPA to lower NO<sub>x</sub> emissions standards for heavy-duty vehicles. Taken as a whole, the numerous comments, the expected increase in heavy-duty truck VMT, and the fact that ozone challenges will remain across the country demonstrate the critical need for more stringent nationwide NO<sub>x</sub> emissions standards. Such standards are vital to improving air quality nationwide and reducing public health effects associated with exposure to ozone and secondary PM<sub>2.5</sub>, especially for vulnerable populations and in highly impacted regions.

On June 3, 2016, the EPA received a Petition for Rulemaking from the South Coast Air Quality Management District (California), the Pima County Department of Environmental Quality (Arizona), the Bay Area Air Quality Management District (California), the Connecticut Department of Energy and Environmental Protection Agency, the Delaware Department of Energy and Environmental Protection, the Washoe County Health District (Nevada), the New Hampshire Department of Environmental Services, the New York City Department of Environmental Protection, the Akron Regional Air Quality Management District (Ohio), the Washington State Department of Ecology, and the Puget Sound Clean Air

<sup>116</sup> To foster the development of the next generation of lower NO<sub>x</sub> engines, in 2013, CARB adopted optional low-NO<sub>x</sub> heavy-duty engine standards ranging from 0.10 down to 0.02 grams per brake horsepower-hour (g/bhp-hr). CARB also funded over \$1 million to a low-NO<sub>x</sub> engine research and demonstration project at Southwest Research Institute (SwRI).

<sup>117</sup> See "Mobile Source Strategy," May 16, 2016 from CARB. Available at: <http://www.arb.ca.gov/planning/sip/2016sip/2016mobsr.htm>.

<sup>118</sup> See "Proposed 2016 State Strategy for the State Implementation Plan," May 17, 2016 from CARB. Available at <http://www.arb.ca.gov/planning/sip/2016sip/2016sip.htm>.

Agency (Washington).<sup>119 120</sup> In a June 15, 2016 letter to EPA, the Commonwealth of Massachusetts also joined this petition. On June 22, 2016, the San Joaquin Valley Air Pollution Control District (California) also submitted a petition for rulemaking to EPA.<sup>121</sup> In these Petitions, the Petitioners request that EPA establish a new, lower NO<sub>x</sub> emission standard for on-road heavy-duty engines. The Petitioners request that EPA implement a new standard by January 1, 2022, and that EPA establish this new standard through a Final Rulemaking issued by December 31, 2017. EPA is not formally responding to this Petition in this Final Rule, but we will do so in a future action. In the petitions, the Petitioners include a detailed discussion of their views and underlying data regarding the need for large scale reduction in NO<sub>x</sub> emissions from heavy-duty engines, why they believe new standards can be achieved, and their legal views on EPA's responsibilities under the Clean Air Act.

Since the establishment of the current heavy-duty on-highway standards in January of 2001,<sup>122</sup> there has been continued progress in emissions control technology. EPA and CARB are currently investing in research to evaluate opportunities for further NO<sub>x</sub> reductions from heavy-duty on-highway vehicles and engines. Programs and research underway at CARB, as well as a significant body of work in the technical literature, indicate that reducing NO<sub>x</sub> emissions significantly below the current on-highway standard of 0.20 grams per brake horsepower-hour (g/bhp-hr) is potentially feasible.<sup>123 124</sup> Opportunities for additional NO<sub>x</sub> reductions include reducing emissions over cold start operation as well as low-speed, low-load off-cycle operation. Reductions are being accomplished through the use of improved engine management, advanced aftertreatment technologies

(improvements in SCR catalyst design/formulation), catalyst positioning, aftertreatment thermal management, and heated diesel exhaust fluid dosing. At the same time, the effect of these new technologies on cost and GHG emissions is being carefully evaluated,<sup>124</sup> since it is important that any future NO<sub>x</sub> control technologies be considered in the context of the final Phase 2 GHG standards. During the Phase 2 program public comment period, EPA received some comments stressing the need for careful evaluation of emerging NO<sub>x</sub> control technologies and urging EPA to consider the relationship between CO<sub>2</sub> and NO<sub>x</sub> before setting lower NO<sub>x</sub> standards (commenters include American Trucking Association, Caterpillar, Daimler Trucks North America, Navistar Inc., PACCAR Inc., Volvo Group, Truck and Engine Manufacturers Association, Diesel Technology Forum, National Association of Manufacturers, and National Automobile Dealers Association). EPA also received comments pointing to advances in NO<sub>x</sub> emission control technologies that would lower NO<sub>x</sub> without reducing engine efficiency (commenters include Advanced Engine Systems Institute, Clean Energy, Manufacturers of Emission Controls Association, and Union of Concerned Scientists). EPA will continue to evaluate both opportunities and challenges associated with lowering NO<sub>x</sub> emissions from the current standards, and over the coming months we intend to engage with many stakeholders as we develop our response to the June 2016 Petitions for Rulemaking discussed above.

EPA believes the opportunity exists to develop, in close coordination with CARB and other stakeholders, a new, harmonized national NO<sub>x</sub> reduction strategy for heavy-duty on-highway engines which could include the following:

- Substantially lower NO<sub>x</sub> emission standards;
- Improvements to emissions warranties;
- Consideration of longer useful life, reflecting actual in-use activity;
- Consideration of rebuilding/ remanufacturing practices;
- Updated certification and in-use testing protocols;
- Incentives to encourage the transition to next-generation cleaner technologies as soon as possible;
- Improvements to test procedures and test cycles to ensure emission reductions occur in the real-world, not only over the applicable certification test cycles.

Based on the air quality need, the requests described above, the continued progress in emissions control technology, and the June 2016 petitions for rulemaking, EPA plans to engage with a range of stakeholders to discuss the opportunities for developing more stringent federal standards to further reduce the level of NO<sub>x</sub> emissions from heavy-duty on-highway engines, after the publication of this Final Rule. Recognizing the benefits of a nationally harmonized program and given California's unique ability under CAA section 209 to be allowed to regulate new motor vehicle and engine emission standards if certain criteria are met, EPA intends to work closely with CARB on this effort. EPA also intends to engage with truck and engine manufacturers, suppliers, state air quality agencies, NGOs, labor, the trucking industry, and the Petitioners over the next several months as we develop our formal response to the June 2016 Petitions for Rulemaking.

## (2) Issues Related to Phase 2

### (a) Natural Gas Engines and Vehicles

This combined rulemaking by EPA and NHTSA is designed to regulate two separate characteristics of heavy duty vehicles and engines: GHGs and fuel consumption. In the case of diesel or gasoline powered vehicles, there is a one-to-one relationship between these two characteristics. For alternatively fueled vehicles, which use no petroleum, the situation is different. For example, a natural gas vehicle that achieves approximately the same fuel efficiency as a diesel powered vehicle will emit 20 percent less CO<sub>2</sub>; and a natural gas vehicle with the same fuel efficiency as a gasoline vehicle will emit 30 percent less CO<sub>2</sub>. Yet natural gas vehicles consume no petroleum. The agencies are continuing Phase 1 approach, which the agencies have previously concluded balances these facts by applying the gasoline and diesel CO<sub>2</sub> standards to natural gas engines based on the engine type of the natural gas engine. Fuel consumption for these vehicles is then calculated according to their tailpipe CO<sub>2</sub> emissions. In essence, this applies a one-to-one relationship between fuel efficiency and tailpipe CO<sub>2</sub> emissions for all vehicles, including natural gas vehicles. The agencies determined that this approach will likely create a small balanced incentive for natural gas use. In other words, it created a small incentive for the use of natural gas engines that appropriately balanced concerns about the climate impact methane emissions against other factors such as the energy security

<sup>119</sup> [http://4cleanair.org/sites/default/files/resources/HD\\_Ultra-Low-NOx\\_Petition\\_to\\_EPA-060316.pdf](http://4cleanair.org/sites/default/files/resources/HD_Ultra-Low-NOx_Petition_to_EPA-060316.pdf).

<sup>120</sup> [http://4cleanair.org/sites/default/files/resources/Petition\\_Attachments-Ultra-Low-NOx\\_Petition\\_to\\_EPA-060316\\_0.pdf](http://4cleanair.org/sites/default/files/resources/Petition_Attachments-Ultra-Low-NOx_Petition_to_EPA-060316_0.pdf).

<sup>121</sup> [http://www.valleyair.org/recent\\_news/Media\\_releases/2016/PR-District-Petitions-Federal-Government-06-22-16.pdf](http://www.valleyair.org/recent_news/Media_releases/2016/PR-District-Petitions-Federal-Government-06-22-16.pdf).

<sup>122</sup> 66 FR 5002 (January 18, 2001).

<sup>123</sup> See CARB's September 2015 *Draft Technology Assessment: Lower NO<sub>x</sub> Heavy-Duty Diesel Engines*, and *Draft Technology Assessment: Low Emission Natural Gas and Other Alternative Fuel Heavy-Duty Engines*.

<sup>124</sup> <http://www.arb.ca.gov/research/veh-emissions/low-nox/low-nox.htm>, 4/26/16. This low NO<sub>x</sub> study is in the process of selecting the emission reduction systems for final testing and it is expected that this demonstration program will be complete by the end of 2016.



benefits of using domestic natural gas. See 76 FR 57123.

(b) Alternative Refrigerants

In addition to use of low-leak components in air conditioning system design, manufacturers can also decrease the global warming impact of any refrigerant leakage emissions by adopting systems that use alternative, lower global warming potential (GWP) refrigerants, to replace the refrigerant most commonly used today, HFC-134a (R-134a). HFC-134a is a potent greenhouse gas with a GWP 1,430 times greater than that of CO<sub>2</sub>.

Under EPA's Significant New Alternatives Policy (SNAP) Program,<sup>125</sup> EPA has found acceptable, subject to use conditions, three alternative refrigerants that have significantly lower GWPs than HFC-134a for use in A/C systems in newly manufactured *light-duty vehicles*: HFC-152a, CO<sub>2</sub> (R-744), and HFO-1234yf.<sup>126</sup> HFC-152a has a GWP of 124, HFO-1234yf has a GWP of 4, and CO<sub>2</sub> (by definition) has a GWP of 1, as compared to HFC-134a which has a GWP of 1,430.<sup>127</sup> CO<sub>2</sub> is nonflammable, while HFO-1234yf and HFC-152a are flammable. All three are subject to use conditions requiring labeling and the use of unique fittings, and where appropriate, mitigating flammability and toxicity. Currently, the SNAP listing for HFO-1234yf is limited to newly manufactured A/C systems in light-duty vehicles, whereas HFC-152a and CO<sub>2</sub> have been found acceptable for all motor vehicle air conditioning applications, including heavy-duty vehicles.

None of these alternative refrigerants can simply be "dropped" into existing HFC-134a air conditioning systems. In order to account for the unique properties of each refrigerant and address use conditions required under SNAP, changes to the systems will be necessary. Typically these changes will need to occur during a vehicle redesign cycle but can also occur during a refresh. For example, because CO<sub>2</sub>, when used as a refrigerant, is physically

and thermodynamically very different from HFC-134a and operates at much higher pressures, a transition to this refrigerant would require significant hardware changes. A transition to A/C systems designed for HFO-1234yf, which is more thermodynamically similar to HFC-134a than is CO<sub>2</sub>, requires less significant hardware changes that typically include installation of a thermal expansion valve and can potentially require resized condensers and evaporators, as well as changes in other components. In addition, vehicle assembly plants require re-tooling in order to handle new refrigerants safely. Thus a change in A/C refrigerants requires significant engineering, planning, and manufacturing investments.

EPA is not aware of any significant development of A/C systems designed to use alternative refrigerants in heavy-duty vehicles.<sup>128</sup> However, all three lower GWP alternatives are in use or under various stages of development for use in LD vehicles. Of these three refrigerants, most manufacturers of LD vehicles have identified HFO-1234yf as the most likely refrigerant to be used in that application. For that reason, EPA anticipates that HFO-1234yf will be a primary candidate for refrigerant substitution in the HD market in the future if it is listed as an acceptable substitute under SNAP for HD A/C applications.

As mentioned above, EPA has listed as acceptable, subject to use conditions, two lower-GWP refrigerants, R-744 (CO<sub>2</sub>) and HFC-152a, for use in HD vehicles. On April 18, 2016, EPA also proposed to list HFO-1234yf as acceptable, subject to use conditions, in A/C systems for newly manufactured MDPVs, HD pickup trucks, and complete HD vans (81 FR 22810). In that action, EPA proposed to list HFO-1234yf as acceptable, subject to use conditions, for those vehicle types for which human health and environmental risk could be assessed using the currently available risk assessments and analysis on LD vehicles. Also in that action, EPA requested "information on development of HFO-1234yf MVAC systems for other HD vehicle types or off-road vehicles, or plans to develop these systems in the future." EPA also stated "This information may be used to inform a future listing" (81 FR 22868).

In another rulemaking action under the SNAP program, on July 20, 2015, EPA published a final rule (80 FR

42870) that will change the listing status of HFC-134a to unacceptable for use in newly manufactured LD motor vehicles beginning in MY 2021 (except as allowed under a narrowed use limit for use in newly manufactured LD vehicles destined for use in countries that do not have infrastructure in place for servicing with other acceptable refrigerants through MY 2025). In that same rule, EPA listed the refrigerant blends SP34E, R-426A, R-416A, R-406A, R-414A, R-414B, HCFC Blend Delta, Freeze 12, GHG-X5, and HCFC Blend Lambda as unacceptable for use in newly manufactured light-duty vehicles beginning in MY 2017. EPA's decisions were based on the availability of other substitutes that pose less overall risk to human health and the environment, when used in accordance with required use conditions. Neither the April 2016 proposed rule nor the July 2015 final rule consider a change of listing status for HFC-134a in HD vehicles.

LD vehicle manufacturers are currently making investments in systems designed for lower-GWP refrigerants, both domestically and on a global basis. In support of the LD GHG rule, EPA projected a full transition of LD vehicles to lower-GWP alternatives in the United States by MY 2021. We expect the costs of transitioning to decrease over time as alternative refrigerants are adopted across all LD vehicles and trucks, in part due to increased availability of components and the continuing increases in refrigerant production capacity, as well as knowledge gained through experience. As lower-GWP alternatives become widely used in LD vehicles, some HD vehicle manufacturers may wish to also transition their vehicles. Transitioning could be advantageous for a variety of reasons, including platform standardization and company environmental stewardship policies.

In the proposal for this Phase 2 HD rule, EPA proposed another action related to alternative refrigerants. EPA proposed to allow a manufacturer to be "deemed to comply" with the leakage standard if its A/C system used a refrigerant other than HFC-134a that was both listed as an acceptable substitute refrigerant for heavy-duty A/C systems under SNAP, and was identified in the LD GHG regulations at 40 CFR 86.1867-12(e). 80 FR 40172. By slightly reducing the regulatory burden of compliance with the leakage standard for a manufacturer that used an alternative refrigerant, the "deemed to comply" provision was intended to provide a modest incentive for the use of such refrigerants. There were comments in support of this approach,

<sup>125</sup> Section 612(c) of the Clean Air Act requires EPA to review substitutes for class I and class II ozone-depleting substances and to determine whether such substitutes pose lower risk than other available alternatives. EPA is also required to publish lists of substitutes that it determines are acceptable and those it determines are unacceptable. See <http://www3.epa.gov/ozone/snap/refrigerants/lists/index.html>, last accessed on March 5, 2015.

<sup>126</sup> Listed at 40 CFR part 82, subpart G.

<sup>127</sup> GWP values cited in this final action are from the IPCC Fourth Assessment Report (AR4) unless stated otherwise. Where no GWP is listed in AR4, GWP values are determined consistent with the calculations and analysis presented in AR4 and referenced materials.

<sup>128</sup> To the extent that some manufacturers produce HD pickups and vans on the same production lines or in the same facilities as LD vehicles, some A/C system technology commonality between the two vehicle classes may be developing.



including from Honeywell and Chemours, both of which manufacture HFO-1234yf.

For several reasons, EPA has reconsidered the proposed “deemed to comply” provision for this rule, and instead, the Phase 2 program retains the Phase 1 requirement that manufacturers attest that they are using low-leak components, regardless of the refrigerant they use. CARB and several NGO commenters expressed concerns about the proposed “deemed to comply” provision, primarily citing the potential for manufacturers to revert to less leak-tight components if they were no longer required to attest to the use of low-leak A/C system components because they used a lower-GWP refrigerant. In general, we expect that the progress LD vehicle manufacturers are making toward more leak-tight A/C systems will continue and that this progress will transfer to HD A/C systems. Still, we agree that continued improvements in low-leak performance HD vehicles is an important goal, and that continuing the Phase 1 leakage requirements in the Phase 2 program should discourage manufacturers from reverting to higher-leak and potentially less expensive components. It is also important to note that there is no “deemed to comply” option in the parallel LD-GHG program—manufacturers must attest to meeting the leakage standard. There is no compelling reason to have a different regime for heavy duty applications.

Although leakage of lower-GWP refrigerants is of less concern from a climate perspective than leakage of higher GWP refrigerants, we also agree with several commenters that expressed a concern related to the servicing of lower-GWP systems with higher-GWP refrigerants in the aftermarket. We agree that this could result due to factors such as price differentials between aftermarket refrigerants. However, as is the case for Phase 1, as a part of certification, HD manufacturers will attest both to the use of low-leak components as well as to the specific refrigerant used. Thus, in the future, a manufacturer wishing to certify a vehicle with an A/C system designed for an alternative refrigerant will attest to the use of that specific refrigerant. In that situation, any end-user servicing and recharging that A/C system with any other refrigerant would be considered tampering with an emission-related component under Title II of the CAA. For example, recharging an A/C system certified to use a lower-GWP refrigerant, such as HFO-1234yf, with any other refrigerant, including but not limited to HFC-134a, would be

considered a violation of Title II tampering provisions.

At the same time, EPA does not believe that finalizing the “deemed to comply” provision would have had an impact on any future transition of the HD industry to alternative refrigerants. As discussed above, two lower-GWP refrigerants are already acceptable for use in HD vehicles, and EPA has proposed to list HFO-1234yf as acceptable, subject to use conditions, for limited HD vehicle types. As also discussed above, and especially in light of the rapid expansion of alternative refrigerants that has been occurring in the LD vehicle market, similar trends may develop in the HD vehicle market, regardless of EPA’s action regarding leakage of alternative refrigerants in this final rule.

#### (c) Small Business Issues

The Regulatory Flexibility Act (RFA) generally requires an agency to prepare a regulatory flexibility analysis of any rule subject to notice and comment rulemaking requirements under the Administrative Procedure Act or any other statute unless the agency certifies that the rule will not have a significant economic impact on a substantial number of small entities. See generally 5 U.S.C. 601–612. The RFA analysis is discussed in Section XIV.

Pursuant to section 609(b) of the RFA, as amended by the Small Business Regulatory Enforcement Fairness Act (SBREFA), EPA also conducted outreach to small entities and convened a Small Business Advocacy Review Panel to obtain advice and recommendations of representatives of the small entities that potentially will be subject to the rule’s requirements. Consistent with the RFA/SBREFA requirements, the Panel evaluated the assembled materials and small-entity comments on issues related to elements of the Initial Regulatory Flexibility Analysis (IRFA). A copy of the Panel Report was included in the docket for this rule.

The agencies previously determined that the Phase 2 regulations could potentially have a significant economic impact on small entities. Specifically, the agencies identified four categories of directly regulated small businesses that could be impacted:

- Trailer Manufacturers
- Alternative Fuel Converters
- Vocational Chassis Manufacturers
- Glider Vehicle<sup>129</sup> Assemblers

<sup>129</sup> Vehicles produced by installing a used engine into a new chassis are commonly referred to as “gliders,” “glider kits,” or “glider vehicles.” See Section I.E.i and XIII.B.

To minimize these impacts the agencies are adopting certain regulatory flexibilities—both general and category-specific. In general, we are delaying new requirements for EPA GHG emission standards by one initial year and simplifying certification requirements for small businesses. Even with this one year delay, small businesses will be required to comply with EPA’s standards before NHTSA’s fuel efficiency standards are mandatory. Because of this timing, compliance with NHTSA’s regulations will not be delayed, as small business manufacturers will be accommodated through EPA’s initial one year delay. The agencies are also providing the following specific relief:

- *Trailers*: Adopting simpler requirements for non-box trailers, which are more likely to be manufactured by small businesses; reduced reliance on emission averaging; and making third-party testing easier for certification.

- *Alternative Fuel Converters*: Omitting recertification of a converted vehicle when the engine is converted and certified; reduced N<sub>2</sub>O testing; and simplified onboard diagnostics and delaying required compliance with each new standard by one model year.

- *Vocational Chassis*: Less stringent standards for certain vehicle categories; opportunity to generate credits under the Phase 1 program.

- *Glider Vehicle Assemblers*:<sup>130</sup> Exempting existing small businesses, but limiting the small business exemption to a capped level of annual production (production in excess of the capped amount will be allowed, but subject to all otherwise applicable requirements including the Phase 2 standards). Providing additional flexibility for newer engines.

These flexibilities are described in more detail in Section XIV, in RIA Section 12 and in the Panel Report. Flexibilities specific to glider vehicle assemblers are described in Section XIII.

#### (d) Confidentiality of Test Results and GEM Inputs

The agencies received mixed comments regarding the question of whether GEM inputs should be made available to public. Some commenters supported making this information available, while others thought it should

<sup>130</sup> EPA is amending its rules applicable to engines installed in glider kits, which will affect emission standards not only for GHGs but for criteria pollutants as well. EPA is also clarifying its requirements for certification and revising its definitions for glider kit and glider vehicle manufacturers. NHTSA is not including glider vehicles under its Phase 2 fuel consumption standards. See Section XIII.B.

be protected as confidential business information (CBI). In accordance with Federal statutes, EPA does not release information from certification applications (or other compliance reports) that we determine to be CBI under 40 CFR part 2. Consistent with section 114(c) of the CAA, EPA does not consider emission test results to be CBI after introduction into commerce of the certified engine or vehicle. (However, we have generally treated test results as protected before the introduction into commerce date). EPA has not yet made a final determination for Phase 1 or Phase 2 certification test results. Nevertheless, at this time we expect to continue this policy and consider it likely that we would not treat any test results or other GEM inputs as CBI after the introduction into commerce date as identified by the manufacturer.

With regard to NHTSA's treatment of confidential business information, manufacturers must submit a request for confidentiality with each electronic submission specifying any part of the information or data in a report that it believes should be withheld from public disclosure as trade secret or other confidential business information. A form is available through the NHTSA Web site to request confidentiality. NHTSA does not consider manufacturers to continue to have a business case for protecting pre-model report data after the vehicles contained within that report have been introduced into commerce.

#### (e) Delegated Assembly and Secondary Manufacturers

In EPA's existing regulations (40 CFR 1068.261), we allow engine manufacturers to sell or ship engines that are missing certain emission-related components if those components will be installed by the vehicle manufacturer. These provisions already apply to Phase 1 vehicles as well, providing a similar allowance for *vehicle* manufacturers to sell or ship *vehicles* that are missing certain emission-related components if those components will be installed by a *secondary* vehicle manufacturer. See section 1037.620. EPA has found this provision to work well and is finalizing certain amendments in this rule. See 40 CFR 1037.621. Under the amended rule, as conditions of this allowance, manufacturers will be required to:

- Have a contractual obligation with the secondary manufacturer to complete the assembly properly and provide instructions about how to do so
- Keep records to demonstrate compliance
- Apply a temporary label to the incomplete vehicles

- Take other reasonable steps to ensure the assembly is completed properly
- Describe in its application for certification how it will use this allowance

Under delegated assembly, it is the upstream manufacturer that holds the certificate and assumes primary responsibility for all compliance requirements. Our experience applying this approach has shown that holding the upstream manufacturer responsible ensures that they will exercise due diligence throughout the process.

EPA proposed to apply this new section broadly. However, commenters raised valid questions about whether it is necessary to apply this formal process as broadly as proposed. In response, we have reconsidered the proposed approach and have determined that it would be appropriate to allow a less formal process with components for which market forces will make it unlikely that a secondary manufacturer would not complete assembly properly. In those cases, the certifying manufacturers will be required to provide sufficiently detailed installation instructions to the secondary manufacturers, who would then be obligated to complete assembly properly before the vehicles are delivered to the ultimate purchasers.

One example of a case for which market forces could ensure that assembly is completed properly would be air conditioning leakage requirements. Purchasers will have the expectation that the systems will not leak, and a secondary manufacturer should have no incentive to not follow the certifying manufacturer's instructions.

As revised, § 1037.621 will require the formal delegated assembly process for the following technologies if they are part of the OEM's certified configuration but not shipped with the vehicle:

- Auxiliary power units
- Aerodynamic devices
- Hybrid components
- Natural gas fuel tanks

Certificate holders will remain responsible for other certified components, but will not automatically be required to comply with the formal delegated assembly requirements. That determination will be made case-by-case as part of the certification process. We are also explicitly making the flexibility in 40 CFR 1037.621 available for HD pickups and vans certified to the standards in 40 CFR part 86. As is currently specified in 40 CFR 1068.261, EPA will retain the authority to apply additional necessary conditions (at the time of certification) to the allowance to

delegate assembly of emission to secondary manufacturers (when emission control equipment is not shipped with the vehicle to the secondary manufacturer, as just noted). In particular, we would likely apply such additional conditions for manufacturers that we determine to have previously not completed assembly properly. Issues of delegated assembly are addressed in more detail in Section 1.4.4 of the RTC.

#### (f) Engine/Vehicle Useful Life

We received comment on what policies we should adopt to address the situation where the engine and the vehicle are subject to emission standards over different useful-life periods. For example, a medium heavy-duty engine may power vehicles in weight classes ranging from 2b to 8, with correspondingly different regulatory useful lives for those vehicles. As provided in 40 CFR 1037.140 of the final regulations, we have structured the vehicle regulations to generally apply the same useful life for the vehicle that applies for the engines. However, these regulations also allow vehicle manufacturers to certify their vehicles to longer useful lives. The agencies see no problem with allowing vehicles to have longer useful lives than the engines.

#### (g) Compliance Reports

The agencies received comment on the NPRM from two environmental organizations requesting that the agencies make available to the public data and information that would enable the public to track trends in technology sales over time, as well as track company-specific compliance data. The commenters suggested that this should include an agency publication of an annual compliance report for the Heavy-duty Phase 2 program. The commenters requested this information to allow all stakeholders to see how individual companies, as well as the industry overall, were performing relative to their compliance obligations (see comments from ACEEE and NRDC).

The agencies agree with this comment. In the context of the light-duty vehicle GHG standards, EPA has already published four annual compliance reports which has made available to the public detailed information regarding both how individual light-duty vehicle companies have been meeting their compliance obligations, as well as summary information at the light-duty fleet level. NHTSA makes the up-to-date information on the light-duty fuel economy program available through its

CAFE Public Information Center ([http://www.nhtsa.gov/CAFE\\_PIC/CAFE\\_PIC\\_Home.htm](http://www.nhtsa.gov/CAFE_PIC/CAFE_PIC_Home.htm)). Information includes manufacturer and overall fleet standards and CAFE performance, credit status, and civil penalty status. This information has been helpful to increase transparency to all stakeholders and to allow the public to see how companies are progressing from one year to the next with respect to their compliance requirements. It is EPA's intention to publish a similar annual compliance report for the heavy duty GHG program, covering both the existing Phase 1 program, as well as the Phase 2 standards contained in this final rule. It is NHTSA's intention to expand the Public Information Center to include the medium- and heavy-duty fuel efficiency program and to make up-to-date information collected in the heavy-duty fuel efficiency compliance process available publicly. Both the EPA and NHTSA compliance reports will provide available information at the vehicle subclass level for each of the four vehicle categories (*i.e.* Tractors, Trailers, Vocational, and Heavy-Duty Pickups and Vans), and EPA will provide available information for the other GHG standards, such as N<sub>2</sub>O and refrigerant leak detection standards. Prior to issuing the compliance reports, EPA and NHTSA will work with regulated manufacturers to reconcile concerns over the release of claimed confidential business information, consistent with 40 CFR part 2 and 49 CFR 512.

### (3) Life Cycle Emissions

The agencies received many comments expressing concerns about establishing the GHG and fuel consumption standards as tailpipe standards that do not account for upstream emissions or other life cycle impacts. However, many other commenters supported this approach. Comments specifically related to alternative fuels or electric vehicles are addressed in Section I.C.(1)(d) and in Section XI.B. This section addresses the issue more broadly.

As discussed below, the agencies do not see how we could accurately account for life cycle emissions in our vehicle standards, nor have commenters shown that such an accounting is needed. In addition, NHTSA has already noted that the fuel efficiency standards are necessarily tailpipe-based, and that a lifecycle approach would likely render it impossible to harmonize the fuel efficiency and GHG emission standards, to the great detriment of our goal of achieving a national, harmonized program. See 76 FR 57125.

It is also worth noting that EPA's engine and vehicle emission standards and NHTSA's vehicle fuel consumption standards (including those for light-duty vehicles) have been in place for decades as tailpipe standards. The agencies find no reasonable basis in the comments or elsewhere to change fundamentally from this longstanding approach.

Although the final standards do not account for life cycle emissions, the agencies have estimated the upstream emission impact of reducing fuel consumption for heavy-duty vehicles. As shown in Section VII and VIII, these upstream emission reductions are significant and worth estimating, even with some uncertainty. However, this analysis would not be a sufficient basis for inclusion in the standards themselves.

#### (a) Challenges for Addressing Life Cycle Emissions With Vehicle Standards

Commenters supporting accounting for life cycle emissions generally did so in the context of one or more specific technologies. However, the agencies cannot accurately address life-cycle emissions on a technology specific basis at this time for two reasons:

- We lack data to address each technology, and see no path to selectively apply a life cycle analysis to some technologies, but not to others.
- Actual life cycle emissions are dependent on factors outside the scope of the rulemaking that may change in the future.

With respect to the first reason, even if we were able to accurately and fully account for life cycle impacts of one technology (such as weight reduction), this would not allow us to address life cycle emissions for other technologies. For example, how would the agencies address potential differences in life cycle emissions for shifting from a manual transmission to and AMT, or the life cycle emissions of aerodynamic fairings? If we cannot factor in life cycle impacts for all technologies, how would we do it for weight reductions? Given the complexity of these rules and the number of different technologies involved, we see no way to treat the technologies equitably. Commenters do not provide the information necessary to address this challenge, nor are the agencies aware of such information.

The second reason is just as problematic. This rulemaking is setting standards for vehicles under specific statutory provisions. It is not regulating manufacturing processes, distribution practices, or the locations of manufacturing facilities. And yet each of these factors could impact life cycle emissions. So while we could take a

snapshot of life cycle emissions at this point in time for specific manufacturers, it may or may not have any relation to life cycle emissions in 2027, or for other manufacturers. Consider, for example, two component manufacturers: One that produces its components near the vehicle assembly plant, and relies on natural gas to power its factory; and a second that is located overseas and relies on coal-fired power. How would the agencies equitably (or even non-arbitrarily) factor in these differences without regulating these processes? To the extent commenters provided any information on life cycle impacts, they did not address this challenge.

#### (b) Need for Life Cycle Consideration in the Standards

The agencies acknowledge that a full and accurate accounting of life cycle emissions (if it were possible) could potentially make the Phase 2 program marginally better. However, we do not agree that this is an issue of fundamental importance. While some commenters submitted estimates of the importance of life cycle emissions for light-duty vehicles, life cycle emissions are less important for heavy-duty vehicles. Consider, for example, the difference between a passenger car and a heavy-duty tractor. If the passenger car achieves 40 mile per gallon and travels 150,000 miles in its life, it would consume less than 4,000 gallons of fuel in its life. On the other hand, a tractor that achieves 8 miles per gallon and travels 1,000,000 miles would consume 125,000 gallons of fuel in its life, or more than 30 times the fuel of the passenger car. Commenters provide no basis to assume the energy consumption associated with tractor production would be 30 times that of the production of a passenger car.

#### (4) Amendments to the Phase 1 Program

The agencies are revising some test procedures and compliance provisions used for Phase 1. These changes are described in Section XII. This includes both amendments specific to Phase 1, as well as amendments that apply more broadly than Phase 1, such as the revisions to the delegated assembly provisions. As a drafting matter, EPA notes that we are moving the GHG standards for Class 2b and 3 pickups and vans from 40 CFR 1037.104 to 40 CFR 86.1819-14.

NHTSA is also amending 49 CFR part 535 to make technical corrections to its Phase 1 program to better align with EPA's compliance approach, standards and CO<sub>2</sub> performance results. In general, these changes are intended to improve the regulatory experience for regulated

parties and also reduce agency administrative burden. More specifically, NHTSA is changing the rounding of its standards and performance values to have more significant digits. Increasing the number of significant digits for values used for compliance with NHTSA standards reduces differences in credits generated and overall credit balances for the EPA and NHTSA programs. NHTSA is also removing the petitioning process for off-road vehicles, clarifying requirements for the documentation needed for submitting innovative technology requests in accordance with 40 CFR 1037.610 and 49 CFR 535.7, and adding further detail to requirements for submitting credit allocation plans as specified in 49 CFR 535.9. Finally, NHTSA is adding the same recordkeeping requirements that EPA currently requires to facilitate in-use compliance inspections. These changes are intended to improve the regulatory experience for regulated parties and also reduce agency administrative burden.

The agencies received few comments on these changes, with most supporting the proposed changes or suggesting improvements. These comments as well as the few comments opposing any of these changes are discussed in Section XII and in the RTC.

#### (5) Other Amendments to EPA Regulations

EPA is finalizing certain other changes to regulations that we proposed, which are not directly related to the HD Phase 1 or Phase 2 programs, as detailed in Section XIII. For these amendments, there are no corresponding changes in NHTSA regulations. Some of these amendments relate directly to heavy-duty highway engines, but not to the GHG programs. Others relate to nonroad engines. This latter category reflects the regulatory structure EPA uses for its mobile source regulations, in which regulatory provisions applying broadly to different types of mobile sources are codified in common regulatory parts such as 40 CFR part 1068. This approach creates a broad regulatory structure that regulates highway and nonroad engines, vehicles, and equipment collectively in a common program. Thus, it is appropriate to include some amendments to nonroad regulations in addition to the changes applicable only for highway engines and vehicles.

Except as noted below, the agencies received relatively few significant comments on these issues. All comments are discussed in more detail in Section XIII and in the RTC. One area, for which we did receive

significant comment was the issue of competition vehicles. As described in Section XIII, EPA is not finalizing the proposed clarification related to highway vehicles used for competition.

#### (a) Standards for Engines Installed In Glider Kits

EPA regulations currently allow used pre-2013 engines to be installed into new glider kits without meeting currently applicable standards. As described in Section XIII.B, EPA is amending its regulations to allow only engines that have been certified to meet standards for the model year in which the glider vehicle is assembled (*i.e.* current model year engine standards) to be installed in new glider kits, with certain exceptions. First, engines certified to earlier MY standards that are identical to the current model year standards may be used. Second, engines still within their useful life (and certain similar engines) may be used. Note that this would not allow use of the pre-2002 engines that are currently being used in most glider vehicles because they all would be outside of the 10-year useful life period. Finally, the interim small manufacturer allowance for glider vehicles will also apply for the engines used in the exempted glider kits. Comments on this issue are summarized and addressed in Section XIII.B and in RTC Section 14.2.

#### (b) Nonconformance Penalty Process Changes

Nonconformance penalties (NCPs) are monetary penalties established by regulation that allow a vehicle or engine manufacturer to sell engines that do not meet the emission standards. Manufacturers unable to comply with the applicable standard pay penalties, which are assessed on a per-engine basis.

On September 5, 2012, EPA adopted final NCPs for heavy heavy-duty diesel engines that could be used by manufacturers of heavy-duty diesel engines unable to meet the current oxides of nitrogen (NO<sub>x</sub>) emission standard. On December 11, 2013 the U.S. Court of Appeals for the District of Columbia Circuit issued an opinion vacating that Final Rule. It issued its mandate for this decision on April 16, 2014, ending the availability of the NCPs for the current NO<sub>x</sub> standard, as well as vacating certain amendments to the NCP regulations due to concerns about inadequate notice. In particular, the amendments revise the text explaining how EPA determines when NCP should be made available. In the Phase 2 NPRM, EPA re-proposed most of these amendments to provide fuller

notice and additional opportunity for public comment. As discussed in Section XIII, although EPA received one comment opposing these amendments, they are being finalized as proposed.

#### (c) Updates to Heavy-Duty Engine Manufacturer In-Use Testing Requirements

EPA and manufacturers have gained substantial experience with in-use testing over the last four or five years. This has led to important insights in ways that the test protocol can be adjusted to be more effective. We are accordingly making changes to the regulations in 40 CFR part 86, subparts N and T.

#### (d) Extension of Certain 40 CFR Part 1068 Provisions to Highway Vehicles and Engines

As part of the Phase 1 GHG standards, we applied the exemption and importation provisions from 40 CFR part 1068, subparts C and D, to heavy-duty highway engines and vehicles. We also specified that the defect reporting provisions of 40 CFR 1068.501 were optional. In an earlier rulemaking, we applied the selective enforcement auditing under 40 CFR part 1068, subpart E (75 FR 22896, April 30, 2010). We are adopting the rest of 40 CFR part 1068 for heavy-duty highway engines and vehicles, with certain exceptions and special provisions.

As described above, we are applying all the general compliance provisions of 40 CFR part 1068 to heavy-duty engines and vehicles subject to 40 CFR parts 1036 and 1037. We are also applying the recall provisions and the hearing procedures from 40 CFR part 1068 for highway motorcycles and for all vehicles subject to standards under 40 CFR part 86, subpart S.

EPA is updating and consolidating the regulations related to formal and informal hearings in 40 CFR part 1068, subpart G. This will allow us to rely on a single set of regulations for all the different categories of vehicles, engines, and equipment that are subject to emission standards. We also made an effort to write these regulations for improved readability.

We are also making a number of changes to part 1068 to correct errors, to add clarification, and to make adjustments based on lessons learned from implementing these regulatory provisions.

#### (e) Amendments to Engine and Vehicle Test Procedures in 40 CFR Parts 1065 and 1066

EPA is making several changes to our engine testing procedures specified in

40 CFR part 1065. None of these changes will significantly impact the stringency of any standards.

(f) Amendments Related to Marine Diesel Engines in 40 CFR Parts 1042 and 1043

EPA's emission standards and certification requirements for marine diesel engines under the Clean Air Act and the act to Prevent Pollution from Ships are identified in 40 CFR parts 1042 and 1043, respectively. EPA is amending these regulations with respect to continuous NO<sub>x</sub> monitoring and auxiliary engines, as well as making several other minor revisions.

(g) Amendments Related to Locomotives in 40 CFR Part 1033

EPA's emission standards and certification requirements for locomotives under the Clean Air Act are identified in 40 CFR part 1033. EPA is making several minor revisions to these regulations.

(6) Other Amendments to NHTSA Regulations

NHTSA proposed to amend 49 CFR parts 512 and 537 to allow manufacturers to submit required compliance data for the Corporate Average Fuel Economy (CAFE) program electronically, rather than submitting some reports to NHTSA via paper and CDs and some reports to EPA through its VERIFY database system. NHTSA is not finalizing this proposal in this rulemaking and will consider electronic submission for CAFE reports in a future action.

## II. Vehicle Simulation and Separate Engine Standards for Tractors and Vocational Chassis

### A. Introduction

This Section II. describes two regulatory program elements that are *common* among tractors and vocational chassis. In contrast, Sections III and V respectively describe the regulatory program elements that are *unique* to tractors and to vocational chassis. The common elements described here are the vehicle simulation approach to vehicle certification and the separate standards for engines. Section II.B discusses the reasons for this Phase 2 regulatory approach; namely, requiring vehicle simulation for tractor and vocational chassis certification, maintaining separate engine standards, and expanding and updating their related mandatory and optional test procedures. Section II.C discusses in detail the evolution and final version of the vehicle simulation computer program, which is called the

Greenhouse gas Emissions Model or "GEM." Section II.C also discusses the evolution and final versions of the test procedures for determining the GEM inputs that are common for tractors and vocational chassis. Section II.D discusses in detail the separate engine standards for GHGs and fuel efficiency and their requisite test procedures.

In this final action, the agencies have built on the success of the Phase 1 GEM-based approach for the certification of tractors and vocational chassis. To better recognize the real-world impact of vehicle technologies, we have expanded the number of required and optional vehicle inputs into GEM. Inputting these additional details into GEM results in more accurate representations of vehicle performance and greater opportunities to demonstrate reductions in CO<sub>2</sub> emissions and fuel consumption. We are also finalizing revisions to the vehicle driving patterns that are programmed into GEM to better reflect real-world vehicle operation and the emissions reductions that result from applying GHG and fuel efficiency technologies to vehicles. As a result of these revisions, the final GEM-based vehicle certification approach necessitates new testing of engines and testing of some other vehicle components to generate the additional GEM inputs for Phase 2. More detail is provided in Section II.C.

Based on our assessments of the technological feasibility; cost effectiveness; requisite lead times for implementing new and additional tractor and vocational vehicle technologies; and based on comments we received in response to our notice of proposed rulemaking and in response to our more recent notice of additional data availability, the agencies are finalizing steadily increasing stringencies of the CO<sub>2</sub> and fuel consumption standards for tractors and vocational chassis for vehicle model years 2021, 2024 and 2027. See Section I or Sections III and V respectively for these numerical standards for tractors and vocational chassis. As part of our analytical process for determining the numerical values of these standards, the agencies utilized GEM. Using GEM as an integral part of our own standard-setting process helps ensure consistency between our technology assessments and the GEM-based certification process that we require for compliance with the Phase 2 standards. Our utilization of GEM in our standard-setting process is described further in Section II.C.

For Phase 2 we are finalizing, as proposed, the same Phase 1 certification approach for all of the GHG and fuel efficiency separate engine standards for

those engines installed in tractors and vocational chassis. For the separate engine standards, we will continue to require the Phase 1 engine dynamometer certification test procedures, which were adopted substantially from EPA's existing heavy-duty engine emissions test procedures. In this action we are finalizing, as proposed, revisions to the weighting factors of the tractor engine 13-mode steady-state test cycle (*i.e.*, the Supplemental Engine Test cycle or "SET"). The SET is required for determining tractor engine CO<sub>2</sub> emissions and fuel consumption. Consistent with the rationale we presented in our proposal and consistent with comments we received, these revised SET weighting factors better reflect the lower engine speed operation of modern engines, which frequently occurs at tractor cruise speeds. We used these revised weighting factors as part of our engine technology assessments of both current engine technology (*i.e.*, our "baseline engine" technology) and future engine technology.

Based on our assessments of the technological feasibility; cost effectiveness; requisite lead times for implementing new and additional engine technologies; and based on comments we received in response to our notice of proposed rulemaking and in response to our more recent notice of additional data availability, the agencies are finalizing steadily increasing stringencies of the CO<sub>2</sub> and fuel consumption separate engine standards for engine model years 2021, 2024 and 2027. In addition, for each of these model years, EPA is maintaining the Phase 1 separate engine standards for CH<sub>4</sub> and N<sub>2</sub>O emissions—both at their Phase 1 numeric values. While EPA is not finalizing at this time more stringent N<sub>2</sub>O emissions standards, as originally proposed, EPA may soon revisit these separate engine N<sub>2</sub>O standards in a future rulemaking. All of the final Phase 2 separate engine standards are presented in Section II.D, along with our related assessments.

### B. Phase 2 Regulatory Structure

As proposed, in this final action the agencies have built on the success of the Phase 1 GEM-based approach for the certification of tractors and vocational chassis, while also maintaining the Phase 1 separate engine standards approach to engine certification. While the regulatory structures of both Phase 1 and Phase 2 are quite similar, there are a number of new elements for Phase 2. Note that we are not applying these new

Phase 2 elements for compliance with the Phase 1 standards.

These modifications for Phase 2 are consistent with the agencies' Phase 1 commitments to consider a range of regulatory approaches during the development of future regulatory efforts (76 FR 57133), especially for vehicles not already subject to full vehicle chassis dynamometer testing. For example, we committed to consider a more sophisticated approach to vehicle testing to more completely capture the complex interactions within the total vehicle, including the engine and powertrain performance. We also committed to consider the potential for full vehicle certification of complete tractors and vocational chassis using a chassis dynamometer test procedure. We also considered chassis dynamometer testing of complete tractors and vocational chassis as a complementary approach for validating a more complex vehicle simulation approach. We committed to consider the potential for a regulatory program for some of the trailers hauled by tractors. After considering these various approaches, the agencies proposed a structure in which regulated tractor and vocational chassis manufacturers would additionally enter engine and powertrain-related inputs into GEM, which was not part of in Phase 1.

The basic structure in the proposal was widely supported by commenters, although some commenters supported changing certain aspects. Some commenters suggested revising GEM to recognize additional technologies, such as tire pressure monitoring systems and electronic controls that decrease fuel consumption while a vehicle is coasting. To the extent that the agencies were able to collect and receive sufficient data to support such revisions in GEM, these changes were made. See Section II.C. for details. For determining certain GEM inputs, some commenters suggested more cost-effective test procedures for separate engine and transmission testing, compared to the engine-plus-transmission powertrain test procedure that the agencies proposed. In collaboration with researchers at engine manufacturer test

laboratories, at Oak Ridge National Laboratory and at Southwest Research Institute, the agencies completed a number of laboratory evaluations of these suggested test procedures.<sup>131</sup> Based on these results, which were made available to the public for a 30-day comment period in the NODA, the agencies are finalizing these more cost-effective test procedures as options, in addition to the powertrain test procedure we proposed. We note that we are also finalizing some of these more cost-effective test procedures, the cycle average approach for all vehicle cycles, as optional for the testing of "pre-transmission" hybrids. In response to our request for comment, some commenters expressed support for a so-called, "cycle-average" approach for generating engine map data for input into GEM. This approach facilitates an accurate recognition of an engine's transient performance. The agencies further refined this approach, and we made detailed information on this approach available in the NODA.<sup>132</sup> Based on comments, we are finalizing this approach as mandatory for mapping engines over GEM's transient cycle, and we are allowing this approach as optional for GEM's 55 mph and 65 mph cycles.

Some commenters expressed concern about GEM and our proposed tractor standards appropriately accounting for the performance of powertrain technologies installed in some of the largest specialty tractors. We have addressed this concern by finalizing a new "heavy-haul" tractor sub-category, with a unique payload and vehicle masses in GEM, which result in a unique set of numeric standards for these vehicles. This is explained in detail in Section III.D. Other commenters expressed concern about the greater complexity of GEM's additional inputs and the appropriateness of our proposed

<sup>131</sup> Oak Ridge National Laboratory results docketed for the NODA: EPA-HQ-OAR-2014-0827-1622 and NHTSA-2014-0132-0183. Southwest Research Institute results docketed for the NODA: EPA-HQ-OAR-2014-0827-1619 and NHTSA-2014-0132-0184.

<sup>132</sup> *Ibid.*

vocational chassis standards, as applied to certain custom-built vocational chassis. We have addressed these concerns by finalizing a limited number of optional custom chassis standards, tailored according to a vocational chassis' final application (e.g., school bus, refuse truck, cement mixer, etc.). To address the concerns about GEM's complexity for these specialty vehicles, these optional custom chassis standards require a smaller number of GEM inputs. This is explained in detail in Section V.D.

Some vehicle manufacturers did not support the agencies finalizing separate engine standards. However, as described below, the agencies continue to believe that separate engine standards are necessary and appropriate. Thus, the agencies are finalizing the basic rule structure that was proposed, but with a number of refinements.

For trailer manufacturers, which will be subject to first-time standards under Phase 2, we will apply the standards using a GEM-based certification, but to do so without actually running GEM. More specifically, based on the agencies' analysis of the results of running GEM many times and varying GEM's trailer configurations, the agencies have developed a simple equation that replicates GEM results, based on inputting certain trailer values into the equation. Use of the equation, rather than full GEM, should significantly facilitate trailer certification. As described in Chapter 2.10.5 of the RIA, the equation has a nearly perfect correlation with GEM, so that they can be used instead of GEM, without impacting stringency. This is a result of the relative simplicity of the trailer inputs as compared to the tractor and vocational vehicle inputs.

#### (1) Other Structures Considered

To follow-up on the commitment to consider other approaches, the agencies spent significant time and resources before the proposal in evaluating six different options for demonstrating compliance with the proposed Phase 2 standards as shown in Figure II.1

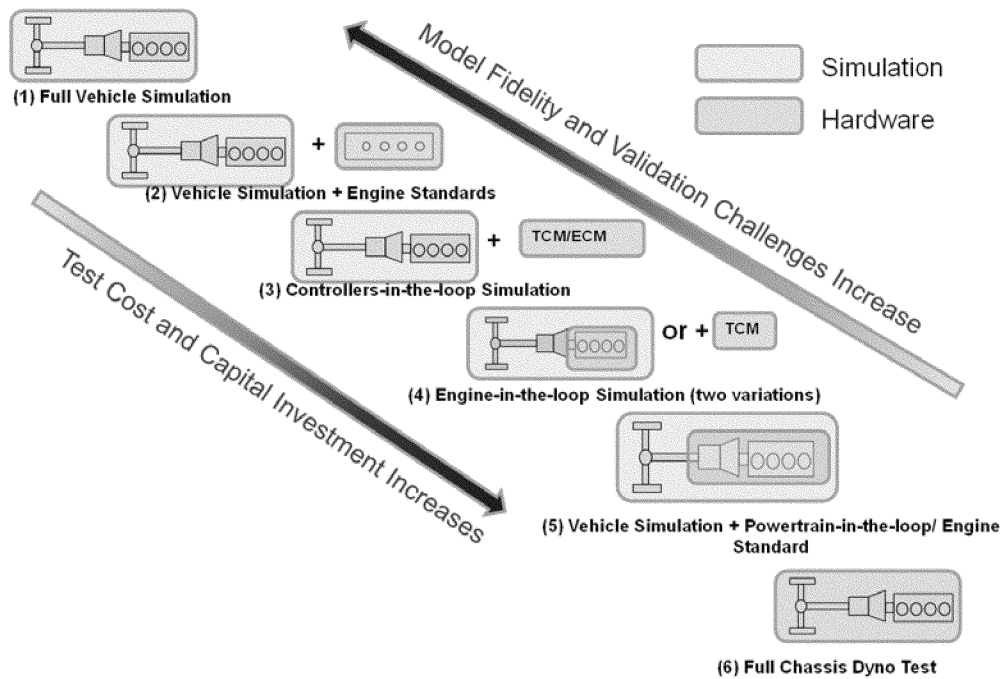

**Figure II.1 Six Certification Options**

As shown in Figure II.1 these six options include:

1. Full vehicle simulation, where vehicle inputs are entered into simulation software.

2. Vehicle simulation, supplemented with separate engine standards.

3. Controllers-in-the-loop simulation, where an actual electronic transmission controller module (TCM) and an actual engine controller module (ECM) are tested in hardware.

4. Engine-in-the-loop simulation, with or without a TCM, where at least the engine is tested in hardware.

5. Vehicle simulation with powertrain-in-the-loop, where the engine and transmission are tested in hardware. One variation involves an engine standard.

6. Full vehicle chassis dynamometer testing.

The agencies evaluated these options in terms of the capital investment required of regulated manufacturers to conduct the testing and/or simulation, the cost per test, the accuracy of the simulation, and the challenges of validating the results. Other considerations included the representativeness compared to the real world behavior, maintaining existing Phase 1 certification approaches that are known to work well, enhancing the Phase 1 approaches that could use improvements, the alignment of test procedures for determining GHG and

non-GHG emissions compliance, and the potential to circumvent the intent of the test procedures. The agencies presented our evaluations in the proposal, and we received comments on some of these approaches, and these comments were considered carefully in our evaluations for this final action. Notably, in this final action we are adopting a combination of these options, where some are mandatory and others are optional for certification via GEM. We have concluded that this combination of these options strikes an optimal balance between their costs, accuracy with respect to real-world performance, and robustness for ensuring compliance. In this section we present our evaluation and rationale for finalizing these Phase 2 certification approaches.

Chassis dynamometer testing (Option 6) is used extensively in the development and certification of light-duty vehicles. It also is used in Phase 1 to certify complete Class 2b/3 pickups and vans, as well as to certify certain incomplete vehicles (at the manufacturer's option). The agencies considered chassis dynamometer testing more broadly as a heavy-duty fuel efficiency and GHG certification option because chassis dynamometer testing has the ability to evaluate a vehicle's performance in a manner that most closely resembles the vehicle's in-use performance. Nearly all of the fuel

efficiency technologies can be evaluated simultaneously on a chassis dynamometer, including the vehicle systems' interactions that depend on the behavior of the engine, transmission, and other vehicle electronic controllers. One challenge associated with the application of wide-spread heavy-duty chassis testing is the small number of heavy-duty chassis test sites that are available in North America. As discussed in RIA Chapter 3, the agencies were only able to locate 11 heavy-duty chassis test sites. However, more recently we have seen an increased interest in building new sites since issuing the Phase 1 Final Rule. For example, EPA is currently building a heavy-duty chassis dynamometer with the ability to test up to 80,000 pound vehicles at the National Vehicle and Fuel Emissions Laboratory in Ann Arbor, Michigan.

Nevertheless, the agencies continue to be concerned about requiring a chassis test procedure for certifying tractors or vocational chassis due to the initial cost of a new test facility and the large number of heavy duty tractor and vocational chassis variants that could require testing. We have also concluded that for heavy-duty tractors and vocational chassis, there can be increased test-to-test variability under chassis dynamometer test conditions, versus other approaches. First, the agencies recognize that such testing



requires expensive, specialized equipment that is not widely available. The agencies estimate that it would vary from about \$1.3 to \$4.0 million per new test site depending on existing facilities.<sup>133</sup> In addition, the large number of heavy-duty vehicle configurations would require significant amounts of testing to cover the sector. For example, for Phase 1 tractor manufacturers typically certified several thousand variants of one single tractor model. Finally, EPA's evaluation of heavy-duty chassis dynamometer testing has shown that the variation of chassis test results is greater than light-duty testing, up to 3 percent worse, based on our sponsored testing at Southwest Research Institute.<sup>134</sup> The agencies' research identified a number of unique sources of test-to-test variability in HD chassis dynamometer testing versus other types of testing (described next). These unique sources include variations in HD tire performance and tire temperature and pressure stability; variations in human driver performance; and variations in the test facilities' heating, ventilation and air conditioning system affecting emissions after-treatment performance (e.g., increased fuel consumption to maintain after-treatment temperature) and engine accessory power (e.g., engine fan clutching). Although the agencies are not requiring chassis dynamometer certification of tractors and vocational chassis, we believe such an approach could potentially be appropriate in the future for some heavy duty vehicles if more test facilities become available and if the agencies are able to address the large number of vehicle variants that might require testing and the unique sources of test-to-test variability. Note, as discussed in Section II.C.(4) we are finalizing a manufacturer-run complete tractor heavy-duty chassis dynamometer test program for monitoring relative trends fuel efficiency and for comparing those trends to the trends indicated via GEM simulation. While the agencies did not receive significant comment on the appropriateness of full vehicle heavy-duty chassis dynamometer testing for certification, the agencies did receive significant, mostly negative, comment on the costs versus benefits of a manufacturer-run complete tractor heavy-duty chassis dynamometer test program for data collection. These comments and our responses are detailed in Section II.C.(4).

<sup>133</sup> 03–19034 TASK 2 Report-Paper 03-Class8\_hil DRAFT, September 30, 2013.

<sup>134</sup> GEM Validation, Technical Research Workshop, San Antonio, December 10–11, 2014.

Another option considered for certification involves testing a vehicle's powertrain in a modified engine dynamometer test facility, which is part of option 5 shown in Figure II.1. In this case the engine and transmission are installed together in a laboratory test facility, and a dynamometer is connected to the output shaft of the transmission. GEM or an equivalent vehicle simulation computer program is then used to control the dynamometer to simulate vehicle speeds and loads. The step-by-step test procedure considered for this option was initially developed as an option for hybrid powertrain testing for Phase 1. We are not finalizing this approach as mandatory, but we are allowing this as an option for manufacturers to generate powertrain inputs for use in GEM. For Phase 2 we generally require this test procedure for evaluating hybrid powertrains for inputs into GEM, but there are certain exceptions where engine-only test procedures may be used to certify hybrids via GEM (e.g., pre-transmission hybrids).

A key advantage of the powertrain test approach is that it directly measures the effectiveness of the engine, the transmission, and the integration of these two components. Engines and transmissions are particularly challenging to simulate within a computer program like GEM because the engines and transmissions installed in vehicles today are actively and interactively controlled by their own sophisticated electronic controls; namely the ECM and TCM.

We believe that the capital investment impact on manufacturers for powertrain testing is reasonable; especially for those who already have heavy-duty engine dynamometer test facilities. We have found that, in general, medium-duty powertrains can be tested in heavy-duty engine test cells. EPA has successfully completed such a test facility conversion at the National Vehicle and Fuel Emissions Laboratory in Ann Arbor, Michigan. Southwest Research Institute (SwRI) in San Antonio, Texas has completed a similar test cell conversion. Oak Ridge National Laboratory in Oak Ridge, Tennessee has been operating a recently constructed heavy heavy-duty powertrain dynamometer facility, and EPA currently has an interagency agreement with DOE to fund EPA powertrain testing at ORNL. The results from this testing were published for a 30-day comment period, as part of the NODA.<sup>135</sup> Eaton Corporation has been

<sup>135</sup> Oak Ridge National Laboratory results docketed for the NODA: EPA–HQ–OAR–2014–

operating a heavy-duty powertrain test cell and has provided the agencies with valuable test results and other comments.<sup>136</sup> PACCAR recently constructed and began operation of a powertrain test cell that includes engine, transmission and axle test capabilities.<sup>137</sup> EPA also contracted SwRI to evaluate North America's capabilities (as of 2014) for powertrain testing in the heavy-duty sector and the cost of installing a new powertrain cell that meets agency requirements.<sup>138</sup> Results from this 2014 survey indicated that one supplier (Eaton) already had this capability. We estimate that the upgrade costs to an existing engine test facility are on the order of \$1.2 million, and a new test facility in an existing building are on the order of \$1.9 million. We also estimate that current powertrain test cells that could be upgraded to measure CO<sub>2</sub> emissions would cost approximately \$600,000. For manufacturers or suppliers wishing to contract out such testing, SwRI estimated that a cost of \$150,000 would provide about one month of powertrain testing services. Once a powertrain test cell is fully operational, we estimate that for a nominal powertrain family (i.e. one engine family tested with one transmission family), the cost for powertrain installation, testing, and data analysis would be about \$70,000 in calendar year 2016, in 2016 dollars. Since the NPRM in July 2015, the agencies and other stakeholders have completed significant new work toward refining the powertrain test procedure itself, and these results confirm the robustness of this approach. The agencies regulations provide details of the final powertrain test procedure. See 40 CFR 1037.550.

Furthermore, the agencies have worked with key transmission suppliers to develop an approach to define transmission families. Coupled with the agencies' existing definitions of engine families (40 CFR 1036.230 and 1037.230), we are finalizing powertrain family definitions in 40 CFR 1037.231 and axle and transmission families in 40 CFR 1037.232.

Even though there is conclusive evidence that powertrain testing is a

0827–1622 and NHTSA–2014–0132–0183. Southwest Research Institute results docketed for the NODA: EPA–HQ–OAR–2014–0827–1619 and NHTSA–2014–0132–0184.

<sup>136</sup> Eaton, Greenhouse gas emissions and fuel efficiency standards for medium- and heavy-duty engines and vehicles—Phase 2, 80 FED. REG. 40,137—Docket ID NOS. EPA–HQ–OAR–2014–0827, October 1, 2015.

<sup>137</sup> <https://engines.paccar.com/technology/research-development/>.

<sup>138</sup> 03–19034 TASK 2 Report-Paper 03-Class8\_hil DRAFT, September 30, 2013.



technically robust and cost-effective approach to evaluating the CO<sub>2</sub> and fuel consumption performance of powertrains, and even though there has been a clear trend toward manufacturers and other test laboratories recognizing the benefits and investing in new powertrain testing facilities, the agencies also received significant negative comment regarding the sheer amount of powertrain testing that could be required to certify the large number of unique configurations (*i.e.*, unique combinations of engines and transmissions). While the agencies proposed to allow manufacturers to group powertrains in powertrain families, as defined by the EPA in 40 CFR 1037.231, requiring powertrain testing broadly would still likely require a large number of tests. To address these concerns, while at the same time achieving most of the advantages of powertrain testing, the agencies are also finalizing some mandatory and optional test procedures to separately evaluate engine transient performance (via the mandatory “cycle-average” approach for the transient cycle) and transmission efficiency performance. While neither of these test procedures capture the optimized shift logic and other benefits of deep integration of the engine and transmission controllers, which only powertrain testing can capture, these separate test procedures do capture the remaining benefits of powertrain testing. The advantage of these separate tests is that their results can be mixed and matched within GEM to represent many more combinations of engines and transmissions than a comparable number of powertrain tests. For example, separately testing three parent engines that each have two child ratings and separately efficiency testing three transmissions that each have three major calibrations requires the equivalent test time of testing 6 powertrains, but without requiring the use of a powertrain test facility. More importantly, the results of these 6 tests can be combined within GEM to certify at least 27 different powertrain families, which would otherwise have required 27 powertrain tests—more than a four-fold increase in costs. This example clearly shows how cost-effective a vehicle simulation approach to vehicle certification can be.

Another regulatory structure option considered by the agencies was engine-only testing over the GEM duty cycles over a range of simulated vehicle configurations, which is part of Option 4 in Figure II.1. This is essentially a “cycle-average approach,” which would use GEM to generate engine duty cycles

by simulating a range of transmissions and other vehicle variations. These engine-level duty cycles would then be programmed into a separate controller of a dynamometer connected to an engine’s output shaft. The agencies requested comment on this approach, and based on continued research that has been conducted since the proposal, and based on comments we received in response to the NODA, we are finalizing this approach as mandatory for determining the GEM inputs that characterize an engine’s transient engine performance within GEM over the ARB Transient duty cycle. We are also finalizing this approach as optional for characterizing the more steady-state engine operation in GEM over the 55 mph and 65 mph duty cycles with road grade, in lieu of steady-state engine mapping for these two cycles. We are also finalizing this approach as an option for certifying pre-transmission hybrids, in lieu of powertrain testing. We are calling this approach the “cycle-average” approach, which generates a cycle-average engine fuel map that is input into GEM. This map simulates an engine family’s performance over a given vehicle drive cycle, for the full range of vehicles into which that engine could be installed. Unlike the chassis dynamometer or powertrain dynamometer approaches, which could have significant test facility construction or modification costs, this engine-only approach necessitates little capital investment because engine manufacturers already have engine test facilities to both develop engines and to certify engines to meet both EPA’s non-GHG standards and the agencies’ Phase 1 fuel efficiency and GHG separate engine standards. This option has received significant attention since our notice of proposed rulemaking. EPA and others have published peer reviewed journal articles demonstrating the efficacy of this approach.<sup>139 140</sup> and the agencies have received significant comments on both the information we presented in the proposal and in the NODA. Comments have been predominantly supportive, and the comments we received tended to focus on ideas for further minor refinements of this test procedure.<sup>136 141 142 143 144 145</sup>

<sup>139</sup> H. Zhang, J. Sanchez, M. Spears, “Alternative Heavy-duty Engine Test Procedure for Full Vehicle Certification,” *SAE Int. J. Commer. Veh.* 8(2): 2015, doi:10.4271/2015-01-2768.

<sup>140</sup> G. Salemm, E.D., D. Kieffer, M. Howenstein, M. Hunkler, and M. Narula, *An Engine and Powertrain Mapping Approach for Simulation of Vehicle CO<sub>2</sub> Emissions*. SAE Int. J. Commer. Veh. October 2015. 8: p. 440–450.

<sup>141</sup> Cummins, Inc., Comments in Response to Greenhouse Gas Emissions and Fuel Efficiency Standards for Medium- and Heavy-Duty Engines

At this time the agencies believe that the wealth of experimental data supporting the robustness and cost-effectiveness of the cycle-average approach, supports the agencies’ decision to finalize this test procedure as mandatory for the determination of the transient performance of engines for use in GEM (*i.e.*, over the ARB Transient Cycle).

The agencies also considered simulating the engine, transmission, and vehicle using a computer program; while having the actual transmission electronic controller connected to the computer running the vehicle simulation program, which is part of Option 3 in Figure II.1. The output of the simulation would be an engine cycle that would be used to test the engine in an engine test facility. Just as in the cycle-average approach, this procedure would not require significant capital investment in new test facilities. An additional benefit of this approach would be that the actual transmission controller would be determining the transmission gear shift points during the test, without a transmission manufacturer having to reveal their proprietary transmission control logic. This approach comes with some significant technical challenges, however. The computer model would have to become more complex and tailored to each new transmission and controller to make sure that the controller would operate properly when it is connected to a computer instead of an actual transmission. Some examples of the transmission specific requirements would be simulating all the Controller Area Network (CAN) communication to and from the transmission controller and the specific sensor responses both through simulation and hardware. Each vehicle manufacturer would have to be

and Vehicles—Phase 2 (Docket ID No. EPA-HQ-OAR-2014-0827 and Docket ID No. NHTSA-2014-0132).

<sup>142</sup> Paccar, Inc., Greenhouse Gas Emissions and Fuel Efficiency Standards for Medium- and Heavy-Duty Engines and Vehicles; Phase 2; Proposed Rule, 80 FR 40138 (July 13, 2015); Docket I.D. No.: EPA-HQ-OAR-2014-0827 and NHTSA-2014-0132.

<sup>143</sup> Daimler Trucks North America LLC, Detroit Diesel Corporation, And Mercedes-Benz USA, Greenhouse Gas Emissions and Fuel Efficiency Standards for Medium- and Heavy-Duty Engines and Vehicles, Phase 2, Proposed Rule, Docket ID No: EPA-HQ-OAR-2014-0827 and NHTSA-2014-0132; 80 FR 40137 (July 13, 2015).

<sup>144</sup> Volvo Group, Greenhouse Gas Emissions and Fuel Efficiency Standards for Medium- and Heavy-Duty Engines and Vehicles, Phase 2, Proposed Rule, Dockets ID No: EPA-HQ-OAR-2014-0827 and NHTSA-2014-0132; 80 FR 40137 (July 13, 2015).

<sup>145</sup> Navistar, Greenhouse Gas Emissions and Fuel Efficiency Standards for Medium- and Heavy-Duty Engines and Vehicles, Phase 2, Proposed Rule, Dockets ID No: EPA-HQ-OAR-2014-0827 and NHTSA-2014-0132; 80 FR 40137 (July 13, 2015).

responsible for connecting the transmission controller to the computer, which would require a detailed verification process to ensure it is operating properly while it is in fact disconnected from a real transmission. Determining full compliance with this test procedure would be a significant challenge for the regulatory agencies because the agencies would have to be able to replicate each of the manufacturer's unique interfaces between the transmission controller and computer running GEM. The agencies did not receive any significant comments on this approach, presumably because commenters focused on the more viable options of powertrain testing and the cycle-average engine mapping approach. And because of the significant challenges noted above, the agencies did not pursue this option further between the time of proposal and this final action. However, should this approach receive more research attention in the future, such that the concerns noted above are sufficiently addressed, the agencies could consider allowing this certification approach as an option, within the context of a separate future rulemaking.

Finally, the agencies considered full vehicle simulation plus separate engine standards (Option 2 in Figure II.1), which is the required approach being finalized for Phase 2. This approach is discussed in more detail in the following sections. It should be noted before concluding this subsection that the agencies do provide a regulatory path for manufacturers to apply for approval of alternative test methods that are different than those the agencies specify. See 40 CFR part 1065, subpart A. Therefore, even though we have not finalized some of the certification approaches and test procedures that we investigated, our conclusions about these procedures do not prevent a manufacturer from seeking agency approval of any of these procedures or any other alternative procedures.

## (2) Final Phase 2 Regulatory Structure

Under the final Phase 2 structure, tractor and vocational chassis manufacturers will be required to provide engine, transmission, drive axle(s) and tire inputs into GEM (as well as the inputs already required under Phase 1). For Phase 1, GEM used fixed default values for all of these, which limited the types of technologies that could be recognized by GEM to show compliance with the standards. We are expanding GEM to account for a wider range of technological improvements that would otherwise need to be recognized through the more

cumbersome off-cycle crediting approach in Phase 1. Additional technologies that will now be recognized in GEM also include lightweight thermoplastic materials, automatic tire inflation systems, tire pressure monitoring systems, advanced cruise control systems, electronic vehicle coasting controls, engine stop-start idle reduction systems, automatic engine shutdown systems, hybrids, and axle configurations that decrease the number of drive axles. The agencies are also continuing separate engine standards. As described below, we see advantages to having both engine-based and vehicle-based standards. Moreover, the advantages described here for full vehicle simulation do not necessarily correspond to disadvantages for engine testing or vice versa.

### (a) Advantages of Vehicle Simulation

The agencies' primary purpose in developing fuel efficiency and GHG emissions standards is to increase the use of vehicle technologies that improve fuel efficiency and decrease GHG emissions. Under the Phase 1 tractor and vocational chassis standards, there is no *regulatory* incentive for vehicle manufacturers to consider adopting new engine, transmission or axle technologies because GEM was not configured to recognize these technologies uniquely, leaving off-cycle credits as the only regulatory mechanism to recognize these technologies' benefits. By recognizing such technologies in GEM under Phase 2, the agencies will be creating a direct regulatory incentive to improve engine, transmission, and axle technologies to improve fuel efficiency and decrease GHG emissions. In its 2014 report, NAS also recognized the benefits of full vehicle simulation and recommended that the Phase 2 rules incorporate such an approach.<sup>160</sup>

The new Phase 2 approach will create three new specific regulatory incentives. First, vehicle manufacturers will have an incentive to use the most efficient engines. Since GEM will no longer use the agency default engine in simulation, manufacturers will have their own engines recognized in GEM. Under Phase 1, engine manufacturers have a regulatory incentive to design efficient engines, but vehicle manufacturers do not have a similar regulatory incentive to use the most efficient engines in their vehicles. Second, the new Phase 2 approach will create incentives for both engine and vehicle manufacturers to design engines and vehicles to work together to ensure that engines actually operate as much as possible near their most efficient points. This is because

Phase 2 GEM will require the vehicle manufacturers to input specific transmission, axle, and tire characteristics, thus recognizing powertrain optimization, such as engine down-speeding, and different transmission architectures and technologies, such as automated manual transmissions, automatic transmissions, and different numbers of transmission gears, transmission gear ratios, axle ratios and tire revolutions per mile. No matter how well designed, all engines have speed and load operation points with differing fuel efficiency and GHG emissions. The speed and load point with the best fuel efficiency (*i.e.*, peak thermal efficiency) is commonly known as the engine's "sweet spot." The more frequently an engine operates near its sweet spot, the better the vehicle's fuel efficiency will be. In Phase 1, a vehicle manufacturer receives no regulatory credit under GEM for designing its vehicle to operate closer to its engine's sweet spot because Phase 1 GEM does not model the specific engine, transmission, axle, or tire revolutions per mile of the vehicle. Third, this approach will recognize improvements to the overall efficiency of the drivetrain, including the axle. The new version of GEM will recognize the benefits of different integrated axle technologies including axle lubricants (via an optional axle efficiency test), and technologies that reduce axle losses such as by enabling three-axle vehicles to deliver power to only one rear axle. This is accomplished through the simulation of axle disconnect technology (see Chapter 4.5 of the RIA). The new version of GEM also will be able to recognize the benefits of reducing energy losses within a transmission, via an optional transmission efficiency test.

In addition to providing regulatory incentives to use more fuel efficient technologies, expanding GEM to recognize engine and other powertrain component improvements will provide important flexibility to vehicle manufacturers. Providing flexibility to effectively trade engine and other powertrain component improvements against the other vehicle improvements that are recognized in GEM will allow vehicle manufacturers to better optimize their vehicles to achieve the lowest cost for specific customers. Because of the improvements in GEM, GEM will recognize this deeper level of vehicle optimization. Vehicle manufacturers could use this flexibility to reduce overall compliance costs and/or address special applications where certain vehicle technologies are not preferred or

practical. The agencies considered in Phase 1 allowing the exchange of emission certification credits generated relative to the separate brake-specific engine standards and credits generated relative to the vehicle standards. However, we did not allow this in Phase 1 due in part to concerns about the equivalency of credits generated relative to different standards, with different units of measure and different test procedures. The Phase 2 approach eliminates these concerns because engine and other vehicle component improvements will be evaluated relative to the same vehicle standard in GEM. This also means that under the Phase 2 approach there is no need to consider allowing emissions credit trading between engine-generated and vehicle-generated credits because vehicle manufacturers are directly credited by the combination of engine and vehicle technologies they choose to install in each vehicle. Therefore, this approach eliminates one of the concerns about continuing separate engine standards, which was that a separate engine standard and a full vehicle standard were somehow mutually exclusive. That is not the case. In fact, in the next section we describe how we are continuing the separate engine standard along with recognizing engine performance at the vehicle level. The agencies acknowledge that maintaining a separate engine standard will limit flexibility in cases where a vehicle manufacturer wanted to use less efficient engines and make up for them using more efficient vehicle technologies. However, as described below, we see important advantages to maintaining a separate engine standard, and we believe they more than justify the reduced flexibility. Furthermore, in response to comments about some specialized vocational custom chassis, the agencies are finalizing a limited number of optional standards that would be met using a somewhat simplified version of GEM. Specifically, in this simplified version of GEM, which is only applicable as an option for certain custom chassis applications, the GEM inputs for the engine, transmission gears, gear ratios, gear efficiency; axle ratio, axle efficiency; and tire revolutions per mile are all fixed to default values. This simplification allows the option of certifying these custom chassis without penalty for utilizing less efficient engines, transmissions, or axles. This flexibility also addresses a comment the agencies received from Cummins that the inclusion of the specific engine in GEM limits the flexibility provided by

the separate engine standards' emissions averaging, banking and trading program. Cummins explained that certain applications like emergency vehicles, cement mixers and recreational vehicles oftentimes require higher-performance, less-efficient, engines, which are credit using engines under the ABT program of the separate engine standards. Because these particular vehicle applications have few other cost-effective and practical vehicle-level technologies with which to offset their use of less efficient engines, the main Phase 2 vocational chassis standards that require engine and other powertrain inputs into GEM (*i.e.*, the standards for other than custom chassis vocational vehicles) could be particularly challenging for these applications. However, the optional custom chassis standards solves this issue for custom chassis applications. This approach solves two issues. First, it provides a means toward certification for these custom chassis applications, without penalty for using the engines they need. Second, this approach maintains the flexibility intended by the separate engine standards' averaging, banking and trading program since these custom chassis applications would still be using certified engines.

One disadvantage of recognizing engines and transmission in GEM is that it will increase complexity for the vehicle standards. For example, vehicle manufacturers will be required to conduct additional engine tests and to generate additional GEM inputs for compliance purposes. However, we believe that most of the burden associated with this increased complexity will be an infrequent burden of engine testing and updating information systems to track these inputs. Furthermore, the agencies are requiring that engine manufacturers certify their respective GEM inputs; namely, their own engine maps. Because there are a relatively small number of heavy-duty engine manufacturers who will be responsible for generating and complying with their declared engine maps for GEM, the overall engine testing burden to the heavy-duty vehicle industry is small. With this approach, the large number of vocational chassis manufacturers will not have to conduct any engine testing.

Another potential disadvantage to GEM-based vehicle certification is that because GEM measures performance over specific duty cycles intended to represent average operation of vehicles in-use, this approach might also create an incentive to optimize powertrains and drivetrains for the best GEM performance rather than the best in-use performance for a particular application.

This is always a concern when selecting duty cycles for certification, and so is not an issue unique to GEM. There will always be instances, however infrequent, where specific vehicle applications will operate differently than the duty cycles used for certification. The question is would these differences force manufacturers to optimize vehicles to the certification duty cycles in a way that decreases fuel efficiency and increases GHG emissions in-use? We believe that the certification duty cycles will not create a disincentive for manufacturers to properly optimize vehicles for customer fuel efficiency. First, the impact of the certification duty cycles versus any other real-world cycle will be relatively small because they affect only a small fraction of all vehicle technologies. Second, the emission averaging and fleet average provisions mean that the regulations will not require all vehicles to meet the standards. Vehicles exceeding a standard over the duty cycles because they are optimized for different in-use operation can be offset by other vehicles that perform better over the certification duty cycles. Third, vehicle manufacturers also have the ability to lower such a vehicle's measured GHG emissions by adding technology that would improve fuel efficiency both over the certification duty cycles and in-use (and to be potentially eligible to generate off-cycle credits in doing so). These standards are not intended to be at a stringency where manufacturers will be expected to apply all technologies to all vehicles. Thus, there should be technologies available to add to vehicle configurations that initially fail to meet the Phase 2 standards. Fourth, we are further sub-categorizing the vocational vehicle segment compared to Phase 1, tripling the number of subcategories within this segment from three to nine. These nine subcategories will divide each of the three Phase 1 weight categories into three additional vehicle speed categories. Each of the three speed categories will have unique duty cycle weighting factors to recognize that different vocational chassis are configured for different vehicle speed applications. This further subdivision better recognizes technologies' performance under the conditions for which the vocational chassis was configured to operate. This also decreases the potential of the certification duty cycles to encourage manufacturers to configure vocational chassis differently than the optimum configuration for specific customers' applications. Similarly, for the tractor

category we are finalizing a new “heavy-haul” category to recognize the greater payload and vehicle mass of these tractors, as well as their limitations to effectively utilize some technologies like aerodynamic technologies. These new categories help minimize differences between GEM simulation and real-world operation. Finally, we are also recognizing seven specific vocational vehicle applications under the optional custom chassis vocational vehicle standards.

Another disadvantage of our full vehicle simulation approach is the potential requirement for engine manufacturers to disclose information to vehicle manufacturers who install their engines that engine manufacturers might consider to be proprietary. Under this approach, vehicle manufacturers may need to know some additional details about engine performance long before production, both for compliance planning purposes, as well as for the actual submission of applications for certification. Moreover, vehicle manufacturers will need to know details about the engine’s performance that are generally not publicly available—specifically the detailed steady-state fuel consumption map of an engine. Some commenters expressed significant concern about the Phase 2 program forcing the disclosure of proprietary steady-state engine performance information to business competitors; especially prior to an engine being introduced into commerce. It can be argued that a sufficiently detailed steady-state engine map, such as the one required for input into GEM, can reveal proprietary engine design elements such as intake air, turbo-charger, and exhaust system design; exhaust gas recirculation strategies; fuel injection strategies; and exhaust after-treatment thermal management strategies. Conversely, the agencies also received comments requesting that all GEM inputs be made public, as a matter of transparency and public interest.

It is unclear at this point whether such information is truly proprietary. In accordance with Federal statutes, EPA does not release information from certification applications (or other compliance reports) that we determine to be Confidential Business Information (CBI) under 40 CFR part 2. Consistent with section 114(c) of the CAA, EPA does not consider emission test results to be CBI *after* introduction into commerce of the certified engine or vehicle. However, we have generally treated test results as protected *before* a product’s introduction into commerce date. EPA has not yet made a final CBI determination for Phase 1 or Phase 2

GEM inputs. Nevertheless, at this time we expect to continue our current policy of non-disclosure prior to introduction into commerce, but we consider it likely that we would ultimately not treat any test results or other GEM inputs as CBI *after* the introduction into commerce date, as identified by the manufacturer.

To further address the specific concern about the Phase 2 program forcing the disclosure of proprietary steady-state engine maps to business competitors, especially prior to an engine being introduced into commerce, the agencies are finalizing an option for engine manufacturers to certify only “cycle average” engine maps over the 55-mph and 65-mph GEM cycles and separately mandating the cycle average approach for use over the ARB Transient cycle. See Section II.B. above. The advantage to this approach is that each data point of a cycle average map represents the average emissions over an entire cycle. Therefore, the cycle average engine map approach does not reveal any potentially proprietary information about an engine’s performance at a particular steady-state point of operation.

#### (b) Advantages of Separate Engine Standards

For engines installed in tractors and vocational vehicle chassis, we are maintaining separate engine standards for fuel consumption and GHG emissions in Phase 2 for both spark-ignition (SI, generally but not exclusively gasoline-fueled) and compression-ignition (CI, generally but not exclusively diesel-fueled) engines. Moreover, we are adopting a sequence of new more stringent engine standards for CI engines for engine model years 2021, 2024 and 2027. While the vehicle standards alone are intended to provide sufficient incentive for improvements in engine efficiency, we continue to see important advantages to maintaining separate engine standards for both SI and CI engines. The agencies believe the advantages described below are critical to fully achieve the goals of the EPA and NHTSA standards.

First, EPA has a robust compliance program based on separate engine testing. For the Phase 1 standards, we applied the existing criteria pollutant compliance program to ensure that engine efficiency in actual use reflected the improvements manufacturers claimed during certification. With engine-based standards, it is straightforward to hold engine manufacturers accountable by testing in-use engines in an engine dynamometer laboratory. If the engines exceed the

standards, manufacturers can be required to correct the problem or perform other remedial actions. Without separate engine standards in Phase 2, addressing in-use compliance would be more subjective. Having clearly defined compliance responsibilities is important to both the agencies and to the manufacturers.

Second, engine standards for CO<sub>2</sub> and fuel efficiency force engine manufacturers to optimize engines for both fuel efficiency and control of non-CO<sub>2</sub> emissions at the same engine operating points. This is of special concern for NO<sub>x</sub> emissions, given the strong counter-dependency between engine-out NO<sub>x</sub> emissions and fuel consumption. By requiring engine manufacturers to comply with both NO<sub>x</sub> and CO<sub>2</sub> standards using the same test procedures, the agencies ensure that manufacturers include technologies that can be optimized for both, rather than alternate, calibrations that would trade NO<sub>x</sub> emissions against fuel consumption, depending how the engine or vehicle is tested. In the past, when there was no CO<sub>2</sub> engine standard and no steady-state NO<sub>x</sub> standard, some manufacturers chose this dual calibration approach instead of investing in technology that would allow them to simultaneously reduce both CO<sub>2</sub> and NO<sub>x</sub>.

It is worth noting that these first two advantages foster fair competition within the marketplace. In this respect, the separate engine standards help assure manufacturers that their competitors are not taking advantage of regulatory ambiguity. The agencies believe that the absence of separate engine standards would leave open the opportunity for a manufacturer to choose a high-risk compliance strategy by gaming the NO<sub>x</sub>-CO<sub>2</sub> tradeoff. Manufacturer concerns that competitors might take advantage of this can create a dilemma for those who wish to fully comply, but also perceive shareholder pressure to choose a high-risk compliance strategy to maintain market share.

Finally, the existence of meaningful separate engine standards allows the agencies to exempt certain vehicles from some or all of the vehicle standards and requirements without forgoing the engine improvements. A good example of this is the off-road vehicle exemption in 40 CFR 1037.631 and 49 CFR 535.3, which exempts vehicles “intended to be used extensively in off-road environments” from the vehicle requirements. The engines used in such vehicles must still meet the engine standards of 40 CFR 1036.108 and 49 CFR 535.5(d). The agencies see no

reason why efficient engines cannot be used in such vehicles. However, without separate engine standards, there would be no way to require the engines to be efficient. The engine standards provide a similar benefit with respect to the custom chassis program discussed in Section V.

In the past there has been some confusion about the Phase 1 separate engine standards somehow preventing the recognition of engine-vehicle optimization that vehicle manufacturers perform to minimize a vehicle's overall fuel consumption. It was not the existence of separate engine standards that prevented recognition of this optimization. Rather it was that the agencies did not allow manufacturers to enter inputs into GEM that characterized unique engine performance. For Phase 2 we are requiring that manufacturers input such data because we intend for GEM to recognize this engine-vehicle optimization. The continuation of separate engine standards in Phase 2 does not undermine in any way the recognition of this optimization in GEM.

### C. Phase 2 GEM and Vehicle Component Test Procedures<sup>146</sup>

GEM was originally created for the certification of tractors and vocational vehicle chassis to the agencies' Phase 1 CO<sub>2</sub> and fuel efficiency standards. See 76 FR 57116, 57146, and 57156–57157. For Phase 2 the agencies proposed a number of modifications to GEM, and based on public comments in response to the agencies' proposed modifications, the agencies have further refined these modifications for this final action.

In Phase 1 the agencies adopted a regulatory structure where regulated entities are required to use GEM to simulate and certify tractors and vocational vehicle chassis. This computer program is provided free of charge for unlimited use, and the program may be downloaded by anyone from EPA's Web site: <http://www3.epa.gov/otaq/climate/gem.htm>. GEM mathematically combines the results of a number of performance tests of certain vehicle components, along with other pre-determined vehicle attributes and driving patterns to determine a vehicle's characteristic levels of fuel consumption and CO<sub>2</sub> emissions, for certification purposes. For Phase 1, the required inputs to GEM for tractors include vehicle aerodynamics information, tire rolling resistance, and whether or not a vehicle

is equipped with certain lightweight high-strength steel or aluminum components, a tamper-proof speed limiter, or tamper-proof idle reduction technologies. For Phase 1, the sole input for vocational vehicles is tire rolling resistance. For Phase 1, the computer program's inputs did not include engine test results or attributes related to a vehicle's powertrain; namely, its transmission, drive axle(s), or tire revolutions per mile. Instead, for Phase 1 the agencies specified generic engine and powertrain attributes within GEM. For Phase 1 these are fixed and cannot be changed in GEM.<sup>147</sup>

Similar to other vehicle simulation computer programs, GEM combines various vehicle inputs with known physical laws and justified assumptions to predict vehicle performance for a given period of vehicle operation. GEM represents this information numerically, and this information is integrated as a function of time to calculate CO<sub>2</sub> emissions and fuel consumption. Some of the justified assumptions in GEM include average energy losses due to friction between moving parts of a vehicle's powertrain; the logical behavior of an average driver shifting from one transmission gear to the next; and speed limit assumptions such as 55 miles per hour for urban highway driving and 65 miles per hour for rural interstate highway driving. The sequence of the GEM vehicle simulation can be visualized by imagining a human driver initially sitting in a parked running tractor or vocational vehicle. The driver then proceeds to drive the vehicle over a prescribed route that includes three distinct patterns of driving: Stop-and-go city driving, urban highway driving, and rural interstate highway driving. The driver then exits the highway and brings the vehicle to a stop, with the engine still running at idle. This concludes the vehicle simulation sequence.

Over each of the three driving patterns or "duty cycles," GEM simulates the driver's behavior of pressing the accelerator, coasting, or applying the brakes. GEM also simulates how the engine operates as the gears in the vehicle's transmission are shifted and how the vehicle's weight, aerodynamics, and tires resist the forward motion of the vehicle. GEM combines the driver behavior over the duty cycles with the various vehicle inputs and other assumptions to determine how much fuel must be consumed to move the vehicle forward

at each point during the simulation. For Phase 2 the agencies added the effect of road grade. In GEM the effect of road grade on fuel consumption is simulated by increasing fuel consumption uphill, by the amount of fuel consumed by the engine to provide the power needed to raise the mass of the vehicle and its payload against the force of Earth's gravity—while at the same time maintaining the duty cycle's vehicle speed. Downhill road grades are simulated by decreasing the engine's fuel consumption, by the amount of power returned to the vehicle by it moving in the same direction as Earth's gravity. To maintain vehicle speed downhill, simulated brakes are sometimes applied, and the energy lost due to braking results in a certain amount of fuel consumption as well. For each of the three duty cycles, GEM totals the amount of fuel consumed and then divides that amount by the product of the miles travelled and tons of payload carried. The tons of payload carried are specified by the agencies for each vehicle type and weight class, and these cannot be changed in GEM.

In addition to determining fuel consumption over these duty cycles, for Phase 2, GEM calculates a vehicle's fuel consumption rate when it is stopped in traffic with the driver still operating the vehicle (*i.e.*, "drive idle") and when the vehicle is stopped and parked with the engine still running (*i.e.*, "parked idle"). For each regulatory subcategory of tractor and vocational vehicle (*e.g.*, sleeper cab tractor, day cab tractor, light heavy-duty urban vocational vehicle, heavy heavy-duty regional vocational vehicle, etc.), GEM applies the agencies' prescribed weighting factors to each of the three duty cycles and to each of the two idle fuel consumption rates to represent the fraction of city driving, urban highway driving, rural highway driving, drive idle, and parked idle that is typical of each subcategory. After combining the weighted results of all the cycles and idle fuel rates, GEM then outputs a single composite result for the vehicle, expressed as both fuel consumed in gallon per 1,000 ton-miles (for NHTSA standards) and an equivalent amount of CO<sub>2</sub> emitted in grams per ton-mile (for EPA standards). These are the vehicle's GEM results that are used along with other information to demonstrate that a vehicle certificate holder (*e.g.*, a vehicle manufacturer) complies with the applicable standards. This other information includes the annual sales volume of the vehicle family, plus information on emissions credits that may be generated or used as

<sup>146</sup> The specific version of GEM used to develop these standards, and which we propose to use for compliance purposes is also known as GEM 3.0.

<sup>147</sup> These attributes are recognized in Phase 1 innovative technology provisions at 40 CFR 1037.610.

part of that vehicle family's certification.

For Phase 1 GEM's tractor inputs include vehicle aerodynamics information, tire rolling resistance, and whether or not a vehicle is equipped with lightweight materials, a tamper-proof speed limiter, or tamper-proof idle reduction technologies. Other vehicle and engine characteristics in GEM were fixed as defaults that cannot be altered by the user. These defaults included tabulated data of engine fuel rate as a function of engine speed and torque (*i.e.*, "engine fuel maps"), transmissions, axle ratios, and vehicle payloads. For tractors, Phase 1 GEM simulates a tractor pulling a standard trailer. For vocational vehicles, Phase 1 GEM includes a fixed aerodynamic drag coefficient and vehicle frontal area.

For Phase 2 new inputs are required and other new inputs are allowed as options. These include the outputs of new test procedures to "map" an engine to generate steady-state and transient, cycle-average, engine fuel rate inputs to represent the actual engine in a vehicle. As described in detail in RIA Chapter 4, certification to the Phase 2 standards will require entering new inputs into GEM to describe the vehicle's transmission type and its number of gears and gear ratios. Manufacturers must also enter attributes that describe the vehicle's drive axle(s) type, axle ratio and tire revolutions per mile. We are also finalizing a number of options to conduct additional component testing for the purpose of replacing some of the agencies' "default values" in GEM with inputs that are based on component testing. These include optional axle and transmission power loss test procedures. We are also finalizing an optional powertrain test procedure that would replace both the required engine mapping and the agencies' default values for a transmission and its automated shift strategy. We are also finalizing an option to generate cycle-average maps for the 55 mph and 65 mph cycles in GEM. In addition, we have made a number of improvements to the aerodynamic coast-down test procedures and associated aerodynamic data analysis techniques. While these aerodynamic test and data analysis improvements are primarily intended for tractors, for Phase 2 we are providing a streamlined off-cycle credit pathway for vocational vehicle aerodynamic performance to be recognized in GEM.

As proposed, we are finalizing a significantly expanded number of technologies that are recognized in GEM. These include recognizing lightweight thermoplastic materials, automatic tire inflation systems,

advanced cruise control systems, workday idle reduction systems, and axle configurations that decrease the number of drive axles. In response to comments and data submitted to the agencies on the Phase 2 proposal we are also finalizing inputs related to tire pressure monitoring systems and advanced electronically controlled vehicle coast systems.

Although GEM is similar in concept to a number of other commercially available vehicle simulation computer programs, the applicability of GEM is unique. First, GEM was designed exclusively for manufacturers and regulated entities to certify tractor and vocational vehicle chassis to the agencies' fuel consumption and CO<sub>2</sub> emissions standards. For GEM to be effective for this purpose, the inputs to GEM include only information related to certain vehicle components and attributes that significantly impact vehicle fuel efficiency and CO<sub>2</sub> emissions. For example, these include vehicle aerodynamics, tire rolling resistance, and powertrain component information. On the other hand, other attributes such as those related to a vehicle's suspension, frame strength, or interior features are not included, where these otherwise might be included in other commercially available vehicle simulation programs that are used for other purposes. Furthermore, the simulated payload, driver behavior and duty cycles in GEM cannot be changed. Keeping these values constant helps to ensure that all vehicles are simulated and certified in the same way. However, these fixed attributes in GEM largely preclude GEM from being of much use as a research tool for exploring the effects of payload, driver behavior and different duty cycles.

Similar to Phase 1, GEM for Phase 2 is available free of charge for unlimited use, and the GEM source code is open source. That is, the programming source code of GEM is freely available upon request for anyone to examine, manipulate, and generally use without restriction. In contrast, commercially available vehicle simulation programs are generally not free and open source. Additional details of GEM are included in Chapter 4 of the RIA.

GEM is a computer software program, and like all other software development processes the agencies periodically released a number of developmental versions of the GEM software for others to review and test during the Phase 2 rulemaking process. This type of user testing significantly helps the agencies detect and fix any problems or "bugs" in the GEM software.

As part of Phase 1, the agencies conducted a peer review of GEM version 1.0, which was the version released for the Phase 1 proposal.<sup>148 149</sup> In response to this peer review and to comments from stakeholders, EPA made changes to the version of GEM released with the Phase 1 final rule. Updates to the Phase 1 GEM were also made via Technical Amendments.<sup>150</sup> The current version of Phase 1 GEM is v2.0.1, which is the version applicable for the Phase 1 standards.<sup>150</sup> As part of the development of GEM for Phase 2, both a formal peer review<sup>149</sup> and a series of expert reviews were conducted.<sup>151 152 153 154</sup>

The agencies have provided numerous opportunities for comment on GEM, and its iterative development. Shortly after the Phase 2 proposal's publication in July 2015 (and before the end of the public comment period), the agencies received comments on GEM. Based on these early comments, the agencies made minor revisions to fix a few bugs in GEM and in August 2015 released an updated version of GEM to the public for additional comment, which also included new information on GEM road grade profiles. The agencies also extended the public comment period on the proposal, which provided at least 30 days for public comment on this slightly updated version of GEM.<sup>153</sup> Then, in response to comments submitted at the close of the comment period, in early January 2016

<sup>148</sup> See 76 FR 57146–57147.

<sup>149</sup> U.S. Environmental Protection Agency. "Peer Review of the Greenhouse Gas Emissions Model (GEM) and EPA's Response to Comments." EPA-420-R-11-007. Last access on November 24, 2014 at <http://www3.epa.gov/otaq/climate/documents/420r11007.pdf>.

<sup>150</sup> See EPA's Web site at <http://www3.epa.gov/otaq/climate/gem.htm> for the Phase 1 GEM revision dated May 2013, made to accommodate a revision to 49 CFR 535.6(b)(3).

<sup>151</sup> U.S. Environmental Protection Agency, GEM new release (GEM P2v1.1) and known issues and workarounds for GEM P2v1.0), Greenhouse Gas Emissions Standards and Fuel Efficiency Standards for Medium- and Heavy-Duty Engines and Vehicles—Phase 2—EPA-HQ-OAR-2014-0827, August 19, 2015.

<sup>152</sup> U.S. Environmental Protection Agency, GEM Power User Release for Debugging, Greenhouse Gas Emissions Standards and Fuel Efficiency Standards for Medium- and Heavy-Duty Engines and Vehicles—Phase 2—EPA-HQ-OAR-2014-0827, January 27, 2016.

<sup>153</sup> U.S. Environmental Protection Agency, GEM NODA Release, Greenhouse Gas Emissions Standards and Fuel Efficiency Standards for Medium- and Heavy-Duty Engines and Vehicles—Phase 2—EPA-HQ-OAR-2014-0827, February 16, 2016.

<sup>154</sup> U.S. Environmental Protection Agency, GEM Power User Release for Debugging, Greenhouse Gas Emissions Standards and Fuel Efficiency Standards for Medium- and Heavy-Duty Engines and Vehicles—Phase 2—EPA-HQ-OAR-2014-0827, May 19, 2016.

the agencies released a “debugging” version of GEM to a wide range of expert reviewers.<sup>152</sup> The agencies provided one month for expert reviewers to provide informal feedback for debugging purposes.<sup>152</sup> Because the changes for this debugging version mostly added new features to make GEM easier to use for certifying via optional test procedures, like the powertrain test, there were only minor changes to the way that GEM performed. In the March 2016 NODA, the agencies included another developmental version of GEM<sup>153</sup> for public comment and provided 30 days for public comment. Based on the NREL report, which was also released as part of the NODA for public comment, the NODA version of GEM contained updated weighting factors of the duty cycles and idle cycles.<sup>155</sup> Therefore, the outputs of GEM for a given vehicle configuration changed because these duty cycle weighting factors changed, but there were only minor updates to how the individual technologies were simulated in GEM. Based on comments received on the NODA, the agencies made minor changes to GEM and released another debugging version in May 2016 to manufacturers, NGOs, suppliers, and CARB staff.<sup>154</sup> The most significant change to GEM for the May 2016 version was that 0.5 miles of flat road was added to the beginning and end of the 55 mph and 65 mph drive cycles in response to concerns raised by manufacturers.<sup>156</sup> This change did not change the way that GEM worked, but it did change GEM results because of the change in the duty cycles. This change was made to better align GEM simulation with real-world engine operation. The agencies provided the expert reviewers with at least a 3-week period in which to review GEM and provide feedback. Details on the history of the comments the agencies received and the history of the agencies responses leading to these multiple releases of GEM can be found in Section II.C.(1). The following list summarizes the changes in GEM in response to those comments and data submitted to the agencies in response to the Phase 2 proposal, NODA and other GEM releases:

- Revised road grade profiles for 55- and 65-mph cruise cycles, only minor changes since August 2015.
- Revised idle cycles for vocational vehicles with new vocational cycle

<sup>152</sup> EPA–HQ–OAR–2014–0827–1621 and NHTSA–2014–0132–0187.

<sup>156</sup> Memo to Docket, “Summary of Meetings and Conference Calls with the Truck and Engine Manufacturers Association to Discuss the Phase 2 Heavy-Duty GHG Rulemaking”, August 2016.

weightings, weightings released for public comment in NODA.

- Made changes to the input file structures. Examples includes additions of columns for axle configuration (“6×2,” “6×4,” “6×4D,” “4×2”), and additions of a few more technology improvement inputs, such as “Neutral Idle,” “Start/Stop,” and “Automatic Engine Shutdown.” These were minor changes, all were in NODA version of GEM.

- Made changes to the output file structures. Examples include an option to allow the user to select an output of detailed results on average speed, average work at the input and output of the transmission, and the numbers of shifts for each cycle (e.g., 55 mph cycle, 65 mph cycle and the ARB Transient cycle). These were minor changes, all were in NODA version of GEM.

- Added an input file for optional axle power losses (function of axle output speed and torque) and replaced a single axle efficiency value with lookup table of power loss. These were minor changes to streamline the use of GEM, all were in NODA version of GEM.

- Modified engine torque response to be more realistic, with a fast response region scaled by engine displacement, and a slower torque response in the turbo-charger’s highly boosted region. These were minor changes, all were in NODA version of GEM.

- Added least-squares regression models to interpret cycle-average fuel maps for all cycles. These were minor changes to streamline the use of GEM, all were in NODA version of GEM.

- Added different fuel properties according to 40 CFR 1036.530. This was a fix to align GEM with regulations.

- Improved shift strategy based on testing data and comments received. These were minor changes, all were in NODA version of GEM.

- Added scaling factors for transmission loss and inertia, per regulatory subcategory. These were minor changes, all were in NODA version of GEM.

- Added optional input table for transmission power loss data. These were minor changes to streamline the use of GEM, all were in NODA version of GEM.

- Added minimum torque converter lock-up gear user input for automatic transmissions. This was a minor change to streamline the use of GEM, this change was in the NODA version of GEM.

- Revised the default transmission power loss tables, based on test data. This was a minor change to streamline

the use of GEM, this change was in the NODA version of GEM.

- Added neutral idle and start/stop effects idle portions of the ARB Transient cycle. These were minor changes, all were in NODA version of GEM

- Adjusted shift and torque converter lockup strategy. This was a minor change to streamline the use of GEM, this change was in the NODA version of GEM.

Notwithstanding these numerous opportunities for public comment (as well as many informal opportunities via individual meetings), some commenters maintained that they still had not received sufficient notice to provide informed comment because each proposal represented too much of a “moving target.”<sup>157 158 159</sup> The agencies disagree. Even at proposal, Phase 2 GEM provided nearly all of the essential features of the version we are promulgating in final form. These include: (1) The reconfiguration of the engine, transmission, and axle sub-models to reflect additional designs and to receive manufacturer inputs; and (2) the addition of road grade and idle cycles for vocational vehicles, along with revised weighting factors.

Moreover, the changes the agencies have made to GEM in response to public comment indicates that those comments were highly informed by the proposal. The agencies thus do not accept the contention that commenters were not afforded sufficient information to provide meaningful comment on GEM.

#### (1) Description of Modifications to GEM From Phase 1 to Phase 2

As explained above, GEM is a computer program that was originally developed by EPA specifically for manufacturers to use to certify to the Phase 1 tractor and vocational chassis standards. GEM mathematically combines the results of vehicle component test procedures with other vehicle attributes to determine a vehicle’s certified levels of fuel consumption and CO<sub>2</sub> emissions. Again as explained above, for Phase 1 the required inputs to GEM include vehicle aerodynamics information, tire rolling resistance, and whether or not a vehicle is equipped with certain lightweight

<sup>157</sup> Memo to Docket, “Summary of Meetings and Conference Calls with the Truck and Engine Manufacturers Association to Discuss the Phase 2 Heavy-Duty GHG Rulemaking”, August 2016.

<sup>158</sup> Memo to Docket, “Summary of Meetings and Conference Calls with Allison Transmission to Discuss the Phase 2 Heavy-Duty GHG Rulemaking”, August 2016.

<sup>159</sup> “Heavy-Duty Phase 2 Stakeholder Meeting Log”, August 2016.



high-strength steel or aluminum components, a tamper-proof speed limiter, or tamper-proof idle reduction technologies for tractors. The vocational vehicle inputs to GEM for Phase 1 only included tire rolling resistance. For Phase 1 GEM's inputs did not include engine test results or attributes related to a vehicle's powertrain; namely, its transmission, drive axle(s), or loaded tire radius. Instead, for Phase 1 the agencies specified a generic engine and powertrain within GEM, and for Phase 1 these cannot be changed in GEM.

For this rulemaking, GEM has been modified as proposed and validated against a set of experimental data that represent over 130 unique vehicle variants conducted at powertrain and chassis dynamometers with the manufacturers' provided transmission shifting tables. In addition, GEM has been validated against different types of tests when the EPA transmission default auto-shift strategy is used, which includes powertrain dynamometer tests and two truck tests running in a real-world driving route. Detailed comparisons can be seen in Chapter 4 of the RIA. As noted above, the agencies believe that this new version of GEM is an accurate and cost-effective alternative to measuring fuel consumption and CO<sub>2</sub> over a chassis dynamometer test procedure. Again as noted earlier, some of the key modifications will require additional vehicle component test procedures (both mandatory and optional) to generate additional GEM inputs. The results of which will provide additional inputs into GEM. These include a new required engine test procedure to provide engine fuel consumption inputs into GEM. We proposed to measure fuel consumption as a matrix of steady-state points, but also sought comment on a newly developed engine test procedure that captures transient engine performance for use in GEM. We are specifying a combination of these procedures for the final rule—steady-state fuel maps for the highway cruise simulations, and cycle-average maps for transient simulations. As an option, cycle average maps could be also used for the highway cruise simulation as well. See Chapter 3 of the RIA for additional discussion of the fuel mapping procedures. We are also requiring inputs that describe the vehicle's transmission type, and its number of gears and gear ratios. We are allowing an optional powertrain test procedure that would provide inputs to override the agencies' simulated engine and transmission in GEM. In addition, in response to comments, we will also

allow manufacturers to measure transmission efficiency in the form of the power loss tables to replace the default values in GEM. We are finalizing the proposed requirement to input a description of the vehicle's drive axle(s), including its type (e.g., 6×4 or 6×2) and axle ratio. We are also finalizing the optional axle efficiency test procedure for which we sought comment. This would allow manufacturers to override the agencies' simulated axle in GEM. Chapter 4 of the RIA details all of these GEM related input changes.

As noted above, we are significantly expanding the number of technologies that are recognized in GEM. These include recognizing lightweight thermoplastic materials, automatic tire inflation systems, advanced cruise control systems, engine stop-start idle reduction systems, and axle configurations that decrease the number of drive axles. To better reflect real-world operation, we are also revising the vehicle simulation computer program's urban and rural highway duty cycles to include changes in road grade, and including a new duty cycle to capture the performance of technologies that reduce the amount of time a vehicle's engine is at idle during a workday. Finally, to better recognize that vocational vehicle powertrains are configured for particular applications, we are further subdividing the vocational chassis category into three different vehicle speed categories, where GEM weights the individual duty cycles' results of each of the speed categories differently. Section 4.2 of the RIA details all these modifications. The following sub-sections provide further details on some of these key modifications to GEM.

#### (a) Simulating Engines for Vehicle Certification

Before describing the Phase 2 approach, this section first reviews how engines are simulated for vehicle certification in Phase 1. As noted earlier, GEM for Phase 1 simulates the same generic engine for any vehicle in a given regulatory subcategory with a data table of steady-state engine fuel consumption mass rates (g/s) versus a series of steady-state engine output shaft speeds (revolutions per minute, rpm) and loads (torque, N·m). This data table is also sometimes called a "fuel map" or an "engine map," although the term "engine map" can mean other kinds of data in different contexts. The engine speeds in this map range from idle to maximum governed speed and the loads range from engine motoring (negative load) to the maximum load of an engine. When GEM executes a simulation over

a vehicle duty cycle, this data table is linearly interpolated to find a corresponding fuel consumption mass rate at each engine speed and load that is demanded by the simulated vehicle operating over the duty cycle. The fuel consumption mass rate of the engine is then integrated over each duty cycle in GEM to arrive at the total mass of fuel consumed for the specific vehicle and duty cycle. Under Phase 1, manufacturers were not allowed to input their own engine fuel maps to represent their specific engines in the vehicle being simulated in GEM. Because GEM was programmed with fixed engine fuel maps for Phase 1 that all manufacturers had to use, the tables themselves did not have to exactly represent how an actual engine might operate over these three different duty cycles.

In contrast, for Phase 2 we are requiring manufacturers to generate their own engine fuel maps to represent each of their engine families in GEM. This Phase 2 approach is consistent with the 2014 NAS Phase 2 First Report recommendation.<sup>160</sup> To investigate this approach, before proposal we examined the results from 28 individual engine dynamometer tests. Three different engines were used to generate this data, and these engines were produced by two different engine manufacturers. One engine was tested at three different power ratings (13 liters at 410, 450 & 475 bhp) and one engine was tested at two ratings (6.7 liters at 240 and 300 bhp), and other engine with one rating (15 liters 455 bhp) service classes. For each engine and rating the steady-state engine dynamometer test procedure was conducted to generate an engine fuel map to represent that particular engine in GEM. Next, with GEM, we simulated various vehicles in which the engine could be installed. For each of the GEM duty cycles we are using, namely the urban local (ARB Transient), urban highway with road grade (55 mph), and rural highway with road grade (65 mph) duty cycles, we determined the GEM result for each vehicle configuration, and we saved the engine output shaft speed and torque information that GEM created to interpolate the steady-state engine map for each vehicle configuration. We then had this same engine output shaft speed and torque information programmed into an engine dynamometer controller, and we had each engine perform the same duty cycles that GEM demanded of the

<sup>160</sup> National Academy of Science. "Reducing the Fuel Consumption and GHG Emissions of Medium- and Heavy-Duty Vehicles, Phase Two, First Report." 2014. Recommendation 3.8.



simulated version of the engine. We then compared the GEM results based on GEM's linear interpolation of the engine maps to the measured engine dynamometer results. We concluded that for the 55 mph and 65 mph duty cycles, GEM's interpolation of the steady-state data tables was sufficiently accurate versus the measured results. This is an outcome one would reasonably expect because even with changes in road grade, the 55 mph and 65 mph duty cycles do not demand rapid changes in engine speed or load. The 55 mph and 65 mph duty cycles are nearly steady-state, as far as engine operation is concerned, just like the engine maps themselves. However, for the ARB Transient cycle, we observed a consistent bias when using the steady-state maps, where GEM consistently under-predicted fuel consumption and CO<sub>2</sub> emissions. This low bias over the 28 engine tests ranged from 4.2 percent low to 7.8 percent low. The mean was 5.9 percent low and the 90th percentile value was 7.1 percent low. These observations are consistent with the fact that engines generally operate less efficiently under transient conditions than under steady-state conditions.

A number of reasons explain this consistent trend. For example, under rapidly changing (*i.e.* transient) engine conditions, it is generally more challenging to program an engine electronic controller to respond with optimum fuel injection rate and timing, exhaust gas recirculation valve position, variable nozzle turbocharger vane position and other set points than under steady-state conditions. Transient heat and mass transfer within the intake, exhaust, and combustion chambers also tend to increase turbulence and enhance energy loss to engine coolant during transient operation. In many cases during cold transient operation, the thermal management is triggered in order to maintain optimal performance of selective catalytic reduction devices for a diesel engine. Furthermore, because exhaust emissions control is more challenging under transient engine operation, engineering tradeoffs sometimes need to be made between fuel efficiency and transient criteria pollutant emissions control. Special calibrations are typically also required to control smoke and manage exhaust temperatures during transient operation for a transient cycle.

To account for these effects in GEM, the agencies have developed and are finalizing a test procedure called "cycle average" mapping to account for this transient behavior (40 CFR 1036.540). Detailed analyses and presentation of the test procedure was published in two

peer-reviewed journal articles.<sup>139,140</sup> A number of commenters likewise suggested this approach. Additionally, progress has been made on further improving this test procedure since publication, based on a large number of engine dynamometer tests conducted by a variety of laboratory test facilities.<sup>161</sup> Since the proposal, further refinement of the numerical schemes used for interpreting cycle average engine fuel map was also completed. The engine dynamometer tests include a Cummins medium duty ISB engine, a Navistar heavy duty N13 engine, a Volvo heavy duty D13 engine, and a Cummins heavy duty ISX engine. All testing results indicated that the new test procedure works well for the transient ARB cycle.<sup>162</sup> In addition, Cummins in their NODA comments (see the following paragraph) provided additional data supporting this approach with their ISL 450 bhp rating engine. This data corroborated earlier data showing good agreement between engine dynamometer tests and the cycle average engine mapping approach.<sup>163</sup>

EPA solicited comment on the cycle average approach at proposal. 80 FR 40193. EPA also specifically provided notice and a 30-day opportunity for public comment on the possibility of requiring use of the cycle average mapping approach for the ARB Transient cycle. This was included in the version of GEM that was made available for public comment as part of the NODA<sup>153</sup>. In response, many comments were received on the cycle average approach. These include comments from Cummins<sup>163</sup> and Volvo.<sup>164</sup> Cummins was very supportive of the cycle average approach and also supported applying this approach to the 55 mph and 65 mph cruise cycles in GEM. Volvo expressed some concern over having enough time to fully evaluate this approach. The agencies believe that one of the reasons that Volvo expressed concern over having enough time to evaluate this approach is because Volvo initially declined working with the agencies to

collaboratively refine this approach. At the same time, a number of Volvo's competitors chose to actively coordinate laboratory testing and technical analysis to contribute to the development of this approach. We believe these other manufacturers gained a deeper understanding of the approach earlier than Volvo because they invested time and resources to make technical contributions at earlier point in time. Nevertheless, the agencies fully welcome and appreciate Volvo's more recent active involvement in reviewing the cycle average approach and for making a number of productive suggestions for further refinement.

While the agencies are finalizing the cycle average engine mapping test procedure as mandatory for the ARB Transient cycle, for the 55 mph and 65 mph GEM drive cycles, the agencies are finalizing the same steady-state mapping procedure that the agencies originally proposed. The only difference is that we are finalizing about 85 unique steady-state map points, versus the about 143 points that were proposed. See 40 CFR 1036.535 for details. We are adopting a lower number of points because many of the originally proposed points were specified for use with the ARB Transient cycle.<sup>139</sup> Again, as an option, the cycle average mapping test procedure also may be used for these two cruise speed cycles, in lieu of the steady-state mapping procedure.

#### (b) Simulating Human Driver Behavior and Transmissions for Vehicle Certification

GEM for Phase 1 simulates the same generic human driver behavior and manual transmission shifting patterns for all vehicles. The simulated driver responds to changes in the target vehicle speed of the duty cycles by changing the simulated positions of the vehicle's accelerator pedal, brake pedal, clutch pedal, and gear shift lever. For simplicity, in Phase 1 the GEM driver shifted at pre-specified vehicle speeds and the manual transmission was simulated as an ideal transmission that did not have any delay time (*i.e.*, torque interruption) between gear shifts and did not have any energy losses associated with clutch slip during gear shifts.

In GEM for Phase 2 we are allowing manufacturers to select one of four types of transmissions to represent the transmission in the vehicle they are certifying: Manual transmission (MT), automated manual transmission (AMT), automatic transmission (AT) and dual clutch transmission (DCT). For Phase 2 the agencies proposed unique transmission shifting patterns to

<sup>161</sup> Memos to Docket, "Test Procedure Review with Cummins, Volvo, Navistar, Paccar, Daimler Eaton and Allison."

<sup>162</sup> Michael Ross, *Validation Testing for Phase 2 Greenhouse Gas Test Procedures and the Greenhouse Gas Emission Model (GEM) for Medium and Heavy-Duty Engines and Powertrains*, Final Report to EPA, Southwest Research Institute, June 2016, found in docket of this rulemaking, EPA-HQ-QAR-2014-0827.

<sup>163</sup> Cummins NODA Comments, found in Phase 2 Docket: ID No. EPA-HQ-OAR-2014-0817, April 1, 2016.

<sup>164</sup> Volvo Group NODA Comments, found in Phase 2 Docket: ID No. EPA-HQ-OAR-2014-0817, April 1, 2016.

represent the different types of automated transmissions. These shifting patterns over the steady state cruise cycles has been further modified from the proposed version to be more realistic with respect to slight variations in vehicle speed due to road grade. In particular, when going downhill, the simulated vehicle is now allowed to exceed the speed target by 3 mph before the brakes are applied. In the proposed version, the driver model applied the brakes much sooner to prevent the vehicle from exceeding the speed target. This change allows the vehicle to carry additional momentum into the next hill, much the same as real drivers would.

In the final version of GEM, the driver behavior and the different transmission types are simulated in the same basic manner as in Phase 1, but each transmission type features unique transmission responses that match the transmission responses we measured during vehicle testing of these three transmission types. In general the transmission gear shifting strategy for all of the transmissions is designed to shift the transmission so that it is in the most efficient gear for the current vehicle demand, while staying within certain limits to prevent unrealistically high frequency shifting (*i.e.*, to prevent “short-shifting”). Some examples of these limits are torque reserve limits (which vary as function of engine speed), minimum time-in-gear and minimum fuel efficiency benefit to shift to the next gear. Some of the differences between the transmission types include a driver “double-clutching” during gear shifts of the manual transmission only, and “power shifts” and torque converter torque multiplication, slip, and lock-up in automatic transmissions only. Refer to Chapter 4 of the RIA for a more detailed description of these different simulated driver behaviors and transmission types.

Prior to the proposal, we considered an alternative approach where transmission manufacturers would provide vehicle manufacturers with detailed information about their automated transmissions’ proprietary shift strategies for representation in GEM. NAS also recommended this approach.<sup>165</sup> The advantages of this approach would include a more realistic representation of a transmission in GEM

and potentially the recognition of additional fuel efficiency improving strategies to achieve additional fuel consumption and CO<sub>2</sub> emissions reductions. However, there are a number of technical and compliance disadvantages of this approach. One disadvantage is that it would require the disclosure of proprietary information because some vehicle manufacturers produce their own transmissions and also use other suppliers’ transmissions. There are technical challenges too. For example, some transmission manufacturers have upwards of 40 different shift strategies programmed into their transmission controllers. Depending on in-use driving conditions, some of which are not simulated in GEM (*e.g.*, changing payloads, changing tire traction) a transmission controller can change its shift strategy.

Representing dynamic switching between multiple proprietary shift strategies would be extremely complex to simulate in GEM. Furthermore, if the agencies were to require transmission manufacturers to provide shift strategy inputs for use in GEM, then the agencies would have to devise a compliance strategy to monitor in-use shift strategies, including a driver behavior model that could be implemented as part of an in-use shift strategy confirmatory test. This too would be very complex. If manufacturers were subject to in-use compliance requirements of their transmission shift strategies, this could lead to restricting the use of certain shift strategies in the heavy-duty sector, which would in turn potentially lead to sub-optimal vehicle configurations that do not improve fuel efficiency or adequately serve the wide range of customer needs; especially in the vocational vehicle segment. For example, if the agencies were to restrict the use of more aggressive and less fuel efficient in-use shift strategies that are used only under heavy loads and steep grades, then certain vehicle applications would need to compensate for this loss of capability through the installation of over-sized and over-powered engines that are subsequently poorly matched and less efficient under lighter load conditions. Therefore, as a policy consideration to preserve vehicle configuration choice and to preserve the full capability of heavy-duty vehicles today, the agencies are intentionally not allowing transmission manufacturers to submit detailed proprietary shift strategy information to vehicle manufacturers to input into GEM. The agencies are finalizing as proposed that vehicle manufacturers can choose from among several transmission types that

the agencies have already developed, validated, and programmed into GEM. The vehicle manufacturers will then enter into GEM their particular transmission’s number of gears and gear ratios, optionally together with power loss tables representing their transmission’s gear friction, pumping and spin losses. If a manufacturer chooses to use the optional powertrain test procedure, however, then the agencies’ transmission types in GEM would be overridden by the actual data collected during the powertrain test, which would recognize the transmission’s unique shift strategy. (Presumably, vehicle manufacturers will choose to use the optional powertrain test procedure only if their actual transmission shift strategy is more efficient compared to its respective default shift strategy simulated by GEM.)

#### (c) Simulating Axles for Vehicle Certification

In GEM for Phase 1 the axle ratio of the primary drive axle and the energy losses assumed in the simulated axle itself were the same for all vehicles. For Phase 2 the vehicle manufacturer will be required to input into GEM the axle ratio of the primary drive axle. This input will recognize the design to operate the engine at a particular engine speed when the transmission is operating in its highest transmission gear; especially for the 55 mph and 65 mph duty cycles in GEM. This input facilitates GEM’s recognition of vehicle designs that take advantage of operating the engine at the lowest possible engine speeds. This is commonly known as “engine down-speeding,” and the general rule-of-thumb for heavy-duty engines is that for every 100 rpm decrease in engine speed, there can be about a 1 percent decrease in fuel consumption and CO<sub>2</sub> emissions. Therefore, it is important that GEM allow this value to be input by the vehicle manufacturer. Axle ratio is also straightforward to verify during any in-use compliance audit. UCS and ACEEE commented that engine down-speeding should be recognized in the agencies’ separate engine standards, rather than in the vehicle standard. The agencies disagree with this because recognizing down-speeding at the vehicle level ensures that the powertrain configuration in-use, in the real world, will lead to the engine operating at lower speeds. In contrast, the engine speeds specified in the separate engine standards’ test procedures are based on the engine’s maximum torque versus speed curve (*i.e.*, lug curve) and not on the configuration of the powertrain to

<sup>165</sup> Transportation Research Board 2014. “Reducing the Fuel Consumption and Greenhouse Gas Emissions of Medium- and Heavy-Duty Vehicles, Phase Two.” (“Phase 2 First Report”) Washington, DC, The National Academies Press. Cooperative Agreement DTNH22-12-00389. Available electronically from the National Academy Press Web site at [http://www.nap.edu/catalog.php?record\\_id=12845](http://www.nap.edu/catalog.php?record_id=12845) (last accessed December 2, 2014). Recommendation 3.7.

which the engine is attached in a vehicle. This means that even if a manufacturer manipulated the engine's lug curve such that the separate engine standards' test procedure led to the engine operating at lower speeds during certification, that same engine could be installed in a vehicle with a powertrain configured for the engine to operate at higher engine speeds. Therefore, recognizing down-speeding within GEM, at the vehicle level, best ensures that the agencies' test procedures and standards lead to real-world engine down-speeding in-use.

We proposed to use a fixed axle ratio energy efficiency of 95.5 percent at all speeds and loads, but requested comment on whether this pre-specified efficiency is reasonable. 80 FR 40185. In general, commenters stated that the efficiency of the axle actually varies as a function of axle ratio, axle speed, and axle input torque. Therefore, we have modified GEM to accept an input data table of power loss as a function of axle speed and axle torque. The modified version of GEM subsequently interpolates this table over each of the duty cycles to represent a more realistic axle efficiency at each point of each duty cycle. The agencies specify a default axle efficiency table in GEM for any manufacturer to use. We are also finalizing an optional axle power loss test procedure that requires the use of a dynamometer test facility (40 CFR 1037.560). With this optional test procedure, a manufacturer can create an axle efficiency table for use in lieu of the EPA default table. We requested comment on this test procedure in the proposal, and we received supportive comments. Refer to 40 CFR 1037.560 of the Phase 2 regulations, which contain this test procedure.

Moreover, the final regulations allow the manufacturers to develop analytical methods to derive axle efficiency tables for untested axle configurations, based on testing of similar axles. This would be similar to the analytically derived CO<sub>2</sub> emission calculations allowed for pickups and vans. However, manufacturers would be required to obtain prior approval from the agencies before using analytically derived values. In addition, the agencies could conduct confirmatory testing or require a selective enforcement audit for any axle configuration. See 40 CFR 1037.235.

In addition to requiring the primary drive axle ratio input into GEM (and an option to input an actual axle power loss data table), we are requiring that the vehicle manufacturer input into GEM whether one or two drive axles are driven by the engine. When a heavy-duty vehicle is equipped with two rear

axles where both are driven by the engine, this is called a "6×4" configuration. "6" refers to the total number of wheel hubs on the vehicle. In the 6×4 configuration there are two front wheel hubs for the two steer wheels and tires plus four rear wheel hubs for the four rear wheels and tires (or more commonly four *sets* of rear dual wheels and tires). "4" refers to the number of wheel hubs driven by the engine. These are the two rear axles that have two wheel hubs each. Compared to a 6×4 configuration, a 6×2 configuration decreases axle energy loss due to friction and oil churning in two driven axles, by driving only one axle. The decrease in fuel consumption and CO<sub>2</sub> emissions associated with a 6×2 versus 6×4 axle configuration can be in the range of 2.5 percent depending on specific axles, which is modeled by the power loss table.<sup>166</sup> Therefore, in the Phase 2 version of GEM, if a manufacturer simulates a 6×2 axle configuration using the default axle efficiencies, GEM decreases the overall GEM result roughly by 2.5 percent on average through the power loss table. Note that GEM will similarly decrease the overall GEM result by 2.5 percent for a 4×2 tractor or Class 8 vocational chassis configuration if it has only two wheel hubs driven. If a manufacturer does not use the default efficiencies, the benefit of 6×2 and 4×2 configurations will be reflected directly in its input tables. Note that the Phase 2 version of GEM does not have an option to simulate more than two drive axles or configurations where the front axle(s) are driven or where there are more than two rear axles. The regulations specify that such vehicles are to be simulated as 6×4 vehicles in GEM. This is consistent with how the standards were developed and the agencies believe this approach will provide the appropriate incentive for manufacturers to apply the same fuel saving technologies to these vehicles, as they would to their conventional 6×4 vehicles. Moreover, because these configurations are manufactured for specialized vehicles that require extra traction for off-road applications, they have very low sales volume and any increased fuel consumption and CO<sub>2</sub> emissions from them are not significant in comparison to the overall reductions of the Phase 2 program. Note that 40 CFR 1037.631 (for off-road vocational vehicles), which is being continued from the Phase 1 program, exempts many of these vehicles from the vehicle

standards because they are limited mechanically to low-speed operation.

(d) Simulating Accessories for Vehicle Certification

The agencies proposed to continue the approach from Phase 1 whereby GEM uses a fixed power consumption value to simulate the fuel consumed for powering accessories such as steering pumps and alternators. 80 FR 40186. The final rule continues the Phase 1 approach, as proposed. However, Phase 2 GEM provides an option to provide a GEM input reflecting technology improvement inputs for the accessory loads. This allows the manufacturers to receive credit for those technologies that are not modeled in GEM. Manufacturers seeking credit for those technologies that are not modeled in GEM would generally follow the off-cycle credit program procedures in 40 CFR 1037.610.

(e) Aerodynamics in GEM for Tractor, Vocational Vehicle, and Trailer Certification

Phase 2 GEM simulates aerodynamic drag in using C<sub>d</sub>A (the product of the drag coefficient and frontal area of the vehicle) rather than a drag coefficient (C<sub>d</sub>). For tractors and trailers we will continue to use an aerodynamic bin approach similar to the one that exists in Phase 1 today, although the actual Phase 2 bins are being revised to reflect new test procedures and our projections for more aerodynamic tractors and trailers in the future. This approach allows manufacturers to determine C<sub>d</sub>A (or delta-C<sub>d</sub>A in the case of trailers) from coastdown testing, scale wind tunnel testing and/or computational fluid dynamics modeling. It requires tractor manufacturers (but not trailer manufacturers) to conduct a certain minimum amount of coast-down vehicle testing to validate their methods. The regulations also provide an alternate path for trailer manufacturers to rely on testing performed by component suppliers. See 40 CFR 1037.

The results of these tests determine into which bin a tractor or trailer is assigned. GEM uses the aerodynamic drag coefficient applicable to the bin, which is the same for all tractors (or trailers) within a given bin. This approach helps to account for limits in the repeatability of aerodynamic testing and it creates a compliance margin since any test result which keeps the vehicle in the same aerodynamic bin is considered compliant. For Phase 2 we are establishing new boundary values for the bins themselves and we are adding two additional tractor bins in order to recognize further advances in

<sup>166</sup> NACFE, Executive Report—6×2 (Dead Axle) Tractors, November 2010. See Docket EPA-HQ-OAR-2014-0827.

aerodynamic drag reduction beyond what was recognized in Phase 1. Furthermore, while Phase 1 GEM used predefined frontal areas for tractors where the manufacturers input only a  $C_d$  value, manufacturers will use a measured drag area ( $C_dA$ ) value for each tractor configuration for Phase 2. See 40 CFR 1037.525. The agencies do not project that vocational vehicles will need to improve their aerodynamic performance to comply with the Phase 2 vocational chassis standards.

However, the agencies are providing features in GEM for vocational vehicles to receive credit for improving the aerodynamics of vocational vehicles (see 40 CFR 1037.520(m)).

In addition to these changes, we are making a number of aerodynamic drag test procedure improvements. One improvement is to update the “standard trailer” that is prescribed for use during aerodynamic drag testing of a tractor. Using the  $C_dA$  from such testing means the standard trailer would also be the hypothetical trailer modeled in GEM to represent a trailer paired with the tractor in actual use.<sup>167</sup> In Phase 1, a non-aerodynamic 53-foot long box-shaped dry van trailer was specified as the standard trailer for tractor aerodynamic testing (see 40 CFR 1037.501(g)). For Phase 2 we are modifying this standard trailer for tractor testing to make it more similar to the trailers we expect to be produced during the Phase 2 timeframe. More specifically, we are prescribing the installation of aerodynamic trailer skirts (and low rolling resistance tires as applied in Phase 1) on the standard trailer, as discussed in further in Section III.E.2. As explained more fully in Sections III and IV, the agencies believe that tractor-trailer pairings will be optimized aerodynamically to a significant extent in-use (such as using high-roof cabs when pulling box trailers), and that this real-world optimization should be reflected in the certification testing. We are also revising the test procedures to better account for average wind yaw angle to reflect the true impact of aerodynamic features on the in-use fuel consumption and CO<sub>2</sub> emissions of tractors, again as discussed in more detail in Section III below. Refer to the test procedures in 40 CFR 1037.525 through 1037.527 for further details of these aerodynamic test procedures.

For trailer certification, the agencies use GEM in a different way than it is used for tractor certification. As

described in Section IV, the agencies developed a simple equation to replicate GEM performance. The trailer standards are based on this equation, and trailer manufacturers use this GEM-based equation for certification. The only technologies recognized by this GEM-based equation for trailer certification are aerodynamic technologies, tire technologies (including tire rolling resistance and tire pressure systems), and weight reduction. Note that since the purpose of this equation is to replicate GEM performance, it can be considered as simply another form of the model using a different input interface. Thus, for simplicity, the remainder of this Section II.C. sometimes discusses GEM as being used for trailers, without regard to how manufacturers will actually input GEM variables. As with all of the standards in Phase 2, compliance is measured consistent with the same test methods used by the agencies to establish the standard.

Similar to tractor certification, trailer manufacturers will use data from aerodynamic testing (*e.g.*, coastdown testing, scale wind tunnel testing, computational fluid dynamics modeling, or possibly aerodynamic component testing) with the equation.<sup>168</sup> As part of the protocol for generating these inputs, the agencies are specifying the configuration of a reference tractor for conducting trailer testing. Refer to Section IV of this Preamble and to 40 CFR 1037.501 of the regulations for details on the reference tractor configuration for trailer test procedures.

Finally, GEM has been modified to accept an optional delta  $C_dA$  value for vocational chassis, to simulate aerodynamic improvements relative to pre-specified baseline defined in Chapter 4 of RIA. For example, a manufacturer that demonstrates that adding side skirts to a box truck reduces its  $C_dA$  by 0.2 m<sup>2</sup> could input that value into GEM for box trucks that include those skirts. See 40 CFR 1037.520(m).

#### (f) Tires and Tire Inflation Systems for Truck and Trailer Certification

For GEM in Phase 1 tractor and vocational chassis manufacturers input the tire rolling resistance of steer and drive tires directly into GEM. The agencies prescribed an internationally recognized tire rolling resistance test procedure, ISO 28580, for determining the tire rolling resistance value that is

input into GEM, as described in 40 CFR 1037.520(c). For Phase 2 we will continue this same approach and the use of ISO 28580, and we are expanding these requirements to trailer tires as well.

In addition to tire rolling resistance, Phase 2 vehicle manufacturers will enter into GEM the tire manufacturer's specified revolutions per distance directly (revs/mile) for the vehicle's drive tires. This value is commonly reported by tire manufacturers already so that vehicle speedometers can be adjusted appropriately. This input value is needed so that GEM can accurately convert simulated vehicle speed into axle speed, transmission speed, and ultimately engine speed.

For tractors and trailers, we proposed to allow manufacturers to specify whether or not an automatic tire inflation system (ATIS) is installed. 80 FR 40187. Based on comments and as discussed further in Sections III, IV, and V, in the Phase 2 final rule we are adopting provisions that allow manufacturers of tractors, trailers, and vocational vehicle chassis to input a percent decrease in overall fuel consumption and CO<sub>2</sub> emissions into GEM if the vehicle includes either an ATIS or a tire pressure monitoring system (TPMS). The value that can be input depends on whether a TPMS or ATIS is deployed. See 40 CFR 1037.520.

#### (g) Weight Reduction for Tractor, Vocational Chassis and Trailer Certification

Phase 2 GEM continues the weight reduction recognition approach in Phase 1, where the agencies prescribe fixed weight reductions, or “deltas,” for using certain lightweight materials for certain vehicle components. In Phase 1 the agencies published a list of weight reductions for using high-strength steel and aluminum materials on a part by part basis. For Phase 2 we use updated values for high-strength steel and aluminum parts for tractors and for trailers and we have scaled these values for use in certifying the different weight classes of vocational chassis. In addition we use a similar part by part weight reduction list for tractor parts made from thermoplastic material. We proposed to assign a fixed weight increase to natural gas fueled vehicles to reflect the weight increase of natural gas fuel tanks versus gasoline or diesel tanks, but we are not finalizing that provision based on comments. 80 FR 40187. Commenters opposing this provision generally noted that the proposed provision was not consistent with how the agencies were treating other technologies. We agree that

<sup>167</sup> See Section III. for a discussion of how GEM will model a more advanced trailer beginning with the 2027 model year.

<sup>168</sup> The agencies project that more than enough aerodynamic component vendors will take advantage of proposed optional pre-approval process to make testing optional for trailer manufacturer.

natural gas vehicles should be treated consistently with other technologies and so are not adopting the proposed provision.

For tractors, we will continue the same mathematical approach in GEM to assign  $\frac{1}{3}$  of a total weight decrease to a payload increase and  $\frac{2}{3}$  of the total weight decrease to a vehicle mass decrease. For Phase 1, these ratios were based on the average frequency that a tractor operates at its gross combined weight rating. We will also use these ratios for trailers in Phase 2. For vocational chassis, for which Phase 1 did not address weight reduction, we will assign  $\frac{1}{2}$  of a total weight decrease to a payload increase and  $\frac{1}{2}$  of the total weight decrease to a vehicle mass decrease.

#### (h) GEM Duty Cycles for Tractor, Vocational Chassis and Trailer Certification

In Phase 1, there are three GEM vehicle duty cycles that represent stop-and-go city driving (ARB Transient), urban highway driving (55 mph), and rural interstate highway driving (65 mph). In Phase 1 these cycles were time-based. That is, they were specified as a function of simulated time and the duty cycles ended once the specified time elapsed in simulation. The agencies proposed to continue to use these three drive cycles in Phase 2, but with some revisions. 80 FR 40187. We are finalizing revisions similar but not identical to those that were proposed. First, GEM will simulate these cycles on a distance-based specification, rather than on a time-based specification. A distance-based specification ensures that even if a vehicle in simulation does not always achieve the target vehicle speed, the vehicle will have to continue in simulation for a longer period to complete the duty cycle. This ensures that vehicles are evaluated over the complete distance of the duty cycle and not just the portion of the duty cycle that a vehicle completes in a given time period. A distance-based duty cycle specification also facilitates a straightforward specification of road grade as a function of distance along the duty cycle. As noted in above, for Phase 2, the agencies have enhanced the 55 mph and 65 mph duty cycles by adding representative road grade to exercise the simulated vehicle's engine, transmission, axle, and tires in a more realistic way. A flat road grade profile over a constant speed test does not properly simulate a transmission with respect to shifting gears, and may have the unintended consequence of enabling underpowered vehicles or excessively down-spiced drivetrains to generate

credits, when in actuality the engine does not remain down-spiced in-use when the vehicle encounters road grades. The road grade profile being finalized is the same hill and valley profile for both the 55 mph and 65 mph duty cycles, and is based on statistical analysis of the United States' national distribution of road grades. Although the final profile is different than that proposed, the agencies provided notice of the analysis that was used to generate the final profile.<sup>169</sup> In written comments, we received in-use engine data from some manufacturers, and based on this information we made minor adjustments to the road grade to ensure that engines simulated in GEM operated similarly to that reported in the in-use engine data submitted to us. See Section III.E.(2)(b) of this document and Chapter 3.4.2.1 of the RIA for more details on development of the road grade profile. We believe that the enhancement of the 55 mph and 65 mph duty cycles with road grade is consistent with the NAS recommendation regarding road grade.<sup>170</sup>

#### (i) Workday Idle Operation for Vocational Chassis Certification

In the Phase 1 program, reduction in idle emissions was recognized only for sleeper cab tractors, and only with respect to hoteling idle, where a driver needs power to operate heating, ventilation, air conditioning and other electrical equipment in order to use the sleeper cab to eat, rest, or conduct other business. As described in Section V, GEM for Phase 2 will recognize technologies that reduce workday idle emissions, such as automatic stop-start systems, daytime parked idle automatic engine shutdown systems, and

<sup>169</sup> See National Renewable Energy Laboratory report "EPA GHG Certification of Medium- and Heavy-Duty Vehicles: Development of Road Grade Profiles Representative of US Controlled Access Highways" dated May 2015 and EPA memorandum "Development of an Alternative, Nationally Representative, Activity Weighted Road Grade Profile for Use in EPA GHG Certification of Medium- and Heavy-Duty Vehicles" dated May 13, 2015, both available in Docket EPA-HQ-OAR-2014-0827. This docket also includes file NREL\_SyntheticAndLocalGradeProfiles.xlsx which contains numerical representations of all road grade profiles described in the NREL report.

<sup>170</sup> NAS 2010 Report, Page 189. "A fundamental concern raised by the committee and those who testified during our public sessions was the tension between the need to set a uniform test cycle for regulatory purposes, and existing industry practices of seeking to minimize the fuel consumption of medium and heavy-duty vehicles designed for specific routes that may include grades, loads, work tasks or speeds inconsistent with the regulatory test cycle. This highlights the critical importance of achieving fidelity between certification values and real-world results to avoid decisions that hurt rather than help real-world fuel consumption."

transmissions that either automatically or inherently shift to neutral at idle while in drive. Many vocational vehicle applications operate on patterns implicating workday idle cycles, and the agencies use test procedures in GEM to account specifically for these cycles and potential idle controls. GEM will recognize these idle controls in two ways. For technologies like neutral-idle transmissions and stop-start systems that address idle that occurs during vehicle operation when the vehicle is stopped at a stop light, GEM will interpolate lower fuel rates from the engine map during the idle portions of the ARB Transient and during a separate GEM "drive idle cycle." For technologies like start-stop and auto-shutdown that eliminate some of the idle that occurs when a vehicle is stopped or parked, GEM will assign a value of zero fuel rate during a separate GEM "parked idle cycle." The idle cycles will be weighted along with the 65 mph, 55 mph, and ARB Transient duty cycles, according to the new vocational chassis duty cycle weighting factors. These weighting factors are different for each of the three vocational chassis speed categories for Phase 2. For tractors, only neutral idle and hotel idle will be addressed in GEM.

#### (2) Experimental Validation of GEM

The core simulation algorithms in GEM have not changed significantly since the proposal. Most of the changes since proposal focused on streamlining how manufacturers input data into GEM; revising to the drive cycles in GEM; and updating how GEM weights these different drive cycles to determine a composite fuel consumption value. These changes did not alter the fundamental way that GEM simulates varying vehicle "road load" and how GEM converts vehicle speed to engine speed and then interpolates engine maps to determine vehicle fuel consumption and CO<sub>2</sub> emissions.

Refinements to GEM since the time of proposal that did alter GEM's simulation performance include modifying the default transmissions' shift strategies and their power losses. Another key refinement was cycle average mapping engines for simulation of the ARB Transient cycle. Each time the agencies made such modifications to GEM, GEM's correlation to the agencies collection of laboratory-generated engine and vehicle data was checked. Potential refinements to GEM were accepted if GEM's correlation was improved versus this set of experimental data. If potential refinements resulted in GEM's correlation to the experimental data

becoming worse, those potential changes were rejected. Chapter 4.3.2 of the RIA details the GEM validation that was performed to determine if potential changes to GEM should be accepted or rejected. The first step of the validation process involves simulating vehicles in GEM using engine fuel maps and transmission shifting strategies obtained from manufacturers and comparing GEM results to experiments conducted with the same engines and transmissions. This first step re-validates all of the non-powertrain elements of GEM, which were already validated in Phase 1. The second step is to use GEM's default transmissions' shift strategies in simulation<sup>171</sup> and then compare GEM results to powertrain tests of several transmissions. The only difference between the first and second step is the shifting strategy and powertrain energy loss assumptions. This step facilitates tuning of GEM's default transmission models so that they correlate well to a variety of real transmissions. The third step is to compare GEM simulations to real-world in-use recorded data from actual vehicles. This is the most challenging step because the experimental data

includes real-world effects of wind, road grade, and driver behavior in traffic. The most important element of this third step is not *absolute* correlation, but rather, *relative* correlation, which demonstrates that when a technology is added to a real vehicle, the relative improvement in the real world is simulated in GEM with a high degree of correlation.

In the first validation step, the agencies compared GEM to over 130 vehicle variants, consistent with the recommendation made by the NAS in their Phase 2-First Report.<sup>172</sup> As described in Chapter 4 of the RIA, good agreement was observed between GEM simulations and test data over a wide range of vehicles. In general, the model simulations agreed with experimental test results within  $\pm 5$  percent on an absolute basis. As pointed out in Chapter 4.3.2 of the RIA, relative accuracy is more relevant to the intent of this rulemaking, which is to accelerate the adoption of *additional* fuel efficiency improving technologies. Consistent with the intent of this rulemaking, all of the numeric standards for tractors, trailers and vocational chassis are derived from running GEM

first with Phase 1 "baseline" technology packages and then with various Phase 2 technology packages. The differences between these GEM results are examined to determine final stringencies. In other words, the agencies used the same final version of GEM to establish the numeric standards as will be used by manufacturers to demonstrate compliance. Therefore, it is most important that GEM accurately reflects *relative* changes in emissions for each added technology. In other words, for vehicle certification purposes it is less important that GEM's absolute value of the fuel consumption or CO<sub>2</sub> emissions be accurate compared to laboratory testing of the same vehicle. The ultimate purpose of GEM is to evaluate *changes* or *additions* in technology, and compliance is demonstrated on a relative basis to the numeric standards that were also derived from GEM. Nevertheless, the agencies concluded that the absolute accuracy of GEM is generally within  $\pm 5$  percent, as shown in Figure II.2. Chapter 4.3.2 of the RIA shows that *relative* accuracy is even better,  $\pm 2-3$  percent.

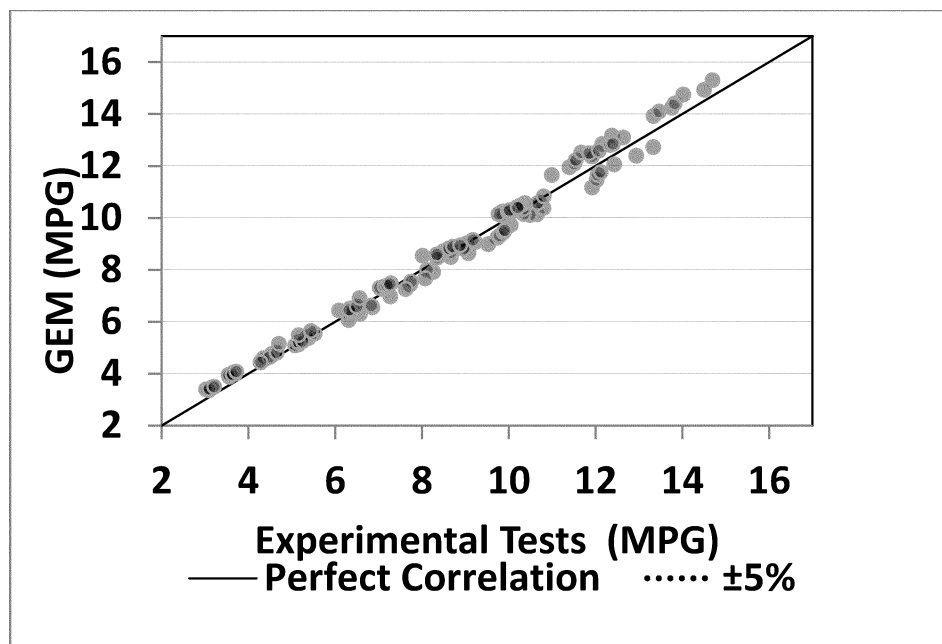

Figure II.2 GEM Validation Data

<sup>171</sup> K. Newman, J. Kargul, and D. Barba, "Development and Testing of an Automatic Transmission Shift Schedule Algorithm for Vehicle

Simulation," *SAE Int. J. Engines* 8(3):2015, doi:10.4271/2015-01-1142.

<sup>172</sup> National Academy of Science. "Reducing the Fuel Consumption and GHG Emissions of Medium- and Heavy-Duty Vehicles, Phase Two, First Report." 2014. Recommendation 1.2.

In addition to this successful validation against experimental results, the agencies have also conducted a peer review of the GEM source code. This peer review has been submitted to Docket number EPA-HQ-OAR-2014-0827.

The second validation step was to repeat the first step's GEM simulations with the agencies' default transmission shift strategies.<sup>171</sup> It was expected that GEM's absolute accuracy would decrease because these shift strategies were tuned for best average performance and for a particular transmission. Nevertheless, it was shown that relative accuracy did not suffer; therefore, the agencies deemed the GEM default shift strategies acceptable for GEM certification purposes. Further details of this validation step are presented in Chapter 4.3.2.3 of the RIA and in a SwRI final report.<sup>162</sup>

As explained above and in Chapter 4.3.2.3 of the RIA, it is challenging to achieve absolute correlation between any computer simulation and real-world vehicle operation. Therefore, the agencies focused on relative comparisons. Following the SAE standard procedure SAE J1321 "Type II," two trucks have been tested and these real-world results were compared to GEM simulations. In summary, the relative comparisons between GEM simulations and the real-world testing of trucks showed a 2.4 percent difference. The details of this testing and correlation analysis is presented in Chapter 4.3.2.3 of the RIA.

In conclusion, the agencies completed a number of validation steps to ensure that GEM demonstrates a reasonable degree of absolute accuracy, but more importantly a high degree of relative accuracy, versus both laboratory and real-world experimental data.

### (3) Supplements to GEM Simulation

As in Phase 1, for most tractors and vocational vehicles, compliance with the Phase 2 g/ton-mile vehicle standards could be evaluated by directly comparing the GEM result to the standard. However, in Phase 1, manufacturers incorporating innovative or advanced technologies could apply improvement factors to lower the GEM result before comparing to the standard.<sup>173</sup> For example, a manufacturer incorporating a launch-assist mild hybrid that was pre-approved for a 5 percent benefit would apply a 0.95 improvement factor to its GEM results for such vehicles. In this

example, a GEM result of 300 g/ton-mile will be reduced to 285 g/ton-mile.

For Phase 2, the agencies largely continue the existing Phase 1 innovative technology approach, but we name it "off-cycle" to better reflect its purpose.

#### (a) Off-Cycle Technology Procedures

In Phase 1 the agencies adopted an emissions credit generating opportunity that applied to new and innovative technologies that reduce fuel consumption and CO<sub>2</sub> emissions, which were not in common use with heavy-duty vehicles before model year 2010 and are not reflected over the test procedures or GEM (*i.e.*, the benefits are "off-cycle"). See 76 FR 57253. As was the case in the development of Phase 1, the agencies continue this approach for technologies and concepts with CO<sub>2</sub> emissions and fuel consumption reduction potential that might not be adequately captured over the Phase 2 duty cycles or are not inputs to GEM. Note, however, that the agencies now refer to these technologies as off-cycle rather than innovative. Comments were generally supportive of continuing this provision. See Section I.C(1)(c) of this document and Section 1 of the RTC for more discussion of innovative and off-cycle technologies.

We recognize that the Phase 1 testing burden associated with the innovative technology credit provisions discouraged some manufacturers from applying. To streamline recognition of many technologies, default values have been integrated directly into GEM. For example, automatic tire inflation systems have fixed default values, and such technologies are now recognized through a post-simulation adjustment approach, discussed in Chapter 4 of the RIA. This is similar to the technology "pick list" from our light-duty programs. See 77 FR 62833–62835 (October 15, 2012). If manufacturers wish to receive additional credit beyond these fixed values, then the off-cycle technology credit provisions provide a regulatory path toward that additional recognition.

Beyond the additional technologies that the agencies have added to GEM, the agencies also believe there are several emerging technologies that are being developed today, but will not be accounted for in GEM because we do not have enough information about these technologies to assign fixed values to them in GEM. Any credits for these technologies will need to be based on the off-cycle technology credit generation provisions. These require the assessment of real-world fuel consumption and GHG reductions that can be measured with verifiable test

methods using representative operating conditions typical of the engine or vehicle application.

As in Phase 1, the agencies continue to provide two paths for approval of the test procedure to measure the CO<sub>2</sub> emissions and fuel consumption reductions of an off-cycle technology used in the HD tractor. See 40 CFR 1037.610 and 49 CFR 535.7. The first path does not require a public approval process of the test method. A manufacturer can use "pre-approved" test methods for HD vehicles including the A-to-B chassis testing, powertrain testing or on-road testing. A manufacturer may also use any developed test procedure which has known quantifiable benefits. A test plan detailing the testing methodology is required to be approved by the agencies prior to collecting any test data. The agencies will also continue the second path which includes a public approval process of any testing method which could have uncertain benefits (*i.e.*, an unknown usage rate for a technology). Furthermore, the agencies are modifying our provisions to better clarify the documentation required to be submitted for approval aligning them with provisions in 40 CFR 86.1869–12, and NHTSA separately prohibits credits from technologies addressed by any of its crash avoidance safety rulemakings (*i.e.*, congestion management systems).

Sections III and V separately describe tractor and vocational vehicle technologies, respectively, that the agencies anticipate may qualify for these off-cycle credit provisions.

#### (4) Production Vehicle Testing for Comparison to GEM

As described in Section III.E.(2)(j), The agencies are requiring tractor manufacturers to annually chassis test five production vehicles over the GEM cycles to verify that relative reductions simulated in GEM are being achieved in production. See 40 CFR 1037.665. We do not expect absolute correlation between GEM results and chassis testing. GEM makes many simplifying assumptions that do not compromise its usefulness for certification, but do cause it to produce emission rates different from what would be measured during a chassis dynamometer test. Given the limits of correlation possible between GEM and chassis testing, we would not expect such testing to accurately reflect whether a vehicle was compliant with the GEM standards. Therefore, we are not applying GHG compliance liability to such testing. Rather, this testing will be for data collection and informational purposes only. The agencies will continue to evaluate in-use compliance

<sup>173</sup> 40 CFR 1036.610, 1036.615, 1037.610, and 1037.615.



by verifying GEM inputs and testing in-use engines. (Note that NTE standards for criteria pollutants may apply for some portion of the test cycles.)

#### (5) Use of GEM in Establishing the Phase 2 Numerical Standards

As in Phase 1, the agencies are setting specific numerical standards against which tractors and vocational vehicles will be certified using GEM (box trailers will use a GEM-based equation, and some trailers and custom chassis vocational vehicles may optionally use a non-GEM certification path). Although these standards are performance-based standards, which do not specifically require the use of any particular technologies,<sup>174</sup> the agencies established these standards by evaluating specific vehicle technology packages using the final version of Phase 2 GEM. We note that that this means the final numerical standards are not directly comparable to the proposed standards, which were based on an intermediate version of GEM, rather than on the final version.

#### (a) Relation to In-Use Emissions

The purpose of this rulemaking is to achieve in-use emission and fuel consumption reductions by requiring manufacturers to demonstrate that they meet the promulgated emission standards. Thus, it is important that GEM simulations be reasonably representative of in-use operation. Testing that is unrepresentative of actual in-use operation does not necessarily tell us anything about whether any emission reductions occur. However, we recognize that certain simplifications are necessary for practical simulations. In the past, EPA has addressed this issue by including in our testing regulations a process by which EPA can work with manufacturers to adjust test procedures to make them more representative of in-use operation. For engine testing, this provision is in 40 CFR 1065.10(c)(1), where EPA requires manufacturers to notify us in cases in which they determine that the specified test procedures would result in measurements that do not represent in-use operation.

Although we are not adopting an equivalent provision for GEM at this time, we expect similar principles to apply. To the extent that GEM fails to represent in-use emission, we would expect to work with manufacturers to address the issue—under the existing regulations where possible, or by promulgating a new rulemaking.

We recognize that many compromises must be made between the practicality of testing/simulation and the matching of in-use operation. We have considered many aspects of the test procedures in this respect for the engines, vehicles, and emission controls of which we are currently aware. We have concluded that the procedures will generally result in emission simulations that are sufficiently representative of in-use emissions, even though not all in-use operation will occur during simulation. Nevertheless, we have identified several areas that deserve some additional discussion.

GEM is structured to simulate a single vehicle weight (curb weight plus payload) per regulatory subcategory. However, we know that actual in-use weights will rarely be exactly the same as the simulated weights. Nevertheless, since the representativeness of the simulated weights (or lack thereof) is being fully considered in the setting of the standards, there would be no need to modify the procedures to account for different curb weights or payloads.

GEM simulates vehicle emissions over three drive cycles plus two idle cycles, and weights the cycle results based on the type of vehicle being certified. These cycles and weightings reflect *fleet average* driving patterns and the agencies do not expect them to fully match driving patterns for *individual* vehicles. Thus, we would generally not consider GEM's cycles as unrepresentative for vehicles with different in-use driving patterns. However, if new information became available that demonstrated that GEM's cycles somehow did not reflect fleet average driving patterns, the agencies would consider such information in the context of the principles of representative testing, described above.

Finally, GEM includes default values for axle and transmission efficiency derived from baseline technologies. However, we generally expect manufacturers to use more efficient axles and transmissions for Phase 2 vehicles. As noted above, based on comments, the agencies are allowing manufacturers to optionally input measured efficiencies to better represent these more efficient technologies. We would not consider GEM unrepresentative if manufacturers chose to use the default values rather than measure these efficiencies directly.

#### (b) Relation to Powertrain Testing

As already noted, GEM correlates very well with powertrain testing. To the extent they differ, it would be expected to be primarily related to how transmission performance is modeled in

GEM. Although GEM includes a sophisticated model of transmissions, it cannot represent a transmission better than a powertrain test of the same transmission. Thus, the agencies consider powertrain testing to be as good as or better than GEM run using engine-only fuel maps; hence the provision in the final rules allowing results from powertrain testing to be used as a GEM input.

In some respects, powertrain testing can be considered to be a reference method for this rulemaking. Because manufacturers have the option to perform powertrain testing instead of engine-only fuel mapping, the stringency of the final standards can be traced to powertrain testing. In other words, methods that can be shown to be equivalent to powertrain testing can be considered to be consistent with the testing that was used as the basis of the final Phase 2 standards.

In a related context, it may be useful in the future to consider equivalency to powertrain testing as an appropriate criterion for evaluating changes to GEM to address new technologies. Consider, for example, a new technology that is not represented in GEM, but that is reflected in powertrain testing. The agencies could determine that it would be appropriate to modify GEM to reflect the technology rather than to require manufacturers to perform powertrain testing. In such a case, the agencies would not consider the modification to GEM to impact the effective stringency of the Phase 2 standards because the new version of GEM would be equivalent to performing powertrain testing.

#### D. Engine Test Procedures and Engine Standards

In addition to the Phase 1 GEM-based vehicle certification of tractors and vocational chassis, the agencies also set Phase 1 separate CO<sub>2</sub> and fuel efficiency standards for the engines installed in tractors and vocational chassis. EPA also set Phase 1 separate engine standards for capping methane (CH<sub>4</sub>) and nitrous oxide (N<sub>2</sub>O) emissions (essentially capping emissions at current emission levels). Compliance with all of these Phase 1 separate engine standards is demonstrated by measuring these emissions during an engine dynamometer test procedure. For Phase 1 the agencies use the same test procedure specified for EPA's existing heavy-duty engine emissions standards (e.g., NO<sub>x</sub> and PM standards). These Phase 1 engine standards are specified in terms of brake-specific (g/bhp-hr) fuel, CO<sub>2</sub>, CH<sub>4</sub> and N<sub>2</sub>O emissions limits. Since the test procedure already

<sup>174</sup> The sole exception being the design-based standards for non-aero and partial aero trailers.

specified how to measure fuel consumption, CO<sub>2</sub> and CH<sub>4</sub>, few changes were needed to utilize the test procedure for Phase 1, the most notable change being a modification specifying how to measure N<sub>2</sub>O.

There are some differences in how these non-GHG test procedures are applied in Phase 1 and Phase 2. In EPA's non-GHG engine emissions standards, heavy-duty engines must meet brake-specific standards for emissions of total oxides of nitrogen (NO<sub>x</sub>), particulate mass (PM), non-methane hydrocarbon (NMHC), and carbon monoxide (CO). These standards must be met by all engines both over a 13-mode steady-state duty cycle called the "Supplemental Emissions Test" (SET)<sup>175</sup> and over a composite of a cold-start and a hot-start transient duty cycle called the "Federal Test Procedure" (FTP). In contrast, for Phase 1 the agencies require that engines specifically installed in tractors meet fuel efficiency and CO<sub>2</sub> standards over only the SET but not the composite FTP. This requirement was intended to reflect that tractor engines typically operate near steady-state conditions versus transient conditions. See 76 FR 57159. For Phase 2 the agencies are finalizing, as proposed, slight changes to the 13-modes' weighting factors to better reflect in-use engine operation. These weighting factors apply only for determining SET fuel consumption and CO<sub>2</sub> emissions. No changes are being made to the weighting factors for EPA's non-GHG emission standards. The agencies adopted the converse for engines installed in vocational vehicles. That is, these engines must meet fuel efficiency and CO<sub>2</sub> standards over the composite FTP but not the SET. This requirement was intended to reflect that vocational vehicle engines typically operate under transient conditions versus steady-state conditions (76 FR 57178). For both tractor and vocational vehicle engines in Phase 1, EPA set CH<sub>4</sub> and N<sub>2</sub>O emissions cap standards over the composite FTP only and not over the SET duty cycle. See Section II.D. for details on this final action's engine test procedures for Phase 2.

In response to the agencies' proposed engine standards, we received a number of public comments. The agencies considered those comments, and the following list summarizes key changes we've made in response, and more detailed descriptions of these changes are presented in Chapter 2.7 of the RIA:

<sup>175</sup> The SET cycle is also referred to as the "ramped-modal cycle" because, for criteria pollutants, it is performed as a continuous cycle with ramped transitions between the individual modes of the SET.

- Recalculated the SET baseline using the new Phase 2 SET weighting factors.
- Recalculated the FTP baseline, based on MY 2016 FTP certification data from Cummins, DTNA, Volvo, Navistar, Hino, Isuzu, Ford, GM and FCA. These included HHD, MHD, and LHD engines.
- Projected how manufacturers would modify maximum fuel rates as a function of speed to strategically relocate SET mode points to achieve lowest SET results.
- Projected a higher market penetration of WHR in 2027, versus what we proposed.
- Decreased our projected impact of engine technology dis-synergies by increasing the magnitude of our so-called "dis-synergy factors;" accounting for these changes by increasing the research and development costs needed for this additional optimization.

The following section first describes the engine test procedures used to certify engines to the Phase 2 separate engine standards. Sections that follow describe the Phase 2 CO<sub>2</sub>, N<sub>2</sub>O and CH<sub>4</sub> separate engine standards and their feasibility.

(1) Engine Test Procedures

(a) SET Cycle Weighting

The SET cycle was adopted by EPA in 2000 and modified in 2005 from a discrete-mode test to a ramped-modal cycle to broadly cover the most significant part of the speed and torque map for heavy-duty engines, defined by three non-idle speeds and three relative torques. The low speed is called the "A speed," the intermediate speed is called the "B speed," and the high speed is called the "C speed." As is shown in Table II-1, the SET cumulatively weights these three speeds at 23 percent, 39 percent, and 23 percent.

TABLE II-1—SET MODES WEIGHTING FACTOR IN PHASE 1

Speed, % Load	Weighting factor in Phase 1 (%)
Idle .....	15
A, 100 .....	8
B, 50 .....	10
B, 75 .....	10
A, 50 .....	5
A, 75 .....	5
A, 25 .....	5
B, 100 .....	9
B, 25 .....	10
C, 100 .....	8
C, 25 .....	5
C, 75 .....	5
C, 50 .....	5
Total .....	100

TABLE II-1—SET MODES WEIGHTING FACTOR IN PHASE 1—Continued

Speed, % Load	Weighting factor in Phase 1 (%)
Cumulative A Speed .....	23
Cumulative B Speed .....	39
Cumulative C Speed .....	23

The C speed is typically in the range of 1800 rpm for current heavy heavy-duty engine designs. However, it is becoming much less common for engines to operate at such a high speeds in real-world driving conditions, and especially not during cruise vehicle speeds in the 55 to 65 mph vehicle speed range. This trend has been corroborated by engine manufacturers' in-use data that has been submitted to the agencies in comments and presented at technical conferences.<sup>176</sup> Thus, although the current SET represents highway operation better than the FTP cycle, it could be improved by adjusting its weighting factors to better reflect modern trends in in-use engine operation. Furthermore, the most recent trends indicate that manufacturers are configuring drivetrains to operate engines at speeds down to a range of 1050–1200 rpm at a vehicle speed of 65 mph.

To address this trend toward in-use engine down-speeding, the agencies are finalizing as proposed refined SET weighting factors for the Phase 2 CO<sub>2</sub> emission and fuel consumption standards. The new SET mode weightings move most of the C weighting to "A" speed, as shown in Table II-2. To better align with in-use data, these changes also include a reduction of the idle speed weighting factor. These new mode weightings do not apply to criteria pollutants or to the Phase 1 CO<sub>2</sub> emission and fuel consumption standards.

TABLE II-2—NEW SET MODES WEIGHTING FACTOR IN PHASE 2

Speed/% load	Weighting factor in Phase 2 (%)
Idle .....	12
A, 100 .....	9
B, 50 .....	10
B, 75 .....	10
A, 50 .....	12
A, 75 .....	12
A, 25 .....	12
B, 100 .....	9

<sup>176</sup> "OEM perspective—Meeting EPA/NHTSA GHG/Efficiency Standards", 7th Integer Emissions Summit USA 2014, Volvo Group North America.

TABLE II-2—NEW SET MODES WEIGHTING FACTOR IN PHASE 2—Continued

Speed/% load	Weighting factor in Phase 2 (%)
B, 25 .....	9
C, 100 .....	2
C, 25 .....	1
C, 75 .....	1
C, 50 .....	1
Total .....	100
Total A Speed .....	45
Total B Speed .....	38
Total C Speed .....	5

(b) Engine Test Provisions for SET, FTP, and Engine Mapping for GEM Inputs

Although GEM does not apply directly to engine certification, Phase 2 will require engine manufacturers to generate and certify full load and motoring torque curves and engine fuel rate maps for input into GEM for tractor and vocational chassis manufacturers to demonstrate compliance to their respective standards. The full load and motoring torque curve procedures were previously defined in 40 CFR part 1065, and these are already required for non-GHG emissions certification. The Phase 2 final default test procedure for generating an engine map for GEM’s 55 mph and 65 mph drive cycles is the “steady-state” mapping procedure. However, the agencies are finalizing an option for manufacturers to use the “cycle average” mapping procedure for GEM’s 55 mph and 65 mph drive cycles. The test procedure for generating an engine map for GEM’s ARB Transient drive cycle is the “cycle-average” mapping procedure, and the agencies are not finalizing any other mapping options for the ARB Transient drive cycle. Note that if an engine manufacturer elects to conduct powertrain testing to generate inputs for GEM, then steady-state and cycle-average engine maps would not be required for those GEM vehicle configurations to which the powertrain test inputs would apply. The steady-state and cycle-average test procedures are specified in 40 CFR parts 1036 and 1065. The technical and confidential business information motivations for finalizing these test procedures are explained in II. B. (2), along with a summary of comments we received.

One important consideration is the need to correct measured fuel consumption rates for the carbon and energy content of the test fuel. As proposed, we will continue the Phase 1 approach, which is specified in 40 CFR

1036.530. We are specifying a similar approach to GEM fuel maps in Phase 2.

As proposed, the agencies are requiring that engine manufacturers certify fuel maps for GEM, as part of their certification to the engine standards. However, there were a number of manufacturer comments strongly questioning the particular proposed requirement that engine manufacturers provide these maps to vehicle manufacturers starting in MY 2020 for the certification of vehicles commercially marketed as MY 2021 vehicles in calendar year 2020. This is a normal engine and vehicle manufacturing process, where many vehicles may be produced with engines having an earlier model year than the commercial model year of the vehicle. For example, we expect that some MY 2021 vehicles will be produced with MY 2020 engines. Thus, we proposed to require engine manufacturers to begin providing GEM fuel maps for MY 2020 engines so that vehicle manufacturers could run GEM to certify MY 2021 vehicles with MY 2020 engines. EMA and some of its members commented that MY 2020 engines should not be subject to Phase 2 requirements, based on NHTSA’s statutory 4-year lead-time requirement and because the potential higher fuel consumption of MY 2020 (i.e., Phase 1) engine maps could force vehicle manufacturers to install additional technologies that were not projected by the agencies for compliance. The agencies considered these comments along with the potential cost savings for manufacturers to align the timing of both their engines’ and vehicle’s Phase 2 product plans and certification paths. The agencies also considered how this situation would repeat in MY 2024 and MY 2027 and possibly with future standards as well. Based on these considerations, we have decided that it would be more appropriate to harmonize the engine and vehicle standards, starting in MY 2021 so that vehicle manufacturers will not need fuel maps for 2020 engines. Thus, we are not finalizing the requirement to provide fuel maps for MY 2020 engines. However, we are requiring fuel maps for all MY 2021 engines, even those (e.g., small businesses) for which the Phase 2 engine and vehicle standards have been delayed. See 40 CFR 1036.150.

The current engine test procedures also require the development of regeneration emission rate and frequency factors to determine infrequent regeneration adjustment factors (IRAFs) that account for the emission changes for *criteria* pollutants during an exhaust emissions control

system regeneration event. In Phase 1 the agencies adopted provisions to exclude CO<sub>2</sub> emissions and fuel consumption due to regeneration. However, for Phase 2, we are requiring the inclusion of CO<sub>2</sub> emissions and fuel consumption due to regeneration over the FTP and SET (RMC) cycles, as determined using the IRAF provisions in 40 CFR 1065.680. While some commenters opposed this because of its potential impact on stringency, we do not believe this will significantly impact the stringency of these standards because manufacturers have already made great progress in reducing the frequency and impact of regeneration emissions since 2007. Rather, the agencies are including IRAF CO<sub>2</sub> emissions for Phase 2 to prevent these emissions from increasing in the future to the point where they would otherwise become significant. Manufacturers qualitatively acknowledged the likely already small and decreasing magnitude of IRAF CO<sub>2</sub> emissions in their comments. For example, EMA stated, “the rates of infrequent regenerations have been going down since the adoption of the Phase 1 standards” and that IRAF “contributions are minor.” Nevertheless, we believe it is prudent to begin accounting for regeneration emissions to discourage manufacturers from adopting criteria emissions compliance strategies that could reverse this trend. Manufacturers expressed concern about the additional test burden, but the only additional requirement would be to measure and report CO<sub>2</sub> emissions for the same tests they are already performing to determine IRAFs for other pollutants.

At the time of the proposal, we did not specifically adjust baseline levels to include additional IRAF emissions because we believed them to be negligible and decreasing. Commenters opposing this proposed provision provided no data to dispute this belief. We continue to believe that regeneration strategies can be engineered to maintain these negligible rates. Thus, we do not believe they are of fundamental significance for our baselines in the FRM. Highway operation includes enough high temperature operation to make active regenerations unnecessary. Furthermore, recent improvements in exhaust after-treatment catalyst formulations and exhaust temperature thermal management strategies, such as intake air throttling, minimize CO<sub>2</sub> IRAF impacts during non-highway operation, where active regeneration might be required. Finally, as is discussed in Section II.D.(2), recent significant

efficiency improvements over the FTP cycle suggest that FTP emissions may actually be even lower than we have estimated in our updated FTP baselines, which would provide additional margin for manufacturers to manage any minor CO<sub>2</sub> IRAF impacts that may occur.

We are not including fuel consumption due to after-treatment regeneration in the creation of fuel maps used in GEM for vehicle compliance. We believe that the IRAF requirements for the separate SET and FTP engine standards, along with market forces that already exist to minimize regeneration events, will create sufficient incentives to reduce fuel consumption during regeneration over the entire fuel map.

#### (c) Powertrain Testing

The agencies are finalizing a powertrain test option to afford a robust mechanism to quantify the benefits of CO<sub>2</sub> reducing technologies that are a part of the powertrain (conventional or hybrid), that are not captured in the GEM simulation. Among these technologies are integrated engine and transmission control and hybrid systems. We are finalizing a number of improvements to the test procedure in 40 CFR 1037.550. As proposed we are finalizing the requirement for Phase 2 hybrid powertrains to mapped using this powertrain test method. The agencies are also finalizing modifications to 40 CFR 1037.550 to separate out the hybrid specific testing protocols.

To limit the amount of testing under this rule, powertrains can be divided into families and are tested in a limited number of simulated vehicles that will cover the range of vehicles in which the powertrain will be used. A matrix of 8 to 9 tests will be needed per vehicle cycle, to enable the use of the powertrain results broadly across all the vehicles in which the powertrain will be installed. The individual tests differ by the vehicle that is being simulated during the test. These are discussed in detail in Chapter 3.6 of the RIA.

#### (i) Powertrain Test Procedure

The agencies are expanding upon the test procedures defined 40 CFR 1037.550 for Phase 1 hybrid vehicles. The Phase 2 expansion will migrate the current Phase 1 test procedure to a new 40 CFR 1037.555 and will modify the current test procedure in 40 CFR 1037.550, allowing its use for Phase 2 only. The Phase 2 modifications relative to 40 CFR 1037.550 include the addition of the rotating inertia of the driveline and tires, and the axle efficiency. This revised procedure also requires that each of the powertrain components be

cooled so that the temperature of each of the components is kept in the normal operation range. We are extending the powertrain procedure to PHEV powertrains.

Powertrain testing contains many of the same requirements as engine dynamometer testing. The main differences are where the test article connects to the dynamometer and the software that is used to command the dynamometer and operator demand setpoints. The powertrain procedure finalized in Phase 2 allows for the dynamometer(s) to be connected to the powertrain either upstream of the drive axle or at the wheel hubs. The output of the transmission is upstream of the drive axle for conventional powertrains. In addition to the transmission, a hydraulic pump or an electric motor in the case of a series hybrid may be located upstream of the drive axle for hybrid powertrains. If optional testing with the wheel hub is used, two dynamometers will be needed, one at each hub. Beyond these points, the only other difference between powertrain testing and engine testing is that for powertrains, the dynamometer and throttle setpoints are not set by fixed speed and torque targets prescribed by the cycle, but are calculated in real time by the vehicle model. The powertrain test procedure requires a forward calculating vehicle model, thus the output of the model is the dynamometer speed setpoints. The vehicle model calculates the speed target using the measured torque at the previous time step, the simulated brake force from the driver model, and the vehicle parameters (tire rolling resistance, drag area, vehicle mass, rotating mass, and axle efficiency). The operator demand that is used to change the torque from the engine is controlled such that the powertrain follows the vehicle speed target for the cycle instead of being controlled to match the torque or speed setpoints of the cycle. The emission measurement procedures and calculations are identical to engine testing.

#### (ii) Engine Test Procedures for Replicating Powertrain Tests

As described in Section II.B.(2)(b), the agencies are finalizing the proposed powertrain test option to quantify the benefits of CO<sub>2</sub>-reducing powertrain technologies. This option is very similar to the cycle average mapping approach, although these powertrain test results would be used to override both the engine and transmission (and possibly axle) simulation portions of GEM, not just the engine fuel map. The agencies are requiring that any manufacturer

choosing to use this option also measure engine speed and engine torque during the powertrain test so that the engine's performance during the powertrain test could be replicated in a non-powertrain engine test cell. Manufacturers would be required to measure or calculate, using good engineering judgment, the engine shaft output torque, which would be close-coupled to the transmission input shaft during a powertrain test. Subsequent engine testing then could be conducted using the normal part 1065 engine test procedures as specified in 40 CFR 1037.551, and g/bhp-hr CO<sub>2</sub> results could be compared to the levels the manufacturer reported during certification. Such testing could apply for both confirmatory and selective enforcement audit (SEA) testing. This would simplify both the certification and SEA testing.

As proposed, engine manufacturers certifying powertrain performance (instead of or in addition to the multi-point fuel maps) will be held responsible for powertrain test results. If the engine manufacturer does not certify powertrain performance and instead certifies only the steady-state and/or cycle-average fuel maps, it will be held responsible for fuel map performance rather than the powertrain test results. Engine manufacturers certifying both will be responsible for both.

Some commenters objected to the potential liability for such engine-only tests. However, it appears they do not understand our intent. This provision states clearly that this approach could be used only where "the test engine's operation represents the engine operation observed in the powertrain test." Also, since the manufacturers perform all SEA testing themselves, this would be an option for the manufacturer rather than something imposed by EPA. Thus, this concern should be limited to the narrow circumstance in which EPA performs confirmatory engine testing of an engine that was certified using powertrain testing, follows the manufacturer's specified engine test cycle, and ensures that the test accurately represents the engine's performance during the powertrain test. However, it is not clear why this would be problematic. It is entirely reasonable to assume that testing the engine in this way would result in equivalent emission results. To the extent manufacturer concerns remain, each manufacturer would be free to certify their engines based on engine-only fuel maps rather than powertrain testing.

#### (d) CO<sub>2</sub> From Urea SCR Systems

For diesel engines utilizing urea SCR emission control systems for NO<sub>x</sub>

reduction, the agencies will allow, but not require, correction of the final engine (and powertrain) fuel maps to account for the contribution of CO<sub>2</sub> from the urea injected into the exhaust. This urea typically contributes 0.2 to 0.5 percent of the total CO<sub>2</sub> emissions measured from the engine, and up to 1 percent at certain map points. Since current urea production methods use gaseous CO<sub>2</sub> captured from the atmosphere (along with NH<sub>3</sub>), CO<sub>2</sub> emissions from urea consumption does not represent a net carbon emission. This adjustment is necessary so that fuel maps developed from CO<sub>2</sub> measurements will be consistent with fuel maps from direct measurements of fuel flow rates. This adjustment is also necessary to fully align EPA's CO<sub>2</sub> standards with NHTSA's fuel consumption standards. Failing to account for urea CO<sub>2</sub> tailpipe emissions would result in reporting higher fuel consumption than what was actually

consumed. Thus, we are only allowing this correction for emission tests where CO<sub>2</sub> emissions are determined from direct measurement of CO<sub>2</sub> and not from fuel flow measurement, which would not be impacted by CO<sub>2</sub> from urea.

We note that this correction will be voluntary for manufacturers, and we expect that some manufacturers may determine that the correction is too small to be of concern. The agencies will use this correction for CO<sub>2</sub> measurements with any engines for which the engine manufacturer applied the correction for its fuel maps during certification.

We are not allowing this correction for engine test results with respect to the engine CO<sub>2</sub> standards. Both the Phase 1 standards and the new standards for CO<sub>2</sub> from diesel engines are based on test results that included CO<sub>2</sub> from urea. In other words, these standards are consistent with using a test procedure that does not correct for CO<sub>2</sub> from urea.

(2) Engine Standards for CO<sub>2</sub> and Fuel Consumption

We are largely maintaining the existing Phase 1 regulatory structure for engine standards, which had separate standards for spark-ignition engines (such as gasoline engines) and compression-ignition engines (such as diesel engines), and for HHD, MHD and LHD engines, but we are changing how these standards will apply to alternative fuel engines as described in Section XII.A.2.

Phase 1 applied different test cycles depending on whether the engine is used for tractors, vocational vehicles, or both, and we are continuing this approach. Tractor engines are subject to standards over the SET, while vocational engines are subject to standards over the FTP. Table II-3 shows the Phase 1 standards for diesel engines.

TABLE II-3—PHASE 1 MY 2017 DIESEL ENGINE CO<sub>2</sub> AND FUEL CONSUMPTION STANDARDS

Units	HHD SET	MHD SET	HHD FTP	MHD FTP	LHD FTP
g/bhp-hr .....	460	487	555	576	576
gal/100 bhp-hr .....	4.5187	4.7839	5.4519	5.6582	5.6582

In the Phase 2 proposal we assumed that these numeric values of the Phase 1 standards were the baselines for Phase 2. We applied our technology assessments to these baselines to arrive at the Phase 2 standards for MY 2021, MY 2024 and MY 2027. In other words, for the Phase 2 proposal we projected that starting in MY 2017 engines would, on average, just meet the Phase 1 standards and not over-comply. However, based on comments we received on how to consistently apply our new SET weighting factors in our analysis and based on recent MY 2016 engine certification data, we are updating our Phase 2 baseline assumptions for both the SET and FTP.

First, with respect to the SET, in the proposal we compared our proposed Phase 2 standards, which are based on these new Phase 2 weighting factors, to the Phase 1 numeric standards, which are based on the current Phase 1 weighting factors. Because we continue to use the same 13-mode brake specific CO<sub>2</sub> and fuel consumption numeric values we used for the proposal to represent the performance of a MY 2017 baseline engine, we are not projecting a different technology level in the baseline. Rather, this is simply correcting an “apples-to-oranges” comparison from the proposal by applying the Phase 2 weighting factors

to the MY 2017 baseline engine. This was pointed out to us by UCS, ICCT and EDF in their public comments. While this did not impact our technology effectiveness or cost analyses, it did impact the numeric value of our baseline to which we reference the effectiveness of applying technologies to the 13 individual modes of the SET. Because the revised SET weighting factors result in somewhat lower brake specific CO<sub>2</sub> and fuel consumption numeric results for the composite baseline SET value, this correction, in turn, lowers the numerical values of the final Phase 2 SET standards. Making this particular update did not result in a change to the relative stringency of the final Phase 2 numeric engine standards (relative to MY 2017 baseline performance), but our updated feasibility analysis did; see Section II.D.(2)(a) below).

Second, the agencies made adjustments to the FTP baselines, but these adjustments were not made because of a calculation error. Rather, MY 2016 FTP certification data showed an unexpected step-change improvement in engine fuel consumption and CO<sub>2</sub> emissions. These data were not available at the time of proposal, so the agencies relied upon the MY 2017 Phase 1 standard as a baseline. EDF publicly commented in

response to the NODA that the more recent certification data revealed this new step-change. MY 2016 certification data submitted to the agencies<sup>177</sup> as well as to ARB<sup>178</sup> show that many engines from many manufacturers already not only achieve the Phase 1 FTP standards, but some were also below the MY 2027 standards proposed for Phase 2. This was not the case for the SET, where most manufacturers are still not yet complying with the MY 2017 Phase 1 SET standards. In view of this situation for the FTP, the agencies are adjusting the Phase 2 FTP baseline to reflect this shift. The underlying reasons for this shift are mostly related to manufacturers optimizing their SCR thermal management strategy over the FTP in ways that we (mistakenly) thought they already had in MY 2010 (*i.e.*, the Phase 1 baseline). As background, the FTP includes a cold-start, a hot-start and significant time spent at engine idle. During these portions of the FTP, the NO<sub>x</sub> SCR system can cool down and lose NO<sub>x</sub> reducing efficiency. One simplistic strategy to maintain SCR temperature is to inefficiently consume additional fuel, such that the fuel energy is lost to the

<sup>177</sup> <https://www3.epa.gov/otaq/certdata.htm#oh>.

<sup>178</sup> <http://www.arb.ca.gov/msprog/onroad/cert/mdehdhdv/2016/2016.php>.

exhaust system in the form of heat. There are more sophisticated strategies to maintain SCR temperature, however, but these apparently required additional time from MY 2010 for research, development and refinement. In updating these baseline values, the agencies did consider the concerns raised by manufacturers about the potential impact of IRAFs on baseline emissions.

As just noted, at the time of Phase 1 we had not realized that these improvements were not already in the Phase 1 baseline. These include optimizing the use of an intake throttle to decrease excess intake air at idle and SCR catalyst reformulation to maintain SCR efficiency at lower temperatures.

Based on this information, which was provided to the agencies by engine manufacturers, but only after we specifically requested this information, the agencies concluded that in Phase 1 we did not account for how much further these kinds of improvements could still impact FTP fuel consumption. Conversely, only by reviewing the new MY 2016 certification data did we realize how little SCR thermal management optimization actually occurred for the engine model years that we used to establish the Phase 1 baseline—namely MY 2009 and MY 2010 engines. Because we never accounted for this kind of improvement in our Phase 2 proposal’s stringency analysis for meeting the

Phase 2 proposed FTP standards, this baseline shift does not alter our projected effectiveness and market adoption rates from the proposal. Therefore, we continue to apply the same improvements that we proposed, but we apply them to the updated FTP baseline. See Section II.D.(5) for a discussion on how this impacts carry-over of Phase 1 emission credits.

Table II–4 shows the Phase 2 diesel engine final CO<sub>2</sub> baseline emissions. Note that the gasoline engine CO<sub>2</sub> baseline for Phase 2 is the same as the Phase 1 HD gasoline FTP standard, 627 g/bhp-hr. More detailed analyses on these Phase 2 baseline values of tractor and vocational vehicles can be found in Chapter 2.7.4 of RIA.

TABLE II–4—PHASE 2 DIESEL ENGINE FINAL CO<sub>2</sub> AND FUEL CONSUMPTION BASELINE EMISSIONS

Units	HHD SET	MHD SET	HHD FTP	MHD FTP	LHD FTP
g/bhp-hr .....	455	481	525	558	576
gal/100 bhp-hr .....	4.4695	4.7250	5.1572	5.4813	5.6582

As described below, the agencies are adopting standards for new compression-ignition engines for Phase 2, commencing in MY 2021, that will require additional reductions in CO<sub>2</sub> emissions and fuel consumption beyond the Phase 2 baselines. The agencies are not adopting new CO<sub>2</sub> or fuel consumption engine standards for new heavy-duty gasoline engines. Note, however, that we are projecting some small improvement in gasoline engine

performance that will be recognized over the vehicle cycles (that is, reflected in the stringency of certain of the vocational vehicle standards). See Section V.B.2.a below.

For diesel engines to be installed in Class 7 and 8 combination tractors, the agencies are adopting the SET standards shown in Table II–5.<sup>179</sup> The MY 2027 SET standards for engines installed in tractors will require engine manufacturers to achieve, on average, a

5.1 percent reduction in fuel consumption and CO<sub>2</sub> emissions beyond the Phase 2 baselines. We are also adopting SET standards in MY 2021 and MY 2024 that will require tractor engine manufacturers to achieve, on average, 1.8 percent and 4.2 percent reductions in fuel consumption and CO<sub>2</sub> emissions, respectively, beyond the Phase 2 baselines.

TABLE II–5—PHASE 2 HEAVY-DUTY TRACTOR ENGINE STANDARDS FOR ENGINES <sup>180</sup> OVER THE SET CYCLE

Model year	Standard	Heavy heavy-duty	Medium heavy-duty
2021–2023 .....	CO <sub>2</sub> (g/bhp-hr) .....	447	473
	Fuel Consumption (gallon/100 bhp-hr) .....	4.3910	4.6464
2024–2026 .....	CO <sub>2</sub> (g/bhp-hr) .....	436	461
	Fuel Consumption (gallon/100 bhp-hr) .....	4.2829	4.5285
2027 and Later .....	CO <sub>2</sub> (g/bhp-hr) .....	432	457
	Fuel Consumption (gallon/100 bhp-hr) .....	4.2436	4.4892

For diesel engines to be installed in vocational chassis, the agencies are adopting the FTP standards shown in Table II–6. The MY 2027 FTP standards for engines installed in vocational chassis will require engine

manufacturers to achieve, on average, a 4.2 percent reduction in fuel consumption and CO<sub>2</sub> emissions beyond the Phase 2 baselines. We are also adopting FTP standards in MY 2021 and MY 2024 that will require vocational

chassis engine manufacturers to achieve, on average, 2.3 percent and 3.6 percent reductions in fuel consumption and CO<sub>2</sub> emissions, respectively, beyond the Phase 2 baselines.

<sup>179</sup> The agencies note that the CO<sub>2</sub> and fuel consumption standards for Class 7 and 8 combination tractors do not cover gasoline or LHDD

engines, as those are not used in Class 7 and 8 combination tractors.

<sup>180</sup> Tractor engine standards apply to all tractor engines, without regard to the actual fuel (e.g.,

diesel or natural gas) or engine-cycle classification (e.g., compression-ignition or spark-ignition).

TABLE II-6—VOCATIONAL DIESEL (CI) ENGINE STANDARDS OVER THE HEAVY-DUTY FTP CYCLE

Model year	Standard	Heavy heavy-duty <sup>181</sup>	Medium heavy-duty diesel <sup>181</sup>	Light heavy-duty diesel <sup>182</sup>
2021–2023 .....	CO <sub>2</sub> (g/bhp-hr) .....	513	545	563
	Fuel Consumption (gallon/100 bhp-hr) .....	5.0393	5.3536	5.5305
2024–2026 .....	CO <sub>2</sub> (g/bhp-hr) .....	506	538	555
	Fuel Consumption (gallon/100 bhp-hr) .....	4.9705	5.2849	5.4519
2027 and Later .....	CO <sub>2</sub> (g/bhp-hr) .....	503	535	552
	Fuel Consumption (gallon/100 bhp-hr) .....	4.9411	5.2554	5.4224

(a) Feasibility of the Diesel (Compression-Ignition) Engine Standards

In this section, the agencies discuss our assessment of the feasibility of the engine standards and the extent to which they conform to our respective statutory authorities and responsibilities. More details on the technologies discussed here can be found in RIA Chapter 2.3. The feasibility of these standards is further discussed in RIA Chapter 2.7 for tractor and vocational vehicle engines. While the projected technologies are discussed here separately, as is discussed at the beginning of this Section II.D, the agencies also accounted for dis-synergies between technologies. Note that Section II.D.(2)(e) discusses the potential for some manufacturers to achieve greater emission reductions by introducing new engine platforms, and how and why these reductions are reflected in the tractor and vocational vehicle standards.

Based on the technology analysis described below, the agencies project that a technology path exists that will allow engine manufacturers to meet the final Phase 2 standards by 2027, and to meet the MY 2021 and 2024 standards. The agencies also project that these manufacturers will be able to meet these standards at a reasonable cost and without adverse impacts on in-use reliability.

In general, engine performance for CO<sub>2</sub> emissions and fuel consumption can be improved by improving the internal combustion process and by reducing energy losses. More specifically, the agencies have identified the following key means by which fuel efficiency can be improved:

- Combustion optimization
- Turbocharger design and optimization
  - Engine friction and other parasitic loss reduction
  - Exhaust after-treatment pressure drop reduction
  - Intake air and exhaust system pressure drop reduction (including EGR system)
  - Engine down-sizing to improve core engine efficiency
  - Engine down-speeding over the SET, and in-use, by lug curve shape optimization
  - Waste heat recovery system installation and optimization
  - Physics model based electronic controls for transient performance optimization

The agencies are gradually phasing in the separate engine standards from 2021 through 2027 so that manufacturers can gradually introduce these technology improvements. For most of these, the agencies project manufacturers could begin applying these technologies to about 45–50 percent of their heavy-duty engines by 2021, 90–95 percent by 2024, and ultimately apply them to 100 percent of their heavy-duty engines by 2027. However, for some of these improvements (such as waste heat recovery and engine downsizing) we project lower application rates in the Phase 2 time frame. This phase-in structure is consistent with the normal manner in which manufacturers introduce new technology to manage limited R&D budgets as well as to allow them to work with fleets to fully evaluate in-use reliability before a technology is applied fleet-wide. The agencies believe the phase-in schedule will allow manufacturers to complete these normal processes. See RIA 2.3.9.

Based on our technology assessment described below, the engine standards appear to be consistent with the agencies' respective statutory authorities. All of the technologies with high penetration rates above 50 percent have already been demonstrated to some extent in the field or in research laboratories, although some development work remains to be

completed. We note that our feasibility analysis for these engine standards is not based on projecting 100 percent application for any technology until 2027. We believe that projecting less than 100 percent application is appropriate and gives us additional confidence that the 2021 and 2024 MY standards are feasible.

Because this analysis considers reductions from engines meeting the Phase 1 standards, it assumes manufacturers will continue to include the same compliance margins as in Phase 1. In other words, a manufacturer currently declaring FCLs 10 g/bhp-hr above its measured emission rates (in order to account for production and test-to-test variability) will continue to do the same in Phase 2. Both the costs and benefits are determined relative to these baselines, and so are reflective of these compliance margins.

The agencies have carefully considered the costs of applying these technologies, which are summarized in Section II.D.(2)(d). These costs appear to be reasonable on both a per engine basis, and when considering payback periods.<sup>183</sup> The engine technologies are discussed in more detail below. Readers are encouraged to see the RIA Chapter 2.7 for additional details (and underlying references) about our feasibility analysis.

(i) Combustion Optimization

Although manufacturers are making significant improvements in combustion to meet the Phase 1 engine standards, the agencies project that even more improvement is possible after 2018. For example, improvements to fuel injection systems will allow more flexible fuel injection capability with higher injection pressure, which can provide more opportunities to improve engine fuel efficiency. Further optimization of piston bowls and injector tips will also improve engine performance and fuel efficiency. We project that a reduction of up to 1.0 percent is feasible in the 2024 model year through the use of

<sup>183</sup> See Section IX.M for additional information about payback periods.

<sup>181</sup> Heavy heavy-duty engine standards apply to all heavy heavy-duty engines, without regard to the actual fuel (e.g., diesel or natural gas) or engine-cycle classification (e.g., compression-ignition or spark-ignition).

<sup>182</sup> The agencies are not adopting new CO<sub>2</sub> or fuel consumption engine standards for new heavy-duty gasoline engines. Therefore, the Phase 2 HD gasoline FTP standard is the same as the Phase 1 HD gasoline FTP standard, 627 g/bhp-hr, 7.0552 gallon/100 bhp-hr.



these technologies, although it will likely apply to only 95 percent of engines until 2027.

Another important area of potential improvement is advanced engine control incorporating model based calibration to reduce losses of control during transient operation. Improvements in computing power and speed will make it possible to use much more sophisticated algorithms that are more predictive than today's controls. Because such controls are only beneficial during transient operation, they will reduce emissions over the FTP cycle, over the ARB Transient cycle's cycle-average mapping procedure, and during in-use operation, but this technology will not reduce emissions over the SET cycle or over the steady-state engine mapping procedure. Thus, the agencies are projecting model based control reductions only for vocational engines' FTP standards and for projecting improvements captured by the cycle-average mapping over the ARB Transient cycle. Although this control concept is not currently available and is still under development, we project model based controls achieving a 2 percent improvement in transient emissions. Based on model based controls already in widespread use in engine laboratories for the calibration of simpler controllers and based on recent model based control development under the DOE SuperTruck partnership (*e.g.*, DTNA's SuperTruck engine's model based controls), we project that such controls could be in limited production for some engine models by 2021. We believe that some vocational chassis applications would particularly benefit from these controls in-use (*e.g.*, urban applications with significant in-use transient operation). Therefore, we project that a modest amount of engine models will have these controls by MY 2021. We also project that manufacturers will learn more from the in-use operation of these technology leading engines, and manufacturers will be able to improve these controls even further, such that they would additionally benefit other vocational applications, such as multi-purpose and regional applications. By 2027, we project that 40 percent of all vocational diesel engines will incorporate model-based controls at a 2 percent level of effectiveness.

#### (ii) Turbocharger System

Many advanced turbocharger technologies can be brought into production in the time frame between 2021 and 2027, and some of them are already in production, such as mechanical or electric turbo-

compounding, more efficient variable geometry turbines, and Detroit Diesel's patented asymmetric turbocharger. A turbo-compound system, like those installed on some of Volvo's EURO VI compliant diesels and on some of DTNA's current U.S. offerings (supplied to DTNA by a division of Cummins), extracts energy from the exhaust to provide additional power. Mechanical turbo-compounding includes a power turbine located downstream of the turbine which in turn is connected to the crankshaft to supply additional power. On-highway demonstrations of this technology began in the early 1980s. It was used first in heavy duty production in the U.S. by Detroit Diesel for their DD15 and DD16 engines and reportedly provided a 3 to 5 percent fuel consumption reduction. Results are duty cycle dependent, and require significant time at high load to realize an in-use fuel efficiency improvement. Lightly loaded vehicles on flat roads or at low vehicle speeds can expect little or no benefit. Volvo reports two to four percent fuel consumption improvement in line haul applications.<sup>184</sup> Because of turbo-compound technology's drive cycle dependent effectiveness, the agencies are only projecting a market penetration of 10 percent for all tractor engines, at slightly less than 2 percent effectiveness over the SET. The agencies are considering turbo-compound to be mutually exclusive with WHR because both technologies seek to extract additional usable work from the same waste heat and are unlikely to be used together.

#### (iii) Engine Friction and Parasitic Losses

The friction associated with each moving part in an engine results in a small loss of engine power. For example, frictional losses occur at bearings, in the valve train, and at the piston ring-cylinder interface. Taken together such losses represent a measurable fraction of all energy lost in an engine. For Phase 1, the agencies projected a 1–2 percent reduction in fuel consumption due to friction reduction. However, new information leads us to project that an additional 1.4 percent reduction is possible for some engines by 2021 and all engines by 2027. These reductions are possible due to improvements in bearing materials, lubricants, and new accessory designs such as variable-speed pumps.

#### (iv) After-Treatment Optimization

All heavy duty diesel engine manufacturers are already using diesel particulate filters (DPFs) to reduce

particulate matter (PM) and selective catalytic reduction (SCR) to reduce NO<sub>x</sub> emissions. The agencies see two areas in which improved after-treatment systems can also result in lower fuel consumption. First, increased SCR efficiency could allow re-optimization of combustion for better fuel consumption because the SCR would be capable of reducing higher engine-out NO<sub>x</sub> emissions. We don't expect this to be significant, however. Manufacturers already optimize the DEF (urea) consumption and fuel consumption to achieve the lowest cost of operation; taking into account fuel consumption, DEF consumption and the prices of fuel and DEF. Therefore, if manufacturers re-optimized significantly for fuel consumption, it is possible that this would lead to higher net operating costs. This scenario is highly dependent upon fuel and DEF prices, so projecting this technology path is uncertain. Second, improved designs could reduce backpressure on the engine to lower pumping losses. If manufacturers have opportunities to lower backpressure within the size constraints of the vehicle, the agencies project that manufacturers will opt to lower after-treatment back pressure. The agencies project the combined impact of these improvements would be 0.6 percent over the SET.

Note that this improvement is independent of cold-start improvements made recently by some manufacturers with respect to vocational engines. Thus, the changes being made to the FTP baseline engines do not reduce the likelihood of the benefits of re-optimizing after-treatment projected here.

#### (v) Engine Intake and Exhaust Systems

Various high efficiency air handling for both intake air and exhaust systems could be produced in the 2020 and 2024 time frame. To maximize the efficiency of such processes, induction systems may be improved by manufacturing more efficiently designed flow paths (including those associated with air cleaners, chambers, conduit, mass air flow sensors and intake manifolds) and by designing such systems for improved thermal control. Improved turbocharging and air handling systems will likely include higher efficiency EGR systems and intercoolers that reduce frictional pressure losses while maximizing the ability to thermally control induction air and EGR. EGR systems that often rely upon an adverse pressure gradient (exhaust manifold pressures greater than intake manifold pressures) must be reconsidered and their adverse pressure gradients

<sup>184</sup> <http://www.volvotrucks.us/powertrain/d13/>.

minimized. Other components that offer opportunities for improved flow efficiency include cylinder heads, ports and exhaust manifolds to further reduce pumping losses by about 1 percent over the SET.

(vi) Engine Downsizing and Down Speeding

Proper sizing of an engine is an important component of optimizing a vehicle for best fuel consumption. This Phase 2 rule will require reductions in road load due to aerodynamic resistance, tire rolling resistance and weight, which will result in a drop in the vehicle power demand for most operation. This drop moves the engine operating points down to a lower load zone, which can move the engine away from operating near its peak thermal efficiency (a.k.a. the “sweet spot”). Engine downsizing combined with engine down speeding can allow the engine to move back to higher loads and a lower speed zone, thus achieving better fuel efficiency in the real world. However, because of the way engines are tested, little of the benefit of engine downsizing would be detected during engine testing (if power density remains the same) because the engine test cycles are de-normalized based on the full torque curve. Thus, the separate engine standards are not the appropriate standards for recognizing the benefits of engine downsizing. Nevertheless, we project that some small benefit can be measured over the engine test cycles depending on the characteristics of the engine fuel map and how the SET points are determined as a function of the engine’s lug curve.

After the proposal we received comments recommending that we should recognize some level of engine down speeding within the separate engine standards. Based on this comment and some additional confidential business information that we received, we believe that engine lug curve reshaping to optimize the locations of the 13-mode points is a way that manufacturers can demonstrate some degree of engine down-speeding over the engine test. As pointed out in Chapter 2.3.8 and 2.7.5 of the RIA, down speeding via lug curve reshaping alone can provide SET reductions in the range of 0.4 percent depending on the engine map characteristics.

(vii) Waste Heat Recovery

More than 40 percent of all energy loss in an engine is lost as heat to the exhaust and engine coolant. For many years, manufacturers have been using turbochargers to convert some of this waste heat in the exhaust into usable

mechanical power that is then used to compress the intake air. Manufacturers have also been developing a Rankine cycle-based system to extract additional heat energy from the engine. Such systems are often called waste heat recovery (WHR) systems. The possible sources of waste heat energy include the exhaust, recirculated exhaust gases, compressed charge air, and engine coolant. The basic approach with WHR is to use waste heat from one or more of these sources to evaporate a working fluid, which is passed through a turbine or equivalent expander to create mechanical or electrical power, then re-condensed.

For the proposal, the agencies projected that by 2027, 15 percent of tractor engines would employ WHR systems with an effectiveness of better than three percent. We received many comments on this projection, which are discussed briefly below and in more detail in the RTC. In particular, we note that some of the comments included confidential data related to systems not yet on the market. After carefully considering all of these comments, we have revised our projections to increase the effectiveness, decrease costs, and project higher adoption rates than we proposed.

Prior to the Phase 1 Final Rule, the NAS estimated the potential for WHR to reduce fuel consumption by up to 10 percent.<sup>185</sup> However, the agencies do not believe such levels will be achievable within the Phase 2 time frame. There currently are no commercially available WHR systems for diesel engines, although research prototype systems are being tested by some manufacturers. American Trucking Association, Navistar, DTNA, OOIDA, Volvo, and UPS commented that because WHR is still in the prototype stage, it should not be assumed for setting the stringency of the tractor engine standards. Many of these commenters pointed to the additional design and development efforts that will be needed to reduce cost, improve packaging, reduce weight, develop controls, select an appropriate working fluid, implement expected OBD diagnostics, and achieve the necessary reliability and durability. Some stated that the technology has not been thoroughly tested or asked that more real-world data be collected before setting standards based on WHR. Some of these commenters provided confidential business information pertaining to their analysis of WHR system component costs, failure modes,

and projected warranty cost information.

Alternatively, a number of commenters including Cummins, ICCT, CARB, ACEEE, EDF, Honeywell, ARB and others stated that the agencies should increase the assumed application rate of WHR in the final rule and the overall stringency of the engine standards. They argued the agencies’ WHR technology assessment was outdated and too conservative, the fuel savings and GHG reduction estimation for WHR were too low, and the agencies’ cost estimates were based on older WHR systems where costs were confounded with hybrid component costs and that these have since been improved upon. In addition, the agencies received CBI information supporting the arguments of some of these commenters.

Cummins stated the agencies underestimated the commercial viability of WHR and that we overstated the development challenges and timing in the NPRM. They said WHR can provide a 4 to 5 percent improvement in fuel consumption on tractor drive cycles and that WHR would be commercially viable and available in production as early as 2020 and will exceed the agencies’ estimates for market penetration over the period of the rule. According to Cummins, the reliability of their WHR system has improved with each generation of the technology and they have developed a smaller system footprint, improved integration with the engine and vehicle and a low-GWP working fluid, resulting in a much more compact and integrated system. They added that their system would be evaluated in extended customer testing by the end of 2015, and that results of that experience will inform further technology development and product engineering leading to expected commercial product availability in the 2020 timeframe. Furthermore, they said multiple product development cycles over the implementation timeframe of the rule would provide opportunities for further development for reduced cost and improved performance and reliability.

Some commenters, including EDF, said the agencies’ assumed design had little in common with the latest designs planned for production. They cited several publications, including the NAS 21st Century Truck Program report #3 and stated WHR effectiveness is much higher than the agencies estimated. Gentham cited an ICCT study saying that up to a 12 percent fuel consumption reduction from a 2010 baseline engine is possible with the application of advanced engine technologies and WHR.

<sup>185</sup> See 2010 NAS Report, page 57.

The agencies recognize that much work remains to be done, but we are providing significant lead time to bring WHR to market. Based on our assessment of each manufacturer's work to date, we are confident that a commercially-viable WHR capable of reducing fuel consumption by over three percent will be available in the 2021 to 2024 time frame. Concerns about the system's cost and complexity may remain high enough to limit the use of such systems in this time frame. Moreover, packaging constraints and lower effectiveness under transient conditions will likely limit the application of WHR systems to line-haul tractors. Refer to RIA Chapter 2.3.9 for a detailed description of these systems and their applicability. For our analysis of the engine standards, the agencies project that WHR with the Rankine technology could be used on 1 percent of tractor engines by 2021, on 5 percent by 2024, and 25 percent by 2027, with nearly all being used on sleeper cabs. We project this sharper increase in market adoption in the 2027 timeframe because we have noted that most technology adoption rate curves follow an S-shape: Slow initial adoption, then more rapid adoption, and then a leveling off as the market saturates (not always at 100 percent).<sup>186</sup> We assumed an S-shape curve for WHR adoption, where we project a steeper rise in market adoption in and around the 2027 timeframe. Given our averaging, banking and trading program flexibilities and that manufacturers may choose from a range of other technologies, we believe that manufacturers will be able to meet the 2027 standards, which we based on a 25 percent WHR adoption in tractor engines. Although we project these as steps, it is more likely that manufacturers will try to gradually increase the WHR adoption in MY 2025 and MY 2026 from the 5 percent in 2024 to generate emission credits to smooth the transition to the 2027 standards.

Commenters opposing the agencies' WHR projections argued that the real-world GHG and fuel consumption savings will be less than in prototype systems. DTNA said a heat rejection increase of 30 percent to 40 percent with WHR systems will require larger radiators, resulting in more aerodynamic drag and lower fuel savings from WHR systems. DTNA cited a Volvo study showing a 2 percent loss of efficiency with the larger frontal areas needed to accommodate heat rejection from WHR systems. Daimler stated effectiveness may be lower than expected since there is large drop off in

fuel savings when the tractor is not operating on a steady state cycle and the real world performance of WHR systems will be hurt by transient response issues. Daimler and ACEEE said the energy available from exhaust and other waste heat sources could diminish as tractor aerodynamics improve, thus lowering the expected fuel savings from WHR. Daimler said because of this, WHR estimated fuel savings was overestimated by the agencies. Navistar said WHR working fluids will have a significant GHG impact based on their high global warming potential. They commented that fuel and GHG reductions will be lower in the real world with the re-weighting of the RMC which results in lower engine load, and thus lower available waste heat. However, none of these commenters have access to the full range of data available to the agencies, which includes CBI.

It is important to note that the net cost and effectiveness of future WHR systems depends on the sources of waste heat. Systems that extract heat from EGR gases may provide the side benefit of reducing the size of EGR coolers or eliminating them altogether. To the extent that WHR systems use exhaust heat, they increase the overall cooling system heat rejection requirement and likely require larger radiators. This could have negative impacts on cooling fan power needs and vehicle aerodynamics. Limited engine compartment space under the hood could leave insufficient room for additional radiator size increasing. Many of these issues disappear if exhaust waste heat is not recovered from the tailpipe and brought under the hood for conversion to mechanical work. In fact, it is projected that if a WHR system only utilizes heat that was originally within the engine compartment (*e.g.*, EGR cooler heat, coolant heat, oil heat, etc.), then any conversion of that heat to mechanical heat actually reduces the heat rejection demand under the hood; potentially leading to smaller radiators and lower frontal area, which would actually lead toward improved aerodynamic performance. Refer to RIA Chapter 2.3.9 for more discussion.

Several commenters stated that costs are highly uncertain for WHR technology, but argued that the agencies' assumption of a \$10,523 cost in 2027 are likely significantly lower than reality. Volvo estimated a cost of \$21,700 for WHR systems. Volvo said that in addition to hardware cost being underestimated, the agencies had not properly accounted for other costs such as the R&D needed to bring the

technology into production within a vehicle. Volvo said they would lose \$17,920 per unit R&D alone, excluding other costs such as materials and administrative expenses. Daimler said that costs almost always inflate as the complexity of real world requirements drive up need for more robust designs, sensors, controls, control hardware, and complete vehicle integration. They added that development costs will be large and must be amortized over limited volumes. Furthermore, OOIDA said the industry experience with such complex systems is that maintenance, repair, and down-time cost can be much greater than the initial purchase cost. ATA and OOIDA said that potential downtime associated with an unproven technology is a significant concern for the industry.

On the other hand, some commenters argued that the agencies had actually overestimated WHR costs in the proposal. These commenters generally argued that engineering improvements to the WHR systems that will go into production in the Phase 2 time frame would lower costs, in particular by reducing components. The agencies largely agree with these commenters and we have revised our analysis to reflect these cost savings. See RIA 2.11.2.15 for additional discussion.

#### (viii) Technology Packages for Diesel Engines Installed in Tractors

This Section (a)(viii) describes technology packages that the agencies project could be applied to Phase 1 tractor engines to meet the Phase 2 SET separate engine standards. Section II.D.(2)(e) also describes additional improvements that the agencies project some engine manufacturers will be able to apply to their engines.

We received comments on the tractor engine standards in response to the proposal and in response to the NODA. These comments can be grouped into two general themes. One theme expressed by ARB, non-governmental environmentally focused organizations, Cummins and some technology suppliers like Honeywell, recommended higher engine stringencies, up to 10–15 percent in some comments. Another theme, generally expressed by vertically integrated engine and vehicle manufacturers supported either no Phase 2 engine standards at all, or they supported the proposal's standards, but none of these commenters supported standards that were more stringent than what we proposed. An example of the contrast between these two themes can be shown in one report submitted to the docket and another submission rebutting the statements made in the

<sup>186</sup> NACFE 2015 Annual Fleet Fuel Study.

report. The report was submitted to the agencies by the Environmental Defense Fund (EDF).<sup>187</sup> On the other hand, four vertically integrated engine and vehicle manufacturers, DTNA, Navistar, Paccar, and Volvo, submitted a rebuttal to EDF's findings.<sup>188</sup> Some of these individual vehicle manufacturers also provided their own comments on EDF's report.<sup>189</sup> Cummins also provided comments and recommended stringencies somewhere between EDF's recommendations and the integrated

manufacturers' rebuttal. Cummins recommended achieving reductions by 2030 in the range of 9–15 percent. CARB's recommendation from their comments<sup>191</sup> is 7.1 percent in 2024.

The agencies carefully considered this wide range of views, and based on the best data available, the agencies modified some of our technology projections between the proposal and the final rule.

Table II–5 lists our projected technologies together with our projected

effectiveness and market adoption rates for tractor engines. The reduction values shown as "SET reduction" are relative to our Phase 2 baseline values, as shown in Table II–7. It should be pointed out that the reductions in Table II–7 are based on the Phase 2 final SET weighting factors, shown in Table II–2. RIA Chapter 2.7.5 details the reasoning supporting our projection of improvements attributable to this fleet average technology package.

TABLE II–7—PROJECTED TRACTOR ENGINE TECHNOLOGIES AND REDUCTION

SET mode	SET weighted reduction (%) 2020–2027	Market penetration (2021) (%)	Market penetration (2024) (%)	Market penetration (2027) (%)
Turbo compound with clutch .....	1.9	5	10	10
WHR (Rankine cycle) .....	3.6	1	5	25
Parasitic/Friction (Cyl Kits, pumps, FIE), lubrication .....	1.5	45	95	100
After-treatment (lower dP) .....	0.6	30	95	100
EGR/intake & exhaust manifolds/Turbo/VVT/Ports .....	1.1	45	95	100
Combustion/FI/Control .....	1.1	45	95	100
Downsizing .....	0.3	10	20	30
Overall reductions (%)				
Weighted reduction (%) .....	.....	1.7	4.0	4.8
Down speeding optimization on SET .....	.....	0.1	0.2	0.3
Total % reduction .....	.....	1.8	4.2	5.1

The weighted reductions shown in this table have been combined using the "Π-formula," which has been augmented to account for technology dis-synergies that occur when combining multiple technologies. A 0.85 dis-synergy factor was used for 2021, and a 0.90 dis-synergy factor was used for 2024 and 2027.<sup>192</sup> RIA Chapter 2.7.4 provides details on the "Π-formula" and an explanation for how the dis-synergy factors were determined. Some commenters argued that use of a single dis-synergy factor for all technologies is inappropriate. While we

agree that it would be preferable to have a more detailed analysis of the dis-synergy between each pair or group of technologies, we do not have the information necessary to conduct such an analysis. In the absence of such information, the simple single value approach is a reasonable approximation. Moreover, we note that the degree of dis-synergy is sufficiently small to make the impact of any errors on the resulting standards negligible.

Figure II.3 2018 HHD Figure II.4 are the samples of the HHD engine fuel maps used for the agencies' MY 2018

baseline engine and MY 2027 sleeper cab engine for tractors. As can be seen from these two figures, the torque curve shapes are different. This is because engine down speeding optimization for the SET is taken into consideration, where the engine peak torque is increased and the engine speed is shifted to lower speed. All maps used by GEM for all vehicles are shown in Chapter 2.7 of the RIA.

<sup>187</sup> Environmental Defense Fund, Greenhouse Gas Emission and Fuel Efficiency Standards for Medium-Duty and Heavy-Duty Engines and Vehicles—Phase 2—Notice of Data Availability," Docket: ID No. EPA–HQ–OAR–2014–0817, October 1, 2015.

<sup>188</sup> Daimler Trucks North America, Navistar, Inc, Paccar Inc, and Volvo Group," Greenhouse Gas Emission and Fuel Efficiency Standards for Medium-Duty and Heavy-Duty Engines and Vehicles—Phase 2—Notice of Data Availability," Docket: ID No. EPA–HQ–OAR–2014–0817, April 1, 2016.

<sup>189</sup> Navistar, Inc., Greenhouse Gas Emission and Fuel Efficiency Standards for Medium-Duty and Heavy-Duty Engines and Vehicles—Phase 2—Notice of Data Availability," Docket: ID No. EPA–HQ–OAR–2014–0817, April 1, 2016.

<sup>190</sup> Daimler Trucks North America LLC, Detroit Diesel Corporation, Greenhouse Gas Emission and Fuel Efficiency Standards for Medium-Duty and Heavy-Duty Engines and Vehicles—Phase 2—Notice of Data Availability," Docket: ID No. EPA–HQ–OAR–2014–0817, April 1, 2016.

<sup>191</sup> California Air Resources Board (CARB), Greenhouse Gas Emissions and Fuel Efficiency Standards for Medium- and Heavy-Duty Engines and Vehicles—Phase 2 (Docket ID No. EPA–HQ–OAR–2014–0827 and Docket ID No. NHTSA–2014–0132).

<sup>192</sup> As used in the agencies' analyses, dis-synergy factors less than one reflect dis-synergy between technologies that reduce the overall effectiveness, while dis-synergy factors greater than one would indicate synergy that improves the overall effectiveness.

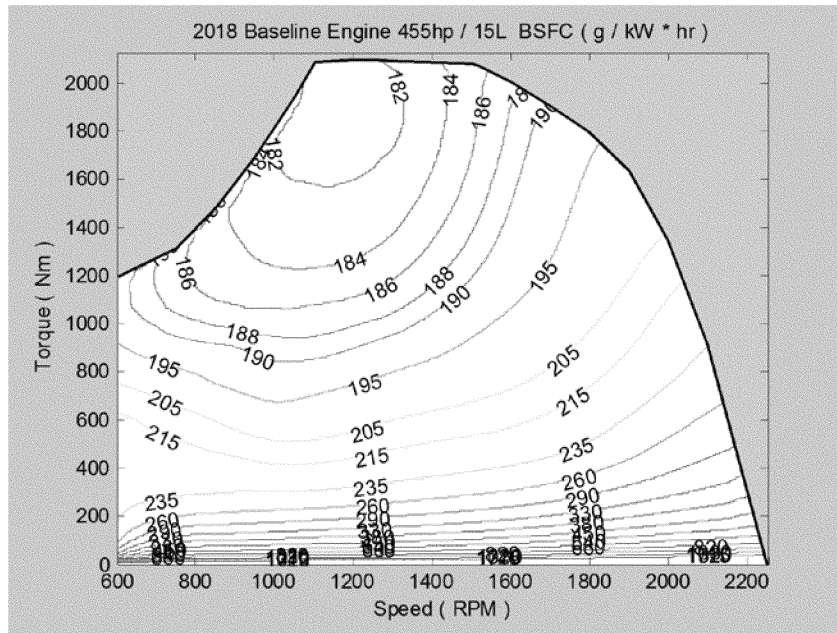

Figure II.3 2018 HHD Baseline Engine Fuel Map.

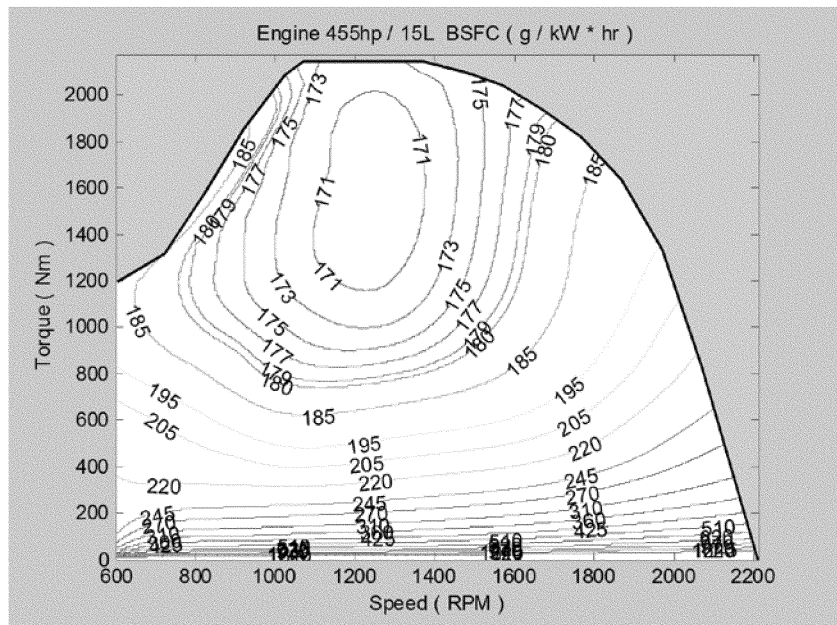

Figure II.4 2027 HHD Engine Fuel Map for a Sleeper Cab Tractor Vehicle.

(ix) Technology Packages for Diesel Engines Installed in Vocational Vehicles

For diesel engines (and other compression-ignition engines) used in vocational vehicles, the MY 2021 standards will require engine manufacturers to achieve, on average, a 2.3 percent reduction in fuel

consumption and CO<sub>2</sub> emissions beyond the Phase 2 FTP baselines. Beginning in MY 2024, the agencies are requiring a 3.6 percent reduction in fuel consumption and CO<sub>2</sub> emissions beyond the Phase 2 FTP baselines for all diesel engines including LHD, MHD, and HHD, and beginning in MY 2027 this increases to 4.2 percent, on average. The

agencies have based these FTP standards on the performance of reduced parasitic and friction losses, improved after-treatment, combustion optimization, superchargers and variable geometry turbochargers, physics model-based controls, improved EGR pressure drop, and variable valve timing (only in LHD and MHD engines).

The percent reduction for the MY 2021, MY 2024, and MY 2027 standards is based on the combination of technology effectiveness and the respective market adoption rates projected.

Most of the potential engine technologies discussed previously for tractor engines can also be applied to vocational engines. However, neither of the waste heat technologies, Rankine cycle nor turbo-compound, are likely to be applied to vocational engines because they are less effective under transient operation, which is weighted more heavily for all of the vocational sub-categories. Given the projected cost and complexity of such systems, we believe that for the Phase 2 time frame manufacturers will focus their WHR development work on tractor applications (which will have better payback for operators), rather than on vocational applications. In addition, the

benefits due to engine downsizing, which can be realized in some tractor engines, may not be realized at all in the vocational sector, again because this control technology produces few benefits under transient operation.

One of the most effective technologies for vocational engines is the optimization of transient controls with physics model based control, which would replace current look-up table based controls. These are described more in detail in Chapter 2.3 of the RIA. We project that more advanced transient controls, including different levels of model based control, discussed in Chapter 2.3 of the RIA, would continue to progress and become more broadly applicable throughout the Phase 2 timeframe.

Other effective technologies include parasitic load/friction reduction, as well as improvements to combustion, air

handling systems, turbochargers, and after-treatment systems. Table II-8 below lists those potential technologies together with the agencies' projected market penetration rates for vocational engines. Again, similar to tractor engines, the technology reduction and market penetration rates are estimated by combining manufacturer-submitted confidential business information, together with estimates reflecting the agencies' judgment, which is informed by historical trends in the market adoption of other fuel efficiency improving technologies. The reduction values shown as "percent reduction" are relative to the Phase 2 FTP baselines, which are shown in Table II-3. The overall reductions combine the technology reduction values with their market adoption rates. The same set of the dis-synergy factors as the tractor are used for MY 2021, 2024, and 2027.

TABLE II-8—PROJECTED VOCATIONAL ENGINE TECHNOLOGIES AND REDUCTION

Technology	Percent reduction 2020-2027	Market penetration 2021 (%)	Market penetration 2024 (%)	Market penetration 2027 (%)
Model based control .....	2.0	25	30	40
Parasitic/Friction .....	1.5	60	90	100
EGR/Air/VVT/Turbo .....	1.0	60	90	100
Improved AT .....	0.5	30	60	100
Combustion Optimization .....	1.0	60	90	100
Weighted reduction (%) -L/M/HHD .....	.....	2.3	3.6	4.2

Figure II.5 is a sample of a 2018 baseline engine fuel map for a MHD vocational engine.

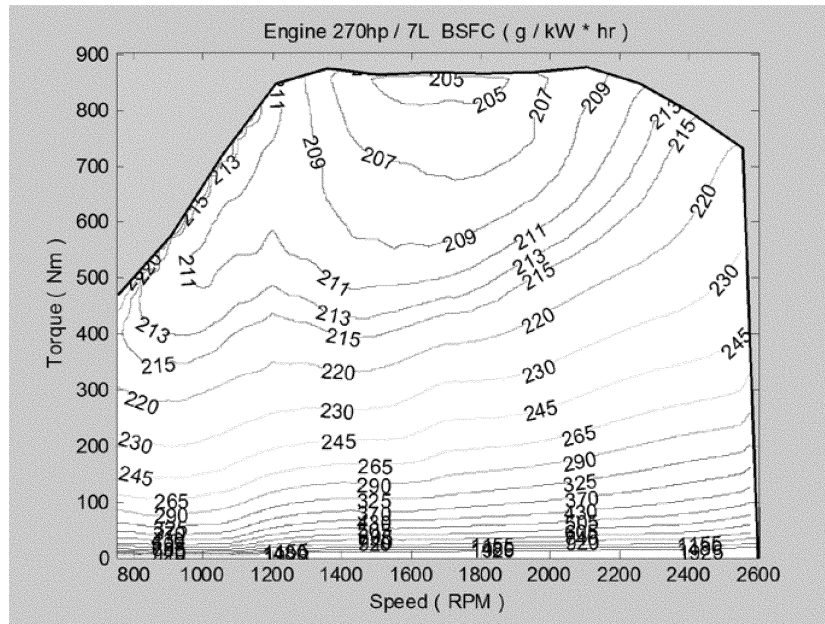

Figure II.5 2018 MHD engine fuel map

(x) Summary of the Agencies' Analysis of the Feasibility of the Diesel Engine Standards

The HD Phase 2 standards are based on projected adoption rates for technologies that the agencies regard as the maximum feasible for purposes of EISA section 32902 (k) and appropriate under CAA section 202(a) based on the technologies discussed above and in RIA Chapter 2. The agencies believe these technologies can be adopted at the estimated rates for these standards within the lead time provided, as discussed in RIA Chapter 2.7. The 2021 and 2024 MY standards are phase-in standards on the path to the 2027 MY standards, and these earlier standards were developed using less aggressive application rates and therefore have lower technology package costs than the 2027 MY standards.

As described in Section II.D.(2)(d) below, the costs to comply with these standards are estimated to range from \$275 to \$1,579 per engine. This is slightly higher than the costs for Phase 1, which were estimated to be \$234 to \$1,091 per engine. Although the agencies did not separately determine fuel savings or emission reductions due to the engine standards apart from the vehicle program, it is expected that the fuel savings will be significantly larger than these costs, and the emission reductions will be roughly proportional to the technology costs when compared to the corresponding vehicle program reductions and costs. Thus, we regard these standards as cost-effective. This is true even without considering payback period. The phase-in 2021 and 2024 MY standards are less stringent and less costly than the 2027 MY standards. Given that the agencies believe these standards are technologically feasible, are highly cost effective, and highly cost effective when accounting for the fuel savings, and have no apparent adverse potential impacts (e.g., there are no projected negative impacts on safety or vehicle utility), they appear to represent a reasonable choice under section 202(a) of the CAA and the maximum feasible under NHTSA's EISA authority at 49 U.S.C. 32902(k)(2).

(b) Basis for Continuing the Phase 1 Spark-Ignited Engine Standard

For gasoline vocational engines, we are not adopting more stringent *engine* standards. Today most SI-powered vocational vehicles are sold as incomplete vehicles by a vertically integrated chassis manufacturer, where the incomplete chassis shares most of the same technology as equivalent complete pickups or vans, including the

powertrain. Another, even less common way that SI-powered vocational vehicles are built is by a non-integrated chassis manufacturer purchasing an engine from a company that also produces complete and/or incomplete HD pickup trucks and vans. Gasoline engines used in vocational vehicles are generally the same engines as are used in the complete HD pickups and vans in the Class 2b and 3 weight categories, although the operational demands of vocational vehicles often require use of the largest, most powerful SI engines, so that some engines fitted in complete pickups and vans are not appropriate for use in vocational vehicles. Given the relatively small sales volumes for gasoline-fueled vocational vehicles, manufacturers typically cannot afford to invest significantly in developing separate technology for these engines.

The agencies received many comments suggesting that technologies be applied to increase the stringency of the SI engine standard. These comments were essentially misplaced, since the agencies already had premised the Phase 1 SI MY 2016 FTP engine standards on 100 percent adoption of these technologies. The commenters thus did not identify any additional engine technologies that the agencies did not already consider and account for in setting the MY 2016 FTP engine standard. Therefore, the Phase 1 SI engine FTP standard for these engines will remain in place. However, as noted above, projected engine improvements are being reflected in the stringency of the vehicle standard for the vehicle in which the engine will be installed. In part this is because the GEM cycles result in very different engine operation than what occurs when an engine is run over the engine FTP cycle. We believe that certain technologies will show a fuel consumption and CO<sub>2</sub> emissions reduction during GEM cycles that do not occur over the engine FTP. We received comments on engine technologies that can be recognized over the GEM vehicle cycles. As a result, the Phase 2 gasoline-fueled vocational vehicle standards are predicated on adoption of advanced engine friction reduction and cylinder deactivation. To the extent any SI engines do not incorporate the projected engine technologies, manufacturers of SI-powered vocational vehicles would need to achieve equivalent reductions from some other vehicle technology to meet the vehicle standards. See Section V.C of this Preamble for a description of how we applied these technologies to develop the vocational vehicle standards. See Section VI.C of this

Preamble for a description of the SI engine technologies that have been considered in developing the HD pickup truck and van standards.

(c) Engine Improvements Projected for Vehicles Over the GEM Duty Cycles

As part of the certification process for the Phase 2 vehicle standards, tractor and vocational vehicle manufacturers will need to represent their vehicles' actual engines in GEM. Although the vehicle standards recognize the same engine technologies as the separate engine standards, each have different test procedures for demonstrating compliance. As explained earlier in Section II.D.(1), compliance with the tractor separate *engine* standards is determined from a composite of the Supplemental Engine Test (SET) procedure's 13 steady-state operating points. Compliance with the vocational vehicle separate *engine* standards is determined over the Federal Test Procedure's (FTP) transient engine duty cycle. In contrast, compliance with the vehicle standards is determined using GEM, which calculates composite results over a combination of 55 mph, 65 mph, ARB Transient and idle vehicle cycles. Each of these duty cycles emphasize different engine operating points; therefore, they can each recognize certain technologies differently. Hence, these engine improvements can be readily recognized in GEM and appropriately reflected in the stringency of the vehicle standards. It is important to note, however, that the tractor vehicle standards presented in Section III project that some (but not all) tractor engines will achieve greater reductions than required by the engine standards. This was reflected in the agencies' feasibility analysis using projected engine fuel maps that represent engines having fuel efficiency better than what is required by the engine standards. Similarly, the vocational vehicle standards in presented in Section V project that the average vocational engine will achieve greater reductions than required by the engine standards. These additional reductions are recognized by GEM and are reflected in the stringency of the respective vehicle standards.

Our first step in aligning our engine technology assessment at both the engine and vehicle levels was to separately identify how each technology impacts performance at each of the 13 individual test points of the SET steady-state engine duty cycle. For example, engine friction reduction technology is expected to have the greatest impact at the highest engine speeds, where frictional energy losses are the greatest.



As another example, turbocharger technology is generally optimized for best efficiency at steady-state cruise vehicle speed. For an engine, this is near its lower peak-torque speed and at a moderately high load that still offers sufficient torque reserve to climb modest road grades without frequent transmission gear shifting. The agencies also considered the combination of certain technologies causing dis-synergies with respect to engine efficiency at each of these test points. See RIA Chapter 2.3 and 2.7 for further details. Chapter 2.8 and 2.9 of the RIA details how the engine fuel maps are created for both tractor and vocational vehicles used for GEM as the default engine fuel maps.

(d) Engine Technology Package Costs for Tractor and Vocational Engines (and Vehicles)

As described in Chapters 2 and 7 of the RIA, the agencies estimated costs for each of the engine technologies discussed here. All costs are presented relative to engines projected to at least comply with the model year 2017 standards—*i.e.*, relative to our Phase 2 baseline engines. Note that we are not presenting any costs for gasoline engines (SI engines) in this section because we are not changing the SI engine standards. However, we are including a cost for additional engine technology as part of the vocational vehicle analysis in Section V.C.2.(e) (and appropriately so, since those engine improvements are reflected in the stringency of the vocational vehicle standard).

Our engine cost estimates include a separate analysis of the incremental part costs, research and development activities, and additional equipment. Our general approach used elsewhere in this action (for HD pickup trucks, gasoline engines, Class 7 and 8 tractors, and Class 2b–8 vocational vehicles) estimates a direct manufacturing cost for a part and marks it up based on a factor to account for indirect costs. *See also* 75 FR 25376. We believe that approach is appropriate when compliance with the standards is achieved generally by installing new parts and systems purchased from a supplier. In such a case, the supplier is conducting the bulk of the research and development on the new parts and systems and including those costs in the purchase price paid by the original equipment manufacturer. Consequently, the indirect costs incurred by the original equipment manufacturer need not reflect significant cost to cover research and development since the bulk of that effort is already completed. For the MHD and HHD diesel engine segment, however, the agencies believe that OEMs will incur costs not associated with the purchase of parts or systems from suppliers or even the production of the parts and systems, but rather the development of the new technology by the original equipment manufacturer itself. Therefore, the agencies have directly estimated additional indirect costs to account for these development costs. The agencies used the same approach in the Phase 1 HD rule. EPA commonly uses this approach in cases

where significant investments in research and development can lead to an emission control approach that requires no new hardware. For example, combustion optimization may significantly reduce emissions and cost a manufacturer millions of dollars to develop but would lead to an engine that is no more expensive to produce. Using a bill of materials approach would suggest that the cost of the emissions control was zero reflecting no new hardware and ignoring the millions of dollars spent to develop the improved combustion system. Details of the cost analysis are included in the RIA Chapter 2.7. To reiterate, we have used this different approach because the MHD and HHD diesel engines are expected to comply in part via technology changes that are not reflected in new hardware but rather reflect knowledge gained through laboratory and real world testing that allows for improvements in control system calibrations—changes that are more difficult to reflect through direct costs with indirect cost multipliers. Note that these engines are also expected to incur new hardware costs as shown in Table II–9 through Table II–12. EPA also developed the incremental piece cost for the components to meet each of the 2021 and 2024 standards. The costs shown in Table II–13 include a low complexity ICM of 1.15 and assume the flat-portion of the learning curve is applicable to each technology.

(i) Tractor Engine Package Costs

TABLE II–9—MY 2021 TRACTOR DIESEL ENGINE COMPONENT COSTS INCLUSIVE OF INDIRECT COST MARKUPS AND ADOPTION RATES [2013\$]

	Medium HD	Heavy HD
After-treatment system (improved effectiveness SCR, dosing, DPF) .....	\$7	\$7
Valve Actuation .....	84	84
Cylinder Head (flow optimized, increased firing pressure, improved thermal management) .....	3	3
Turbocharger (improved efficiency) .....	9	9
Turbo Compounding .....	51	51
EGR Cooler (improved efficiency) .....	2	2
Water Pump (optimized, variable vane, variable speed) .....	44	44
Oil Pump (optimized) .....	2	2
Fuel Pump (higher working pressure, increased efficiency, improved pressure regulation) .....	2	2
Fuel Rail (higher working pressure) .....	5	5
Fuel Injector (optimized, improved multiple event control, higher working pressure) .....	5	5
Piston (reduced friction skirt, ring and pin) .....	1	1
Valve train (reduced friction, roller tappet) .....	39	39
Waste Heat Recovery .....	71	71
“Right sized” engine .....	–41	–41
<b>Total .....</b>	<b>284</b>	<b>284</b>

Note: “Right sized” diesel engine is a smaller, less costly engine than the engine it replaces.

TABLE II–10—MY 2024 TRACTOR DIESEL ENGINE COMPONENT COSTS INCLUSIVE OF INDIRECT COST MARKUPS AND ADOPTION RATES  
[2013\$]

	Medium HD	Heavy HD
After-treatment system (improved effectiveness SCR, dosing, DPF) .....	\$14	\$14
Valve Actuation .....	169	169
Cylinder Head (flow optimized, increased firing pressure, improved thermal management) .....	6	6
Turbocharger (improved efficiency) .....	17	17
Turbo Compounding .....	93	93
EGR Cooler (improved efficiency) .....	3	3
Water Pump (optimized, variable vane, variable speed) .....	85	85
Oil Pump (optimized) .....	4	4
Fuel Pump (higher working pressure, increased efficiency, improved pressure regulation) .....	4	4
Fuel Rail (higher working pressure) .....	9	9
Fuel Injector (optimized, improved multiple event control, higher working pressure) .....	10	10
Piston (reduced friction skirt, ring and pin) .....	3	3
Valve train (reduced friction, roller tappet) .....	77	77
Waste Heat Recovery .....	298	298
“Right sized” engine .....	–82	–82
<b>Total .....</b>	<b>712</b>	<b>712</b>

**Note:** “Right sized” diesel engine is a smaller, less costly engine than the engine it replaces.

TABLE II–11—MY 2027 TRACTOR DIESEL ENGINE COMPONENT COSTS INCLUSIVE OF INDIRECT COST MARKUPS AND ADOPTION RATES  
[2013\$]

	Medium HD	Heavy HD
After-treatment system (improved effectiveness SCR, dosing, DPF) .....	\$15	\$15
Valve Actuation .....	172	172
Cylinder Head (flow optimized, increased firing pressure, improved thermal management) .....	6	6
Turbocharger (improved efficiency) .....	17	17
Turbo Compounding .....	89	89
EGR Cooler (improved efficiency) .....	3	3
Water Pump (optimized, variable vane, variable speed) .....	85	85
Oil Pump (optimized) .....	4	4
Fuel Pump (higher working pressure, increased efficiency, improved pressure regulation) .....	4	4
Fuel Rail (higher working pressure) .....	9	9
Fuel Injector (optimized, improved multiple event control, higher working pressure) .....	10	10
Piston (reduced friction skirt, ring and pin) .....	3	3
Valve train (reduced friction, roller tappet) .....	77	77
Waste Heat Recovery .....	1,208	1,208
“Right sized” engine .....	–123	–123
<b>Total .....</b>	<b>1,579</b>	<b>1,579</b>

**Note:** “Right sized” diesel engine is a smaller, less costly engine than the engine it replaces.

(ii) Vocational Diesel Engine Package  
Costs

TABLE II–12—MY 2021 VOCATIONAL DIESEL ENGINE COMPONENT COSTS INCLUSIVE OF INDIRECT COST MARKUPS AND ADOPTION RATES  
[2013\$]

	Light HD	Medium HD	Heavy HD
After-treatment system (improved effectiveness SCR, dosing, DPF) .....	\$8	\$8	\$8
Valve Actuation .....	93	93	93
Cylinder Head (flow optimized, increased firing pressure, improved thermal management) .....	6	3	3
Turbocharger (improved efficiency) .....	10	10	10
EGR Cooler (improved efficiency) .....	2	2	2
Water Pump (optimized, variable vane, variable speed) .....	58	58	58
Oil Pump (optimized) .....	3	3	3
Fuel Pump (higher working pressure, increased efficiency, improved pressure regulation) .....	3	3	3
Fuel Rail (higher working pressure) .....	8	6	6
Fuel Injector (optimized, improved multiple event control, higher working pressure) .....	8	6	6
Piston (reduced friction skirt, ring and pin) .....	1	1	1
Valve train (reduced friction, roller tappet) .....	70	52	52
Model Based Controls .....	29	29	29
<b>Total .....</b>	<b>298</b>	<b>275</b>	<b>275</b>

TABLE II-13—MY 2024 VOCATIONAL DIESEL ENGINE COMPONENT COSTS INCLUSIVE OF INDIRECT COST MARKUPS AND ADOPTION RATES  
[2013\$]

	Light HD	Medium HD	Heavy HD
After-treatment system (improved effectiveness SCR, dosing, DPF) .....	\$14	\$14	\$14
Valve Actuation .....	160	160	160
Cylinder Head (flow optimized, increased firing pressure, improved thermal management) .....	10	6	6
Turbocharger (improved efficiency) .....	16	16	16
EGR Cooler (improved efficiency) .....	3	3	3
Water Pump (optimized, variable vane, variable speed) .....	81	81	81
Oil Pump (optimized) .....	4	4	4
Fuel Pump (higher working pressure, increased efficiency, improved pressure regulation) .....	4	4	4
Fuel Rail (higher working pressure) .....	11	9	9
Fuel Injector (optimized, improved multiple event control, higher working pressure) .....	13	10	10
Piston (reduced friction skirt, ring and pin) .....	2	2	2
Valve train (reduced friction, roller tappet) .....	97	73	73
Model Based Controls .....	32	32	32
<b>Total .....</b>	<b>446</b>	<b>413</b>	<b>413</b>

TABLE II-14—MY 2027 VOCATIONAL DIESEL ENGINE COMPONENT COSTS INCLUSIVE OF INDIRECT COST MARKUPS AND ADOPTION RATES  
[2013\$]

	Light HD	Medium HD	Heavy HD
After-treatment system (improved effectiveness SCR, dosing, DPF) .....	\$15	\$15	\$15
Valve Actuation .....	172	172	172
Cylinder Head (flow optimized, increased firing pressure, improved thermal management) .....	10	6	6
Turbocharger (improved efficiency) .....	17	17	17
EGR Cooler (improved efficiency) .....	3	3	3
Water Pump (optimized, variable vane, variable speed) .....	85	85	85
Oil Pump (optimized) .....	4	4	4
Fuel Pump (higher working pressure, increased efficiency, improved pressure regulation) .....	4	4	4
Fuel Rail (higher working pressure) .....	11	9	9
Fuel Injector (optimized, improved multiple event control, higher working pressure) .....	14	10	10
Piston (reduced friction skirt, ring and pin) .....	3	3	3
Valve train (reduced friction, roller tappet) .....	102	77	77
Model Based Controls .....	41	41	41
<b>Total .....</b>	<b>481</b>	<b>446</b>	<b>446</b>

(e) Feasibility of Additional Engine Improvements

While the agencies' technological feasibility analysis for the engine standards focuses on what is achievable for existing engine platforms, we recognize that it could be possible to achieve greater reductions by designing entirely new engine platforms. Unlike existing platforms, which are limited with respect to peak cylinder pressures (precluding certain efficiency improvements), new platforms can be designed to have higher cylinder pressure than today's engines. New designs are also better able to incorporate recent improvements in materials and manufacturing, as well as other technological developments. Considered together, it is likely that a new engine platform could be about 2 percent better than engines using older platforms. Moreover, the agencies have seen CBI data that suggests improvement of more than 3 percent are

possible. However, because designing and producing a new engine platform requires hundreds of millions of dollars in capital investment and significant lead time for research and development, it would not be appropriate to project that each engine manufacturer could complete a complete redesign of all of its engines within the Phase 2 time frame. Unlike light-duty, heavy-duty sales volumes are not large enough to support short redesign cycles. As a result, it can take 20 years for a manufacturer to generate the necessary return on the investment associated with an engine redesign. Forcing a manufacturer to redesign its engines prematurely could easily result in significant financial strain on a company.

On the other hand, how far the various manufacturers are into their design cycles suggests that one or more manufacturers will probably introduce a new engine platform during the Phase 2

time frame. This would not enable other engine manufacturers to meet more stringent standards, and thus it would not be an appropriate basis to justify more stringent engine standards (and certainly not engine standards reflecting 100 percent use of technologies premised on existence of new platforms). However, the availability of some more efficient engines on the market will provide the opportunity for vehicle manufacturers to lower their average fuel consumption as measured by GEM. Vehicle manufacturers can use a mix of newer and older engine designs to achieve an average engine performance significantly better than what is required by the engine standards. Thus, the vehicle standards can reflect engine platform improvements (which are amenable to measurement in GEM), without necessarily forcing each manufacturer to achieve these additional reductions,

which may be achievable only for new engine platforms.

As discussed in Section III.D.(1)(b)(i), the agencies project that at least one engine manufacturer (and possibly more) will have completed a redesign for tractor engines by 2027.

Accordingly, we project that 50 percent of tractor engines in 2027 will be redesigned engines and be 1.6 percent more efficient than required by the engine standards, so the average engine would be 0.8 percent better. However, we could have projected the same overall improvement by projecting 25 percent of engine getting 3.2 percent better. Based on the CBI information available to us, we believe projecting a 0.8 percent improvement is reasonable, but may be somewhat conservative.

Adding this 0.8 percent improvement to the 5.1 percent reduction *required* by the standards means we project the average 2027 tractor engine would be 5.9 percent better than Phase 1. Because engine improvements for tractors are applied separately for day cabs and sleeper cabs in the vehicle program, we estimated separate improvements for them here. Specifically, we project a 5.4 percent reduction for day cabs and a 6.4 percent reduction in fuel consumption in sleeper cabs beyond Phase 1. It is important to also note that manufacturers that do not achieve this level would be able to make up for the difference by applying one of the many other tractor vehicle technologies to a greater extent than we project, or to achieve greater reductions by

optimizing technology efficiency further. We are not including the cost of developing these new engines in our cost analysis because we believe these engines are going to be developed due to market forces (*i.e.*, the new platform, already contemplated) rather than due to this rulemaking.

We are making a similar new engine platform projection for vocational vehicles. This is because many of tractor and vocational engines, such as HHD, would likely share the same engine hardware with the exception of WHR. In addition, the model based control discussed in Chapter 2.3 of the RIA could integrate engines better with transmissions on the vehicle side. We believe manufacturers will first focus their efforts on improving tractor engines but still believe that the 2027 vocational engine will be significantly better than required by the engine standards.

### (3) EPA Engine Standards for N<sub>2</sub>O

EPA will continue to apply the Phase 1 N<sub>2</sub>O engine standard of 0.10 g/bhp-hr and a 0.02 g/bhp-hr default deterioration factor to the Phase 2 program. EPA adopted the cap standard for N<sub>2</sub>O as an engine-based standard because the agency believes that emissions of this GHG are technologically related solely to the engine, fuel, and emissions after-treatment systems, and the agency is not aware of any influence of vehicle-based technologies on these emissions. Note that NHTSA did not adopt standards for N<sub>2</sub>O because these emissions do not

impact fuel consumption in a significant way.

In the proposal we considered reducing both the standard and deterioration factor to 0.05 and 0.01 g/bhp-hr respectively because engines certified in model year 2014 were generally meeting the proposed standard. We also explained the process behind N<sub>2</sub>O formation in urea SCR after-treatment systems and how that process could be optimized to elicit additional N<sub>2</sub>O reductions. 80 FR 40203. While we have seen some reductions and a few increases in engine family certified N<sub>2</sub>O levels across the 2014, 2015, and 2016 model years, the majority have remained unchanged.

While we still believe that further optimization of SCR systems is possible to reduce N<sub>2</sub>O emissions, as demonstrated for some engine families, we do not know to what extent further optimization can be achieved given the tradeoffs required to meet the Phase 2 CO<sub>2</sub> standards. These tradeoffs potentially include advancing fuel injection timing to reduce CO<sub>2</sub> emissions resulting in an increase in NO<sub>x</sub> emissions at the engine outlet before the after-treatment, increasing the needed NO<sub>x</sub> reduction efficiency of the SCR system. We will continue to assess N<sub>2</sub>O emissions as SCR technology evolves and CO<sub>2</sub> emission reductions phase in, and we will revisit the standard at a later date to further control N<sub>2</sub>O emission. This will likely be included in the upcoming rule to consider more stringent NO<sub>x</sub> standards.

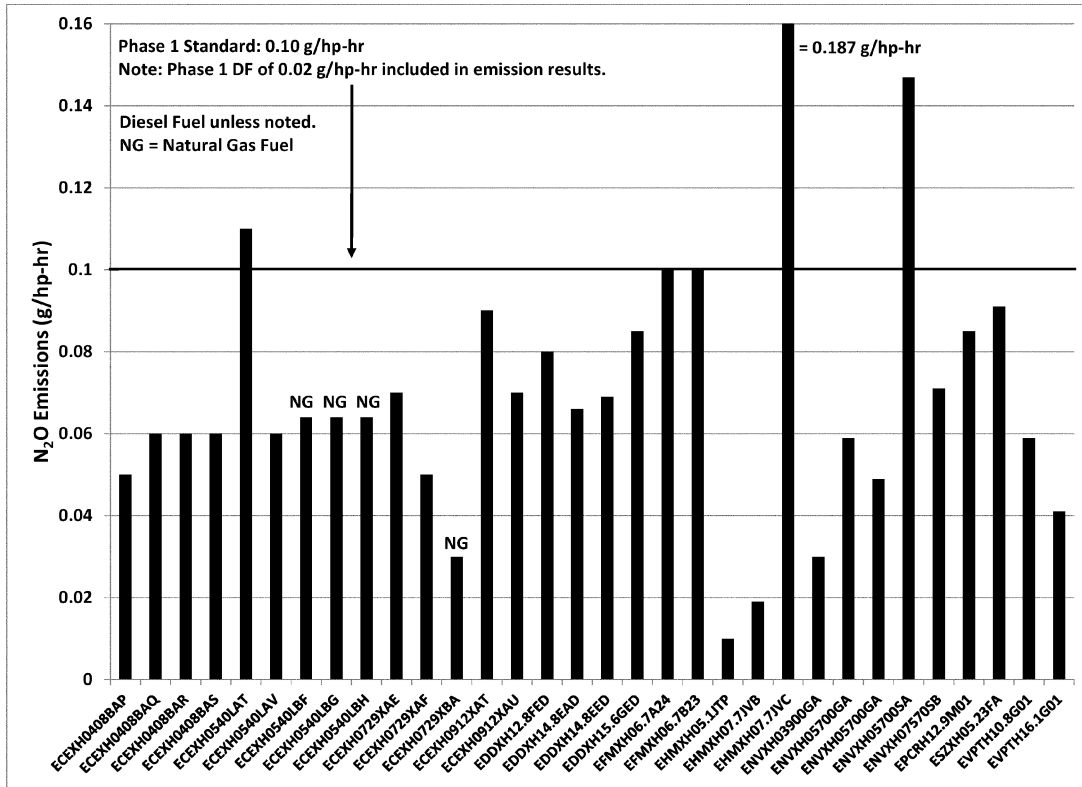

Figure II.6 EPA 2014 Certification Database N<sub>2</sub>O Emission Results for 24 Engines.

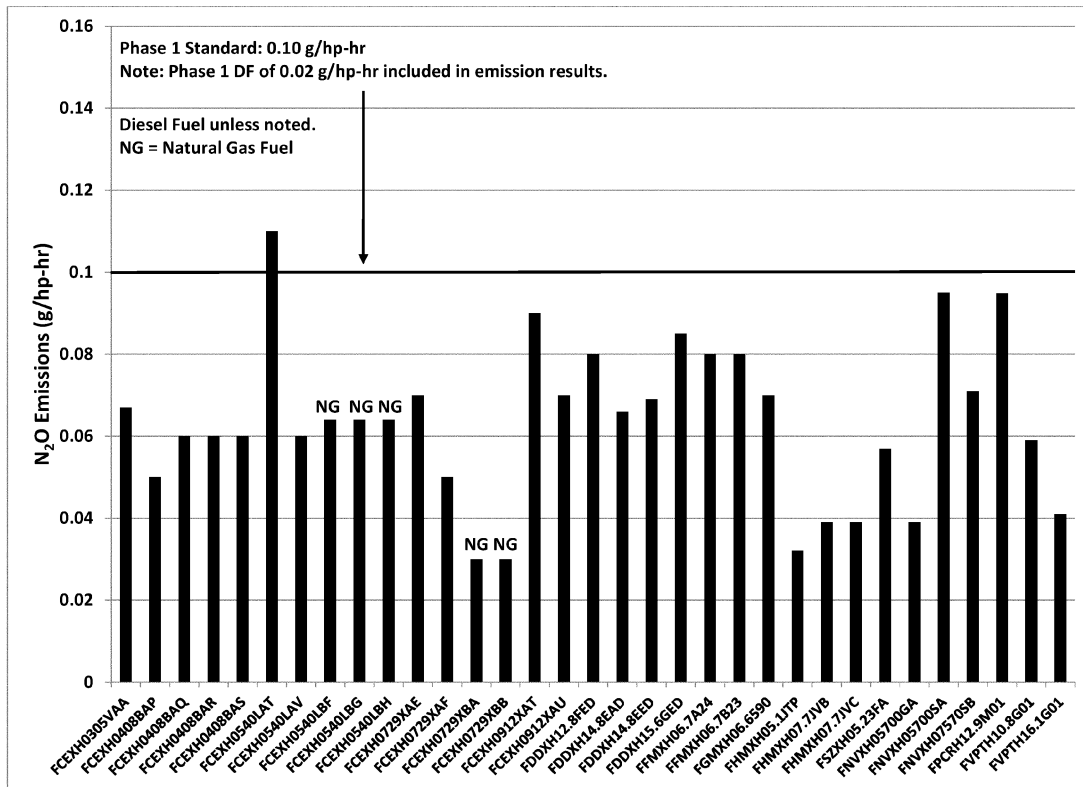

Figure II.7 EPA 2015 Certification Database N<sub>2</sub>O Emission Results for 24 Engines.

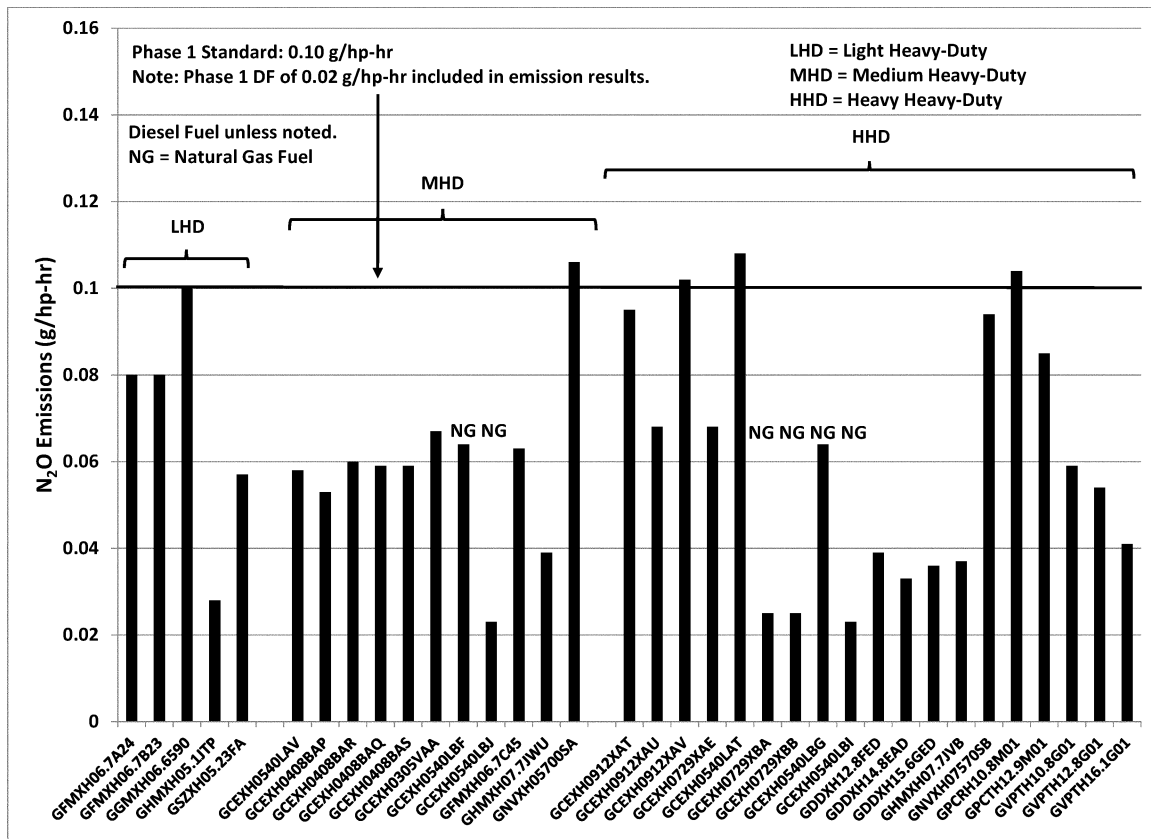

Figure II.8 EPA 2016 Certification Database N<sub>2</sub>O Emission Results for 24 Engines.

#### (4) EPA Engine Standards for Methane

EPA will continue to apply the Phase 1 methane engine standards to the Phase 2 program. EPA adopted the cap standards for CH<sub>4</sub> (along with N<sub>2</sub>O standards) as engine-based standards because the agency believes that emissions of this GHG are technologically related solely to the engine, fuel, and emissions after-treatment systems, and the agency is not aware of any influence of vehicle-based technologies on these emissions. We are applying these cap standards against the FTP duty-cycle because the FTP cycle is the most stringent with respect to emissions of these pollutants and we do not believe that a reduction in stringency from the current Phase 1 standards is warranted. Note that NHTSA did not adopt standards for CH<sub>4</sub> (or N<sub>2</sub>O) because these emissions do not impact fuel consumption in a significant way.

EPA continues to believe that manufacturers of most engine technologies will be able to comply with the Phase 1 CH<sub>4</sub> standard with no technological improvements. We note that we are not aware of any new technologies that would have allowed

us to adopt more stringent standards at this time.

#### (5) Compliance Provisions and Flexibilities for Engine Standards

The agencies are continuing most of the Phase 1 compliance provisions and flexibilities for the Phase 2 engine standards.

##### (a) Averaging, Banking, and Trading

The agencies' general approach to averaging is discussed in Section I. We did not propose to offer any new or special credits to engine manufacturers to comply with any of the separate engine standards. Except for early credits, the agencies are retaining all Phase 1 credit flexibilities and limitations to continue for use in the Phase 2 engine program.

As discussed below and as proposed, EPA is changing the useful life for LHD engines for GHG emissions from the current 10 years/110,000 miles to 15 years/150,000 miles to be consistent with the useful life of criteria pollutants recently updated in EPA's Tier 3 rule. In order to ensure that banked credits maintain their value in the transition from Phase 1 to Phase 2, EPA and NHTSA are adopting the proposed adjustment factor of 1.36 (*i.e.*, 150,000

mile ÷ 110,000 miles) for credits that are carried forward from Phase 1 to the MY 2021 and later Phase 2 standards. Without this adjustment factor the change in useful life would have effectively resulted in a discount of banked credits that are carried forward from Phase 1 to Phase 2, which is not the intent of the change in the useful life. See Sections V and VI for additional discussion of similar adjustments of vehicle-based credits.

Finally, the agencies are limiting the carryover of certain Phase 1 engine credits into the Phase 2 program. As described in Section II.D.(2) the agencies made adjustments to the FTP baselines, to address the unexpected step-change improvement in engine fuel consumption and CO<sub>2</sub> emissions. The underlying reasons for this shift are mostly related to manufacturers optimizing their SCR thermal management strategy over the FTP in ways that we (mistakenly) thought they already had in MY 2010 (*i.e.*, the Phase 1 baseline). At the time of Phase 1 we had not realized that these improvements were not already in the Phase 1 baseline. This issue does not apply for SET emissions, and thus only significantly impacts engines certified

exclusively to the FTP standards (rather than both FTP and SET standards). To prevent manufacturers from diluting the Phase 2 engine program with credits generated relative to this incorrect baseline, we are not allowing engine credits generated against the Phase 1 FTP standards to be carried over into the Phase 2 program.

(b) Changing Global Warming Potential (GWP) Values in the Credit Program for CH<sub>4</sub> and N<sub>2</sub>O

The Phase 1 rule included a compliance flexibility that allowed heavy-duty manufacturers and conversion companies to comply with the respective methane or nitrous oxide standards by means of over-complying with CO<sub>2</sub> standards (40 CFR 1036.705(d)). The heavy-duty rules allow averaging only between vehicles or engines of the same designated type (referred to as an “averaging set” in the rules). Specifically, the Phase 1 heavy-duty rulemaking added a CO<sub>2</sub> credits program which allowed heavy-duty engine manufacturers to average and bank emission credits to comply with the methane and nitrous oxide requirements after adjusting the CO<sub>2</sub> emission credits based on the relative GWP equivalents. To establish the GWP equivalents used by the CO<sub>2</sub> credits program, the Phase 1 rule incorporated the IPCC Fourth Assessment Report GWP values of 25 for CH<sub>4</sub> and 298 for N<sub>2</sub>O, which are assessed over a 100 year lifetime.

EPA will continue this provision for Phase 2. However, since the Phase 1 rule was finalized, a new IPCC report has been released (the Fifth Assessment Report), with new GWP estimates. This caused us to look again at the relative GWP equivalency of methane and nitrous oxide and to seek comment on whether the methane and nitrous oxide GWPs used to establish the equivalency value for the CO<sub>2</sub> Credit program should be updated to those established by IPCC in its Fifth Assessment Report. 80 FR 40206. The Fifth Assessment Report provides four 100 year GWP values for methane ranging from 28 to 36 and two 100 year GWP values for nitrous oxide, either 265 or 298.

EPA is updating the GWP value to convert CO<sub>2</sub> credits for use against the methane standard. We are using a GWP of 34 for the value of methane reductions relative to CO<sub>2</sub> reductions. (The GWP remains 298 for N<sub>2</sub>O). The use of this new methane GWP will not begin until MY 2021, when the Phase 2 engine standards begin. This provides sufficient lead time for both the agencies and manufacturers to update systems, and also ensures that manufacturers

would be able to make any necessary design changes. The choice of when to commence use of this GWP value for our engines standards does not prejudice the choice of other GWP values for use in regulations and other purposes in the near term. Further discussion is found in Section XI.D.2.a.

(c) In-Use Compliance and Useful Life

Consistent with section 202(a)(1) and 202(d) of the CAA, for Phase 1, EPA established in-use standards for heavy-duty engines. Based on our assessment of testing variability and other relevant factors, we established in-use standards by adding a 3 percent adjustment factor to the full useful life CO<sub>2</sub> emissions and fuel consumption results measured in the EPA certification process to address measurement variability inherent in comparing results among different laboratories and different engines. See 40 CFR part 1036. The agencies are not changing this for Phase 2 SET and FTP engine standard compliance.

In Phase 1, EPA set the useful life for engines and vehicles with respect to GHG emissions equal to the respective useful life periods for criteria pollutants. In April 2014, as part of the Tier 3 light-duty vehicle final rule, EPA extended the regulatory useful life period for criteria pollutants to 150,000 miles or 15 years, whichever comes first, for Class 2b and 3 pickup trucks and vans and some light-duty trucks (79 FR 23414, April 28, 2014). As proposed, EPA is applying the same useful life of 150,000 miles or 15 years for the Phase 2 GHG standards for engines primarily intended for use in vocational vehicles with a GVWR at or below 19,500 lbs. NHTSA will use the same useful life values as EPA for all heavy-duty vehicles.

As proposed, we will continue the regulatory allowance in 40 CFR 1036.150(g) that allows engine manufacturers to use assigned deterioration factors (DFs) for most engines without performing their own durability emission tests or engineering analysis. However, the engines will still be required to meet the standards in actual use without regard to whether the manufacturer used the assigned DFs. This allowance is being continued as an interim provision and may be discontinued for later phases of standards as more information becomes known. Manufacturers are allowed to use an assigned additive DF of 0.0 g/bhp-hr for CO<sub>2</sub> emissions from any conventional engine (*i.e.*, an engine not including advanced or off-cycle technologies). Upon request, we could allow the assigned DF for CO<sub>2</sub> emissions from engines including advanced or off-

cycle technologies, but only if we determine that it would be consistent with good engineering judgment. We believe that we have enough information about in-use CO<sub>2</sub> emissions from conventional engines to conclude that they will not increase as the engines age. However, we lack such information about the more advanced technologies. For technologies such as WHR that are considered advanced in the context of Phase 1, but would be treated as a more ordinary technology by the end of Phase 2, we plan to work with manufacturers to determine if using the assigned zero DF would be appropriate.

(d) Alternate CO<sub>2</sub> Standards

In the Phase 1 rulemaking, the agencies allowed certification to alternate CO<sub>2</sub> engine standards in model years 2014 through 2016. This flexibility was intended to address the special case of needed lead time to implement new standards for a previously unregulated pollutant. Since that special case does not apply for Phase 2, we are not adopting a similar flexibility in this rulemaking.

(e) Approach to Standards and Compliance Provisions for Natural Gas Engines

EPA is also making certain clarifying changes to its rules regarding classification of natural gas engines. This relates to standards for all emissions, both greenhouse gases and criteria pollutants. These clarifying changes are intended to reflect the status quo, and therefore should not have any associated costs.

EPA emission standards have always applied differently for gasoline-fueled and diesel-fueled engines. The regulations in 40 CFR part 86 implement these distinctions by dividing engines into Otto-cycle and Diesel-cycle technologies. This approach led EPA to categorize natural gas engines according to their design history. A diesel engine converted to run on natural gas was classified as a diesel-cycle engine; a gasoline engine converted to run on natural gas was classified as an Otto-cycle engine.

The Phase 1 rule described our plan to transition to a different approach, consistent with EPA's non-road programs, in which we divide engines into compression-ignition and spark-ignition technologies based only on the thermodynamic operating characteristics of the engines.<sup>193</sup> However, the Phase 1 rule included a provision allowing us to continue with

<sup>193</sup> See 40 CFR 1036.108.



the historic approach on an interim basis.

Under the existing EPA regulatory definitions of “compression-ignition” and “spark-ignition,” a natural gas engine would generally be considered compression-ignition if it operates with lean air-fuel mixtures and uses a pilot injection of diesel fuel to initiate combustion, and would generally be considered spark-ignition if it operates with stoichiometric air-fuel mixtures and uses a spark plug to initiate combustion.

EPA’s basic premise here is that natural gas engines performing similar in-use functions as diesel engines should be subject to similar regulatory requirements. The compression-ignition emission standards and testing requirements reflect the operating characteristics for the full range of heavy-duty vehicles, including substantial operation in long-haul service characteristic of tractors. The

spark-ignition emission standards and testing requirements do not include some of those provisions related to use in long-haul service or other applications where diesel engines predominate, such as steady-state testing, Not-to-Exceed standards, and extended useful life. We believe it would be inappropriate to apply the spark-ignition standards and requirements to natural gas engines that are being used in applications mostly served by diesel engines today. We therefore proposed to replace the interim provision described above with a differentiated approach to certification of natural gas engines across all of the EPA standards—for both GHGs and criteria pollutants. 80 FR 40207. Under the proposed amendment, we would require manufacturers to divide all their natural gas engines into primary intended service classes, as we already require for compression-ignition engines, whether or not the engine has

features that otherwise could (in theory) result in classification as SI under the current rules. We proposed that any natural gas engine qualifying as a medium heavy-duty engine (19,500 to 33,000 lbs. GVWR) or a heavy heavy-duty engine (over 33,000 lbs. GVWR) would be subject to all the emission standards and other requirements that apply to compression-ignition engines. However, based on comments, we are finalizing this change only for heavy heavy-duty engines. Commenters identified medium heavy-duty applications in which SI alternative fuel engines compete significantly with gasoline engines, which is not consistent with the premise of the proposal. Thus, we are not finalizing the proposed change for medium heavy-duty engines.

Table II–15 describes the provisions that apply differently for compression-ignition and spark-ignition engines:

TABLE II–15—REGULATORY PROVISIONS THAT ARE DIFFERENT FOR COMPRESSION-IGNITION AND SPARK-IGNITION ENGINES

Provision	Compression-ignition	Spark-ignition
Transient duty cycle .....	40 CFR part 86, Appendix I, paragraph (f)(2) cycle; divide by 1.12 to de-normalize.	40 CFR part 86, Appendix I, paragraph (f)(1) cycle.
Ramped-modal test (SET) .....	yes .....	no.
NTE standards .....	yes .....	no.
Smoke standard .....	yes .....	no.
Manufacturer-run in-use testing .....	yes .....	no.
ABT—pollutants .....	NO <sub>x</sub> , PM .....	NO <sub>x</sub> , NMHC.
ABT—transient conversion factor ..	6.5 .....	6.3.
ABT—averaging set .....	Separate averaging sets for light, medium, and heavy HDDE	One averaging set for all SI engines.
Useful life .....	110,000 miles for light HDDE, <sup>a</sup> 185,000 miles for medium HDDE, 435,000 miles for heavy HDDE.	110,000 miles. <sup>a</sup>
Warranty .....	50,000 miles for light HDDE, 100,000 miles for medium HDDE, 100,000 miles for heavy HDDE.	50,000 miles.
Detailed AECD description .....	yes .....	no.
Test engine selection .....	highest injected fuel volume .....	most likely to exceed emission standards.

**Note:**

<sup>a</sup> As proposed, useful life for light heavy-duty diesel and spark ignition engines is being increased to 150,000 miles for GHG emissions, but remains at 110,000 for criteria pollutant emissions.

The onboard diagnostic requirements already differentiate requirements by fuel type, so there is no need for those provisions to change based on the considerations of this section.

We are not aware of any currently certified engines that will change from compression-ignition to spark-ignition under this approach. Nonetheless, because these proposed changes could result in a change in standards for engines currently under development, we believe it is appropriate to provide additional lead time. We will therefore continue to apply the existing interim provision through model year 2020.<sup>194</sup>

<sup>194</sup> Section 202(a)(2), applicable to emissions of greenhouse gases, does not mandate a specific period of lead time, but EPA sees no reason for a

Starting in model year 2021, all the provisions will apply as described above for heavy heavy-duty engines. Manufacturers will not be permitted to certify any engine families using carryover emission data if a particular engine model switched from compression-ignition to spark-ignition, or vice versa. However, as noted above, in practice these vehicles are already

different compliance date here for GHGs and criteria pollutants. This is also true with respect to the closed crankcase emissions discussed in the following subsection. Also, as explained in section I.E.i.e, EPA interprets the phrase “classes or categories of heavy duty vehicles or engines” in CAA section 202(a)(3)(C) to refer to categories of vehicles established according to features such as their engine cycle (spark-ignition or compression-ignition).l.

being certified as CI engines, so we view these changes as clarifications ratifying the current status quo.

These provisions will apply equally to engines fueled by any fuel other than gasoline or ethanol, should such engines be produced in the future. Given the current and historic market for vehicles above 33,000 lbs. GVWR, the agencies believe any alternative-fueled vehicles in this weight range will be competing primarily with diesel vehicles and should be subject to the same requirements as them. See Sections XI and XII for additional discussion of natural gas fueled engines.

## (f) Crankcase Emissions From Natural Gas Engines

EPA proposed to require that all natural gas-fueled engines have closed crankcases, rather than continuing the provision that allows venting to the atmosphere all crankcase emissions from all compression-ignition engines. 80 FR 40208. However, EPA is not finalizing the proposed requirement at this time.

Open crankcases have been allowed as long as these vented crankcase emissions are measured and accounted for as part of an engine's tailpipe emissions. This allowance has historically been in place to address the technical limitations related to recirculating diesel-fueled engines' crankcase emissions, which have high PM emissions, back into the engine's air intake. High PM emissions vented into the intake of an engine can foul turbocharger compressors and after cooler heat exchangers. In contrast, historically EPA has mandated closed crankcase technology on all gasoline fueled engines and all natural gas spark-ignition engines.<sup>195</sup> The inherently low PM emissions from these engines posed no technical barrier to a closed crankcase mandate. However, after considering the comments on this issue, we now believe that there are practical reasons why we should not close natural gas crankcases without also requiring closed crankcases for other compression-ignition engines. Because current natural gas engines are generally produced from diesel engine designs that are not designed to operate with closed crankcases, we have concerns that sealing the crankcase on the natural gas versions will require substantial development effort, and the seals may not function properly. Thus, we expect to update our regulations for crankcase emissions from all compression ignition engines at the same time in a future rulemaking.

## (g) Compliance Margins

Some commenters suggested that the agencies should apply a compliance margin to confirmatory and SEA test results to account for variability of engine maps and emission tests. However, EPA's past practice has been to base the standards on technology projections that assume manufacturers will apply compliance margins to their test results for certification. In other words, they design their products to have emissions below the standards by some small margin so that test-to-test or lab-to-lab variability would not cause

them to exceed any applicable standards. Consequently, EPA has typically not set standards precisely at the lowest levels achievable, but rather at slightly higher levels—expecting manufacturers to target the lower levels to provide compliance margins for themselves. The agencies have applied this approach to the Phase 2 standards. Thus, the feasibility and cost analyses reflect the expectation that manufacturers will target lower values to provide compliance margins.

The agencies have also improved the engine test procedures and compliance provisions to reduce the agencies' and the manufacturers' uncertainty of engine test results. For example, in the agencies' confirmatory test procedures we are requiring that the agencies use the average of at least three tests (*i.e.*, the arithmetic mean of a sample size of at least three test results) for determining the values of confirmatory test results for any GEM engine fuel maps. We are only doing this for GEM engine fuel maps because these are relatively new tests, compared to Phase 1 testing or EPA's other emissions standards. Therefore, this provision does not apply to any other emissions testing. For all other emissions testing besides GEM engine fuel maps the agencies' maintain our usual convention of utilizing a sample size of one for confirmatory testing. For GEM engine fuel mapping this at least triples the test burden for the agencies to conduct confirmatory testing, but it also decreases confirmatory test result uncertainty by at least 42 percent.<sup>196</sup> Based on improvements like this one, and others described in Section 1.4 of the RTC, we believe that SET, FTP and GEM's steady-state, cycle-average and powertrain test results will have an overall uncertainty of  $\pm 1.0$  percent. To further protect against falsely high emissions results or false failures due to this remaining level of test procedure uncertainty, we have included a +1 percent compliance margin into our stringency analyses of the engine standards and the GEM fuel map inputs used to determine the tractor and vocational vehicle standards. In other words we set Phase 2 engine and vehicle standards 1 percent less stringent than if we had not considered this test procedure uncertainty.

<sup>196</sup> The statistical formula for standard error, which is a well-accepted measure of uncertainty, is the standard deviation times the reciprocal of the square root of the sample size. For a sample size of three, the reciprocal of the square root of three is approximately 0.58, which results in a 42% reduction in uncertainty, versus a sample size of one.

In addition to the test procedure improvements and the +1 percent margin we incorporated into our standards, the agencies are also committed to a process of continuous improvement of test procedures to further reduce test result uncertainty. To contribute to this effort, in mid-2016 EPA committed \$250,000 to fund research to further evaluate individual sources of engine mapping test procedure uncertainty. This work will occur at SwRI. Should the results of this work or other similar future work indicate test procedure improvements that would further reduce test result uncertainty, the agencies will incorporate these improvements through appropriate guidance or through technical amendments to the regulations via a notice and comment rulemaking. If we determine in the future through the SwRI work or other work that such improvements eliminate the need to require the agencies to conduct triplicate confirmatory testing of GEM engine fuel maps, we will promulgate technical amendments to the regulations to remove this requirement. If we determine in the future through the SwRI work or other work that the +1.0 percent we factored into our stringency analysis was inappropriately low or high, we will promulgate technical amendments to the regulations to address any inappropriate impact this +1.0 percent had on the stringency of the engine and vehicle standards.<sup>197</sup> In addition, whenever the agencies determine whether or not confirmatory test results are statistically significantly different from manufacturers' declared values, the agencies will use good engineering judgment to appropriately factor into such determinations the results of this SwRI work and/or any other future work that quantifies our test procedures' uncertainty.

**III. Class 7 and 8 Combination Tractors**

Class 7 and 8 combination tractors-trailers contribute the largest portion of the total GHG emissions and fuel consumption of the heavy-duty sector, approximately 60 percent, due to their large payloads, their high annual miles traveled, and their major role in national freight transport.<sup>198</sup> These vehicles

<sup>197</sup> Note that this +1.0 percent compliance margin built into the standards, or any other future determination of test procedure uncertainty, does not impact the agencies' technology feasibility or cost-benefit analyses for this rulemaking.

<sup>198</sup> The on-highway Class 7 and 8 combination tractor-trailers constitute the vast majority of this regulatory category. A small fraction of combination tractors are used in off-road applications and are regulated differently, as described in Section III.C.

<sup>195</sup> See 40 CFR 86.008–10(c).

consist of a cab and engine (tractor or combination tractor) and a trailer.<sup>199</sup> In general, reducing GHG emissions and fuel consumption for these vehicles will involve improvements to all aspects of the vehicle.

As we found during the development in Phase 1 and as continues to be true in the industry today, the heavy-duty combination tractor-trailer industry consists of separate tractor manufacturers and trailer manufacturers. We are not aware of any manufacturer that typically assembles both the finished truck and the trailer and introduces the combination into commerce for sale to a buyer. There are also large differences in the kinds of manufacturers involved with producing tractors and trailers. For HD highway tractors and their engines, a relatively limited number of manufacturers produce the vast majority of these

products. The trailer manufacturing industry is quite different, and includes a large number of companies, many of which are relatively small in size and production volume. Setting standards for the products involved—tractors and trailers—requires recognition of the large differences between these manufacturing industries, which can then warrant consideration of different regulatory approaches. Thus, although tractor-trailers operate essentially as a unit from both a commercial standpoint and for purposes of fuel efficiency and CO<sub>2</sub> emissions, the agencies have developed separate standards for each.

Based on these industry characteristics, EPA and NHTSA believe that the most appropriate regulatory approach for combination tractors and trailers is to establish standards for tractors separately from trailers. As discussed below in Section IV, the

agencies are also adopting standards for certain types of trailers.

#### A. Summary of the Phase 1 Tractor Program

The design of each tractor's cab and drivetrain determines the amount of power that the engine must produce in moving the truck and its payload down the road. As illustrated in Figure III-1, the loads that require additional power from the engine include air resistance (aerodynamics), tire rolling resistance, and parasitic losses (including accessory loads and friction in the drivetrain). The importance of the engine design is that it determines the basic GHG emissions and fuel consumption performance for the variety of demands placed on the vehicle, regardless of the characteristics of the cab in which it is installed.

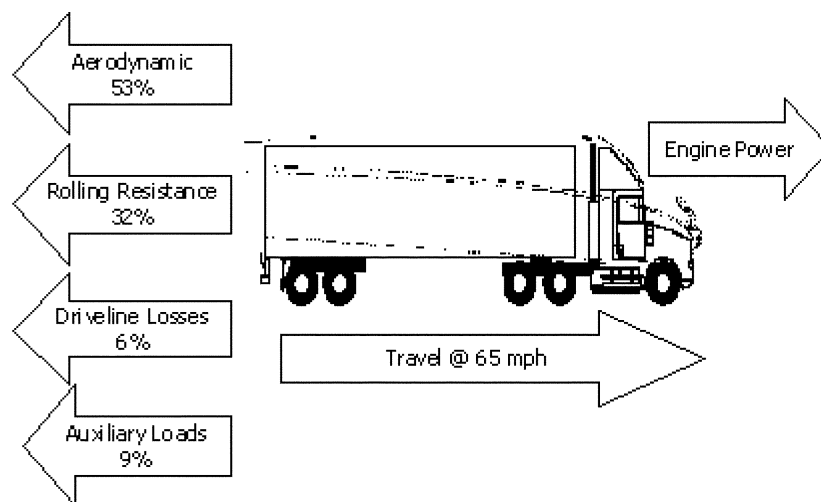

Figure III-1 Combination Tractor and Trailer Loads<sup>200</sup>

Accordingly, for Class 7 and 8 combination tractors, the agencies adopted two sets of Phase 1 tractor standards for fuel consumption and CO<sub>2</sub> emissions. The CO<sub>2</sub> emission and fuel consumption reductions related to engine technologies are recognized in the engine standards. For vehicle-related emissions and fuel consumption, tractor manufacturers are required to meet vehicle-based standards. Compliance with the vehicle standard must be determined using the GEM vehicle simulation tool.

The Phase 1 tractor standards were based on several key attributes related to GHG emissions and fuel consumption that reasonably represent the many differences in utility and performance among these vehicles. Attribute-based standards in general recognize the variety of functions performed by vehicles and engines, which in turn can affect the kind of technology that is available to control emissions and reduce fuel consumption, or its effectiveness. Attributes that characterize differences in the design of vehicles, as well as differences in how

the vehicles will be employed in-use, can be key factors in evaluating technological improvements for reducing CO<sub>2</sub> emissions and fuel consumption. Developing an appropriate attribute-based standard can also avoid interfering with the ability of the market to offer a variety of products to meet the customer's demand. The Phase 1 tractor standards differ depending on GVWR (*i.e.*, whether the truck is Class 7 or Class 8), the height of the roof of the cab, and whether it is a "day cab" or a "sleeper cab." These later two attributes are important

<sup>199</sup> "Tractor" is defined in 49 CFR 571.3 to mean "a truck designed primarily for drawing other motor vehicles and not so constructed as to carry a load

other than a part of the weight of the vehicle and the load so drawn."

<sup>200</sup> Adapted from Figure 4.1. Class 8 Truck Energy Audit, Technology Roadmap for the 21st Century

Truck Program: A Government-Industry Research Partnership, 21CT-001, December 2000.

because the height of the roof, designed to correspond to the height of the trailer, significantly affects air resistance, and a sleeper cab generally corresponds to the opportunity for extended duration idle emission and fuel consumption improvements. Based on these attributes, the agencies created nine subcategories within the Class 7 and 8 combination tractor category. The Phase 1 rules set standards for each of them. Phase 1 standards began with the 2014 model year and were followed with more stringent standards following in model year 2017.<sup>201</sup> The standards represent an overall fuel consumption and CO<sub>2</sub> emissions reduction up to 23 percent from the tractors and the engines installed in them when compared to a baseline 2010 model year tractor and engine without idle shutdown technology. Although the EPA and NHTSA standards are expressed differently (grams of CO<sub>2</sub> per ton-mile and gallons per 1,000 ton-mile respectively), the standards are equivalent.

In Phase 1, the agencies allowed manufacturers to certify certain types of combination tractors as vocational vehicles. These are tractors that do not typically operate at highway speeds, or would otherwise not benefit from efficiency improvements designed for line-haul tractors (although standards still apply to the engines installed in these vehicles). The agencies created a subcategory of “vocational tractors,” or referred to as “special purpose tractors” in 40 CFR part 1037, because real world operation of these tractors is better represented by our Phase 1 vocational vehicle duty cycle than the tractor duty cycles. Vocational tractors are subject to the standards for vocational vehicles rather than the combination tractor standards. In addition, specific vocational tractors and heavy-duty vocational vehicles primarily designed to perform work off-road or having tires installed with a maximum speed rating at or below 55 mph are exempted from the Phase 1 standards.

In Phase 1, the agencies also established separate performance standards for the engines manufactured for use in these tractors. EPA’s engine-based CO<sub>2</sub> standards and NHTSA’s engine-based fuel consumption standards are being implemented using EPA’s existing test procedures and regulatory structure for criteria pollutant emissions from medium- and heavy-duty engines. These engine standards

vary depending on engine size linked to intended vehicle service class (which are the same service classes used for many years for EPA’s criteria pollutant standards).

Manufacturers demonstrate compliance with the Phase 1 tractor standards using the GEM simulation tool. As explained in Section II above, GEM is a customized vehicle simulation model which is the preferred approach to demonstrating compliance testing for combination tractors rather than chassis dynamometer testing used in light-duty vehicle compliance. As discussed in the development of HD Phase 1 and recommended by the NAS 2010 study, a simulation tool is the preferred approach for HD tractor compliance because of the extremely large number of vehicle configurations.<sup>202</sup> The GEM compliance tool was developed by EPA and is an accurate and cost-effective alternative to measuring emissions and fuel consumption while operating the vehicle on a chassis dynamometer. Instead of using a chassis dynamometer as an indirect way to evaluate real world operation and performance, various characteristics of the vehicle are measured and these measurements are used as inputs to the model. For HD Phase 1, these characteristics relate to key technologies appropriate for this category of truck including aerodynamic features, weight reductions, tire rolling resistance, the presence of idle-reducing technology, and vehicle speed limiters. The model also assumes the use of a representative typical engine in compliance with the separate, applicable Phase 1 engine standard. Using these inputs, the model is used to quantify the overall performance of the vehicle in terms of CO<sub>2</sub> emissions and fuel consumption. CO<sub>2</sub> emission reduction and fuel consumption technologies not measured by the model must be evaluated separately, and the HD Phase 1 rules establish mechanisms allowing credit for such “off-cycle” technologies.

In addition to the final Phase 1 tractor-based standards for CO<sub>2</sub>, EPA adopted a separate standard to reduce leakage of HFC refrigerant from cabin air conditioning (A/C) systems from combination tractors that apply to the tractor manufacturer. This HFC leakage standard is independent of the CO<sub>2</sub> tractor standard. Manufacturers can

choose technologies from a menu of leak-reducing technologies sufficient to comply with the standard, as opposed to using a test to measure performance.

The Phase 1 program also provided several flexibilities to advance the goals of the overall program while providing alternative pathways to achieve compliance. The primary flexibility is the averaging, banking, and trading program which allows emissions and fuel consumption credits to be averaged within an averaging set, banked for up to five years, or traded among manufacturers. Manufacturers with credit deficits were allowed to carry-forward credit deficits for up to three model years, similar to the LD GHG and CAFE carry-back credits. Phase 1 also included several interim provisions, such as incentives for advanced technologies and provisions to obtain credits for innovative technologies (called off-cycle in the Phase 2 program) not accounted for by the HD Phase 1 version of GEM or for certifying early.

#### *B. Overview of the Phase 2 Tractor Program and Key Changes From the Proposal*

The HD Phase 2 program is similar in many respects to the Phase 1 approach. The agencies are keeping the Phase 1 attribute-based regulatory structure in terms of dividing the tractor category into the same nine subcategories based on the tractor’s GVWR, cab configuration, and roof height. This structure is working well in the implementation of Phase 1. EMA and Daimler supported this approach again in their comments to the Phase 2 NPRM. The one area where the agencies are changing the regulatory structure is related to heavy-haul tractors. As noted above, the Phase 1 regulations include a set of provisions that allow vocational tractors to be treated as vocational vehicles. However, because the agencies are including the powertrain as part of the technology basis for the tractor and vocational vehicle standards in Phase 2, we are classifying a certain set of these vocational tractors as heavy-haul tractors and subjecting them to a separate tractor standard that reflects their unique powertrain requirements and limitations in application of technologies to reduce fuel consumption and CO<sub>2</sub> emissions.<sup>203</sup> The agencies are adopting some revisions to the proposed Phase 2 criteria used to define heavy-haul tractors in response

<sup>201</sup> Manufacturers may have voluntarily opted-in to the NHTSA fuel consumption standards in model years 2014 or 2015. Once a manufacturer opts into the NHTSA program it must stay in the program for all optional MYs.

<sup>202</sup> National Academy of Science. “Technologies and Approaches to Reducing the Fuel Consumption of Medium- and Heavy-Duty Vehicles.” 2010. Recommendation 8–4 stated “Simulation modeling should be used with component test data and additional tested inputs from powertrain tests, which could lower the cost and administrative burden yet achieve the needed accuracy of results.”

<sup>203</sup> See 76 FR 57138 for Phase 1 discussion. See 40 CFR 1037.801 for Phase 2 heavy-haul tractor regulatory definition.

to comments, as discussed below in Section III.C.4.

The agencies will retain much of the certification and compliance structure developed in Phase 1. The Phase 2 tractor CO<sub>2</sub> emissions and fuel consumption standards, as in Phase 1, will be aligned.<sup>204</sup> The agencies will also continue to have separate engine and vehicle standards to drive technology improvements in both areas. The reasoning behind maintaining separate standards is discussed above in Section II.B.2. As in Phase 1, the manufacturers will certify tractors using the GEM simulation tool and evaluate the performance of subsystems through testing (the results of this testing to be used as inputs to the GEM simulation tool). Other aspects of the HD Phase 2 certification and compliance program also mirror the Phase 1 program, such as maintaining a single reporting structure to satisfy both agencies, requiring limited data at the beginning of the model year for certification, and determining compliance based on end of year reports. In the Phase 1 program, manufacturers participating in the ABT program provided 90 day and 270 day reports after the end of the model year. For the Phase 2 program, the agencies proposed that manufacturers would only be required to submit one end of the year report, which would have simplified reporting. Manufacturers provided comments opposing this approach. After further consideration, the agencies are adopting an approach in Phase 2 that mirrors the Phase 1 approach with a 90 day preliminary report and a 270 day final report, with the manufacturer having the option to request a waiver of the 90 day report based on positive credit balances.

Even though many aspects of the HD Phase 2 program are similar to Phase 1, there are some key differences. While Phase 1 focused on reducing CO<sub>2</sub> emissions and fuel consumption in tractors through the application of existing (“off-the-shelf”) technologies, the HD Phase 2 standards seek additional reductions through increased use of existing technologies and the development and deployment of more advanced technologies. The agencies received numerous comments on the proposed Phase 2 technology assessments in terms of the baseline, the technology effectiveness, the market adoption rate projections, and the technology costs. The agencies have made changes reflecting our assessment

of these comments, as described in Section III.D.

To evaluate the effectiveness of a more comprehensive set of technologies in Phase 2, the agencies are including several additional inputs to the Phase 2 GEM. The set of inputs includes the Phase 1 inputs plus parameters to assess the performance of the engine, transmission, and driveline. Specific inputs for, among others, predictive cruise control, automatic tire inflation systems, and 6x2 axles will now be required. The final Phase 2 program includes some changes to the proposed Phase 2 technology inputs to GEM. These changes from proposal include the use of cycle-averaged fuel maps for use when evaluating a vehicle over the transient cycle, optional transmission efficiency inputs, optional axle efficiency inputs, an increase in the types of idle reduction technologies recognized in GEM, and the ability to recognize the effectiveness of tire pressure monitoring systems, neutral coast, and neutral idle. As in Phase 1, in Phase 2 manufacturers will conduct component testing to obtain the values for these technologies (should they choose to use them), then the testing values will be input into the GEM simulation tool. See Section III.D.1 below. To effectively assess performance of the technologies, the agencies are adopting a revised version of the road grade profiles proposed for Phase 2. Finally, the agencies are adopting Phase 2 regulations with clarified selective enforcement and confirmatory testing requirements for the GEM inputs that differ from the Phase 2 NPRM based on the comments received.

The key aerodynamic assessment areas that the agencies proposed to change in Phase 2 relative to Phase 1 were the use of a more aerodynamic reference trailer, the inclusion of the impact of wind on the tractor, and changes to the aerodynamic test procedures. We are adopting these changes in Phase 2 with some further revisions from those proposed for Phase 2 based on comments. To reflect the evolving trailer market, the agencies are adopting as proposed the addition of trailer skirts (an aerodynamic improving device) to the reference trailer (*i.e.* the trailer used during testing to determine the relative aerodynamic performance of the tractor). The agencies are also adopting the proposed aerodynamic certification test procedure that captures the impact of wind average drag on tractor aerodynamic performance. However, the agencies are specifying in the final rule the use of a single surrogate yaw angle instead of a full

yaw sweep to reduce the aerodynamic testing burden based on further assessment of the EPA aerodynamic data and comments received on the NPRM. Finally, the agencies are adopting aerodynamic test procedure and data analysis changes from the Phase 2 proposal to further reduce the variability of aerodynamic test results. Detailed discussion of the aerodynamic test procedures is included in Section III.E.2.

Another key change to the final rule is the adoption of more stringent particulate matter (PM) standards for auxiliary power units (APU) installed in new tractors.<sup>205</sup> In the Phase 2 NPRM, EPA sought comment on the need for and feasibility of new PM standards for these engines because APUs can be used in lieu of operating the main engine during extended idle operations to provide climate control and power to the driver. See 80 FR 40213. APUs can reduce fuel consumption, NO<sub>x</sub>, HC, CH<sub>4</sub>, and CO<sub>2</sub> emissions when compared to main engine idling.<sup>206</sup> However, a potential unintended consequence of reducing CO<sub>2</sub> emissions from combination tractors through the use of APUs during extended idle operation is an increase in PM emissions. EPA is adopting requirements for APUs installed in new tractors to meet lower PM standards starting in 2018, with a more stringent PM standard starting in 2024. Please see Section III.C.3 for more details.

The agencies are also ending some of the interim provisions developed in Phase 1 to reflect the maturity of the program and the reduced need and justification for some of the Phase 1 flexibilities. Further discussions on all of these matters are covered in the following sections.

### C. Phase 2 Tractor Standards

EPA is adopting CO<sub>2</sub> standards and NHTSA is adopting fuel consumption standards for new Class 7 and 8 combination tractors in Phase 2 that are more stringent than Phase 1. In addition, EPA is continuing the HFC standards for the air conditioning systems that were adopted in Phase 1. EPA is also adopting new standards to further control emissions of particulate matter (PM) from auxiliary power units (APU) installed in new tractors that will prevent an unintended consequence of

<sup>205</sup> This is necessarily an EPA-only provision since it relates to control of criteria pollutant emissions from a type of non-road engine, not to fuel efficiency.

<sup>206</sup> U.S. EPA. Development of Emission Rates for Heavy-Duty Vehicles in the Motor Vehicle Emissions Simulator MOVES 2010. EPA-420-B-12-049. August 2012.

<sup>204</sup> Fuel consumption is calculated from CO<sub>2</sub> using the conversion factor of 10,180 grams of CO<sub>2</sub> per gallon for diesel fuel.

increasing PM emissions during long duration idling.

This section describes these standards in detail.

(1) Final Fuel Consumption and CO<sub>2</sub> Standards

The Phase 2 fuel consumption and CO<sub>2</sub> standards for the tractor cab are shown below in Table III–1. These standards will achieve reductions of up

to 25 percent compared to the 2017 model year baseline level when fully phased in for the 2027 MY.<sup>207</sup> The standards for Class 7 are described as “Day Cabs” because we are not aware of any Class 7 sleeper cabs in the market today; however, the agencies require any Class 7 tractor, regardless of cab configuration, meet the standards described as “Class 7 Day Cab.”

The agencies’ analyses, as discussed briefly below and in more detail later in this Preamble and in the RIA Chapter 2.4 and 2.8, indicate that these standards are the maximum feasible (within the meaning of 49 U.S.C. 32902(k)) and are appropriate under each agency’s respective statutory authorities.

TABLE III–1—PHASE 2 HEAVY-DUTY COMBINATION TRACTOR EPA EMISSIONS STANDARDS (g CO<sub>2</sub>/TON-MILE) AND NHTSA FUEL CONSUMPTION STANDARDS (GAL/1,000 TON-MILE)

	Day cab		Sleeper cab	Heavy-haul
	Class 7	Class 8	Class 8	Class 8
<b>2021 Model Year CO<sub>2</sub> Grams per Ton-Mile</b>				
Low Roof .....	105.5	80.5	72.3	52.4
Mid Roof .....	113.2	85.4	78.0	.....
High Roof .....	113.5	85.6	75.7	.....
<b>2021 Model Year Gallons of Fuel per 1,000 Ton-Mile</b>				
Low Roof .....	10.36346	7.90766	7.10216	5.14735
Mid Roof .....	11.11984	8.38900	7.66208	.....
High Roof .....	11.14931	8.40864	7.43615	.....
<b>2024 Model Year CO<sub>2</sub> Grams per Ton-Mile</b>				
Low Roof .....	99.8	76.2	68.0	50.2
Mid Roof .....	107.1	80.9	73.5	.....
High Roof .....	106.6	80.4	70.7	.....
<b>2024 Model Year and Later Gallons of Fuel per 1,000 Ton-Mile</b>				
Low Roof .....	9.80354	7.48527	6.67976	4.93124
Mid Roof .....	10.52063	7.94695	7.22004	.....
High Roof .....	10.47151	7.89784	6.94499	.....
<b>2027 Model Year CO<sub>2</sub> Grams per Ton-Mile<sup>a</sup></b>				
Low Roof .....	96.2	73.4	64.1	48.3
Mid Roof .....	103.4	78.0	69.6	.....
High Roof .....	100.0	75.7	64.3	.....
<b>2027 Model Year and Later Gallons of Fuel per 1,000 Ton-Mile</b>				
Low Roof .....	9.44990	7.21022	6.29666	4.74460
Mid Roof .....	10.15717	7.66208	6.83694	.....
High Roof .....	9.82318	7.43615	6.31631	.....

**Note:**

<sup>a</sup> The 2027 MY high roof tractor standards include a 0.3 m<sup>2</sup> reduction in CdA as described in Section III.E.2.a.vii.

As the agencies noted in the Preamble to the proposed standards, the HD Phase 2 CO<sub>2</sub> and fuel consumption standards are not directly comparable to the Phase 1 standards. 80 FR 40212. This is because the agencies are adopting several test procedure changes to more accurately reflect real world operation. With respect to tractors, these changes will result in the following differences. First, the same vehicle evaluated using

the HD Phase 2 version of GEM will obtain higher (*i.e.* less favorable) CO<sub>2</sub> and fuel consumption values because the Phase 2 drive cycles include road grade. Road grade, which (of course) exists in the real-world, requires the engine to operate at higher horsepower levels to maintain speed while climbing a hill. Even though the engine saves fuel on a downhill section, the overall impact increases CO<sub>2</sub> emissions and fuel

consumption. The second of the key differences between the CO<sub>2</sub> and fuel consumption values in Phase 1 and Phase 2 is due to changes in the evaluation of aerodynamics. Vehicles are exposed to wind when in use which increases the drag of the vehicle and in turn increases the power required to move the vehicle down the road. To more appropriately reflect the in-use aerodynamic performance of tractor-

<sup>207</sup> Since the HD Phase 1 tractor standards fully phase-in by the MY 2017, this is the logical baseline year.

trailers, the agencies are adopting a wind averaged coefficient of drag instead of the no-wind (zero yaw) value used in Phase 1. The final key difference between Phase 1 and the Phase 2 program includes a more realistic and improved simulation of the transmission in GEM, which could increase CO<sub>2</sub> and fuel consumption relative to Phase 1.

The agencies are adopting Phase 2 CO<sub>2</sub> emissions and fuel consumption standards for the combination tractors that reflect reductions that can be achieved through improvements in the tractor's powertrain, aerodynamics, tires, and other vehicle systems. The agencies have analyzed the feasibility of achieving the CO<sub>2</sub> and fuel consumption standards, and have identified means of achieving these standards that are technically feasible in the lead time afforded, economically practicable and cost-effective. EPA and NHTSA present the estimated costs and benefits of these standards in Section III.D.1. In developing these standards for Class 7 and 8 tractors, the agencies have evaluated the following:

- The current levels of emissions and fuel consumption
- the types of technologies that could be utilized by tractor and engine manufacturers to reduce emissions and fuel consumption from tractors and associated engines
- the necessary lead time
- the associated costs for the industry
- fuel savings for the consumer
- the magnitude of the CO<sub>2</sub> and fuel savings that may be achieved

The technologies on whose performance the final tractor standards are predicated include: improvements in the engine, transmission, driveline, aerodynamic design, tire rolling resistance, other accessories of the tractor, and extended idle reduction technologies. These technologies, and other accessories of the tractor, are described in RIA Chapter 2.4 and 2.8. The agencies' evaluation shows that some of these technologies are available today, but have very low adoption rates on current vehicles, while others will require some lead time for development. EPA and NHTSA also present the estimated costs and benefits of the Class 7 and 8 combination tractor standards in RIA Chapter 2.8 and 2.12, explaining as well the basis for the agencies' stringency level.

As explained below in Section III.D, EPA and NHTSA have determined that there will be sufficient lead time to introduce various tractor and engine technologies into the fleet starting in the 2021 model year and fully phasing in by

the 2027 model year. This is consistent with NHTSA's statutory requirement to provide four full model years of regulatory lead time for standards. As was adopted in Phase 1, the agencies are adopting provisions for Phase 2 that allow manufacturers to generate and use credits from Class 7 and 8 combination tractors to show compliance with the standards. This is discussed further in Section III.F.

Based on our analysis, the 2027 model year standards for combination tractors and engines represent up to a 25 percent reduction in CO<sub>2</sub> emissions and fuel consumption over a 2017 model year baseline tractor, as detailed in Section III.D.1. In considering the feasibility of vehicles to comply with these standards over their useful lives, EPA also considered the potential for CO<sub>2</sub> emissions to increase during the regulatory useful life of the product. As we discuss in Phase 1 and separately in the context of deterioration factor (DF) testing, we have concluded that CO<sub>2</sub> emissions are likely to stay the same or actually decrease in-use compared to new certified configurations for the projected technologies. In general, engine and vehicle friction decreases as products wear, leading to reduced parasitic losses and consequent lower CO<sub>2</sub> emissions. Similarly, tire rolling resistance falls as tires wear due to the reduction in tread depth. In the case of aerodynamic components, we project no change in performance through the regulatory life of the vehicle since there is essentially no change in their physical form as vehicles age. Similarly, weight reduction elements such as aluminum wheels are not projected to increase in mass through time, and hence, we can conclude will not deteriorate with regard to CO<sub>2</sub> emissions performance in-use. Given all of these considerations, the agencies are confident in projecting that the tractor standards today will be technically feasible throughout the regulatory useful life of the program.

#### (2) Non-CO<sub>2</sub> GHG Emission Standards for Tractors

EPA is also continuing the Phase 1 standards to control non-CO<sub>2</sub> GHG emissions from Class 7 and 8 combination tractors.

#### (a) N<sub>2</sub>O and CH<sub>4</sub> Emissions

The final Phase 2 heavy-duty engine standards for both N<sub>2</sub>O and CH<sub>4</sub> as well as details of these standards are included in the discussion in Section II.D.3 and II.D.4. EPA requested comment, but did not receive any comments (or otherwise obtain any new information) indicating that there were

appropriate controls for these non-CO<sub>2</sub> GHG emissions for the tractors manufacturers. Nor does EPA believe there are any technologies available to set vehicle standards. Therefore, EPA is not adopting any additional controls for N<sub>2</sub>O or CH<sub>4</sub> emissions beyond those in the HD Phase 2 engine standards for the tractor category.

#### (b) HFC Emissions

Manufacturers can reduce hydrofluorocarbon (HFC) emissions from air conditioning (A/C) leakage emissions in two ways. First, they can utilize leak-tight A/C system components. Second, manufacturers can largely eliminate the global warming impact of leakage emissions by adopting systems that use an alternative, low-Global Warming Potential (GWP) refrigerant, to replace the commonly used R-134a refrigerant. EPA is maintaining the A/C leakage standards adopted in HD Phase 1 (see 40 CFR 1037.115). EPA believes the Phase 1 use of leak-tight components is at an appropriate level of stringency while maintaining the flexibility to produce the wide variety of A/C system configurations required in the tractor category. Please see Section I.F.(1)(b) for a discussion related to alternative refrigerants.

#### (3) EPA's PM Emission Standards for APUs Installed in New Tractors

Auxiliary power units (APUs) can be used in lieu of operating the main engine during extended idle operations to provide climate control and additional hotel power for the driver. As noted above, APUs can reduce fuel consumption, NO<sub>x</sub>, HC, CH<sub>4</sub>, and CO<sub>2</sub> emissions by a meaningful amount when compared to main engine idling.<sup>208</sup> However, a potential unintended consequence of reducing CO<sub>2</sub> emissions from combination tractors through the use of APUs during extended idle operation is an increase in diesel PM emissions. Engines currently being used to power APUs have been subject to the Nonroad Tier 4 p.m. standards (40 CFR 1039.101), which are less stringent in this power category than the heavy-duty on-highway standards (40 CFR 86.007-11) on a brake-specific basis. In the NPRM, EPA sought comment on the need for and appropriateness of further reducing PM emissions from APUs used as part of a compliance strategy for Phase 2, and suggested the basis for possible new PM

<sup>208</sup> U.S. EPA. Development of Emission Rates for Heavy-Duty Vehicles in the Motor Vehicle Emissions Simulator MOVES 2010. EPA-420-B-12-049. August 2012.

standards to avoid these unintended consequence. 80 FR 40213.

After considering the numerous comments submitted on this issue and our consideration of feasibility of PM controls, EPA is adopting a new PM standard of 0.02 g/kW-hr that applies exclusively to APUs installed in MY 2024 and later new tractors. EPA is also amending the Phase 1 GHG standards to provide that as of January 1, 2018 and through MY 2020, a tractor can receive credit for use of an AESS with an APU installed at the factory only if the APU engine is certified under 40 CFR part 1039 with a deteriorated emission level for PM that is at or below 0.15 g/kW-hr. For MY 2021 through 2023, this same emission level applies as a standard for all new tractors with an APU installed. Starting in MY 2024, any

APU installed in a new tractor must be certified to a PM emission standard of 0.02 g/kW-hr over the full useful life as specified in 40 CFR 1039.699. Engine manufacturers may alternatively meet the APU standard by certifying their engines under 40 CFR part 1039 with a Family Emission Limit for PM at or below 0.02 g/kW-hr. APUs installed on MY 2024 and later tractors must have a label stating that the APU meets the PM requirements of 40 CFR 1039.699. Tractor manufacturers will be subject to a prohibition against selling new MY 2024 and later tractors with APUs that are not certified to the specified standards, and manufacturers will similarly be subject to a prohibition against selling new MY 2021 through 2023 tractors with APUs that do not meet the specified emission levels. This

applies for both new and used APUs installed in such new tractors. Manufacturers of new nonroad engines and new APUs may continue to produce and sell their products for uses other than installation in new tractors without violating these prohibitions. However, nonroad engine manufacturers and APU manufacturers would be liable if they are found to have caused a tractor manufacturer to violate this prohibition, such as by mislabeling an APU as compliant with this standard. Note also that the PM standard for APUs applies for new tractors, whether or not the engine and APU are new; conversely, the PM standard does not apply for APU retrofits on tractors that are no longer new, even if the engine and APU are new.

TABLE III-2—PM STANDARDS FOR TRACTORS USING APUS

Tractor MY	PM emission standard (g/kW-hr)	Expected control technology
MY 2021–2023 <sup>a</sup>	0.15	In-cylinder PM control.
MY 2024 and later	0.02	Diesel Particulate Filter.

**Note:**

<sup>a</sup> APUs installed on new tractors built January 1, 2018 and later, through model year 2020, must have engines that meet the same 0.15 g/kW-hr emission level if they rely on AESS for demonstrating compliance with emission standards.

We discuss below the principal comments we received on whether to adopt a standard to control PM emissions from APUs used for tractor idle emission control, the basis for the amended standards, and how EPA envisions the standards operating in practice.

Among the comments we received were those from the American Lung Association, National Association of Clean Air Agencies, Northeast States for Coordinated Air Use Management, Environmental Defense Fund, Natural Resources Defense Council, Environmental Law and Policy Center, Coalition for Clean Air/California Cleaner Freight Coalition, Moving Forward Network, Ozone Transport Commission, and the Center for Biological Diversity that urged EPA to amend the standards for PM emissions from these engines in order to reduce PM emission increases resulting from increased APU use. Bendix commented that EPA should consider the full vehicle emissions and fuel consumption, including the APU, to create a more accurate comparison when considering alternatives to diesel powered APUs. California’s ARB supported the development of a federal rule that requires DPFs on APUs, similar to the requirements already in place in

California because diesel PM poses a large public health risk.

In contrast, EMA commented that EPA should not impose any new emission requirements on APU engines because they already meet the Tier 4 nonroad standards and argued further that this rulemaking is not the proper forum for amending nonroad engine emission standards. Ingersoll Rand commented that they have significant concerns with regard to a nationwide requirement for use of DPFs in diesel-powered APUs, and strongly urged EPA not to impose such a perceived burden on the trucking industry. Ingersoll Rand’s concerns are that the additional cost would push owners away from diesel-powered APUs to battery-powered APUs that, according to Ingersoll Rand, are not yet mature enough to serve as a replacement for diesel-powered APUs. Ingersoll Rand believes that high-capacity battery-powered APUs will eventually become a commercially available and cost-effective alternative to diesel-powered APUs. Ingersoll Rand stated that, although Thermo King has been dedicating resources to research and development in this area for some time, mandating this technology today would significantly decrease consumer choice, competitiveness in the APU marketplace, and driver comfort and

safety. ATA is concerned that efforts to place additional emissions controls, and therefore additional costs, on APUs by making PM standards more stringent will discourage the use of this fuel efficient technology. EPA considered Ingersoll Rand’s comments in developing a phased-in approach to the new PM standards for new tractors using APUs to, having the principal standard apply commencing with MY 2024 tractors in order to provide sufficient lead time.

Following is discussion of our analysis of this issue in light of the information we received and of our decision to establish a new PM standard for these units.

(a) PM Emissions Impact Without Additional Controls

EPA conducted an analysis using MOVES, which evaluates the potential impact on PM emissions due to an increase in APU adoption rates. In this analysis, EPA assumed that PM emission rates from current technology APUs would be unchanged in the future. We estimated an average in-use APU emission rate of 0.96 grams PM per hour from three in-use APUs (model years 2006 and 2011), measured in



different load conditions.<sup>209</sup> We determined that a typical 2010 model year or newer tractor that uses its main engine to idle emits 0.32 grams PM per hour, based on a similar analysis of in-use idling of emissions from 2010 model year and newer tractors.<sup>12</sup> Thus, the use of an APU would lead to a potential increase in PM of as much as 0.64 grams per hour.

The results from these MOVES runs are shown below in Table III–3. These results show that an increase in use of APUs could lead to an overall increase in PM emissions if no additional PM emission standards were put in place. Column three labeled “Final Phase 2 GHG Program PM<sub>2.5</sub> Emission Impact without Further PM Control (tons)” shows the incremental increase in PM<sub>2.5</sub> without further regulation of APU PM<sub>2.5</sub>

emissions, assuming the rate of APU use on which the final CO<sub>2</sub> standard is premised. These PM emission impacts represent an increase of approximately three percent of the HD sector PM emissions. We note further that the pollutant at issue is diesel PM, which is associated with myriad serious health effects, including premature mortality. See Section VIII.A.6 below.

TABLE III–3—PROJECTED IMPACT OF INCREASED ADOPTION OF APUS IN PHASE 2

CY	Baseline HD vehicle PM <sub>2.5</sub> emissions (tons)	Final phase 2 GHG program PM <sub>2.5</sub> <sup>a</sup> emission impact without further PM control (tons) <sup>b</sup>
2040 .....	20,939	464
2050 .....	22,995	534

**Note:**

<sup>a</sup> Positive numbers mean emissions would increase from baseline to control case.

<sup>b</sup> The impacts shown include all PM<sub>2.5</sub> impacts from the rule including impacts from increased tire wear and brake wear that results from the slight increase in VMT projected as a result of this rule.

(b) Feasibility of PM Emission Reductions

As EPA discussed in the NPRM, there are DPFs in the marketplace today that can reduce PM emissions from APUs. 80 FR 40213. Since January 1, 2008, California ARB has restricted the idling of sleeper cab tractors during periods of sleep and rest.<sup>210</sup> The regulations apply additional requirements to diesel-fueled APUs on tractors equipped with 2007 model year or newer main engines. Truck owners in California must either: (1) Fit the APU with an ARB verified Level 3 particulate control device that achieves 85 percent reduction in particulate matter; or (2) have the APU exhaust plumbed into the vehicle’s exhaust system upstream of the particulate matter aftertreatment device.<sup>211</sup> Currently ARB has identified four control devices that have been verified to meet the Level 3 p.m. requirements. These devices include HUSS Umwelttechnik GmbH’s FS–MK Series Diesel Particulate filters, Impco Ecotrans Technologies’ ClearSky Diesel Particulate Filter, Thermo King’s Electric Regenerative Diesel Particulate Filter, and Proventia’s Electronically Heated Diesel Particulate Filter. In addition, ARB has approved a Cummins integrated diesel-fueled APU and

several fuel-fired heaters produced by Espar and Webasto.

EPA received comments from Daimler, Idle Smart, MECA, and Proventia addressing the feasibility of PM reductions from APU engines. Daimler stated that they supply APUs that currently meet ARB’s PM emission requirements and encouraged EPA to simply adopt ARB’s regulations. Proventia commented that they have produced an ARB-approved actively regenerating DPF to fit the Thermo King Tripac APU since 2012 and that it is proven, reliable, and commercially available. Idle Smart commented that their start-stop idle reduction solution emits less PM emissions than a diesel APU without a DPF. MECA commented that a particulate filter in this application would be a wall flow device and, due to the relatively cold exhaust temperature of these small engines, the filters would need to use either all active or a combination of passive and active regeneration to periodically clean the soot from the filter. MECA stated that active regeneration could be achieved through the use of a fuel burner or electric heater upstream of the filter. MECA also stated that ARB’s regulations demonstrate that it is feasible to control PM from small APU engines and that the technology has been available since 2008.

California’s Clean Idle program requires that diesel-powered APUs be fitted with a verified DPF. In some cases, limits are put on the PM emission level at the engine outlet (upstream of the DPF). For example, the ThermoKing APU approval utilizing a Yanmar engine requires that engine is certified to a PM level of 0.2 g/kW-hr or less (upstream of the DPF).<sup>212</sup> Implementation of the California program and the subsequent approval of Level 3 verified devices has led to the certification of engines utilized in APUs whose PM emissions at the engine outlet are well below the 0.4 g/kW-hr nonroad Tier 4 final standard for this size engine in 40 CFR part 1039. For example, the Yanmar TK270M engine that is used in combination with ThermoKing’s electronic regenerative diesel particulate filter, which is certified under the EPA designated engine family GYDXL0.57NUA, is certified with a PM level of 0.09 g/kW-hr. The addition of a DPF affords at least an additional 85 percent reduction from the engine outlet certified value, or less than 0.014 g/kW-hr.

EPA believes that these comments confirm our discussion at proposal that PM standards reflecting performance of a diesel particulate filter are technically feasible.

<sup>209</sup> U.S. EPA. Updates to MOVES for Emissions Analysis of Greenhouse Gas Emissions and Fuel Efficiency Standards for Medium- and Heavy-Duty Engines and Vehicles—Phase 2 FRM. Docket Number EPA–HQ–OAR–2014–0827. July 2016.

<sup>210</sup> California Air Resources Board. Idle Reduction Technologies for Sleeper Berth Trucks. Last viewed on September 19, 2014 at <http://www.arb.ca.gov/msprog/cabcomfom/cabcomfom.htm>.

<sup>211</sup> California Air Resources Board. § 2485(c)(3)(A)(1).

<sup>212</sup> California Air Resources Board. Executive Order DE–12–006. Last viewed on June 21, 2016 at [http://www.arb.ca.gov/diesel/verdev/pdf/executive\\_orders/de-12-006.pdf](http://www.arb.ca.gov/diesel/verdev/pdf/executive_orders/de-12-006.pdf).

(c) Benefits of Further PM Controls

Using MOVES, EPA evaluated the impact of requiring further PM control from APUs nationwide. As shown in Table III–3 and Table III–4, EPA projects that the HD Phase 2 program without additional PM controls would increase PM<sub>2.5</sub> emissions by 464 tons in 2040 and 534 tons in 2050. The annual impact of

the final program to further control PM is projected to lead to a reduction of PM<sub>2.5</sub> emissions nationwide by 927 tons in 2040 and by 1,114 tons in 2050, as shown in Table III–4 the column labeled “Net Impact on National PM<sub>2.5</sub> Emission (tons).” Note that these requirements will reduce PM emissions from APUs assumed in the baseline for MY 2018

and later, as well as the additional APUs that are projected to be used as a result of the Phase 2 standards. This results in projected reductions that exceed the projected increase in PM emissions that would have occurred with the new Phase 2 GHG standards but without these newly promulgated APU standards.

TABLE III–4—PROJECTED IMPACT OF FURTHER CONTROL ON PM<sub>2.5</sub> EMISSIONS <sup>a</sup>

CY	Baseline national heavy-duty vehicle PM <sub>2.5</sub> emissions (tons)	HD Phase 2 program national PM <sub>2.5</sub> emissions without further PM control (tons)	HD Phase 2 program national PM <sub>2.5</sub> emissions with further PM control (tons)	Net impact on national PM <sub>2.5</sub> emission with further PM control of APUs (tons)
2040 .....	20,939	21,403	20,476	– 927
2050 .....	22,995	23,529	22,416	– 1,114

**Note:**

<sup>a</sup> The impacts shown include all PM<sub>2.5</sub> impacts from the rule including impacts from increased tire wear and brake wear that results from the slight increase in VMT projected as a result of this rule.

(d) PM Emission Reduction Technology Costs

EPA does not project any cost for meeting the requirement, commencing on January 1, 2018, that tractor manufacturers using APUs as part of a compliance path to meeting the Phase 1 GHG standards only receive credit in GEM for use of the APU if they use an APU with an engine with deteriorated PM emissions at or below 0.15 g/kW-hr. The same conclusion applies for MY 2021, when we adopt the PM emission level of 0.15 g/kW-hr as an emission standard, not only as a qualifying condition for using AESSE for demonstrating compliance with the CO<sub>2</sub> standard. First, EPA projects that the 2018–2023 requirements can be achieved at zero cost because several engines are already meeting them today with in-cylinder controls. Second, this is only one of many potential compliance pathways for tractors meeting the Phase 1 standards. We nonetheless are providing extra lead time by tying this provision to calendar year 2018, rather than model year 2018, to allow manufacturers time for confirming emission levels and otherwise complying with administrative requirements.

PM emission reductions from APU engines beginning in MY 2024 would most likely be achieved through installation of a diesel particulate filter (DPF).<sup>213</sup> In the NPRM, EPA discussed several sources for DPF cost estimates.

<sup>213</sup> As discussed below, a DPF could be installed by the APU manufacturer, the engine manufacturer, the tractor manufacturer, or a fourth entity, with certification and labelling responsibilities differing depending on which entity does the installation.

The three sources included the federal Nonroad Diesel Tier 4 rule, ARB, and Proventia. EPA developed long-term cost projections for catalyzed diesel particulate filters (DPF) as part of the Nonroad Diesel Tier 4 rulemaking. In that rulemaking, EPA estimated the DPF costs would add \$580 to the cost of 150 horsepower engines (69 FR 39126, June 29, 2004). On the other hand, ARB estimated the cost of retrofitting a diesel powered APU with a PM trap to be \$2,000 in 2005.<sup>214</sup> Proventia is charging customers \$2,240 for electronically heated DPF for retrofitting existing APUs.<sup>215</sup>

EPA requested comment on DPF costs in the NPRM and received comments from MECA, Proventia, and Ingersoll Rand. MECA agreed with EPA’s range of DPF costs discussed in the NPRM. Proventia stated that the \$2,240 end user price cited in the NPRM is for an aftermarket retrofit device. Proventia estimated that the direct manufacturing cost of materials and manufacturing (which is less than the retail price equivalent) for quantities exceeding 10,000 annually would be \$975 for an actively regenerating device. The basis for this estimate is Proventia’s current production cost in the quantity of 50 units of \$1069. Proventia stated that EPA’s estimate of \$580 for a 150hp

<sup>214</sup> California Air Resources Board. Staff Report: Initial Statement of Reasons; Notice of Public Hearing to Consider Requirements to Reduce Idling Emissions From New and In-Use Trucks, Beginning in 2008. September 1, 2005. Page 38. Last viewed on October 20, 2014 at <http://www.arb.ca.gov/regact/hdvidle/isor.pdf>.

<sup>215</sup> Proventia. Tripac Filter Kits. Last accessed on October 21, 2014 at <http://www.proventiafilters.com/purchase.html>.

engine is likely to be for a catalyzed passively regenerating DPF because those engines have higher exhaust temperatures. Proventia also stated that a cost of an actively regenerating DPF is significantly higher than for passively regenerating devices. Ingersoll Rand commented that Thermo King currently offers a DPF option on its line of diesel-powered APUs and the incremental price of the DPF option can be as high as \$3,500. ATA commented that adding a DPF to an APU increases the cost of the device by up to 20 percent. Daimler provided DPF costs as CBI.

EPA considered the comments and more closely evaluated NHTSA’s contracted TetraTech cost report which found the total retail price of a diesel-powered APU that includes a DPF to be \$10,000.<sup>216</sup> Based on all of this information, EPA is projecting the retail price increment of an actively regenerating DPF installed in an APU to be \$2,000. This cost is incremental to the diesel-powered APU technology costs beginning in 2024 MY.

EPA regards these costs as reasonable. First, the PM standard is necessary to avoid an unintended consequence of GHG idle control. The standard adopted is also appropriate for APUs used in on-highway applications, since it is comparable to the heavy-duty on-highway standard after considering rounding conventions (the PM standard for a tractor’s main engine is 0.01 g/hp-hr as specified in 40 CFR 86.007–11(a)(1)(iv)). The standard is also voluntary in the sense that tractor

<sup>216</sup> U.S. DOT/NHTSA. Commercial Medium- and Heavy-Duty Truck Fuel Efficiency Technology Cost Study. May 2015. Page 71.

manufacturers can use other types of idle reducing technologies, or choose a Phase 2 compliance path not involving idle control. The agencies have developed technology packages for determining the final Phase 2 tractor GHG and fuel consumption standards that are predicated on lower penetration rates of diesel APUs than in the NPRM and have included several additional idle reducing technologies, making it more likely that alternative compliance paths are readily available. APU manufacturers (and manufacturers of APU engines) also can market their product to any entities other than MY 2024 and later new tractors without meeting the DPF-based PM standard. Our review of the costs of these standards thus indicates that they will be reasonable.

It is also worth noting that the reductions also have monetized benefits far greater than the costs of the standard. Section IX.H.1 of this Preamble discusses the economic value of reductions in criteria pollutants. In this analysis, EPA estimates the economic value of the human health benefits associated with the resulting reductions in PM<sub>2.5</sub> exposure using what are known as “benefit per ton” values. The benefit per ton values estimate the benefits of reducing incidence of specific PM<sub>2.5</sub>-related health impacts, including reduction in both premature mortality and premature morbidity from on-road mobile sources. The estimate of benefits from reducing one ton of direct PM<sub>2.5</sub> from on-road mobile sources in 2030 using a three percent discount rate range is between \$490,000 and \$1,100,000 (2013\$) and is between \$440,000 and \$990,000 (2013\$) using a seven percent discount rate.<sup>217</sup> The estimated cost per ton for the new APU standards in 2040 is \$101,717.

#### (e) Other Considerations

EPA considered the lead time of the new PM standards for APUs installed in new tractors. The 2018 provision restricting GEM credit for use of APUs is not a new standard, but rather a compliance constraint. There should be ample time for tractor manufacturers to consider how to obtain APUs certified

<sup>217</sup> This valuation is undoubtedly conservative because it reflects exposure to PM<sub>2.5</sub> generally, rather than to the form of PM here: Diesel exhaust particulate, a likely human carcinogen. See section VIII.A.6.b. Due to underlying analytical limitations, PM<sub>2.5</sub>-related benefit per ton values are only estimated out to the year 2030. For the criteria pollutant benefits analysis in this rulemaking, we make a conservative assumption that 2030 values apply to all emission reductions in years that extend beyond 2030. We assume benefit-per-ton values grow larger in the future due to income growth and a larger future population.

to the designated deteriorated PM emissions level should they wish to receive GEM credit for use of APUs. As noted in (d) above, we concluded that the reasonable feasible lead time is to implement these provisions on January 1, 2018 because the manufacturer’s contemplating use of APUs in conjunction with a Phase 1 compliance strategy using AESS would need time to adapt their certification systems, which we believe requires lead time of at least several months.

In MY 2021, tractor manufacturers will be subject to a prohibition against selling new MY 2021 through 2023 tractors with APUs that do not meet those specified PM emission levels. For the reasons just given, there is ample time to meet this requirement.

The diesel particulate filter-based standard for APUs installed in new tractors begins in MY 2024. This allows several years for the development and application of diesel particulate filters to these APUs. We have concluded that, given the timing of the PM emission standards finalized in this document and the availability of the technologies, APUs can be designed to meet the new standards with the lead time provided (and, again, noting that tractor manufacturers have available compliance pathways available not involving APUs).

In terms of safety, EPA considered the fact that diesel particulate filters are a known technology. DPFs have been installed on a subset of diesel powered APUs since the beginning of the California requirements and have been used with on-highway diesel engines since the sale of MY 2007 engines. We are unaware of any safety issues with this technology. We are adopting these APU requirements because they allow for reduced fuel consumption; this also leads to a positive impact with respect to energy.

#### (f) Implementation of the Standard

EPA has a choice as to whether to adopt these provisions as a tractor vehicle standard or as a standard for the non-road engine in the APU. Under either approach, EPA is required to consider issues of technical feasibility, cost, safety, energy, and lead time. EPA has addressed all of these factors above, and finds the 2018, 2021, and 2024 provisions, and associated lead time, to be justified.<sup>218</sup>

The final rule applies most directly to tractor manufacturers. However, other entities potentially affected are the manufacturer of the APU, the

<sup>218</sup> As noted above, the 2018 provision is a compliance constraint, not a standard.

manufacturer of the engine installed in the APU, and a different entity (if any) separately installing a DPF on the APU engine. At present, all engines used in APUs must certify to the PM standard in 40 CFR 1039.101, and must label the engine accordingly (see 40 CFR 1039.135). The provisions we are adopting for MY 2024 require that any APU engine being certified to the 0.02 g/kW-hr PM standard have a label indicating that the APU or engine is so certified. This puts any entity receiving that engine on notice that the APU (and its engine) can be used in a new tractor. Conversely, the absence of such a label indicates that the engine cannot be so used. Consequently, if a tractor manufacturer receives an APU without the supplemental label, it can only use the APU in a new tractor if it installs a DPF or otherwise retrofits the APU engine to meet the PM standard.

The APU certification provisions in 40 CFR 1039.699 are simplified to account for the fact that the APU manufacturer would generally be adding emission control hardware without modifying the engine from its certified configuration. Note that engine manufacturers, tractor manufacturers or others installing the emission control hardware may also certify to the 0.02 g/kW-hr standard. Since the prohibition applies to the tractor manufacturer, we would not expect the delegated assembly provisions of 40 CFR 1037.621 or the secondary vehicle manufacturer provisions of 40 CFR 1037.622 to apply for APU manufacturers.

As described above, we are aware that the PM standards as adopted would not prevent a situation in which tractors are retrofitted with diesel APUs after they are no longer new, without meeting the PM standards described above. We believe that vehicle manufacturers will strongly desire to apply the benefit of AESS with low-PM diesel APUs to help them meet CO<sub>2</sub> standards for any installations where a diesel APU is a viable or likely option for in-use tractors. We will consider addressing this possible gap in the program with a standard for *new* APUs installed on *new* or *used* tractors. Such a standard would be issued exclusively under our authority to regulate nonroad engines as described in Clean Air Act section 213 (a)(4). If we adopt such a standard, we will also consider whether to adopt that same requirement for new APUs installed in other motor vehicles, and for other nonroad installations generally.

#### (4) Special Purpose Tractors and Heavy-Haul Tractors

The agencies proposed and are adopting provisions in Phase 2 to set standards for a new subcategory of heavy-haul tractors. In addition and as noted above, in Phase 1 the agencies adopted provisions to allow tractor manufacturers to reclassify certain tractors as vocational vehicles, also called Special Purpose Tractors.<sup>219</sup> The agencies proposed and are adopting provisions in Phase 2 to continue to allow manufacturers to exclude certain vocational-types of tractors (Special Purpose Tractors) from the combination tractor standards and instead be subject to the vocational vehicle standards. However, the agencies are making changes to the proposed Phase 2 Special Purpose Tractors and heavy-haul tractors in response to comments, as discussed below.

##### (a) Heavy-Haul Tractors

For Phase 2, the agencies proposed and are adopting an additional subcategory to the tractor category for heavy-haul tractors that are designed to haul much heavier loads than conventional tractors. The agencies recognize the need for manufacturers to build these types of vehicles for specific applications and also recognize that such heavy-haul tractors are not fully represented by the way GEM simulates conventional tractors. We believe the appropriate way to prevent effectively penalizing these vehicles is to set separate standards recognizing a heavy-haul vehicle's unique needs, which include the need for a higher horsepower engine and different transmissions. In addition drivetrain technologies such as 6x2 axles, may not be capable of handling the heavier loads. The agencies are adopting this change in Phase 2 because, unlike in Phase 1, the engine, transmission, and drivetrain technologies are included in the technology packages used to determine the stringency of the tractor standards and are included as manufacturer inputs in GEM. The agencies also recognize that certain technologies used to determine the stringency of the Phase 2 tractor standards are less applicable to the heavy-haul tractors designed for the U.S. market. For example, heavy-haul tractors in the U.S. are not typically used in the same manner as long-haul tractors with extended highway driving, and therefore will experience less benefit from aerodynamics. This means that the agencies are adopting a

standard that reflects individualized performance of these technologies in particular applications, in this case, heavy-haul tractors, and further, have a means of reliably assessing individualized performance of these technologies at certification.

The typical tractor is designed in the U.S. with a Gross Combined Weight Rating (GCWR) of approximately 80,000 pounds due to the effective weight limit on the federal highway system, except in states with preexisting higher weight limits. The agencies proposed in Phase 2 to consider tractors with a GCWR over 120,000 pounds as heavy-haul tractors. Based on comments received during the development of HD Phase 1 (76 FR 57136–57138) and because we did not propose in Phase 2 a sales limit for heavy-haul as we have for the vocational tractors in Phase 1, the agencies also believed it would be appropriate to further define the heavy-haul vehicle characteristics to differentiate these vehicles from the vehicles in the other nine tractor subcategories. The two additional requirements in the Phase 2 proposal included a total gear reduction greater than or equal to 57:1 and a frame Resisting Bending Moment (RBM) greater than or equal to 2,000,000 in-lbs per rail or rail and liner combination. Heavy-haul tractors typically require the large gear reduction to provide the torque necessary to start the vehicle moving. These vehicles also typically require frame rails with extra strength to ensure the ability to haul heavy loads. We requested comment on the proposed heavy-haul tractor specifications, including whether Gross Vehicle Weight Rating (GVWR) or Gross Axle Weight Rating (GAWR) would be a more appropriate metric to differentiate between a heavy-haul tractor and a typical tractor.

We received comments from several manufacturers about the proposed heavy-haul subcategory. None of the commenters were averse to creating such a subcategory, and many manufacturers directly supported such an action. Navistar supported creating a new heavy-haul subcategory maintaining that this type of vehicle is specified uniquely and is not designed for standard trailers. Volvo supported this addition since heavy-haul tractors require large engines and increased cooling capacity and most heavy-haul rigs have some requirement for off-road access to pick up machinery, bulk goods, and unusual loads.

We received comments from several manufacturers about the criteria proposed to define the heavy-haul tractor subcategory. Allison commented

that for heavy-haul tractors equipped with an automatic transmission, the gear reduction ratio should be greater than or equal to 24.9:1 because an automatic transmission with a torque converter provides a torque multiplying effect and better launch capability. EMA and other manufacturers commented that the proposed specifications for heavy-haul tractors do not allow the relevant vehicles to meet the proposed total gear reduction ratio of 57:1 or greater. EMA commented that the Allison 7-speed 4700 transmission and the Eaton 9LL products both are specifically designed for heavy-haul operations, could meet a 53:1 specification, but not a 57:1 ratio. PACCAR also commented that an automatic transmission torque converter ratio should be included in the Total Reduction ratio calculation to properly incorporate the slip and first gear ratio combination that is inherent in an automatic transmission. EMA, PACCAR, and Volvo recommended that the agencies should change the rear axle ratio for the baseline vehicle to attain the 53:1 total reduction ratio because the proposed baseline heavy-haul vehicle did not meet the proposed total reduction ratio. Daimler commented that the agencies should remove both the frame resistance bending moment requirement and the gear reduction requirement.

EMA and some of the manufacturers commented that the agencies should revise the definition of heavy-haul tractor to be “equal to or greater than 120,000 pounds GCWR” rather than “greater than 120,000 pounds GCWR.” They stated that the specifications for the heavy-haul market start with and include 120,000 pounds GCWR. Daimler suggested that the minimum GCWR be set at 105,000 pounds to better catch the large number of Canadian vehicles that are heavy-haul. Daimler stated that this broader weight definition catches a very small number of US vehicles (0.1 to 0.9 percent of the vehicles, depending on other factors) but catches the large number of Canadian vehicles that Daimler considers to be heavy-haul.

Volvo commented that there are multiple types of heavy-haul tractors, each with their own specific characteristics based on operational considerations: High-roof highway sleeper tractors pulling box vans at or above 120,000 pounds GCWR (e.g. long combination vehicles) that run regional and long-haul operations and can benefit from the same technologies as high-roof sleepers with 80,000 pound GCWR and should be credited for the higher payload; low- and mid-roof sleepers that primarily run long-haul routes (e.g. pulling low-boy trailers and

<sup>219</sup> See 40 CFR 1037.630.

heavy equipment); low-roof day cab tractors running regional and shorter routes (e.g. bulk haul); and then what the industry typically refers to as heavy-haul that are extremely high GCWR and can haul above 300 metric tons and sometimes run in multiple tractor configurations that provide for one or more tractor(s) pulling and one or more tractor(s) pushing.

In part to follow up on the comments made by manufacturers, EPA held discussions with Environment and Climate Change Canada (ECCC) after the NPRM was released regarding the Special Purpose tractors and heavy-haul tractors.<sup>220</sup> In our discussions, ECCC emphasized that the highway weight limitations in Canada are much greater than those in the U.S. Where the U.S. federal highways have limits of 80,000 pounds GCW, Canadian provinces have weight limits up to 140,000 pounds. This difference could potentially limit emission reductions that could be achieved if ECCC were to fully harmonize with the U.S.'s HD Phase 2 standards because a significant portion of the tractors sold in Canada have GCWR greater than 120,000 pounds, the proposed limit for heavy-haul tractors.

For the FRM, EPA and NHTSA are revising the heavy-haul tractor provisions to balance the certainty that vehicles are regulated in an appropriate subcategory along with the potential to better harmonize the U.S. and Canadian regulations. Based on our assessment, the tractors with GCWR greater than or equal to 120,000 pounds truly represent heavy-haul applications in the U.S. Therefore, we are adopting criteria only based on GCWR, not the proposed RBM or total gear reduction ratios. The agencies are adopting Phase 2 heavy-haul standards for this subset of vehicles, similar to the standards proposed for Phase 2 and detailed below in Section III.D.1.

In Canada, due to their differences in weight and dimension requirements, it is primarily tractors with a GCWR of equal to or greater than 140,000 pounds that are truly heavy-haul vehicles. This leaves a set of tractors sold in Canada with a GCWR between 120,000 and 140,000 pounds that are used in ways that are similar to the way tractors with a GCWR less than 120,000 pounds (the typical Class 8 tractor) are used in the U.S. These tractors sold in Canada could benefit from the deployment of additional GHG-reducing technologies beyond what is being required for heavy-haul tractors in the U.S., such as

aerodynamic and idle reduction improvements. Most manufacturers tend to rely on U.S. certificates as their evidence of conformity for products sold into Canada to reduce compliance burden. Therefore, in Phase 2 the agencies are adopting provisions that allow the manufacturers the option to meet standards that reflect the appropriate technology improvements, along with the powertrain requirements that go along with higher GCWR. While these heavy Class 8 tractor standards will be optional for tractors sold into the U.S. market, we expect that Canada will consider adopting these as mandatory requirements as part of their regulatory development and consultation process. Given the unique circumstances in the Canadian fleet, we believe that there is a reasonable basis for considering such an approach for Canadian tractors. As such, the agencies have coordinated these requirements with ECCC. The agencies are only adopting optional heavy Class 8 standards for MY 2021 at this time. The expectation is that ECCC will develop their own heavy-duty GHG regulations to harmonize with this Phase 2 rulemaking through its own domestic regulatory process. We expect that ECCC will include a mandate that heavy Class 8 tractors be certified to the MY 2021 heavy Class 8 tractor standards, but could also specify more stringent standards for later years for these vehicles. We plan to coordinate with ECCC to incorporate any needed future changes in a timely manner. Details of these optional standards are included in Section III.D.1.

#### (b) Special Purpose Tractors

During the development of Phase 1, the agencies received comments from several stakeholders supporting an approach for an alternative treatment of a subset of tractors because they were designed to operate at lower speeds, in stop and go traffic, and sometimes operate off-road or at higher weights than the typical line-haul tractor. These types of applications have limited potential for improvements in aerodynamic performance to reduce CO<sub>2</sub> emissions and fuel consumption. Therefore, we adopted provisions to allow these special purpose tractors to certify as vocational vehicles (or vocational tractors). Consistent with our approach in Phase 1, the agencies still believe that these vocational tractors are operated differently than line-haul tractors and therefore fit more appropriately into the vocational vehicle category. However, we need to continue to ensure that only tractors that are *truly* vocational tractors are

classified as such.<sup>221</sup> As adopted in Phase 1, a Phase 2 vehicle determined by the manufacturer to be a HHD vocational tractor will fall into one of the HHD vocational vehicle subcategories and be regulated as a vocational vehicle. Similarly, MHD tractors which the manufacturer chooses to reclassify as vocational tractors will be regulated as MHD vocational vehicles. Specifically, the agencies adopted in Phase 1 provisions in EPA's 40 CFR 1037.630 and NHTSA's regulation at 49 CFR 523.2 to only allow the following three types of vocational tractors to be eligible for reclassification by the manufacturer: Low-roof tractors intended for intra-city pickup and delivery, such as those that deliver bottled beverages to retail stores; tractors intended for off-road operation (including mixed service operation), such as those with reinforced frames and increased ground clearance; and tractors with a GCWR over 120,000 pounds.<sup>222</sup>

In the Phase 2 proposal, the agencies proposed to remove the third type of vocational tractors, heavy-haul tractors with a GCWR over 120,000 pounds, from the Phase 2 Special Purpose Tractor category and set unique standard for heavy-haul tractors. 80 FR 40214. The agencies requested comment on the Special Purpose Tractor criteria and received comments from the manufacturers. EMA and PACCAR commented there is a group of special purpose tractors with a gross combination weight rating over 120,000 pounds that fall in between the proposed regulatory categories for heavy-haul tractors and Class 8 tractors that need to be accounted for in a separate and distinct manner. They stated that such vehicles are still appropriately categorized as Special Purpose Tractors and should be included at the manufacturer's option in the vocational tractor family, even though they may not meet the proposed total gear reduction requirement or the frame rail requirements. PACCAR and Volvo also requested a modification to the definition to include "equal to 120,000 GCWR."

Volvo provided a list of recommended Special Purpose Tractor criteria. Volvo stated that these characteristics differentiate these vehicles from line haul operation, especially in terms of fuel economy as well as the significant added costs for these features. Volvo's

<sup>221</sup> As a part of the end of the year compliance process, EPA and NHTSA verify manufacturer's production reports to avoid any abuse of the vocational tractor allowance.

<sup>222</sup> See existing 40 CFR 1037.630 (a)(1)(i) through (iii).

<sup>220</sup> Memo to Docket. Heavy Class 8 Discussion with Environment and Climate Change Canada. July 2016. Docket EPA-HQ-OAR-2014-0827.

recommended criteria included GCWR greater than 120,000 pounds or any three of the following vehicles specifications: Configuration other than 4x2, 6x2, or 6x4; greater than 14,600 pounds front axle load rating; greater than 46,000 pounds rear axle load rating; greater than or equal to 3.00:1 overall axle reduction in transmission high range; greater than 57.00:1 overall axle reduction in transmission low range; frame rails with a resistance bending moment greater than or equal to 2,000,000 in-lbs., greater than or equal to 20 degree approach angle; or greater than or equal to 14 inch ground clearance.

The heavy-haul tractor standards that the agencies are adopting in Phase 2 apply to tractors with a GCWR greater than or equal to 120,000 pounds. As stated above, the agencies are adopting heavy-haul tractor criteria based only on GCWR, and are not adopting the proposed criteria of RBM or total gear reduction. With these Phase 2 changes to the proposed heavy-haul tractor definition, all tractors that would have been considered as Special Purpose Tractors in Phase 1 due to the GCWR criteria listed in EPA's 40 CFR 1037.630 and NHTSA's regulation at 49 CFR 523.2 will now qualify as heavy-haul tractors in Phase 2. Therefore, we no longer believe that it is necessary for heavy-haul tractors to be treated as Special Purpose Tractors. The agencies also reviewed Volvo's suggested criteria and concluded that the Phase 1 approach and Special Purpose Tractor criteria are working well; therefore, we do not see the need to adopt more restrictive criteria. Consequently, the agencies are adopting in Phase 2 provisions in EPA's 40 CFR 1037.630 and NHTSA's regulation at 49 CFR 523.2 to only allow the following two types of vocational tractors to be eligible for reclassification to Special Purpose Tractors by the manufacturer:

(1) Low-roof tractors intended for intra-city pickup and delivery, such as those that deliver bottled beverages to retail stores.

(2) Tractors intended for off-road operation (including mixed service operation), such as those with reinforced frames and increased ground clearance.

These provisions apply only for purposes of Phase 2. The agencies are not amending the Phase 1 provisions for special purposes tractors.

Volvo also requested that the agencies add a Vocational Heavy-Haul Tractor subcategory that allows for a heavy-haul tractor which benefits from the utilization of a powertrain optimized to meet the vocational operational

requirements of this segment, a technology package corresponding to those operational characteristics, and with a corresponding duty cycle and, most importantly, a payload representative of heavy-haul operation. The agencies considered this request and analyzed the expected technology package differences between the vocational and tractor program. As described in Section III.D.1, the agencies are only adopting technologies in the heavy-haul tractor category that would be applicable to the operation of these vehicles. For example, we are not adopting standards that are premised on any improvements to aerodynamics or extended idle reduction. Therefore, we concluded that there is no need to develop another vocational subcategory to account for heavy-haul tractors.

Because the difference between some vocational tractors and line-haul tractors is potentially somewhat subjective, and because of concerns about relative stringency, we also adopted in Phase 1 and proposed to continue in Phase 2 a rolling three year sales limit of 21,000 vocational tractors per manufacturer consistent with past production volumes of such vehicles to limit the use of this provision. We proposed in Phase 2 to carry-over the existing three year sales limit with the recognition that heavy-haul tractors would no longer be permitted to be treated as vocational vehicles (suggesting a lower volume cap could be appropriate) but that the heavy-duty market has improved since the development of the HD Phase 1 rule (suggesting the need for a higher sales cap). The agencies requested comment on whether the proposed sales volume limit is set at an appropriate level looking into the future. 80 FR 40214.

Several of the manufacturers commented that it would be reasonable to remove the sales cap limit. Allison stated that this limitation may have been reasonable in the initial years of the program as a precaution against unreasonably assigning too many tractors to the vocational vehicle category. However in Phase 2, Allison recommended that the agencies should remove the cap for three reasons: (1) Vehicle configurations change over time; (2) the Phase 2 vocational program drives technology improvements of powertrains; and (3) Phase 2 better represents the diversity of vocational vehicle uses that would allow for better alignment of vehicles with duty cycles that most represent their real world operation. Daimler stated that they think that with the addition of heavy-haul tractor standards, there will be less need for a sales volume limit on special purpose tractors. In Volvo Group's

opinion, the proposed volume limit is overly constraining and burdensome and should be removed. Volvo stated that given the recent product lineup overhauls across the industry they do not believe that there are many models still on the market that are sold in large numbers into both highway tractor and vocational tractor segments, nor is there sufficient reason that any OEM cannot identify specific vehicle attributes in order to classify a tractor as suitable solely for highway use, or for on/off-road use. Volvo Group suggested that the agencies remove the vocational tractor volume restrictions and employ a guideline based on specific vehicle characteristics.

The agencies evaluated the sales cap limit proposed for special purpose tractors and the comments addressing the issue of a sales cap. EPA calculated the number of vocational tractors certified in MY 2014 and MY 2015. The number of tractors ranged between approximately 2,600 and 6,200 per year per manufacturer that certified special purpose tractors, but one manufacturer did not use this provision at all.<sup>223</sup> It is apparent that none of the manufacturers are utilizing this provision near the maximum allowable level in Phase 1 (a rolling three year sales limit of 21,000). We also believe that there is more incentive for manufacturers to use the special purpose tractor provisions in Phase 1 because the relative difference in stringency between the tractor and vocational programs is much greater in Phase 1 than it will be in Phase 2. Upon further consideration, we concluded that there is significantly less incentive for the manufacturers to reclassify tractors that are not truly special purpose tractors as vocational vehicles as a pathway to a less stringent standard in Phase 2 primarily since the Phase 2 vocational vehicle program stringency is similar to the stringency of the tractor program. In addition, the Phase 2 vocational vehicle compliance program and standards better represent the duty cycles expected of these vehicles and are predicated on performance of similar sets of vehicle technologies, except for aerodynamic technologies, as the primary tractor program. Therefore, we are adopting Phase 2 special purpose tractor provisions without a sales cap, but will continue to monitor during the Phase 2 implementation.

<sup>223</sup> U.S. EPA. Memo to Docket: Special Purpose Tractor Production Volumes. Docket EPA-HQ-OAR-2014-0827.

### (5) Small Tractor Manufacturer Provisions

In Phase 1, EPA determined that manufacturers that met the small business criteria specified in 13 CFR 121.201 for “Heavy Duty Truck Manufacturing” should not be subject to the initial phase of greenhouse gas emissions standards in 40 CFR 1037.106.<sup>224</sup> The regulations required that qualifying manufacturers notify the Designated Compliance Officer each model year before introducing the exempted vehicles into commerce. The manufacturers are also required to label the vehicles to identify them as excluded vehicles. EPA and NHTSA proposed to eliminate this small business provision for tractor manufacturers in the Phase 2 program. As stated in the NPRM, the agencies are aware of two second stage manufacturers building custom sleeper cab tractors. In the proposal we stated that we could treat these vehicles in one of two ways. First, the vehicles may be considered as dromedary vehicles and therefore treated as vocational vehicles.<sup>225</sup> Or the agencies could provide provisions that stated if a manufacturer changed the cab, but not the frontal area of the vehicle, then it could retain the aerodynamic bin of the original tractor. 80 FR 40214.

The agencies received comments on the second stage manufacturer options for small manufacturers discussed in the proposal. American Reliance Industries (ARI) raised concerns related to the proposed alternative methods for excluding or exempting second stage manufacturers performing cab sleeper modifications. ARI is concerned that treating these vehicles as vocational vehicles may mean that other regulations related to vocational vehicles would become applicable and have unanticipated adverse results and that the vehicles would not be certified as vocational vehicles when originally certified by an OEM. ARI commented that if EPA and NHTSA adopt a frontal area approach for second stage manufacturers making cab sleeper modifications, that the section be revised to ensure greater clarity as to the intention and effect of this section. In building a custom sleeper cab, ARI stated that they may use wind fairings, fuel tank fairings, roof fairings, and side extenders that can modify the frontal area of the tractor in height and width as compared to the frontal area of the

vehicle used to obtain the original certification. ARI also commented that depending on the custom cab sleeper modification, ARI may replace an aerodynamic fairing from the tractor in order to provide better aerodynamic results in light of the cab sleeper modification. ARI does not want to be precluded from continuing to provide these benefits to clients. ARI encourages the agencies to take a similar approach to small business exemption under the Phase 1 regulation in the Phase 2 regulation.

Daimler commented on the agencies’ two proposed approaches for second stage manufacturers that build custom sleepers. Daimler’s main concern is to clarify that where the primary manufacturer has certified a vehicle as a day cab, the second stage manufacturer’s actions do not draw the primary manufacturer into noncompliance. Daimler stated that in many cases, they do not know that a vehicle will be altered by a second stage manufacturer. Daimler did not have a preference on the way that the agencies proposed to regulate these secondary vehicle manufacturers, as long as the primary vehicle manufacturers could continue to sell vehicles with the expectation that anyone changing them from the compliant state in which it was built would certify those changes.

In response to these comments, EPA is clarifying in 40 CFR 1037.622 that small businesses may modify tractors as long as they do not modify the front of the vehicle and so long as the sleeper compartment is no more than 102 inches wide or 162 inches in height. As an interim provision, to allow for a better transition to Phase 2, EPA is finalizing a more flexible compliance path in 40 CFR 1037.150(r). This option allows small manufacturers to convert a low or mid roof tractor to a high roof configuration without recertification, provided it is for the purpose of building a custom sleeper tractor or for conversion to a natural gas tractor. Although this more flexible allowance to convert low and mid roof tractors to high roof tractors is being adopted as an interim provision, we have not established an end date at this time. We expect to reevaluate as manufacturers begin to make use of and may decide to revise it in the future, potentially deciding to make it a permanent allowance. To be eligible for this option, the secondary manufacturer must be a small manufacturer and the original low or mid roof tractor must be covered by a valid certificate of conformity. The modifications may not increase the frontal area of the tractor beyond the frontal area of the equivalent high roof

tractor paired with a standard box van. With respect to Daimler’s comment, 40 CFR 1037.130 only applies to vehicles sold in an uncertified condition and does not apply to vehicles sold in a certified condition.

### (6) Glider Vehicles

As described in Section XIII.B, EPA is adopting new provisions related to glider vehicles, including glider tractors.<sup>226</sup> NHTSA did not propose such changes. Glider vehicles and glider kits were also treated differently under NHTSA and EPA regulations prior to this rulemaking. They are exempt from NHTSA’s Phase 1 fuel consumption standards. For EPA purposes, the CO<sub>2</sub> provisions of Phase 1 exempted glider vehicles and glider kits produced by small businesses but did not include such a blanket exemption for other glider kits. Thus, some gliders and glider kits are already subject to the Phase 1 requirement to obtain a vehicle certificate prior to introduction into commerce as a new vehicle. 80 FR 40528.

In the NPRM, EPA proposed to revise the provisions applicable to glider vehicles so that the engines used in these vehicles would need to meet the standards for the year of the new glider vehicle. EPA’s resolution of issues relating to glider vehicles, including glider tractors, and glider kits, is discussed fully in Section XIII.B and RTC Section 14.2.

Similarly, NHTSA considered including glider vehicles under its Phase 2 program. After assessing the impact glider vehicles have on the tractor segment, NHTSA has elected not to include glider vehicles in its Phase 2 program. NHTSA may reconsider fuel efficiency regulations for glider vehicles in a future rulemaking.

As discussed in the NPRM, NHTSA would like to reiterate its safety authority over gliders—notably, that it has become increasingly aware of potential noncompliance with its regulations applicable to gliders. While there are instances in which NHTSA regulations allow gliders to use a “donor VIN” from a “donor tractor,” NHTSA has learned of manufacturers that are creating glider vehicles that are new vehicles under 49 CFR 571.7(e); however, the manufacturers are not certifying them and obtaining a new VIN as required. NHTSA plans to pursue enforcement actions as applicable against noncompliant manufacturers. In addition to enforcement actions, NHTSA may

<sup>224</sup> See 40 CFR 1037.150(c).

<sup>225</sup> A dromedary is a box, deck, or plate mounted behind the tractor cab and forward of the fifth wheel on the frame of the power unit of a tractor-trailer combination to carry freight.

<sup>226</sup> See section I.E. 1 for descriptions of glider vehicles and glider kits.



consider amending 49 CFR 571.7(e) and related regulations as necessary. NHTSA believes manufacturers may not be using this regulation as originally intended.

We believe that the agencies having different policies for glider kits and glider vehicles under the Phase 2 program will not result in problematic disharmony between the NHTSA and EPA programs, because of the small number of vehicles that will be involved. EPA believes that its changes will result in the glider market returning to the pre-2007 levels, in which fewer than 1,000 glider vehicles will be produced in most years. Only non-exempt glider vehicles will be subject to different requirements under the NHTSA and EPA regulations. However, we believe that this is unlikely to exceed a few hundred vehicles in any year, which will be few enough not to result in any meaningful disharmony between the two agencies.

(7) Useful Life and Deterioration Factors

Section 202(a)(1) of the CAA specifies that EPA is to adopt emissions standards that are applicable for the useful life of the vehicle. The in-use Phase 2 standards that EPA is adopting will apply to individual vehicles and engines, just as EPA adopted for Phase 1. NHTSA is also adopting the same useful life mileage and years as EPA for Phase 2.

EPA is also not adopting any changes to the existing provisions that require that the useful life for tractors with respect to CO<sub>2</sub> emissions be equal to the respective useful life periods for criteria pollutants, as shown below in Table III–5. See 40 CFR 1037.106(e). EPA does not expect degradation of the technologies evaluated for Phase 2 in terms of CO<sub>2</sub> emissions, therefore we did not adopt any changes to the regulations describing compliance with GHG pollutants with regards to deterioration. See 40 CFR 1037.241.

TABLE III–5—TRACTOR USEFUL LIFE PERIODS

	Years	Miles
Class 7 Tractors .....	10	185,000
Class 8 Tractors .....	10	435,000

D. Feasibility of the Final Phase 2 Tractor Standards

This section describes the agencies’ technical feasibility and cost analysis. Further detail on all of these technologies can be found in the RIA Chapter 2.

Class 7 and 8 tractors are used in combination with trailers to transport

freight. The variation in the design of these tractors and their typical uses drive different technology solutions for each regulatory subcategory. As noted above, the agencies are continuing the Phase 1 provisions that treat vocational tractors as vocational vehicles instead of as combination tractors, as noted in Section III.C.4. The focus of this section is on the feasibility of final standards for combination tractors including the heavy-haul tractors, but not the vocational tractors.

EPA and NHTSA collected information on the cost and effectiveness of fuel consumption and CO<sub>2</sub> emission reducing technologies from several sources, including new information collected since the NPRM was promulgated. The primary sources of pre-proposal information were the Southwest Research Institute evaluation of heavy-duty vehicle fuel efficiency and costs for NHTSA,<sup>227</sup> the Department of Energy’s SuperTruck Program,<sup>228</sup> 2010 National Academy of Sciences report of Technologies and Approaches to Reducing the Fuel Consumption of Medium- and Heavy-Duty Vehicles,<sup>229</sup> TIAX’s assessment of technologies to support the NAS panel report,<sup>230</sup> the analysis conducted by the Northeast States Center for a Clean Air Future, International Council on Clean Transportation, Southwest Research Institute and TIAX for reducing fuel consumption of heavy-duty long haul combination tractors (the NESCCAF/ICCT study),<sup>231</sup> and the technology cost analysis conducted by ICF for EPA.<sup>232</sup> Some additional information and data were also provided in comments.

Commenters generally supported the agencies’ projection that manufacturers

can reduce CO<sub>2</sub> emissions and fuel consumption of combination tractors through use of many technologies, including engine, drivetrain, aerodynamic, tire, extended idle, and weight reduction technologies. The agencies’ determination of the feasibility of the final HD Phase 2 standards is based on our updated projection of the use of these technologies and an updated assessment of their effectiveness. We will also discuss other technologies that could potentially be used, such as vehicle speed limiters, although we are not basing the final standards on their use for the model years covered by this rule, for various reasons discussed below.

(1) Projected Technology Effectiveness and Cost

EPA and NHTSA project that CO<sub>2</sub> emissions and fuel consumption reductions can be feasibly and cost-effectively met through technological improvements in several areas. The agencies evaluated each technology and estimated the most appropriate adoption rate of technology into each tractor subcategory. The next sections describe the baseline vehicle configuration, the effectiveness of the individual technologies, the costs of the technologies, the projected adoption rates of the technologies into the regulatory subcategories, and finally the derivation of these standards.

Based on information available at the time of the NPRM, the agencies proposed Phase 2 standards that projected by 2027, all high-roof tractors would have aerodynamic performance equal to or better today’s SmartWay performance—which represents the best of today’s technology. This would equate to having 40 percent of new high roof sleeper cabs in 2027 complying with the current best practices and 60 percent of the new high-roof sleeper cab tractors sold in 2027 having better aerodynamic performance than the best tractors available today. For tire rolling resistance, we premised the proposed standards on the assumption that nearly all tires in 2027 would have rolling resistance equal to or superior to tires meeting today’s SmartWay designation. At proposal, the agencies assumed the 2027 MY engines would achieve an additional 4 percent improvement over Phase 1 engines and we projected 15 percent adoption of waste heat recovery (WHR) and many other advanced engine technologies. In addition, we proposed standards that projected improvements to nearly all of today’s transmissions, incorporation of extended idle reduction technologies on 90 percent of sleeper cabs, and significant adoption of

<sup>227</sup> Reinhart, T.E. (June 2015). *Commercial Medium- and Heavy-Duty Truck Fuel Efficiency Technology Study—Report #1*. (Report No. DOT HS 812 146). Washington, DC: National Highway Traffic Safety Administration.

<sup>228</sup> U.S. Department of Energy. SuperTruck Initiative. Information available at <http://energy.gov/eere/vehicles/vehicle-technologies-office>.

<sup>229</sup> Committee to Assess Fuel Economy Technologies for Medium- and Heavy-Duty Vehicles; National Research Council; Transportation Research Board (2010). *Technologies and Approaches to Reducing the Fuel Consumption of Medium- and Heavy-Duty Vehicles*. (“The 2010 NAS Report”) Washington, DC, The National Academies Press.

<sup>230</sup> TIAX, LLC. “Assessment of Fuel Economy Technologies for Medium- and Heavy-Duty Vehicles,” Final Report to National Academy of Sciences, November 19, 2009.

<sup>231</sup> NESCCAF, ICCT, Southwest Research Institute, and TIAX. *Reducing Heavy-Duty Long Haul Combination Truck Fuel Consumption and CO<sub>2</sub> Emissions*. October 2009.

<sup>232</sup> ICF International. “Investigation of Costs for Strategies to Reduce Greenhouse Gas Emissions for Heavy-Duty On-Road Vehicles.” July 2010. Docket Number EPA–HQ–OAR–2010–0162–0283.



other types of technologies such as predictive cruise control and automatic tire inflation systems.

The agencies also discussed several other alternatives in the proposal. When considering alternatives, it is necessary to evaluate the impact of a regulation in terms of CO<sub>2</sub> emission reductions, fuel consumption reductions, and technology costs. However, it is also necessary to consider other aspects, such as manufacturers' research and development resources, the impact on purchase price, and the impact on purchasers. Manufacturers are limited in their ability to develop and implement new technologies due to their human resources and budget constraints. This has a direct impact on the amount of lead time that is required to meet any new standards. From the owner/operator perspective, heavy-duty vehicles are a capital investment for firms and individuals so large increases in the upfront cost could impact buying patterns. Though the dollar value of the lifetime fuel savings will far exceed the upfront technology costs, purchasers often discount future fuel savings for a number of reasons, as discussed in more detail in Section IX.A. Tractor purchasers are often uncertain regarding the amount of fuel savings that can be expected for their specific operation due to the diversity of the heavy-duty tractor market. Although a nationwide perspective that averages out this uncertainty is appropriate for rulemaking analysis, individual operators must consider their potentially narrow operation. In addition, purchasers often put a premium on reliability (because downtime is costly in terms of towing, repair, late deliveries, and lost revenue) and may perceive any new technology as a potential risk with respect to reliability. Another factor that purchasers consider is the impact of a new technology on the resale market, which can also be impacted by uncertainty.

The agencies solicited comment on all of these issues and again noted the possibility of adopting, in a final action, standards that are more accelerated than those in Alternative 3, notably what we termed at proposal, Alternative 4 which would have involved a three year pull ahead of the proposed 2027 standards. 80 FR 40211. The agencies also assumed in the NPRM that both the proposed standards and Alternative 4 could be accomplished with all changes being made during manufacturers' normal product design cycles. However, we noted that doing so would be more challenging for Alternative 4 and may require accelerated research and

development outside of design cycles with attendant increased costs. Commenters were encouraged in the NPRM to address all aspects of feasibility analysis, including costs, the likelihood of developing the technology to achieve sufficient reliability within the lead time, and the extent to which the market could utilize the technology.

The agencies received several general comments on the overall stringency of the proposed Phase 2 standards. Several entities encouraged the agencies to adopt more stringent tractor standards, including adoption of Alternative 4. They pointed out that DOE's SuperTruck program demonstrated over 40 percent improvement over 2010 levels, including 10.7 mpg by Cummins-Peterbilt and 12.2 mpg by Daimler. CBD stated that the technology forcing nature of Clean Air Act section 202(a)(2)<sup>233</sup> and EPCA/EISA requires more aggressive assumptions regarding technology adoption. UCS commented that the tractor standards could be strengthened by another six percent in 2024 and seven percent in 2027 to reflect the full range of improvements to the powertrain and engine. ICCT stated that its analysis indicates that the technology potential is higher and costs are lower than the agencies' assessments in the NPRM. CARB stated that Alternative 4 is technologically feasible and will result in more emission and fuel consumption reductions. CARB continued to state that the increased cost due to accelerated implementation is minimal, about \$1,000 per vehicle purportedly according to the NPRM.

In contrast to the commenters that called for more stringent standards than those proposed, several other commenters cautioned the agencies from adopting final standards that are more stringent than those proposed. Diesel Technology Forum commented that the agencies should proceed with caution on technologies that are not in wide use that have not demonstrated reliability or commercial availability. The International Foodservice Distributors Association is concerned about Alternative 4 in terms of reliability, commenting that it would require their members to purchase unproven and unreliable equipment in order for OEMs to meet the requirements. OOIDA commented if owners fear a reduction in reliability, increased operating costs, reduced residual value, or large increases in

purchase prices, they will adjust their purchase plans.

PACCAR commented about the importance of lead time because their customers need time to determine if a technology meets their specific needs in their specific application and need assurance that a technology will be reliable in use. PACCAR also stated that the timing provided in the NPRM Alternative 3 provides the "greatest likelihood for a successful program." Volvo commented that SuperTruck demonstration vehicles serve only the purpose of demonstration but are not proven with respect to cost, reliability, and durability. Volvo stated that the purpose of SuperTruck was narrow in applicability of matched tractor-trailers and that it did not result in a cost effective tractor because each project cost between \$40 and \$80 million to produce a single vehicle. Volvo also commented that not all SuperTruck technologies should be forced into all applications and duty cycles and if they are a pre-buy (or no-buy) could result.

The agencies considered all of the general comments associated with the proposed Alternative 3 and Alternative 4 tractor standards. We believe there is merit in many of the detailed comments received regarding technologies. These are discussed in detail in the following sections. Instead of merely choosing from among the proposed alternatives, the agencies have developed a set of final tractor standards that reflect our reevaluation of the ability to pull ahead certain technologies, the limitations in adoption rates and/or effectiveness of other technologies, and consideration of additional technologies. In general, the final Phase 2 tractor standards are similar in overall stringency as the levels proposed in Alternative 3, but have been determined using new technology packages that reflect consideration of all of the technology comments, and in some respects reflect greater stringency than the proposed Alternative 3.

As can be seen from the comments, there is uncertainty and a wide range of opinions regarding the extent to which these technologies can be applied to heavy-duty tractors. Vehicle manufacturers tended to take the conservative position for each technology and argue that the agencies should not project effectiveness or adoption rates beyond that which is certain. Many other commenters took a more optimistic view and argued for the agencies to assume that each potential technology will be highly effective in most applications. However the agencies believe the most likely outcome will be that some technologies

<sup>233</sup> CBD is mistaken that section 202(a)(2) mandates technology-forcing standards, although it allows them. See generally 74 FR 49464-465 (Sept. 28, 2009).

will work out better than expected while others will be slightly more challenging than projected. Thus, the agencies have tended to make balanced projections for the various technologies, although some may be slightly optimistic while others are somewhat conservative. We believe the overall effect of this approach will be standards that achieve large reductions with minimal risks to the industry.

(a) Tractor Baselines for Costs and Effectiveness

The fuel efficiency and CO<sub>2</sub> emissions of combination tractors vary depending on the configuration of the tractor. Many aspects of the tractor impact its performance, including the engine, transmission, drive axle, aerodynamics, and rolling resistance. For each subcategory, the agencies selected a theoretical tractor to represent the average 2017 model year tractor that meets the Phase 1 standards (see 76 FR 57212, September 15, 2011). These tractors are used as baselines from which to evaluate costs and effectiveness of additional technologies and standards.

As noted earlier, the Phase 1 2017 model year tractor standards (based on Phase 1 GEM and test procedures) and the baseline 2017 model year tractor results (using Phase 2 GEM and test procedures) are not directly comparable. The same set of aerodynamic and tire rolling resistance technologies were used in both setting the Phase 1 standards and determining the baseline of the Phase 2 tractors. However, there are several aspects that differ. First, a new version of GEM was developed and validated to provide additional capabilities, including more refined modeling of transmissions and engines. Second, the determination of the HD Phase 2 C<sub>d</sub>A value takes into account a revised test procedure, a new standard reference trailer, and wind averaged drag as discussed below in Section III.E. In addition, the HD Phase 2 version of GEM includes road grade in the 55 mph and 65 mph highway cycles, as discussed below in Section III.E.

The agencies used the same adoption rates of tire rolling resistance for the Phase 2 baseline as we used to set the Phase 1 2017 MY standards. See 76 FR 57211. The tire rolling resistance level assumed to meet the 2017 MY Phase 1 standard high roof sleeper cab is considered to be a weighted average of 10 percent pre-Phase 1 baseline rolling resistance, 70 percent Level 1, and 20 percent Level 2. The tire rolling resistance to meet the 2017MY Phase 1 standards for the high roof day cab, low roof sleeper cab, and mid roof sleeper

cab includes 30 percent pre-Phase 1 baseline level, 60 percent Level 1 and 10 percent Level 2. Finally, the low and mid roof day cab 2017 MY standards were premised on a weighted average rolling resistance consisting of 40 percent baseline, 50 percent Level 1, and 10 percent Level 2. The agencies did not receive comments on the tire packages used to develop the Phase 2 baseline in the NPRM.

The agencies sought comment on the baseline vehicle attributes described in the NPRM. The agencies received comments related to the baseline adoption rate of automatic engine shutdown systems (AESS) and the baseline aerodynamics assessment. In the proposal, the agencies noted that the manufacturers were not using tamper-proof AESS to comply with the Phase 1 standards so the agencies reverted back to the baseline APU adoption rate of 30 percent used in the Phase 1 baseline. EMA and TRALA commented that the agencies confused the use of an APU with the use of tamper-proof idle technologies in assessing the baseline for the proposed Phase 2 standards. They stated that a 30 percent penetration rate of APUs is not the same as a 30 percent penetration rate of tamper-proof idle systems. ATA and Volvo also commented that the assumption that 30 percent of 2017 sleeper tractors will utilize the tamper-proof automatic engine shutdown is too high. EMA and PACCAR commented that virtually all tractors in the field have an automatic shutdown programmed in their engine; however, less than one percent of vehicles sold in recent years have tamper-proof AESS that are triggered in less than five minutes and cannot be reprogrammed for 1.259 million miles. In response to these comments, the agencies reassessed the baseline idle reduction adoption rates. The latest NACFE confidence report found that 9 percent of tractors had auxiliary power units and 96 percent of vehicles are equipped with adjustable automatic engine shutdown systems.<sup>234</sup> Therefore, the agencies are projecting that 9 percent of sleeper cabs will contain an adjustable AESS and APU, while the other 87 percent will only have an adjustable AESS. Additional discussion on adjustable AESS is included in Section III.D.1.b.

The Phase 2 baseline in the NPRM was determined based on the aerodynamic bin adoption rates used to determine the Phase 1 MY 2017 tractor standards. Volvo, EMA, and other

<sup>234</sup> North American Council for Freight Efficiency. Confidence Report: Idle Reduction Solutions. 2014. Page 13.

manufacturers also commented that the aerodynamic drag baseline for 2017 tractors included in the NPRM was too aerodynamically efficient. EMA commented that some of the best aerodynamic tractors available were tested by the agencies and then declared to be the baseline. According to the manufacturers, the average tractor—the true baseline—is a full bin worse than these best tractors. While the agencies agree with the commenters that it is important to develop an accurate baseline so that the appropriate aerodynamic technology package effectiveness and costs can be evaluated in determining the final Phase 2 standards, there appears to be some confusion regarding the NPRM baseline aerodynamic assessment. The Phase 2 baseline in the NPRM was determined based on the aerodynamic bin adoption rates used to determine the Phase 1 MY 2017 tractor standards (see 76 FR 57211). The baseline was not determined by or declared to be the average results of the vehicles tested, as some commenters maintained. The vehicles that were tested prior to the NPRM were used to develop the proposed aerodynamic bin structure for Phase 2. In both the NPRM and this final rulemaking, we developed the Phase 2 bins such that there is an alignment between the Phase 1 and Phase 2 aerodynamic bins after taking into consideration the changes in aerodynamic test procedures and reference trailers required in Phase 2. The Phase 2 bins were developed so that tractors that performed as a Bin III in Phase 1 would also perform as Bin III tractors in Phase 2. Additional details regarding how the agencies refined the aerodynamic bin values for Phase 2 for the final rule can be found in Section III.E.2.a. The baseline aerodynamic value for the Phase 2 final rulemaking was determined in the same manner as the NPRM, using the adoption rates of the bins used to determine the Phase 1 standards, but reflect the final Phase 2 bin C<sub>d</sub>A values.

In the NPRM, we used a transmission top gear ratio of 0.73 and drive axle ratio of 3.70 in the baseline 2017 MY tractor. UCS commented that the baseline axle ratio is too high. The agencies determined the rear axle ratio and final drive ratio in the baseline tractor based on axle market information shared by Meritor,<sup>235</sup> one of the primary suppliers of heavy-duty axles, and confidential business information provided by Daimler. Our assessment of this information found that a rear axle ratio

<sup>235</sup> NACFE. Confidence Report: Programmable Engine Parameters. February 2015. Page 23.

of 3.70 and a top gear ratio of 0.73 (equivalent to a final drive ratio of 2.70) is a commonly spec'd tractor. Meritor's white paper on downspeeding stated that final drive ratios of less than 2.64 are considered to be "downsped."<sup>236</sup> The agencies recognize that there is a significant range in final drive ratios that will be utilized by tractors built in

2017 MY, we do not believe that the average (*i.e.*, baseline) tractor in 2017 MY will downsped (*i.e.*, have a final drive ratio of less than 2.64). Therefore, the agencies are maintaining the proposed top gear ratio and drive axle ratio for the assessment of the baseline tractor performance.

The agencies are using the specific attributes of each tractor subcategory as are listed below in Table III-6 for the Phase 2 baselines. Using these values, the agencies assessed the CO<sub>2</sub> emissions and fuel consumption performance of the baseline tractors using the Phase 2 GEM. The results of these simulations are shown below in Table III-7.

TABLE III-6—GEM INPUTS FOR THE BASELINE CLASS 7 AND 8 TRACTOR

Class 7			Class 8					
Day cab			Day cab			Sleeper cab		
Low roof	Mid roof	High roof	Low roof	Mid roof	High roof	Low roof	Mid roof	High roof
<b>Engine</b>								
2017 MY 11L Engine 350 HP	2017 MY 11L Engine 350 HP	2017 MY 11L Engine 350 HP	2017 MY 15L Engine 455 HP	2017 MY 15L Engine 455 HP	2017 MY 15L Engine 455 HP	2017 MY 15L Engine 455 HP	2017 MY 15L Engine 455 HP	2017 MY 15L Engine 455 HP
<b>Aerodynamics (C<sub>d</sub>A in m<sup>2</sup>)</b>								
5.41	6.48	6.38	5.41	6.48	6.38	5.41	6.48	5.90
<b>Steer Tires (CRR in kg/metric ton)</b>								
6.99	6.99	6.87	6.99	6.99	6.87	6.87	6.87	6.54
<b>Drive Tires (CRR in kg/metric ton)</b>								
7.38	7.38	7.26	7.38	7.38	7.26	7.26	7.26	6.92
<b>Extended Idle Reduction—Adjustable AESS with no Idle Red Tech Adoption Rate @1% Effectiveness</b>								
N/A	N/A	N/A	N/A	N/A	N/A	87%	87%	87%
<b>Extended Idle Reduction—Adjustable AESS with Diesel APU Adoption Rate @3% Effectiveness</b>								
N/A	N/A	N/A	N/A	N/A	N/A	9%	9%	9%
<b>Transmission = 10 Speed Manual Transmission</b>								
<b>Gear Ratios = 12.8, 9.25, 6.76, 4.90, 3.58, 2.61, 1.89, 1.38, 1.00, 0.73</b>								
<b>Drive Axle Configuration = 4 × 2</b>			<b>Drive Axle Configuration = 6 × 4</b>					
<b>Tire Revs/Mile = 512</b>								
<b>Drive Axle Ratio = 3.70</b>								

TABLE III-7—CLASS 7 AND 8 TRACTOR BASELINE CO<sub>2</sub> EMISSIONS AND FUEL CONSUMPTION

	Class 7			Class 8					
	Day Cab			Day Cab			Sleeper Cab		
	Low roof	Mid roof	High roof	Low roof	Mid roof	High roof	Low roof	Mid roof	High roof
CO <sub>2</sub> (grams CO <sub>2</sub> /ton-mile) .....	119.1	127.2	129.7	91.3	96.6	98.2	84.0	90.2	87.8
Fuel Consumption (gal/1,000 ton-mile) .....	11.69941	12.49509	12.74067	8.96857	9.48919	9.64637	8.25147	8.86051	8.62475

The agencies also received comments related to the baseline heavy-haul tractor parameters. Volvo did not agree that certain segments of the heavy-haul

population are appropriately represented by the baseline in the NPRM. Volvo stated that these types of vehicles typically utilize an 18-speed

transmission, since they require the very close gear ratios and nearly all heavy-haul tractors have deeper drive axle ratios than the agencies have assumed

<sup>236</sup> Ostrander, Robert, et al. (Meritor). Understanding the Effects of Engine Downspeeding on Drivetrain Components. 2014. Page 2.

(3.55). PACCAR commented the 14.4 first gear of the 18-speed transmission coupled with the 3.73 rear axle ratio is an example of a significant sales volume combination that meets their recommended 53:1 Total Reduction ratio. Upon further consideration, the agencies find the suggestion that the baseline heavy-haul tractor is better represented by an 18-speed manual transmission to be persuasive. We therefore revised the baseline heavy-haul tractor configuration, as shown in Table III–8.

The baseline 2017 MY heavy-haul tractor will emit 56.9 grams of CO<sub>2</sub> per ton-mile and consume 5.59 gallons of fuel per 1,000 ton-mile.

TABLE III–8—HEAVY-HAUL TRACTOR BASELINE CONFIGURATION

Baseline heavy-haul tractor configuration
Engine = 2017 MY 15L Engine with 600 HP.
Aerodynamics (C <sub>d</sub> A in m <sup>2</sup> ) = 5.00.
Steer Tires (CRR in kg/metric ton) = 7.0.
Drive Tires (CRR in kg/metric ton) = 7.4.
Transmission = 18 speed Manual Transmission Gear ratio = 14.4, 12.29, 8.51, 7.26, 6.05, 5.16, 4.38, 3.74, 3.2, 2.73, 2.28, 1.94, 1.62, 1.38, 1.17, 1.00, 0.86, 0.73.
Drive axle Ratio = 3.73.
All Technology Improvement Factors = 0%.

The fuel consumption and CO<sub>2</sub> emissions in this “flat” baseline described above remains the same over time with no assumed improvements after 2017, absent a Phase 2 regulation. An alternative baseline was also evaluated by the agencies in which there is a continuing uptake of technologies in the tractor market that reduce fuel consumption and CO<sub>2</sub> emissions absent a Phase 2 regulation. This alternative baseline, referred to as the “dynamic” baseline, was developed to estimate the potential effect of market pressures and non-regulatory government initiatives to improve tractor fuel consumption. The dynamic baseline assumes that the significant level of research funded and conducted by the Federal government, industry, academia and other organizations will, in the future, result in the adoption of some technologies beyond the levels required to comply with Phase 1 standards. One example of such research is the Department of Energy

Super Truck program<sup>237</sup> which has a goal of demonstrating cost-effective measures to improve the efficiency of Class 8 long-haul freight trucks by 50 percent by 2015. The dynamic baseline also assumes that manufacturers will not cease offering fuel efficiency improving technologies that currently have significant market penetration, such as automated manual transmissions. The baselines (one for each of the nine tractor types) are characterized by fuel consumption and CO<sub>2</sub> emissions that gradually decrease between 2019 and 2028. In 2028, the fuel consumption for the alternative tractor baselines is approximately 4.0 percent lower than those shown in Table III–7. This results from the assumed introduction of aerodynamic technologies such as down exhaust, underbody airflow treatment in addition to tires with lower rolling resistance. The assumed introduction of these technologies reduces the C<sub>d</sub>A of the baseline tractors and CRR of the tractor tires. To take one example, the C<sub>d</sub>A for baseline high roof sleeper cabs in Table III–6 is 5.90 m<sup>2</sup> in 2017. In 2028, the C<sub>d</sub>A of a high roof sleeper cab would be assumed to still be 5.90 m<sup>2</sup> in the flat baseline case outlined above. Alternatively, in the dynamic baseline, the C<sub>d</sub>A for high roof sleeper cabs is 5.61 m<sup>2</sup> in 2028 due to assumed market penetration of technologies absent the Phase 2 regulation. The dynamic baseline analysis is discussed in more detail in RIA Chapter 11.

#### (b) Tractor Technology Effectiveness

The agencies’ assessment of the technology effectiveness was developed through the use of the GEM in coordination with modeling conducted by Southwest Research Institute. The agencies developed these standards through a three-step process, similar to the approach used in Phase 1. First, the agencies developed estimates of technology performance characteristics and effectiveness in terms of reducing CO<sub>2</sub> emissions and fuel consumption for each technology, as described below. Each technology is associated with an input parameter which in turn is used as an input to the Phase 2 GEM simulation tool. There are two types of GEM input parameters. The first type requires a manufacturer to measure aspects of the technology. These aspects are used as inputs to GEM which then models the technology’s effectiveness (*i.e.* the effectiveness for that technology

is the GEM output). Aerodynamics, tire rolling resistance, engine fuel maps, axle ratio, the optional axle efficiency, and optional transmission efficiencies are examples of this first type of GEM input. The second type of GEM input only requires a manufacturer to install the technology onto the vehicle and does not require any testing to determine the GEM input. The agencies determined and specify in the regulations (see 40 CFR 1037.520) the effectiveness of this second type of GEM input. The agencies also define the technologies that qualify to be eligible for these GEM technology inputs in the regulations (see 40 CFR 1037.660 and 1037.801). Examples of these technology inputs include transmission type, idle reduction technologies, tire pressure systems, vehicle speed limiters, weight reduction, intelligent controls, and other accessories. The performance levels for the range of Class 7 and 8 tractor aerodynamic packages and vehicle technologies are described below in Table III–10.<sup>238</sup> All percentage improvements noted below are relative to the 2017 MY baseline tractor.

As discussed in Section I.C.1.a, we assume manufacturers will incorporate appropriate compliance margins for all measured GEM inputs. In other words, they will declare values slightly higher than their measured values. As discussed in Section II.D.5, compliance margins associated with fuel maps are likely to be approximately one percent. For aerodynamic inputs, we believe the bin structure will eliminate the need for C<sub>d</sub>A compliance margins for most vehicles. However, for vehicles with measured C<sub>d</sub>A values very near the upper bin boundary, manufacturers will likely choose to certify some of them to the next higher bin values (as a number of commenters noted). For tire rolling resistance, our feasibility rests on the Phase 1 standards, consistent with our expectation that manufacturers will to continue to incorporate the compliance margins they considered necessary for Phase 1. With respect to optional axle and/or transmission power loss maps, we believe manufacturers will need very small compliance margins. These power loss procedures require high precision so measurement uncertainty will likely be on the order of 0.1 percent of the transmitted power. All of these margins are reflected in our projections of the emission levels that will be technologically feasible.

The agencies then determined the adoption rates feasible for each

<sup>237</sup> U.S. Department of Energy. See SuperTruck Report to Congress. <http://energy.gov/eere/vehicles/downloads/vehicle-technologies-office-report-adoption-new-fuel-efficient-technologies>.

<sup>238</sup> These GEM default values could be superseded on a case-by-case basis based on an appropriate off-cycle credit demonstration.

technology in each model year, as described in Section III.D.1.c. Then as described in Section III.D.1.f, the agencies combined the technology performance levels with a projected technology adoption rate to determine the GEM inputs used to set the stringency of these standards. The agencies input these parameters into Phase 2 GEM and used the output to determine the final CO<sub>2</sub> emissions and fuel consumption levels.

#### (i) Engine Improvements

There are several technologies that could be used to improve the efficiency of diesel engines used in tractors. These technologies include friction reduction, combustion system optimization, and waste heat recovery using the Rankine cycle. Details of the engine technologies, adoption rates, and overall fuel consumption and CO<sub>2</sub> emission reductions are included in Section II.D. The Phase 2 *engine* standards will lead each manufacturer to achieve reductions of 1.8 percent in 2021 MY, 4.2 percent in 2024 MY, and 5.1 percent in 2027 MY. For the final Phase 2 rule, we recognize that it could be possible to achieve greater reductions than those included in the engine standard by designing entirely new engine platforms. See Section II.D.2.e. Unlike existing platforms, which are limited with respect to peak cylinder pressures (precluding certain efficiency improvements), new platforms can be designed to have higher cylinder pressure than today's engines. New designs are also better able to incorporate recent improvements in materials and manufacturing, as well as other technological developments. Considered together, it is likely that a new engine platform could be about 2 percent better than engines using older platforms. Moreover, the agencies have seen CBI data that suggests improvement of more than 3 percent are possible. As discussed in Section II.D.2.e above, how far the various manufacturers are into their design cycles suggests that one or more manufacturers will probably introduce a new engine platform during the Phase 2 time frame. Thus, we project that 50 percent of tractor engines produced in 2027 MY will be redesigned engines (*i.e.* engines reflecting redesigned engine platforms, again based on existing engine platform redesign schedules within the industry). This means the average 2027 MY tractor engine would be 5.4 and 6.4 percent better than Phase 1 for day and sleeper cabs

respectively.<sup>239</sup> This reflects an average 0.8 percent improvement beyond what is required to meet the engine standards.

As noted in Section II.D.2.e, it is important to note that these new platforms will be developed based on normal market forces rather than as a result of this rulemaking. Some engine manufacturers have developed new platforms with the last ten years, and we do not expect these engines to be replaced within the Phase 2 time frame. However, other engines have not been fundamentally redesigned recently and will be due for replacement by 2027. Because these new platforms will occur because of market forces rather than this rulemaking, these reductions are in some ways windfalls for vehicle manufacturers. Thus, we have not included the cost of these new platforms as part of our rulemaking analysis.

We have factored these levels into our analysis of the vehicle efficiency levels that will be achievable in MY 2027. These additional engine improvements will result in vehicles having lower GEM results. Thus, they make more stringent vehicle standards feasible, and the final standards are structured so that these improved engines are not able to generate windfall credits against the engine standards, but rather that their projected performance is reflected in the stringency of the final tractor vehicle standard. It is important to also note that manufacturers that do not achieve this level of engine reduction would be able to make up the difference by applying one of the many other available and cost-effective tractor technologies to a greater extent or more effectively, so that there are multiple technology paths for meeting the final standards. In other words, a manufacturer that does not invest in updating engine platforms in the Phase 2 time frame is likely to be able to invest in improving other vehicle technologies. (Note that these same reductions cannot be assumed as part of the engine standards because engine manufacturers will not have this same flexibility). These reductions from the engine will show up in the fuel maps used in GEM to set the Phase 2 tractor stringencies.

#### (ii) Aerodynamics

There are opportunities to reduce aerodynamic drag from the tractor by further optimization of body components, but it is sometimes difficult to assess the benefit of individual aerodynamic features. Therefore, reducing aerodynamic drag requires optimizing of the entire system.

The potential areas to reduce drag include all sides of the truck—front, sides, top, rear and bottom. The grill, bumper, and hood can be designed to minimize the pressure created by the front of the truck. Technologies such as aerodynamic mirrors and fuel tank fairings can reduce the surface area perpendicular to the wind and provide a smooth surface to minimize disruptions of the air flow. Roof fairings provide a transition to move the air smoothly over the tractor and trailer. Side extenders can minimize the air entrapped in the gap between the tractor and trailer. Lastly, underbelly treatments can manage the flow of air underneath the tractor. DOE has partnered with the heavy-duty industry to demonstrate high roof sleeper cab tractor and box trailer combinations that achieve a 50 percent improvement in freight efficiency evaluated as a 65,000 pound vehicle operating on the highway under somewhat controlled circumstances. However, these demonstration vehicles developed in SuperTruck are not necessarily designed to handle the rigors of daily use over actual in-use roads. For example, they generally have very limited ground clearance that would likely preclude operation in snow, and would be very susceptible to damage from potholes or other road hazards. Nevertheless, this SuperTruck program has led to significant advancements in the aerodynamics of combination tractor-trailers. While the agencies cannot simply apply the SuperTruck program achievements directly into the Phase 2 program because of the significant differences in the limited purpose of SuperTruck and the plenary applicability of a regulation to all operating conditions and duty cycles, it is helpful to assess the achievements and evaluate how the technologies could be applied into mass production into a variety of real world applications while maintaining performance throughout the full useful life of the vehicle. A manufacturer's SuperTruck demonstration vehicle achieved approximately a seven percent freight efficiency improvement over a 2009 MY baseline vehicle due to improvements in tractor aerodynamics and approximately 16 percent overall for the tractor-trailer combination.<sup>240</sup> The seven percent freight efficiency improvement due to tractor aerodynamics equates to roughly a 14 percent reduction in C<sub>d</sub>A from a 2010 MY baseline vehicle. The 2010 NAS Report on heavy-duty trucks found that there are achievable aerodynamic

<sup>239</sup> See RIA Chapter 2.8.4.1 for the analysis of the engine technologies and the associated fuel maps.

<sup>240</sup> Daimler Truck North America. SuperTruck Program Vehicle Project Review. June 19, 2014.

improvements which yield 3 to 4 percent fuel consumption reduction or six to eight percent reduction in Cd values, beyond a baseline reflecting performance of technologies used in today's SmartWay trucks.<sup>241</sup>

The Phase 2 aerodynamic packages are categorized as Bin I, Bin II, Bin III, Bin IV, Bin V, Bin VI, or Bin VII based on the wind averaged drag aerodynamic performance determined through testing conducted by the manufacturer. Bin I represents the least aerodynamic tractors, while Bins V–VII would be more aerodynamic than any tractor on the road today. A more complete description of these aerodynamic packages is included in Chapter 2.8.2.2 of the RIA. In general, the CdA values for each package and tractor subcategory were developed through EPA's coastdown testing of tractor-trailer combinations, the 2010 NAS report, and SAE papers.

The agencies received comments on our aerodynamic technology assessment. A de F Limited commented that wheel covers improve the aerodynamics of tractors and trailers, though the results may be lost in the noise when evaluated on tractors and trailers separately. Daimler commented that they found in their SuperTruck work that there are diminishing opportunities for tractor aerodynamics improvements and there may be impediments to some due to the need to access the back of cab and reliability concerns. AIR CTI commented that they have built a truck with aerodynamic technologies such as a front spoiler that automatically deploys at vehicle speeds over 30 mph, aerodynamic mirrors, and wheel covers over the rear wheels. ICCT found in their workshop that opportunities exist for high roof line haul tractor aerodynamic improvements that could lead to a three to nine percent improvement in fuel consumption over a 2010 baseline.<sup>242</sup> The HD manufacturers and EMA raised significant concerns with regard to the proposed aerodynamic assessment for Phase 2. They stated that even the best anticipated future-technology SuperTruck tractor configurations with a Phase 2 reference trailer likely would only qualify for the proposed Phase 2 Bin IV or possibly Bin V, leaving Bins V, VI and VII largely infeasible and unachievable.

The agencies' assessment is that the most aerodynamic tractor tested by EPA

in 2015 achieved Bin IV performance. See RIA Chapter 3.2.1.2. This vehicle did not include all of the possible aerodynamic technologies, such as wheel covers or active aerodynamics like a grill shutter or front air dam. Upon further analysis of simulation modeling of a SuperTruck tractor with a Phase 2 reference trailer with skirts, we agree with the manufacturers that a SuperTruck tractor technology package would only achieve the Bin V level of CdA, as discussed above and in RIA Chapter 2.8.2.2. Therefore, the agencies' assessment is that Bin V is achievable with known aerodynamic technologies, as discussed in RIA Chapter 2.4.2.1 and 2.8.2.2, but agree with the manufacturers that Bins VI and VII have less known technology paths. The agencies are including definitions of Bins VI and VII performance in the Phase 2 regulations with the understanding that aerodynamics will continue to improve over the next ten years until the full phase-in of the Phase 2 program and to provide a value to be input to GEM should they do so. However, we considered the comments and discuss the adoption rates of the more aerodynamic bins in Section III.D.1.c.i, which ultimately concludes that the standards should be predicated only on performance of aerodynamic technologies reflecting up to Bin V.

As discussed in Section III.E.2, the agencies are increasing the number of aerodynamic bins for low and mid roof tractors from the two levels adopted in Phase 1 to seven levels in Phase 2. The agencies adopted an increase in the number of bins for these tractors to reflect the actual range of aerodynamic technologies effective in low and mid roof tractor applications. The aerodynamic improvements to the bumper, hood, windshield, mirrors, and doors are developed for the high roof tractor application and then carried over into the low and mid roof applications.

### (iii) Tire Rolling Resistance

A tire's rolling resistance is a function of the tread compound material, the architecture and materials of the casing, tread design, the tire manufacturing process, and its operating conditions (surface, inflation pressure, speed, temperature, etc.). Differences in rolling resistance of up to 50 percent have been identified for tires designed to equip the same vehicle. Since 2007, SmartWay designated tractors have had steer tires with rolling resistance coefficients of less than 6.5 kg/metric ton for the steer tire and less than 6.6 kg/metric ton for

the drive tire.<sup>243</sup> Low rolling resistance (LRR) drive tires are currently offered in both dual assembly and wide-based single configurations. Wide based single tires can offer rolling resistance reduction along with improved aerodynamics and weight reduction. The rolling resistance coefficient target for the Phase 2 NPRM was developed from SmartWay's tire testing to develop the SmartWay certification and testing a selection of tractor tires as part of the Phase 1 and Phase 2 programs. Even though the coefficient of tire rolling resistance comes in a range of values, to analyze this range, the tire performance was evaluated at four levels for both steer and drive tires, as determined by the agencies. The four levels in the Phase 2 proposal included the baseline (average) from 2010, Level I and Level 2 from Phase 1, and Level 3 that achieves an additional 25 percent improvement over Level 2. The Level 1 rolling resistance performance represents the threshold used to develop SmartWay designated tires for long haul tractors. The Level 2 threshold represents an incremental step for improvements beyond today's SmartWay level and represents the best in class rolling resistance of the tires we tested for Phase 1. The Level 3 values in the NPRM represented the long-term rolling resistance value that the agencies predicts could be achieved in the 2025 timeframe. Given the multiple year phase-in of the standards, the agencies expect that tire manufacturers will continue to respond to demand for more efficient tires and will offer increasing numbers of tire models with rolling resistance values significantly better than today's typical low rolling resistance tires.

ICCT found in their workshop that opportunities exist for improvements in rolling resistance for tractor tires that could lead to a two to six percent improvement in fuel consumption when compared to a 2010 baseline tractor.<sup>244</sup> A fuel consumption improvement in this range would require a six to 18 percent improvement in the tractor tire rolling resistance levels. Michelin commented that the proposed values for the drive tires seem reasonable, though the 4.5 kg/ton level would require significantly higher adoption rate of

<sup>243</sup> U.S. EPA. "US EPA Low Rolling Resistance Tire Testing Activities" presentation to SAE Government-Industry Meeting. January 22, 2016. Values represent the ISO 28580 2 meter drum results because these align with the test method used to certify tractors to the GHG and fuel consumption standards.

<sup>244</sup> Delgado, Oscar. N. Lutsey. Advanced Tractor-Trailer Efficiency Technology Potential in the 2020–2030 Timeframe. April 2015. Docket EPA–HQ–OAR–2014–0827.

<sup>241</sup> See TIAAX, Note 230, Page 4–40.

<sup>242</sup> Delgado, Oscar. N. Lutsey. Advanced Tractor-Trailer Efficiency Technology Potential in the 2020–2030 Timeframe. April 2015. Docket EPA–HQ–OAR–2014–0827.

new generation wide base single tires. Michelin also stated that the value of 4.3 kg/ton target for steer tires is highly unlikely based on current evolution and that research shows that 5.0 kg/ton would be more likely.

The agencies have evaluated this comment and find it persuasive. The agencies analyzed the 2014MY certification data for tractors between the NPRM and final rulemaking. We found that the lowest rolling resistance value submitted for 2014 MY GHG and fuel efficiency certification for tractors was 4.9 and 5.1 kg/metric ton for the steer and drive tires respectively, while the highest rolling resistance tire had a CRR of 9.8 kg/metric ton.<sup>245</sup> We have accordingly increased the coefficient of rolling resistance for Level 3 tires in the final rule based on the comments and the certification data.

#### (iv) Tire Pressure Monitoring and Automatic Tire Inflation Systems

Proper tire inflation is critical to maintaining proper stress distribution in the tire, which reduces heat loss and rolling resistance. Tires with low inflation pressure exhibit a larger footprint on the road, more sidewall flexing and tread shearing, and therefore, have greater rolling resistance than a tire operating at its optimal inflation pressure. Bridgestone tested the effect of inflation pressure and found a 2 percent variation in fuel consumption over a 40 psi range.<sup>246</sup> Generally, a 10 psi reduction in overall tire inflation results in about a one percent reduction in fuel economy.<sup>247</sup> To achieve the intended fuel efficiency benefits of low rolling resistance tires, it is critical that tires are maintained at the proper inflation pressure.

Proper tire inflation pressure can be maintained with a rigorous tire inspection and maintenance program or with the use of tire pressure and inflation systems. According to a study conducted by FMCSA in 2003, about 1 in 5 tractors/trucks is operating with 1 or more tires underinflated by at least 20 psi.<sup>248</sup> A 2011 FMCSA study estimated

under inflation accounts for one service call per year and increases tire procurement costs 10 to 13 percent. The study found that total operating costs can increase by \$600 to \$800 per year due to under inflation.<sup>249</sup> A recent study by The North American Council on Freight Efficiency, found that openness to the use of tire pressure monitoring systems is increasing. It also found that reliability and durability of commercially available tire pressure systems are good and early issues with the systems have been addressed.<sup>250</sup> These automatic tire inflation systems (ATIS) monitor tire pressure and also automatically keep tires inflated to a specific level. The agencies proposed to provide a one percent CO<sub>2</sub> and fuel consumption reduction value for tractors with automatic tire inflation systems installed.

Tire pressure monitoring systems (TPMS) notify the operator of tire pressure, but require the operator to manually inflate the tires to the optimum pressure. Because of the dependence on the operator's action, the agencies did not propose an emission reduction value for tire pressure monitoring systems. Instead, we requested comment on this approach and sought data from those that support a reduction value be assigned to tire pressure monitoring systems. 80 FR 40218.

Many commenters including OOIDA, ATA, the truck manufacturers, RMA, UPS, Bendix, Doran, First Industries, NADA, and others suggested that the agencies should recognize TPMS as a technology in GEM, with the effectiveness value set at an equal level as ATIS. On the other hand, ARB generally supported the use of ATIS but not TPMS because it requires action from the driver. Many stakeholders stated that TPMS offers similar benefit, but at a lower cost, so is more acceptable in the market. UPS commented that they prefer TPMS because TPMS gives the truck owner an affirmative indication that there is a tire pressure problem, so it can be fixed, whereas the ATIS does not and they are concerned that ATIS simply keeps adding tire pressure automatically, wasting energy, and the truck owner may never know it. Bendix believes that

both ATIS and TPMS should be available in the market in the Phase 2 timeframe for tractors. RMA cited a NHTSA study of LD vehicles of model years 2004–2007 and found that the presence of a TPMS system led to a 55.6 percent reduction in the likelihood that a vehicle would have one tire that is significantly underinflated (25 percent or greater).<sup>251</sup> RMA also stated that NHTSA found TPMS to be effective in reducing moderate under inflation (at least 10 percent, but under 25 percent), which was reduced by 35.3 percent.<sup>252</sup> RMA's comments also stated for light trucks and vans, the effectiveness rates were even higher, with TPMS reducing severe under inflation by 61.2 percent and moderate under inflation by 37.7 percent. RMA commented that NHTSA found that in 2011, the TPMS systems save \$511 million in fuel costs across the vehicle fleet.<sup>253</sup> Navistar said the driver alert with TPMS is simpler and sufficient to ensure tire inflation in commercial applications. Navistar also commented that in heavy duty, a professional driver has both the incentive and the knowledge to keep tires adequately inflated, neither of which may necessarily be the case with light duty. Doran Manufacturing cited FMCSA studies on TPMS in 2006 that found TPMS were accurate at assessing tire pressure, in 2007 found acceptable durability of TPMS, and in 2011 found that TPMS or ATIS in fleet studies showed a 1.4 percent improvement in fuel economy. ARB's technology assessment found ATIS benefit at one percent.<sup>254</sup> ICCT found in their workshop that opportunities exist for ATIS that could lead to a 0.5 to two percent improvement in fuel consumption.<sup>255</sup> AIR CTI discussed the consequences of improper inflation pressures on tire life, safety, stopping distance, vehicle vibration, and damage to the roads. AIR CTI commented that their Central Tire Inflation system controls tire pressure from controls on the dash and is commonly used in logging and other off-road transportation.

After consideration of the comments, the agencies found them persuasive and are adopting provisions in Phase 2 GEM that allow manufacturers flexibility to

<sup>245</sup> U.S. EPA. Memo to Docket. Coefficient of Rolling Resistance and Coefficient of Drag Certification Data for Tractors. See Docket EPA-HQ-OAR-2014-0827.

<sup>246</sup> Bridgestone Tires. Real Questions, Real Answers. [http://www.bridgestonetrucktires.com/us\\_eng/real/magazines/ra\\_special-edit\\_4/ra\\_special4\\_fuel-tires.asp](http://www.bridgestonetrucktires.com/us_eng/real/magazines/ra_special-edit_4/ra_special4_fuel-tires.asp)

<sup>247</sup> "Factors Affecting Truck Fuel Economy," Goodyear, Radial Truck and Retread Service Manual. Accessed February 16, 2010 at [http://www.goodyear.com/truck/pdf/radialretserv/Retread\\_S9\\_V.pdf](http://www.goodyear.com/truck/pdf/radialretserv/Retread_S9_V.pdf).

<sup>248</sup> American Trucking Association. Tire Pressure Monitoring and Inflation Maintenance. June 2010. Page 3. Last accessed on December 15, 2014 at <http://www.trucking.org/ATA%20Docs/About/>

*Organization/TMC/Documents/Position%20Papers/Study%20Group%20Information%20Reports/Tire%20Pressure%20Monitoring%20and%20Inflation%20Maintenance%2%80%94TMC%20I.R.%202010-2.pdf.*

<sup>249</sup> TMC Future Truck Committee Presentation "FMCSA Tire Pressure Monitoring Field Operational Test Results," February 8, 2011.

<sup>250</sup> North American Council for Freight Efficiency, "Tire Pressure Systems," 2013.

<sup>251</sup> 80 FR at 40173.

<sup>252</sup> 80 FR 40278.

<sup>253</sup> 80 FR at 40258.

<sup>254</sup> California Air Resources Board. Draft Technology Assessment: Engine/Powerplant and Drivetrain Optimization and Vehicle Efficiency. June 2015. Page III-3. Report is available at [www.arb.ca.gov](http://www.arb.ca.gov).

<sup>255</sup> Delgado, Oscar. N. Lutsey. Advanced Tractor-Trailer Efficiency Technology Potential in the 2020–2030 Timeframe. April 2015. Docket EPA-HQ-OAR-2014-0827.



show compliance with the CO<sub>2</sub> and fuel consumption standards using various technologies, including the flexibility to adopt ATIS or TPMS (see 40 CFR 1037.520). This reflects a change from the Phase 2 NPRM, where only ATIS (not TPMS) was a GEM input. The agencies believe that sufficient incentive exists for truck operators to address low tire pressure conditions if they are notified that they exist through a TPMS.

The agencies also considered the comments to determine the effectiveness of TPMS and ATIS. The agencies conducted a further review of the FCMSA study cited by commenters and we interpret the results of the study to indicate that overall a combination of TPMS and ATIS in the field achieved 1.4 percent reduction. However, it did not separate the results from each technology, and therefore did not indicate that TPMS and ATIS achieved the same levels of reduction. Therefore, we set the effectiveness of TPMS slightly lower than ATIS to reflect that operators will be required to take some action to insure that the proper inflation pressure is maintained. The input values to the Phase 2 GEM are set to 1.2 percent reduction in CO<sub>2</sub> emissions and fuel consumption for ATIS and 1.0 percent reduction for TPMS. In other words, if a manufacturer installs an ATIS onto a vehicle, then they will enter 1.2 percent into the Tire Pressure System value in their GEM input file. If a manufacturer installs a TPMS, then they will input 1.0 percent into the Tire Pressure System value in GEM.

EPA proposed a definition of ATIS in 40 CFR 1037.801 to qualify it as a technology input to GEM. The proposed definition stated that "Automatic tire inflation system means a system installed on a vehicle to keep each tire inflated to within 10 percent of the target value with no operator input." The agencies received comment about this definition. Meritor suggested adopting the historical industry definition of ATIS as "Automatic Tire Inflation Systems maintain tire pressure at a single preset level and are pneumatically or electronically activated. These systems eliminate the need to manually inflate tires." Meritor is concerned with the proposed definition of ATIS that required the system must "keep each tire inflated to within 10 percent" to qualify as a technology input to GEM. Meritor commented that the proposed definition is not consistent with the manner in which these systems are used in practice. Meritor stated that an ATIS assures that tires will always be running at the recommended cold tire inflation pressure. The agencies are adopting

changes to reflect the appropriate definition of ATIS in the final rule (see 40 CFR 1037.801).

#### (v) Idle Reduction

Auxiliary power units (APU), fuel operated heaters (FOH), battery supplied air conditioning, and thermal storage systems are among the technologies available today to reduce fuel consumption and CO<sub>2</sub> emissions from extended idling (or hoteling). Each of these technologies reduces fuel consumption during idling relative to a truck without this equipment. In Phase 1 and in the Phase 2 NPRM, the agencies took an approach whereby tractor manufacturers could input an idle reduction value into GEM only if a vehicle included a tamper-proof automatic engine shutdown system (AESS) programmed to shut down the engine after five minutes or less. This approach allows the manufacturers to use AESS as one of the technologies (in combination with other technologies such as aerodynamics or low rolling resistance tires) to demonstrate compliance with the CO<sub>2</sub> emission and fuel consumption standards. The agencies also included several override provisions for the AESS and a discounted GEM input value for an expiring AESS or a system that allowed a specified number of hours of idling per year (see 40 CFR 1037.660).

The agencies did not differentiate between the various idle reduction technologies in terms of effectiveness because we adopted in Phase 1 and proposed in Phase 2 a conservative effectiveness level to recognize that some vehicles may be sold with only an AESS but may then install an idle reduction technology after it leaves the factory (76 FR 57207). The effectiveness for AESS in Phase 1 and proposed in Phase 2 was determined by comparing the idle fuel consumption of the main engine at approximately 0.8 gallons per hour to the fuel consumption of a diesel powered APU that consumes approximately 0.2 gallons per hour. This difference equates to a five percent reduction in overall CO<sub>2</sub> emissions and fuel consumption of a Class 8 sleeper cab. A diesel powered APU was selected for determining the effectiveness and cost because it was a conservative estimate. Diesel powered APUs have the highest fuel consumption and cost of the idle reduction technologies considered.<sup>256</sup> The agencies proposed that a tamper-proof AESS would receive a five percent CO<sub>2</sub> emissions and fuel consumption reduction in GEM for vehicles that included this technology.

<sup>256</sup> See the draft RIA Chapter 2.4.8 for details.

This value is in line with the TIAX assessment which found a five percent reduction in overall fuel consumption to be achievable.<sup>257</sup> The agencies requested comments on the proposed approach.

The agencies received a number of comments regarding "mandating APU" or "mandating AESS." There is a misconception of the proposed Phase 2 program where stakeholders thought that the agencies were mandating use of APUs. This is incorrect. The tractor standards are performance standards. The agencies merely *projected* an adoption rate of up to 90 percent for tamper-proof AESS in our analysis for determining the stringency level of the proposed standard. As stated above, we did not propose to differentiate between the various idle reduction technologies in terms of effectiveness and only used the diesel powered APU in terms of determining the cost and effectiveness of a potential standard. Also, because the standards are performance standards, the agencies are not mandating any specific fuel consumption or GHG emission reducing technology. For each standard, we developed one potential technology pathway to demonstrate the feasibility of the standards, but manufacturers will be free to choose other paths.<sup>258</sup>

The agencies received a significant number of comments about idle reduction for sleeper cabs, including recommendations to the agencies to assess the emission reduction for a variety of idle reduction technologies instead of just a tamper-proof AESS. ATA, NADA, and others commented that fleets have a variety of choices available in providing the driver power and comfort in-lieu of idling including use of APUs, FOHs, stop-start (main engine turns on only to recharge the battery after several hours), shore power, battery stand-by, stand-alone anti-idling infrastructure establishments, slip-seat operations, and hotel accommodations. Convoy Solutions stated that IdleAir's electrified parking spaces are an important bridge technology to more electrified solutions. IdleAir commented it may be possible to recognize off board behavior at the OEM level as a buyer of a new truck could enter into a contract with an EPS provider prior to accepting delivery. ATA and First Industries support efficiency credits for idling reduction options installed by fleets either at the OEM point-of-sale or installed in the after-market.

<sup>257</sup> See the 2010 NAS Report at 128.

<sup>258</sup> The one exception being the design standards for certain non-aero trailers. See Section IV below.



The agencies also received comments regarding the level of effectiveness of idle reduction technologies. ICCT found in their workshop that opportunities exist for line haul tractor idle reduction improvements that could lead to a four to seven percent improvement in fuel consumption.<sup>259</sup> MEMA recommended that the agencies modify the projected effectiveness level based on the merit of the individual idle control technology. MEMA’s recommendation for effectiveness levels based on the fuel consumption and GHG emissions of each technology ranged from 7.7 g/ton-mile for fuel cell APU, 6 g/ton-mile for diesel APU, and 9 g/ton-mile for batter air conditioning systems, fuel operated heater, and combinations of technologies. MEMA supports the agencies’ proposal that, in order to qualify for the use of an idle reduction technology in GEM, it is mandatory that the truck be equipped with an AESS. MEMA also commented that in the Phase 1 RIA, the agencies assumed a Class 8 sleeper cab spends 1,800 hours in extended idle per year and travels about 250 days per year. MEMA recommends that the agencies use 2,500 annual hours for APUs and 1,250 annual hours for FOHs to better reflect real-world application and experiences. Additionally, MEMA recommends that 0.87 gallon/hour fuel consumed by the main engine during idle be used in the calculations for credit.

The agencies also received a significant number of comments about idle reduction encouraging the agencies to consider recognizing adjustable AESS instead of only a tamper-proof AESS. ATA commented that most fleets already purchase “programmable” idle shutdown timers to limit idling due to the national patchwork of anti-idling laws currently in place. ATA continued to say that these timers are typically set for a given period of time throughout the initial fleet’s ownership period. ATA also stated as witnessed under Phase I, fleets are unwilling to purchase hard-programmed, tamper-proof AESS given their need for flexibility regarding their resale of used equipment on the secondary market. Caterpillar also noted that fleets do not purchase tamper-resistant automatic engine shutdown systems; therefore, AESS should not be part of the stringency setting, unless the agencies also consider programmable versions of AESS. PACCAR, Volvo and EMA request the agencies to consider partial credit for AESS that are

programmed to a 5-minute or sooner shutdown but are not tamper-resistant to changes by an owner. Daimler and Navistar also commented that the agencies should consider adjustable AESS as a technology input to GEM. Daimler found that less than one percent of the adjustable AESS systems set at or below 5 minutes that were installed in customer tractors were deactivated or reprogrammed to a value longer than 5 minutes. PACCAR viewed the proposed tamper-proof AESS for 1.259 million miles as unrealistic and not reflecting current market conditions.

While the agencies do not necessarily believe that customer reluctance in the initial years of Phase 1 should be considered insurmountable, we do agree with commenters that the agencies should allow adjustable AESS to be a technology input to GEM and should differentiate effectiveness based on the idle reduction technology installed by the tractor manufacturer. We will still apply the Phase 1 requirement that the AESS be programmed to 5 minutes or less at the factory to qualify as a technology input in GEM (see 40 CFR 1037.660), but for Phase 2 will allow a variety of both tamper-proof and adjustable systems to qualify for some reduction (*i.e.* to be recognized by GEM). Any changes made subsequent to the factory but prior to delivery to the purchaser, must be accounted for in the manufacturer’s end of year reports.

The agencies developed effectiveness levels for the extended idle technologies from literature, SmartWay work, and the 2010 NAS report. The agencies also reviewed the NACFE report on programmable engine parameters which included a fleet survey on how often the fleets change programmable parameters, such as automatic engine shutdown timers.<sup>260</sup> The survey found that approximately 70 percent of these fleets never changed the setting. The agencies developed the effectiveness levels to reflect that there is some greater uncertainty of adjustable AESS systems, therefore the effectiveness values are discounted from the values determined for tamper-proof AESS. A detailed discussion regarding the comments and the associated calculations to determine the effectiveness of each of the idle reduction technologies are included in RIA Chapter 2.4.8.1.1. In summary, the effectiveness for each type of idle reduction technology is included in Table III–9.

TABLE III–9—IDLE REDUCTION TECHNOLOGY EFFECTIVENESS

Idle Reduction Technology	Idle reduction value in GEM (%)
Tamper-Proof AESS .....	4
Tamper-Proof AESS w/Diesel APU .....	4
Tamper-Proof AESS w/Battery APU .....	6
Tamper-Proof AESS w/Automatic Stop-Start .....	3
Tamper-Proof AESS w/FOH Cold, Main Engine Warm ..	3
Adjustable AESS w/Diesel APU .....	3
Adjustable AESS w/Battery APU .....	5
Adjustable AESS w/Automatic Stop-Start .....	3
Adjustable AESS w/FOH Cold, Main Engine Warm ..	2
Adjustable AESS programmed to 5 minutes .....	1

In addition to extended idling (or hoteling) by sleeper cabs, the agencies discussed work day idle by day cabs in the Phase 2 NPRM. 80 FR 40217. Day cab tractors often idle while cargo is loaded or unloaded, as well as during the frequent stops that are inherent with driving in urban traffic conditions near cargo destinations. Prior to issuing the Phase 2 NPRM, the agencies reviewed literature to quantify the amount of idling which is conducted outside of hoteling operations. One study, conducted by Argonne National Laboratory, identified several different types of trucks which might idle for extended amounts of time during the work day.<sup>261</sup> Idling may occur during the delivery process, queuing at loading docks or border crossings, during power take off operations, or to provide comfort during the work day. However, the study provided only “rough estimates” of the idle time and energy use for these vehicles. At the time of the Phase 2 NPRM, the agencies were not able to appropriately develop a baseline of workday idling for day cabs and identify the percent of this idling which could be reduced through the use of AESS. We welcomed comment and data on quantifying the effectiveness of AESS on day cabs. We further requested comment on the possibility of adapting the idle-only duty cycle for vocational vehicles to certain day cab tractors, and also considered the possibility of neutral idle technology for tractors using torque-converter automatic

<sup>259</sup> Delgado, Oscar. N. Lutsey. Advanced Tractor-Trailer Efficiency Technology Potential in the 2020–2030 Timeframe. April 2015. Docket EPA–HQ–OAR–2014–0827.

<sup>260</sup> North American Council for Freight Efficiency. Confidence Report: Programmable Engine Parameters. February 2015. Page 48.

<sup>261</sup> Gaines, L., A. Vyas, J. Anderson. Estimation of Fuel Use by Idling Commercial Trucks. January 2006.

transmissions and stop-start for any tractor. Id.

The agencies received a significant number of comments regarding day cab idle reduction. CARB commented that the agencies should include idle reduction technologies for day cabs, similar to the proposed vocational vehicle approach. CARB stated that even if the first owners do not see significant emission reductions, many of the day cab tractors are used in port and drayage applications in their second life where they would see significant reductions. CARB suggested that the GEM composite weighting factor for idle should be between 5 and 10 percent. Bendix would like to see the vocational vehicle idle reduction approach extended to day cab tractors based on their data which found that there are many applications of day cab tractors that spend a significant portion of their day's drive time at idle, especially pick-up and delivery type applications and a growing number of fleets that run hub and spoke type operations. MEMA supported extending neutral idle and stop-start technologies to day cab tractors. MEMA recommends that the agencies set the effectiveness of day cabs idle reduction technologies at a value equal to 35 percent of the effectiveness associated with a comparable technology in a Class 8 sleeper cab. Allison stated that agencies should include automatic neutral in all tractors. Allison stated that automatic neutral is standard with the Allison TC10 and is available with the Allison 3000 and 4000 Series transmissions.

Daimler commented that they have not validated that stop-start strategies are viable for Class 7 and 8 applications and considers it premature for the agencies to project that stop-start strategies are viable for this class of engines. Daimler stated that lubrication of critical bearing surfaces is lacking or severely compromised during engine start up due to the lack of lubricating oil pressure and this lack of lubrication leads to metal to metal contact, wear, and ultimately failure. In addition, Daimler commented that firing pressures inherent to compression ignition engines further exacerbate wear as compared to, for example, spark ignition engines where stop-start technology is being increasingly applied. Daimler also stated that these known problems, coupled with the extremely long million mile plus service life expectations for this heavier class of heavy-duty engines, together pose a development challenge that is significantly more challenging than that posed to spark ignition engines in passenger cars. Daimler further stated

that heat soak of temperature critical parts and temporary disruption of their lubrication/cooling systems will have to be understood and possible degradations handled through modifications at either component or system basis, the extent of which is not yet fully quantified. Daimler also stated that similarly, on the turbocharger side, the larger speed swings will shorten turbocharger wheel life, which is increasingly challenged in vocational applications that are characteristically more transient as compared to the relatively steady operation nature of line haul.

The agencies considered the comments, both supporting and raising concerns over idle reduction in day cabs. The agencies determined that neutral idle for automatic transmissions is an appropriate technology for use in tractors. Therefore, the agencies are adopting provisions in Phase 2 to recognize neutral-idle in automatic transmissions as an input to GEM. Our analysis shows that neutral idle effectiveness is approximately 0.8 to one percent over the composite day cab tractor cycles, as shown in RIA Chapter 2.8.2.6.2. The agencies will also include neutral idle as a GEM input for sleeper cabs, though the effectiveness is very low. The agencies are predicating the standards for day cabs based on a technology package that includes neutral idle.

In terms of stop-start technologies in tractors, the agencies are not including it as a technology input to GEM because we believe the technology, as applied to tractors, needs further development. If this technology is developed in the future for tractors, then manufacturers may consider applying for off-cycle technology credits. Since the agencies are not predicating the Phase 2 standards on adoption of start-stop technologies, the agencies are also not including this technology as a GEM input.

#### (vi) Transmissions

As discussed in the 2010 NAS report, automatic (AT) and automated manual transmissions (AMT) may offer the ability to improve vehicle fuel consumption by optimizing gear selection compared to an average driver.<sup>262</sup> However, as also noted in the

<sup>262</sup> Manual transmissions require the driver to shift the gears and manually engage and disengage the clutch. Automatic transmissions shift gears through computer controls and typically include a torque converter. An AMT operates similar to a manual transmission, except that an automated clutch actuator disengages and engages the drivetrain instead of a human driver. An AMT does not include a clutch pedal controllable by the driver or a torque converter.

report and in the supporting TIAX report, the improvement is very dependent on the driver of the truck, such that reductions ranged from zero to eight percent.<sup>263</sup> Well-trained drivers would be expected to perform as well or even better than an automated transmission since the driver can see the road ahead and anticipate a changing stoplight or other road condition that neither an automatic nor automated manual transmission can anticipate. However, less well-trained drivers that shift too frequently or not frequently enough to maintain optimum engine operating conditions could be expected to realize improved in-use fuel consumption by switching from a manual transmission to an automatic or automated manual transmission. As transmissions continue to evolve, dual clutch transmissions (DCTs) are now being used in the European heavy-duty vehicle market. DCTs operate similar to AMTs, but with two clutches so that the transmission can maintain engine speed during a shift which improves fuel efficiency.

The benefits for automated manual, automatic, and dual clutch transmissions were developed from literature, from simulation modeling conducted by Southwest Research Institute, and powertrain testing conducted at Oak Ridge National Laboratory. The proposed Phase 2 benefit of these transmissions in GEM was set at a two percent improvement over a manual transmission due to the automation of the gear shifting. 80 FR 40217.

Allison Transmission commented that their real world studies indicate that automatic transmissions perform as well or better than AMTs or DCTs in terms of GHG and fuel efficiency impact. Allison commented that their ATs can exceed the 2 percent level estimated at proposal, but believe it is a reasonable level to apply this level of effectiveness for ATs and AMTs. Allison stated that automatic transmissions in tractors have neutral at stop capability, first gear lockup operation, load-based and grade-based shift algorithms and acceleration rate management that contribute to the overall fuel efficiency of ATs in tractors. Allison also commented that although DCTs should logically perform better than the MT baseline, there was no record information to support that assumption. Volvo commented that fuel consumption with their I-Shift DCT is the same as the I-Shift AMT. PACCAR recommends that the agencies take a more detailed approach to assessing transmission advances and revise the

<sup>263</sup> See TIAX, Note 230, above at 4–70.

agencies' estimate to reflect technologies that are already under true consideration for use in production powertrains.

UCS commented that as much as 1.3 to 2.0 percent savings from tractor-trailers could be added to the proposed stringency to reflect the true potential from tractor-trailers from powertrain optimization, particularly since every major manufacturer already offers at least one "integrated powertrain" option in its long-haul fleet. ICCT referred to two studies related to tractor-trailer technologies in their comments.<sup>264 265</sup> In their stakeholder workshop, they found that the effectiveness of automated manual transmissions ranged between two and three percent. They also cited another finding that highlighted opportunities to improve transmission efficiency, including direct drive, which would provide about two percent fuel consumption reduction.<sup>266</sup>

The agencies' assessment of the comments is that Allison, ICCT, and Volvo support the proposed two percent effectiveness for AT and AMT transmission types. In addition, the agencies reviewed the NACFE report on electronically controlled transmissions (AT, AMT, and DCT).<sup>267</sup> This report had similar findings as those noted above in the NAS 2010 report. Electronically controlled transmissions were found to be more fuel efficient than manual transmissions, though the amount varied significantly. The report also stated that fleets found that electronically controlled transmissions also reduced the fuel efficiency variability between drivers. Therefore after considering the comments related to effectiveness and additional reports, the agencies are adopting as proposed a two percent effectiveness for AMT. As discussed in RIA 2.8.2.5, the agencies conducted powertrain testing at Oak Ridge National Laboratory to compare the fuel efficiency of an AMT to an AT. Based on the results, the agencies expect that automatic transmissions designed for long haul operation and automated manual transmissions will perform

similarly and have similar effectiveness when compared to a manual transmission.

The benefit of the AMT's automatic shifting compared to a manual transmission is recognized in Phase 2 GEM by simulating the MT as an AMT and increasing the emission results from the simulation by two percent. For ATs, the agencies developed the default automatic transmission inputs to GEM to represent a typical heavy-duty automatic transmission, which is less efficient than the TC10 (the transmission tested at Oak Ridge National Lab). The agencies selected more conservative default transmission losses in GEM so that we would not provide a false efficiency improvement for the less efficient automatic transmissions that exist in the market today. Under the regulations in this rulemaking, manufacturers that certify using the TC10 transmission would need to either conduct the optional transmission gear efficiency testing or powertrain testing to recognize the effectiveness of this type of automatic transmission in GEM. In our technology packages developed to set the Phase 2 standard stringencies, the agencies used a two percent effectiveness for automatic transmissions with neutral idle under the assumption that either powertrain or transmission gear efficiency tests would be conducted. The compliance costs for this type of testing (which crosses over both the vocational and tractor programs) are included as noted in RIA Chapter 7.2.1.2.

The agencies agree with PACCAR that we should consider future transmission advances. There are three certification pathways for manufacturers to assess benefits of future transmissions; that is, to generate a value reflecting greater improvement than the two percent GEM input. The first is an optional powertrain test (40 CFR 1037.550), the second is an optional transmission efficiency test (40 CFR 1037.565), and the third is off-cycle credits (40 CFR 1037.610).

The agencies acknowledge UCS's comment about increasing the stringency of the tractor program due to the opportunity to further improve powertrain optimization through powertrain testing. For the Phase 2 final rule, we have made several changes that capture much of the improvement potential highlighted by UCS. First, the required use of a cycle average fuel map in lieu of a steady state fuel map for evaluating the transient cycle in GEM will recognize improvements to transient fuel control of the engine. The agencies are including the impact of

improved transient fuel control in the engine fuel maps used to derive the final standards. Second, the optional transmission efficiency test will recognize the benefits of improved gear efficiencies. The agencies have built some improvements in transmission gear efficiency into the technology package used to derive the final standards. This leaves only the optimization of the transmission shift strategy, which would need to be captured on a powertrain test. The agencies believe that the opportunity of shift strategy optimization is less for tractors than for other types of vocational vehicles because a significant portion of the tractor drive cycles are at highway speeds with limited transmission shifting. Therefore, we have not included the powertrain optimization portion only recognized through powertrain testing into the standard setting for the final rule.

The agencies also proposed standards that considered the efficiency benefit of transmissions that operate with top gear direct drive instead of overdrive. In the proposal, we estimated that direct drive had two percent higher gear efficiency than an overdrive gear. 80 FR 40229. The benefit of direct drive was recognized through the transmission gear ratio inputs to GEM. Direct drive leads to greater reductions of CO<sub>2</sub> emissions and fuel consumption during highway operation, but virtually none in transient operation. The agencies did not receive any negative comments regarding the efficiency difference between direct drive and overdrive; therefore, we continued to include the default transmission gear efficiency advantage of two percent for a gear with a direct drive ratio in the version of GEM adopted for the final Phase 2 rules.

The agencies are also adopting in Phase 2 an optional transmission efficiency test (40 CFR 1037.565) for generating an input to GEM that overrides the default efficiency of each gear based on the results of the test. Although optional, the transmission efficiency test will allow manufacturers to reduce the CO<sub>2</sub> emissions and fuel consumption by designing better transmissions with lower friction due to better gear design and/or mandatory use of better lubricants. The agencies project that transmission efficiency could improve one percent over the 2017 baseline transmission in Phase 2. Our assessment was based on comments received and discussions with transmission manufacturers.<sup>268</sup>

<sup>264</sup> Lutsey, Nic. T. Langer, S. Khan. Stakeholder Workshop on Tractor-Trailer Efficiency Technology in the 2015–2030 Timeframe. August 2014. Docket EPA–HQ–OAR–2014–0827.

<sup>265</sup> Delgado, Oscar. N. Lutsey. Advanced Tractor-Trailer Efficiency Technology Potential in the 2020–2030 Timeframe. April 2015. Docket EPA–HQ–OAR–2014–0827.

<sup>266</sup> Stoltz, T. and Dorobantu, M. Transmission Potential to Contribute to CO<sub>2</sub> Reduction: 2020 and Beyond Line Haul Perspective. ACEEE/ICCT Workshop on Emerging Technologies for Heavy-Duty Fuel Efficiency. July 2014.

<sup>267</sup> North American Council for Freight Efficiency. Confidence Report: Electronically Controlled Transmissions. December 2014.

<sup>268</sup> Memorandum to the Docket "Effectiveness of Technology to Increase Transmission Efficiency." July 2016.

## (vii) Drivetrain and Engine Downsizing

**Downsizing:** As tractor manufacturers continue to reduce the losses due to vehicle loads, such as aerodynamic drag and rolling resistance, the amount of power required to move the vehicle decreases. In addition, engine manufacturers continue to improve the power density of heavy-duty engines through means such as reducing the engine friction due to smaller surface area. These two changes lead to the ability for truck purchasers to select lower displacement engines while maintaining the previous level of performance. Engine downsizing could be more effective if it is combined with the downsizing assuming increased brake mean effective pressure does not affect durability. The increased efficiency of the vehicle moves the operating points down to a lower load zone on a fuel map, which often moves the engine away from its sweet spot to a less efficient zone. In order to compensate for this loss, downsizing allows the engine to run at a lower engine speed and move back to higher load zones, and thus can slightly improve fuel efficiency. Reducing the engine size allows the vehicle operating points to move back to the sweet spot, thus further improving fuel efficiency. Engine downsizing can be accounted for as a vehicle technology through the use of the engine's fuel map in GEM in combination with the vehicle's transmission gear ratios, drive axle ratio, and tire diameter. The agencies evaluated the impact of downsizing in setting the stringencies by modeling different rear axle ratios in GEM. As shown in RIA Chapter 2.8.2.7, a decrease in final drive ratio from 2.6 to 2.3 will lead to a 2.5 percent reduction in tractor CO<sub>2</sub> emissions and fuel consumption. The reshaping of the torque curve of an engine to increase the low speed torque and reduce the speed at which maximum torque occurs, will impact the CO<sub>2</sub> emissions and fuel consumption on the engine test cycles, but will also have a small impact on the vehicle fuel consumption. Higher torque at lower engine speeds will allow the transmission to operate in top gear for a longer period of the time which will reduce the number of downshifts over a cycle and in turn means that the engine speed is lower on average. This benefit will show up in GEM. Additional information on engine downsizing can be found in RIA Chapter 2.3.8.

**Low Friction Axle and Wheel Bearing Lubricants:** The 2010 NAS report assessed low friction lubricants for the drivetrain as providing a one percent

improvement in fuel consumption based on fleet testing.<sup>269</sup> A field trial of European medium-duty trucks found an average fuel consumption improvement of 1.8 percent using SAE 5W-30 engine oil, SAE 75W90 axle oil and SAE 75W80 transmission oil when compared to SAE 15W40 engine oil and SAE 90W axle oil, and SAE 80W transmission oil.<sup>270</sup> The light-duty 2012-16 MY vehicle rule and the pickup truck portion of this program estimate that low friction lubricants can have an effectiveness value between zero and one percent compared to traditional lubricants. In the Phase 2 proposal, the agencies proposed the reduction in friction due to low viscosity axle lubricants of 0.5 percent. 80 FR 40217.

Lubrizol commented that high performing lubricants should play a role in Phase 2. Lubrizol also supports the axle test procedures to further recognize axle efficiency improvements. PACCAR recommended eliminating the rear axle efficiency test and provide credits based on calculated values.

The agencies' assessment of axle improvements found that axles built in the Phase 2 timeline could be 2 percent more efficient than a 2017 baseline axle.<sup>271</sup> In lieu of a fixed value for low friction axle lubricants (*i.e.* in lieu of a specified GEM input), the agencies are adopting an axle efficiency test procedure (40 CFR 1037.560), as discussed in the NPRM. 80 FR 40185. The axle efficiency test will be optional, but will allow manufacturers to recognize in GEM reductions in CO<sub>2</sub> emissions and fuel consumption through improved axle gear designs and/or mandatory use of low friction lubricants. The agencies are not providing an alternate path to recognize better lubricants without axle testing.

**Axle Configuration:** Most tractors today have three axles—a steer axle and two rear drive axles, and are commonly referred to as 6x4 tractors. Manufacturers offer 6x2 tractors that include one rear drive axle and one rear non-driving axle. The 6x2 tractors offer three distinct benefits. First, the non-driving rear axle does not have internal friction and therefore reduces the overall parasitic losses in the drivetrain. In addition, the 6x2 configuration typically weighs approximately 300 to

400 lbs less than a 6x4 configuration.<sup>272</sup> Finally, the 6x2 typically costs less or is cost neutral when compared to a 6x4 tractor. Sources cite the effectiveness of 6x2 axles at between one and three percent.<sup>273 274</sup> The NACFE report found in OEM evaluations of 6x2 axles that the effectiveness ranged between 1.6 and 2.2 percent. NACFE also evaluated 6x2 axle tests conducted by several fleets and found the effectiveness in the range of 2.2 to 4.6 percent. Similarly, with the increased use of double and triple trailers, which reduce the weight on the tractor axles when compared to a single trailer, manufacturers offer 4x2 axle configurations. The 4x2 axle configuration would have as good as or better fuel efficiency performance than a 6x2. The agencies proposed to apply a 2.5 percent improvement in vehicle efficiency to 6x4 and 4x2 axle configurations. 80 FR 40217-218.

Meritor stated in their comments that their internal testing and real world testing supported the 2.5 percent efficiency proposed by the agencies for 6x2 axles. Meritor suggested the need to better define a “disengageable tandem” when the agencies discussed what we called axle disconnect in the NPRM. Meritor recommends that a fuel efficiency benefit of 2.0 percent be assigned to the disengageable tandem for the 55 mph and 65 mph drive cycles to account for the more limited use.

ICCT referred to two studies related to tractor-trailer technologies in their comments.<sup>275 276</sup> In their stakeholder workshop, they found that the effectiveness of 6x2 axles ranged between one and 2.5 percent.

The agencies' assessments of these technologies show that the reductions are in the range of two to three percent. For the final rule, the agencies are simulating 6x2, 4x2, and disengageable axles within GEM based on the manufacturer input of the axle configuration instead of providing a fixed value for the reduction. This approach is more technically sound because it will take into account future changes in axle efficiency. See RIA

<sup>272</sup> North American Council for Freight Efficiency. “Confidence Findings on the Potential of 6x2 Axles.” 2014. Page 16.

<sup>273</sup> *Ibid.*

<sup>274</sup> Reinhart, T.E. (June 2015). *Commercial Medium- and Heavy-Duty Truck Fuel Efficiency Technology Study—Report #1*. (Report No. DOT HS 812 146). Washington, DC: National Highway Traffic Safety Administration.

<sup>275</sup> Lutsey, Nic. T. Langer, S. Khan. Stakeholder Workshop on Tractor-Trailer Efficiency Technology in the 2015-2030 Timeframe. August 2014. Docket EPA-HQ-OAR-2014-0827.

<sup>276</sup> Delgado, Oscar. N. Lutsey. Advanced Tractor-Trailer Efficiency Technology Potential in the 2020-2030 Timeframe. April 2015. Docket EPA-HQ-OAR-2014-0827.

<sup>269</sup> See the 2010 NAS Report, Note 229, page 67.

<sup>270</sup> Green, D.A., et. al. “The Effect of Engine, Axle, and Transmission Lubricant, and Operating Conditions on Heavy Duty Diesel Fuel Economy. Part 1: Measurements.” SAE 2011-01-2129. SAE International Journal of Fuels and Lubricants. January 2012.

<sup>271</sup> Memorandum to the Docket “Effectiveness of Technology to Increase Axle Efficiency.” July 2016.

Chapter 4 for additional details regarding GEM.

(viii) Accessories and Other Technologies

*Accessory Improvements:* Parasitic losses from the engine come from many systems, including the water pump, oil pump, and power steering pump. Reductions in parasitic losses are one of the areas being developed under the DOE SuperTruck program. As presented in the DOE Merit reviews, Navistar stated that they demonstrated a 0.45 percent reduction in fuel consumption through water pump improvements and 0.3 percent through oil pump improvements compared to a current engine. In addition, Navistar showed a 0.9 percent benefit for a variable speed water pump and variable displacement oil pump. Detroit Diesel reports a 0.5 percent benefit coming from improved water pump efficiency.<sup>277</sup> It should be noted that water pump improvements include both pump efficiency improvement and variable speed or on/off controls. Lube pump improvements are primarily achieved using variable displacement pumps and may also include efficiency improvement. All of these results shown in this paragraph are demonstrated through the DOE SuperTruck program at a single operating point on the engine map, and therefore the overall expected reduction of these technologies is less than the single point result. The agencies proposed that compared to 2017 MY air conditioners, air conditioners with improved efficiency compressors will reduce CO<sub>2</sub> emissions by 0.5 percent. Improvements in accessories, such as power steering, can lead to an efficiency improvement of one percent over the 2017 MY baseline. 80 FR 40218.

Navistar commented that the proposed “electrically powered pumps for engine cooling” be revised to include “electronically controlled variable speed coolant pumps” to align with the Preamble descriptions and technology under development as part of the SuperTruck program. Navistar commented that shifting to fully electronic pump creates reliability concerns and adds additional complexity due to the size of the necessary pumps (2+ horsepower) and that the increased power load will require a larger alternator and upgraded wiring. Navistar suggested that in addition to a fully electric pump, Dual Displacement power steering should also be included as an accessory improvement because this technology reduces parasitic loads by applying

power proportional to steering demand. ZF TRW Commercial Steering commented that they are developing a power steering pump that uses a secondary chamber deactivation during highway cruise operations that reduce the pump drive torque by 30 to 40 percent. Navistar also commented that the effectiveness for an electrified air conditioning compressor is understated in the NPRM. Navistar’s estimates are closer to 1.5 percent when in use which will be during the use of air conditioning and during defrost; therefore, the effective benefit should be one percent. Daimler commented that the proposed high efficiency air conditioning effectiveness should be refined and that other opportunities to reduce losses, such as blend air systems, should be considered. In response to the comments, the agencies evaluated a set of accessories that can be designed to reduce accessory losses. Due to the complexity in determining what qualifies as an efficient accessory, we are maintaining the proposed language for accessories for tractors which provides defined effectiveness values for only electric air conditioning compressors and electric power steering pumps and coolant pumps. Manufacturers have the option to apply for off-cycle credits for the other types and designs of high efficiency accessories.

*Intelligent Controls:* Skilled drivers know how to control a vehicle to obtain maximum fuel efficiency by, among other things, considering road terrain. For example, the driver may allow the vehicle to slow down below the target speed on an uphill and allow it to go over the target speed when going downhill, to essentially smooth out the engine demand. Electronic controls can be developed to essentially mimic this activity. The agencies proposed to provide a two percent reduction in fuel consumption and CO<sub>2</sub> emissions for vehicles configured with intelligent controls, such as predictive cruise control. 80 FR 40218. ICCT found in their workshop that opportunities exist for road load optimization through predictive cruise, GPS, and driver feedback that could lead to a zero to five percent improvement in fuel consumption.<sup>278</sup> Daimler commented that eCoast should also be recognized as an intelligent control within GEM. Eaton offers similar technology, known as Neutral Coast Mode. Neutral coast is an electronic feature that places an

automated transmission in neutral on downhill grades which allows the engine speed to go idle speed. A fuel savings is recognized due to the difference in engine operating conditions due to the reduced load on the engine due to the transmission.

Based on literature information, intelligent controls such as predictive cruise control will reduce CO<sub>2</sub> emissions by two percent, and the agencies are assuming this level of improvement in considering the level of the tractor standard. In addition, the agencies’ review of literature and confidential business information provided based on the SuperTruck demonstration vehicles indicates that neutral coasting will reduce fuel consumption and CO<sub>2</sub> emissions by 1.5 percent.

*Solar Load Management:* The agencies received a letter from the California Air Resources Board prior to the proposal requesting consideration of including technologies that reduce solar heating of the cab (to reduce air conditioning loads) in setting the Phase 2 tractor standards. Solar reflective paints and solar control glazing technologies are discussed in RIA Chapter 2.4.9.3. The agencies requested comment on the Air Resources Board’s letter and recommendations.<sup>279</sup> The agencies received some clarifications from ARB on our evaluation of solar technologies and some CBI from Daimler, but not a sufficient amount of information to evaluate the baseline level of solar control that exists in the heavy-duty market today, determine the effectiveness of each of the solar technologies, or to develop a definition of what qualifies as a solar control technology that could be used in the regulations. Therefore, the agencies would consider solar control to be a technology that manufacturers may consider pursuing through the off-cycle credit program. As such, the agencies did not include solar load management technologies in the technology packages used in setting the final Phase 2 tractor standard stringencies.

(ix) Weight Reduction

Reductions in vehicle mass lower fuel consumption and GHG emissions by decreasing the overall vehicle mass that is moved down the road. Weight reductions also increase vehicle payload capability which can allow additional tons to be carried by fewer trucks consuming less fuel and producing

<sup>278</sup> Delgado, Oscar. N. Lutsey. Advanced Tractor-Trailer Efficiency Technology Potential in the 2020–2030 Timeframe. April 2015. Docket EPA–HQ–OAR–2014–0827.

<sup>279</sup> California Air Resources Board. Letter from Michael Carter to Matthew Spears dated December 3, 2014. Solar Control: Heavy-Duty Vehicles White Paper. Docket EPA–HA–OAR–2014–0827.

<sup>277</sup> See the RIA Chapter 2.4 for details.

lower emissions on a ton-mile basis. We treated such weight reduction in two ways in Phase 1 to account for the fact that combination tractor-trailers weigh-out approximately one-third of the time and cube-out approximately two-thirds of the time. Therefore in Phase 1 and also as finalized for Phase 2, one-third of the weight reduction will be added payload in the denominator while two-thirds of the weight reduction is subtracted from the overall weight of the vehicle in GEM. See 76 FR 57153.

In Phase 1, we reflected mass reductions for specific technology substitutions (e.g., installing aluminum wheels instead of steel wheels). These substitutions were included where we could with confidence verify the mass reduction information provided by the manufacturer. The weight reductions were developed from tire manufacturer information, the Aluminum Association, the Department of Energy, SABIC and TIAH. The agencies proposed to expand the list of weight reduction components which can be input into GEM in order to provide the manufacturers with additional means to comply via GEM with the combination tractor standards and to further encourage reductions in vehicle weight. As in Phase 1, we recognize that there may be additional potential for weight reduction in new high strength steel components which combine the reduction due to the material substitution along with improvements in redesign, as evidenced by the studies done for light-duty vehicles.<sup>280</sup> The agencies however do not agree with all of the recommendations in this report. See Section I.C.1 and RTC Section 1 for a discussion on lifecycle emissions. In the development of the high strength steel component weights, we are only assuming a reduction from material substitution and no weight reduction from redesign, since we do not have any data specific to redesign of heavy-duty components nor do we have a regulatory mechanism to differentiate between material substitution and improved design. Additional weight reduction would be evaluated as a potential off-cycle credit. As described in Section III.E.2 below, the agencies discuss the weight reduction component comments received and are adopting an expanded list of weight reduction options which could be input into the GEM by the manufacturers to reduce their certified

CO<sub>2</sub> emission and fuel consumption levels.

#### (x) Vehicle Speed Limiter

Fuel consumption and GHG emissions increase proportional to the square of vehicle speed. Therefore, lowering vehicle speeds can significantly reduce fuel consumption and GHG emissions. A vehicle speed limiter (VSL), which limits the vehicle's maximum speed, is another technology option for compliance that is already utilized today by some fleets (though the typical maximum speed setting is often higher than 65 mph).

CARB recommended not giving any credit for VSLs because the available data do not fully support whether VSLs result in real-world fuel consumption and GHG reductions. CARB referenced Oakridge National Laboratory's Transportation Energy Data Book, Table 5.11 that shows CO<sub>2</sub> emissions decrease with increased speed. CARB also stated that the draft GEM model appears to offer up to 22 percent credit for use of VSL set to 45 mph, which they consider to be unreasonably high. Before including VSLs as a technology, CARB staff suggests that EPA and NHTSA should thoroughly evaluate whether they would result in real-world CO<sub>2</sub> and fuel consumption benefits.

The agencies conducted in-use tractor testing at different speeds and in turn used this data to validate the GEM simulations of VSL, as discussed in more detail in RIA Chapter 4. The agencies are confident that GEM appropriately recognizes the impact of VSL on CO<sub>2</sub> emissions and fuel consumption. The agencies have limited the range of inputs to the VSL in Phase 2 GEM to a minimum of 55 mph to align with the regulations in 40 CFR 1037.631 that provide exemptions for vocational vehicles intended for off-road use. A 55 mph VSL installed on a typical day cab tractor would reduce the composite grams of CO<sub>2</sub> emitted per ton-mile by seven percent. Similarly, a 55 mph VSL on a sleeper cab would reduce the composite grams of CO<sub>2</sub> per ton-mile emitted by 10 percent. Please see RIA Chapter 2.8 for additional detail of technology impacts.

#### (xi) Hybrid Powertrains

In Phase 2, hybrid powertrains are generally considered a conventional rather than innovative technology, especially for vocational vehicles. However, hybrid powertrain development in Class 7 and 8 tractors has been limited to a few manufacturer demonstration vehicles to date. One of the key benefit opportunities for fuel consumption reduction with hybrids is

less fuel consumption when a vehicle is idling, but the standard is already premised on use of extended idle reduction so use of hybrid technology will duplicate many of the same emission reductions attributable to extended idle reduction. NAS estimated that hybrid systems would cost approximately \$25,000 per tractor in the 2015 through the 2020 time frame and provide a potential fuel consumption reduction of ten percent, of which six percent is idle reduction that can be achieved (less expensively) through the use of other idle reduction technologies.<sup>281</sup> The limited reduction potential outside of idle reduction for Class 8 sleeper cab tractors is due to the mostly highway operation and limited start-stop operation. Due to the high cost and limited benefit during the model years at issue in this action, the agencies did not include hybrids in assessing stringency of the proposed tractor standard.

In addition to the high cost and limited utility of hybrids for many tractor drive cycles noted above, the agencies believe that hybrid powertrains systems for tractors may not be sufficiently developed and the necessary manufacturing capacity put in place to base a standard on any significant volume of hybrid tractors. Unlike hybrids for vocational vehicles and light-duty vehicles, the agencies are not aware of any full hybrid systems currently developed for long haul tractor applications. To date, hybrid systems for tractors have been primarily focused on extended idle shutdown technologies and not on the broader energy storage and recovery systems necessary to achieve reductions over typical tractor drive cycles. The Phase 2 sleeper cab tractor standards instead reflect the potential for extended idle shutdown technologies. Further, as highlighted by the 2010 NAS report, the agencies do believe that full hybrid powertrains may have the potential in the longer term to provide significant improvements in long haul tractor fuel efficiency and to greenhouse gas emission reductions. With respect to day cab tractors, the types of tractors that would receive the benefit from hybrid powertrains would be those such as beverage delivery tractors which could be treated as vocational vehicles through the Special Purpose Tractor provisions (40 CFR 1037.630).

Several stakeholders commented on hybrid powertrain development for tractor applications. Allison agreed with the agencies' overall assessment of hybrids in tractors, as discussed in the

<sup>280</sup> American Iron and Steel Institute. "A Cost Benefit Analysis Report to the North American Steel Industry on Improved Material and Powertrain Architectures for 21st Century Trucks."

<sup>281</sup> See the 2010 NAS Report, Note 229, page 128.

NPRM. Bendix agreed that hybrid systems for tractors have not been focused on. Bendix believed that mild hybrid systems should be included in GEM for credit, including stop-start and electrification of accessories. Daimler commented that in SuperTruck, a tractor that was tested on line haul-type highway routes, the hybrid system provided little benefit beyond what eCoast achieved because it competes with hybrids for energy that might be lost on hills. Overall, Daimler's view was that hybrid systems proved too costly relative to their benefit. Eaton stated that hybrids have not penetrated the commercial trucking landscape, primarily due to the costs but that there may be potential in the future for hybrids in tractor applications driven by improved aerodynamics and lower rolling resistance tires because it would lead to longer coasting times and higher braking loads, therefore greater regeneration opportunities. PACCAR commented that their history with hybrid technology was a niche market application appealing to "green" companies as long as incentives offset the cost of the technology. PACCAR stated that the low sales volumes were not based on performance, but rather on the combination of the payback of the high initial cost based on the limited number of gallons saved in low mileage pick up-and-delivery applications and on the concern over resale value, since at some point in the vehicle's life the battery must be replaced at a significant cost to the owner.

After considering the comments, the agencies are continuing the Phase 1 approach of not including hybrid powertrains in our feasibility analysis for Phase 2. Because the technology for tractor applications is still under development we cannot confidently

assess the effectiveness of this technology at this point in time. In addition, due to the high cost, limited benefit during highway driving, and lacking any existing systems or manufacturing base, we cannot conclude that such technology will be available for tractors in the 2021–2027 timeframe. However, manufacturers will be able to use powertrain testing to capture the performance of a hybrid system in GEM if systems are developed in the Phase 2 timeframe, so this technology remains a potential compliance option (without requiring an off-cycle demonstration).

(xii) Operational Management

The 2010 NAS report noted many operational opportunities to reduce fuel consumption, such as driver training and route optimization. The agencies have included discussion of several of these strategies in RIA Chapter 2, but are not using these approaches or technologies in the Phase 2 standard setting process. The agencies are looking to other resources, such as EPA's SmartWay Transport Partnership and regulations that could potentially be promulgated by the Federal Highway Administration and the Federal Motor Carrier Safety Administration, to continue to encourage the development and utilization of these approaches. In addition, the agencies have also declined to base standard stringencies on technologies which are largely to chiefly driver-dependent, and evaluate such potential improvements through the off-cycle credit mechanism. See, e.g., 77 FR 62838/3 (Oct. 12, 2012).

(xiii) Consideration of Phase 1 Credits in Phase 2 Stringency Setting

The agencies requested comment regarding the treatment of Phase 1

credits, as discussed in Section I.C.1.b. See 80 FR 40251. As examples, the agencies discussed limiting the use of Phase 1 credits in Phase 2 and factoring credit balances into the 2021 standards. Daimler commented that allowing Phase 1 credits in Phase 2 is necessary to smooth the transition into a new program that is very complex and that HD manufacturers cannot change over an entire product portfolio at one time. The agencies evaluated the status of Phase 1 credit balances in 2015 by sector. For tractors, we found that manufacturers are generating significant credits, and that it appears that many of the credits result from their use of an optional provision for calculating aerodynamic drag. However, we also believe that manufacturers will generate fewer credits in MY 2017 and later when the final Phase 1 standards begin. Still, the agencies believe that manufacturers will have significant credit balances available to them for MYs 2021–2023, and that much of these balances would be the result of the test procedure provisions rather than pull ahead of any technology. Based on confidential product plans for MYs 2017 and later, we expect this total windfall amount to be three percent of the MY 2021 standards or more. Therefore, the agencies are factoring in a total credit amount equivalent to this three percent credit (i.e. three years times 1 percent per year). Thus, we are increasing the stringency of the CO<sub>2</sub> and fuel consumption tractor standards for MYs 2021–2023 by 1 percent to reflect these credits.

(xiv) Summary of Technology Performance

Table III–10 describes the performance levels for the range of Class 7 and 8 tractor vehicle technologies.

TABLE III–10—PHASE 2 TECHNOLOGY INPUTS

	Class 7			Class 8					
	Day cab			Day cab			Sleeper cab		
	Low roof	Mid roof	High roof	Low roof	Mid roof	High roof	Low roof	Mid roof	High roof
<b>Engine</b>									
	2021MY 11L Engine 350 HP	2021MY 11L Engine 350 HP	2021MY 11L Engine 350 HP	2021MY 15L Engine 455 HP	2021MY 15L Engine 455 HP	2021MY 15L Engine 455 HP	2021MY 15L Engine 455 HP	2021MY 15L Engine 455 HP	2021MY 15L Engine 455 HP
<b>Aerodynamics (C<sub>d</sub>A in m<sup>2</sup>)</b>									
Bin I .....	6.00	7.00	7.45	6.00	7.00	7.45	6.00	7.00	7.15
Bin II .....	5.60	6.65	6.85	5.60	6.65	6.85	5.60	6.65	6.55
Bin III .....	5.15	6.25	6.25	5.15	6.25	6.25	5.15	6.25	5.95
Bin IV .....	4.75	5.85	5.70	4.75	5.85	5.70	4.75	5.85	5.40
Bin V .....	4.40	5.50	5.20	4.40	5.50	5.20	4.40	5.50	4.90
Bin VI .....	4.10	5.20	4.70	4.10	5.20	4.70	4.10	5.20	4.40
Bin VII .....	3.80	4.90	4.20	3.80	4.90	4.20	3.80	4.90	3.90

TABLE III-10—PHASE 2 TECHNOLOGY INPUTS—Continued

	Class 7			Class 8						
	Day cab			Day cab			Sleeper cab			
	Low roof	Mid roof	High roof	Low roof	Mid roof	High roof	Low roof	Mid roof	High roof	
	2021MY 11L Engine 350 HP	2021MY 11L Engine 350 HP	2021MY 11L Engine 350 HP	2021MY 15L Engine 455 HP	2021MY 15L Engine 455 HP	2021MY 15L Engine 455 HP	2021MY 15L Engine 455 HP	2021MY 15L Engine 455 HP	2021MY 15L Engine 455 HP	
<b>Steer Tires (CRR in kg/metric ton)</b>										
Base .....	7.8	7.8	7.8	7.8	7.8	7.8	7.8	7.8	7.8	
Level 1 .....	6.6	6.6	6.6	6.6	6.6	6.6	6.6	6.6	6.6	
Level 2 .....	5.7	5.7	5.7	5.7	5.7	5.7	5.7	5.7	5.7	
Level 3 .....	4.9	4.9	4.9	4.9	4.9	4.9	4.9	4.9	4.9	
<b>Drive Tires (CRR in kg/metric ton)</b>										
Base .....	8.1	8.1	8.1	8.1	8.1	8.1	8.1	8.1	8.1	
Level 1 .....	6.9	6.9	6.9	6.9	6.9	6.9	6.9	6.9	6.9	
Level 2 .....	6.0	6.0	6.0	6.0	6.0	6.0	6.0	6.0	6.0	
Level 3 .....	5.0	5.0	5.0	5.0	5.0	5.0	5.0	5.0	5.0	
<b>Idle Reduction (% reduction)</b>										
Tamper Proof AESS .....	N/A	N/A	N/A	N/A	N/A	N/A	N/A	4	4	4
Tamper Proof AESS with Diesel APU .....	N/A	N/A	N/A	N/A	N/A	N/A	N/A	4	4	4
Tamper Proof AESS with Bat- tery APU .....	N/A	N/A	N/A	N/A	N/A	N/A	N/A	6	6	6
Tamper Proof AESS with Auto- matic Stop-Start .....	N/A	N/A	N/A	N/A	N/A	N/A	N/A	3	3	3
Tamper Proof AESS with FOH .....	N/A	N/A	N/A	N/A	N/A	N/A	N/A	3	3	3
Adjustable AESS .....	N/A	N/A	N/A	N/A	N/A	N/A	N/A	1	1	1
Adjustable AESS with Diesel APU .....	N/A	N/A	N/A	N/A	N/A	N/A	N/A	3	3	3
Adjustable AESS with Battery APU .....	N/A	N/A	N/A	N/A	N/A	N/A	N/A	5	5	5
Adjustable AESS with Auto- matic Stop-Start .....	N/A	N/A	N/A	N/A	N/A	N/A	N/A	5	5	5
Adjustable AESS with FOH .....	N/A	N/A	N/A	N/A	N/A	N/A	N/A	2	2	2
<b>Transmission (% reduction)</b>										
Manual .....	0	0	0	0	0	0	0	0	0	
AMT .....	2	2	2	2	2	2	2	2	2	
Auto .....	2	2	2	2	2	2	2	2	2	
Dual Clutch .....	2	2	2	2	2	2	2	2	2	
Top Gear Direct Drive .....	2	2	2	2	2	2	2	2	2	
Trans Efficiency .....	1	1	1	1	1	1	1	1	1	
Neutral Idle .....	Modeled in GEM	Modeled in GEM	Modeled in GEM	Modeled in GEM	Modeled in GEM	Modeled in GEM	Modeled in GEM	Modeled in GEM	Modeled in GEM	
<b>Driveline (% reduction)</b>										
Axle Efficiency .....	2	2	2	2	2	2	2	2	2	
6x2, 6x4 Axle Disconnect or 4x2 Axle .....	N/A	N/A	N/A	Modeled in GEM	Modeled in GEM	Modeled in GEM	Modeled in GEM	Modeled in GEM	Modeled in GEM	
Downspeed .....	Modeled in GEM	Modeled in GEM	Modeled in GEM	Modeled in GEM	Modeled in GEM	Modeled in GEM	Modeled in GEM	Modeled in GEM	Modeled in GEM	
<b>Accessory Improvements (% reduction)</b>										
A/C Efficiency .....	0.5	0.5	0.5	0.5	0.5	0.5	0.5	0.5	0.5	
Electric Access .....	1	1	1	1	1	1	1	1	1	
<b>Other Technologies (% reduction)</b>										
Predictive Cruise Control .....	2	2	2	2	2	2	2	2	2	
Automated Tire Inflation System Tire Pressure Monitoring Sys- tem .....	1.2	1.2	1.2	1.2	1.2	1.2	1.2	1.2	1.2	
Neutral Coast .....	1.5	1.5	1.5	1.5	1.5	1.5	1.5	1.5	1.5	

**Note:**  
 "Modeled in GEM" means that a manufacturer will input information into GEM, such as "Yes or No" for neutral idle, and GEM will simulate that condition. The values listed in the table above as percentages reflect a post-processing done within GEM after the simulation runs the drive cycles.



## (c) Tractor Technology Adoption Rates

As explained above, tractor manufacturers often introduce major product changes together, as a package. In this manner the manufacturers can optimize their available resources, including engineering, development, manufacturing and marketing activities to create a product with multiple new features. Since Phase 1 began, this approach also has allowed manufacturers to consolidate testing and certification requirements. In addition, manufacturers recognize that a truck design will need to remain competitive over the intended life of the design and meet future regulatory requirements. In some limited cases, manufacturers may implement an individual technology outside of a vehicle's redesign cycle.

With respect to the levels of technology adoption used to develop the HD Phase 2 standards, NHTSA and EPA established technology adoption constraints. The first type of constraint was established based on the application of fuel consumption and CO<sub>2</sub> emission reduction technologies into the different types of tractors. For example, extended idle reduction technologies are limited to Class 8 sleeper cabs using the reasonable assumption that day cabs are not used for overnight hoteling. Day cabs typically idle for shorter durations throughout the day.

A second type of constraint was applied to most other technologies and limited their adoption based on factors reflecting the real world operating conditions that some combination tractors encounter (so that the standards are not based on use of technologies which do not provide in-use benefit). This second type of constraint was applied to the aerodynamic, tire, powertrain, vehicle speed limiter technologies, and other technologies. NHTSA and EPA believe that within each of these individual vehicle categories there are particular applications where the use of the identified technologies will be either ineffective or not technically feasible. For example, the agencies are not predicating these standards on the use of full aerodynamic vehicle treatments on 100 percent of tractors because we know that in some applications (for example, gravel trucks engaged in local delivery) the added weight of the aerodynamic technologies will increase fuel consumption and hence CO<sub>2</sub> emissions to a greater degree than the reduction that will be accomplished from the more aerodynamic nature of the tractor. General considerations of needed lead time also play a significant

role in the agencies' determination of technology adoption rates.

In the development of the standards, we generally focused initially on what technology could be adopted in 2027 MY after ten years of lead time, consistent with the general principles discussed above. Based on our detailed discussions with manufacturers and technology suppliers, we can project that the vast majority of technologies will be fully developed and in widespread use by 2027 MY. (One notable exception to this is Rankine cycle waste heat recovery, which we project to be less widespread in 2027). Having identified what could be achieved in 2027 MY, we projected technology steps for 2021 MY and 2024 MY to reflect the gradual development and deployment of these technologies.

This is also consistent with how manufacturers will likely approach complying with these standards. In general, we would expect a manufacturer to first identify technology packages that would allow them to meet the 2027 MY standards, then to structure a development plan to make steady progress toward the 2027 MY standards. To some extent, it was easier to project the technology for 2027 MY, because it represents a maximum feasible adoption of most technologies. The agencies' projections for MYs 2021 and 2024 are less certain because they reflect choices manufacturers would likely make to reach the 2027 levels. As such, we have more confidence that the levels of our MYs 2021 and 2024 standards are appropriate than we do that each manufacturer will follow our specific technology development path in 2021 MY or 2024 MY.

Table III-13, Table III-14, and Table III-15 specify the adoption rates that EPA and NHTSA used to develop these standards.

## (i) Aerodynamics Adoption Rate

The impact of aerodynamics on a tractor-trailer's efficiency increases with vehicle speed. Therefore, the usage pattern of the vehicle will determine the benefit of various aerodynamic technologies. Sleeper cabs are often used in line haul applications and drive the majority of their miles on the highway travelling at speeds greater than 55 mph. The industry has focused aerodynamic technology development, including SmartWay tractors, on these types of trucks. Therefore the agencies proposed standards that reflect the most aggressive aerodynamic technology application rates to this regulatory subcategory, along with the high roof day cabs. 80 FR 40227. All of the major manufacturers today offer at least one

SmartWay sleeper cab tractor model, which is represented as Bin III aerodynamic performance. The agencies requested comment on the proposed aerodynamic assessment.

The agencies received significant comment from the manufacturers regarding our assessment of aerodynamics in the most aerodynamic bins for high roof sleeper cabs. EMA commented that the assumptions that Class 7 and Class 8 high-roof vehicles will achieve a 35 percent penetration rate into Bin V, a 20 percent penetration rate into Bin VI, and a 5 percent penetration rate into Bin VII by 2027 are over-stated and unreasonable. Volvo and EMA commented that it is impossible to achieve the targeted aerodynamic drag reductions that ultimately are predicated on 60 percent of tractors achieving aero bins V, VI, and VII. According to their analysis, the manufacturers stated that it is not possible to achieve these low drag levels with any tractor design coupled to the non-aerodynamic test trailer prescribed in this proposal. Caterpillar commented that given the proposed aerodynamic testing procedures, the Phase 2 test trailer, and the lack of any audit margin for these highly variable test processes, it is infeasible to design tractors that can achieve bin V, and so would not be able to achieve bins VI and VII. Caterpillar also stated that none of the vehicles developed within the Department of Energy's SuperTruck program are capable of meeting the proposed aerodynamic targets.

In Phase 1, the agencies determined the stringency of the tractor standards through the use of a mix of aerodynamic bins in the technology packages. For example, we included 10 percent Bin II, 70 percent Bin III, and 20 percent Bin IV in the high roof sleeper cab tractor standard. The weighted average aerodynamic performance of this technology package is equivalent to Bin III. 76 FR 57211. In consideration of the comments, the agencies have adjusted the aerodynamic adoption rate for Class 8 high roof sleeper cabs used to set the final standards in 2021, 2024, and 2027 MYs (*i.e.*, the degree of technology adoption on which the stringency of the standard is premised). Upon further analysis of simulation modeling of a SuperTruck tractor with a Phase 2 reference trailer with skirts, we agree with the manufacturers that a SuperTruck tractor technology package would only achieve the Bin V level of C<sub>d</sub>A, as discussed above and in RIA Chapter 2.8.2.2. Consequently, as noted above, the final standards are not premised on any adoption of Bin VI and VII technologies. Accordingly, we

determined the adoption rates in the technology packages developed for the final rule using a similar approach as Phase 1—spanning three aerodynamic bins and not setting adoption rates in the most aerodynamic bin(s)—to reflect that there are some vehicles whose operation limits the applicability of some aerodynamic technologies. We set the MY 2027 high roof sleeper cab tractor standards using a technology package that included 20 percent of Bin III, 30 percent Bin IV, and 50 percent Bin V reflecting our assessment of the fraction of high roof sleeper cab tractors that we project could successfully apply these aerodynamic packages with this amount of lead time. The weighted average of this set of adoption rates is equivalent to a tractor aerodynamic performance near the border between Bin IV and Bin V. We believe that there is sufficient lead time to develop aerodynamic tractors that can move the entire high roof sleeper cab aerodynamic performance to be as good as or better than today's SmartWay designated tractors.

The agencies phased-in the aerodynamic technology adoption rates within the technology packages used to determine the MY 2021 and 2024 standards so that manufacturers can gradually introduce these technologies. The changes required for Bin V performance reflect the kinds of improvements projected in the Department of Energy's SuperTruck program. That program has demonstrated tractor-trailers in 2015 with significant aerodynamic technologies. For the final rule, the agencies are projecting that truck manufacturers will be able to begin implementing some of these aerodynamic technologies on high roof tractors as early as 2021 MY on a limited scale. For example, in the 2021 MY technology package, the agencies have assumed that 10 percent of high roof sleeper cabs will have aerodynamics better than today's best tractors. This phase-in structure is consistent with the normal manner in which manufacturers introduce new technology to manage limited research and development budgets as well as to allow them to work with fleets to fully evaluate in-use reliability before a technology is applied fleet-wide. The agencies believe the phase-in schedule will allow manufacturers to complete these normal processes. Overall, while the agencies are now projecting slightly less benefit from aerodynamic improvements than we did in the NPRM, the actual aerodynamic technologies being projected are very

similar to what was projected at the time of NPRM (however, these vehicles fall into Bin V in the final rule, instead of Bin VI and VII in the NPRM). Importantly, our averaging, banking and trading provisions provide manufacturers with the flexibility (and incentive) to implement these technologies over time even though the standard changes in a single step.

The agencies also received comment regarding our aerodynamic assessment of the other tractor subcategories. Daimler commented that due to their shorter length, day cabs are more difficult to make aerodynamic than sleeper cabs, and that the bin boundaries and adoption rates should reflect this. EMA commented that the assumed aerodynamic performance improvements to be achieved by day cab and mid and low-roof vehicles are over-estimated by at least one bin. Daimler commented that the agencies should adjust the average bin down in recognition of the fact that mid/low-roof vehicles should have lower penetration rates of aerodynamic vehicles to reflect market needs, reflecting these vehicles' use in rough environments or in hauling non-aerodynamic trailers.

Aerodynamic improvements through new tractor designs and the development of new aerodynamic components is an inherently slow and iterative process. The agencies recognize that there are tractor applications that require on/off-road capability and other truck functions which restrict the type of aerodynamic equipment applicable. We also recognize that these types of trucks spend less time at highway speeds where aerodynamic technologies have the greatest benefit. The 2002 VIUS data ranks trucks by major use.<sup>282</sup> The heavy trucks usage indicates that up to 35 percent of the trucks may be used in on/off-road applications or heavier applications. The uses include construction (16 percent), agriculture (12 percent), waste management (5 percent), and mining (2 percent). Therefore, the agencies analyzed the technologies to evaluate the potential restrictions that will prevent 100 percent adoption of more advanced aerodynamic technologies for all of the tractor regulatory subcategories and developed standards with new penetration rates reflecting that these vehicles spend less time at highway speeds. For the final rule, the agencies evaluated the certification data to assess how the aerodynamic performance of high roof day cabs compare to high roof sleeper cabs. In 2014, the high roof day

cabs on average are certified to one bin lower than the high roof sleeper cabs.<sup>283</sup> Consistent with the public comments, and the certification data, the aerodynamic adoption rates used to develop the final Phase 2 standards for the high roof day cab regulatory subcategories are less aggressive than for the Class 8 sleeper cab high roof tractors. In addition, the agencies are also accordingly reducing the adoption rates in the highest bins for low and mid roof tractors to follow the changes made to the high roof subcategories because we neither proposed nor expect the aerodynamics of a low or mid roof tractor to be better than a high roof tractor.

#### (ii) Low Rolling Resistance Tire Adoption Rate

For the tire manufacturers to further reduce tire rolling resistance, the manufacturers must consider several performance criteria that affect tire selection. The characteristics of a tire also influence durability, traction control, vehicle handling, comfort, and retreadability. A single performance parameter can easily be enhanced, but an optimal balance of all the criteria will require improvements in materials and tread design at a higher cost, as estimated by the agencies. Tire design requires balancing performance, since changes in design may change different performance characteristics in opposing directions. Similar to the discussion regarding lesser aerodynamic technology application in tractor segments other than sleeper cab high roof, the agencies believe that the proposed standards should not be premised on 100 percent application of Level 3 tires in all tractor segments given the potential interference with vehicle utility that could result. 80 FR 40223.

Several stakeholders commented about the level of rolling resistance used in setting the proposed level of tractor stringencies because the agencies used a single level for all tractor subcategories. ATA, First Industries, National Association of Manufacturers, PACCAR, Navistar and Daimler commented that the agencies erred by using the same rolling resistance for all types of day and sleeper cab tractors. They stated that the tire stringency levels should account for fleet and class variations and different duty-cycle needs. Caterpillar stated that tires need to meet demands of all conditions, including

<sup>282</sup> U.S. Department of Energy. *Transportation Energy Data Book*, Edition 28–2009. Table 5.7.

<sup>283</sup> U.S. EPA. Memo to Docket. Coefficient of Rolling Resistance and Coefficient of Drag Certification Data for Tractors. See Docket EPA–HQ–OAR–2014–0827.

unpaved roads, sloped loading docks which are frequently not treated in winter conditions. Caterpillar also stated that tire casings must have adequate durability to allow for as many as five retreads. NADA commented current LRR tractor adoption rates are low and are not expected to increase significantly any time soon unless significant improvements in design are forthcoming and that there is no realistic means of ensuring that customers (or subsequent owners) will continue to use LRR tires. OOIDA commented that the LRR tire may be beneficial on flat terrain, but may pose a safety concern in many geographical regions. OOIDA also stated that a LRR tire achieves much of its potential fuel savings benefit by reducing the very component of friction or resistance that a truck driver may rely upon. PACCAR commented that customers with low- and mid-roof configurations typically operate more in urban areas where tires must withstand the abuse of curbs and other obstacles or in more on/off road conditions that are typical for flatbed, tanker, and low-boy operations, which use the low and mid-roof configuration vehicles. PACCAR stated that the tires for low and mid roof tractors vehicles are designed with additional side wall protection and generally have a higher coefficient of rolling resistance. Volvo commented with respect to tractor penetration and stringency setting the agencies show penetration of Level 3 tires starting in MY 2021. Volvo stated that they continue to hear customer feedback that low rolling resistance tires often lack adequate traction under many of the demanding conditions that trucks and tractors experience, such as snow and off-road. Schneider commented that fleet uses low rolling resistance tires on dual wheels for the majority of the standard fleet while using wide-based single tires for weight sensitive portions of the fleet. Schneider commented that regulations should not force the use of wide based single tires based solely on rolling resistance advantages without considering the overall performance because it may increase waste, the number of scrapped tire casings and landfill requirements. The commenter's view is that LRR dual tires are very comparable to wide based single tires (WBS) tires in fuel efficiency while providing better overall operating and economic efficiency.

For the final rulemaking, the agencies evaluated the tire rolling resistance levels in the Phase 1 certification

data.<sup>284</sup> We found that high roof sleeper cabs are certified today with steer tire rolling resistance levels that ranged between 4.9 and 7.6 kg/ton and with drive tires ranging between 5.1 and 9.8 kg/ton. In the same analysis, we found that high roof day cabs are certified with rolling resistance levels ranging between 4.9 and 9.0 kg/ton for steer tires and between 5.1 and 9.8 kg/ton for drive tires. This range spans the baseline through Level 3 rolling resistance performance levels. Therefore, for the final rule we took an approach similar to the one taken in Phase 1 and proposed in Phase 2 that considers adoption rates across a wide range of tire rolling resistance levels to recognize that operators may have different needs. 76 FR 57211 and 80 FR 40227. The adoption rates for the technology packages used to determine the MY 2027 standards for each high roof tractor subcategory are shown in Table III–15.

In our analysis of the Phase 1 certification data, we found that the drive tires on low and mid roof sleeper cab tractors on average had 10 to 17 percent higher rolling resistance than the high roof sleeper cabs. But we found only a minor difference in rolling resistance of the steer tires between the tractor subcategories. Based on comments received and further consideration of our own analysis of the difference in tire rolling resistance levels that exist today in the certification data, the agencies are adopting Phase 2 standards using a technology pathway that utilizes higher rolling resistance levels for low and mid roof tractors than the levels used to set the high roof tractor standards. This is also consistent with the approach that we took in setting the Phase 1 tractor standards. 76 FR 57211. In addition, the final rule reflects a reduction in Level 3 adoption rates for low and mid roof tractors from 25 percent in MY 2027 used at proposal (80 FR 40227) to zero percent adoption rate. The technology packages developed for the low and mid roof tractors used to determine the stringency of the MY 2027 standards in the final rule do not include any adoption rate of Level 3 drive tires to recognize the special needs of these applications, consistent with the comments noted above raising concerns about applications that limit the use of low rolling resistance tires.

The agencies phased-in the low rolling resistance tire adoption rates within the technology packages used to determine the MY 2021 and 2024

standards so that manufacturers can gradually introduce these technologies. In addition, the levels of rolling resistance used in all of the technology packages are achievable with either dual or wide based single tires, so the agencies are not forcing one technology over another. The adoption rates for the technology packages used to determine the MY 2021, 2024, and 2027 standards for each tractor subcategory are shown in Table III–13, Table III–14, and Table III–15.

#### (iii) Tire Pressure Monitoring and Automatic Tire Inflation System (ATIS) Adoption Rate

The agencies used a 20 percent adoption rate of ATIS in MY 2021 and a 40 percent adoption rate in setting the proposed Phase 2 MY 2024 and 2027 tractor standards. 80 FR 40227.

ATA commented that as of 2012, roughly one percent of tractors used ATIS. Caterpillar and First Industries stated that the agencies should not force ATIS into the market by assuming any penetration rate. EMA commented that the assumption that 40 percent of all Class 7 and 8 vehicles will utilize automated tire inflation systems lacked support and failed to account for the prevalence of tire inflation monitoring systems. NADA stated that they can support a 40 percent tractor adoption rate for MY 2027 if TPMS are considered. Volvo commented that given the poor reliability of past ATIS systems, they are skeptical of supplier's claims of current or future reliability improvements to these systems. Volvo stated that fleets are even more skeptical than truck OEMs, as an ATIS air leak results in increased fuel consumption due to a compressor cycling more frequently and also in potentially significant downtime of the vehicle. Volvo also commented that to incentivize truck operators to maintain tire pressure on vehicles equipped with a TPMS system, fleets have the ability to monitor fuel consumption remotely, including the ability to identify causes for increased fuel consumption which would be expected to motivate drivers to properly maintain tire pressure on TPMS equipped vehicles.

The agencies find the comments related to a greater acceptance of TPMS in the tractor market to be persuasive. However, available information indicates that it is feasible to utilize either TPMS or ATIS to reduce the prevalence on underinflated tires in-use on all tractors. As a result, we are finalizing tractor standards that are predicated on the performance of a mix of TPMS and ATIS adoption rates in all tractor subcategories. The agencies are

<sup>284</sup> Memo to Docket. Coefficient of Rolling Resistance and Coefficient of Drag Certification Data for Tractors. Docket EPA-HQ-OAR-2014-0827.

using adoption rates of 30 percent of ATIS and 70 percent of TPMS in the technology packages used in setting the final Phase 2 MY 2027 tractor standards. This represents a lower adoption rate of ATIS than used in the NPRM, but the agencies have added additional adoption rate of TPMS because none of the comments or available information disputed the ability to use it on all tractors. The agencies have developed technology packages for setting the 2021 and 2024 MY standards which reflect a phase in of adoption rates of each of these technologies. In 2021 MY, the adoption rates consist of 20 percent TPMS and 20 percent ATIS. In 2024 MY, the adoption rates are 50 percent TPMS and 25 percent ATIS.

#### (iv) Idle Reduction Technology Adoption Rate

Idle reduction technologies provide significant reductions in fuel consumption and CO<sub>2</sub> emissions for Class 8 sleeper cabs and are available on the market today. There are several different technologies available to reduce idling. These include APUs, diesel fired heaters, and battery powered units. Our discussions with manufacturers prior to the Phase 2 NPRM indicated that idle technologies are sometimes installed in the factory, but that it is also a common practice to have the units installed after the sale of the truck. We want to continue to incentivize this practice and to do so in a manner that the emission reductions associated with idle reduction technology occur in use. We proposed to continue the Phase 1 approach into Phase 2 where we recognize only idle emission reduction technologies that include a tamper-proof automatic engine shutoff system (AESS) with some override provisions.<sup>285</sup> However, we welcomed comment on other approaches that will appropriately quantify the reductions that will be experienced in the real world. 80 FR 40224.

We used an overall 90 percent adoption rate of tamper-proof AESS for Class 8 sleeper cabs in setting the proposed MY 2024 and 2027 standards. Id. The agencies stated in the Phase 2 NPRM that we were unaware of reasons why AESS with extended idle reduction technologies could not be applied to this high fraction of tractors with a sleeper cab, except those deemed a vocational tractor, in the available lead time.

<sup>285</sup> The agencies are retaining the HD Phase 1 AESS override provisions included in 40 CFR 1037.660(b) for driver safety.

EMA, Volvo, Daimler, and Navistar commented that the agencies should consider that customers are not accepting the tamper-proof AESS in Phase 1, therefore the adoption rates included in the proposal were too high and that resale concerns remain a significant issue for customers. PACCAR and EMA commented that the proposed 90 percent penetration rate of tamper-proof AESS is unachievable. Many comments also focused on the need for adjustable AESS. OOIDA commented that 90 percent APU adoption is unreasonable and that the 400 pound weight exemption for APUs is not provided in California, Washington DC, Hawaii, Kentucky, Massachusetts, North Carolina, and Rhode Island. OOIDA also raised concerns about situations where an AESS could have negative consequences—such as team drivers where the co-driver was left asleep in the berth while the truck was shut off, or drivers with certain medical conditions, or pets.

The agencies find the comments regarding the concerns for using 90 percent adoption rates of tamper-proof AESS to be persuasive. For the final rule, the agencies developed a menu of idle reduction technologies that include both tamper-proof and adjustable AESS (as discussed in Section III.D.1.b) that are recognized at different levels of effectiveness in GEM. As discussed in the discussion of tractor baselines (Section III.D.1.a), the latest NACFE confidence report found that 96 percent of HD vehicles are equipped with adjustable automatic engine shutdown systems.<sup>286</sup> Therefore, the agencies built this level of idle reduction into the baseline for sleeper cab tractors. Due to the high percentage acceptance of adjustable AESS today, the agencies project that by 2027 MY it is feasible for 100 percent of sleeper cabs to contain some type of AESS and idle reduction technology to meet the hoteling needs of the driver. However, we recognize that there are a variety of idle reduction technologies that meet the various needs of specific customers and not all customers will select diesel powered APUs due to the cost or weight concerns highlighted in the comments. Therefore, we developed an idle reduction technology package for each MY that reflects this variety. The idle reduction packages developed for the final rule contain lower AESS adoption rates than used at proposal. The AESS used during the NPRM assumed that it also included a diesel powered APU in terms of

<sup>286</sup> North American Council for Freight Efficiency. Confidence Report: Idle-Reduction Solutions. 2014. Page 13.

determining the effectiveness and costs. In the final rule, the idle reduction technology mix actually has an overall lower cost (even after increasing the diesel APU technology cost estimate for the final rule) than would have been developed for the final rule. In addition, the stringency of the tractor standards are not affected because the higher penetration rate of other idle reduction technologies, which are not quite as effective, but will be deployed more. We developed the technology package to set the 2027 MY sleeper cab tractor standards that includes 15 percent adoption rate of adjustable AESS only, 40 percent of adjustable AESS with a diesel powered APU, 15 percent adjustable AESS with a battery APU, 15 percent adjustable AESS with automatic stop/start, and 15 percent adjustable AESS with a fuel operated heater. We continued the same approach of phasing in different technology packages for the 2021 and 2024 MY standards, though we included some type of idle reduction on 100 percent of the sleeper cab tractors. The 2021 MY technology package had a higher adoption rate of adjustable AESS with no other idle reduction technology and lower adoption rates of adjustable AESS with other idle reduction technologies. Details on the idle reduction technology adoption rates for the MY 2021 and 2024 standards are included in Table III-13 and Table III-14.

#### (v) Transmission Adoption Rates

The agencies' proposed standards included a 55, 80, and 90 percent adoption rate of automatic, automated manual, and dual clutch transmissions in MYs 2021, 2024, and 2027 respectively. 80 FR 40225-7. The agencies did not receive any comments regarding these proposed transmission adoption rates, and have not found any other information suggesting a change in approach. Therefore, we are including the same level of adoption rates in setting the final rule standards. The MY 2021 and 2024 standards are likewise premised on the same adoption rates of these transmission technologies as at proposal.

The agencies have added neutral idle as a technology input to GEM for Phase 2 in the final rulemaking. The TC10 that was tested by the agencies for the final rule included this technology. Therefore, we projected that neutral idle would be included in all of the automatic transmissions and therefore the adoption rates of neutral idle match the adoption rates of the automatic transmission in each of the MYs.

Transmissions with direct drive as the top gear and numerically lower axles are

better suited for applications with primarily highway driving with flat or low rolling hills. Therefore, this technology is not appropriate for use in 100 percent of tractors. The agencies proposed standards reflected the projection that 50 percent of the tractors would have direct drive in top gear in MYs 2024 and 2027. 80 FR 40226–7. The agencies did not receive any comments regarding the adoption rates of transmissions with direct drive in those MYs. We therefore are including the same level of adoption rates in setting the final rule standards for MYs 2024 and 2027. Transmissions with direct drive top gears exist in the market today, therefore, the agencies determined it is feasible to also include this technology in the package for setting the 2021 MY standards. For the final rule, the agencies included a 20 percent adoption rate of direct drive in the 2021 MY technology package.

The agencies received comments supporting establishing a transmission

efficiency test that measures the efficiency of each transmission gear and could be input into GEM. In the final rule, the agencies are adopting Phase 2 standards that project that 20, 40, and 70 percent of the AMT and DCT transmissions will be tested and achieve a fuel consumption and CO<sub>2</sub> emissions reduction of one percent in MYs 2021, 2024, and 2027, respectively.

The adoption rates for the technology packages used to determine the MY 2021, 2024, and 2027 standards for each tractor subcategory are shown in Table III–13, Table III–14, and Table III–15.

(vi) Engine Downsizing Adoption Rates

The agencies proposed to include lower final drive ratios in setting the Phase 2 standards to account for engine downsizing. In the NPRM, we used a transmission top gear ratio of 0.73 and baseline drive axle ratio of 3.70 in 2017 going down to a rear axle ratio of 3.55

in 2021 MY, 3.36 in 2024 MY, and 3.20 in 2027 MY. 80 FR 40228–30.

UCS commented that downsizing was only partially captured as proposed. The agencies also received additional information from vehicle manufacturers and axle manufacturers that we believe supports using lower numerical drive axle ratios in setting the final Phase 2 standards for sleeper cabs that spend more time on the highway than day cabs, directionally consistent with the UCS comment. For the final rules, the agencies have used 3.70 in the baseline and 3.16 for sleeper cabs and 3.21 for day cabs in MY 2027 to account for continued downsizing opportunities. The final drive ratios used for setting the other model years are shown in Table III–11. These values represent the “average” tractor in each of the MYs, but there will be a range of final drive ratios that contain more aggressive engine downsizing on some tractors and less aggressive on others.

TABLE III–11—FINAL DRIVE RATIO FOR TRACTOR TECHNOLOGY PACKAGES

Model year	Rear axle ratio	Transmission top gear ratio	Final drive ratio
<b>Sleeper Cabs</b>			
2018 .....	3.70	0.73	2.70
2021 .....	3.31	0.73	2.42
2024 .....	3.26	0.73	2.38
2027 .....	3.16	0.73	2.31
<b>Day Cabs</b>			
2018 .....	3.70	0.73	2.70
2021 .....	3.36	0.73	2.45
2024 .....	3.31	0.73	2.42
2027 .....	3.21	0.73	2.34

(vii) Drivetrain Adoption Rates

The agencies’ proposed standards included 6x2 axle adoption rates in high roof tractors of 20 percent in 2021 MY and 60 percent in MYs 2024 and 2027. Because 6x2 axle configurations could raise concerns of traction, the agencies proposed standards that reflected lower adoption rates of 6x2 axles in low and mid roof tractors recognizing that these tractors may require some unique capabilities. The agencies proposed standards for low and mid roof tractors that included 6x2 axle adoption rates of 10 percent in MY 2021 and 20 percent in MYs 2024 and 2027. 80 FR 40225–7.

ATA and others commented that limitations to a high penetration rate of 6x2 axles include curb cuts, other uneven terrain features that could expose the truck to traction issues,

lower residual values, traction issues, driver dissatisfaction, tire wear, and the legality of their use. The commenters stated that recent surveys indicate current market penetration rates of new line-haul 6x2 tractor sales are only in the range of two percent, according to a NACFE confidence report. The commenters also stated that while recent improvements in traction control systems can automatically shift weight for short periods of time from the non-driving axle to the driving axle during low-traction events, concerns remain over the impacts to highways caused by such shifting of weight between axles. EMA, ATA, OOIDA, Volvo, Daimler, PACCAR, First Industries, National Association of Manufacturers, Caterpillar, and others discussed that 6x2 axles are not legal in all U.S. states and Canadian provinces. Caterpillar and

Daimler also stated the agencies should not assume more than 5 percent penetration rates of 6x2 through 2027. EMA forecasts a 6x2 penetration rate of less than 5 percent.

Upon further consideration, the agencies have reduced the adoption rate of 6x2 axles and projected a 30 percent adoption rate in the technology package used to determine the Phase 2 2027 MY standards. The 2021 MY standards include an adoption rate of 15 percent and the 2024 MY standards include an adoption rate of 25 percent 6x2 axles. This adoption rate represents a combination of liftable 6x2 axles (which as noted in ATA’s comments are allowed in all states but Utah, and Utah is expected to revise their law) and 4x2 axles. In addition, it is worth recognizing that state regulations related to 6x2 axles could change significantly

over the next ten years. It is also worth noting that the issue related to the legality of 6x2 axles was not mentioned as a barrier to adoption by fleets in the NACFE Confidence Report on 6x2 axles.<sup>287</sup>

In the NPRM, the agencies projected that 20 percent of 2021 MY and 40 percent of the 2024 and 2027 MY axles would use low friction axle lubricants. 80 FR 40225–7. In the final rule, we are requiring that manufacturers conduct an axle efficiency test if they want to include the benefit of low friction lubricant or other axle design improvements when certifying in GEM.

The axle efficiency test will be optional, but will allow manufacturers to reduce CO<sub>2</sub> emissions and fuel consumption if the manufacturers have improved axle gear designs and/or mandatory use of low friction lubricants. The agencies' assessment of axle improvements found that 80 percent of the axles built in MY 2027 could be two percent more efficient than a 2017 baseline axle. Because it will take time for axle manufacturers to make improvements across the majority of their product offerings, the agencies phased in the amount of axle efficiency improvements in the technology packages in setting the

2021 and 2024 MY standards to include 30 and 65 percent adoption rates, respectively.

(viii) Accessories and Other Technology Adoption Rates

In the NPRM, the agencies projected adoption rates as show in Table III–12. 80 FR 40227. The agencies are adopting the same level of adoption rates for setting the final Phase 2 standards because we did not receive any comments or new data to support a change in the adoption rates used in the proposal.

TABLE III–12—ADOPTION RATES USED IN THE TRACTOR TECHNOLOGY PACKAGES IN THE NPRM

Model year	Predictive cruise control (%)	Electrified accessories (%)	Higher efficiency air conditioning (%)
2021 .....	20	10	10
2024 .....	40	20	20
2027 .....	40	30	30

(ix) Weight Reduction Technology Adoption Rates

In the NPRM, the agencies proposed to allow manufacturers to use tractor weight reduction to comply with the standards. 80 FR 40223. A number of organizations commented generally in favor of the inclusion of light weight components for compliance, including the Aluminum Association, Meritor, American Die Casting Association, and the American Chemistry Council saying light-weight materials are durable and their use in heavy-duty vehicles can reduce weight and fuel consumption.

Unlike in HD Phase 1, the agencies proposed the 2021 through 2027 model year tractor standards without using weight reduction as a technology to demonstrate the feasibility of the standards. The ICCT stated that the agencies should include light weight components in setting the stringency of the standards, citing an ICCT tractor and trailer study showing specific light weight benefits for tractor components. Meritor argued that weight reduction should not be included in setting stringency, given the high cost to benefit ratio for weight reduction.

The agencies view weight reduction as a technology with a high cost that offers a small benefit in the tractor sector. For example, our estimate of a 400 pound weight reduction will cost \$2,050 (2012\$) in 2021 MY, but offers a 0.3 percent reduction in fuel

consumption and CO<sub>2</sub> emissions. The agencies are excluding the use of weight reduction components for the tractor stringency calculation due to the high cost associated with this technology. As noted above, Meritor in their comments expressed agreement with this approach.

(x) Vehicle Speed Limiter Adoption Rate

Consistent with Phase 1, we proposed to continue the approach where vehicle speed limiters may be used as a technology to meet the Phase 2 standard. See 80 FR 40224. In setting the Phase 2 proposed standard, however, we assumed a zero percent adoption rate of vehicle speed limiters. Although we expect there will be some use of VSL, currently it is used when the fleet involved decides it is feasible and practicable and increases the overall efficiency of the freight system for that fleet operator. To date, the compliance data provided by manufacturers indicate that none of the tractor configurations include a tamper-proof VSL setting less than 65 mph.

At this point the agencies are not in a position to determine in how many additional situations use of a VSL will result in similar benefits to overall efficiency or how many customers will be willing to accept a tamper-proof VSL setting. Although we believe vehicle speed limiters are a simple, easy to

implement, and inexpensive technology, we want to leave the use of vehicle speed limiters to the truck purchaser. In doing so, we are providing another means of meeting the standard that can lower compliance costs and provide a more optimal vehicle solution for some truck fleets or owners. For example, a local beverage distributor may operate trucks in a distribution network of primarily local roads. Under those conditions, aerodynamic fairings used to reduce aerodynamic drag provide little benefit due to the low vehicle speed while adding additional mass to the vehicle. A vehicle manufacturer could choose to install a VSL set at an optimized speed for its intended application and use this technology to assist in complying with our program all at a lower cost to the ultimate tractor purchaser.<sup>288</sup>

We welcomed comment on whether the use of a VSL would require a fleet to deploy additional tractors, but did not receive responsive comment. ARB stated that if EPA and NHTSA decide to give credit in Phase 2 GEMs for VSLs, VSL benefit should also be reflected in the standard's stringency. Daimler supported the approach of not including VSLs in setting the stringency because of the resistance in the market to accept tamperproof VSLs. OOIDA commented that the agencies must consider the significant negative consequences of VSLs, such as safety impact from

<sup>287</sup> North American Council for Freight Efficiency. "Confidence Findings on the Potential of 6x2 Axles." 2014. Page 16.

<sup>288</sup> Ibid.

<sup>288</sup> The agencies note that because a VSL value can be input into GEM, its benefits can be directly

assessed with the model and off cycle credit applications therefore are not necessary even though the standard is not based on performance of VSLs (*i.e.* VSL is an on-cycle technology).

differential speeds between light duty vehicles and trucks.

After considering the comments, we still could not make a determination regarding the reasonableness of setting a standard based on a particular VSL adoption rate, for the same reasons articulated at proposal. Therefore, the

agencies are not premising these final Phase 2 standards on use of VSL, and instead will continue to rely on the industry to select VSL when circumstances are appropriate for its use (in which case there is an input in GEM reflecting VSL efficiency).

(d) Summary of the Adoption Rates Used To Determine the Final Phase 2 Tractor Standards

Table III–13 through Table III–16 provide the adoption rates of each technology broken down by weight class, cab configuration, and roof height.

TABLE III–13—TECHNOLOGY ADOPTION RATES FOR CLASS 7 AND 8 TRACTORS FOR DETERMINING THE 2021 MY STANDARDS

	Class 7			Class 8						
	Day cab			Day cab			Sleeper cab			
	Low roof	Mid roof	High roof	Low roof	Mid roof	High roof	Low roof	Mid roof	High roof	
<b>Engine</b>										
	2021 MY 11L engine 350 HP	2021 MY 11L engine 350 HP	2021 MY 11L engine 350 HP	2021 MY 15L engine 455 HP	2021 MY 15L engine 455 HP	2021 MY 15L engine 455 HP	2021 MY 15L engine 455 HP	2021 MY 15L engine 455 HP	2021 MY 15L engine 455 HP	2021 MY 15L engine 455 HP
<b>Aerodynamics</b>										
Bin I .....	10%	10%	0%	10%	10%	0%	0%	10%	0%	
Bin II .....	10%	10%	0%	10%	10%	0%	20%	10%	0%	
Bin III .....	70%	70%	60%	70%	70%	60%	60%	70%	60%	
Bin IV .....	10%	10%	35%	10%	10%	35%	20%	10%	30%	
Bin V .....	0%	0%	5%	0%	0%	5%	0%	0%	10%	
Bin VI .....	0%	0%	0%	0%	0%	0%	0%	0%	0%	
Bin VII .....	0%	0%	0%	0%	0%	0%	0%	0%	0%	
<b>Steer Tires</b>										
Base .....	5%	5%	5%	5%	5%	5%	5%	5%	5%	
Level 1 .....	35%	35%	35%	35%	35%	35%	35%	35%	35%	
Level 2 .....	50%	50%	50%	50%	50%	50%	50%	50%	50%	
Level 3 .....	10%	10%	10%	10%	10%	10%	10%	10%	10%	
<b>Drive Tires</b>										
Base .....	15%	15%	5%	15%	15%	5%	15%	15%	5%	
Level 1 .....	35%	35%	35%	35%	35%	35%	35%	35%	35%	
Level 2 .....	50%	50%	50%	50%	50%	50%	50%	50%	50%	
Level 3 .....	0%	0%	10%	0%	0%	10%	0%	0%	10%	
<b>Idle Reduction</b>										
Tamper Proof AESS .....	N/A	N/A	N/A	N/A	N/A	N/A	0%	0%	0%	
Tamper Proof AESS with Diesel APU .....	N/A	N/A	N/A	N/A	N/A	N/A	0%	0%	0%	
Tamper Proof AESS with Battery APU .....	N/A	N/A	N/A	N/A	N/A	N/A	0%	0%	0%	
Tamper Proof AESS with Automatic Stop-Start .....	N/A	N/A	N/A	N/A	N/A	N/A	0%	0%	0%	
Tamper Proof AESS with FOH .....	N/A	N/A	N/A	N/A	N/A	N/A	0%	0%	0%	
Adjustable AESS .....	N/A	N/A	N/A	N/A	N/A	N/A	40%	40%	40%	
Adjustable AESS with Diesel APU .....	N/A	N/A	N/A	N/A	N/A	N/A	30%	30%	30%	
Adjustable AESS with Battery APU .....	N/A	N/A	N/A	N/A	N/A	N/A	10%	10%	10%	
Adjustable AESS with Automatic Stop-Start .....	N/A	N/A	N/A	N/A	N/A	N/A	10%	10%	10%	
Adjustable AESS with FOH .....	N/A	N/A	N/A	N/A	N/A	N/A	10%	10%	10%	
<b>Transmission</b>										
Manual .....	0%	0%	0%	0%	0%	0%	0%	0%	0%	
AMT .....	40%	40%	40%	40%	40%	40%	40%	40%	40%	
Auto .....	10%	10%	10%	10%	10%	10%	10%	10%	10%	
Dual Clutch .....	5%	5%	5%	5%	5%	5%	5%	5%	5%	
Top Gear Direct Drive .....	20%	20%	20%	20%	20%	20%	20%	20%	20%	
Trans. Efficiency .....	20%	20%	20%	20%	20%	20%	20%	20%	20%	
Neutral Idle .....	10%	10%	10%	10%	10%	10%	10%	10%	10%	
<b>Driveline</b>										
Axle Efficiency .....	30%	30%	30%	30%	30%	30%	30%	30%	30%	
6x2, 6x4 Axle Disconnect or 4x2 Axle .....	N/A	N/A	N/A	15%	15%	15%	15%	15%	15%	
Downspeed (Rear Axle Ratio) ..	3.36	3.36	3.36	3.36	3.36	3.36	3.31	3.31	3.31	





TABLE III-14—TECHNOLOGY ADOPTION RATES FOR CLASS 7 AND 8 TRACTORS FOR DETERMINING THE 2024 MY STANDARDS—Continued

	Class 7			Class 8					
	Day cab			Day cab			Sleeper cab		
	Low roof	Mid roof	High roof	Low roof	Mid roof	High roof	Low roof	Mid roof	High roof
Dual Clutch .....	10%	10%	10%	10%	10%	10%	10%	10%	10%
Top Gear Direct Drive .....	50%	50%	50%	50%	50%	50%	50%	50%	50%
Trans. Efficiency .....	40%	40%	40%	40%	40%	40%	40%	40%	40%
Neutral Idle .....	20%	20%	20%	20%	20%	20%	20%	20%	20%
<b>Driveline</b>									
Axle Efficiency .....	65%	65%	65%	65%	65%	65%	65%	65%	65%
6x2, 6x4 Axle Disconnect or 4x2 Axle .....	N/A	N/A	N/A	25%	25%	25%	25%	25%	25%
Downspeed (Rear Axle Ratio) ..	3.31	3.31	3.31	3.31	3.31	3.31	3.26	3.26	3.26
<b>Accessory Improvements</b>									
A/C Efficiency .....	20%	20%	20%	20%	20%	20%	20%	20%	20%
Electric Access. ....	20%	20%	20%	20%	20%	20%	20%	20%	20%
<b>Other Technologies</b>									
Predictive Cruise Control .....	40%	40%	40%	40%	40%	40%	40%	40%	40%
Automated Tire Inflation System	25%	25%	25%	25%	25%	25%	25%	25%	25%
Tire Pressure Monitoring Sys- tem .....	50%	50%	50%	50%	50%	50%	50%	50%	50%
Neutral Coast .....	0%	0%	0%	0%	0%	0%	0%	0%	0%

TABLE III-15—TECHNOLOGY ADOPTION RATES FOR CLASS 7 AND 8 TRACTORS FOR DETERMINING THE 2027 MY STANDARDS

	Class 7			Class 8					
	Day cab			Day cab			Sleeper cab		
	Low roof	Mid roof	High roof	Low roof	Mid roof	High roof	Low roof	Mid roof	High roof
<b>Engine</b>									
	2027 MY 11L Engine 350 HP	2027 MY 11L Engine 350 HP	2027 MY 11L Engine 350 HP	2027 MY 15L Engine 455 HP	2027 MY 15L Engine 455 HP	2027 MY 15L Engine 455 HP	2027 MY 15L Engine 455 HP	2027 MY 15L Engine 455 HP	2027 MY 15L Engine 455 HP
<b>Aerodynamics</b>									
Bin I .....	0%	0%	0%	0%	0%	0%	0%	0%	0%
Bin II .....	20%	20%	0%	20%	20%	20%	20%	20%	0%
Bin III .....	50%	50%	30%	50%	60%	30%	40%	50%	20%
Bin IV .....	30%	30%	30%	30%	20%	30%	40%	30%	30%
Bin V .....	0%	0%	40%	0%	0%	40%	0%	0%	50%
Bin VI .....	0%	0%	0%	0%	0%	0%	0%	0%	0%
Bin VII .....	0%	0%	0%	0%	0%	0%	0%	0%	0%
<b>Steer Tires</b>									
Base .....	5%	5%	5%	5%	5%	5%	5%	5%	5%
Level 1 .....	20%	20%	10%	20%	20%	10%	20%	20%	10%
Level 2 .....	50%	50%	50%	50%	50%	50%	50%	50%	50%
Level 3 .....	25%	25%	35%	25%	25%	35%	25%	25%	35%
<b>Drive Tires</b>									
Base .....	5%	5%	5%	5%	5%	5%	5%	5%	5%
Level 1 .....	10%	10%	10%	10%	10%	10%	10%	10%	10%
Level 2 .....	85%	85%	50%	85%	85%	50%	85%	85%	50%
Level 3 .....	0%	0%	35%	0%	0%	35%	0%	0%	35%
<b>Idle Reduction</b>									
Tamper Proof AESS .....	N/A	N/A	N/A	N/A	N/A	N/A	0%	0%	0%
Tamper Proof AESS with Diesel APU .....	N/A	N/A	N/A	N/A	N/A	N/A	0%	0%	0%
Tamper Proof AESS with Bat- tery APU .....	N/A	N/A	N/A	N/A	N/A	N/A	0%	0%	0%
Tamper Proof AESS with Auto- matic Stop-Start .....	N/A	N/A	N/A	N/A	N/A	N/A	0%	0%	0%
Tamper Proof AESS with FOH	N/A	N/A	N/A	N/A	N/A	N/A	0%	0%	0%
Adjustable AESS .....	N/A	N/A	N/A	N/A	N/A	N/A	15%	15%	15%
Adjustable AESS with Diesel APU .....	N/A	N/A	N/A	N/A	N/A	N/A	40%	40%	40%

TABLE III-15—TECHNOLOGY ADOPTION RATES FOR CLASS 7 AND 8 TRACTORS FOR DETERMINING THE 2027 MY STANDARDS—Continued

	Class 7			Class 8						
	Day cab			Day cab			Sleeper cab			
	Low roof	Mid roof	High roof	Low roof	Mid roof	High roof	Low roof	Mid roof	High roof	
<b>Engine</b>										
Adjustable AESS with Battery APU .....	N/A	N/A	N/A	N/A	N/A	N/A	N/A	15%	15%	15%
Adjustable AESS with Automatic Stop-Start .....	N/A	N/A	N/A	N/A	N/A	N/A	N/A	15%	15%	15%
Adjustable AESS with FOH .....	N/A	N/A	N/A	N/A	N/A	N/A	N/A	15%	15%	15%
<b>Transmission</b>										
Manual .....	0%	0%	0%	0%	0%	0%	0%	0%	0%	0%
AMT .....	50%	50%	50%	50%	50%	50%	50%	50%	50%	50%
Auto .....	30%	30%	30%	30%	30%	30%	30%	30%	30%	30%
Dual Clutch .....	10%	10%	10%	10%	10%	10%	10%	10%	10%	10%
Top Gear Direct Drive .....	50%	50%	50%	50%	50%	50%	50%	50%	50%	50%
Trans. Efficiency .....	70%	70%	70%	70%	70%	70%	70%	70%	70%	70%
Neutral Idle .....	30%	30%	30%	30%	30%	30%	30%	30%	30%	30%
<b>Driveline</b>										
Axle Efficiency .....	80%	80%	80%	80%	80%	80%	80%	80%	80%	80%
6×2, 6×4 Axle Disconnect or 4×2 Axle .....	N/A	N/A	N/A	30%	30%	30%	30%	30%	30%	30%
Downspeed (Rear Axle Ratio) ..	3.21	3.21	3.21	3.21	3.21	3.21	3.21	3.16	3.16	3.16
<b>Accessory Improvements</b>										
A/C Efficiency .....	30%	30%	30%	30%	30%	30%	30%	30%	30%	30%
Electric Access .....	30%	30%	30%	30%	30%	30%	30%	30%	30%	30%
<b>Other Technologies</b>										
Predictive Cruise Control .....	40%	40%	40%	40%	40%	40%	40%	40%	40%	40%
Automated Tire Inflation System	30%	30%	30%	30%	30%	30%	30%	30%	30%	30%
Tire Pressure Monitoring System .....	70%	70%	70%	70%	70%	70%	70%	70%	70%	70%
Neutral Coast .....	0%	0%	0%	0%	0%	0%	0%	0%	0%	0%

(e) Adoption Rates Used To Set the Heavy-Haul Tractor Standards

The agencies recognize that certain technologies used to determine the stringency of the Phase 2 tractor standards are less applicable to heavy-haul tractors. Heavy-haul tractors are not typically used in the same manner as long-haul tractors with extended highway driving, and therefore will experience less benefit from aerodynamics. Aerodynamic technologies are very effective at reducing the fuel consumption and GHG emissions of tractors, but only when traveling at highway speeds. At lower speeds, the aerodynamic technologies may have a detrimental impact due to the potential of added weight. The agencies therefore proposed not considering the use of aerodynamic technologies in the development of the Phase 2 heavy-haul tractor standards. Moreover, because aerodynamics will not play a role in the heavy-haul standards, the agencies proposed to combine all of the heavy-haul tractor cab configurations (day and sleeper) and roof heights (low, mid, and high) into a

single heavy-haul tractor subcategory. We welcomed comment on this approach. 80 FR 40233.

The agencies received comments regarding the applicability of aerodynamic technologies on heavy-haul vehicles. Daimler commented that heavy-haul vehicles are designed to meet high cooling needs, therefore have large radiators and grilles, and are not designed primarily for hauling standard trailers on the highway. Daimler also stated that these vehicles are designed to operate off-road or on difficult terrain, which also limits the application of aerodynamic fairings, and that requiring aerodynamic improvements on these vehicles, may compromise the vehicles' work. EMA supported the agencies' proposed approach of not requiring the use of aerodynamic technologies as a component of the proposed Phase 2 heavy-haul tractor standards. EMA stated that those vehicles are already quite heavy (by virtue of need), are designed to meet high-cooling needs (thus having, for example, large grilles), and generally are not designed for

hauling standard trailers on highways. EMA also stated that those vehicles are often designed to be capable of operation off-road or on difficult terrain. Volvo supported the addition of a heavy-haul subcategory since heavy-haul tractors require large engines and increased cooling capacity that limits aerodynamic improvements. Volvo also stated the most heavy-haul rigs have some requirement for off-road access to pick up machinery, bulk goods, and unusual loads that also inhibit aerodynamic improvements. These comments largely echo the agencies' own concerns voiced at proposal. After considering these comments, the agencies are using a technology package that does not use aerodynamic improvements in setting the Phase 2 heavy-haul tractor standards, as we proposed.<sup>289</sup>

Certain powertrain and drivetrain components are also impacted during the design of a heavy-haul tractor,

<sup>289</sup> Since aerodynamic improvements are not part of the technology package, the agencies likewise are not adopting any aero bin structure for the heavy-haul tractor subcategory.

including the transmission, axles, and the engine. Heavy-haul tractors typically require transmissions with 13 or 18 speeds to provide the ratio spread to ensure that the tractor is able to start pulling the load from a stop. Downsized powertrains are typically not an option for heavy-haul operations because these vehicles require more torque to move the vehicle because of the heavier load. Finally, due to the loading requirements of the vehicle, it is not likely that a 6x2 axle configuration can be used in heavy-haul applications. We requested comments on all aspects of our heavy-haul tractor technology packages. 80 FR 40233.

We received comments from stakeholders about the application of technologies other than aerodynamics for heavy-haul tractors. Daimler commented that the low rolling resistance levels in the NPRM are overly

aggressive because heavy-haul tractors require unusually high traction and stopping power. Daimler agreed with the agencies' assessment in the NPRM that did not include weight reduction because these vehicles require strong frames and axles to carry heavy loads. Volvo commented that heavy-haul tractors would not likely be able to utilize current SmartWay tires; would see no benefit from predictive cruise; sometimes utilize an auxiliary transmission for further reduction or closer ratios; and nearly all heavy-haul tractors have deeper drive axle ratios than the agencies assumed in the NPRM. After considering these comments and the information regarding the tire rolling resistance improvement opportunities, discussed in Section III.D.1.b.iii, the agencies have adjusted the adoption rate of low rolling resistance tires. Consistent with the

changes made in the final rule for the adoption of low rolling resistance tires in low and mid roof tractors, the agencies did not project any adoption of Level 3 tires for heavy-haul tractors in the final rule.

Allison commented that AMTs in the NPRM receive a 1.8 percent credit in GEM for heavy-haul tractors, yet there is no similar credit for ATs. Allison commented that since ATs offer similar, if not greater, benefits, they should also receive credit and that neutral-idle recognition should be available. The final version of Phase 2 GEM treats ATs and AMTs the same for heavy-haul tractors as for the other tractors.

The agencies used the following heavy-haul tractor adoption rates for developing the final Phase 2 2021, 2024, and 2027 MY standards, as shown in Table III-16.

TABLE III-16—APPLICATION RATES FOR HEAVY-HAUL TRACTOR STANDARDS  
[Heavy-haul tractor application rates]

Engine	2021 MY	2024 MY	2027 MY
	2021 MY 15L engine with 600 HP with 2% reduction over 2018 MY	2024 MY 15L engine with 600 HP with 4.2% reduction over 2018 MY	2027 MY 15L engine with 600 HP with 5.4% reduction over 2018 MY
<b>Aerodynamics—0%</b>			
<b>Steer Tires</b>			
Phase 1 Baseline:	15%	10%	5%
Level 1 .....	35%	30%	10%
Level 2 .....	50%	60%	85%
Level 3 .....	0%	0%	0%
<b>Drive Tires</b>			
Phase 1 Baseline:	15%	10%	5%
Level 1 .....	35%	30%	10%
Level 2 .....	50%	60%	85%
Level 3 .....	0%	0%	0%
<b>Transmission</b>			
AMT .....	40%	50%	50%
Automatic with Neutral Idle .....	10%	20%	20%
DCT .....	5%	10%	10%
<b>Other Technologies</b>			
6x2 Axle .....	0%	0%	0%
Transmission Efficiency .....	20%	40%	70%
Axle Efficiency .....	30%	65%	80%
Predictive Cruise Control .....	20%	40%	40%
Accessory Improvements .....	10%	20%	20%
Air Conditioner Efficiency Improvements .....	10%	20%	20%
Automatic Tire Inflation Systems .....	20%	25%	30%
Tire Pressure Monitoring System .....	20%	50%	70%

The agencies are also adopting in Phase 2 provisions that allow the manufacturers to meet an optional heavy Class 8 tractor standard that reflects both aerodynamic

improvements, along with the powertrain requirements that go along with higher GCWR. Table III-17 reflects the adoption rates for each of the technologies for each of the

subcategories in MY 2021. The technology packages closely reflect those in the primary Class 8 tractor program. The exceptions include less aggressive targets for low rolling

resistance tires, no 6x2 axle adoption rates, and no downspeeding due to the heavier loads of these vehicles.

TABLE III–17—ADOPTION RATES USED TO DEVELOP THE 2021 MY OPTIONAL HEAVY CLASS 8 TRACTOR STANDARDS  
[Optional heavy class 8 tractor application rates—2021 MY]

Engine	Low/mid roof day cab	High roof day cab	Low/mid roof sleeper cab	High roof sleeper cab
	2021 MY 15L Engine with 600 HP	2021 MY 15L Engine with 600 HP	2021 MY 15L Engine with 600 HP	2021 MY 15L Engine with 600 HP
<b>Aerodynamics</b>				
Bin I .....	10%	0%	10%	0%
Bin II .....	10%	0%	10%	0%
Bin III .....	70%	60%	70%	60%
Bin IV .....	10%	35%	10%	30%
Bin V .....	0%	5%	0%	10%
Bin VI .....	0%	0%	0%	0%
Bin VII .....	0%	0%	0%	0%
<b>Steer Tires</b>				
Phase 1 Baseline	10%	5%	10%	5%
Level 1 .....	25%	35%	25%	35%
Level 2 .....	65%	60%	65%	60%
Level 3 .....	0%	0%	0%	0%
<b>Drive Tires</b>				
Phase 1 Baseline	20%	10%	20%	10%
Level 1 .....	40%	30%	40%	30%
Level 2 .....	40%	60%	40%	60%
Level 3 .....	0%	0%	0%	0%
<b>Transmission</b>				
AMT .....	40%	40%	40%	40%
Automatic with Neutral Idle .....	10%	10%	10%	10%
DCT .....	5%	5%	5%	5%
<b>Other Technologies</b>				
Adjustable AESS w/Diesel APU .....	N/A	N/A	30%	30%
Adjustable AESS w/Battery APU .....	N/A	N/A	10%	10%
Adjustable AESS w/Automatic Stop-Start .....	N/A	N/A	10%	10%
Adjustable AESS w/FOH Cold, Main Engine Warm .....	N/A	N/A	10%	10%
Adjustable AESS programmed to 5 minutes .....	N/A	N/A	40%	40%
Transmission Efficiency .....	20%	20%	20%	20%
Axle Efficiency .....	30%	30%	30%	30%
Predictive Cruise Control .....	20%	20%	20%	20%
Accessory Improvements .....	10%	10%	10%	10%
Air Conditioner Efficiency Improvements .....	10%	10%	10%	10%
Automatic Tire Inflation Systems .....	20%	20%	20%	20%
Tire Pressure Monitoring System .....	20%	20%	20%	20%

(f) Derivation of the Final Phase 2 Tractor Standards

The agencies used the technology effectiveness inputs and technology adoption rates to develop GEM inputs to derive the HD Phase 2 fuel consumption and CO<sub>2</sub> emissions standards for each subcategory of Class 7 and 8 combination tractors. Note that we have analyzed *one* technology pathway for each level of stringency, but manufacturers will be free to use any combination of technology to meet the

standards, as well as the flexibility of averaging, banking and trading, to meet the standard on average. The agencies derived a scenario tractor for each subcategory by weighting the individual GEM input parameters included in Table III–7 with the adoption rates in Table III–8 through Table III–10. For example, the C<sub>d</sub>A value for a 2021 MY Class 8 Sleeper Cab High Roof scenario case was derived as 60 percent times 5.95 plus 30 percent times 5.40 plus 10 percent times 4.90, which is equal to a

C<sub>d</sub>A of 5.68 m<sup>2</sup>. Similar calculations were made for tire rolling resistance, transmission types, idle reduction, and other technologies. The agencies developed fuel maps that achieved the CO<sub>2</sub> emissions and fuel consumption reductions described in Section III.D.1.b. The agencies then ran GEM with a single set of vehicle inputs, as shown in Table III–18 through Table III–21, to derive the final standards for each subcategory. Additional detail is provided in the RIA Chapter 2.8.4.

TABLE III-18—GEM INPUTS FOR THE 2021 MY CLASS 7 AND 8 TRACTOR STANDARD SETTING

Class 7			Class 8					
Day cab			Day cab			Sleeper cab		
Low roof	Mid roof	High roof	Low roof	Mid roof	High roof	Low roof	Mid roof	High roof
<b>Engine</b>								
2021 MY 11L Engine 350 HP	2021 MY 11L Engine 350 HP	2021 MY 11L Engine 350 HP	2021 MY 15L Engine 455 HP	2021 MY 15L Engine 455 HP	2021 MY 15L Engine 455 HP	2021 MY 15L Engine 455 HP	2021 MY 15L Engine 455 HP	2021 MY 15L Engine 455 HP
<b>Aerodynamics (C<sub>d</sub>A in m<sup>2</sup>)</b>								
5.24	6.33	6.01	5.24	6.33	6.01	5.24	6.33	5.68
<b>Steer Tires (CRR in kg/metric ton)</b>								
6.0	6.0	6.0	6.0	6.0	6.0	6.0	6.0	6.0
<b>Drive Tires (CRR in kg/metric ton)</b>								
6.6	6.6	6.3	6.6	6.6	6.3	6.6	6.6	6.3
<b>Extended Idle Reduction Weighted Effectiveness</b>								
N/A	N/A	N/A	N/A	N/A	N/A	2.3%	2.3%	2.3%
<b>Transmission</b> = 10 speed Manual Transmission <b>Gear Ratios</b> = 12.8, 9.25, 6.76, 4.90, 3.58, 2.61, 1.89, 1.38, 1.00, 0.73								
<b>Drive Axle Ratio</b> = 3.36 for day cabs, 3.31 for sleeper cabs								
<b>6x2 Axle Weighted Effectiveness</b>								
N/A	N/A	N/A	0.3%	0.3%	0.3%	0.3%	0.3%	0.3%
<b>Transmission Type Weighted Effectiveness</b> = 1.1%								
<b>Neutral Idle Weighted Effectiveness</b>								
0.1%	0.1%	0.1%	0.1%	0.1%	0.1%	0.02%	0.02%	0.02%
<b>Direct Drive Weighted Effectiveness</b> = 0.4%								
<b>Transmission Efficiency Weighted Effectiveness</b> = 0.2%								
<b>Axle Efficiency Improvement</b> = 0.6%								
<b>Air Conditioner Efficiency Improvements</b> = 0.1%								
<b>Accessory Improvements</b> = 0.1%								
<b>Predictive Cruise Control</b> = 0.4%								
<b>Automatic Tire Inflation Systems</b> = 0.3%								
<b>Tire Pressure Monitoring System</b> = 0.2%								
<b>Phase 1 Credit Carry-over</b> = 1%								

TABLE III-19—GEM INPUTS FOR THE 2024 MY CLASS 7 AND 8 TRACTOR STANDARD SETTING

Class 7			Class 8					
Day cab			Day cab			Sleeper cab		
Low roof	Mid roof	High roof	Low roof	Mid roof	High roof	Low roof	Mid roof	High roof
<b>Engine</b>								
2024 MY 11L Engine 350 HP	2024 MY 11L Engine 350 HP	2024 MY 11L Engine 350 HP	2024 MY 15L Engine 455 HP	2024 MY 15L Engine 455 HP	2024 MY 15L Engine 455 HP	2024 MY 15L Engine 455 HP	2024 MY 15L Engine 455 HP	2024 MY 15L Engine 455 HP
<b>Aerodynamics (C<sub>d</sub>A in m<sup>2</sup>)</b>								
5.16	6.25	5.82	5.16	6.25	5.82	5.16	6.25	5.52
<b>Steer Tires (CRR in kg/metric ton)</b>								
5.9	5.9	5.8	5.9	5.9	5.8	5.9	5.9	5.8
<b>Drive Tires (CRR in kg/metric ton)</b>								
6.4	6.4	6.0	6.4	6.4	6.0	6.4	6.4	6.0
<b>Extended Idle Reduction Weighted Effectiveness</b>								
N/A	N/A	N/A	N/A	N/A	N/A	2.5%	2.5%	2.5%
<b>Transmission = 10 speed Manual Transmission</b>								
<b>Gear Ratios = 12.8, 9.25, 6.76, 4.90, 3.58, 2.61, 1.89, 1.38, 1.00, 0.73</b>								
<b>Drive Axle Ratio = 3.31 for day cabs, 3.26 for sleeper cabs</b>								
<b>6x2 Axle Weighted Effectiveness</b>								
N/A	N/A	N/A	0.5%	0.5%	0.5%	0.5%	0.5%	0.5%
<b>Transmission Type Weighted Effectiveness = 1.6%</b>								
<b>Neutral Idle Weighted Effectiveness</b>								
0.2%	0.2%	0.2%	0.2%	0.2%	0.2%	0.03%	0.03%	0.03%
<b>Direct Drive Weighted Effectiveness = 1.0%</b>								
<b>Transmission Efficiency Weighted Effectiveness = 0.4%</b>								
<b>Axle Efficiency Improvement = 1.3%</b>								
<b>Air Conditioner Efficiency Improvements = 0.1%</b>								
<b>Accessory Improvements = 0.2%</b>								
<b>Predictive Cruise Control = 0.8%</b>								
<b>Automatic Tire Inflation</b>								
<b>Tire Pressure Monitoring System = 0.5%</b>								

TABLE III-20—GEM INPUTS FOR THE 2027 MY CLASS 7 AND 8 TRACTOR STANDARD SETTING

Class 7			Class 8					
Day cab			Day cab			Sleeper cab		
Low roof	Mid roof	High roof	Low roof	Mid roof	High roof	Low roof	Mid roof	High roof
<b>Engine</b>								
2027 MY 11L Engine 350 HP	2027 MY 11L Engine 350 HP	2027 MY 11L Engine 350 HP	2027 MY 15L Engine 455 HP	2027 MY 15L Engine 455 HP	2027 MY 15L Engine 455 HP	2027 MY 15L Engine 455 HP	2027 MY 15L Engine 455 HP	2027 MY 15L Engine 455 HP
<b>Aerodynamics (C<sub>d</sub>A in m<sup>2</sup>)</b>								
5.12	6.21	5.67	5.12	6.21	5.67	5.08	6.21	5.26
<b>Steer Tires (CRR in kg/metric ton)</b>								
5.8	5.8	5.6	5.8	5.8	5.6	5.8	5.8	5.6
<b>Drive Tires (CRR in kg/metric ton)</b>								
6.2	6.2	5.8	6.2	6.2	5.8	6.2	6.2	5.8
<b>Extended Idle Reduction Weighted Effectiveness</b>								
N/A	N/A	N/A	N/A	N/A	N/A	3%	3%	3%
<b>Transmission = 10 speed Manual Transmission</b>								
<b>Gear Ratios = 12.8, 9.25, 6.76, 4.90, 3.58, 2.61, 1.89, 1.38, 1.00, 0.73</b>								
<b>Drive Axle Ratio = 3.21 for day cabs, 3.16 for sleeper cabs</b>								
<b>6x2 Axle Weighted Effectiveness</b>								
N/A	N/A	N/A	0.6%	0.6%	0.6%	0.6%	0.6%	0.6%
<b>Transmission Type Weighted Effectiveness = 1.6%</b>								
<b>Neutral Idle Weighted Effectiveness</b>								
0.2%	0.2%	0.2%	0.2%	0.2%	0.2%	0.03%	0.03%	0.03%
<b>Direct Drive Weighted Effectiveness = 1.0%</b>								
<b>Transmission Efficiency Weighted Effectiveness = 0.7%</b>								
<b>Axle Efficiency Improvement = 1.6%</b>								
<b>Air Conditioner Efficiency Improvements = 0.3%</b>								
<b>Accessory Improvements = 0.2%</b>								
<b>Predictive Cruise Control = 0.8%</b>								
<b>Automatic Tire Inflation Systems = 0.4%</b>								
<b>Tire Pressure Monitoring System = 0.7%</b>								

TABLE III-21—GEM INPUTS FOR 2021, 2024 AND 2027 MY HEAVY-HAUL TRACTOR STANDARDS

2021 MY	2024 MY	2027 MY
Engine = 2021 MY 15L Engine with 600 HP .....	Engine = 2024 MY 15L Engine with 600 HP ..	Engine = 2027 MY 15L Engine with 600 HP.
<b>Aerodynamics (C<sub>d</sub>A in m<sup>2</sup>) = 5.00</b>		
Steer Tires (CRR in kg/metric ton) = 6.2 .....	Steer Tires (CRR in kg/metric ton) = 6.0 .....	Steer Tires (CRR in kg/metric ton) = 5.8.
Drive Tires (CRR in kg/metric ton) = 6.6 .....	Drive Tires (CRR in kg/metric ton) = 6.4 .....	Drive Tires (CRR in kg/metric ton) = 6.2.
Transmission = 18 speed Manual Transmission	Transmission = 18 speed Manual Transmission.	Transmission = 18 speed Manual Transmission.
Drive axle Ratio = 3.70 .....	Drive axle Ratio = 3.70 .....	Drive axle Ratio = 3.70.
6x2 Axle Weighted Effectiveness = 0% .....	6x2 Axle Weighted Effectiveness = 0% .....	6x2 Axle Weighted Effectiveness = 0%.
Transmission benefit = 1.1% .....	Transmission benefit = 1.8% .....	Transmission benefit = 1.8%.

TABLE III-21—GEM INPUTS FOR 2021, 2024 AND 2027 MY HEAVY-HAUL TRACTOR STANDARDS—Continued

2021 MY	2024 MY	2027 MY
Transmission Efficiency = 0.2%	Transmission Efficiency = 0.4%	Transmission Efficiency = 0.7%.
Axle Efficiency = 0.3%	Axle Efficiency = 0.7%	Axle Efficiency = 1.6%.
Predictive Cruise Control = 0.4%	Predictive Cruise Control = 0.8%	Predictive Cruise Control = 0.8%.
Accessory Improvements = 0.1%	Accessory Improvements = 0.2%	Accessory Improvements = 0.3%.
Air Conditioner Efficiency Improvements = 0.1%	Air Conditioner Efficiency Improvements = 0.1%.	Air Conditioner Efficiency Improvements = 0.2%.
Automatic Tire Inflation Systems = 0.3%	Automatic Tire Inflation Systems = 0.3%	Automatic Tire Inflation Systems = 0.4%.
Tire Pressure Monitoring System = 0.2%	Tire Pressure Monitoring System = 0.5%	Tire Pressure Monitoring System = 0.7%.

The agencies ran GEM with a single set of vehicle inputs, as shown in Table III-22, to derive the optional standards

for each subcategory of the Heavy Class 8 tractors (see Section III.C.(4)(a)).

TABLE III-22—GEM INPUTS FOR 2021 MY OPTIONAL HEAVY CLASS 8 TRACTOR STANDARDS  
[Heavy Class 8 GEM inputs for 2021 MY]

Day cab			Sleeper cab		
Low roof	Mid roof	High roof	Low roof	Mid roof	High roof
<b>2021 MY 15L Engine 600 HP</b>					
<b>Aerodynamics (C<sub>d</sub>A in m<sup>2</sup>)</b>					
5.2	6.3	6.0	5.2	6.3	5.7
<b>Steer Tires (CRR in kg/metric ton)</b>					
6.1	6.1	6.1	6.1	6.1	6.1
<b>Drive Tires (CRR in kg/metric ton)</b>					
6.8	6.8	6.5	6.8	6.8	6.5
<b>Extended Idle Reduction Weighted Effectiveness</b>					
N/A	N/A	N/A	2.3%	2.3%	2.3%
<b>Transmission = 18 speed Manual Transmission</b>					
<b>Drive Axle Ratio = 3.73</b>					
<b>Transmission Type Weighted Effectiveness = 1.1%</b>					
<b>Neutral Idle Weighted Effectiveness</b>					
0.1%	0.1%	0.1%	0.1%	0.1%	0.1%
<b>Direct Drive Weighted Effectiveness = 0.4%</b>					
<b>Transmission Efficiency Weighted Effectiveness = 0.2%</b>					
<b>Axle Efficiency Improvement = 0.6%</b>					
<b>Air Conditioner Efficiency Improvements = 0.1%</b>					
<b>Accessory Improvements = 0.1%</b>					
<b>Predictive Cruise Control = 0.4%</b>					
<b>Automatic Tire Inflation Systems = 0.3%</b>					
<b>Tire Pressure Monitoring System = 0.2%</b>					

The level of the final Phase 2 2027 model year standards, and the phase-in standards in model years 2021 and 2024

for each subcategory, is shown in Table III-23.



TABLE III-23—FINAL PHASE 2 2021, 2024, AND 2027 MODEL YEAR TRACTOR STANDARDS

	Day cab		Sleeper cab	Heavy-haul
	Class 7	Class 8	Class 8	Class 8
<b>2021 Model Year CO<sub>2</sub> Grams per Ton-Mile</b>				
Low Roof .....	105.5	80.5	72.3	52.4
Mid Roof .....	113.2	85.4	78.0	
High Roof .....	113.5	85.6	75.7	
<b>2021 Model Year Gallons of Fuel per 1,000 Ton-Mile</b>				
Low Roof .....	10.36346	7.90766	7.10216	5.14735
Mid Roof .....	11.11984	8.38900	7.66208	
High Roof .....	11.14931	8.40864	7.43615	
<b>2024 Model Year CO<sub>2</sub> Grams per Ton-Mile</b>				
Low Roof .....	99.8	76.2	68.0	50.2
Mid Roof .....	107.1	80.9	73.5	
High Roof .....	106.6	80.4	70.7	
<b>2024 Model Year and Later Gallons of Fuel per 1,000 Ton-Mile</b>				
Low Roof .....	9.80354	7.48527	6.67976	4.93124
Mid Roof .....	10.52063	7.94695	7.22004	
High Roof .....	10.47151	7.89784	6.94499	
<b>2027 Model Year CO<sub>2</sub> Grams per Ton-Mile<sup>a</sup></b>				
Low Roof .....	96.2	73.4	64.1	48.3
Mid Roof .....	103.4	78.0	69.6	
High Roof .....	100.0	75.7	64.3	
<b>2027 Model Year and Later Gallons of Fuel per 1,000 Ton-Mile</b>				
Low Roof .....	9.44990	7.21022	6.29666	4.74460
Mid Roof .....	10.15717	7.66208	6.83694	
High Roof .....	9.82318	7.43615	6.31631	

**Note:**

<sup>a</sup> The 2027 MY high roof tractor standards include a 0.3 m<sup>2</sup> reduction in C<sub>d</sub>A as described in Section III.E.2.a.vii.

The level of the Phase 2 2027 model year optional Heavy Class 8 standards is shown in Table III-24.

TABLE III-24—PHASE 2 OPTIONAL HEAVY CLASS 8 STANDARDS

[Optional heavy Class 8 tractor standards]

Low roof day cab	Mid roof day cab	High roof day cab	Low roof sleeper cab	Mid roof sleeper cab	High roof sleeper cab
<b>2021 Model Year CO<sub>2</sub> Standards (Grams per Ton-Mile)</b>					
51.8	54.1	54.1	45.3	47.9	46.9
<b>2021 MY and Later Fuel Consumption (Gallons of Fuel per 1,000 Ton-Mile)</b>					
5.08841	5.31434	5.31434	4.44990	4.70530	4.60707

(g) Technology Costs of the Final Phase 2 Tractor Standards

A summary of the technology package costs is included in Table III-15 through Table III-17 for MYs 2021, 2024, and 2027, respectively, with additional details available in the RIA Chapter 2.12.

The agencies received several comments related to the APU, tire, and

aerodynamic technology costs used by the agencies at proposal. As noted in Section III.C.3 above, ATA, First Industries, and Daimler commented that APU costs are substantially higher than the figures in the proposal. PACCAR commented that the cost of a diesel or battery-based APU is \$8,570 to \$11,263. EMA commented that the direct per-chassis cost of a diesel APU is

approximately \$8,500–\$10,100 and approximately \$11,300 for battery/ electric APUs. Volvo commented that APU prices can vary between \$9,500 and \$11,000 depending on the type. Schneider commented that an electronic APU will have an initial cost of at least \$5,000 and engine powered APUs are 2 to 3 times the electric costs.

EPA considered the comments and more closely evaluated NHTSA's contracted TetraTech cost report found the retail price of a diesel-powered APU with a DPF to be \$10,000.<sup>290</sup> The agencies used a retail price of a diesel-powered APU to be \$8,000 without a DPF and \$10,000 with a DPF in the cost analysis for this final rulemaking.

ATA and First Industries commented that the LRR tire costs calculations appear to be based on calculations on 1999 data indexed for inflation. Michelin's comments stated that they estimate the cost of low rolling resistance tires to be about \$25 per tire. ATA commented that the industry commonly sees a 40 percent reduction in useful life and a 20 percent reduction in casing life resulting from low rolling resistance tires. ATA and First Industries commented that the LRR tire costs do not account for reduced tire life resulting in fewer retreads. Schneider commented that WBS tire costs must include additional service costs, cost of reduced tire life, and increased replacement tire costs due to recaps not available, and reduced resale value. Volvo also commented that heavy-duty fleets expect to retread tires as many as five times and have concerns that tire casing durability may be compromised with low rolling resistance tires. Volvo stressed that retreading saves cost and about two thirds of the oil required to produce a new tire.

We have estimated the cost of lower rolling resistance tires based on an estimate from TetraTech of \$30 (retail, 2013\$). We also have applied a "medium" complexity markup value for the more advanced low rolling resistance tires. We expect that, when replaced, the lower rolling resistance tires would be replaced by equivalent performing tires throughout the vehicle lifetime. As such, the incremental increases in costs for lower rolling resistance tires would be incurred throughout the vehicle lifetime at intervals consistent with current tire replacement intervals. A recent study conducted by ATA's Technology and Maintenance Council found through surveys of 51 fleets that low rolling

resistance tires and wide base single tires lasted longer than standard tractor tires.<sup>291</sup> Due to the uncertainty regarding the life expectancy of the LRR tires, we maintained the current tire replacement intervals in our cost analysis.

ATA and First Industries commented that the estimated costs of future aerodynamic devices appear low given the historical nature of the proposed changes. ATA and First Industries also commented that the agencies should describe in detail the component packages they expect to satisfy each bin level, cost breakdowns of these individual components, and how this technology will be modified over time to maintain compliance with increasingly stringency levels. The agencies included the technology cost of aerodynamic improvements, such as wheel covers and active grill shutters, in RIA Chapter 2.11.

The agencies also received comments associated with other costs that should be considered related to the technologies, specifically 6x2 axle configurations, tire pressure monitoring and inflation system, and APUs. ATA and First Industries commented that the agencies should include additional tire wear and negative residual values associated with 6x2 axles. Schneider commented that 6x2 axle configurations cost should include loss on resale value, increased tire wear, and cost for electronic technology to improve traction. ATA and First Industries commented that the cost estimates for tire inflation systems and TPMS must include warranty limitations, useful life, maintenance and replacement costs, as well as costs of false warnings and increased operation of the air compressor. Doran cited a FMCSA study that found TPMS and ATIS reduce road calls for damaged tires and reduced number of tire replacements and did not introduce unscheduled maintenance. Schneider commented that an electronic APU will have maintenance of \$500 per year and engine powered APUs must also include maintenance costs. Caterpillar requested that the agencies take a total cost of ownership approach

when considering the technology feasibility and adoption rates.

With respect to costs, all of the agencies' technology cost analyses include both direct and indirect costs. Indirect costs include items such as warranty. In terms of maintenance, the presence of tire inflation management systems, should serve to improve tire maintenance intervals and perhaps reduce vehicle downtime due to tire issues; they may also carry with them some increased maintenance costs to ensure that the tire inflation systems themselves remain in proper operation. For the analysis, we have considered these two competing factors to cancel each other out. The agencies also considered the maintenance impact of 6x2 axles. As noted in the NACFE Confidence Report on 6x2 axles, the industry expects an overall reduction in maintenance costs and labor for vehicles with a 6x2 configuration as compared to a 6x4 configuration.<sup>292</sup> Among other savings, the reduction in number of parts, such as the interaxle drive shaft, will reduce the number of lubrication procedures needed and reduce the overall quantity of differential fluid needed at change intervals. The agencies have taken an approach to the maintenance costs for the 6x2 technology where we believe that the overall impact will be zero. The agencies added maintenance costs for diesel powered APUs, battery powered APUs, and diesel fired heaters into the cost analysis for the final rulemaking, as described in RIA Chapter 7.2.3. In response to Caterpillar's comment, the agencies considered the total cost of ownership during the payback calculations, included in RIA Chapter 7 of the final rule. The payback calculations include the hardware costs of the new technologies and their associated fixed costs, increased insurance, taxes, and maintenance. The agencies found that for each category of vehicle—tractor/trailers, vocational vehicles, and HD pickups and vans— included in the Phase 2 rule that the fuel savings significantly exceed the costs associated with the technologies over the lifetime of the vehicles.

<sup>290</sup> U.S. DOT/NHTSA. Commercial Medium- and Heavy-Duty Truck Fuel Efficiency Technology Cost Study. May 2015. Page 71.

<sup>291</sup> Truckinginfo. TMC Survey Reveals Misinformed View of Fuel-Efficient Tires. March 2015.

<sup>292</sup> North American Council for Freight Efficiency. Confidence Findings on the Potential of 6x2 Axles. 2014.

TABLE III-25—CLASS 7 AND 8 TRACTOR TECHNOLOGY INCREMENTAL COSTS IN THE 2021 MODEL YEAR<sup>a b</sup> FINAL STANDARD VS. THE FLAT BASELINE  
[2013\$ per vehicle]

	Class 7		Class 8				
	Day cab		Day cab		Sleeper cab		
	Low/mid roof	High roof	Low/mid roof	High roof	Low roof	Mid roof	High roof
Engine <sup>c</sup> .....	\$284	\$284	\$284	\$284	\$284	\$284	\$284
Aerodynamics .....	164	299	164	299	119	119	349
Tires .....	39	9	61	16	61	56	16
Tire inflation system .....	259	259	300	300	300	300	300
Transmission .....	4,096	4,096	4,096	4,096	4,096	4,096	4,096
Axle Efficiency .....	71	71	101	101	101	101	101
Idle reduction .....	0	0	0	0	1,998	1,998	1,909
Air conditioning .....	17	17	17	17	17	17	17
Other vehicle technologies .....	204	204	204	204	204	204	204
Total .....	5,134	5,240	5,228	5,317	7,181	7,175	7,276

**Notes:**

<sup>a</sup> Costs shown are for the 2021 model year and are incremental to the costs of a baseline tractor meeting the Phase 1 standards. These costs include indirect costs via markups along with learning impacts. For a description of the markups and learning impacts considered in this analysis and how it impacts technology costs for other years, refer to Chapter 2 of the RIA (see RIA 2.12).

<sup>b</sup> Note that values in this table include adoption rates. Therefore, the technology costs shown reflect the average cost expected for each of the indicated tractor classes. To see the actual estimated technology costs exclusive of adoption rates, refer to Chapter 2 of the RIA (see RIA 2.12 in particular).

<sup>c</sup> Engine costs are for a heavy HD diesel engine meant for a combination tractor. The engine costs in this table are equal to the engine costs associated with the separate engine standard because both include the same set of engine technologies (see Section II.D.2.d.i).

TABLE III-26—CLASS 7 AND 8 TRACTOR TECHNOLOGY INCREMENTAL COSTS IN THE 2024 MODEL YEAR<sup>a b</sup> PREFERRED ALTERNATIVE VS. THE FLAT BASELINE  
[2013\$ per vehicle]

	Class 7		Class 8				
	Day cab		Day cab		Sleeper cab		
	Low/mid roof	High roof	Low/mid roof	High roof	Low roof	Mid roof	High roof
Engine <sup>c</sup> .....	\$712	\$712	\$712	\$712	\$712	\$712	\$712
Aerodynamics .....	264	465	264	465	217	217	467
Tires .....	40	12	65	20	65	65	20
Tire inflation system .....	383	383	477	477	477	477	477
Transmission .....	6,092	6,092	6,092	6,092	6,092	6,092	6,092
Axle Efficiency .....	139	139	185	185	185	185	185
Idle reduction .....	0	0	0	0	2,946	2,946	2,946
Air conditioning .....	32	32	32	32	32	32	32
Other vehicle technologies .....	374	374	374	374	374	374	374
Total .....	8,037	8,210	8,201	8,358	11,100	11,100	11,306

**Notes:**

<sup>a</sup> Costs shown are for the 2024 model year and are incremental to the costs of a baseline tractor meeting the Phase 1 standards. These costs include indirect costs via markups along with learning impacts. For a description of the markups and learning impacts considered in this analysis and how it impacts technology costs for other years, refer to Chapter 2 of the RIA (see RIA 2.12).

<sup>b</sup> Note that values in this table include adoption rates. Therefore, the technology costs shown reflect the average cost expected for each of the indicated tractor classes. To see the actual estimated technology costs exclusive of adoption rates, refer to Chapter 2 of the RIA (see RIA 2.12).

<sup>c</sup> Engine costs are for a heavy HD diesel engine meant for a combination tractor. The engine costs in this table are equal to the engine costs associated with the separate engine standard because both include the same set of engine technologies (see Section II.D.2.d.i).

TABLE III-27—CLASS 7 AND 8 TRACTOR TECHNOLOGY INCREMENTAL COSTS IN THE 2027 MODEL YEAR<sup>a b</sup> PREFERRED ALTERNATIVE VS. THE FLAT BASELINE  
[2013\$ per vehicle]

	Class 7		Class 8				
	Day cab		Day cab		Sleeper cab		
	Low/mid roof	High roof	Low/mid roof	High roof	Low roof	Mid roof	High roof
Engine <sup>c</sup> .....	\$1,579	\$1,579	\$1,579	\$1,579	\$1,579	\$1,579	\$1,579
Aerodynamics .....	453	547	453	547	415	415	639

TABLE III-27—CLASS 7 AND 8 TRACTOR TECHNOLOGY INCREMENTAL COSTS IN THE 2027 MODEL YEAR <sup>a b</sup> PREFERRED ALTERNATIVE VS. THE FLAT BASELINE—Continued

[2013\$ per vehicle]

	Class 7		Class 8				
	Day cab		Day cab		Sleeper cab		
	Low/mid roof	High roof	Low/mid roof	High roof	Low roof	Mid roof	High roof
Tires .....	43	12	70	20	70	70	20
Tire inflation system .....	469	469	594	594	594	594	594
Transmission .....	7,098	7,098	7,098	7,098	7,098	7,098	7,098
Axle Efficiency .....	168	168	220	220	220	220	220
Idle reduction .....	0	0	0	0	3,134	3,173	3,173
Air conditioning .....	45	45	45	45	45	45	45
Other vehicle technologies .....	380	380	380	380	380	380	380
<b>Total .....</b>	<b>10,235</b>	<b>10,298</b>	<b>10,439</b>	<b>10,483</b>	<b>13,535</b>	<b>13,574</b>	<b>13,749</b>

**Notes:**

<sup>a</sup> Costs shown are for the 2027 model year and are incremental to the costs of a baseline tractor meeting the Phase 1 standards. These costs include indirect costs via markups along with learning impacts. For a description of the markups and learning impacts considered in this analysis and how it impacts technology costs for other years, refer to Chapter 2 of the RIA (see RIA 2.12).

<sup>b</sup> Note that values in this table include adoption rates. Therefore, the technology costs shown reflect the average cost expected for each of the indicated tractor classes. To see the actual estimated technology costs exclusive of adoption rates, refer to Chapter 2 of the RIA (see RIA 2.12 in particular).

<sup>c</sup> Engine costs are for a heavy HD diesel engine meant for a combination tractor. The engine costs in this table are equal to the engine costs associated with the separate engine standard because both include the same set of engine technologies (see Section II.D.2.d.i).

The technology costs associated with the heavy-haul tractor standards are shown below in Table III-28.

TABLE III-28—HEAVY-HAUL TRACTOR TECHNOLOGY INCREMENTAL COSTS IN THE 2021, 2024, AND 2027 MODEL YEAR <sup>a b</sup> PREFERRED ALTERNATIVE VS. THE FLAT BASELINE

[2013\$ per vehicle]

	2021 MY	2024 MY	2027 MY
Engine <sup>c</sup> .....	\$284	\$712	\$1,579
Tires .....	61	65	70
Tire inflation system .....	300	477	594
Transmission .....	4,096	6,092	7,098
Axle Efficiency .....	101	185	220
Air conditioning .....	17	32	45
Other vehicle technologies .....	204	374	380
<b>Total .....</b>	<b>5,063</b>	<b>7,937</b>	<b>9,986</b>

**Notes:**

<sup>a</sup> Costs shown are for the specified model year and are incremental to the costs of a baseline tractor meeting the Phase 1 standards. These costs include indirect costs via markups along with learning impacts. For a description of the markups and learning impacts considered in this analysis and how it impacts technology costs for other years, refer to Chapter 2 of the RIA (see RIA 2.12).

<sup>b</sup> Note that values in this table include adoption rates. Therefore, the technology costs shown reflect the average cost expected for each of the indicated tractor classes. To see the actual estimated technology costs exclusive of adoption rates, refer to Chapter 2 of the RIA (see RIA 2.12 in particular).

<sup>c</sup> Engine costs are for a heavy HD diesel engine meant for a combination tractor.

(2) Consistency of the Tractor Standards With the Agencies' Legal Authority

The HD Phase 2 standards are based on adoption rates for technologies that the agencies regard as the maximum feasible for purposes of EISA Section 32902(k) and appropriate under CAA section 202(a) for the reasons given in Section III.D.1(b) through (d) above; see also RIA Chapter 2.8. The agencies believe these technologies can be adopted at the estimated rates for these standards within the lead time

provided, as discussed above and in RIA Chapter 2.8. The 2021 and 2024 MY standards are phase-in standards on the path to the 2027 MY standards and were developed using less aggressive application rates and therefore have lower technology package costs than the 2027 MY standards. Moreover, we project the cost of these technologies will be rapidly recovered by operators due to the associated fuel savings, as shown in the payback analysis included in Section IX below. The cost per tractor

to meet the 2027 MY standards is projected to range between \$10,200 and \$13,700 (which includes the cost of the engine standards). See Table III-25 above. Much or all of this will be recovered in the form of fuel savings during the first two years of ownership. The agencies note that while the projected costs per vehicle are significantly greater than the costs projected for Phase 1, we still consider that cost to be reasonable, especially given the relatively short payback

period. In this regard the agencies note that the estimated payback period for tractors of less than two years,<sup>293</sup> is itself shorter than the estimated payback period for light duty trucks in the 2017–2025 light duty greenhouse gas standards. That period was slightly over three years, see 77 FR 62926–62927, which EPA found to be a highly reasonable given the usual period of ownership of light trucks is typically five years.<sup>294</sup> The same is true here. Ownership of new tractors is customarily four to six years, meaning that the greenhouse gas and fuel consumption technologies pay for themselves early on and the purchaser sees overall savings in succeeding years—while still owning the vehicle.<sup>295</sup> The agencies note further that the costs for each subcategory are relatively proportionate; that is, costs of any single tractor subcategory are not disproportionately higher (or lower) than any other. Although the rule is technology-forcing (especially with respect to aerodynamic and drivetrain efficiency improvements), the agencies believe that manufacturers retain leeway to develop alternative compliance paths, increasing the likelihood of the standards’ successful implementation. The agencies also regard these reductions as cost-effective, even

without considering payback period. The agencies estimate the cost per metric ton of CO<sub>2</sub>eq reduction without considering fuel savings to be \$36 for tractor-trailers in 2030 which compares favorably with the levels of cost effectiveness the agencies found to be reasonable for light duty trucks.<sup>296 297</sup> See 77 FR 62922. The phase-in 2021 and 2024 MY standards are less stringent and less costly than the 2027 MY standards and hence likewise reasonable. For these reasons, and because the agencies have carefully considered lead time and shown that lead time is adequate, EPA believes they are also reasonable under Section 202(a) of the CAA. Given that the agencies believe these standards are technically feasible, are highly cost effective, and even more highly cost effective when accounting for the fuel savings, and have no apparent adverse potential impacts (e.g., there are no projected negative impacts on safety or vehicle utility, and EPA has taken steps to avoid adverse collateral consequences from use of APUs without filter-based particulate controls), these standards represent a reasonable choice under Section 202(a)(2) of the CAA and the maximum feasible under NHTSA’s EISA authority at 49 U.S.C. 32902(k)(2).

(3) Alternative Tractor Standards Considered

The agencies developed and considered other alternative levels of stringency for the Phase 2 program. The results of the analysis of these alternatives are discussed below in Section X of the Preamble. For tractors, the agencies developed the following alternatives as shown in Table III–29. The agencies are not adopting standards reflecting Alternative 2, because as already described, technically feasible standards are available that provide for greater emission reductions and reduced fuel consumption than provided under Alternative 2. The agencies are not adopting standards reflecting Alternative 4 or Alternative 5 in their entirety because we do not believe to be feasible considering lead time and other relevant factors. However, we note that the tractor standards are predicated on the adoption of engine technology beyond what was projected in Alternative 4 of the NPRM. In addition, the final rule stringency includes additional technologies for tractors that were not considered in any of the alternatives analyzed in the NPRM—axle efficiency, transmission efficiency, adjustable automatic engine shutdown systems, and tire pressure monitoring systems.

TABLE III–29—SUMMARY OF ALTERNATIVES CONSIDERED FOR THE FINAL RULEMAKING

Alternatives 1a and 1b	No action alternatives
Alternative 2 .....	Less Stringent than the Preferred Alternative applying off-the-shelf technologies.
Preferred Alternative .....	Final Phase 2 standards, fully phased-in by 2027 MY.
Alternative 4 .....	Alternative presented in the NPRM that pulls ahead the proposed 2027 MY standards to 2024 MY.
Alternative 5 .....	Alternative based on very high market adoption of advanced technologies.

E. Phase 2 Compliance Provisions for Tractors

In HD Phase 1, the agencies developed an entirely new program to assess the CO<sub>2</sub> emissions and fuel consumption of tractors. The agencies are carrying over many aspects of the Phase 1 compliance approach, but we are also adopting changes to enhance several aspects of the compliance program. The sections below highlight the key areas that are the same and those that are different.

(1) HD Phase 2 Compliance Provisions That Remain the Same

The overall Phase 2 regulatory structure is discussed in more detail above in Section II. This section discusses tractor-specific compliance provisions.

(a) Application and Certification Process

For the Phase 2 final rule, the agencies are keeping many aspects of the HD Phase 1 tractor compliance program. For example, the agencies will continue to use GEM (as revised for Phase 2), in coordination with

additional component testing by manufacturers to determine the inputs, to determine compliance with the fuel efficiency and CO<sub>2</sub> standards. Another aspect that we are carrying over is the overall compliance approach. EMA’s and the HD manufacturers’ comments supported the continued use of GEM and did not support chassis-based certification.

In Phase 1 and as finalized in Phase 2, the general compliance process in terms of the pre-model year, during the model year, and post model year activities remains unchanged. The manufacturers will be required to apply

<sup>293</sup> See RIA Chapter 7.2.4.

<sup>294</sup> Auto Remarketing. Length of Ownership Returning to More Normal Levels; New Registrations Continue Slow Climb. April 1, 2013. Last accessed on February 26, 2015 at <http://www.autoremarketing.com/trends/length-ownership-returning-more-normal-levels-new-registrations-continue-slow-climb>.

<sup>295</sup> North American Council for Freight Efficiency. Barriers to Increased Adoption of Fuel Efficiency Technologies in Freight Trucking. July 2013. Page 24.

<sup>296</sup> See RIA Chapter 7.2.5 and Memo to Docket “Tractor-Trailer Cost per Ton Values.” July 2016. EPA–HQ–OAR–2014–0827.

<sup>297</sup> If using a cost effectiveness metric that treats fuel savings as a negative cost, net costs per ton of GHG emissions reduced or per gallon of avoided fuel consumption will be negative under these standards.

for certification through a single source, EPA, with limited sets of data and GEM results (see 40 CFR 1037.205). EPA will issue certificates upon approval based on information submitted through the VERIFY database (see 40 CFR 1037.255). In Phase 1, EPA and NHTSA jointly review and approve innovative technology requests, *i.e.* performance of any technology whose performance is not measured by the GEM simulation tool and is not in widespread use in the 2010 MY. For Phase 2, the agencies are adopting a similar process for allowing credits for off-cycle technologies that are not measured by the GEM simulation tool, although the revised GEM now recognizes many more technologies than the Phase 1 version of GEM, notably drivetrain and transmission improvements, so fewer technologies would be candidates for off-cycle credits (see Section I.B.v. for a more detailed discussion of off-cycle requests). During the model year, the manufacturers will continue to generate certification data and conduct GEM runs on each of the vehicle configurations it builds. After the model year ends, the manufacturers will submit end of year reports to EPA that include the GEM results for all of the configurations it builds, along with credit/deficit balances if applicable (see 40 CFR 1037.250 and 1037.730). EPA and NHTSA will jointly coordinate on any enforcement action required.

#### (b) Compliance Requirements

As proposed in Phase 2, the agencies did not adopt any provisions in the final Phase 2 rules that significantly change the following Phase 1 provisions:

- Useful life of tractors (40 CFR 1037.105(e) and 1037.106(e)) although added for NHTSA in Phase 2 (49 CFR 535.5)
- Emission-related warranty requirements (40 CFR 1037.120)
- Maintenance instructions, allowable maintenance, and amending maintenance instructions (40 CFR 1037.125 and 137.220)
- Deterioration factors (40 CFR 1037.205(l) and 1037.241(c))
- Vehicle family, subfamily, and configurations (40 CFR 1037.230), except for the addition of a heavy-haul family in Phase 2

#### (c) Drive Cycle Speed Targets and Weightings

In Phase 1, the agencies adopted three drive cycles used in GEM to evaluate the fuel consumption and CO<sub>2</sub> emissions from various vehicle configurations. One of the cycles is the Transient mode of the California ARB Heavy Heavy-Duty Truck 5 Mode cycle. It is intended to broadly cover urban

driving. The other two cycles represent highway driving at 55 mph and 65 mph.

The agencies proposed to maintain the existing Phase 1 drive cycle speed traces and weightings in Phase 2. In the Phase 2 proposal sleeper cab weightings would remain 5 percent of the Transient cycle, 9 percent of the 55 mph cycle, and 86 percent of the 65 mph cycle. The day cabs would be weighted based on 19 percent of the transient cycle, 17 percent of the 55 mph cycle, and 64 percent of the 65 mph cycle (see proposed 40 CFR 1037.510(c) and 80 FR 40242). In response to the Phase 2 NPRM, the American Trucking Associations (ATA) submitted comments based on spot speed records throughout the month of May 2015. This study found that Class 8 trucks operated at speeds of 55 mph or less 57 percent of the time. United Parcel Service (UPS) stated that their Class 8 tractor-trailers average 54 miles per hour in part because they use vehicle speed limiters in their fleet. UPS also shared ATA's comments on the spot speed records. Daimler stated that they did not see a benefit of increasing the amount of low speed operation for tractors, unless the EPA-NREL work supported the need for a change.

The agencies considered these comments along with the information that was used to derive the drive cycle weightings in Phase 1. The agencies did not receive any new drive cycle weighting data for tractors from the EPA-NREL work. The agencies believe that the study cited by ATA includes weightings of speed records, which represent the fraction of *time* spent at a given speed. However, our drive cycle weightings represent the fraction of *vehicle miles traveled* (VMT). The agencies used the vehicle speed information provided in the ATA comments and translated the weightings to VMT. Based on our assessment shown in RIA Chapter 3.4.3, their findings produce weightings that are approximately 74 percent of the vehicle miles traveled are at speeds greater than 55 mph and 26 percent less than 55 mph. In addition, the study cited by ATA represents "Class 8 trucks" which would include day cab tractors, sleeper cab tractors, and heavy heavy-duty vocational trucks. Based on this assessment, the agencies do not believe this new information is significantly different than the drive cycle weightings that were proposed. Therefore, we are adopting the drive cycle weightings for tractors that we adopted for Phase 1 and proposed for Phase 2.

Both in the Phase 1 program and as proposed in the Phase 2 program, the 55 mph and 65 mph drive cycles used in

GEM assume a constant target speed with downshifting occurring if road incline causes a predetermined drop in vehicle speed. In real-world vehicle operation, traffic conditions and other factors may cause periodic operation at lower (*e.g.* creep) or variable vehicle speeds. In the Phase 2 NPRM, the agencies requested comment on the need to include segments of lower or variable speed operation in the nominally 55 mph and 65 mph drive cycles used in GEM and how this may or may not impact the strategies manufacturers would develop. 80 FR 80242.

In response, ACEEE commented that NREL found that constant speeds on positive and negative grades misrepresent the real world operation of HD trucks because there is a strong correlation between road grade and average speed. Daimler commented that for regulatory purposes using a constant speed cycle with representative road grade is appropriate, noting as well that some manufacturers use a constant speed cycle in their internal development processes and have found it correlates well to real world operation. They also highlight the concern that it would be extremely difficult to develop traffic patterns that represent a national average. However, Daimler also stated in their comments that they do see a benefit of allowing increased variability in the vehicle speeds in the 55 and 65 mph cycles, for evaluating the effectiveness of technologies such as predictive cruise control.

After considering these comments and evaluating the final Phase 2 version of GEM, the agencies are adopting in the Phase 2 final rules constant target speed for the 55 mph and 65 mph cycles, as adopted in Phase 1. One key difference in Phase 2 is the addition of road grade in these cruise cycles, as discussed below in Section III.E.2. The addition of road grade to the cruise cycles brings the GEM simulation of vehicles over the drive cycles closer to the real world operation described by ACEEE and Daimler. Even though the cruise cycles will continue to have constant target speeds (55 mph or 65 mph), the vehicle may slow down from the target speed of the cycle on an uphill stretch of road due to the addition of road grade in the Phase 2 cycles. If the vehicle does slow down, the transmission shift logic built into GEM will downshift the transmission to limit the amount of further vehicle deceleration. Similarly, on the downhill portions of the cycles, the driver control logic built into GEM will allow the vehicle to exceed the

target speed by 3 mph prior to braking the vehicle.

(d) Empty Weight and Payload

The total weight of the tractor-trailer combination is the sum of the tractor curb weight, the trailer curb weight, and the payload. The total weight of a vehicle is important because it in part determines the impact of technologies, such as rolling resistance, on GHG emissions and fuel consumption. In Phase 2, we proposed to carry over the total weight of the tractor-trailer combination used in GEM for Phase 1. The agencies developed the tractor curb weight inputs for Phase 2 from actual tractor weights measured in two of EPA’s Phase 1 test programs. The trailer curb weight inputs were derived from actual trailer weight measurements conducted by EPA and from weight data provided to ICF International by the trailer manufacturers.<sup>298</sup> We welcomed comment on the tractor weights we proposed.

Daimler commented that there is a large spread of weights within a subcategory given the variety of different features that a vehicle might incorporate in order to perform its task. The agencies’ proposed curb weights for tractors may be higher than Daimler’s vehicles but in Daimler’s opinion align with some of their competitors’ vehicles, and therefore are reasonable. Based on no negative comment or newer data, the agencies are adopting the Phase 1 tractor curb weights, as proposed.

There is a further issue of what payload weight to assign during compliance testing. In use, trucks

operate at different weights at different times during their operations. The greatest freight transport efficiency (the amount of fuel required to move a ton of payload)—would be achieved by operating trucks at the maximum load for which they are designed all of the time. However, this may not always be practicable. Delivery logistics may dictate partial loading. Some payloads, such as potato chips, may fill the trailer before it reaches the vehicle’s maximum weight limit. Or full loads simply may not be available commercially. M.J. Bradley analyzed the Truck Inventory and Use Survey and found that approximately 9 percent of combination tractor miles travelled empty, 61 percent are “cubed-out” (the trailer volume is full before the weight limit is reached), and 30 percent are “weighed out” (operating weight equals 80,000 lbs which is the gross vehicle weight limit on the Federal Interstate Highway System or greater than 80,000 lbs for vehicles traveling on roads outside of the interstate system).<sup>299</sup>

The amount of payload that a tractor can carry depends on the category (or GVWR and GCWR) of the vehicle. For example, a typical Class 7 tractor can carry less payload than a Class 8 tractor. For Phase 1, the agencies used the Federal Highway Administration Truck Payload Equivalent Factors using Vehicle Inventory and Use Survey (VIUS) and Vehicle Travel Information System data to determine the payloads. FHWA’s results indicated that the average payload of a Class 8 vehicle ranged from 36,247 to 40,089 lbs, depending on the average distance travelled per day.<sup>300</sup> The same study

shows that Class 7 vehicles carried between 18,674 and 34,210 lbs of payload also depending on average distance travelled per day. Based on these data, the agencies proposed to continue to prescribe a fixed payload of 25,000 lbs for Class 7 tractors and 38,000 lbs for Class 8 tractors for certification testing for Phase 2. The agencies also proposed to continue to use a common payload for Class 8 day cabs and sleeper cabs as a predefined GEM input because the data available do not distinguish among Class 8 tractor types. These payload values represent a heavily loaded trailer, but not maximum GVWR, since as described above the majority of tractors “cube-out” rather than “weigh-out.”

The agencies requested comments and data to support changes to our proposed payloads for Phase 2. 80 FR 40242. Daimler commented that the payload weight is even more difficult to determine because weights change based on economic conditions, such as when carriers continue to try to reduce their dead volume and increase their weight per load. Daimler suggested that the agencies might consider increasing the proposed payloads, but did not provide data. In the absence of newer data or other compelling comments, the agencies continue to believe that it is appropriate to continue using the Phase 1 tractor payloads for all of the Class 7 and 8 tractors, as proposed, except for heavy-haul.

Details of the predefined weights by regulatory subcategory, as shown in Table III–30, are included in RIA Chapter 3.

TABLE III–30—FINAL COMBINATION TRACTOR WEIGHT INPUTS

Model type	Regulatory subcategory	Tractor tare weight (lbs)	Trailer weight (lbs)	Payload (lbs)	Total weight (lbs)
Class 8	Sleeper Cab High Roof	19,000	13,500	38,000	70,500
Class 8	Sleeper Cab Mid Roof	18,750	10,000	38,000	66,750
Class 8	Sleeper Cab Low Roof	18,500	10,500	38,000	67,000
Class 8	Day Cab High Roof	17,500	13,500	38,000	69,000
Class 8	Day Cab Mid Roof	17,100	10,000	38,000	65,100
Class 8	Day Cab Low Roof	17,000	10,500	38,000	65,500
Class 7	Day Cab High Roof	11,500	13,500	25,000	50,000
Class 7	Day Cab Mid Roof	11,100	10,000	25,000	46,100
Class 7	Day Cab Low Roof	11,000	10,500	25,000	46,500
Class 8	Heavy-Haul	19,000	13,500	86,000	118,500

<sup>298</sup> ICF International. Investigation of Costs for Strategies to Reduce Greenhouse Gas Emissions for Heavy-Duty On-road Vehicles. July 2010. Pages 4–15. Docket Number EPA–HQ–OAR–2010–0162–0044.

<sup>299</sup> M.J. Bradley & Associates. Setting the Stage for Regulation of Heavy-Duty Vehicle Fuel Economy and GHG Emissions: Issues and Opportunities. February 2009. Page 35. Analysis based on 1992 Truck Inventory and Use Survey data, where the survey data allowed developing the distribution of loads instead of merely the average loads.

<sup>300</sup> The U.S. Federal Highway Administration. Development of Truck Payload Equivalent Factor. Table 11. Last viewed on March 9, 2010 at [http://ops.fhwa.dot.gov/freight/freight\\_analysis/faj/faf2\\_reports/reports9/s510\\_11\\_12\\_tables.htm](http://ops.fhwa.dot.gov/freight/freight_analysis/faj/faf2_reports/reports9/s510_11_12_tables.htm).

## (e) Tire Testing

In Phase 1, manufacturers are required to input their tire rolling resistance coefficient into GEM. Also in Phase 1, the agencies adopted the provisions in ISO 28580 to determine the rolling resistance of tires. As described in 40 CFR 1037.520(c), the agencies require that at least three tires for each tire design are to be tested at least one time. Our assessment of the Phase 1 program to date indicates that these requirements reasonably balance the need for precision, repeatability, and testing burden. Therefore we proposed to carry over the Phase 1 testing provisions for tire rolling resistance into Phase 2. 80 FR 40243. We welcomed comments regarding the tire testing provisions, but did not receive any. Therefore, based on the same reasoning presented at proposal, we are adopting the Phase 1 tire testing provisions in Phase 2.

In Phase 1, the agencies received comments from stakeholders highlighting a need to develop a reference lab and alignment tires for the HD sector. The agencies discussed the lab-to-lab comparison conducted in the Phase 1 EPA tire test program (80 FR 40243, citing to 76 FR 57184). The agencies reviewed the rolling resistance data from the tires that were tested at both the STL and Smithers laboratories to assess inter-laboratory and test machine variability. The agencies conducted statistical analysis of the data to gain better understanding of lab-to-lab correlation and developed an adjustment factor for data measured at each of the test labs. Based on these results, the agencies believe the lab-to-lab variation for the STL and Smithers laboratories will have very small effect on measured rolling resistance values. Based on the test data, the agencies judge for the HD Phase 2 program to continue to use the current levels of variability, and the agencies therefore proposed to allow the use of either Smithers or STL laboratories for determining the tire rolling resistance value. The agencies requested comment on the need to establish a reference machine for the HD sector and whether tire testing facilities are interested in and willing to commit to developing a reference machine. The agencies did not receive any comments on the issue. Therefore, again based on the reasoning presented at proposal, we are adopting the Phase 1 testing approach for Phase 2.

## (2) Key Differences in HD Phase 2 Compliance Provisions

The agencies are adopting certain provisions in Phase 2 that are significantly different from Phase 1. Details regarding some of these key changes such as aerodynamic assessments, road grade in the drive cycles, weight reduction, GEM inputs, emission control labels, and chassis dynamometer testing are provided in this subsection.

## (a) Aerodynamic Assessment

In Phase 1, the manufacturers conduct aerodynamic testing to establish the appropriate bin and GEM input for determining compliance with the CO<sub>2</sub> and fuel consumption standards. The agencies proposed to continue this general approach in HD Phase 2, but to make several enhancements to the aerodynamic assessment of tractors. As discussed below, we proposed some modifications to the aerodynamic test procedures—the addition of wind averaged drag in the aerodynamic assessment, the addition of trailer skirts to the standard trailer used to determine aerodynamic performance of tractors and revisions to the aerodynamic bins. As discussed in more detail in the following subsections, we are adopting many of the proposed Phase 2 aerodynamic test procedures, but with some additional revisions to the test procedures. These procedures are then appropriately reflected in the final Phase 2 aerodynamic bins.

## (i) Phase 1 Aerodynamic Test Procedures

The aerodynamic drag of a vehicle is determined by the vehicle's coefficient of drag (Cd), frontal area, air density and speed. Quantifying tractor aerodynamics as an input to the GEM presents technical challenges because of the proliferation of tractor configurations and subtle variations in measured aerodynamic values among various test procedures. In Phase 1, Class 7 and 8 tractor aerodynamic results are developed by manufacturers using a range of techniques, including wind tunnel testing, computational fluid dynamics, and constant speed tests.

We continue to believe a broad approach allowing manufacturers to use these multiple test procedures to demonstrate aerodynamic performance of its tractor fleet is appropriate given that no single test procedure is superior in all aspects to other approaches. However, we also recognize the need for consistency and a level playing field in evaluating aerodynamic performance. To address the consistency and level

playing field concerns, NHTSA and EPA adopted in Phase 1, while working with industry, an approach that identified a reference aerodynamic test method (coastdown) and a procedure to align results from other aerodynamic test procedures with the reference method by applying a correction factor ( $F_{alt-aero}$ ) to results from alternative methods. The Phase 1 regulations require manufacturers to use good engineering judgment in developing their corrections and specify some minimum testing requirements.

## (ii) Reference Aerodynamic Method in Phase 2

Based on feedback received during the development of Phase 1, we understood even before the Phase 2 NPRM was issued that there was interest from some manufacturers to change the reference method in Phase 2 from coastdown to constant speed testing. EPA conducted an aerodynamic test program at Southwest Research Institute to evaluate both methods in terms of cost of testing, testing time, testing facility requirements, and repeatability of results. Details of the analysis and results are included in RIA Chapter 3.2. The results showed that the enhanced coastdown test procedures and analysis produced results with acceptable repeatability and at a lower cost than the constant speed testing. Based on the results of this testing, the agencies proposed to continue to use the enhanced coastdown procedure for the reference method in Phase 2.<sup>301</sup> 80 FR 40244. However, we welcomed comment on the need to change the reference method for the Phase 2 final rule to constant speed testing, including comparisons of aerodynamic test results using both the coastdown and constant speed test procedures. In addition, we welcomed comments on and suggested revisions to the constant speed test procedure specifications set forth in the proposal in Chapter 3.2.2.2 of the draft RIA and 40 CFR 1037.533 in the proposed regulations (40 CFR 1037.534 in the final regulations).

Several stakeholders provided comments both in favor and against the use of coastdown as the reference aero method for Phase 2 for tractors. CARB does not support the constant speed test as the reference method until it can be demonstrated to be superior to the coastdown methods. Their concerns included the cost associated with vehicle modifications required in test preparation (such as the torque meters

<sup>301</sup> Southwest Research Institute. "Heavy Duty Class 8 Truck Coastdown and Constant Speed Testing." April 2015.



on the wheel hubs). Daimler did not support a change to constant speed testing for the reference method and stated that more time is needed to determine if constant speed testing would be a better alternative. Navistar supports the coastdown as the reference method and does not believe constant speed testing should be adopted even as an alternative, unless significant further work is conducted. EMA stated that they could not support the adoption of constant speed testing as the reference method in Phase 2 because there is insufficient time in the process to properly study whether constant speed is equivalent to or better than coastdown testing. Further, EMA recommended that constant speed testing be included only as a potential alternative to be phased in at a future date if appropriate. Volvo opposed a change in the aerodynamic reference test method to constant speed at this time due to insufficient time to fully evaluate the new test method.

Exa supported the use of constant speed testing as a reference method because it is a real-world measurement with the ability to evaluate wind-averaged drag. Exa also cited some concerns that coastdown is limited to near zero wind yaw angle and does not accurately represent the aerodynamics experienced on the road. MEMA supported including the constant speed test based on research that has demonstrated that it is reliable relative to coastdown tests and is required in European aerodynamic test protocols. SABIC commented that constant speed testing may help isolate the aerodynamic drag from vibration, mechanical, and friction encountered at low speeds. SABIC also cited research that suggested constant speed testing may provide better repeatability than coastdown tests, and suggested that the U.S. may be able to promote harmonization with the required European constant speed testing.

After consideration of the comments, the agencies are continuing to use the Phase 1 approach of setting coastdown testing as the reference method for tractor aerodynamic assessment in Phase 2. After developing revised coastdown test procedures and data analysis methods for the final rule, we have concluded that coastdown testing continues to produce acceptable repeatability and can be conducted at a lower cost than constant speed testing. However, we are finalizing some revisions to the Phase 2 coastdown test procedures in response to comments and discussed below. The agencies are also continuing to allow alternative test methods to be used to determine the

aerodynamic performance of tractors in Phase 2, as long as the results are correlated back to the reference method using a correlation factor (Falt-aero). Additional details are included in the Falt-aero discussion below.

#### (iii) Coastdown Test Procedure Changes for Phase 2

The agencies worked closely with the tractor manufacturers between the Phase 2 NPRM and final rulemaking to develop robust coastdown test procedures that are technically sound.<sup>302</sup> EPA also continued to test additional tractors after the proposal to better inform the test procedure development. Based on this work, the agencies are adopting aerodynamic test procedures that have been improved from those proposed for Phase 2. The details of these procedures and their development are included in RIA Chapter 3.2. Below is a summary of the changes to the coastdown test procedures and data analysis method for the final rule.

The coastdown test procedure changes include the tested speed range, the calibration of the equipment, and specification of yaw and air speed measurements. The agencies proposed two test speed ranges for coastdown testing—70 to 60 mph and 25 to 15 mph. EPA's evaluation of the  $C_{dA}$  values in relation to yaw angle showed that the 25 to 15 mph low-speed range specified in the NPRM test procedures produced yaw curves that were flatter than expected and flatter than demonstrated using other test methods, such as wind tunnels and CFD. Upon further analysis, EPA found that by reducing the low-speed range to even lower speeds, the yaw curve results were more representative. The best speed range to alleviate this concern is a 15 to 5 mph low speed range; however, requiring this would significantly reduce the number of available days for testing in a given year because it would lead to a wind speed limit of 3 mph. Therefore, the agencies are adopting a low speed range of 20 to 10 mph to balance the yaw curve representativeness with the real world testing implications. Along with this test speed change, the component of the wind speed parallel to the road or track will be limited to less than or equal to 6 mph. The agencies are adopting Phase 2 coastdown test procedures that specify the yaw measurement method resolution and accuracy requirements similar to those proposed for constant

speed testing. The calibration of the yaw and air speed equipment will be conducted in a point-by-point manner for each run.

The coastdown data analysis changes include the analysis of low speed pairs and filtering methods, adjustments for rear axle losses and rolling resistance, and determination of the final  $C_{dA}$  value for coastdown. EPA found that the method proposed to analyze the coastdown results of paired runs leads to an unexpected yaw curve asymmetry. Upon further evaluation, EPA found that the yaw curve asymmetry is mitigated by averaging the road load force and air speed from every two opposite direction low-speed segments and using the average with each of the high speed segments in the data analysis. Therefore, the agencies are adopting this method for the Phase 2 final rules. The filtering of the air speed, yaw, vehicle speed, and track wind speed is necessary to remove outliers and replace the data with the moving median value to reduce the variability of coastdown test results. The agencies are specifying this filtering method in the final rules. Coastdown testing measures all of the losses associated with the vehicle, including aerodynamics, rolling resistance, and axle spin losses. To isolate the aerodynamic  $C_{dA}$ , it is important to remove the losses associated with drive axle and tire rolling resistance. For the final Phase 2 rules, the agencies are adopting the SAE J2452 test procedures that require manufacturers to measure the speed dependence of the tire rolling resistance for each of the steer, drive, and trailer tire models used on the article undergoing a coastdown test. The agencies are also requiring that manufacturers measure the speed dependence of the drive axle spin losses for the drive axle model used in the article undergoing a coastdown test using a subset of the rear axle efficiency test procedure being adopted in Phase 2.

The agencies have also developed a process of identifying and removing coastdown test result outliers for the final rules. First, the median yaw angle of the data is determined. All results outside of a range of plus or minus 1 yaw degree are removed. Then the mean  $C_{dA}$  value of the remaining data points is determined.  $C_{dA}$  values that lie outside of plus or minus two standard deviations from the  $C_{dA}$  mean are removed. At least 24 data points are needed after removal of outliers for the results to be valid. Finally, the mean  $C_{dA}$  and mean effective yaw angle are calculated from the remaining points. These values are then used to adjust to reflect a 4.5 degree yaw angle result

<sup>302</sup> Memo to Docket, Aerodynamic Subteam Meetings with EMA, July 2016. Docket EPA-HQ-OAR-2014-0827.

based on an alternate method yaw curve results.

(iv) Improving Correlation of Coastdowns With Alternative Methods ( $F_{alt-aero}$ )

As already noted, the agencies adopted in Phase 1 a coastdown procedure as the reference method (see 40 CFR 1066.310) and defined a process for manufacturers to align drag results from each of their own alternative test methods to the reference method results using  $F_{alt-aero}$  (see 40 CFR 1037.525).<sup>303</sup> Manufacturers are able to use any aerodynamic evaluation method in demonstrating a vehicle's aerodynamic performance as long as they obtain our prior approval and the method is aligned to the reference method. The agencies proposed to continue to use this alignment method approach in Phase 2 to maintain the testing flexibility that manufacturers have today. However, the agencies proposed to increase the rigor in determining the  $F_{alt-aero}$  for Phase 2, including enhancing the minimum testing requirements. Beginning in MY 2021, we proposed that the manufacturers would be required to determine a new  $F_{alt-aero}$  for each of their tractor models for each aerodynamic test method. In Phase 1, manufacturers are required to determine their  $F_{alt-aero}$  using only a high roof sleeper cab with a full aerodynamics package (see 40 CFR 1037.521(a)(2) and proposed 40 CFR 1037.525(b)(2)). In Phase 2, we proposed that manufacturers would be required to determine a unique  $F_{alt-aero}$  value for each major model of their high roof day cabs and high roof sleeper cabs. In Phase 2, we proposed that manufacturers may carry over the  $F_{alt-aero}$  value until a model changeover or based on the agencies' discretion to require up to six new  $F_{alt-aero}$  determinations each year. We requested comment on the amount of testing required to accurately develop a  $F_{alt-aero}$  value and the burden associated with it. See 80 FR 40244.

The agencies received comments with regard to the need of  $F_{alt-aero}$  and the burden of determining it. Exa Corporation (a supplier of CFD software) commented that it is not clear that the  $F_{alt-aero}$  factor would alleviate challenges associated with their expectation that the absolute drag values will differ substantially between different test methods and different facilities. Exa suggested that the agencies require a

certification procedure for an alternate tool that includes a broad validation suite including different types of vehicles from aerodynamic sleeper to less aerodynamic day cabs. The HD vehicle manufacturers strongly recommended that the agencies reduce the number of coastdown tests that must be conducted each year. Navistar commented that only one  $F_{alt-aero}$  should be required for Phase 2. Navistar's testing of their ProStar sleeper and day cabs found that the  $F_{alt-aero}$  only differed within less than one percent using the same test facility. Navistar also commented that the data in the Phase 2 NPRM draft RIA show that three different sleepers show  $F_{alt-aero}$  values within 0.4 percent. EMA commented that only one  $F_{alt-aero}$  value should be required, as supported by the values shown in the Phase 2 Draft RIA where the  $F_{alt-aero}$  values were 1.09 +/- 0.02 for three tested vehicles. EMA also commented that the proposed requirements would be time-consuming, costly, and an unreasonable burden. Daimler supported EMA's comments. The HD vehicle manufacturers also submitted data to the agencies that show the  $F_{alt-aero}$  values were within a range of one percent. Volvo shared data with the agencies that support that  $F_{alt-aero}$  is highly consistent for varying truck models when correcting the test data under the conditions and methods that the industry has recommended. Volvo therefore concluded that multiple  $F_{alt-aero}$  values are not necessary for Phase 2. PACCAR provided results from three tractor models showing the spread of  $F_{alt-aero}$  is less than 0.3 percent.

The agencies determined the  $F_{alt-aero}$  values for all of the tractors tested using different aerodynamic methods for Phase 2 using the aerodynamic test procedures and data analysis finalized for Phase 2. As shown in further detail in RIA Chapter 3.2.1, the  $F_{alt-aero}$  values ranged between 1.13 and 1.20 for a single CFD software. Therefore, the agencies concluded that a single  $F_{alt-aero}$  value is not sufficient for determining the correlation of test methods for all tractors. Furthermore, based on the comments and further refinement of our selective enforcement audit (SEA) provisions in the Phase 2 final rule, we are adopting provisions that require manufacturers to determine  $F_{alt-aero}$  for a minimum of one day cab and one sleeper cab in MYs 2021, 2024, and 2027.<sup>304</sup> While this significantly reduces the test burden from the levels proposed, it also only represents a minimum requirement. The agencies

believe that the improvements to the SEA requirements for aerodynamics will further encourage the manufacturers to ensure that they are accurately reflecting the  $F_{alt-aero}$  for their entire tractor fleet and that they may do additional  $F_{alt-aero}$  determinations beyond the minimum requirement in Phase 2. Without confidence in their  $F_{alt-aero}$  values, manufacturers would risk SEA failures that could halt vehicle production. Even without failing the SEA overall, failing individual vehicles would lead to increased SEA testing. Thus, the SEA requirements will create a stronger incentive for manufacturers to use good engineering judgment for  $F_{alt-aero}$  values.

The agencies also received comments from HD manufacturers stressing that coastdown testing does not produce  $C_dA$  values at zero yaw as assumed. Even at calm test conditions, the resulting yaw angle is something greater than zero degrees. The agencies evaluated our aerodynamic test data and agree with the manufacturers. Therefore, we are adopting Phase 2 provisions that use the effective yaw angle from coastdown testing to determine the  $F_{alt-aero}$  value (see 40 CFR 1037.525). See RIA Chapter 3.2.2 for additional detail.

(v) Computational Fluid Dynamics

The agencies considered refinements to the computational fluid dynamics (CFD) modeling method to determine the aerodynamic performance of tractors in the NPRM. Specifically, we are considering whether the conditions for performing the analysis require greater specificity (e.g., wind speed and direction inclusion, turbulence intensity criteria value) or if turbulence model and mesh deformation should be required, rather than "if applicable," for all CFD analysis.<sup>305</sup> The agencies welcomed comment on the proposed revisions.

Daimler and EMA recommended that the agencies should raise the test speed for CFD from the proposed 55 mph to 65 mph to be consistent with GEM and the sleeper cab tractor weighting of 86 percent. Daimler supported the agencies' other proposed revisions to CFD test procedures.

The agencies agree with the suggested comment to include consistency between the test methods and are adopting CFD provisions that include a test speed of 65 mph, along with the other proposed revisions. The agencies finalized these changes through incorporation of the SAE J2966 CFD guidelines with exceptions and clarifications to keep other aspects of

<sup>303</sup>  $F_{alt-aero}$  is an experimentally determined factor that represents the ratio of coastdown results to results from the alternative method. The agencies allow other functional forms of the relationship consistent with good engineering judgment.

<sup>304</sup> See Section III.E.(2)(a)(ix) for details on the SEA requirements.

<sup>305</sup> 40 CFR 1037.532 "Using computational fluid dynamics to calculate drag area ( $C_dA$ )."

the CFD simulations consistent with Phase 1.

(vi) Wind Averaged Drag Determination

In Phase 1, EPA and NHTSA recognized that wind conditions, most notably wind direction, have a greater impact on real world CO<sub>2</sub> emissions and fuel consumption of heavy-duty trucks than of light-duty vehicles.<sup>306</sup> As noted in the NAS report, the wind average drag coefficient is about 15 percent higher than the zero degree coefficient of drag.<sup>307</sup> In addition, the agencies received comments in Phase 1 that supported the use of wind averaged drag results for the aerodynamic determination. The agencies considered adopting the use of a wind averaged drag coefficient in the Phase 1 regulatory program, but ultimately decided to finalize drag values which represent zero yaw (*i.e.*, representing wind from directly in front of the vehicle, not from the side) instead. We took this approach recognizing that the reference method is coastdown testing and it is not capable of determining wind averaged yaw.<sup>308</sup> Wind tunnels and CFD are currently the only tools to accurately assess the influence of wind speed and direction on a truck's aerodynamic performance. The agencies recognized, as NAS did, that the results of using the zero yaw approach may result in fuel consumption predictions that are offset slightly from real world performance levels, not unlike the offset we see today between fuel economy test results in the CAFE program and actual fuel economy performance observed in-use.

As the tractor manufacturers continue to refine the aerodynamics of tractors, we believe that continuing the zero yaw approach into Phase 2 would potentially impact the overall technology effectiveness or change the kinds of technology decisions made by the tractor manufacturers in developing equipment to meet our HD Phase 2 standards. Therefore, we proposed and are adopting aerodynamic test procedures that take into account the wind averaged drag performance of tractors. The agencies proposed to account for this change in aerodynamic test procedure by appropriately adjusting the aerodynamic bins to reflect a wind averaged drag result instead of a zero yaw result.

The agencies proposed and are adopting provisions that require manufacturers to adjust their C<sub>d</sub>A values

to represent a zero yaw value from coastdown and add the C<sub>d</sub>A impact of the wind averaged drag. The impact of wind averaged drag relative to a zero yaw condition can only be measured in a wind tunnel or with CFD. This requirement commences in MY 2021.

All stakeholders that commented on wind averaged drag supported its use over zero yaw. ACEEE supports the shift to the use of wind averaged drag in Phase 2. Exa supported the use of wind averaged drag because it is a better predictor of real world fuel economy. Michelin supported wind average drag assessments for a realistic and complete assessment of aerodynamic performance and would prevent the unintended consequence of incentivizing improvements that are better at zero wind conditions but sacrifice cross-wind performance. SABIC Innovative Plastics commented that it is imperative that wind effects be part of the standard due to the real-world impact of wind. Plastics Industry Trade Association supported wind average drag to better simulate real life conditions.

PACCAR and Daimler recommended the use of a surrogate angle of 4.5° in lieu of the nine angles required for a full wind averaged draft evaluation for CFD evaluated at 65 mph. PACCAR and Daimler provided data to support the use of a single angle. PACCAR also stated that there is significant CFD burden associated with the use of a nine angle yaw sweep. According to PACCAR in a given year, this would add approximately 4,000 additional simulations to their certification burden. EMA and other tractor manufacturers supported the single surrogate angle of 4.5° as being equivalent to the full yaw sweep result generated with SAE J1252.

As discussed in further detail in RIA Chapter 3.2.1.1.3, our data support that 4.5° results are a good surrogate for full wind averaged drag results for wind tunnel and CFD assessments. Therefore, we are adopting the 4.5° surrogate angle in Phase 2.

The agencies require that manufacturers use the following equation to make the necessary adjustments to a coastdown result to obtain the C<sub>d</sub>A<sub>wa</sub> value:

$$C_{dA_{wa}} = C_{dA_{effective\ yaw\ angle,\ coastdown}} * (C_{dA_{4.5^\circ}} / C_{dA_{effective\ yaw\ angle}})$$

If the manufacturer has a C<sub>d</sub>A value from either a wind tunnel or CFD, then they will use the following equation to obtain the C<sub>d</sub>A<sub>wad</sub> value:

$$C_{dA_{wa}} = C_{dA_{4.5^\circ}} * F_{alt-aero}$$

Because the agencies are adopting a 4.5° surrogate angle, the agencies are not adopting the proposed provisions that

manufacturers have the option of determining the offset between zero yaw and wind averaged yaw either through testing or by using the EPA-defined default offset.

(vii) Standard Trailer Definition

Similar to the approach the agencies adopted in Phase 1, NHTSA and EPA are adopting provisions such that the tractor performance in GEM is judged assuming the tractor is pulling a standardized trailer.<sup>309</sup> The agencies believe that an assessment of the tractor fuel consumption and CO<sub>2</sub> emissions should be conducted using a tractor-trailer combination, as tractors are invariably used in combination with trailers and this is their essential commercial purpose. Trailers, of course, also influence the extent of carbon emissions from the tractor (and vice-versa). We believe that using a standardized trailer best reflects the impact of the overall weight of the tractor-trailer and the aerodynamic technologies in actual use, and consequent real-world performance, where tractors are designed and used with a trailer. EPA research confirms what one intuit: Tractor-trailer pairings are almost always optimized, but this does not indicate that a tractor always uses the same trailer. EPA conducted an evaluation of over 4,000 tractor-trailer combinations using live traffic cameras in 2010.<sup>310</sup> The results showed that approximately 95 percent of the tractors were matched with the standard trailer specified (high roof tractor with dry van trailer, mid roof tractor with tanker trailer, and low roof with flatbed trailer). Therefore, the agencies are continuing the Phase 1 approach into Phase 2 GEM to use a predefined typical trailer in assessing overall performance for test purposes. As such, the high roof tractors will be paired with a standard dry van trailer; the mid roof tractors will be paired with a tanker trailer; and the low roof tractors will be paired with a flatbed trailer.

However, the agencies proposed a change to the definition of the standard dry van reference trailer used by tractor manufacturers to determine the aerodynamic performance of high roof tractors in Phase 2. We believe this is necessary to reflect the aerodynamic improvements experienced by the trailer fleet over the last several years due to influences from the California Air Resources Board mandate<sup>311</sup> and EPA's

<sup>309</sup> See 40 CFR 1037.501(g).

<sup>310</sup> See Memo to Docket, Amy Kopin. "Truck and Trailer Roof Match Analysis." August 2010.

<sup>311</sup> California Air Resources Board. Tractor-Trailer Greenhouse Gas regulation. Last viewed on

<sup>306</sup> See 2010 NAS Report, page 95.

<sup>307</sup> See 2010 NAS Report, Finding 2-4 on page 39. Also see 2014 NAS Report, Recommendation 3.5.

<sup>308</sup> See 2010 NAS Report, Page 95.

SmartWay Transport Partnership. The standard dry van trailer used in Phase 1 to assess the aerodynamic performance of high roof tractors is a 53 foot box trailer without any aerodynamic devices. In the development of Phase 2, the agencies evaluated the increase in adoption rates of trailer side skirts and boat tails in the market over the last several years and have seen a marked increase. We estimate that approximately 50 percent of the new trailers sold in 2018 will have trailer side skirts.<sup>312 313</sup> As the agencies look towards these tractor standards in the 2021 and beyond timeframe, we believe that it is appropriate to update the standard box trailer definition. In 2021–2027, we believe the trailer fleet will be a mix of trailers with no aerodynamics, trailers with skirts, and trailers with advanced aero; with the advanced aero being a very limited subset of the new trailers sold each year. Consequently, overall, we believe a trailer with a skirt will be the most representative of the trailer fleet for the duration of the regulation timeframe, and plausibly beyond. EPA has conducted extensive aerodynamic testing to quantify the impact on the coefficient of drag of a high roof tractor due to the addition of a trailer skirt. Details of the test program and the results can be found in RIA Chapter 3.2. The results of the test program indicate that on average, the impact of a trailer skirt matching the definition of the skirt specified in 40 CFR 1037.501(g)(1) is approximately eight percent reduction in drag area.

We proposed a definition of the standard dry van trailer in Phase 2—the trailer assumed during the certification process to be paired with a high roof tractor—that includes a trailer skirt starting in 2021 model year. 80 FR 40245. Even though the agencies proposed that new dry van trailer standards begin in 2018 MY, we did not propose to update the standard trailer in the tractor certification process until 2021 MY, to align with the new tractor standards. If we were to revise the standardized trailer definition for Phase 1, then we would have needed to revise the Phase 1 tractor standards. The details of the trailer skirt definition are included in 40 CFR 1037.501(g)(1). We

requested comment on our HD Phase 2 standard trailer configuration. We also welcomed comments on suggestions for alternative ways to define the standard trailer, such as developing a certified computer aided drawing (CAD) model.

The agencies received support in comments for adopting a reference trailer with skirts. Daimler supported the addition of side skirts to the Phase 2 reference trailer and stated that it aligns with their internal development process. Daimler also suggested that if the agencies believe there will be significant adoption of trailers with boat tails, then the agencies could update the  $C_dA$  bin value input to GEM and reduce it by 0.5 m<sup>2</sup> to reflect the actual on-road aerodynamics load without changing the standard trailer. The Plastics Industry Trade Association stated that the proposed reference trailer is representative of trailer aerodynamic improvements likely to emerge during Phase 2. Navistar suggested that the standard trailer should be more aerodynamic to reflect trailers that will be used during the life of Phase 2 tractors. ACEEE supports the use of a more aerodynamic reference trailer in Phase 2, however, they suggest an even more aerodynamic reference trailer be required that is closer to the aerodynamic packages projected to be installed on new trailers in 2027. ACEEE and UCS suggested that Phase 2 should facilitate the transition of promoting more tractor-trailer integration. ACEEE recommended providing manufacturers the option to test tractors with advanced trailers; correct the test result appropriately to account for the benefit provided by the trailer alone to promote integration of aerodynamically advanced tractors and trailers. UCS raised concerns that because tractors and trailers are interchangeable and that there is no guarantee that the Phase 2 tractors will pull the newest trailers, therefore, the agencies should not revise the standard trailer over the course of the rule.

The agencies re-evaluated the proposal to include trailer skirts on the Phase 2 reference trailer with consideration of the comments. Based on testing conducted to support the trailer portion of Phase 2, we found that on average a boat tail added to a dry van trailer with skirts reduces wind averaged  $C_dA$  by 0.6 m<sup>2</sup>.<sup>314</sup> We still project that the bulk of trailers that will be in operation during the life of tractors produced early in Phase 2 will be represented by the aerodynamic performance of a trailer with skirts. Therefore, we are adopting the reference

trailer as proposed. However, we also want to recognize that the trailer fleet will continue to evolve over the lifetime of tractors built and certified to Phase 2, especially from MY 2027 and later. We recognize that if we do not account for reduced aerodynamic loads in the real world, then we may not be appropriately evaluating the tractor powertrain. We considered changing the standard trailer in MY 2027; however, this would lead to significant testing burden for the manufacturers because they would have to determine new  $C_dA$  values for their entire fleet of tractors. Instead, we are adopting Phase 2 GEM that beginning in MY 2027 will take the  $C_dA$  input for each vehicle and reduce it by 0.3 m<sup>2</sup> to reflect the lower aerodynamic loads that are a mix of trailers with skirts and trailers with skirts and boat tails. This change has been accounted for in both the baseline and standard setting of the CO<sub>2</sub> emissions and fuel consumption values.

With respect to ACEEE's recommendation for the agencies to facilitate the transition to more integrated tractor-trailers, such as those demonstrated with SuperTruck, the agencies believe this would require a significant change in tractor-trailer logistics to encourage more matching of specific tractors to specific trailers in operation. We believe that this would be most appropriately handled through the Off-Cycle Credit program.

#### (viii) Aerodynamic Bins

The agencies proposed to continue the approach where the manufacturer would determine a tractor's aerodynamic drag force through testing, determine the appropriate predefined aerodynamic bin, and then input the predefined  $C_dA$  value for that bin into the GEM. 80 FR 40245. The agencies' Phase 2 aerodynamic bins reflect three changes to the Phase 1 bins—the incorporation of wind averaged drag, the addition of trailer skirts to the standard box trailer used to determine the aerodynamic performance of high roof tractors (as just explained above), and the addition of bins to reflect the continued improvement of tractor aerodynamics in the future. Because of each of these changes, the aerodynamic bins for Phase 2 are not directly comparable to the Phase 1 bins.

HD Phase 1 included five aerodynamic bins to cover the spectrum of aerodynamic performance of high roof tractors. Since the development of the Phase 1 rules, the manufacturers have continued to invest in aerodynamic improvements for tractors. This continued evolution of aerodynamic performance, both in

September 4, 2014 at <http://www.arb.ca.gov/msprog/truckstop/trailers/trailers.htm>.

<sup>312</sup> Ben Sharpe (ICCT) and Mike Roeth (North American Council for Freight Efficiency), "Costs and Adoption Rates of Fuel-Saving Technologies for Trailer in the North American On-Road Freight Sector," Feb 2014.

<sup>313</sup> Frost & Sullivan, "Strategic Analysis of North American Semi-trailer Advanced Technology Market," Feb 2013.

<sup>314</sup> See RIA Chapter 2.10.2.1.3.

production and in the research stage as part of the SuperTruck program, has consequently led the agencies to propose two additional aerodynamic technology bins (Bins VI and VII) for high roof tractors.

In both HD Phase 1 and Phase 2, aerodynamic Bin I through Bin V represent tractors sharing similar levels of technology. The first high roof aerodynamic category, Bin I, is designed to represent tractor bodies which prioritize appearance or special duty capabilities over aerodynamics. These Bin I tractors incorporate few, if any, aerodynamic features and may have several features that detract from aerodynamics, such as bug deflectors, custom sunshades, B-pillar exhaust stacks, and others. The second high roof aerodynamics category is Bin II, which roughly represents the aerodynamic performance of the average new tractor sold in 2010. The agencies developed this bin to incorporate conventional tractors that capitalize on a generally aerodynamic shape and avoid classic features that increase drag. High roof tractors within Bin III build on the basic aerodynamics of Bin II tractors with added components to reduce drag in the most significant areas on the tractor, such as integral roof fairings, side extending gap reducers, fuel tank fairings, and streamlined grill/hood/mirrors/bumpers, similar to 2013 model year SmartWay tractors. The Bin IV aerodynamic category for high roof tractors builds upon the Bin III tractor body with additional aerodynamic treatments such as underbody airflow treatment, down exhaust, and lowered ride height, among other technologies. HD Phase 1 Bin V tractors incorporate advanced technologies which are currently in the prototype stage of development, such as advanced gap reduction, rearview cameras to replace mirrors, wheel system streamlining, and advanced body designs. For HD Phase 2, the agencies proposed to segment the aerodynamic performance of these advanced technologies into Bins V through VII.

In Phase 1, the agencies adopted only two aerodynamic bins for low and mid roof tractors. The agencies limited the number of bins to reflect the actual range of aerodynamic technologies

effective in low and mid roof tractor applications. High roof tractors are consistently paired with box trailer designs, and therefore manufacturers can design the tractor aerodynamics as a tractor-trailer unit and target specific areas like the gap between the tractor and trailer. In addition, the high roof tractors tend to spend more time at high speed operation which increases the impact of aerodynamics on fuel consumption and GHG emissions. On the other hand, low and mid roof tractors are designed to pull variable trailer loads and shapes. They may pull trailers such as flat bed, low boy, tankers, or bulk carriers. The loads on flat bed trailers can range from rectangular cartons with tarps, to a single roll of steel, to a front loader. Due to these variables, manufacturers do not design unique low and mid roof tractor aerodynamics but instead use derivatives from their high roof tractor designs. The aerodynamic improvements to the bumper, hood, windshield, mirrors, and doors are developed for the high roof tractor application and then carried over into the low and mid roof applications. As mentioned above, the types of designs that will move high roof tractors from a Bin III to Bins IV through V include features such as gap reducers and integral roof fairings which will not be appropriate on low and mid roof tractors.

As Phase 2 looks to further improve the aerodynamics for high roof sleeper cabs, we believe it is also appropriate to expand the number of bins for low and mid roof tractors too. For Phase 2, the agencies proposed to differentiate the aerodynamic performance for low and mid roof applications with four bins, instead of two, in response to feedback received from manufacturers of low and mid roof tractors related to the limited opportunity to incorporate certain aerodynamic technologies in their compliance plan. However, upon further discussions with EMA, it became evident to the agencies that the most straightforward approach would be to include the same number of low and mid roof aero bins as we have for high

roof tractors.<sup>315</sup> Therefore, we are adopting seven aero bins for low and mid roof tractors in Phase 2. In addition, we proposed and are adopting provisions that allow low and mid roof tractor aerodynamic bins to be determined based on the aerodynamic bin of an equivalent high roof tractor, as shown below in Table III–31.

TABLE III–31—PHASE 2 REVISIONS TO 40 CFR 1037.520(b)(3)

High roof bin	Low and mid roof bin
Bin I .....	Bin I.
Bin II .....	Bin II.
Bin III .....	Bin III.
Bin IV .....	Bin IV.
Bin V .....	Bin V.
Bin VI .....	Bin VI.
Bin VII .....	Bin VII.

The agencies developed new high roof tractor aerodynamic bins for Phase 2 that reflect the change from zero yaw to wind averaged drag, the more aerodynamic reference trailer, and the addition of two bins. Details regarding the derivation of the high roof bins are included in RIA Chapter 3.2.1.2. The high roof bin values being adopted in the HD Phase 2 final rulemaking differ from those proposed due to the coastdown and other aerodynamic test procedures changes discussed above in Section III.E.2.a. However, as explained above in Section III.D.1, in both the NPRM and this final rulemaking, we developed the Phase 2 bins such that there is an alignment between the Phase 1 and Phase 2 aerodynamic bins after taking into consideration the changes in aerodynamic test procedures and reference trailers required in Phase 2. The Phase 2 bins were developed so that a tractor that performed as a Bin III in Phase 1 would also perform as a Bin III tractor in Phase 2. The high roof tractor bins are defined in Table III–32. The final revisions to the low and mid roof tractor bins reflect the addition of five new aerodynamic bins and are listed in Table III–33.

<sup>315</sup> Memo to Docket. Aerodynamic Subteam Meetings with EMA. July 2016. Docket EPA–HQ–OAR–2014–0827.

TABLE III-32—PHASE 2 AERODYNAMIC INPUT DEFINITIONS TO GEM FOR HIGH ROOF TRACTORS

	Class 7		Class 8	
	Day cab		Day cab	Sleeper cab
	High roof	High roof	High roof	High roof
<b>Aerodynamic Test Results (<math>C_dA_{wad}</math> in <math>m^2</math>)</b>				
Bin I .....	≥7.2	≥7.2	≥7.2	≥6.9
Bin II .....	6.6–7.1	6.6–7.1	6.3–6.8	6.3–6.8
Bin III .....	6.0–6.5	6.0–6.5	5.7–6.2	5.7–6.2
Bin IV .....	5.5–5.9	5.5–5.9	5.2–5.6	5.2–5.6
Bin V .....	5.0–5.4	5.0–5.4	4.7–5.1	4.7–5.1
Bin VI .....	4.5–4.9	4.5–4.9	4.2–4.6	4.2–4.6
Bin VII .....	≤4.4	≤4.4	≤4.1	≤4.1
<b>Aerodynamic Input to GEM (<math>C_dA_{wad}</math> in <math>m^2</math>)</b>				
Bin I .....	7.45	7.45	7.15	7.15
Bin II .....	6.85	6.85	6.55	6.55
Bin III .....	6.25	6.25	5.95	5.95
Bin IV .....	5.70	5.70	5.40	5.40
Bin V .....	5.20	5.20	4.90	4.90
Bin VI .....	4.70	4.70	4.40	4.40
Bin VII .....	4.20	4.20	3.90	3.90

TABLE III-33—PHASE 2 AERODYNAMIC INPUT DEFINITIONS TO GEM FOR LOW AND MID ROOF TRACTORS

	Class 7		Class 8			
	Day cab		Day cab		Sleeper Cab	
	Low roof	Mid roof	Low roof	Mid roof	Low roof	Mid roof
<b>Aerodynamic Test Results (<math>C_dA</math> in <math>m^2</math>)</b>						
Bin I .....	≥5.4	≥5.9	≥5.4	≥5.9	≥5.4	≥5.9
Bin II .....	4.9–5.3	5.5–5.8	4.9–5.3	5.5–5.8	4.9–5.3	5.5–5.8
Bin III .....	4.5–4.8	5.1–5.4	4.5–4.8	5.1–5.4	4.5–4.8	5.1–5.4
Bin IV .....	4.1–4.4	4.7–5.0	4.1–4.4	4.7–5.0	4.1–4.4	4.7–5.0
Bin V .....	3.8–4.0	4.4–4.6	3.8–4.0	4.4–4.6	3.8–4.0	4.4–4.6
Bin VI .....	3.5–3.7	4.1–4.3	3.5–3.7	4.1–4.3	3.5–3.7	4.1–4.3
Bin VII .....	≤3.4	≤4.0	≤3.4	≤4.0	≤3.4	≤4.0
<b>Aerodynamic Input to GEM (<math>C_dA</math> in <math>m^2</math>)</b>						
Bin I .....	6.00	7.00	6.00	7.00	6.00	7.00
Bin II .....	5.60	6.65	5.60	6.65	5.60	6.65
Bin III .....	5.15	6.25	5.15	6.25	5.15	6.25
Bin IV .....	4.75	5.85	4.75	5.85	4.75	5.85
Bin V .....	4.40	5.50	4.40	5.50	4.40	5.50
Bin VI .....	4.10	5.20	4.10	5.20	4.10	5.20
Bin VII .....	3.80	4.90	3.80	4.90	3.80	4.90

(ix) Selective Enforcement Audits (SEA) and Confirmatory Testing for Aerodynamics

EPA has long required manufacturers to perform SEAs to verify that actual production engines and vehicles conform to their certificates. Before this rulemaking, the regulations in 40 CFR 1037.301 provided generally for SEAs for Phase 1 vehicles, but did not provide specific descriptions of how such testing would be conducted for coastdowns. In Phase 1, we adopted interim provisions in 40 CFR 1037.150(k) that accounted for coastdown measurement variability by

allowing a compliance demonstration based on in-use test results if the drag area was at or below the maximum drag area allowed for the bin above the bin to which the vehicle was certified. Since adoption of Phase 1, EPA has conducted in-use aerodynamic testing and found that uncertainty associated with coastdown testing is less than anticipated.<sup>316</sup> In addition, as noted earlier in this Section III.E.(2)(a), we proposed and are adopting additional enhancements in the Phase 2 coastdown

<sup>316</sup> Southwest Research Institute. "Heavy Duty Class 8 Truck Coastdown and Constant Speed Testing." April 2015.

procedures to continue to reduce the variability of coastdown results, including the impact of environmental conditions. Therefore, we are sunseting the provision in 40 CFR 1037.150(k) at the end of the Phase 1 program (after the 2020 model year). In the NPRM, we proposed a conventional approach to conducting SEAs with respect to aerodynamics. See 80 FR at 40156 and proposed section 1037.301. We requested comment on whether or not we should factor in a test variability compliance margin into the aerodynamic test procedure, and

therefore requested data on aerodynamic test variability.

The agencies received comments from manufacturers arguing for the agencies to establish compliance margins that would allow actual production vehicles to exceed the standards by some fixed amount. These comments included specific requests for an aerodynamic compliance margin. We also received comments from UCS supporting the elimination of the aerodynamic compliance margin. As explained in Section I.C.1, although EPA sometimes provides interim compliance margins to facilitate the initial implementation of new programs, we generally do not consider such an approach to be an appropriate long-term policy. Nevertheless, EPA recognizes that compliance testing relying on coastdowns to evaluate aerodynamic parameters differs fundamentally from traditional compliance testing, in which test-to-test variability is normally expected to be small relative to production variability. With coastdown testing, however, test-to-test variability is expected to be larger relative to production variability. In response to comments addressing this difference, EPA developed a different structure for conducting SEAs to evaluate tractor  $C_dA$

and solicited supplemental comments on it. See 81 FR 10825. This new structure reflects an approach that would be consistent with the following principles:

- Test-to-test variability for individual coastdown runs can be high, so compliance determinations should be based on average values from multiple runs.
- Coastdown testing of a single vehicle is expensive and time consuming, so testing should focus more on repeat tests for the same vehicle than on tests for multiple vehicles. However, manufacturers should not be required to conduct more than 100 valid coastdown runs on any single vehicle.
- Compliance determinations should be based on whether or not the true value for the  $C_dA$  falls within the bin to which the vehicle was certified, rather than on whether or not the true value for the  $C_dA$  exceeds the value measured for certification.
- Given the limited ability to eliminate uncertainty, compliance determinations should consider the statistical confidence that a true value lies outside a bin.

Commenters were generally very supportive of these principles and the proposed structure.

We believe the structure being finalized appropriately balances EPA's need to provide strong incentives for manufacturers to act in good faith with manufacturers' need to avoid compliance actions based on inaccurate testing. Our current assessment is that, where a manufacturer acts in good faith when certifying and uses good engineering judgment throughout the process, false failures for individual vehicles would be rare and false failures for a family would not occur.

Under this approach, EPA would select a production vehicle for coastdown testing, and the manufacturer would be required to perform up to 100 valid coastdown runs to demonstrate whether or not the vehicle was certified to the correct bin. The coastdown results must be adjusted to a yaw angle of 4.5° using an alternate aerodynamic method. EPA will address uncertainty in the measurement using a confidence interval around the mean  $C_dA$  value, where the confidence interval will be calculated from the standard deviation of the  $C_dA$  values ( $\sigma$ ) and the number of runs ( $n$ ) according to the following equation:

$$\text{Confidence interval} = \text{mean} \pm \left( \frac{1.5 \cdot \sigma}{\sqrt{n}} + 0.03 \right)$$

For example, the result of the testing could be a  $C_dA$  value of  $5.90 \pm 0.09$ , which would fall entirely within Bin III for high roof sleeper cabs.<sup>317</sup> If the vehicle had been certified to Bin III or lower, this would be considered a passing test. If it had been certified to Bin IV or higher, this would be considered a failing test. For each vehicle that fails, the manufacturer would be required to test two additional vehicles up to a maximum of 11 vehicles. Manufacturers would have the option to select the same vehicle configuration, or they could choose to have EPA select another configuration within the family. It is appropriate to allow manufacturers the opportunity to retest the same failed configurations because they would only do so where there had reasonable confidence that the failure did not accurately reflect the true value.

The regulations require that manufacturers continue testing until the results are clearly either above or below the applicable bin boundary (*i.e.*, the confidence interval does not cross the boundary), or until 100 runs are completed. By making the confidence interval a function of the number of runs, it will generally become smaller as additional runs are completed, so that it would be increasingly likely to have a clear result as additional runs are completed. Nevertheless, there may be some cases where the results are close enough to the bin boundary that the confidence interval still crosses the boundary after 100 runs, meaning the true  $C_dA$  value could be slightly above or slightly below the bin boundary. The regulations will treat these results as passing.

It is important to note that, although SEAs are directed by EPA, the actual testing is conducted by the manufacturer at their chosen facilities. This minimizes many potential causes of test variability, such as differences in test trailers, test tracks, or

instrumentation. Thus confidence intervals need only reflect true test-to-test variability. Also, manufacturers generally rent facilities for coastdown testing as needed, which means EPA will need to provide some advance notice to allow the manufacturer to reserve the appropriate facility.

In selecting the original configuration and subsequent selections, EPA would likely consider vehicles with measured  $C_dA$  values near the top of the bin since they could be most likely to be mis-certified based on inaccurate results. However, EPA could select any configuration. For subsequent testing if the first vehicle fails, manufacturers would be allowed to retest the same configuration (but not the same exact vehicle). EPA believes this would not decrease the risk of failure for subsequent vehicles, but could allow a manufacturer the opportunity to show its design was actually compliant.

With respect to confirmatory testing, which is testing EPA conducts during certification rather than during production, EPA has generally

<sup>317</sup> As specified in 40 CFR 1037.305, bin boundaries for this determination are expressed to two decimal places and adjusted for rounding effects.

considered its test results to be the official test results. However, we recognize that we need to treat confirmation of a manufacturer's  $F_{alt-aero}$  differently because small changes in its value would be spread over an entire family. Therefore, EPA is adopting an interim provision that would apply the SEA confidence interval approach for confirmatory testing with respect to  $F_{alt-aero}$ . EPA would also attempt to use the same test trailers, test locations, and instrumentation that the manufacturer. Nevertheless, we expect to revisit this issue in the future.

#### (b) Road Grade in the Drive Cycles

Road grade can have a significant impact on the overall fuel economy of a heavy-duty vehicle. Table III-34 shows the results from a real world evaluation of heavy-duty tractor-trailers conducted by Oak Ridge National Lab.<sup>318</sup> The study found that the impact of a mild upslope of one to four percent led to a decrease in average fuel economy from 7.33 mpg to 4.35 mpg. These results are as expected because vehicles consume more fuel while driving on an upslope than driving on a flat road because the vehicle needs to exert additional power to overcome the grade resistance force.<sup>319</sup> The amount of extra fuel increases with increases in road gradient. On downgrades, vehicles consume less fuel than on a flat road. However, as shown in the fuel consumption results in Table III-34, the amount of increase in fuel consumption on an upslope is greater than the amount of decrease in fuel consumption on a downslope which leads to a net increase in fuel consumption. As an example, the data show that a vehicle would use 0.3 gallons per mile more fuel in a severe upslope than on flat terrain, but only save 0.1 gallons of fuel per mile on a severe downslope. In another study, Southwest Research Institute modeling found that the addition of road grade to a drive cycle has an 8 to 10 percent negative impact on fuel economy.<sup>320</sup>

TABLE III-34—FUEL CONSUMPTION RELATIVE TO ROAD GRADE

Type of terrain	Average fuel economy (miles per gallon)	Average fuel consumption (gallons per mile)
Severe upslope (>4%) ..	2.90	0.34
Mild upslope (1% to 4%) ..	4.35	0.23
Flat terrain (1% to 1%) ..	7.33	0.14
Mild downslope (-4% to -1%) ..	15.11	0.07
Severe downslope (≤4%) ..	23.50	0.04

In Phase 1, the agencies did not include road grade. However, we believe it is important to include road grade in Phase 2 to properly assess the value of technologies, such as downspeeding and the integration of the engine and transmission, which were not technologies included in the technology basis for Phase 1 and are not directly assessed by GEM in its Phase 1 iteration. The addition of road grade to the drive cycles is consistent with the NAS recommendation in the 2014 Phase 2 First Report.<sup>321</sup>

The U.S. Department of Energy and EPA partnered to support a project to develop the appropriate road grade profiles for the 55 mph and 65 mph highway cruise duty cycles that will be used in the certification of heavy-duty vehicles to the Phase 2 final GHG emission and fuel efficiency standards. The National Renewable Energy Laboratory (NREL) was contracted to do this work and has developed a database of activity-weighted percent road grades representative of U.S. limited-access highways. To this end, NREL used high-accuracy road grade data and county-specific vehicle miles traveled data. A report documenting this NREL work is in the public docket for these final rules.<sup>322</sup>

In the Phase 2 proposal, the agencies developed an interim road grade profile and provided information in the docket on two NREL-derived road grade profiles. The agencies proposed the inclusion of an interim road grade profile, in both the 55 mph and 65 mph cycles. The grade profile was developed by Southwest Research Institute on a 12.5 mile stretch of restricted-access highway during on-road tests conducted for EPA's validation of the Phase 2

version of GEM.<sup>323</sup> The agencies also included an additional road grade profile as part of the Notice of Data Availability (81 FR at 10825). The agencies sought comment on all of the road grade profiles.

Cummins supported the development of road grade and stated that the proposed road grade with  $\pm 2$  percent did not reflect their assessment of the distribution of North American roads with a distribution of road grades of  $\pm 6$  percent. ACEEE supported inclusion of road grade. Daimler, Navistar, EMA, Volvo, and Eaton commented that the road grade profile presented in the NODA were too steep and did not represent real world driving. Their primary concern was related to the fraction of time the engine spent at full load for various vehicle configurations. According to the manufacturers, the road grade cycle presented in GEM in the NODA spent too high of a fraction of time at full load.

After considering the road grade profile comments and using the NREL database, the agencies have independently developed a road grade profile for the final rules for use in the 55 mph and 65 mph highway cruise duty cycles for the Phase 2 final rulemaking. While based on the same road grade database generated by NREL for U.S. restricted-access highways, its design is predicated on a different approach. The development of this profile is documented in the RIA Chapter 3.4.2.1. The road grade in the final rules includes a stretch with zero percent grade and lower peak grades than the profile presented in the NODA. The minimum grade in the final cycle is -5 percent and the maximum grade is 5 percent. The cycle spends 46 percent of the distance in grades of  $\pm 0.5$  percent. Overall, the cycle spends approximately 66 percent of the time in relatively flat terrain with road gradients of  $\pm 1$  percent. A detailed discussion of the road grade profile is included in RIA Chapter 3.4.2.1.

#### (c) Heavy-Haul Provisions

The agencies proposed that heavy-haul tractors demonstrate compliance with the standards using the day cab drive cycle weightings of 19 percent transient cycle, 17 percent 55 mph cycle, and 64 percent 65 mph cycle. We also proposed that GEM simulates the heavy-haul tractors with a payload of 43

<sup>318</sup> Oakridge National Laboratory. Transportation Energy Book, Edition 33. Table 5.10 Effect of Terrain on Class 8 Truck Fuel Economy. 2014. Last accessed on September 19, 2014 at <http://cta.ornl.gov/data/Chapter5.shtml>.

<sup>319</sup> Ibid.

<sup>320</sup> Reinhart, T. (February 2016). *Commercial Medium- and Heavy-Duty (MD/HD) Truck Fuel Efficiency Technology Study—Report #2*. Washington, DC: National Highway Traffic Safety Administration. EPA-HQ-OAR-2014-0827-1623.

<sup>321</sup> National Academy of Science. "Reducing the Fuel Consumption and GHG Emissions of Medium- and Heavy-Duty Vehicles, Phase Two, First Report." 2014. Recommendation S.3 (3.6).

<sup>322</sup> See NREL Report "EPA Road Grade Profiles" for DOE-EPA Interagency Agreement to Refine Drive Cycles for GHG Certification of Medium- and Heavy-Duty Vehicles, IA Number DW-89-92402501.

<sup>323</sup> Southwest Research Institute. "GEM Validation," Technical Research Workshop supporting EPA and NHTSA Phase 2 Standards for MD/HD Greenhouse Gas and Fuel Efficiency—December 10 and 11, 2014. Can be accessed at <http://www3.epa.gov/otaq/climate/regs-heavy-duty.htm>.



tons and a total tractor, trailer, and payload weight of 118,500 lbs. In addition, we proposed that the engines installed in heavy-haul tractors meet the tractor engine standards included in 40 CFR 1036.108. We welcomed comments on these specifications.

Volvo does not agree with the proposal that the engine installed in a heavy-haul tractor must meet the tractor engine standard defined in 40 CFR 1036.108. As discussed below in Section III.E.2.i, we have modified 40 CFR 1037.601(a)(1) in this final rulemaking to remove the prohibition of using vocational engines in tractors.

(d) Weight Reduction

In Phase 1, the agencies adopted regulations that provided manufacturers with the ability to use GEM to measure emission reduction and reductions in fuel consumption resulting from use of high strength steel and aluminum components for weight reduction, and to do so without the burden of entering the curb weight of every tractor produced. We treated such weight reduction in two ways in Phase 1 to account for the fact that combination tractor-trailers weigh-out approximately one-third of the time and cube-out approximately two-thirds of the time. Therefore, one-third of the weight reduction is added payload in the denominator while two-thirds of the weight reduction is subtracted from the overall weight of the vehicle in GEM. See 76 FR 57153. The agencies also allowed manufacturers to petition for off-cycle credits for components not measured in GEM.

NHTSA and EPA proposed to carry the Phase 1 treatment of weight reduction into Phase 2. That is, these types of weight reduction, although not part of the agencies' technology packages for the final standards, can still be recognized in GEM up to a point. In addition, the agencies proposed to add additional thermoplastic components to the weight reduction table. The thermoplastic component weight reduction values were developed in coordination with SABIC, a thermoplastic component supplier. Also, in Phase 2, we proposed to

recognize the potential weight reduction opportunities in the powertrain and drivetrain systems as part of the vehicle inputs into GEM. Therefore, we believe it is appropriate to also recognize the weight reduction associated with both smaller engines and 6x2 axles.<sup>324</sup> We welcomed comments on all aspects of weight reduction. 80 FR 40249.

Several organizations suggested changes to specific weights proposed in the NPRM. The Aluminum Association cited several additional advancements in the aluminum industry and stated that the proposed table is appropriate when these components are considered for substitution on an individual basis. Aluminum Association also asked the agencies to add a 500 pound weight reduction for switching from steel to aluminum tractor cabs, among other components. Meritor supported the inclusion and expansion of the weight reduction technologies in the NPRM. Meritor suggested the aluminum carriers illustrate consistent weight reductions of 60 pounds for the rear-front-drive axle, 35 pounds for the rear-rear-drive axle and therefore 95 pounds for the tandem. Based on their data, Meritor recommends that a 42 pound weight savings be credited per tractor for using High-Strength steel drums on the steer (non-drive) axle and 74 pound per vehicle for 6x4 drive axle applications. Meritor anticipates the availability of an aluminum version of a brake bracket in the timeframe of the regulation which will provide a calculated per vehicle weight savings of 36 pounds for a 6x4 configuration. Meritor believes that weight savings should be credited for the use of single-piece drivelines in excess of 86" because today, most drivelines in excess of 86" are two piece. American Iron and Steel Institute commented that light weight values for high strength steel should be adjusted upward in the FRM, citing light duty vehicle weight reduction approaches using high strength steel and saying these improvements should apply to the heavy-duty sector as well. Daimler commented that increased credit should be given to hoods and fairings for the difference between steel and thermoplastic, but no specific values

were provided. PACCAR recommends that the agencies broaden the definition of "composite" to include materials other than thermoplastics, including thermoplastics, thermosets, and fiber reinforced plastics.

Some organizations commented against including some or all light-weight components for compliance with the tractor standards. American Iron and Steel Institute commented against the inclusion of any light-weight components as a compliance mechanism for tractors unless improved technical data to support the weight saving values are used. Daimler commented that the weight reduction values for engines less than 15 liters are arbitrary. Allison commented that the agencies should establish weight penalties for components that increase weight, and they used the example of MT/AMT with countershaft architectures.

We have expanded the list of weight reduction technologies for some steel and aluminum components for the final rule based on information provided in the comments. We did not adopt weight reduction values for some components, such as an axle carrier, because we are not confident that this is not double counting the weight reduction of the axles already provided in the regulations. We also did not adopt weight reduction values for technologies still in development, such as aluminum brake brackets. The agencies are not finalizing a weight penalty for any components since this would require detailed information on conventional and light-weight tractor components to establish a baseline and the weight reduction potential for each component. In addition, we are not broadening the definition of composite at this time to include materials other than thermoplastics because the specific weight reduction values in the table are specific to thermoplastics. We are adopting the values listed in Table III-35 and Table III-36 and making them available upon promulgation of the final Phase 2 rules (*i.e.*, available even under Phase 1). Additional weight reduction would be evaluated as a potential off-cycle credit.

TABLE III-35—PHASE 2 WEIGHT REDUCTION TECHNOLOGIES FOR TRACTORS

Weight reduction technology	Weight reduction
Wide-Based Single Drive Tire with:	
Steel Wheel .....	84 lbs. per wheel/tire set.
Aluminum Wheel/Aluminum Alloy Wheel .....	147 lbs. per wheel/tire set.

<sup>324</sup> North American Council for Freight Efficiency. "Confidence Findings on the Potential of 6x2 Axles." 2014. Page 16.

TABLE III-35—PHASE 2 WEIGHT REDUCTION TECHNOLOGIES FOR TRACTORS—Continued

Weight reduction technology	Weight reduction			
Wide-Based Single Trailer Tire with:				
Steel Wheel .....				84 lbs. per wheel/tire set.
Aluminum Wheel/Aluminum Alloy Wheel .....				131 lbs. per wheel/tire set.
Steer Tire or Dual Wide Drive Tire with:				
High Strength Steel Wheel .....				8 lbs. per wheel.
Aluminum Wheel/Aluminum Alloy Wheel .....				25 lbs. per wheel.

Weight reduction technologies	Steel (lb.)	Aluminum weight reduction (lb.)	High strength steel weight reduction (lb.)	Thermoplastic weight reduction (lb.)
Door (per door) .....		20	6	
Roof (per vehicle) .....		60	18	
Cab rear wall (per vehicle) .....		49	16	
Cab floor (per vehicle) .....		56	18	
Hood (per vehicle) .....		55	17	
Hood Support Structure (per vehicle) .....		15	3	
Hood and Front Fender (per vehicle) .....				65
Day Cab Roof Fairing (per vehicle) .....				18
Sleeper Cab Roof Fairing (per vehicle) .....		75	20	40
Aerodynamic Side Extender (per vehicle) .....				10
Fairing Support Structure (per vehicle) .....		35	6	
Instrument Panel Support Structure (per vehicle) .....		5	1	
Brake Drums—Drive (per 4) .....		140	74	
Brake Drums—Non Drive (per 2) .....		60	42	
Frame Rails (per vehicle) .....		440	87	
Crossmember—Cab (per vehicle) .....		15	5	
Crossmember—Suspension (per vehicle) .....		25	6	
Crossmember—Non Suspension (per 3) .....		15	5	
Fifth Wheel (per vehicle) .....		100	25	
Radiator Support (per vehicle) .....		20	6	
Fuel Tank Support Structure (per vehicle) .....		40	12	
Steps (per vehicle) .....		35	6	
Bumper (per vehicle) .....		33	10	
Shackles (per vehicle) .....		10	3	
Front Axle (per vehicle) .....		60	15	
Suspension Brackets, Hangers (per vehicle) .....		100	30	
Transmission Case (per vehicle) .....		50	12	
Clutch Housing (per vehicle) .....		40	10	
Drive Axle Hubs (per 4) .....		80	20	
Non Drive Front Hubs (per 2) .....		40	5	
Single Piece Driveline (for drivelines longer than 86") .....	43	63	43	
Driveshaft (per vehicle) .....		20	5	
Transmission/Clutch Shift Levers (per vehicle) .....		20	4	

TABLE III-36—PHASE 2 WEIGHT REDUCTION VALUES FOR OTHER COMPONENTS

Weight reduction technology	Weight reduction (lb)
6x2 axle configuration in tractors	300
4x2 axle configuration in Class 8 tractors .....	300
Tractor engine with displacement less than 14.0L .....	325 300

(e) GEM Inputs

The agencies proposed to continue to require the Phase 1 GEM inputs for

<sup>325</sup> Kenworth. "Kenworth T680 with PACCAR MX-13 Engine Lowers Costs for Oregon Open-Deck Carrier." Last viewed on December 16, 2014 at <http://www.kenworth.com/news/news-releases/2013/december/t680-cotc.aspx>.

tractors in Phase 2. These inputs include the following:

- Steer tire rolling resistance,
- Drive tire rolling resistance,
- Coefficient of Drag Area,
- Idle reduction,
- Weight reduction, and
- Vehicle Speed Limiter.

As discussed above in Section II.C and III.D, there are several additional inputs that we are adopting for Phase 2. The majority of these new inputs are the same as proposed, with the addition of two new optional inputs to account for transmission and axle efficiency improvements in response to comments. The new GEM inputs for Phase 2 include the following:

- Engine information including manufacturer, model, combustion type, fuel type, family name, and calibration identification,

- Engine steady state and cycle average fuel maps,
- Engine full-load torque curve,
- Engine motoring curve,
- Transmission information including manufacturer and model,
- Transmission type,
- Transmission gear ratios,
- Transmission loss map (optional),
- Drive axle(s) ratio,
- Axle power loss map (optional),
- Tire size (revolutions per mile) for drive tires, and
- Other technology inputs.

(f) Vehicle Speed Limiter Provisions

The agencies received comments during the development of Phase 1 that the Clean Air Act provisions to prevent tampering (CAA section 203(a)(3)(A)) of vehicle speed limiters and extended idle reduction technologies would prohibit

their use for demonstrating compliance with the Phase 1 standards. In Phase 1, the agencies adopted provisions to allow for discounted credits for idle reduction technologies that allowed for override conditions and expiring engine shutdown systems (see 40 CFR 1037.660). Similarly, the agencies adopted provisions to allow for “soft top” speeds and expiring vehicle speed limiters, and we did not propose to change those provisions (see 40 CFR 1037.640). However, as we developed Phase 2, we understood that the concerns still exist that the ability for a tractor manufacturer to reflect the use of a VSL in its compliance determination may be constrained by the demand for flexibility in the use of VSLs by the customers. The agencies welcomed suggestions on how to close the gap between the provisions that would be acceptable to the industry while maintaining our need to ensure that modifications do not violate section 203(a)(3)(A). We requested comment on potential approaches which would enable a feedback mechanism between the vehicle owner/fleet that would provide the agencies the assurance that the benefits of the VSLs will be seen in use but would also provide the vehicle owner/fleet the flexibility they may need during in-use operation. More generally, in our discussions with several trucking fleets and with the American Trucking Associations, an interest was expressed by the fleets if there was a means by which they could participate in the emissions credit transactions that are currently limited to the directly regulated truck manufacturers. VSLs were an example technology that fleets and individual owners can order for a new build truck, and for which, from the fleets’ perspective, the truck manufacturers receive emission credits. The agencies did not have a specific suggestion in the Phase 2 NPRM or a position on the request from the American Trucking Association and its members, but we requested comment on whether or not it is appropriate to allow owners to participate in the overall compliance process for the directly regulated parties, if such a thing is allowed under the two agencies’ respective statutes, and what regulatory provisions would be needed to incorporate such an approach. 80 FR 40250.

The agencies received comments regarding VSLs. ATA commented that the agencies should recognize in GEM VSLs set at speeds less than the speed limit mandated if a rule is adopted by NHTSA and FMCSA. ATA also suggested that the agencies should

explore ways of incorporating the in-use benefits being derived from VSLs, such as allowing manufacturers to accept a purchaser’s commitment to establish a maximum limited speed, as opposed to the tamper-proof option, when acknowledged and affirmed on a vehicle’s purchase agreement. ATA also suggested that the agencies allow manufacturers to adjust VSLs at the end of a vehicle’s lease or trade-in and allow the creation of deficits or credits if such adjustments affect the initial VSL effectiveness that was generated and allow trucking companies to adjust maximum speeds if company policies change during the ownership cycle with corresponding adjustment to manufacturer credits. CARB stated it is not clear what fleet owners would do with Phase 2 credits and allowing fleet owners to garner such credits would unnecessarily complicate implementation and enforcement of the Phase 2 program. As a result, CARB staff recommends not including owners in emission credit transactions for VSL installation. Daimler suggested that they report in their 270 day end of year report the number of VSLs that remain active. Daimler recommends that the agencies provide in GEM reduced effectiveness for non-regulatory VSLs in proportion to the fraction of non-regulatory ones that remained unaltered, based upon their study of their database. Volvo commented that approximately 15 percent of tractors built over 2013–2015 were shipped with their programmable road speed limiters set at less than 65 mph from the factory and 47 percent were reported in use with the same setting, even during a period of very low fuel prices. Volvo Group requests that the agencies consider providing an effectiveness value in GEM for reprogrammable speed limiters set at the factory at, or below 65 mph. UPS commented that instead of tamperproof VSLs, they would support a regulatory approach in which the fleet owner can adjust speed settings, but only if certified personnel make these changes and their activities within the ECIVIs are trackable and fully accountable to proper authorities.

The agencies considered the comments and the compliance burden associated with the suggestions. The agencies also considered DOT’s upcoming actions with respect to mandatory vehicle speed limiters for heavy-duty trucks. The existing Phase 1 VSL flexibilities provide opportunities for manufacturers to use VSL as a technology in GEM while still allowing the settings to change after an “expiration” time determined by the

manufacturer. At this time, we believe that the Phase 1 flexibilities sufficiently balance the desire to encourage technologies that reduce GHG emissions and fuel consumption while minimizing the compliance burden of trying to accommodate changes throughout the useful life of the vehicle. Therefore, the agencies are not adopting any new VSL provisions for Phase 2 and the Phase 1 provisions will continue (see 40 CFR 1037.640).

#### (g) Emission Control Labels

The agencies consider it crucial that authorized compliance inspectors are able to identify whether a vehicle is certified, and if so whether it is in its certified condition. To facilitate this identification in Phase 1, EPA adopted labeling provisions for tractors that included several items. The Phase 1 tractor label must include the manufacturer, vehicle identifier such as the Vehicle Identification Number (VIN), vehicle family, regulatory subcategory, date of manufacture, compliance statements, and emission control system identifiers (see 40 CFR 1037.135). In Phase 1, the emission control system identifiers are limited to vehicle speed limiters, idle reduction technology, tire rolling resistance, some aerodynamic components, and other innovative and advanced technologies.

The number of emission control systems for greenhouse gas emissions in Phase 2 has increased significantly. For example, all aspects of the engine transmission and drive axle; accessories; tire radius and rolling resistance; wind averaged drag; predictive cruise control; idle reduction technologies; and automatic tire inflation systems are controls that can be evaluated on-cycle in Phase 2 (*i.e.* these technologies’ performance can now be input to GEM), but could not be in Phase 1. Due to the complexity in determining greenhouse gas emissions as in Phase 2, the agencies do not believe that we can unambiguously determine whether or not a vehicle is in a certified condition through simply comparing information that could be made available on an emission control label with the components installed on a vehicle. Therefore, EPA proposed to remove the requirement to include the emission control system identifiers required in 40 CFR 1037.135(c)(6) and in Appendix III to 40 CFR part 1037 from the emission control labels for vehicles certified to the Phase 2 standards. However, the agencies requested comment on the appropriate content that would properly balance the need to limit label content with the interest in providing the most useful information for inspectors to

confirm that vehicles have been properly built. The agencies received comments on the emission control labels. Navistar supported the elimination of the emission control information from the vehicle GHG label. After considering the comments, EPA is finalizing the proposed tractor labeling requirements. Nevertheless, as described below we remain interested in finding a better approach for labeling.

Under the agencies' existing authorities, manufacturers must provide detailed build information for a specific vehicle upon our request. Our expectation is that this information should be available to us via email or other similar electronic communication on a same-day basis, or within 24 hours of a request at most. The agencies have started to explore ideas that would provide inspectors with an electronic method to identify vehicles and access on-line databases that would list all of the engine-specific and vehicle-specific emissions control system information. We believe that electronic and Internet technology exists today for using scan tools to read a bar code or radio frequency identification tag affixed to a vehicle that could then lead to secure on-line access to a database of manufacturers' detailed vehicle and engine build information. Our exploratory work on these ideas has raised questions about the level of effort that would be required to develop, implement and maintain an information technology system to provide inspectors real-time access to this information. We have also considered questions about privacy and data security. We requested comment on the concept of electronic labels and database access, including any available information on similar systems that exist today and on burden estimates and approaches that could address concerns about privacy and data security. Based on new information that we receive, we stated in the NPRM that we may consider initiating a separate rulemaking effort to propose and request comment on implementing such an approach.

#### (h) End of Year Reports

In the Phase 1 program, manufacturers participating in the ABT program provided 90 day and 270 day reports to EPA and NHTSA after the end of the model year. The agencies adopted two reports for the initial program to help manufacturers become familiar with the reporting process. For the HD Phase 2 program, the agencies proposed to simplify reporting such that manufacturers would only be required to submit the final report 90 days after the end of the model year with the

potential to obtain approval for a delay up to 30 days. We requested comments on this approach. EMA, PACCAR, Navistar, Daimler, and Cummins recommended keeping the 270 day report to allow sufficient time after the production period is completed. We are accordingly keeping both the 90 day and 270 day reports, with the ability of the agencies to waive the 90 day report.

#### (i) Other Compliance Provisions

In Phase 2, the agencies are adopting provisions to evaluate the performance of the engine, transmission, and drivetrain in determining compliance with the Phase 2 tractor standards. With the inclusion of the engine's performance in the vehicle compliance, EPA proposed to modify the prohibition to introducing into U.S. commerce a tractor containing an engine not certified for use in tractor (see proposed 40 CFR 1037.601(a)(1)). During development of the Phase 2 NPRM, we no longer saw the need to prohibit the use of vocational engines in tractors because the performance of the engine would be appropriately reflected in GEM. We welcomed comments on removing this prohibition.

The agencies received comments supporting the proposed approach. PACCAR supports removing the prohibition on the installation of vocational engines into tractors where these engines are appropriate for the customer's application. Daimler agreed with the proposal that with the engine properly represented in GEM, there is less need for the prohibition on vocational-only certified engines in tractors and that the true in-vehicle emissions are represented by the full-vehicle standard. Accordingly, we are modifying 40 CFR 1037.601(a)(1) in this final rulemaking to remove the prohibition of using vocational engines in tractors.

The agencies also proposed to change the compliance process for manufacturers seeking to use the off-road exclusion. During the Phase 1 program, manufacturers realized that contacting the agencies in advance of the model year was necessary to determine whether vehicles would qualify for exemption and need approved certificates of conformity. The agencies found that the petition process allowed at the end of the model year was not necessary and that an informal approval during the precertification period was more effective. Therefore, NHTSA proposed to remove its off-road petitioning process in 49 CFR 535.8 and EPA proposed to add requirements for informal approvals in 40 CFR 1037.610. The agencies did not receive any

comments regarding the petition process. We are adopting the Phase 2 provisions as proposed.

In Phase 1 and as proposed in Phase 2, the agencies allow manufacturers to certify vehicles into a higher service class. No credits can be generated from vehicles certified to the higher service class, but any deficit produced must be offset by credits generated from other vehicles within the higher service class. Though the agencies did not propose any changes, we received comments on the treatment of 4x2 tractors. EMA and the manufacturers suggest that tractors with a 4x2 axle configuration and a heavy heavy-duty engine should be classified as a Class 8 tractor regardless of GVWR and be included in the Class 8 averaging set. Navistar and EMA stated that these vehicles are typically purchased to pull multiple trailers, even though the GVWR is less than 33,000 pounds. In the agencies' assessment, we agree with the manufacturers that these vehicles resemble Class 8 work and due to the higher useful life requirements, we are adopting provisions into the Phase 2 regulations that gives all manufacturers the option to classify Class 7 tractors with 4x2 axle configurations as Class 8 tractors.

#### (j) Chassis Dynamometer Testing Requirement

The agencies foresee the need to continue to track the progress of the Phase 2 program throughout its implementation. As discussed in Section II, the agencies expect to evaluate the overall performance of tractors with the GEM results provided by manufacturers through the end of year reports. However, we also need to continue to have confidence in our simulation tool, GEM, as the vehicle technologies continue to evolve. Therefore, EPA proposed that the manufacturers conduct annual chassis dynamometer testing of three sleeper cab tractors and two day cab tractors and provide the data and the GEM result from each of these tractor configurations to EPA (see 40 CFR 1037.665). 80 FR 40251. We requested comment on the costs and efficacy of this data submission requirement.

In response, the agencies received mixed comments supporting and raising concerns about the proposed chassis test requirements. ACEEE and ICCT supported the proposal to conduct annual chassis testing to verify the relative reductions simulated in GEM and suggested that the results be provided to the public. UCS supported the proposal, similar to ACEEE and ICCT, with the additional suggestion to conduct an over the road testing of

select vehicles under real world conditions. EMA, Daimler, Volvo, PACCAR, and Navistar commented that they support auditing, but the proposed chassis testing is burdensome with few facilities available and will not achieve the agencies' stated goal of validating GEM's measure trends in the real world. Daimler and Navistar also stated that chassis dyno testing cannot replicate the real-world conditions for many technologies, such as tire pressure monitoring systems, intelligent coasting on grades, predictively adjusting vehicle speed on hills, adapting ride height at speed, using advanced cooling system controls, etc. Volvo raised concerns about the chassis test results due to driver variability, accessory loads, and the need to simulate road loads that comprise around 90 percent of the vehicle load in tractor cycles. Volvo and Daimler noted that without separate tests to quantify the aerodynamics and rolling resistance, which accounts for a significant majority of the vehicle losses, the chassis test essentially only evaluates the powertrain and therefore recommended powertrain testing for this purpose over a chassis test. The manufacturer's suggested that EPA conduct the testing or work collaboratively to develop an in-use research program. Navistar commented that if the provision remains for the final rule, then it be limited to one vehicle in 2021, 2024, and 2027 model year. Navistar also suggested that the final requirements do not include the proposed measurement of gaseous emissions due to the additional cost burden.

After consideration of the comments, the agencies are requiring tractor manufacturers to annually chassis test five production vehicles over the GEM cycles to verify that relative reductions simulated in GEM are being achieved in actual production. See 40 CFR 1037.665. We do not expect absolute correlation between GEM results and chassis testing. GEM makes many simplifying assumptions that do not compromise its usefulness for certification, but do cause it to produce emission rates different from what would be measured during a chassis dynamometer test. Given the limits of correlation possible between GEM and chassis testing, we would not expect such testing to accurately reflect whether a vehicle was compliant with the GEM standards. Therefore, we are not applying compliance liability to such testing. Rather, this testing will be for informational purposes only. However, we do expect there to be correlation in a relative sense. Vehicle to vehicle differences showing a 10

percent improvement in GEM should show a similar percent improvement with chassis dynamometer testing. Nevertheless, manufacturers will not be subject to recall or other compliance actions if chassis testing did not agree with the GEM results on a relative basis. Rather, the agencies will continue to evaluate in-use compliance by verifying GEM inputs and testing in-use engines. (Note that NTE standards for criteria pollutants may apply for some portion of the test cycles.)

EPA believes this chassis test program is necessary because of our experience implementing regulations for heavy-duty engines. In the past, manufacturers have designed engines that have much lower emissions on the duty cycles than occur during actual use. The recent experience with Volkswagen is an unfortunate instance. By using this simple test program, we hope to be able to identify such issues earlier and to dissuade any attempts to design solely to the certification test. We also expect the results of this testing to help inform the need for any further changes to GEM.

As already noted in Section II.B.(1), it can be expensive to build chassis test cells for certification. However, EPA has structured this pilot-scale program to minimize the costs. First, this chassis testing will not need to comply with the same requirements as will apply for official certification testing. This will allow testing to be performed in developmental test cells with simple portable analyzers. Second, since the program will require only five tests per year, manufacturers without their own chassis testing facility will be able to contract with a third party to perform the testing. Finally, EPA is applying this testing to only those manufacturers with annual production in excess of 20,000 vehicles.

#### *F. Flexibility Provisions*

EPA and NHTSA are adopting two flexibility provisions specifically for heavy-duty tractor manufacturers in Phase 2. These are an averaging, banking and trading program for CO<sub>2</sub> emissions and fuel consumption credits, as well as provisions for credits for off-cycle technologies which are not included as inputs to the GEM. Credits generated under these provisions can only be used within the same averaging set that generated the credit.

The agencies are also modifying several Phase 1 interim provisions, as described below.

#### (1) Averaging, Banking, and Trading (ABT) Program

Averaging, banking, and trading of emission credits have been an important part of many EPA mobile source programs under CAA Title II, and the NHTSA light-duty CAFE program. The agencies also included this flexibility in the HD Phase 1 program. ABT provisions are useful because they can help to address many potential issues of technological feasibility and lead-time, as well as considerations of cost. They provide manufacturers flexibilities that assist in the efficient development and implementation of new technologies and therefore enable new technologies to be implemented at a more aggressive pace than without ABT. A well-designed ABT program can also provide important environmental and energy security benefits by increasing the speed at which new technologies can be implemented. Between MYs 2013 and 2014 all four tractor manufacturers are taking advantage of the ABT provisions in the Phase 1 program. NHTSA and EPA proposed to carry-over the Phase 1 ABT provisions for tractors into Phase 2, and are adopting these provisions.

The agencies proposed and are adopting for Phase 2 the five year credit life and three year deficit carry-over provisions from Phase 1 (40 CFR 1037.740(c) and 1037.745). Please see additional discussion in Section I.C.1.b.i. Although we did not propose any additional restrictions on the use of Phase 1 credits, we requested comment on this issue. In the NPRM, we stated that early indications suggest that positive market reception to the Phase 1 technologies could lead to manufacturers accumulating credits surpluses that could be quite large at the beginning of the Phase 2 program. 80 FR 40251. For the final rule, the agencies assessed the level of credits that the tractor manufacturers are accruing. As discussed above in Section III.D, the agencies adjusted the 2021 MY standards to reflect the accumulation of credits.

#### (2) Off-Cycle Technology Credits

In Phase 1, the agencies adopted an emissions and fuel consumption credit generating opportunity that applied to innovative technologies that reduce fuel consumption and CO<sub>2</sub> emissions. These technologies were required to not be in common use with heavy-duty vehicles before the 2010MY and not reflected in the GEM simulation tool (*i.e.*, the benefits are "off-cycle"). See 76 FR 57253. The agencies proposed to essentially continue this program in Phase 2. However, we are calling the

program an off-cycle credit program rather than an innovative technology program (although there is little, if any, difference in practice). In other words, beginning in 2021 MY all technologies that are not accounted for in the GEM test procedure (including powertrain testing) could be considered off-cycle, including those technologies that may have been considered innovative technologies in Phase 1 of the program. The agencies proposed to maintain the requirement that, in order for a manufacturer to receive credits for Phase 2, the off-cycle technology would still need to meet the requirement that it was not in common use prior to MY 2010. However, the final provisions will not require manufacturers to make such a demonstration. Rather, the agencies will merely retain the authority to deny a request if we determine that a technology was in common use in 2010 and was thus part of the Phase 1 baseline (and thus also the Phase 2 baseline). For additional information on the treatment of off-cycle technologies see Section I.C.1.c. as well as the discussion of off-cycle credits in each of the Phase 2 standard chapters.

### (3) Post Useful Life Modifications

Under 40 CFR part 1037, it is generally prohibited for any person to remove or render inoperative any emission control device installed to comply with the requirements of part 1037. However, in 40 CFR 1037.655 EPA clarifies that certain vehicle modifications are allowed after a vehicle reaches the end of its regulatory useful life. This section applies for all vehicles subject to 40 CFR part 1037 and will thus apply for trailers regulated in Phase 2. EPA proposed to continue this provision and requested comment on it. 80 FR 40252.

This section states (as examples) that it is generally allowable to remove tractor roof fairings after the end of the vehicle's useful life if the vehicle will no longer be used primarily to pull box trailers, or to remove other fairings if the vehicle will no longer be used significantly on highways with vehicle speed of 55 miles per hour or higher. More generally, this section clarifies that owners may modify a vehicle for the purpose of reducing emissions, provided they have a reasonable technical basis for knowing that such modification will not increase emissions of any other pollutant. This essentially requires the owner to have information that will lead an engineer or other person familiar with engine and vehicle design and function to reasonably believe that the modifications will not increase emissions of any regulated

pollutant. Thus, this provision does not provide a blanket allowance for modifications after the useful life.

This section also makes clear that no person may ever disable a vehicle speed limiter prior to its expiration point, or remove aerodynamic fairings from tractors that are used primarily to pull box trailers on highways. It is also clear that this allowance does not apply with respect to engine modifications or recalibrations.

This section does not apply with respect to modifications that occur within the useful life period, other than to note that many such modifications to the vehicle during the useful life and to the engine at any time are presumed to violate section 202(a)(3)(A) of the Act. EPA notes, however, that this is merely a presumption, and it does not prohibit modifications during the useful life where the owner clearly has a reasonable technical basis for knowing that the modifications would not cause the vehicle to exceed any applicable standard.

The agencies did not receive comments opposing the proposed regulation, and is adopting it as proposed.

### (4) Other Interim Provisions

In HD Phase 1, EPA adopted provisions to delay the full onboard diagnostics (OBD) requirements for heavy-duty hybrid powertrains until the 2016 and 2017 model years (see 40 CFR 86.010–18(q)). In discussions with manufacturers during the development of Phase 2, the agencies have learned that meeting the on-board diagnostic requirements for criteria pollutant engine certification continues to be a potential impediment to adoption of hybrid systems. See Section XIII.A.1 for a discussion of regulatory changes to reduce the non-GHG certification burden for engines paired with hybrid powertrain systems.

The Phase 1 advanced technology credits were adopted to promote the implementation of advanced technologies, such as hybrid powertrains, Rankine cycle engines, all-electric vehicles, and fuel cell vehicles (see 40 CFR 1037.150(p)). As the agencies stated in the Phase 1 final rule, the Phase 1 standards were not premised on the use of advanced technologies but we expected these advanced technologies to be an important part of the Phase 2 rulemaking (76 FR 57133, September 15, 2011). The HD Phase 2 heavy-duty engine and tractor standards are premised on the use of Rankine-cycle engines; therefore, the agencies believe it is no longer appropriate to provide

extra credit for this technology. While the agencies have not premised the HD Phase 2 tractor standards on hybrid powertrains, fuel cells, or electric vehicles, we also foresee some limited use of these technologies in 2021 and beyond. We proposed in Phase 2 to not provide advanced technology credits in Phase 2 for any technology, but received many comments supporting the need for such incentive. As described in Section I.C.1.b, the agencies are finalizing credit multipliers for plug-in battery electric hybrids, all-electric, and fuel cell vehicles.

### (5) Phase 1 Flexibilities Not Adopted for Phase 2

In Phase 1, the agencies adopted an early credit mechanism to create incentives for manufacturers to introduce more efficient engines and vehicles earlier than they otherwise would have planned to do (see 40 CFR 1037.150(a)). The agencies did not propose to extend this flexibility to Phase 2 because the ABT program from Phase 1 will be available to manufacturers in 2020 model year and this will displace the need for early credits. However, the agencies are adopting provisions in the final Phase 2 rule that provide early credit opportunities for a limited set of technologies (see 40 CFR 1037.150(y)(2); see also 40 CFR 1037.150(y)(1) and (3) providing early credit flexibilities to certain vocational vehicles).

## IV. Trailers

As mentioned in Section III, trailers pulled by Class 7 and 8 tractors (together considered "tractor-trailers") account for approximately 60 percent of the heavy-duty sector's total CO<sub>2</sub> emissions and fuel consumption. Because neither trailers nor the tractors that pull them are useful by themselves, it is the combination of the tractor and the trailer that forms the useful vehicle. Although trailers do not directly generate exhaust emissions or consume fuels (except for the refrigeration units on refrigerated trailers), their designs and operation nevertheless contribute substantially to the CO<sub>2</sub> emissions and diesel fuel consumption of the tractors pulling them. See also Section I.E above.

The agencies are finalizing standards for trailers specifically designed to be drawn by Class 7 and 8 tractors when coupled to the tractor's fifth wheel. Although many other vehicles are known commercially as trailers, this trailer program does not apply to those that are pulled by vehicles other than tractors, and those that are coupled to vehicles exclusively by pintle hooks or hitches instead of a fifth wheel. These

standards are expressed in terms of CO<sub>2</sub> emissions and fuel consumption, and as described in more detail in Section IV.C.(2), apply to specific trailer subcategories. In general, the final standards are based on the same technology as the proposed standards—primarily better tires (including tire pressure management) for all regulated trailers and aerodynamic improvements for box vans (dry and refrigerated). Most of the changes from the proposal are intended to simplify and clarify the implementation of these standards. See Section IV.B. for an overview of the final program, and the rest of this Section IV for more detailed discussions.

This rulemaking establishes the first EPA regulations covering trailer manufacturers for CO<sub>2</sub> emissions (or any other emissions), and the first fuel consumption regulations by NHTSA for these manufacturers. The agencies have designed this program to be a unified national program, so that when a trailer model complies with EPA's standards it will also comply with NHTSA's standards, and vice versa.

#### A. The Trailer Industry

##### (1) Industry Characterization

The trailer industry encompasses a wide variety of trailer applications and designs. Among these are box vans (dry and refrigerated vans of various sizes) and “non-box” trailers, including platform (e.g., lowboys, flatbeds), tanks, container chassis, bulk, dump, grain, and many specialized types of trailers, such as car carriers, pole trailers, and logging trailers. Most trailers are designed for predominant use on paved streets, roads, and highways. A relatively small number of trailers are designed with unique capabilities and features for dedicated use in off-road applications.

The trailer manufacturing industry is very competitive, and manufacturers are highly responsive to their customers' diverse demands. The wide range of trailer designs and features reflects the broad variety of customer needs, chief among them typically being the ability to maximize the amount of freight the trailer can transport. Other design goals reflect the numerous, more specialized customer needs.

Box vans (*i.e.*, dry and refrigerated) are the most common type of trailer and are made in many different lengths, generally ranging from 28 feet to 53 feet. While all have a rectangular shape, they can vary widely in basic construction design (internal volume and weight), materials (steel, fiberglass composites, aluminum, and wood) and the number

and configuration of axles (usually two axles closely spaced, but number and spacing of axles can be greater). Box van designs may also include additional features, such as one or more side doors, out-swinging or roll-up rear doors, side or rear lift gates, and numerous types of undercarriage accessories (such as access ramps, dolly storage, spare tire storage, or mechanical lifts).

Non-box trailers are often uniquely designed to transport a specific type of freight. Platform trailers carry cargo that may not be easily contained within or loaded into/unloaded from a box van, such as large, non-uniform equipment or machine components. Tank trailers are often sealed or pressurized enclosures designed to carry liquids, gases or bulk, dry solids and semi-solids. There are also a number of other specialized trailers such as grain, dump, livestock trailers, or logging.

Chapter 1 of the RIA includes a more thorough characterization of the trailer industry. The agencies have considered the variety of trailer designs and applications in developing the CO<sub>2</sub> emissions and fuel consumption standards for trailers. As is described later in this Section IV, the agencies have excluded most types of specialized trailers from the Phase 2 regulations.

##### (2) Context for the Trailer Provisions

###### (a) Summary of Trailer Consideration in Phase 1

In the Phase 1 program, the agencies did not regulate trailers, but discussed how we might do so in the future (see 76 FR 57362). In proposing the Phase 1 program, the agencies solicited general comments on controlling CO<sub>2</sub> emissions and fuel consumption through future trailer regulations (see 75 FR 74345–74351). The agencies considered those comments in developing today's rules.

###### (b) SmartWay Program

For several years, EPA's voluntary SmartWay Transport Partnership program has been encouraging businesses to take actions that reduce fuel consumption and CO<sub>2</sub> emissions while cutting costs. The SmartWay program works with the shipping, logistics, and carrier communities to identify cleaner strategies and technologies for moving goods across their transportation supply chains. It is a voluntary, market-based program that provides carbon footprint and other air emissions performance information to partners who submit annual partner reports. SmartWay Partners commit to assessing, tracking, and improving environmental performance over time, by adopting fuel-saving practices and

technologies. SmartWay also provides technical assistance, provides recognition incentives and encourages the use of best practices that enable companies to readily incorporate fuel and emission reduction strategies into their freight supply chains.

Annually, SmartWay trucking fleet partners report type and amount of fuel consumption, tons of goods moved, type and model year of equipment used, miles driven, speed profiles and other data. Using EPA MOVES model emission factors and other EPA resources, SmartWay's assessment and tracking tools convert this information to an objective ranking of a company's environmental efficiency, enabling each participating company to benchmark performance relative to its competitors. Logistics companies, multimodal firms and shippers use this information to calculate their corporate emissions from goods movement, which can be included in annual carbon reporting protocols and sustainability reports.

EPA's SmartWay program has accelerated the availability and market penetration of advanced, fuel efficient technologies and operational practices. In conjunction with the SmartWay Partnership Program, EPA established a testing, verification, and designation program, the SmartWay Technology Program, to help freight companies identify the equipment, technologies, and strategies that save fuel and lower emissions. SmartWay verifies the performance of aerodynamic equipment, low rolling resistance tires and other technologies and maintains lists of verified technologies on its Web site. Trailer aerodynamic technologies are grouped in performance bins that represent one percent, four percent, five percent or nine percent fuel savings relative to a typical long-haul tractor-trailer at 65-mph cruise conditions. As a shorthand description and to encourage saving fuel with multiple available technologies, EPA established criteria to describe tractors and trailers as SmartWay designated if they are equipped with specific technologies. Historically, a 53-foot dry van trailer equipped with verified aerodynamic devices totaling at least five percent fuel savings, and SmartWay verified tires, qualifies as a “SmartWay Designated Trailer.” In 2014, EPA expanded the program to include the aerodynamic bin for nine percent or more fuel savings and these trailers when also equipped with verified tires qualify as “SmartWay Designated Elite Trailer.” The 2014 updates also expanded the use of aerodynamic technologies and SmartWay-designated trailer eligibility to include 53-foot refrigerated van



trailers in addition to 53-foot dry van trailers.

The SmartWay Technology Program continues to improve the industry understanding of technologies, test methods and quality of data fleet stakeholders need to achieve fuel savings and environmental goals. EPA bases its SmartWay verification protocols on common industry test methods with additional criteria to achieve performance objectives and cost effective industry acceptance. Historically, SmartWay's aerodynamic equipment verification protocol was based on the TMC type II and SAE J1321 test procedures, which measures fuel consumption as test vehicles drive laps around a test track. Under SmartWay's 2014 updates, EPA expanded the aerodynamic technology verification program to allow additional testing options. The updates included a new, more stringent 2014 track test protocol based on industry updates to the TMC RP 1102 (2014) and SAE's 2012 update to its SAE J1321 test method<sup>326</sup> as well as protocols for wind tunnel and coastdown methods. The SmartWay program is also reviewing computational fluid dynamics (CFD) approaches for verification. These new protocols are based on stakeholder input, the latest industry standards (*i.e.*, 2012 versions of the SAE fuel consumption and wind tunnel test<sup>327</sup> methods and 2013 CFD guidance<sup>328</sup>), EPA's own testing and research, and lessons learned from years of communications with manufacturers, testing organizations and trucking companies. Wind tunnel, coastdown, and CFD testing produce values for aerodynamic drag improvements in terms of coefficient of drag ( $C_D$ ), which is then related to projected fuel savings using a mathematical curve.<sup>329</sup>

The SmartWay Technology Program verifies tires based on test data submitted by tire manufacturers demonstrating the coefficient of rolling resistance ( $C_{RR}$ ) of their tires using either the SAE J1269 or ISO 28580 test

methods. These verified tires have rolling resistance targets for each axle position on the tractor and trailer. SmartWay-verified trailer tires achieve a  $C_{RR}$  of 5.1 kg/metric ton or less on the ISO28580 test method. Compared to popular tires used in 2007, an operator who replaces the trailer tires with SmartWay-verified tires can expect fuel consumption savings of one percent or more at a 65-mph cruise. Operators who apply SmartWay-verified tires on both the trailer *and* tractor can achieve three percent fuel consumption savings at 65-mph. As most van trailers and many other trailer types are manufactured with SmartWay verified tires, fleets have confidence in maintaining their fuel performance thru the use of and flexibility to choose other SmartWay verified tires.

Over the last decade, the trucking industry has achieved measureable fuel consumption benefits by adding aerodynamic features and low rolling resistance tires to their trailers. To date, SmartWay has verified over 70 aerodynamic technologies, including ten packages from five manufacturers that have received the Elite performance level. The SmartWay Transport Partnership program has worked with over 3,000 partners, the majority of which are trucking fleets, and broadly throughout the supply-chain industry, since 2004. These relationships, combined with the Technology Program's extensive involvement testing and technology development has provided EPA with significant experience in freight fuel efficiency. Furthermore, the more than 10-year duration of the voluntary SmartWay Transport Partnership has resulted in significant fleet and manufacturer experience with innovating and deploying technologies that reduce CO<sub>2</sub> emissions and fuel consumption.

#### (c) California Tractor-Trailer Greenhouse Gas Regulation

The state of California passed the Global Warming Solutions Act of 2006 (Assembly Bill 32, or AB32), enacting the state's 2020 greenhouse gas emissions reduction goal into law. Pursuant to this Act, the California Air Resource Board (CARB) was required to begin developing early actions to reduce GHG emissions. As a part of a larger effort to comply with AB32, the California Air Resource Board issued a regulation entitled "Heavy-Duty Greenhouse Gas Emission Reduction Regulation" in December 2008.

This regulation reduces GHG emissions by requiring improvement in the efficiency of heavy-duty tractors and 53 feet or longer dry and refrigerated

box trailers that operate in California.<sup>330</sup> The program is being phased in between 2010 and 2020. Small fleets have been allowed special compliance opportunities to phase in the retrofits of their existing trailer fleets through 2017. The regulation requires affected trailer fleet owners to either use SmartWay-verified aerodynamic technologies and SmartWay-verified tires or retread tires. The efficiency improvements are achieved through the use of aerodynamic equipment and low rolling resistance tires on both the tractor and trailer. EPA has granted a waiver for this California program.<sup>331</sup>

#### (d) NHTSA Safety-Related Regulations for Trailers and Tires

NHTSA regulates new trailer safety through regulations. Table IV-1 lists the current regulations in place related to trailers. Trailer manufacturers continue to be required to meet current safety regulations for the trailers they produce. FMVSS Nos. 223 and 224<sup>332</sup> require installation of rear guard protection on trailers. The definition of rear extremity of the trailer in 223 limits installation of rear fairings to a specified zone behind the trailer.

TABLE IV-1—CURRENT NHTSA STATUTES AND REGULATIONS RELATED TO TRAILERS

Reference	Title
49 CFR part 565	Vehicle Identification Number (VIN) Requirements.
49 CFR part 566	Manufacturer Identification.
49 CFR part 567	Certification.
49 CFR part 568	Vehicles Manufactured in Two or More Stages.
49 CFR part 569	Regrooved Tires.
49 CFR part 571	Federal Motor Vehicle Safety Standards.
49 CFR part 573	Defect and Noncompliance Responsibility and Reports.
49 CFR part 574	Tire Identification and Recordkeeping.
49 CFR part 575	Consumer Information.
49 CFR part 576	Record Retention.

<sup>330</sup> In December 2013, ARB adopted regulations that establish its own parallel Phase 1 program with standards consistent with the EPA Phase 1 tractor standards. On December 5, 2014 California's Office of Administrative Law approved ARB's adoption of the Phase 1 standards, with an effective date of December 5, 2014.

<sup>331</sup> See EPA's waiver of CARB's heavy-duty tractor-trailer greenhouse gas regulation applicable to new 2011 through 2013 model year Class 8 tractors equipped with integrated sleeper berths (sleeper-cab tractors) and 2011 and subsequent model year dry-can and refrigerated-van trailers that are pulled by such tractors on California highways at 79 FR 46256 (August 7, 2014).

<sup>332</sup> 49 CFR 571.223 and 571.224.

<sup>326</sup> SAE International, Fuel Consumption Test Procedure—Type II. SAE Standard J1321. Revised 2012-02-06. Available at: [http://standards.sae.org/j1321\\_201202/](http://standards.sae.org/j1321_201202/).

<sup>327</sup> SAE International, Wind Tunnel Test Procedure for Trucks and Buses. SAE Standard J1252. Revised 2012-07-16. Available at: [http://standards.sae.org/j1252\\_201207/](http://standards.sae.org/j1252_201207/).

<sup>328</sup> SAE International, Guidelines for Aerodynamic Assessment of Medium and Heavy Commercial Ground Vehicles Using Computational Fluid Dynamics. SAE Standard J2966. Issued 2013-09-17. Available at: [http://standards.sae.org/j2966\\_201309/](http://standards.sae.org/j2966_201309/).

<sup>329</sup> McCallen, R., et al. Progress in Reducing Aerodynamic Drag for Higher Efficiency of Heavy Duty Trucks (Class 7-8). SAE Technical Paper. 1999-01-2238.



NHTSA recognizes that regulatory and market factors that result in changes in trailer weight can potentially have safety ramifications, both positive and negative. NHTSA believes that the appropriate perspective is to evaluate the regulation and market factors in their entirety. One such factor is that incentives in the Phase 2 regulation could result in an average decrease in trailer weight. Since removing weight from trailers allows more cargo to be carried, fewer trips are needed to move the same amount of cargo, and fewer crashes—including fatal crashes—could occur. Fleets and other customers have a natural incentive to request lighter-weight trailers. From the trailer owners' perspective, reducing trailer weight not only allows them to increase cargo when they are near capacity, but also reduces fuel consumption whether the trailer is fully loaded or not. In pre-proposal meetings with trailer manufacturers, companies said that customers are requesting lighter-weight components when possible and manufacturers are installing them.

To further incentivize a shift to lighter weight materials, the Phase 2 program provides two compliance mechanisms, both of which are discussed later in this Preamble (Section IV.D.(1)(d) and Section IV.E.(5)(d), respectively). The first is a list of weight reductions from which manufacturers can select. The list identifies specific lighter-weight components, such as side posts, roof bows, and flooring. Manufacturers using these lighter-weight components achieve fuel consumption and GHG reductions that count toward their compliance calculations. The NPRM identified twelve components, ranging from lighter-weight landing gear (which receives credit for 50 pounds of weight reduction) to aluminum upper coupler assemblies (which receive credit for 430 pounds). See proposed section 1037.515 at 80 FR 40627. In addition, for a lighter-weight component or technology that is not on the list of specific components, the program provides for manufacturers to use the "off-cycle" process to recognize the weight reduction (Section IV.E.(5)(d)). Through these mechanisms, the program provides significant flexibility and incentives for trailer light-weighting.

NHTSA also recognizes that the aerodynamic devices that we expect may be adopted to meet the Phase 2 trailer standards inherently add weight to trailers. In comments on the NPRM, TTMA stated that they believe that this weight increase will result in added trips and increased numbers of fatal crashes. By its analysis, this additional weight—which TTMA estimates to be

250 pounds per trailer, will cause some trucks to exceed the trailer weight limits, necessitating additional truck trips to transport freight that could not be moved by the "weighed-out" trucks. By TTMA's analysis, these added trips would cause an additional 184 million truck miles per year and would result in 246 crashes and 7 extra fatal crashes, using an assumed crash rate of 134 collisions per 100 million VMT and a 3 percent fatality rate per crash. The agencies evaluated TTMA's estimate of additional fatalities and disagree with some of the assumptions made in the analysis. For example, the fatality rate used was developed in a study conducted for Idaho and is higher than the national average. According to FMCSA's 2014 annual report for "Large Truck and Bus Crash Facts" indicates there are less than 1.67 fatalities per 100 million vehicle miles traveled (VMT) by combination trucks in the U.S. for 2014. When multiplied by an estimated 184 million additional truck miles due to weighed-out trucks, the result is an increase of about 3 fatalities, or 2.7 fatal crashes.

Overall, the potential positive safety implications of weight reduction efforts could partially or fully offset safety concerns from added weight of aerodynamic devices. In fact, for this reason, we believe that the Phase 2 trailer program could produce a net safety benefit in the long run due to the potentially greater amount of cargo that could be carried on each truck as a result of trailer weight reduction.

(e) Additional DOT Regulations Related to Trailers

In addition to NHTSA's regulations, DOT's Federal Highway Administration (FHWA) regulates the weight and dimensions of motor vehicles on the National Network.<sup>333</sup> FHWA's regulations limit states from setting truck size and weight limits beyond certain ranges for vehicles used on the National Network. Specifically, vehicle weight and truck tractor-semitrailer length and width are limited by FHWA.<sup>334</sup> EPA and NHTSA do not anticipate any conflicts between FHWA's regulations and those established in this rulemaking.

Utility Trailer Manufacturing Co. (Utility) commented that reducing existing restrictions on trailer size and weight could help encourage the transition to new technologies and trailer designs. However, these size and weight restrictions are under the jurisdiction of FHWA, and are largely

controlled by the weight limits established by Congress in 1956 and 1974, the size limits established in the Surface Transportation Assistance Act of 1982, and the size and weight limits established in the Intermodal Surface Transportation Efficiency Act of 1991. Changes to these restrictions would require a broader process involving Congress and federal and state agencies, and is beyond the scope of the Phase 2 trailer program.

Wabash National Corporation (Wabash) stated that the agencies should seek to ensure that today's action harmonizes with safety regulations applicable to trailers. Specifically, Wabash highlighted NHTSA's work on rear impact guard standards and ongoing examination of side impact guards. Wabash stated new or revised requirements for impact guards could increase trailer weight. The agencies have analyzed the issues in the present rulemaking while fully considering NHTSA's safety regulations and rulemakings pertaining to trailers. The subject of a possible side guard requirement is in a research stage. As discussed in a July 2015 document, NHTSA is in the process of evaluating issues relating to side guards and will issue a decision on them at a later date.<sup>335</sup> In December 2015, NHTSA issued a notice of proposed rulemaking proposing to adopt requirements of Transport Canada's standard for underdrive guards.<sup>336</sup> NHTSA is currently assessing next steps on that proposal, and includes as part of its analysis consideration of impacts of any decisions on the fuel efficiency of the vehicles. With respect to Wabash's comment regarding the additional weight from aerodynamic devices, as discussed in the previous subsection, the agencies believe potential compliance paths incorporating lightweighting could offset the additional weight of aerodynamic devices in whole or in part.

*B. Overview of the Phase 2 Trailer Program and Key Changes From the Proposal*

The HD Phase 2 program represents the first time CO<sub>2</sub> emission and fuel consumption standards have been established for manufacturers of new trailers. As was proposed (80 FR 40257), the final standards will phase in gradually, beginning in MY 2018. New regulated trailers built on or after January 1, 2018 need to be certified to

<sup>333</sup> 23 CFR 658.9.

<sup>334</sup> 23 CFR part 658.

<sup>335</sup> 80 FR 43663 (footnote 3) (July 23, 2015).

<sup>336</sup> 80 FR 78417 (December 16, 2015).

the new CO<sub>2</sub> emissions standards.<sup>337</sup> NHTSA fuel consumption standards are voluntary until MY 2021.

EPA and NHTSA proposed a trailer program, using appropriate aspects of the Phase 1 tractor program as a guide, including optional averaging provisions (*i.e.* optional averaging across a manufacturer's trailer fleet) as a flexibility for trailer manufacturers to meet the proposed standards. The comments from the trailer industry were nearly unanimous in opposing averaging. Commenters cited the highly competitive nature of the industry, combined with a wide range of product diversity among companies. Commenters believe that these two factors could result in a program that unfairly benefits the few larger companies with diverse offerings and would be impossible to implement for the many companies with limited product diversity. Additionally, compared to other industry sectors, trailer manufacturers noted that they often have little control over what kinds of trailer models their customers demand and thus limited ability to manage the mix and volume of different products. Specifically, Wabash and Utility stated that the dynamic and customer-driven nature of the industry, with many customer-specific requirements for each trailer order, makes it impossible for a manufacturer to predict what products they will produce in a given year. Utility stated that an averaging program will put manufacturers in the position of having to decide which customers receive trailers with aerodynamic devices and which receive trailers without devices. Utility added that averaging may force manufacturers to absorb the cost of aerodynamic devices, or it could cause customers to go to another manufacturer with sufficient credits to fill an order without using aerodynamic devices. Truck Trailer Manufacturers Association (TTMA) also submitted comments asking the agencies not to adopt averaging provisions. In contrast, Great Dane stated that averaging is an option manufacturers may need and recommended its inclusion in the final rule. The International Council on Clean Transportation (ICCT) said that they generally favor averaging since it gives manufacturers maximum flexibility in meeting standards while allowing for the technology deployment path that best matches a company's business strategy.

In order to balance the advantage of an averaging program in allowing for introduction of the most reasonably stringent standards for trailers with the concerns articulated by manufacturers, the final program accordingly limits the option for trailer manufacturers to apply averaging exclusively to MYs 2027 and later for full-aero box vans only. We believe this delay provides box van manufacturers sufficient time to develop, evaluate and market new technologies and to become familiar with the compliance process and possible benefits of averaging. This will also allow customers to become more familiar with the technologies and to recognize their benefits. See Section IV.E.(5)(b) for more details on the trailer averaging program. In the earlier years of the program, when the program does not provide for averaging, the program does provide each manufacturer with a limited "allowance" of trailers that do not need to meet the standards. See Section IV.E.(5)(a) below.

The agencies proposed standards for dry and refrigerated box vans that were performance-based, and that were predicated on a high adoption of aerodynamic technologies, lower rolling resistance (LRR) tires and automatic tire inflation systems (ATIS). We designed the compliance approach for these performance-based standards so that manufacturers would have a degree of choice among aerodynamic, tire, tire pressure, and weight-reduction technologies and could combine them as they wished to achieve the standards. See 80 FR 40257. This final program maintains this flexible approach, adding provisions that include options for using tire pressure monitoring systems (TPMS) and innovative weight-reduction technologies as part of manufacturer compliance strategies. Section IV.E.(2) below discusses the trailer compliance provisions.

We proposed "partial-aero" criteria for box vans with work-performing equipment that impeded use of aerodynamic technologies and we proposed that those "partial-aero" box vans would not have to adopt the most stringent standards in MY 2027; instead, they would maintain the MY 2024 standards. We also proposed design-based tire standards for non-box trailers that required adoption of LRR tires and ATIS. Finally, in recognition that some specialized box van designs are not very compatible with the aerodynamic technologies, the agencies established "non-aero" criteria for box vans. Box vans meeting the "non-aero" criteria will be subject to the same requirements as the non-box trailers. 80 FR 40259.

The proposed program was designed to include nearly all trailer types, with a limited number of exemptions or exclusions that we believed indicated off-road, heavy-haul or non-freight transporting operation. TTMA and the American Trucking Associations (ATA) provided comments suggesting that additional trailer types should be excluded from the program based on these trailers' typical operational characteristics. The agencies considered the suggestions of these commenters and of several individual trailer manufacturers, and we recognize that many trailers in the proposed non-box subcategory have unique physical characteristics for specialized operations that may make use of lower rolling resistance (LRR) tires and/or tire pressure systems difficult or infeasible. Instead of focusing on trailer characteristics that indicated off-highway or specialty use, the agencies have identified three specific types of non-box trailers that represent the majority of non-box trailers that are designed for and mostly used in on-road applications: Tank trailers, flatbed trailers, and container chassis. Because of their predominant on-road usage, the tire technologies adopted in this trailer program will be consistently effective for these non-box trailer types. Consequently, the final program as it applies to non-box trailers is limited to tanks, flatbeds, and container chassis. All other non-box trailers, about half of the non-box trailers produced, are excluded from the Phase 2 trailer program, with no regulatory requirements. See Section IV.C.(1) for the regulatory definitions of the trailers included in this program.

Wabash commented that partial-aero vans should be exempt in MY 2021 rather than MY 2027 as proposed, citing the need for multiple devices to meet the later standards. The agencies reconsidered the proposed partial-aero standards in light of this comment and recognize that it would likely be difficult for most manufacturers to meet the proposed MY 2024 standards without the use of multiple devices, and yet partial-aero trailers, by definition, are restricted from using multiple devices. For these reasons, the agencies redesigned the partial-aero standards such that trailers with qualifying work-performing equipment can meet standards that would be achievable with the use of a single aerodynamic device throughout the program, similar to the MY 2018 standards. The partial-aero standards do, however, increase in stringency slightly in MY 2021 to reflect

<sup>337</sup> For an explanation of how EPA defines "model year" for purposes of the trailer program, see Section IV.E.(1)(a).

the broader use of improved lower rolling resistance tires.

The agencies also considered comments from manufacturers that were concerned about the cost and, availability of ATIS for the trailer industry. Wabash, Owner Operator Independent Drivers Association (OOIDA), the Rubber Manufacturers Association (RMA), American Trucking Associations (ATA), and Bendix asked that TPMS be allowed for trailer tire compliance in addition to ATIS. OOIDA said that operators prefer less expensive and easier to operate TPMS to ATIS. Wabash expressed concern that ATIS suppliers would not be able to meet demand should ATIS be required as a compliance mechanism for all trailers, especially in the early years of the program. Great Dane stated that their customers are not seeing consistent benefit of ATIS. ATA commented that trailer manufacturers should be allowed to use TPMS for compliance because they are increasingly effective, and some trailers used in heavy-haul applications would need an additional ATIS air compressor, which adds cost and weight that can be avoided by the use of TPMS. The California Air Resources Board supported the agencies' proposal to allow only ATIS for compliance since TPMS require action on the part of the driver to re-inflate affected tires and thus the benefit of the systems is dependent on driver behavior.

The agencies agree that TPMS generally promote proper tire inflation and that including these lower-cost systems as a compliance option will increase acceptance of the technologies. The final trailer program provides for manufacturers to install either TPMS or ATIS as a part of compliance. For full- and partial-aero trailers, the standards are performance standards, and the GEM-based compliance equation (described below) provides ATIS a slightly greater credit than it does for TPMS, to account for the greater uncertainty about TPM system effectiveness due to the inherent user-interaction required with systems that simply monitor tire pressure. These performance standards are based on the use of ATIS and the numerical values of these standards reflect the 0.2 percent increase in stringency. See Section IV.D.(1)(c) for additional information.

For non-aero box vans and non-box trailers, the standards are design standards, met directly by installation of specified technologies, not by using the compliance equation. As long as a manufacturer of these trailers installs either a TPMS or an ATIS (as well as lower rolling resistance tires meeting the specified threshold), the trailer will

comply, and either technology applies equally. We project that most design-based tire standards will be met with the less expensive TPMS, but trailers with ATIS will also comply. The effectiveness values adopted for ATIS and TPMS in the trailer program are consistent with those in the tractor and vocational vehicle programs.

The agencies generated the proposed standards with use of EPA's Greenhouse gas Emissions Model (GEM) vehicle simulation tool, but for compliance we created a GEM-based equation that trailer manufacturers would use for compliance. See Section IV.E.(2)(a). We made several improvements to GEM based on public comment, and these improvements impacted the results of the model. We have re-created a compliance equation for trailers based on the updated model and are adopting the new equation as the means for trailer manufacturers to certify their trailers in Phase 2.

The agencies also proposed an aerodynamic device testing compliance path that would allow device manufacturers to submit performance test data directly to EPA for pre-approval. 80 FR 40280. We designed this alternative to reduce the test burden of trailer manufacturers by allowing them to install devices with pre-approved data and to eliminate the need to perform their own testing of the devices. Based on public comment, the agencies are adopting the aerodynamic device testing alternative in the final trailer program and are updating several of the provisions related to submission and verification of test data on those devices. See Section IV.E.(3)(b)(v).

The agencies considered five alternative programs in the proposal and extensively evaluated what were termed Alternative 3 and Alternative 4 in our feasibility analysis. 80 FR 40273. The final stringency of both alternatives was identical and each included three-year stages of increasing stringency. However, Alternative 4 represented an accelerated timeline that reached its final stringency in MY 2024. Alternative 3 included an additional three years to meet its final stringency in MY 2027. Alternative 5 was proposed in four stages, but would have a required much greater application rate of the most advanced aerodynamic devices, including aerodynamic technologies on non-box trailers. The agencies believed this alternative was infeasible for this newly-regulated industry and did not extensively evaluate it.

Public comment from the trailer industry unanimously opposed the accelerated timeline of the proposed Alternative 4. TTMA recommended that

the agencies adopt no mandatory requirements, and instead rely on a voluntary program for trailers. OOIDA supported standards less stringent than either Alternatives 3 or 4. Great Dane said that adoption of standards more stringent than Alternative 3 would considerably increase the probability of negative effects on stakeholders. Wabash questioned whether, under the accelerated timeline of Alternative 4, current technologies could be produced for all applications for which they would be needed, and with sufficient reliability. The International Food Service Delivery Association, the Truck Trade Association, and Schneider also opposed Alternative 4 for similar reasons. STEMCO, California Air Resources Board (CARB), ICCT, and American Council for an Energy-Efficient Economy (ACEEE) supported Alternative 4. The Environmental Defense Fund (EDF) supported Alternative 5, but with an accelerated schedule, saying technologies will be available to meet the Alternative 5 standards by 2024.

The final standards adopted for the Phase 2 trailer program have the same four-stage implementation schedule as the proposed Alternative 3, with standards phasing in for MYs 2018, 2021, 2024, and 2027 (NHTSA standards apply beginning in MY 2021). We received comments regarding adjustments to technology adoption rates in our baseline reference cases which the agencies found to be persuasive, and the resulting adjustments are described in Section IV.D.(2)(c). Additionally, the technology effectiveness values and projected adoption rates for each of the four stages of the program were updated in response to comments, to reflect new test data, and to account for a program without averaging.

### *C. Phase 2 Trailer Standards*

These final rules establish, for the first time, a set of CO<sub>2</sub> emission and fuel consumption standards for manufacturers of new trailers that phase in over a period of nine years and continue to reduce CO<sub>2</sub> emissions and fuel consumption in the years to follow. These standards are expressed as overall CO<sub>2</sub> emissions and fuel consumption performance standards, considering the trailer as an integral part of the tractor-trailer vehicle.

The agencies believe that the trailer standards finalized here will implement our respective statutory obligations. That is, we believe that this set of standards represents the maximum feasible alternative within the meaning of section 32902(k) of EISA, and are

appropriate under EPA's CAA authority (sections 202(a)(1) and (2)).

These standards have the same implementation schedule as the proposed Alternative 3, with standards phasing in for MYs 2018, 2021, 2024, and 2027. In our consideration of the full range of comments, the agencies have adjusted elements of the proposed Alternative 3 in ways that address some of these comments, as discussed in Section 0 below. As discussed in Section IV.E.(5)(b), the option to apply averaging to meet these standards will be available starting with MY 2027, but will not be available in earlier model years.

The agencies did not propose and are not establishing standards for CO<sub>2</sub> emissions and fuel consumption from the transport refrigeration units (TRUs) used on refrigerated box trailers. Also, EPA is not establishing standards for hydrofluorocarbon (HFC) emissions from TRUs. See Section IV.C.(3) below.

#### (1) Trailer Designs Covered by the Trailer Program

As described previously, the trailer industry produces many different trailer designs for many different applications. The agencies are introducing standards for a majority of these trailers that phase in from MY 2018 through MY 2027; the NHTSA fuel consumption standards are voluntary until MY 2021. The regulatory definitions of the trailers covered by this program are summarized below and are found in 40 CFR 1037.801 and 49 CFR 571.3.

##### (a) Box Vans

Box vans are trailers with enclosed cargo space that is permanently attached to the chassis, with fixed sides, nose and roof. Trailers with sides or roofs consisting of curtains or other removable panels are not considered box vans in this program. Box vans with self-contained HVAC systems are considered "refrigerated vans." This definition includes systems that provide cooling, heating or both. Box vans without HVAC systems are considered "dry vans."

This rulemaking establishes separate standards for box vans based on length. Box vans of length greater than 50 feet are considered "long box vans."<sup>338</sup> All vans 50 feet and shorter are considered "short box vans." The agencies requested comment on the proposed 50-foot demarcation between "long" and "short" box vans (80 FR 40258). CARB

<sup>338</sup> Most long trailers are 53 feet in length; we are adopting a cut-point of 50 feet to avoid an unintended incentive for an OEM to slightly shorten a trailer design in order to avoid the new regulatory requirements.

and the Union of Concerned Scientists (UCS) commented on this issue, requesting that the demarcation be changed to 47 feet, such that 48-foot vans would be covered under the long box subcategory. CARB suggested that the performance of aerodynamic technologies such as skirts and boat tails on a 48-foot van would be more similar to the performance of the same technologies on a 53-foot van than on the 28-foot van used to evaluate short box performance. CARB also stated that 48-foot trailers are not pulled in tandem and thus have the potential to adopt rear devices for additional reductions.

The agencies agree that 48-foot vans are aerodynamically similar to longer vans and that 28-foot trailers are often used in tandem, reducing the opportunity for rear aerodynamic features. However, the agencies believe that the use of 48-foot vans is more similar to that of shorter trailers than to that of the long-haul vans that make up most the long box subcategory. Trailer manufacturers have indicated that 48-foot vans are mostly used in short-haul operations (e.g., local food service delivery) and consequently they travel less frequently at speeds at which aerodynamic technologies can be most beneficial. Also, 48-foot vans make up a relatively small fraction of long box vans.<sup>339</sup> The agencies thus do not believe that standards predicated on the use of more effective aerodynamic technologies on 48-foot vans will provide a substantial enough additional reduction in CO<sub>2</sub> emissions and fuel consumption to justify more stringent standards for those trailers. For these reasons, the agencies are maintaining the proposed 50-foot demarcation between long and short box vans and are basing the standards for each van size category accordingly.

The trailer program identifies certain types of work-performing equipment manufacturers may install on box vans that may inhibit the use of aerodynamic technologies and thus impede the trailers' ability to meet standards predicated on adoption of aerodynamic technologies. For this program, we consider such trailer equipment to consist of a rear lift gate or rear hinged ramp and any of the following side features: A side lift gate, a side-mounted pull-out platform, steps for side-door access, a drop-deck design, or a belly box or boxes that occupy at least half the length of both sides of the trailer between the centerline of the landing

<sup>339</sup> Memorandum to Docket EPA-HQ-OAR-2014-0827: Evaluation of 50-Foot Trailer Length Demarcation to Distinguish between Long and Short Box Vans. July 18, 2016.

gear and the leading edge of the front wheels. See 40 CFR 1037.107(a)(1) and 49 CFR 571.3.

The agencies have also considered how "roll-up" or "overhead" rear trailer doors might inhibit the use of rear aerodynamic devices. TTMA, ATA, Great Dane, and Utility stated that roll-up doors are work-performing devices that can inhibit rear aerodynamic technologies. However, the agencies are aware of several existing aerodynamic devices designed to be installed near the rear of a trailer that can function regardless of the type of rear door. Also, in their comments, STEMCO indicated that additional rear aerodynamic technologies would be less likely to enter the market if the trailer program were to include roll-up doors on the list of work-performing devices above and the industry didn't demand an aerodynamic product to work with roll-up doors. The agencies recognize there may currently be limited availability of rear aerodynamic technologies for roll-up door trailers, yet we also understand that innovations and improvements continue for all trailer aerodynamic technologies. For this reason, the final trailer program includes an interim provision—through MY 2023—for box vans with roll-up doors to qualify for non-aero and partial-aero standards (as defined immediately below), by treating such doors as work-performing devices equivalent to rear lift gates. For MY 2024 and later, roll-up doors will not qualify as a work-performing device in this way; however, we expect that manufacturers of trailers with roll-up doors will comply using combinations of new rear aerodynamic technologies, in conjunction with improved trailer side and gap-reducing technologies as appropriate. See 40 CFR 1037.150.

As presented in Section IV.C.(2) below, the agencies are adopting separate standards for each of the same nine box van subcategories introduced in the proposal (80 FR 40256) and for the non-box category discussed below. Full-aero long box dry vans and full-aero long box refrigerated vans are those that are over 50 feet in length and that do not have any of the work-performing equipment discussed immediately above. Similarly, full-aero short box dry vans and full-aero short box refrigerated vans are 50 feet and shorter without any work-performing equipment. We expect these trailers to be capable of meeting the most stringent standards in the trailer program.

Long box dry vans and long box refrigerated vans that have work-performing equipment either on the underside or on the rear of the trailer that would limit a manufacturer's ability

to install aerodynamic technologies may be designated as partial-aero vans for their given subcategory. The partial-aero standards are based on adoption of tire technologies and a single aerodynamic device throughout the program. Long box dry and refrigerated vans that have work-performing equipment on the underside and rear of the trailer may be designated non-aero box vans. Non-aero box vans are a single subcategory that have design-based tire standards.

For short vans, the standards are never predicated on the use of rear devices, since many 28-foot trailers are often pulled in tandem. However, we are not aware of any current legislative or regulatory initiatives that would allow tandem trailers longer than 33 feet in length, and therefore we believe that short vans of length 35 feet and longer are unlikely to be pulled in tandem in the timeframe of these rules. We are adopting separate criteria for partial- and non-aero designation for short vans based on a length threshold of 35 feet. If vans 35 feet or longer have work-performing equipment on the underside of the trailer, we expect manufacturers can install rear devices to meet the full-aero standards, but they have the option to designate these trailers as partial-aero dry or refrigerated short vans with reduced standards that can be met with tire technologies and a single aerodynamic device. If vans 35 feet and longer have work performing equipment on the underside and rear, manufacturers may designate them as non-aero box vans.

Short vans that are less than 35 feet in length are more likely to be pulled in tandem, making most rear aerodynamic devices infeasible. Since gap reducers alone are not sufficiently effective to replace a skirt and the shortest trailers are not expected to install rear devices, both dry and refrigerated vans that are shorter than 35 feet with work-performing equipment on the underside of the trailer may be designated non-aero box vans that can comply with tire technologies only. In addition, refrigerated vans that are shorter than 35 feet cannot install gap reducers because of the TRU. Consequently, all refrigerated vans shorter than 35 feet, irrespective of work-performing equipment, can be designated partial-aero short refrigerated vans whose standards can be met with skirts and tire technologies. See 40 CFR 1037.107(a)(1) and 49 CFR 571.3. Because the types of work-performing equipment identified here generally add significant cost and weight to a trailer, we believe that the reduced standards available for trailers using this equipment are unlikely to provide an incentive for manufacturers

to install them simply as a way to avoid the full aero standards.

#### (b) Non-Box Trailers

All trailers that do not meet the definition of box vans are considered non-box trailers in the trailer program. Several commenters requested a clearer distinction of the trailers that are included in the program. In response, the agencies are limiting the non-box trailer standards to three trailer types that have distinct physical characteristics and are most often driven on-highway: Tank trailers, flatbed trailers, and container chassis. Non-box trailers that do not meet the definitions below are excluded from the trailer program, as discussed in the following section.

Tank trailers are defined for the trailer program as enclosed trailers designed to transport liquids or gases. For example, DOT 406, DOT 407, and DOT 412 tanks would fit this definition. These non-box trailers can be pressurized or designed for atmospheric pressure. Tanks that are infrequently used in transport and primarily function as storage vessels for liquids or gases (*e.g.*, frac tanks) are not included in our definition of tank trailers and are excluded from the program.

Flatbed trailers for purposes of the trailer program are platform trailers with a single, continuous load-bearing surface that runs from the rear of the trailer to at least the trailer's kingpin. Flatbed trailers are designed to accommodate side-loading cargo, and this definition includes trailers that use bulkheads, one or more walls, curtains, straps or other devices to restrain or protect cargo while underway. Note that drop deck and lowboy platform trailers are not considered *continuous* load-bearing surfaces.

Finally, in the trailer program, container chassis are trailers designed to transport temporary containers. The standards apply to all lengths of container chassis, including expandable versions. The regulations do not apply to the containers being transported, unless they are permanently mounted on the chassis.

#### (c) Excluded Trailers

As in the proposal (80 FR 40259), the final trailer program completely excludes certain trailer types. However, in response to comments and an improved understanding of the industry, the agencies have changed our approach to excluding some trailer types.

In the proposal, we focused on excluding trailers based on characteristics that tended to indicate

predominant operation in off-highway applications. The American Trucking Associations (ATA) and the Truck Trailer Manufacturers Association (TTMA) provided comments suggesting that additional trailer types should be excluded from the program based on the trailers' typical operational characteristics, generally because of these trailers' limited on-highway operation. Also, Wabash requested that the program specify clearer criteria for excluding or exempting trailers.

The agencies considered all of the suggestions of the commenters, and we now believe that a different approach to excluding some trailer types is more appropriate. We recognize that many trailer types in the proposed non-box subcategory have many unique physical characteristics and are designed for specialized operations and it would be difficult to create a comprehensive list of traits that indicated off-road use. This wide array of trailer types would have made the proposed approach difficult to implement for both trailer manufacturers and for the agencies, since the usage patterns of many specialty trailer types can vary greatly. Some of these uses, especially off-highway applications, may make use of the proposed tire technologies for compliance difficult or infeasible and may limit their effectiveness. Additionally, the agencies are aware that many manufacturers that build these specialty non-box trailers are small businesses (fewer than 1000 employees), and they would incur a disproportionately large financial burden compared to larger manufacturers if they were subject to the standards.

For these reasons, instead of focusing our approach to excluding trailer types on trailer characteristics that indicated predominant off-highway use, the final program excludes all non-box trailer types except for three specific types that we believe are designed for and mostly used in on-road applications. These types are tanks, flatbeds, and container chassis, as defined in the previous subsection. We now consider this approach to be much clearer and more straightforward to implement than the proposed approach. Manufacturers of these types of trailers can easily obtain and install LRR tires and tire pressure systems, and achieve the most consistent benefit from use of these technologies. The trailer program excludes all trailers that do not meet the criteria outlined in Section IV.C.(1)(b) above, and specified in 40 CFR 1037.5 and in 49 CFR 535.3(e).

The final rule also excludes certain types of trailers based on design

characteristics, consistent with the proposed rule. More precisely, these excluded trailer types are sub-types of otherwise regulated trailer types, such as certain types of box vans. First, the rule excludes trailers intended to haul very heavy loads, as indicated by the number of axles. Specifically, the rules exclude all trailers with four or more axles, and trailers less than 35 feet long with three axles. For example, a 53-foot box van with four axles would be excluded. Also, we agree with Utility that spread-axle trailers may be more susceptible to tire scrubbing, and the program accordingly excludes trailers with an axle spread of at least 120 inches between adjacent axle centerlines. The axle spread exclusion does not apply to trailers with adjustable axles that have the ability to be spaced less than 120 inches apart. Finally, the rules exclude trailers intended for temporary or permanent residence, office space, or other work space, such as campers, mobile homes, and carnival trailers.<sup>340</sup>

Manufacturers of excluded trailers have no reporting or other regulatory requirements under the trailer program. See 40 CFR 1037.5 and 49 CFR 535.3 for complete definitions of the trailer types that the program excludes. However, where the criteria for exclusion identified above may be unclear for specific trailer models, manufacturers are encouraged to ask the agencies to make a determination before production begins.

(2) Fuel Consumption and CO<sub>2</sub> Standards

As described previously in Section I, it is the combination of the tractor and

the trailer that form the useful vehicle, and trailer designs substantially affect the CO<sub>2</sub> emissions and fuel consumption of the tractors pulling them. Note that although the agencies are adopting new CO<sub>2</sub> and fuel consumption standards for trailers separately from tractors, we set the numerical level of the trailer standards (see Section IV.D. below) based on operation with “standard” reference tractors in recognition of their interrelatedness. In other words, the regulatory standards refer to the simulated emissions and fuel consumption of a standard tractor pulling the trailer being certified.

Unlike the other sectors covered by this Phase 2 rulemaking, trailer manufacturers do not have experience certifying under the Phase 1 program (or under EPA’s criteria pollutant program). Moreover, a large fraction of the trailer industry is composed of small businesses and even the largest trailer manufacturers do not have the same resources available to them as do manufacturers in some of the other heavy-duty sectors. The standards and compliance regime for trailers have been developed with this in mind, and we are confident these standards can be achieved and demonstrated by manufacturers who lack prior experience implementing such standards.

The agencies designed this trailer program to ensure a gradual progression of both stringency and compliance requirements in order to limit the impact on this newly-regulated industry. The agencies are adopting progressively more stringent standards in three-year stages leading up to the

MY 2027,<sup>341</sup> and are including several options to reduce compliance burden in the early years as the industry gains experience with the program (see Section IV.E.). EPA will initiate its program in MY 2018 with standards for long box dry and refrigerated vans, which standards can be met with common tire technologies and SmartWay-verified aerodynamic devices and standards for the other regulated trailers based on tire technologies only. In this early stage, we expect that manufacturers of trailers in the other trailer subcategories will meet their standards by using tire technologies only. NHTSA’s regulations will be voluntary until MY 2021 as described in Section IV.C.(2).

Standards for the next stages, which begin in MY 2021, gradually increase in stringency for each subcategory, including the introduction of standards for short box vans that we expect will be met by applying both aerodynamic and tire technologies. The standards for partial-aero box vans are less stringent than those for full-aero box vans, reflecting that the standards for partial-aero vans are based on adoption of a single aerodynamic device throughout the program. This is in contrast to the proposed standards for partial-aero vans that were identical to the standards for full-aero vans through MY 2026.

Table IV–2 and Table IV–3 below present the CO<sub>2</sub> and fuel consumption standards, beginning in MY 2018 that the agencies are adopting for full- and partial-aero box vans, respectively. The standards are expressed in grams of CO<sub>2</sub> per ton-mile and gallons of fuel per 1,000 ton-miles to reflect the load-carrying capacity of the trailers.

TABLE IV–2—TRAILER CO<sub>2</sub> AND FUEL CONSUMPTION STANDARDS FOR FULL-AERO BOX VANS

Model year	Subcategory	Dry van		Refrigerated van	
		Long	Short	Long	Short
2018–2020	EPA Standard (CO <sub>2</sub> Grams per Ton-Mile)	81.3	125.4	83.0	129.1
	Voluntary NHTSA Standard (Gallons per 1,000 Ton-Mile)	7.98625	12.31827	8.15324	12.68173
2021–2023	EPA Standard (CO <sub>2</sub> Grams per Ton-Mile)	78.9	123.7	80.6	127.5
	NHTSA Standard (Gallons per 1,000 Ton-Mile)	7.75049	12.15128	7.91749	12.52456
2024–2026	EPA Standard (CO <sub>2</sub> Grams per Ton-Mile)	77.2	120.9	78.9	124.7
	NHTSA Standard (Gallons per 1,000 Ton-Mile)	7.58350	11.87623	7.75049	12.24951
2027+	EPA Standard (CO <sub>2</sub> Grams per Ton-Mile)	75.7	119.4	77.4	123.2
	NHTSA Standard (Gallons per 1,000 Ton-Mile)	7.43615	11.72888	7.60314	12.10216

<sup>340</sup> Secondary manufacturers who purchase incomplete trailers and complete their construction

to serve as trailers are subject to the requirements of 40 CFR 1037.620 and 49 CFR 535.5(e).

<sup>341</sup> These stages are consistent with NHTSA’s stability requirements under EISA.

TABLE IV-3—TRAILER CO<sub>2</sub> AND FUEL CONSUMPTION STANDARDS FOR PARTIAL-AERO BOX VANS

Model year	Subcategory	Dry van		Refrigerated van	
		Long	Short	Long	Short
2018–2020	EPA Standard (CO <sub>2</sub> Grams per Ton-Mile)	81.3	125.4	83.0	129.1
	Voluntary NHTSA Standard (Gallons per 1,000 Ton-Mile)	7.98625	12.31827	8.15324	12.68173
2021+	EPA Standard (CO <sub>2</sub> Grams per Ton-Mile)	80.6	123.7	82.3	127.5
	NHTSA Standard (Gallons per 1,000 Ton-Mile)	7.91749	12.15128	8.08448	12.52456

The agencies are not adopting CO<sub>2</sub> or fuel consumption standards predicated on aerodynamic improvements for non-box trailers or non-aero box vans at any stage of this program. Instead, we are adopting design standards that require manufacturers of these trailers to adopt specific tire technologies and thus to comply without aerodynamic devices. This approach significantly limits the compliance burden for these manufacturers, especially if they do not also manufacture box vans subject to the

aerodynamic requirements. The agencies are adopting these design standards in two stages. In MY 2018, the non-box trailer standards require manufacturers to use tires meeting a rolling resistance of 6.0 kg/ton or better and to install tire pressure systems. In MY 2021, non-box trailers will also need tire pressure systems and LRR tires at 5.1 kg/ton (the current SmartWay-verification threshold) or better. The standards require non-aero box vans, which we believe are largely at a

baseline rolling resistance 6.0 kg/ton today, to install tire pressure monitoring systems and tires at a rolling resistance of 5.1 kg/ton in MY 2018 and 4.7 kg/ton in MY 2021 and later (there are no further increases in standard stringency for these trailers after MY 2021). For non-box trailers and non-aero box vans, manufacturers may install either TPMS or ATIS for compliance.

Table IV-4 summarizes the two stages of these design standards.

TABLE IV-4—DESIGN-BASED TIRE STANDARDS FOR NON-BOX TRAILERS AND NON-AERO BOX VANS

Model year	Tire technology	Non-box trailers	Non-aero box vans
2018–2020	Tire Rolling Resistance Level (kg/ton)	6.0	5.1
	Tire Pressure System	TPMS or ATIS	TPMS or ATIS
2021+	Tire Rolling Resistance Level (kg/ton)	5.1	4.7
	Tire Pressure System	TPMS or ATIS	TPMS or ATIS

The agencies project that the standards for the entire class of regulated trailers, when fully implemented in MY 2027, will achieve fuel consumption and CO<sub>2</sub> emissions reductions of two to nine percent relative to mostly market-driven adoption absent a national regulatory program (see Section IV.D.(2)). Because of the rapid pace of technological improvement in recent years and the lead time of nearly a decade, the agencies expect that both trailer designs and bolt-on CO<sub>2</sub>- and fuel consumption-reducing technologies will advance well beyond the performance of their present-day counterparts. Regardless, we expect that the MY 2027 standards for full-aero box vans could be met with high-performing aerodynamic and tire technologies largely available in the marketplace today. A description of technologies that the agencies considered in developing these rules is provided in Section IV.D., with additional details in RIA Chapter 2.10.

(3) Non-CO<sub>2</sub> GHG Emissions From Trailers

In addition to the impact of trailer design on the CO<sub>2</sub> emissions of tractor-trailer vehicles, EPA recognizes that refrigerated trailers can also be a source of emissions of HFCs. Specifically, HFC refrigerants that are used in transport refrigeration units (TRUs) have the potential to leak into the atmosphere.

In their comments, CARB said they believed that EPA underestimated the potential for TRU refrigerant leakage, and requested that EPA (1) initiate a TRU refrigerant “usage monitoring program” to support future evaluations of leakage; (2) create incentives for low- and zero-emission (e.g., cryogenic) TRUs; and (3) for EPA’s SNAP program to phase out the main TRU refrigerant (R404a) when viable alternatives are available. EPA did not propose any action related to TRUs in this rule, and CARB did not provide sufficient information for EPA to introduce new regulatory requirements for TRUs at this time. In general, however, EPA will continue to monitor the state of TRU technology and operation, and may

pursue appropriate action if warranted in the future.

We also note that EPA has separately proposed a regulation under Title VI of the CAA, specifically section 608. See 80 FR 69457 (November 9, 2015). This proposal would extend existing regulations on ozone depleting refrigerants to many alternative refrigerants, such as HFCs, which are the most common refrigerants used in TRUs.<sup>342</sup> If finalized as proposed, EPA would require that appliances like TRUs be subject to the applicable requirements of 40 CFR subpart F, including requirements for servicing by a certified technician using certified recovery equipment and for recordkeeping by technicians disposing of such appliances with a charge size between five and fifty pounds, which

<sup>342</sup> Under the proposal, the regulations would not be extended to equipment using a substitute refrigerant when that use of the refrigerant has been exempted from the venting prohibition, as listed in 40 CFR 82.154(a).



would include TRUs, to help ensure that the refrigerant is not vented.<sup>343</sup>

#### (4) Lead-Time Considerations

As mentioned earlier, although the agencies did not include standards for trailers in Phase 1, box van manufacturers have been gaining experience with CO<sub>2</sub>- and fuel consumption-reducing technologies over the past several years, and the agencies expect that trend to continue, due in part to EPA's SmartWay program and California's Tractor-Trailer Greenhouse Gas Regulation. Most manufacturers of 53-foot box vans have some experience installing these aerodynamic and tire technologies for customers. Manufacturers of trailers other than 53-foot box vans do not have the benefit of programs such as SmartWay to provide a reliable evaluation and promotion of aerodynamic technologies for those trailers and therefore have less experience with those technologies. However, all trailer manufacturers have experience installing tires and the installation process does not change with the use of lower rolling resistance tires. Some manufacturers may not have direct experience with tire pressure systems, but we observe that they are mechanically fairly simple and can be incorporated into trailer production lines without significant process changes.

EPA is adopting CO<sub>2</sub> emission standards for long box vans for MY 2018 that represent stringency levels similar to the current performance level needed for SmartWay's verification and those required for the current California regulation. These standards can be met by adopting off-the-shelf aerodynamic and tire technologies available today. The agencies are adopting less stringent requirements for manufacturers of other highway trailer subcategories beginning in MY 2018 that can be met without use of aerodynamic technologies. Given that these technologies are readily available and are already familiar to the industry, the agencies believe, for both cases, that manufacturers have sufficient lead time to adopt these technologies and to implement the simplified compliance provisions introduced below and described fully in Section IV.E.

NHTSA's direction under EISA is to allow four model years of lead-time for new fuel consumption standards, regardless of the stringency level or availability of flexibilities. Therefore, NHTSA's fuel consumption

requirements are not mandatory until MY 2021. Prior to MY 2021, trailer manufacturers could voluntarily participate in NHTSA's program, noting that once they made such a choice, they will need to stay in the program for all succeeding model years.<sup>344</sup>

We believe there are technology pathways available today that manufacturers could use to comply with the standards when they are fully implemented in MY 2027. The agencies designed each three-year stage of the program as a gradual progression of stringency that provides sufficient lead-time for all affected trailer manufacturers to evaluate and adopt CO<sub>2</sub>- and fuel consumption-reducing technologies or design trailers to meet these standards while meeting their customers' needs. The agencies believe that the burdens of installing and marketing these CO<sub>2</sub>- and fuel consumption-reducing technologies at the stringency levels of this program are not limiting factors in determining necessary lead-time for manufacturers of these trailers. Instead, we expect that the first-time compliance and, in some cases, performance testing, will be more challenging obstacles for this newly regulated industry. For these reasons, the standards phase in over a period of nine years, with flexibilities to minimize the compliance and testing burdens especially in the early years of the program (see Section IV.E.). We are adopting provisions for manufacturers to use a GEM-based compliance equation in lieu of the GEM vehicle simulation tool, which will reduce the number of resources required to learn and implement the model. We are also finalizing compliance provisions that allow trailer manufacturers to use pre-approved aerodynamic test data from aerodynamic device manufacturers, which could eliminate a trailer manufacturer's test burden for compliance. As explained above, non-aero box vans and non-box trailers, which make up almost 20 percent of the regulated trailers, are subject to straightforward design-based tire standards throughout the program that require that they install qualified LRR tires and tire pressure systems with simplified compliance requirements. See Section IV.E. for a full description of the trailer compliance program.

The Rubber Manufacturers Association (RMA) expressed concern that the proposed program would not provide sufficient lead time for the development and production of LRR tire designs for some off-road applications.

As discussed above, the final program now excludes all trailer types that would generally be used in off-road applications, including all non-box trailers except tanks, flatbeds, and container chassis. Therefore, trailer types designed for off-road use do not have LRR tire requirements, and the final program should significantly reduce RMA's concerns about available lead time for special tire development. Additionally, we have adjusted the tire performance requirements for the LRR tires of the non-box trailer design standards.

#### D. Feasibility of the Trailer Standards

As discussed below, the agencies' determination is that the standards presented in Section IV.C.(2), are the maximum feasible and appropriate under the agencies' respective authorities, considering lead time, cost, and other factors. We summarize our analyses in this section, and describe them in more detail in RIA Chapter 2.10.

Our analysis of the feasibility of the CO<sub>2</sub> and fuel consumption standards is based on technology cost and effectiveness values collected from several sources. Our assessment of the trailer program is based on information from:

- Southwest Research Institute evaluation of heavy-duty vehicle fuel efficiency and costs for NHTSA,<sup>345</sup>
- 2010 National Academy of Sciences report of Technologies and Approaches to Reducing the Fuel Consumption of Medium- and Heavy-Duty Vehicles,<sup>346</sup>
- TIAX's assessment of technologies to support the NAS panel report,<sup>347</sup>
- The analysis conducted by the Northeast States Center for a Clean Air Future, International Council on Clean Transportation, Southwest Research Institute and TIAX for reducing fuel consumption of heavy-

<sup>345</sup> Reinhardt, T.E. (June 2015). Commercial Medium- and Heavy-Duty Truck Fuel Efficiency Technology Study—Report #1. (Report No. DOT HS 812 146). Washington, DC: National Highway Traffic Safety Administration.

<sup>346</sup> Committee to Assess Fuel Economy Technologies for Medium- and Heavy-Duty Vehicles; National Research Council; Transportation Research Board (2010). Technologies and Approaches to Reducing the Fuel Consumption of Medium- and Heavy-Duty Vehicles. ("The NAS Report") Washington, DC, The National Academies Press. Available electronically from the National Academy Press Web site at [http://www.nap.edu/catalog.php?record\\_id=12845](http://www.nap.edu/catalog.php?record_id=12845).

<sup>347</sup> TIAX, LLC. "Assessment of Fuel Economy Technologies for Medium- and Heavy-Duty Vehicles." Final Report to National Academy of Sciences, November 19, 2009.

<sup>343</sup> The Clean Air Act (42 U.S.C. 7671) uses the term "appliance" to refer to TRUs and other similar equipment.

<sup>344</sup> NHTSA adopted a similar voluntary approach in the first years of Phase 1 (see 76 FR 57106).



duty long haul combination tractors (the NESCCAF/ICCT study),<sup>348</sup>  
 —The technology cost analysis conducted by ICF for EPA,<sup>349</sup> and  
 —Testing conducted by EPA.

As an initial step in our analysis, we identified the extent to which fuel consumption- and CO<sub>2</sub>-reducing technologies are in use today. The technologies include those that reduce aerodynamic drag at the front, back, and underside of trailers, tires with lower rolling resistance, tire pressure technologies, and weight reduction through component substitution. For our feasibility analysis, we identified a set of technologies to represent the range of those likely to be used in the time frame of the rule. The agencies developed the CO<sub>2</sub> and fuel consumption standards for each stage of the program by combining the projected effectiveness of trailer technologies and the projected adoption rates for each trailer type. It should be noted that the agencies need not and did not attempt to predict the exact future pathway of the industry's response to the new performance standards for box vans. Rather, we demonstrated one example compliance pathway that could reasonably occur, taking into account cost of the standards (including costs of compliance testing and certification), and needed lead time. More details regarding our analysis can be found in Chapter 2.10 of the RIA.

#### (1) Technological Basis of the Standards

Trailer manufacturers can design a trailer to reduce fuel consumption and CO<sub>2</sub> emissions by addressing the trailer's aerodynamic drag, tire rolling resistance, and weight. Accordingly, the agencies investigated aerodynamic technologies (*e.g.*, skirts and tails), low rolling resistance tires, tire pressure systems, and materials that could be used to reduce trailer weight. A description of these technologies, including their expected performance, can be found in Chapter 2.10.2 of the RIA. For box vans, the analysis below presents one possible set of technology designs by which trailer manufacturers could reasonably achieve the standards. However, in practice, trailer manufacturers could choose different technologies, versions of technologies, and combinations of technologies that meet the business needs of their

customers while complying with this program.

To minimize complexity, a single van is used to represent each box van trailer subcategory in compliance and in our feasibility analysis. Within the short box dry and refrigerated van subcategories (50-foot and shorter), the largest fraction of those trailers are 28 feet in length. Similarly, 53-foot vans make up the majority of the long box dry and refrigerated vans. Consequently, a 28-foot dry van is used to represent all lengths of short dry vans and a 53-foot dry van represents all lengths of long dry vans in this analysis and for compliance. Similar lengths represent the short and long refrigerated van subcategories. This means that manufacturers do not need to analyze the performance of devices for each trailer length in each subcategory. This approach provides a conservative estimate of CO<sub>2</sub> emissions and fuel consumption reductions for the longer vans within a given length subcategory,<sup>350</sup> but the agencies believe that the need to avoid an overly complex compliance program, reinforced by most of the industry comments, justifies this approach.

#### (a) Aerodynamic Technologies

For box vans under these rules, aerodynamic performance of tractor-trailers is evaluated using a vehicle's aerodynamic drag area, C<sub>d</sub>A. However, unlike the tractor program, the performance of trailer technologies is quantified using changes in C<sub>d</sub>A (or "delta C<sub>d</sub>A") rather than absolute values. This delta C<sub>d</sub>A classification methodology, which measures improvement in performance relative to a baseline, is similar to the SmartWay technology verification program with which most long box van manufacturers are already familiar. The one difference is that, although EPA's SmartWay aerodynamic verification program uses a relative improvement, the metric is a percent fuel savings, whereas the compliance program for Phase 2 uses change in drag area, delta C<sub>d</sub>A. Chapter 2.10.2.1.1 of the RIA provides a comparison of the SmartWay and Phase 2 metrics.

The agencies proposed to use a delta C<sub>d</sub>A measured at zero-yaw (head-on wind) in the trailer aerodynamic test procedures (80 FR 40277). However, comments from several stakeholders

including ACEEE, CARB, ICCT, RMA, STEMCO, and Utility suggested that measurements that account for cross-wind provide a more appropriate measure of the benefits these technologies would experience in the real world, especially for technologies that are effective when the wind is at an angle. The agencies evaluated our own aerodynamic test data, including data collected to justify use of wind-average results in the proposed tractor program, and we recognize that the drag coefficient increases under cross-wind conditions likely seen in real-world operation. Since wind-averaging will account for this, and more appropriately capture aerodynamic benefits from many devices, including several small-scale devices, we are adopting a wind-averaged approach for aerodynamic testing in the trailer program. See Section IV.E.(3)(b)(ii) below and Chapter 2.10.2.1.2 of the RIA for a summary of yaw-angle effect as observed in our aerodynamic testing. The feasibility analysis that follows was performed using wind-averaged delta C<sub>d</sub>A values.

#### (i) Aerodynamic Technologies for Non-Box Trailers

The agencies are aware that some side skirts have been adapted for the non-box trailers considered in this rule (*e.g.*, tank trailers, flatbeds, and container chassis). CARB submitted comments noting that some of these technologies have shown potential for large reductions in drag. At this time, however, we are unable to sufficiently assess the degree of CO<sub>2</sub> and fuel consumption improvement that could generally be achieved across this segment of the industry and the associated costs of these technologies. In the case of each of the general non-box trailer types included in the trailer program, the range of physical trailer designs, including the areas where aerodynamic devices would be installed, is great, and technologies to date tend to be designed for narrow applications. This lack of basic information about the applicability of future technologies for these trailer types also inhibits our ability to estimate costs, either of the specific future designs themselves or of the size of the market for any particular product. As a result, we expect that standards predicated on aerodynamic technologies for these trailer types could result in relatively little emission and fuel consumption improvement at relatively high costs. We will continue to monitor this segment of the trailer industry in this regard and may consider further action in the future.

The agencies proposed to adopt design-based tire standards (*i.e.*

<sup>348</sup> NESCCAF, ICCT, Southwest Research Institute, and TLAX. Reducing Heavy-Duty Long Haul Combination Truck Fuel Consumption and CO<sub>2</sub> Emissions. October 2009.

<sup>349</sup> ICF International. "Investigation of Costs for Strategies to Reduce Greenhouse Gas Emissions for Heavy-Duty On-Road Vehicles." July 2010. Docket Number EPA-HQ-OAR-2010-0162-0283.

<sup>350</sup> For example, aerodynamic devices on a 48 foot box van will perform somewhat better than on a 28 foot box van, so our analysis likely underestimates the benefits of these technologies. See Chapter 2.10.2.1.2.6 of the RIA and Memorandum to Docket EPA-HQ-OAR-2014-0827. "

standards not predicated on any aerodynamic technology, and for which neither GEM nor the GEM-based equation is required) for these trailers to eliminate the need for performance testing and to reduce the overall compliance burden for these manufacturers. 80 FR 40257. The data submitted and adoption rates suggested by CARB would not provide a large enough reduction in CO<sub>2</sub> and fuel consumption from non-box trailer aerodynamics to justify the increased burden on these manufacturers. In addition, we believe that there is not currently sufficient information to develop aerodynamic performance standards on these relatively new and untried technologies. Consequently, we are adopting design-based tire technology standards for non-box trailers, as proposed. Non-box trailer manufacturers may include aerodynamic improvements in their future trailer designs, but non-box trailer aerodynamic devices cannot be used for compliance at any point in the Phase 2 program.

#### (ii) Aerodynamic Technologies for Box Vans

EPA collected aerodynamic test data for several tractor-trailer configurations equipped with technologies similar to common SmartWay-verified technologies. As mentioned previously, SmartWay-verified technologies are evaluated on 53-foot dry vans. However, the CO<sub>2</sub>- and fuel consumption-reducing potential of some aerodynamic technologies demonstrated on 53-foot dry vans can be translated to refrigerated vans and box trailers of other lengths. Some fleets have opted to add trailer skirts to their refrigerated vans and 28-foot trailers and our testing included dry vans of length 53-foot, 48-foot, 33-foot, and 28-foot.<sup>351</sup>

In order to evaluate performance and cost of the aerodynamic technologies, the agencies identified “packages” of individual or combined technologies that are being sold today on box trailers. The agencies also identified distinct performance levels (*i.e.*, bins) for these technology packages based on EPA’s aerodynamic testing. All technology packages that produce similar improvements in drag would be categorized as meeting the same bin level of performance. The agencies recognize that there are other technology options that have similar performance to those that we analyzed. We chose the technologies presented

here based on their current adoption rates and availability of test data.

The agencies are adopting a regulatory structure for box trailers with seven bins to evaluate aerodynamic performance. Note that these bins are slightly different than those proposed. We adjusted the aerodynamic bins to reflect additional data and the use of wind-averaged results. The most notable difference is that we expanded the width of the lower bins. The NPRM Bins III, IV and V were reduced to two bins. Bins V, VI, and VII are identical to the highest bins from the NPRM (NPRM bins VI, VII, and VIII). See Chapter 2.10.2.1.3 of the RIA for a complete description of the development of these bins.

In the final trailer program, Bin I represents a base trailer with no aerodynamic technologies added and a delta C<sub>d</sub>A of zero. Bin II is intended to capture aerodynamic devices that achieve small reductions in CO<sub>2</sub> and fuel consumption. Some gap reducers may achieve Bin II on long dry vans, and most individual devices (*e.g.*, skirts or tails) will achieve this bin for short box vans. We expect a majority of single aerodynamic devices to perform in the range of Bins III through IV for long box vans. Combinations of devices are expected to meet Bin III for short vans and Bin V or Bin VI levels of performance for long vans. Bin VI represents the more optimized combinations of technologies on long vans. The agencies observed one device combination that met Bin VI in our aerodynamic testing and did not observe any combinations that meet Bin VII. This final level is designed to represent aerodynamic improvements that may become available in the future, including aerodynamic devices yet to be designed or approaches that incorporate changes to the design of trailer bodies. The agencies believe there is ample lead time to optimize additional existing Bin V combinations such that they can also meet Bin VI by MY 2027. However, none of the standards are predicated on the performance of Bin VII aerodynamic improvements. See Table IV–14 and accompanying text.

Table IV–5 illustrates the bin structure that the agencies are adopting as the basis for box vans to demonstrate compliance. The agencies believe these bins apply to all box vans (dry and refrigerated vans of various lengths). Although the underlying test data from EPA’s aerodynamic testing program reflect some variation due to differences in test methods, as well as differences in trailer and aerodynamic device models, the agencies believe that each of these bins covers a wide enough range

of delta C<sub>d</sub>As to account for the uncertainty. See RIA Chapter 2.10 for more information.

When manufacturers obtain test results, they would check the range shown in Table IV–5 for the measured C<sub>d</sub>A value and use the corresponding input value for compliance. Note that these are wind-averaged results, as described in Chapter 2.10 of the RIA and below in Section IV.E.(3)(b)(ii). Also, the input is a threshold and not an average of the bin range. Consequently, the compliance results will be a conservative estimate of the performance of most technologies that achieve a given bin.<sup>352</sup>

TABLE IV–5—TECHNOLOGY BINS USED TO EVALUATE TRAILER BENEFITS AND COSTS

Bin	Delta C <sub>d</sub> A	
	Measured value	Input value for compliance
Bin I .....	<0.10 .....	0.0
Bin II .....	0.10–0.39 .....	0.1
Bin III .....	0.40–0.69 .....	0.4
Bin IV .....	0.70–0.99 .....	0.7
Bin V .....	1.00–1.39 .....	1.0
Bin VI .....	1.4–1.79 .....	1.4
Bin VII .....	≥1.80 .....	1.8

To develop the standards for box trailers, the agencies assessed the CO<sub>2</sub> emissions and fuel consumption impacts of the aerodynamic bins using an equation based on the GEM vehicle simulation tool. See Section II and Section IV.E. (1) for more information about GEM and Chapter 2.10.5 of the RIA for our development of the GEM-based equation. Within GEM, and reflected in the results of the equation, the aerodynamic performance of each box van subcategory is evaluated by subtracting the delta C<sub>d</sub>A shown in Table IV–5 from the C<sub>d</sub>A value representing a specific standard tractor pulling a trailer with no CO<sub>2</sub>- or fuel consumption-reducing technologies (*i.e.*, a “no-control” trailer). In other words, the tractor-trailer is simulated with improvements to the baseline trailer. The agencies chose to model the no-control long box dry van using a C<sub>d</sub>A value of 6.0 m<sup>2</sup> (the mean wind-averaged C<sub>d</sub>A from EPA’s wind tunnel

<sup>352</sup> This is in contrast to the tractor program where manufacturers obtain absolute C<sub>d</sub>A values in tractor aerodynamic testing. The tractor results are corrected to coastdown values before applying them to bins and obtaining a bin-average value as a compliance input. Trailers measure a delta C<sub>d</sub>A and do not have a correction to a reference method (see Section IV.E.(3)(b)). The lower threshold approach adopted for the trailer compliance inputs limits the chance of over-predicting performance when a reference method correction is not applied.

<sup>351</sup> Although, as noted above, compliance testing (where required) uses either a 28 foot van or 53 foot van to simplify the compliance process.

testing). The single, short box dry vans showed lower  $C_dA$  values compared to its 53-foot counterpart in EPA's wind tunnel testing with an average of 5.6 m<sup>2</sup>. The agencies did not test any refrigerated vans, but we assumed a refrigerated van's TRU would behave similar to a gap reducer. Our test results in Chapter 2.10.2.1.3 did not show gap reducer technologies to have a significant effect on  $C_dA$  and the agencies accordingly assigned the same default  $C_dA$  to refrigerated and dry box vans in GEM. Note that the trailer subcategories that have design standards (*i.e.*, non-box and non-aero box trailers) do not have numerical standards to meet, and do not have defaults in GEM. Table IV-6 illustrates the no-control drag areas ( $C_dA$ ) associated with each trailer subcategory.

TABLE IV-6—DEFAULT AERODYNAMIC DRAG AREA ( $C_dA$ ) VALUES ASSOCIATED WITH EACH (NO-CONTROL) TRAILER MODELED IN GEM

Trailer subcategory	$C_dA$ (M <sup>2</sup> )
Long Dry Van .....	6.0
Short Dry Van .....	5.6
Long Ref. Van .....	6.0
Short Ref. Van .....	5.6

Current "boat tail" devices, applied to the rear of a trailer with rear swing doors, are typically designed to collapse flat as the trailer rear doors are opened. If the tail structure can remain in the collapsed configuration when the doors are closed, the benefit of the device is lost. We requested comment on whether we should require that trailer manufacturers using such devices for compliance with these standards only use designs that automatically deploy when the vehicle is in motion. STEMCO commented that automatic deployment should not be required, since those systems are more expensive, and in their view, not necessary for the Phase 2 program. STEMCO believes that, since there is a strong economic incentive for operators to ensure that the devices are correctly deployed in order to achieve the greatest fuel cost payback, a regulatory requirement related to deployment is not needed. We generally agree, and have not included such a requirement in the final trailer program. For this analysis, we consider all boat tails to be properly deployed.

The agencies are aware that physical characteristics of some box trailers influence the technologies that can be applied. For instance, the TRUs on refrigerated vans are located at the front of the trailer, which prevents the use of current gap-reducers, either by

occupying the space that a front-end fairing would use, or by blocking air flow that the TRU needs for cooling purposes. Similarly, drop deck dry vans have lowered floors between the landing gear and the trailer axles that limit the ability to use side skirts. We discuss another example, roll-up rear doors, in Section IV.C.(1)(a) above. The agencies considered the availability and limitations of aerodynamic technologies for each trailer type evaluated in our feasibility analysis of the standards.

(b) Tire Rolling Resistance

Similar to the Phase 2 tractor and vocational vehicle programs, the agencies are adopting standards based on adoption of lower rolling resistance tires. While some box vans continue to be sold with tires of higher rolling resistances, the agencies believe most box van tires currently achieve a tire  $C_{RR}$  of 6.0 kg/ton or better. Feedback from several box trailer manufacturers indicates that the standard tires offered on their new trailers are SmartWay-verified tires (*i.e.*,  $C_{RR}$  of 5.1 kg/ton or better). An informal survey of members from the Truck Trailer Manufacturers Association (TTMA) in 2014 indicates about 85 percent of box vans sold at that time had SmartWay tires.<sup>353</sup>

The agencies evaluated two levels of tire performance for box vans beyond the baseline trailer tire rolling resistance level (TRRL) of 6.0 kg/ton. The first performance level was set at the criteria for SmartWay-verification for trailer tires, 5.1 kg/ton, which is a 15 percent reduction in  $C_{RR}$  from the baseline. As mentioned previously, several tire models available today achieve rolling resistance values well below the present SmartWay threshold. Given the multiple year phase-in of the standards, the agencies expect that tire manufacturers will continue to respond to demand for more efficient tires and will offer increasing numbers of tire models with rolling resistance values significantly better than today's typical LRR tires. In this context, we believe it is reasonable to expect a large fraction of the trailer industry could adopt tires with rolling resistances at a second performance level that will achieve an additional reduction in rolling resistance, especially in the later stages of the program. The agencies project the  $C_{RR}$  for this second level of performance to be a value of 4.7 kg/ton (a 22 percent reduction from the baseline tire).

The vast majority of box van miles occur on-road, and current LRR tire

designs are appropriate and effective for those applications. We note that current designs of LRR tires may not be appropriate for some non-box trailer types, including those that operate significantly in off-road conditions. We expect that the tire manufacturing industry will continue to expand their offerings of tire designs to additional applications. Regardless, by limiting the non-box trailer types covered by the final trailer program to those generally used in on-highway applications (tanks, flatbeds, and container chassis), the program avoids most of these potential situations.

We received comment from Michelin supporting the use of 6.0 kg/ton as the box trailer tire rolling resistance baseline, but they expressed concern that the SmartWay threshold of 5.1 kg/ton does not apply for non-box trailers, and could compromise their operation. Similarly, the Rubber Manufacturers Association indicated that a baseline of 6.0 kg/ton does not apply to non-box trailers. The agencies agree that the baseline tires for non-box trailers should have a higher rolling resistance, but we did not receive any comments that included  $C_{RR}$  data. For the analysis for the final rules, the agencies revised the baseline  $C_{RR}$  to a value of 6.5 kg/ton for non-box trailer manufacturers. The updated non-box trailer designs standards require LRR tires of 6.0 kg/ton in the first stage of the program and 5.1 kg/ton in the later years. Nowhere in the final program do we require Level 4 tires for non-box trailers.

The agencies evaluated four tire rolling resistance levels, summarized in Table IV-7, in the feasibility analysis of the following sections. It should be noted that these levels are targets for setting the stringency of the box van performance standards and rolling resistance thresholds for the non-box design standards. For compliance, box van manufacturers have the option to use tires with any rolling resistance and are not be limited to these TRRLs.

TABLE IV-7—SUMMARY OF TRAILER TIRE ROLLING RESISTANCE LEVELS EVALUATED

Tire rolling resistance level	$C_{RR}$ (kg/ton)
Level 1 (Non-Box Baseline)	6.5
Level 2 (Box Van Baseline)	6.0
Level 3 .....	5.1
Level 4 .....	4.7

(c) Tire Pressure Systems

Tire pressure monitoring systems (TPMS) and automatic tire inflation systems (ATIS) are designed to address under-inflated tires. Both systems alert

<sup>353</sup> Letter, Truck Trailer Manufacturers Association to EPA. Received on October 16, 2014. Docket EPA-HQ-OAR-2014-0827-0146.

drivers if a tire's pressure drops below its set point. TPMS are simpler and merely monitor tire pressure. Thus, they require user-interaction to reinflate to the appropriate pressure. Today's ATIS, on the other hand, typically take advantage of trailers' air brake systems to supply air back into the tires (continuously or on demand) until a selected pressure is achieved. In the event of a slow leak, ATIS have the added benefit of maintaining enough pressure to allow the driver to get to a safe stopping area. See Chapter 2.10.2.3 of the RIA for more on tire pressure systems.

The agencies proposed that ATIS be the only tire pressure system allowed to be used to meet the standards, since TPMS require action on the part of the operator. Our position at the time of the proposal was that TPMS could not sufficiently guarantee proper inflation. 80 FR 40262. However, some commenters stated that TPMS are effective in encouraging proper tire pressure maintenance, and should also be eligible as a compliance option. Commenters did not provide specific data about the overall effectiveness of TPMS. However, we are aware of the emergence of TPMS that use telematics to automatically report tire pressure data to a central contact. It is also our understanding that there is a growing recognition among fleet and individual operators of the potential value that these systems can provide to operators, so long as the operator and/or a central fleet contact take action to address cases of low tire pressures indicated by the systems. These factors have led the agencies to reconsider our approach to TPMS. As described in Section IV.B. above, we now believe that TPMS provides overall fuel consumption and CO<sub>2</sub> reductions, and the final program recognizes the option of TPMS as part of the compliance path for all covered trailers.

NHTSA and EPA recognize the role of proper tire inflation in maintaining optimum tire rolling resistance during normal trailer operation. Rather than require performance testing of tire pressure systems, the agencies recognize the benefits of these systems, and the program applies default reduction values for manufacturers that incorporate ATIS or TPMS into their trailer designs. Based on information available today, we believe that most tire pressure technologies and systems in typical use perform similarly.

We proposed to assign a 1.5 percent reduction in CO<sub>2</sub> and fuel consumption for all trailers that implement ATIS, based on information available at that

time.<sup>354</sup> We did not receive any comments directly addressing the proposed reduction value. However, the agencies believed it was appropriate to align the effectiveness of tire pressure systems for tractors, trailers and vocational vehicles, and the agencies are adopting a 1.2 percent reduction for ATIS for each of these vehicle categories. As just noted, we are also adopting provisions that recognize a CO<sub>2</sub> and fuel consumption reduction for TPMS. The agencies believe that sufficient incentive exists for truck operators to address low tire pressure conditions if they are notified that they exist through a TPMS (for example, for reasons of personal safety as well as fuel savings). However, we recognize the dependence on operator action for TPMS, and we are adopting a reduction of 1.0 percent for these systems. We have concluded that the use of these systems can consistently ensure that tire pressure and tire rolling resistance are maintained. Sections III.D.(1)(b) and V.C.(1)(a) also discuss the overall Phase 2 program's treatment of both types of tire pressure systems for tractors and vocational vehicles, respectively.

We selected the standards for most box vans with the expectation that a high rate of adoption of ATIS will occur during all years of the phase-in of the program, and that manufacturers of non-aero vans, and non-box trailers will install either TPMS or ATIS, as well as LRR tires, to comply with the design-based tire standards.

In the performance-based compliance approach to full- and partial-aero box vans, the program incorporates a small discount in the value of TPMS in the compliance equation as compared to ATIS, to reflect the inherent user interaction required for TPMS to be effective. In the design-based compliance approach for non-aero vans and non-box trailers, manufacturers may comply by using either TPMS or ATIS, which in that case are valued equally. See Section IV.D.(2)(d) below for discussion of our estimates of the degree of adoption of tire pressure systems prior to and at various points in the phase-in of the proposed program.

#### (d) Weight Reduction

As proposed, the trailer program provides manufacturers the option of complying through the substitution of specified lighter-weight components that can be clearly isolated from the trailer as a whole. In the proposal, the agencies identified several conventional components with lighter-weight substitutes that are currently available

(e.g., substituting conventional dual tires mounted on steel wheels with wide-based single tires mounted on aluminum wheels). 80 FR 40262. Several commenters provided additional component suggestions, with information about their typical associated weight reductions. The component substitutions we have included in the final program, and the weight savings that we are associating with each component, are presented in the RIA Chapter 2.10.2.4 and 40 CFR 1037.515. The agencies have identified 12 common trailer components for which lighter weight options are currently available (see 40 CFR 1037.515).<sup>355 356 357 358</sup> Manufacturers that adopt these technologies and choose to use them as part of their compliance strategy sum the associated weight reductions and apply those values in the GEM-based compliance equation (see Section IV.E.(2)(a)). We believe that the initial cost of these component substitutions is currently substantial enough that only a relatively small segment of the industry has adopted these technologies today.

There is no clear "baseline" for current trailer weight against which lower-weight designs could be compared for regulatory purposes. For this reason, the agencies do not believe it is appropriate or fair across the industry to apply overall weight reductions toward compliance using a universal baseline trailer. However, the agencies do believe it is appropriate to give a manufacturer credit for overall weight reduction achieved in their own product line. In the final program, we are clarifying that manufacturers of box trailers with significant weight reductions have the option of using our off-cycle credit process to compare overall weight reduction of future trailers using an appropriate baseline from their own production. This process allows manufacturers to do a comparison of their new trailer to a previous model to quantify the weight reduction improvements. Manufacturers wishing to go this route should contact

<sup>355</sup> Scarcelli, Jamie. "Fuel Efficiency for Trailers" Presented at ACEEE/ICCT Workshop: Emerging Technologies for Heavy-Duty Vehicle Fuel Efficiency, Wabash National Corporation. July 22, 2014.

<sup>356</sup> "Weight Reduction: A Glance at Clean Freight Strategies," EPA SmartWay. EPA420F09-043. Available at: <http://permanent.access.gpo.gov/gpo38937/EPA420F09-043.pdf>.

<sup>357</sup> Memorandum dated June 2015 regarding confidential weight reduction information obtained during SBREFA Panel. Docket EPA-HQ-OAR-2014-0827.

<sup>358</sup> Randall Scheps, Aluminum Association, "The Aluminum Advantage: Exploring Commercial Vehicles Applications," presented in Ann Arbor, Michigan, June 18, 2009.

<sup>354</sup> See Chapter 2.10.2.3 of the RIA.

EPA in advance to discuss appropriate test procedures. More information about the off-cycle process can be found in Section IV.E.(5)(d) and in 40 CFR 1037.610 or 49 CFR 535.7. Note that non-box trailers and non-aero box vans have design standards that are limited to adoption of lower rolling resistance tires and tire pressure systems, and do not include weight reduction as part of their simplified compliance demonstration.

The agencies recognize that when weight reduction is applied to a trailer, some operators will replace that saved weight with additional payload. To account for this in the average vehicle represented by EPA’s GEM vehicle simulation tool, it is assumed that one-third of any weight reduction will be applied to the payload. Wabash suggested that the agencies reconsider the distribution of weight between payload and trailer weight when modeling weight reduction, expressing concern that the reduction was not receiving appropriate credit in the program. Although the simulated vehicle in GEM only receives 2/3 of the weight reduction applied, the model calculates CO<sub>2</sub> emissions and fuel consumption on a per-ton-mile basis by dividing by the payload, which now includes the extra one-third from weight reduction. Dividing by a larger payload results in lower CO<sub>2</sub> and fuel consumption values.<sup>359</sup>

For 53-foot vans simulated in GEM (and thus, for the GEM-based equation), it takes a weight reduction of nearly 1,000 pounds before a one percent fuel savings is achieved. The impact of the same 1000 pounds is slightly greater for shorter vans, due to their lower overall

weight, but the effectiveness of weight reduction is still relatively low compared to the effectiveness of many aerodynamic technologies. In addition, large material substitutions can be costly. The agencies thus believe that few trailer manufacturers will apply weight reduction solely as a means of achieving reduced fuel consumption and CO<sub>2</sub> emissions. Therefore, we are adopting standards that could be met without reducing weight—that is, the feasible compliance path set out by the agencies for this program does not assume weight reduction as a compliance avenue. However, as discussed here, the final program includes the option for box trailer manufacturers to apply weight reduction to some of their trailers as part of their compliance strategy.

(2) Effectiveness, Adoption Rates, and Costs of Technologies for the Trailer Standards

The agencies evaluated the technologies above as they apply to each of the trailer subcategories. The next sections describe the effectiveness, adoption rates and costs associated with these technologies. The effectiveness and adoption rate projections were used to derive these standards.

(a) No-Control Default Tractor-Trailer Vehicles in GEM (Box Van Standards Only)

The regulatory purpose of EPA’s heavy-duty vehicle compliance tool, GEM, is to combine the effects of trailer technologies through simulation so that they can be expressed as g/ton-mile and gal/1000 ton-mile and thus avoid the

need for direct testing of each trailer being certified. All of the standards for box vans (with the exception of non-aero box vans, which have design standards) use an equation derived from GEM to demonstrate compliance. The trailer program has separate performance standards for each box van subcategory (again, with the exception of non-aero box vans) and each of these subcategories is modeled as a tractor-trailer combination that we believe reflects the average physical characteristics and use pattern of vans in that subcategory. Long vans are pulled by sleeper cab tractors and use the long-haul drive cycle weightings. Short vans are pulled by day cabs and have the short-haul drive cycle weightings. Short vans also have a lighter payload and overall vehicle weight compared to their longer counterparts.

Table IV–8 highlights the relevant vehicle characteristics for the no-control default of each subcategory (*i.e.*, zero CO<sub>2</sub>- or fuel consumption reducing technologies installed). Baseline trailer tires are used, and the drag area, which is a function of the aerodynamic characteristics of both the tractor and trailer, is set to the values shown previously in Table IV–6. Weight reduction and tire pressure systems are not applied in these default vehicles. Chapter 2.10 of the RIA provides a detailed description of the development of these default tractor-trailers. Note that the agencies proposed to use Class 8 tractors for all default tractor-trailer vehicles. However, we are adopting the final standards based on 4x2 Class 7 tractors for short box vans.

TABLE IV–8—CHARACTERISTICS OF THE NO-CONTROL DEFAULT TRACTOR-TRAILER VEHICLES IN GEM

Trailer length	Dry van		Refrigerated van	
	Long	Short	Long	Short
Standard Tractor:				
Class	Class 8	Class 7	Class 8	Class 7.
Cab Type	Sleeper	Day	Sleeper	Day.
Roof Height	High	High	High	High.
Axle Configuration	6 x 4	4 x 2	6 x 4	4 x 2.
Engine	2018 MY 15L, 455 HP ..	2018 MY 11L, 350 HP ..	2018 MY 15L, 455 HP ..	2018 MY 11L, 350 HP.
Steer Tire RR (kg/ton)	6.54	6.54	6.54	6.54.
Drive Tire RR (kg/ton)	6.92	6.92	6.92	6.92.
Drag Area, C <sub>d</sub> A (m <sup>2</sup> )	6.0	5.6	6.0	5.6.
Number of Trailer Axles	2	1	2	1.
Trailer Tire RR (kg/ton)	6.00	6.00	6.00	6.00.
Total Weight (kg)	31978	18306	33778	20106.
Payload (tons)	19	10	19	10.
Tire Pressure System Use	0	0	0	0.
Weight Reduction (lb)	0	0	0	0.
Drive Cycle Weightings:				
65-MPH Cruise	86%	64%	86%	64%.
55-MPH Cruise	9%	17%	9%	17%.

<sup>359</sup> Memorandum to Docket EPA–HQ–OAR–2014–0827, “Evaluation of Weight Reduction

Distribution in Response to Public Comments from Wabash National Corporation,” June 18, 2016.

TABLE IV-8—CHARACTERISTICS OF THE NO-CONTROL DEFAULT TRACTOR-TRAILER VEHICLES IN GEM—Continued

Trailer length	Dry van		Refrigerated van	
	Long	Short	Long	Short
Transient Driving .....	5% .....	19% .....	5% .....	19%.

(b) Effectiveness of Technologies  
 As already noted, the agencies recognize trailer improvements via four performance parameters: Aerodynamic drag reduction, tire rolling resistance reduction, the adoption of tire pressure systems, and weight-reducing strategies. Table IV-9 summarizes the performance levels the agencies evaluated for each of these parameters based on the technology characteristics outlined in Section IV.D.(1).

TABLE IV-9—PERFORMANCE PARAMETERS FOR THE TRAILER PROGRAM

Aerodynamics (Delta C <sub>d</sub> A, m <sup>2</sup> ):	
Bin I .....	0.0.
Bin II .....	0.1.
Bin III .....	0.4.
Bin IV .....	0.7.
Bin V .....	1.0.
Bin VI .....	1.4.
Bin VII .....	1.8.
Tire Rolling Resistance (C <sub>RR</sub> , kg/ton):	
Tire Level 1 .....	6.5.
Tire Level 2 .....	6.0.
Tire Level 3 .....	5.1.
Tire Level 4 .....	4.7.
Tire Inflation System (% reduction):	
ATIS .....	1.2.
TPMS .....	1.0.
Weight Reduction (lb):	
Weight .....	1/3 added to payload, remaining reduces overall vehicle weight.

These performance parameters have different effects on each trailer subcategory due to differences in the simulated trailer characteristics. Table IV-10 shows the agencies' estimates of the effectiveness of each parameter for the four box van types. Each technology was evaluated using the baseline parameter values for the other technology categories. For example, each aerodynamic bin was evaluated using the baseline tire (6.0 kg/ton) and the baseline weight reduction option (zero pounds). The table shows that aerodynamic improvements offer the largest potential for CO<sub>2</sub> emissions and fuel consumption reductions, making them relatively effective technologies.

TABLE IV-10—EFFECTIVENESS (PERCENT CO<sub>2</sub> EMISSIONS AND FUEL CONSUMPTION) OF TECHNOLOGIES FOR BOX VANS IN THE TRAILER PROGRAM

Aerodynamics	Delta C <sub>d</sub> A (m <sup>2</sup> )	Dry van		Refrigerated van	
		Long (%)	Short (%)	Long (%)	Short (%)
Bin I .....	0.0	0	0	0	0
Bin II .....	0.1	1	1	1	1
Bin III .....	0.4	3	3	3	3
Bin IV .....	0.7	5	5	5	5
Bin V .....	1.0	7	7	7	7
Bin VI .....	1.4	9	10	9	10
Bin VII .....	1.8	12	13	12	13
Tire Rolling Resistance	C <sub>RR</sub> (kg/ton)	Dry van		Refrigerated van	
		Long	Short	Long	Short
Level 1 .....	6.5	.....	.....	.....	.....
Level 2 .....	6.0	0	0	0	0
Level 3 .....	5.1	-2	-1	-2	-1
Level 4 .....	4.7	-3	-2	-3	-2
Weight Reduction	Weight (lb)	Dry van		Refrigerated van	
		Long	Short	Long	Short
Baseline .....	0	0	0	0	0

TABLE IV–10—EFFECTIVENESS (PERCENT CO<sub>2</sub> EMISSIONS AND FUEL CONSUMPTION) OF TECHNOLOGIES FOR BOX VANS IN THE TRAILER PROGRAM—Continued

Aerodynamics	Delta C <sub>d</sub> A (m <sup>2</sup> )	Dry van		Refrigerated van	
		Long (%)	Short (%)	Long (%)	Short (%)
Option 1 .....	100	0	0	0	0
Option 2 .....	500	1	1	1	1
Option 3 .....	1000	1	2	1	2
Option 4 .....	2000	2	4	2	4

(c) Baseline Tractor-Trailer To Evaluate Benefits and Costs

In order to evaluate the benefits and costs of the final standards for each of the ten subcategories, it is necessary to establish a reference point for comparison. As mentioned previously, the technologies described in Section IV.D.(1) exist in the market today, and their adoption is driven by available fuel savings as well as by the voluntary SmartWay Partnership and California’s tractor-trailer requirements. For these rules, the agencies identified baseline tractor-trailers for each trailer subcategory based on the technology adoption rates we project would exist in MY 2018 if this trailer program was not implemented.

CARB’s comments noted the informal survey of TTMA members provided in letter from TTMA to EPA in 2014 regarding current adoption rates of several technologies. CARB suggested that our proposed baseline adoption rates did not reflect the data in that letter.<sup>360</sup> We have reassessed available

data and we believe that higher baseline rates are more appropriate, and have made corresponding changes in our analysis. First, we created a separate baseline for box vans that qualify as full-aero, box vans that qualify as partial-aero, and box vans that qualify as non-aero. Because of the challenges of installing effective aerodynamic devices, market forces are not likely to significantly drive adoption of CO<sub>2</sub>- and fuel-consumption reducing technologies for trailers with work performing equipment (e.g., lift gates), and we are projecting zero adoption of the technologies in the baselines for partial- and non-aero box vans before the start of this program. Similarly, we assume that there will be zero adoption of these technologies for non-box trailers in the baseline. We updated the baseline tire rolling resistance level for non-box trailers to reflect the lower 6.5 kg/ton value in response to RMA’s comment that these trailers have different operational characteristics and should

not have the same baseline tires as box vans (see Section IV.D.(1)(b) above).

TTMA’s survey indicated that 35 percent of long vans and less than 2 percent of vans under 53-foot in length include aerodynamic devices, and over 80 percent have adopted lower rolling resistance tires. The agencies believe the trailers for which manufacturers have adopted these technologies are likely to be trailers that would qualify as “full-aero” vans, and we adjusted our baselines to reflect these values. Our baseline assumes that aerodynamics would increase to 40 percent adoption for full-aero long vans (dry and refrigerated) and 5 percent for full-aero short vans by 2018 without the Phase 2 standards. We also assume adoption of lower rolling resistance tires (Level 1) will increase to 90 percent and ATIS to 45 percent in the baseline. We held these adoption rates constant throughout the timeframe of the rules. Table IV–11 summarizes the updated baseline trailers for each trailer subcategory.

TABLE IV–11—ESTIMATED ADOPTION RATES AND AVERAGE PERFORMANCE PARAMETERS FOR THE FLAT BASELINE TRAILERS FOR MY 2018 AND LATER

Technology	Long vans	Short vans	All partial-aero, non-aero vans	All non-box trailers
<b>Aerodynamics:</b>				
Bin I .....	55%	95%	100%	100%
Bin II .....		5%		
Bin III .....	40%			
Bin IV .....	5%			
Bin V.				
Bin VI.				
Bin VII.				
<i>Average Delta C<sub>d</sub>A (m<sup>2</sup>)<sup>a</sup></i> .....	0.2	0.0	0.0	0.0
<b>Tire Rolling Resistance:</b>				
Level 1 .....				100%
Level 2 .....	10%	10%	100%	
Level 3 .....	90%	90%		
Level 4.				
<i>Average C<sub>RR</sub> (kg/ton)<sup>a</sup></i> .....	5.2	5.2	6.0	6.5
<b>Tire Pressure Systems:</b>				
ATIS .....	45%	30%		
TPMS.				
<i>Average Pressure System Reduction (%)<sup>a</sup></i> .....	0.5%	0.3%	0.0%	0.0%
<b>Weight Reduction:</b>				

<sup>360</sup> Letter, Truck Trailer Manufacturers Association to EPA. Received on October 16, 2014. Docket EPA–HQ–OAR–2014–0827–0146.

TABLE IV-11—ESTIMATED ADOPTION RATES AND AVERAGE PERFORMANCE PARAMETERS FOR THE FLAT BASELINE TRAILERS FOR MY 2018 AND LATER—Continued

Technology	Long vans	Short vans	All partial-aero, non-aero vans	All non-box trailers
<i>Weight (lb)<sup>b</sup></i>				

**Notes:**

A blank cell indicates a zero value.

<sup>a</sup> Combines adoption rates with performance levels shown in Table IV-9.

<sup>b</sup> Weight reduction was not projected for the baseline trailers.

Also shown in Table IV-11 are average aerodynamic performance (delta C<sub>d</sub>A), average tire rolling resistance (C<sub>RR</sub>), and average reductions due to use of tire pressure systems and weight reduction for each reference trailer. These values indicate the performance of theoretical average tractor-trailers that the agencies project would be in use in 2018 if no federal regulations were in place for trailer CO<sub>2</sub> and fuel consumption. The average tractor-trailer vehicles serve as baselines for each trailer subcategory.

Because the agencies cannot be certain about future trends, we also

considered a second baseline. This dynamic baseline reflects the possibility that, absent a Phase 2 regulation, there would be continuing adoption of aerodynamic technologies in the long box trailer market after 2018 that reduce fuel consumption and CO<sub>2</sub> emissions. This case assumes the research funded and conducted by the federal government, industry, academia and other organizations would, after 2018, result in the adoption of additional aerodynamic technologies beyond the levels required to comply with existing regulatory and voluntary programs. One example of such research is the

Department of Energy SuperTruck program which has a goal of demonstrating cost-effective measures to improve the efficiency of Class 8 long-haul freight trucks by 50 percent by 2015.<sup>361</sup> This baseline assumes that by 2040, 75 percent of new full-aero long vans would be equipped with SmartWay-verified aerodynamic devices. The agencies project that the lower rolling resistance tires and ATIS adoption would remain constant. Table IV-12 shows the agencies' projected adoption rates of technologies in the dynamic baseline.

TABLE IV-12—PROJECTED ADOPTION RATES AND AVERAGE PERFORMANCE PARAMETERS FOR THE DYNAMIC BASELINE FOR LONG DRY AND REFRIGERATED VANS  
[All other trailers are the same as Table IV-11]

Technology	Long dry and refrigerated					
	Model year	2018	2021	2024	2027	2040
<b>Aerodynamics:</b>						
Bin I .....		55%	50%	45%	40%	20%
Bin II .....						
Bin III .....		40%	45%	50%	55%	75%
Bin IV .....		5%	5%	5%	5%	5%
Bin V .....						
Bin VI .....						
Bin VII .....						
<i>Average Delta C<sub>d</sub>A (m<sup>2</sup>)<sup>a</sup></i> .....		0.2	0.3	0.3	0.3	0.4
<b>Tire Rolling Resistance:</b>						
Level 1 .....						
Level 2 .....		10%	10%	10%	10%	10%
Level 3 .....		90%	90%	90%	90%	90%
Level 4 .....						
<i>Average C<sub>RR</sub> (kg/ton)<sup>a</sup></i> .....		5.2	5.2	5.2	5.2	5.2
<b>Tire Pressure Systems:</b>						
ATIS .....		45%	45%	45%	45%	45%
TPMS .....						
<i>Average Pressure System Reduction (%)<sup>a</sup></i> .....		0.5%	0.5%	0.5%	0.5%	0.5%
<b>Weight Reduction (lbs):</b>						
<i>Weight<sup>b</sup></i> .....						

**Notes:**

A blank cell indicates a zero value.

<sup>a</sup> Combines adoption rates with performance levels shown in Table IV-9.

<sup>b</sup> Weight reduction was not projected for the baseline trailers.

The agencies applied the vehicle attributes from Table IV-8 and the average performance values from Table

IV-11 in the Phase 2 GEM vehicle simulation to calculate the CO<sub>2</sub> emissions and fuel consumption

performance of the baseline tractor-trailers. The results of these simulations are shown in Table IV-13. We used

<sup>361</sup> Daimler Truck North America. SuperTruck Program Vehicle Project Review. June 19, 2014. Docket EPA-HQ-OAR-2014-0827.



these CO<sub>2</sub> and fuel consumption values to calculate the relative improvements that will occur over time with a regulatory program. Note that the large difference between the per ton-mile values for long and short trailers is due primarily to the large difference in

assumed payload (19 tons compared to 10 tons) and the small difference between dry and refrigerated vans of the same length are due to differences in vehicle weight because of the 1800 pounds added to the simulated refrigerated vans to account for the TRU

(see the vehicle characteristics of the simulated tractor-trailers Table IV–8). The alternative baseline shown in Table IV–12 mainly impacts the long-term projections of benefits beyond 2027, which are analyzed in Chapters 5–7 of the RIA.

TABLE IV–13—CO<sub>2</sub> EMISSIONS AND FUEL CONSUMPTION RESULTS FOR THE BASELINE TRACTOR-TRAILERS

Length	Full-aero dry van		Full-aero refrigerated van		Partial-aero dry van		Partial-aero refrigerated van	
	Long	Short	Long	Short	Long	Short	Long	Short
CO <sub>2</sub> Emissions (g/ton-mile) .....	83.2	126.5	84.9	130.3	86.1	128.5	87.9	132.4
Fuel Consumption (gal/1000 ton-miles) .....	8.17289	12.42633	8.33988	12.79961	8.45776	12.62279	8.63458	13.00589

(d) Projected Technology Adoption Rates for the Trailer Standards

The agencies developed their performance and design standards based on projected adoption rates of certain technologies. This section describes how these adoption rates were applied for each of the trailer subcategories.

(i) Aerodynamic and Tire Technologies for Full- and Partial-Aero Box Vans

As described in Section 0, the agencies evaluated several alternatives for the trailer program. Based on our analysis and comments received, the agencies are adopting standards consistent with the agencies’ respective statutory authorities. The agencies proposed alternatives that were based on the use of averaging and the technology adoption rates for those alternatives at proposal reflected the use of averaging. As noted in Section IV.B., we received nearly unanimous, persuasive comments from the trailer industry opposing averaging and the agencies reconsidered the use of averaging in the early years of the program. The agencies designed the trailer program to have no averaging in MY 2018 through MY 2026. In those years, all box vans sold must meet the standards using any combination of available technologies. In MY 2027, when the trailer manufacturers are more comfortable with compliance and the industry is more familiar with the technologies, trailer manufacturers will have the option to use averaging to meet the standards. See Section IV.E.(5)(b) below for additional information about averaging.

Table IV–14 and Table IV–15 present sets of assumed adoption rates for aerodynamic, tire, and tire pressure technologies that a manufacturer could apply to meet the box van standards. Since averaging would not be allowed for MY 2018–MY 2026, the adoption rates consist of the combination of a

single aerodynamic bin (not reflecting any averaging of aerodynamic controls), tire rolling resistance level, and tire pressure system. As mentioned previously, manufacturers can choose other combinations to meet the standards. Chapter 2.10 of the RIA shows several examples of alternative compliance pathways.

The adoption rates in Table IV–14 begin with all full-aero long box vans achieving current SmartWay-level aerodynamics (Bin III) in MY 2018 with a stepwise progression to achieving Bin V in 2024. The adoption rates for full-aero short box vans in Table IV–15 assume no adoption of aerodynamic devices in MY 2018, adoption of single aero devices in MY 2021, and combinations of devices by MY 2024. Although the shorter lengths of these trailers can restrict the design of aerodynamic technologies that fully match the SmartWay-like performance levels of long boxes, we nevertheless expect that trailer and device manufacturers will continue to innovate skirt, under-body, rear, and gap-reducing devices and combinations to achieve improved aerodynamic performance on these shorter trailers.

The adoption rates in MY 2018–MY 2026 are projected to be 100 percent for each technology, instead of an industry average seen in other vehicle sectors in the Phase 2 program. Since we are not considering averaging during those years, each set of adoption rates is one example of how an individual trailer in each subcategory could comply. Through MY 2026, the standards are based on technologies that exist today. We evaluated one technology in our aerodynamic test programs that met Bin VI levels of performance for long vans, suggesting that this bin can be met with combinations of existing aerodynamic technologies, but none of our tested technologies that met Bin IV levels of performance for short vans. We could

not justify standards based on 100 percent adoption of those levels of performance as a final step in our progression of stringency. However, the industry has made great progress toward improving trailer aerodynamics in recent years and are continuing to optimize these technologies. Although we are not projecting fundamentally new technologies for trailers, we do believe aerodynamic performance will evolve in the trailer industry as a result of this rulemaking. Based on the recent rate of improvement, the agencies believe that there is ample lead time to optimize additional existing Bin V and Bin III combinations such that they can also meet Bins VI and IV by MY 2027 and it is reasonable to project that more than half of these full-aero capable trailers will have aerodynamic improvements greater than what is possible with today’s technologies. Our projected aerodynamic improvements in MYs 2027 and later reflect this performance potential.

The MY 2027 full-aero box van standards are based on an averaging program.<sup>362</sup> We cannot predict what technologies or trailer designs may be adapted to meet this level of aerodynamic performance, but an averaging program incentivizes manufacturers to develop advanced designs with the benefit that not all trailers in their production have to meet the same level of performance. The gradual increase in assumed adoption of aerodynamic technologies throughout the phase-in to the MY 2027 standards recognizes that even though many of the technologies are available today and technologically feasible throughout the phase-in period, adoption of more advanced technologies will likely take time. The adoption rates we are

<sup>362</sup> No averaging is allowed for partial-aero box van reduced standards, or the design-based standards for non-aero box vans and non-box trailers.

projecting in the interim years and the standards that we developed from these rates represent steady and reasonable improvement in aerodynamic performance.

We expect manufacturers of all box vans will adopt tires such as SmartWay-verified trailer tires (Level 3) to meet the standards in MY 2018 and will adopt tires with even lower rolling resistance

tires (represented as Level 4) as they become available by MY 2021 and later years and as fleet experience with these tires develops.

In establishing standard stringency, the agencies are also assuming that all box vans will adopt ATIS throughout the program, though manufacturers have the option to install TPMS if they would prefer to make up the difference in

effectiveness using other technologies. As mentioned previously, the agencies did not include weight reduction in their technology adoption projections, but certain types of weight reduction could be used as part of a compliance pathway, as discussed in Section IV.D.(1)(d) IV.D.(1)(d) above.

TABLE IV-14—PROJECTED ADOPTION RATES AND AVERAGE PERFORMANCE PARAMETERS FOR FULL-AERO LONG BOX VANS

Technology	Long box dry & refrigerated vans			
	2018	2021	2024	2027
Model year				
Aerodynamic Technologies:				
Bin I.				
Bin II.				
Bin III .....	100%			
Bin IV .....		100%		
Bin V .....			100%	30%
Bin VI .....				70%
Bin VII.				
Average Delta C <sub>d</sub> A (m <sup>2</sup> ) <sup>a</sup> .....	0.5	0.7	1.0	1.3
Trailer Tire Rolling Resistance:				
Level 1.				
Level 2 .....				5%
Level 3 .....	100%			
Level 4 .....		100%	100%	95%
Average C <sub>RR</sub> (kg/ton) <sup>a</sup> .....	5.1	4.7	4.7	4.8
Tire Pressure Systems:				
ATIS .....	100%	100%	100%	100%
TPMS.				
Average Pressure System Reduction (%) <sup>a</sup> .....	1.2%	1.2%	1.2%	1.2%
Weight Reduction:				
Weight (lb) <sup>b</sup> .				

**Notes:**

A blank cell indicates a zero value.

<sup>a</sup> Combines projected adoption rates with performance levels shown in Table IV-9.

<sup>b</sup> This set of adoption rates did not apply any assumed weight reduction to meet these standards for these trailers.

TABLE IV-15—PROJECTED ADOPTION RATES AND AVERAGE PERFORMANCE PARAMETERS FOR FULL-AERO SHORT BOX VANS

Technology	Short box dry & refrigerated vans			
	2018	2021	2024	2027
Model year				
Aerodynamic Technologies:				
Bin I.				
Bin II .....		100%		
Bin III .....			100%	40%
Bin IV .....				60%
Bin V.				
Bin VI.				
Bin VII.				
Average Delta C <sub>d</sub> A (m <sup>2</sup> ) <sup>b</sup> .....	0.0	0.1	0.4	0.6
Trailer Tire Rolling Resistance:				
Level 1.				
Level 2 .....				5%
Level 3 .....	100%			
Level 4 .....		100%	100%	95%
Average C <sub>RR</sub> (kg/ton) <sup>b</sup> .....	5.1	4.7	4.7	4.8
Tire Pressure Systems:				
ATIS .....	100%	100%	100%	100%
TPMS.				
Average Tire Pressure Reduction (%) <sup>c</sup> .....	1.2%	1.2%	1.2%	1.2%
Weight Reduction:				
Weight (lb) <sup>b</sup> .				

**Notes:**

A blank cell indicates a zero value.

<sup>a</sup> The majority of short box trailers are 28 feet in length. We recognize that they are often operated in tandem, which limits the technologies that can be applied (for example, boat tails).

<sup>b</sup> Combines projected adoption rates with performance levels shown in Table IV-9.

<sup>c</sup> This set of adoption rates did not apply any assumed weight reduction to meet these standards for these trailers.

The agencies proposed that the partial-aero box vans would track with the full-aero van standards until MY 2024. 80 FR 40257. Wabash commented that partial-aero box vans should be exempt starting in MY 2021 since partial-aero vans cannot use multiple devices. The agencies reconsidered the proposed partial-aero standards and

recognize that it would likely be difficult to meet the proposed MY 2024 standards without the use of multiple devices and yet partial-aero trailers, by definition, are restricted from using multiple devices. For these reasons, the agencies redesigned the partial-aero standards, such that trailers with qualifying work-performing equipment

can meet standards that would be achievable with the use of a single aerodynamic device throughout the program, similar to the MY 2018 standards. The partial-aero standards do, however, increase in stringency slightly in MY 2021, to reflect the broader use of improved lower rolling resistance tires.

TABLE IV–16—PROJECTED ADOPTION RATES AND AVERAGE PERFORMANCE PARAMETERS FOR PARTIAL-AERO BOX VANS

Technology Model year	Partial-aero long box vans		Partial-aero short box vans	
	2018	2021+	2018	2021+
<b>Aerodynamic Technologies:</b>				
Bin I.				
Bin II .....	100%	100%		100%
Bin III .....				
Bin IV.				
Bin V.				
Bin VI.				
Bin VII.				
Average Delta C <sub>d</sub> A (m <sup>2</sup> ) <sup>b</sup> .....	0.5	0.5	0.0	0.1
<b>Trailer Tire Rolling Resistance:</b>				
Level 1.				
Level 2.			100%	
Level 3 .....	100%	100%		100%
Level 4 .....				
Average C <sub>RR</sub> (kg/ton) <sup>b</sup> .....	5.1	4.7	5.1	4.7
<b>Tire Pressure Systems:</b>				
ATIS .....	100%	100%	100%	100%
TPMS.				
Average Pressure System Reduction (%) <sup>a</sup> .....	1.2%	1.2%	1.2%	1.2%
<b>Weight Reduction:</b>				
Weight (lb) <sup>b</sup> .				

**Notes:**

A blank cell indicates a zero value.

<sup>a</sup> Combines projected adoption rates with performance levels shown in Table IV–9.

<sup>b</sup> This set of adoption rates did not apply weight reduction to meet these standards for these trailers.

The adoption rates shown in these tables are one set of many possible combinations that box trailer manufacturers could apply to achieve the same average stringency. If a manufacturer chose these adoption rates, a variety of technology options exist within the aerodynamic bins, and several models of LRR tires exist for the levels shown. Alternatively, technologies from other aero bins and tire levels could be used to comply. It should be noted that since the standards for box vans are all performance-based, box van manufacturers are not limited to specific aerodynamic and tire technologies in their compliance choices. Certain types of weight reduction, for example, may be used as part of a compliance pathway. See RIA Chapter 2.10.2.4.1 for other example compliance pathways that include weight reduction.

Similar to our analyses of the baseline cases, the agencies derived a single set of performance parameters for each subcategory by weighting the performance levels included in Table

IV–9 by the corresponding adoption rates. These performance parameters represent a compliant vehicle for each trailer subcategory and are presented as average values in the Table IV–14 through Table IV–16.

(ii) Tire Technologies for Non-Aero Box Vans and Non-Box Trailers

Neither non-aero vans (*i.e.*, those with two or more work-related special components), nor non-box trailers are shown in the tables above. This is because we are adopting design-based (*i.e.*, technology-based) standards for these trailers, not performance-based standards. Manufacturers of these trailers do not need to use aerodynamic technologies, but they need to install the lower rolling resistance tires and tire pressure systems established by this program (see Section IV.C.(2)). Compared to manufacturers that needed aerodynamic technologies to comply, the approach for non-aero box trailers and non-box trailers results in a significantly lower compliance burden for manufacturers by reducing the

amount of tracking and eliminating the need to calculate a compliance value (see Section IV.E.). The agencies are adopting these design standards, which can be assumed to be 100 percent adoption, in two stages. In MY 2018, the non-box trailer standards require manufacturers to use tires meeting a rolling resistance of Level 2 or better and to install tire pressure systems. In MY 2021, non-box trailers standards require tire pressure systems and LRR tires at Level 3 or better. Non-aero box vans, which we believe are largely at a baseline rolling resistance Level 2 today, require tire pressure monitoring systems with Level 3 tires in MY 2018 and Level 4 tires in MY 2021 and later.

We received comment that manufacturers were concerned about the cost and availability of ATIS for the trailer industry. Still, based on comments about TPMS and further evaluations by the agencies, we are including TPMS as an additional option for tire pressure systems in the trailer program, as discussed in Section IV.D.(1)(c) above. Non-aero vans and

non-box trailers are compliant if they have appropriate lower rolling resistance tires and either TPMS or ATIS.

(e) Derivation of the Trailer Standards

The agencies applied the average performance parameters from Table IV–14 and Table IV–15 as input values to the GEM vehicle simulation to derive the HD Phase 2 fuel consumption and CO<sub>2</sub> emissions standards for each long and short full-aero box van subcategory. These full-aero van standards are shown

in Table IV–17. Similarly, the average performance parameters from Table IV–16 were used to calculate the partial-aero van standards shown in Table IV–18. The design standards for non-box trailer and non-aero box van are summarized in Table IV–19.

Over the four stages of the trailer program, the full-aero box vans longer than 50 feet are projected to reduce their CO<sub>2</sub> emissions and fuel consumption by two percent, five percent, seven percent and nine percent compared to their average baseline cases in Table IV–13.

Full-aero box vans 50-feet and shorter will achieve reductions of one percent, two percent, four percent and six percent compared to their average baseline cases. The partial-aero long and short box van standards will reduce CO<sub>2</sub> and fuel consumption by six percent and four percent, respectively, by MY 2021. The tire technologies used on non-box and non-aero box trailers are projected to provide reductions of two percent in the first stage and three percent in MY 2021 and later.

TABLE IV–17—STANDARDS FOR FULL-AERO BOX VANS

Model year	Subcategory	Dry van		Refrigerated van	
		Long	Short	Long	Short
2018–2020	EPA Standard (CO <sub>2</sub> Grams per Ton-Mile)	81.3	125.4	83.0	129.1
	Voluntary NHTSA Standard (Gallons per 1,000 Ton-Mile)	7.98625	12.31827	8.15324	12.68173
2021–2023	EPA Standard (CO <sub>2</sub> Grams per Ton-Mile)	78.9	123.7	80.6	127.5
	NHTSA Standard (Gallons per 1,000 Ton-Mile)	7.75049	12.15128	7.91749	12.52456
2024–2026	EPA Standard (CO <sub>2</sub> Grams per Ton-Mile)	77.2	120.9	78.9	124.7
	NHTSA Standard (Gallons per 1,000 Ton-Mile)	7.58350	11.87623	7.75049	12.24951
2027+	EPA Standard (CO <sub>2</sub> Grams per Ton-Mile)	75.7	119.4	77.4	123.2
	NHTSA Standard (Gallons per 1,000 Ton-Mile)	7.43615	11.7288	7.60314	12.10216

TABLE IV–18—STANDARDS FOR PARTIAL-AERO BOX VANS

Model year	Subcategory	Dry van		Refrigerated van	
		Long	Short	Long	Short
2018–2020	EPA Standard (CO <sub>2</sub> Grams per Ton-Mile)	81.3	125.4	83.0	129.1
	Voluntary NHTSA Standard (Gallons per 1,000 Ton-Mile)	7.98625	12.31827	8.15324	12.68173
2021+	EPA Standard (CO <sub>2</sub> Grams per Ton-Mile)	80.6	123.7	82.3	127.5
	NHTSA Standard (Gallons per 1,000 Ton-Mile)	7.91749	12.15128	8.08448	12.52456

TABLE IV–19—DESIGN-BASED TIRE STANDARDS FOR NON-BOX TRAILERS AND NON-AERO BOX VANS

Model year	Tire technology	Non-box trailers	Non-aero box vans
2018–2020	Tire Rolling Resistance Level (kg/ton)	≤6.0	≤5.1
	Tire Pressure System	TPMS or ATIS	TPMS or ATIS
2021+	Tire Rolling Resistance Level (kg/ton)	≤5.1	≤4.7
	Tire Pressure System	TPMS or ATIS	TPMS or ATIS

(f) Technology Costs for the Trailer Standards

The agencies evaluated the incremental technology costs for 53-foot dry and refrigerated vans and 28-foot dry vans. (As explained above, we believe these length trailers are representative of the majority of trailers in the long and short box van subcategories, respectively.) We identified costs for each technology package and projected the costs for each year of the program. A summary of the technology costs is included in Table

IV–20 through Table IV–23 for MYs 2018 through 2027, with additional details available in the RIA Chapter 2.12. Costs shown in the following tables are for the specific model year indicated and are incremental to the average baseline costs, which includes some level of adoption of these technologies as shown in Table IV–13. Therefore, the technology costs in the following tables reflect the average cost expected for each of the indicated trailer classes across the fleet. Note that these costs do not represent actual costs for the individual components because they

are relative to the costs of the MY 2018 baselines which are expected due to market-driven adoption of the technologies. For more on the estimated technology costs exclusive of adoption rates, refer to Chapter 2.12 of the RIA. These costs include indirect costs via markups and reflect lower costs over time due to learning impacts. For a description of the markups and learning impacts considered in this analysis and how technology costs for other years are thereby affected, refer to Chapter 7 of the RIA.

TABLE IV-20—TRAILER TECHNOLOGY INCREMENTAL COSTS IN THE 2018 MODEL YEAR  
[2013\$]

	Long vans, full aero	Long vans, partial aero	Short vans, full aero	Short vans, partial aero	Long vans, no aero	Short vans, no aero	Non-box
Aerodynamics .....	\$367	\$742	\$0	\$0	\$0	\$0	\$0
Tires .....	2	40	1	20	40	20	28
Tire inflation system .....	347	659	338	494	421	210	421
Total .....	716	1,441	339	514	461	231	448

TABLE IV-21—TRAILER TECHNOLOGY INCREMENTAL COSTS IN THE 2021 MODEL YEAR  
[2013\$]

	Long vans, full aero	Long vans, partial aero	Short vans, full aero	Short vans, partial aero	Long vans, no aero	Short vans, no aero	Non-box
Aerodynamics .....	\$743	\$679	\$450	\$475	\$0	\$0	\$0
Tires .....	17	49	9	25	49	25	23
Tire inflation system .....	321	609	313	457	389	195	389
Total .....	1,081	1,337	772	957	438	219	412

TABLE IV-22—TRAILER TECHNOLOGY INCREMENTAL COSTS IN THE 2024 MODEL YEAR  
[2013\$]

	Long vans, full aero	Long vans, partial aero	Short vans, full aero	Short vans, partial aero	Long vans, no aero	Short vans, no aero	Non-box
Aerodynamics .....	\$899	\$645	\$879	\$451	\$0	\$0	\$0
Tires .....	11	48	6	24	48	24	27
Tire inflation system .....	294	558	286	418	357	178	357
Total .....	1,204	1,251	1,171	894	405	202	383

TABLE IV-23—TRAILER TECHNOLOGY INCREMENTAL COSTS IN THE 2027 MODEL YEAR  
[2013\$]

	Long vans, full aero	Long vans, partial aero	Short vans, full aero	Short vans, partial aero	Long vans, no aero	Short vans, no aero	Non-box
Aerodynamics .....	\$1,069	\$623	\$921	\$436	\$0	\$0	\$0
Tires .....	22	44	11	22	44	22	16
Tire inflation system .....	279	529	272	397	338	169	338
Total .....	1,370	1,196	1,204	855	382	191	354

### (3) Consistency of the Trailer Standards With the Agencies' Statutory Obligations

The agencies have determined that the standards presented in the Section IV.C.(2), are the maximum feasible and appropriate under the agencies' respective authorities, considering lead time, cost, and other factors. The agencies' decisions on the stringency and timing of the trailer standards focused on available technology and the consequent emission reductions and fuel efficiency improvements associated with use of the technology, while taking into account the circumstances of the trailer manufacturing sector. Trailer manufacturers are subject to first-time emission control and fuel consumption regulation under the trailer standards.

These manufacturers are in many cases small businesses, with limited resources to master the mechanics of regulatory compliance. Thus, the agencies are providing ample and reasonable time for trailer manufacturers to become familiar with the requirements and the new compliance regime.

The stringency of the standard is predicated on more widespread deployment of tire technologies that are already in commercial use and existing aerodynamic devices combinations that we believe will be further optimized in the near-term. The availability, feasibility, and level of effectiveness of these technologies are well-documented. In developing the standards, we also took into account not just the capabilities of the technologies,

but also how the use of these technologies is likely to expand under the trailer program, considering factors like degree of market penetration over time and the effect of different operational patterns for different trailer types (Section IV.D.(2) above). For example, some commenters point out that trailers operating at lower speeds will achieve smaller CO<sub>2</sub> and fuel consumption reductions than they will at highway speeds. The agencies acknowledge this fact, and account for a fraction of trailer operation at slower speeds. All long box vans are evaluated with 5 percent of their miles at low speed operation and all short vans are evaluated with 17 percent low speed miles. While we cannot predict individual trailer use, we believe these

values are a reasonable estimate of an industry average.<sup>363</sup> Our analysis in RIA Chapter 2.10.2.1.1 shows that skirts will provide short trailers with at least 1 percent improvement and long trailers with at least 4 percent improvement at 55 mph. We expect most trailers spend at least some of their miles at 55 mph or faster in use and will gain similar benefits during those speeds. We also show that even trailers operating under fully transient conditions (combining slower and faster operation) will experience a small improvement from use of trailer skirts.

The agencies do not believe that there is any issue of technological feasibility of the levels of the standards and the time line for implementing them in the final trailer program. The agencies considered cost and the sufficiency of lead-time, including lead-time not only to deploy technological improvements, but, as just noted, also for this industry sector to assimilate for the first time the compliance mechanisms of the trailer program.

The highest cost shown in Table IV–23 is associated with the standard for long dry vans. We project that the average cost per trailer to meet the MY 2027 standards for these trailers will be about \$1,400, which is less than 10 percent of the cost of a new dry van trailer (estimated to be about \$20,000). Other trailer types have lower projected technology costs, and many have higher purchase prices. As a result, we project that the per-trailer costs for all trailers covered in this regulation will be less than 10 percent of the cost of a new trailer.

The agencies regard these costs as reasonable. We project that most customers will rapidly recover the initial cost of these technologies due to the associated fuel savings, usually in two years. As discussed in Section IX.M and RIA Chapter 7.2.4, this payback is for tractors and trailers together, and includes both long and short-haul. This payback period is generally considered reasonable in the trailer industry for investments that reduce fuel consumption.<sup>364</sup> Although longer paybacks will occur for some trailers, we do not project that any trailers will achieve lifetime fuel savings less than

the cost of the technologies. In addition, the agencies estimate the cost per metric ton of CO<sub>2</sub>eq reduction without considering fuel savings to be \$36 for tractor-trailers in 2030 which compares favorably with the levels of cost effectiveness the agencies found to be reasonable for light duty trucks.<sup>365</sup>

The agencies believe these technologies can be adopted at the projected rates within the lead time provided in the trailer program, as discussed above in Section IV.C.(4) above.

#### (4) Alternative Standards and Feasibility That the Agencies Considered

As discussed in Section X of the NPRM, the agencies evaluated five regulatory alternatives representing different levels of stringency for the Phase 2 program. See 80 FR 40273. A wide range of stakeholders commented on the proposed (Alternative 3) standards and the other alternatives that we discussed, and our final standards reflect our consideration of all of those comments.

Comments on our proposed standards (Alternative 3) and the alternatives we presented generally fell into three categories: (1) Commenters supporting Alternative 1; *i.e.*, generally advocating no mandatory standards and a continuation of today's voluntary SmartWay regime and; (2) Commenters preferring the proposed Alternative 3 standards and timeline to the standards of Alternative 4; and (3) Commenters supporting the more stringent standards and timeline of Alternative 4, Alternative 5, or of other more stringent potential programs.

Commenters including the TTMA, Utility, and Stoughton stated their belief that no mandatory standards are necessary; however, they did not provide information to show that market forces at work today will achieve the clear potential for the industry to reduce CO<sub>2</sub> and fuel consumption in the near- and longer-term future. The agencies have concluded that a program involving no or minimal mandatory requirements would not be appropriate or meet our statutory requirements.

As discussed previously, the agencies believe that our final trailer standards are appropriate under the Clean Air Act and are the maximum feasible standards under the EISA. In developing the proposal and the final rule, we considered standards that would be more stringent or would become effective in an earlier model year than

the proposed Alternative 3 standards and timeline. Several commenters stated that a still more stringent program should be finalized, including information about current and potential future trailer aerodynamic technologies. Commenters including CARB, NACAA, NRDC, ICCT, UCS, and STEMCO supported the standards we presented for Alternative 4 in the proposal (essentially the pull ahead of the MY 2027 standards) in the proposal. In addition, some of the commenters made the additional suggestion that the agencies should anticipate that manufacturers will incorporate a modest degree of Bin VIII technologies—*i.e.*, two bins higher than any performance demonstrated in our aerodynamic testing—in the later stages of the program. EDF supported a program of even greater stringency, supporting Alternative 5 standards (advanced aerodynamic technologies on all box vans, aerodynamic technologies on some non-box trailers, and tire technologies on all non-box trailers) on the Alternative 4 timeline. The Center for Biological Diversity (CBD) did not specifically comment on the alternatives presented in the proposal, but supported a program that would result in significantly more stringent standards (based, for example, on integrated tractor and trailer technologies, such as in the SuperTruck demonstration program). Great Dane, Wabash, ATA, and the International Foodservice Distributors Association expressed concerns that a program of the stringency and timeline of Alternative 4 would have negative consequences, including requiring trailer manufacturers to adopt less-tested technology.

Where commenters provided relevant data and information, the agencies made adjustments to the final program accordingly. For example, as noted in Section IV.C.(1) and Section IV.D.(2) previously, information from the industry was helpful in the decision to limit the non-box trailer program to tanks, flatbeds, and container chassis. Also, partially in response to information we received in comments, we slightly reduced the proposed stringency for partial-aero vans to better reflect their aerodynamic limitations. Also, while not a direct change to the stringency of the standards, the program limits averaging to the final stage of the program to allow van manufacturers more time to become familiar with the compliance processes and the industry to gain confidence in the technologies. Overall, the final standards are slightly more stringent than proposed, based on

<sup>363</sup> Memorandum to Docket EPA–HQ–OAR–2014–0827, “Comparison of GEM Drive Cycle Weightings and Fleet Data Provided by Utility Trailer Manufacturing Co. in Public Comments”, July 2016.

<sup>364</sup> Roeth, Mike, et al. “Barriers to Increased Adoption of Fuel Efficiency Technologies in Freight Trucking,” July 2013. International Council for Clean Transportation. Available here: [http://www.theicct.org/sites/default/files/publications/ICCT-NACFE-CSS\\_Barriers\\_Report\\_Final\\_20130722.pdf](http://www.theicct.org/sites/default/files/publications/ICCT-NACFE-CSS_Barriers_Report_Final_20130722.pdf).

<sup>365</sup> See RIA Chapter 7.2.5 and Memo to Docket “Tractor-Trailer Cost per Ton Values,” July 2016. EPA–HQ–OAR–2014–0827.

an expectation of earlier adoption of more efficient lower rolling resistance tires for all subcategories, and a strengthened the full-aero van program that includes greater adoption of advanced aerodynamics in the final stage.

Based on this analysis and as informed by the comments, we believe that the final standards in the program, slightly revised from the proposed Alternative 3 standards, are appropriate and represent the maximum feasible standards. In contrast, we believe that the accelerated timeline of Alternative 4 may cause technologies to prematurely enter the market, leading to unnecessary costs and compliance burdens that would not be appropriate for this newly regulated industry. Standards similar to or more stringent than those we evaluated for Alternative 5 would require CO<sub>2</sub> and fuel consumption reductions that may well not be technologically achievable, even with fundamental changes to the industry. Nor did the commenters present any information as to how advanced aerodynamic technologies (Bins VII and VIII) could be developed and reliably brought to market at reasonable cost within the lead time of the Phase 2 program. On the basis of what we know today, the agencies are unable to show a pathway for the industry to achieve such additional improvements, at least without the potential for major disruptions to the industry due to requiring, for example, fundamental changes to trailer design and construction, or impractical levels of tractor-trailer integration.

#### E. Trailer Standards: Compliance and Flexibilities

As with other EPA motor vehicle programs, trailer manufacturers must annually obtain a certificate of conformity from EPA before introducing into commerce new trailers subject to the new trailer CO<sub>2</sub> and fuel consumption standards. See CAA section 206(a). The EPA certification provisions align with provisions that apply to the NHTSA trailer program such that this single certification program meets the requirements of both agencies.

The certification process for trailer manufacturers is very similar in its basic structure to the process for the other Phase 2 vehicle programs, although it has been simplified for trailers. This structure involves pre-certification activities, the certification application and its approval, and end-of-year reporting.

In this section, the agencies first describe the general certification

process and how we developed compliance equations based on the GEM vehicle simulation tool, followed by a discussion of the specified test procedures for measuring the performance of tires and aerodynamic technologies and how manufacturers will apply test results toward compliance and certification. The section closes with discussions of several other certification and compliance provisions as well as provisions to provide manufacturers with compliance flexibility.

#### (1) General Certification Process

Under the process for certification, manufacturers of all covered trailers are required to apply to EPA for certification.<sup>366</sup> In addition, manufacturers of box vans subject to the performance-based standards are required to provide aerodynamic performance test data (see 40 CFR 1037.205) in their applications. EPA expects to provide additional guidance to the regulated industry as the program begins to be implemented, including an overview of the regulations, how to prepare for compliance, and instructions for registering with the EPA. Once a trailer manufacturer is registered with EPA, EPA's Compliance Division in the Office of Transportation and Air Quality will assign a staff certification representative to the company to help them through the compliance process. After this point, manufacturers can arrange to meet with the agencies to discuss compliance plans and obtain any preliminary approvals (e.g., appropriate test methods) before applying for certification.

Trailer manufacturers submit their applications through the EPA "Verify" electronic database, and EPA issues certificates based on the information provided. At the end of the model year, trailer manufacturers submit an end-of-year report to the agencies to complete their annual obligations.

#### (a) Definition of Model Year

As mentioned previously, consistent with Clean Air Act specifications, EPA's vehicle certification is an annual process. EPA CO<sub>2</sub> emissions standards start to apply for trailers built on or after January 1, 2018, with later standards being introduced by model year. Under the Clean Air Act, the term "model year" refers to a manufacturer's annual production period. Manufacturers may

use the calendar year as the model year, or may choose a different period of production that includes January 1 of that year. Thus, manufacturers have the option to choose any year-long period of production that begins on or before January 1 of the named model year, but no sooner than January 2 of the previous calendar year. For example, at certification, a manufacturer could specify the 2021 model year production period to be July 1, 2020 through June 30, 2021.

#### (b) Preliminary Considerations for Compliance

Before submitting an application for a certificate, a manufacturer chooses the technologies they plan to offer their customers, and identifies any trailers in their production line that qualify for exclusion from the program.<sup>367</sup> Non-box trailers, which are subject to design standards, the manufacturer will need to select which tires and tire pressure systems to include and confirm that their tires meet the LRR performance standards. For box vans subject to performance standards, manufacturers also obtain performance information for these technologies at this time, either from supplier data or their own testing. Manufacturers that choose to perform aerodynamic or tire testing themselves may also need to obtain approval of test methods and perform preliminary testing. Trailer manufacturers relying on data from a third-party aerodynamic device manufacturer would need to verify that these data are approved.

During this time, the manufacturers also decide the strategy they intend to use for compliance by identifying "families" for the trailers they produce. A family is a grouping of similar products that are all subject to the same standard and covered by a single certificate. All products in each trailer subcategory are generally certified as the same family. That is, long box dry vans, short box dry vans, long refrigerated vans, short refrigerated vans, non-box trailers, partial-aero vans (long and short box, dry and refrigerated vans), and non-aero box vans, are each certified as separate trailer families. Manufacturers may combine dissimilar trailers into a single vehicle family to reduce the compliance burden as described in 40 CFR 1037.230(d)(3) and 49 CFR 535.5(e). In general, manufacturers can combine trailers that have less stringent standards with more stringent standards as long as the combined set of trailers

<sup>366</sup> As with the other Phase 2 vehicle programs, manufacturers submit their applications to EPA, which then shares them with NHTSA. Obtaining an approved certificate of conformity from EPA is the first step in complying with the NHTSA program.

<sup>367</sup> Trailers that meet the qualifications for exclusion do not require a certificate of conformity and manufacturers do not have to submit an application to EPA for these trailers.

meet the more stringent standards. Refrigerated and dry vans of the same length can be combined to meet the dry van standards. Short vans can combine with long vans, meeting the corresponding long van standard. Additionally, non-box trailers can be combined with the non-aero box vans if the manufacturer would like to meet the more stringent non-aero box van design standards with higher-performing tires.

When no averaging is available (*i.e.*, MY 2018 through MY 2026 for full-aero box vans, and all years for remaining trailers), all products within a family need to meet or exceed the standards for that trailer subcategory (except for any trailers included in the manufacturer's allowance for non-complying vehicles (See Section IV.E.(5)(a) below)). This is not to say that, for example, every long box dry van model needs to have identical technologies like skirts, tires, and tire inflation systems, but that every model in that family need to meet the standard for that family.

In MY 2027 and later, full-aero box van manufacturers will still generally have one family per subcategory. However, if a full-aero box van manufacturer subject to performance standards wishes to utilize the averaging provisions, it would need to divide the trailer models in each of the van subcategories/families into subfamilies.<sup>368</sup> Each subfamily can be a grouping of box vans that have similar performance levels, even if they use different technologies. We refer to the performance levels for each subfamily as "Family Emission Limits" (FELs). A long box dry van manufacturer could choose, for example, to create two subfamilies in its long box dry van family. Trailers in one of these subfamilies could be allowed to under-comply with the standard (*e.g.*, not apply a tire pressure system) as long as the performance of the other subfamily over-complies with the standard (*e.g.*, installs additional aerodynamic technologies), such that the average of all of the subfamilies' FELs met or exceeded the standard for that family on a production-weighted basis. Section IV.E.(5)(b) below further discusses how the averaging program would function for any such trailer subfamilies.

<sup>368</sup> The program essentially requires that manufacturers equip 100 percent of their non-box and special purpose box trailers with tire pressure systems and tires meeting the specified rolling resistance levels. Partial-aero box vans meet a reduced performance standard. As a result, averaging provisions do not apply to these trailer subcategories.

#### (c) Submitting a Certification Application and Request for a Certificate to EPA

Once the preliminary steps are completed, the manufacturer can prepare and submit applications to EPA for certificate of conformity for each of its trailer families. The contents of the application are specified in 40 CFR 1037.205, though not all items listed in the regulation are applicable to each trailer manufacturer.

For the early years of the program (*i.e.*, MY 2018 through MY 2020), the application must specify whether the trailer manufacturer is opting into the NHTSA voluntary program to ensure the information is transferred between the agencies. Throughout the program, the application must include a description of the emission and fuel consumption reduction technologies that a manufacturer intends to offer. These technologies could include aerodynamic features, LRR tire models, tire pressure systems, or components that qualify for weight reduction. Basic information about labeling, warranty, and recommended maintenance should also be included in the application (see Section IV.E.(4) for more information on these additional compliance provisions).

The manufacturer also provides a summary of the plans to comply with the standard. This information includes a description of the trailer family and subfamilies (if applicable) covered by the certificate, the technologies that are used for compliance, and projected sales of its products. For trailers subject to performance-based standards (and not those subject to the design-based standards), in the earlier stages of the program when averaging is not available (or for manufacturers of full-aero vans that do not participate in averaging after MY 2026), additional provisions apply. These manufacturers will include information on the configuration with the worst performance level in terms of CO<sub>2</sub> and fuel consumption offered in the trailer family. Any of these manufacturers that choose to average within their full-aero van families after MY 2026 will include performance information for the projected highest production trailer configuration, as well as the lowest and the highest performing configurations within those families. For all covered trailers, once the certification application is accepted, a certificate is issued and manufacturers can begin selling their trailers.

#### (d) End-of-Year Obligations

After the end of each year, all manufacturers, including those with design-based standards, need to submit

a report to the agencies presenting production-related data for that year (see 40 CFR 1037.250 and 49 CFR 535.8). In addition, the year's final compliance data (as calculated using the compliance equation) for box van manufacturers subject to performance-based standards will include both CO<sub>2</sub> emissions and fuel consumption information and actual production volumes in order to demonstrate that the trailers met the standards for that year.

In MY 2027 and later, full-aero box van manufacturers that opt to participate in the averaging program will submit a second report that describes their subfamily FELs and a final calculation of their production-weighted average CO<sub>2</sub> and fuel consumption. See 40 CFR 1037.730, 40 CFR 1037.745, and 49 CFR 535.7. All certifying manufacturers need to maintain records of all the data and information that is required to be supplied to EPA and NHTSA for eight years.

#### (2) Evaluating Trailer Performance for Compliance

The agencies believe that this final compliance program for trailer manufacturers is straightforward, technically robust, transparent, and minimizes administrative burdens on the industry. As described earlier in this section and in Chapter 4 of the RIA, GEM is a customized vehicle simulation model that EPA developed for the Phase 1 program to relate measured aerodynamic and tire performance values, as well as other parameters, to CO<sub>2</sub> and fuel consumption without performing full-vehicle testing. As with the Phase 1 and Phase 2 tractor and vocational vehicle programs, the trailer program uses GEM in evaluating emissions and fuel consumption in developing the trailer standards. However, unlike the tractor and vocational vehicle programs, trailer manufacturers will not use GEM directly to demonstrate compliance with the trailer standards. Instead, we have developed an equation based on GEM that calculates CO<sub>2</sub> and fuel consumption from performance inputs without running the model.

#### (a) Development of the GEM-Based Trailer Compliance Equation

For compliance with the performance-based standards in the trailer program (*i.e.* the standards for full- and partial-aero long and short box vans), the trailer characteristics that a manufacturer supplies to the equation are aerodynamic improvements (*i.e.*, the change in the aerodynamic drag area,



delta C<sub>d</sub>A, from the appropriate bin in m<sup>2</sup>), tire rolling resistance (*i.e.*, coefficient of rolling resistance, C<sub>RR</sub>, in kg/metric ton), the presence of a tire pressure system, and any weight reduction applied in pounds. The use of the equation quantifies the overall performance of the trailer in terms of CO<sub>2</sub> emissions on a grams per ton-mile basis, which can be converted to fuel consumption on a gallons per 1000 ton-mile basis.

Chapter 2.10.5 of the RIA provides a full a description of the development and evaluation of the equation for trailer compliance where the standards are

performance-based. Equation IV–1 is a single linear regression curve that can be used for all box vans in these rules to calculate CO<sub>2</sub> emissions, e<sub>CO2</sub>. Unique constant values, C<sub>1</sub> through C<sub>4</sub>, are applied for each of the van types as shown in Table IV–24. Constant C<sub>5</sub> is equal to 0.988 for any trailer that installs an ATIS (accounting for the 1.2 percent reduction given for use of ATI), 0.990 for any trailer that installs a TPMS, or 1.0 for trailers without tire pressure systems. We found that this equation accurately reproduces the results of GEM for each of the box van subcategories, and the program requires

these trailer manufacturers use Equation IV–1 to calculate CO<sub>2</sub> for compliance. Manufacturers insert their tire rolling resistance level (TRRL), wind-averaged change in drag area (ΔC<sub>d</sub>A), weight reduction value (WR) (if applicable), and the appropriate C<sub>5</sub> value if a tire pressure system is installed into the equation and submit the result to EPA. The program provides for manufacturers to use a conversion of 10.180 grams of CO<sub>2</sub> per gallon of diesel to calculate the corresponding fuel consumption values for compliance with NHTSA’s regulations. See 40 CFR 1037.515 and 49 CFR 535.6.

$$e_{CO2} = [C_1 + C_2 \cdot (TRRL) + C_3 \cdot (\Delta C_d A) + C_4 \cdot (WR)] \cdot C_5 \quad (IV-1)$$

TABLE IV–24—CONSTANTS FOR GEM-BASED TRAILER COMPLIANCE EQUATION

Trailer subcategory	C <sub>1</sub>	C <sub>2</sub>	C <sub>3</sub>	C <sub>4</sub>	C <sub>5</sub> (tire pressure)		
					None	TPMS	ATIS
Long Dry Van .....	76.1	1.67	–5.82	–0.00103	1.000	0.990	0.988
Long Refrigerated Van .....	77.4	1.75	–5.78	–0.00103			
Short Dry Van .....	117.8	1.78	–9.48	–0.00258			
Short Refrigerated Van .....	121.1	1.88	–9.36	–0.00264			

These long and short van constants are based on GEM-simulated tractors pulling 53-foot and solo 28-foot trailers, respectively. As a result, aerodynamic testing to obtain a trailer’s performance parameters for Equation IV–1 must be performed using consistent trailer sizes (*i.e.*, aerodynamic performance for all lengths of short vans would be tested as a solo 28-foot van, and performance for all lengths of long vans would be tested as a 53-foot van). More information about aerodynamic testing is provided in Section IV.E.(3)(b) below.

The constants for long vans apply for all dry or refrigerated vans longer than 50-feet and the constants for short vans apply for all dry or refrigerated vans 50-feet and shorter. The vans with work-performing devices that may be designated as partial-aero vans would use the same equation constants as their full-aero counterparts for compliance. The partial-aero designation simply allows a van to input different values (*i.e.*, lower delta C<sub>d</sub>A) and meet a different standard. Note that compliance with the design-based standards (non-box trailers and non-aero vans) does not require use of the GEM-based equation. Manufacturers supply the TRRL values for their trailer tires and attest that they installed one of the tire pressure systems (TPMS or ATIS) to EPA for compliance.

(b) Use of the Compliance Equation for Box Van Compliance

Box van manufacturers subject to the performance-based standards meet the standards using the GEM-based compliance equation to combine the effects of technologies and quantify the overall performance of the vehicle to demonstrate compliance. Trailer manufacturers obtain delta C<sub>d</sub>A and tire rolling resistance values from testing (either from their own testing or from testing performed by another entity as described in Section IV.E.(3)(b)) and attest that they installed a qualifying tire pressure system and/or adopted weight reduction strategies. Manufacturers adopting aerodynamic improvements will compare their measured delta C<sub>d</sub>A value to the values shown in Table 2 of 40 CFR 1037.515 (and Table IV–5 previously) and use the appropriate aerodynamic bin value as the aerodynamic input into the equation. The TRRL can be directly applied from measurements. Weight reduction is obtained by summing applicable values in our list of light weight components (Table 3 of 40 CFR 1037.515) or from measurements using the off-cycle provisions. Manufacturers indicate use of TPMS or ATIS with a specified percent reduction in CO<sub>2</sub> and fuel consumption.

Qualifying components for weight reduction can be found in 40 CFR

1037.515(d). Manufacturers that substitute one or more of these components on their box vans sum the weight reductions assigned to each component and enter that total into the equation. As noted in Section IV.D.(1)(d), the equation accounts for weight reduction by assigning one-third of that reduced weight to increase the payload and the remaining weight reduction to reduce the overall weight of the assumed vehicle.

Manufacturers of box vans subject to the performance standards apply the compliance equation separately to each configuration to ensure that all of the trailer configurations they offer need to meet the standard for the given model year. The certification application submitted to EPA includes equation results from the worst performing trailer configuration for each subcategory and the manufacturer attests that no regulated trailer will be sold in a lower performing configuration. If the manufacturer offers a new technology package during the model year, the performance can be evaluated using the equation. If the performance of the new package is lower than the value submitted in the application, the manufacturer would submit a “running change” to EPA to reflect the change. Box van manufacturers will submit a single end-of-year report that will include their production volumes and

confirmation that all of their trailers applied the technology packages outlined in their application.

Any full-aero box van manufacturers that wish to take advantage of the agencies' averaging provision in MY 2027 and later will make greater use of the compliance equation. Before submitting a certificate application, these manufacturers would decide which technologies to make available for their customers and use the equation to determine the range of performance of the packages they planned to offer. The manufacturers would supply these results from the equation in their certificate application and those manufacturers that wish to perform averaging would continue to calculate emissions (and fuel consumption) with the equation throughout the model year and keep records of the results for each trailer package produced. As described in Section IV.E.(1)(d) above, at the end of the year, these manufacturers would submit two reports. One report would include their production volumes for each configuration. The second report would summarize the families and subfamilies, and CO<sub>2</sub> emissions and fuel consumption results from the equation for all of the trailer configurations they build in that model year, including a production-weighted average to show compliance.

For non-box trailers and non-aero box vans, compliance is design-based, not performance-based, and the compliance equation is not needed. As described earlier, the standards for these trailers require the use of tires with rolling resistance levels at or below a threshold, and tire pressure systems (either TPMS or ATIS). Instead of aerodynamic testing data in their certification applications, manufacturers of these trailers submit their tire rolling resistance levels and a description of their tire pressure system(s) to EPA.

### (3) Trailer Certification Test Protocols

The Clean Air Act specifies that compliance with emission standards for motor vehicles be demonstrated by the manufacturer using emission test data (see CAA section 206(a) and (b)). As discussed earlier, for the design-based standards (non-box trailers and non-aero vans), the trailer program considers the use of specified LRR tires and tire pressure systems an appropriate surrogate for emission testing, and there are no testing requirements associated with these standards beyond the testing required to show the tires qualify as LRR tires. We expect that tire testing will be performed by the tire manufacturers.

All full- and partial-aero vans covered by the program are subject to performance standards, and compliance is based on measured emission performance. For these trailers, the program uses the GEM-based compliance equation discussed in Section IV.E.(2)(a) above as the official "test procedure" for quantifying CO<sub>2</sub> and fuel consumption performance for trailer compliance and certification (as opposed to use of GEM, which serves this function in the tractor and vocational vehicle programs). Manufacturers input performance information from the applicable trailer technologies into the equation in order to calculate their impact on overall trailer performance. Manufacturers needing aerodynamic and tire rolling resistance performance data obtain it either through their own testing or through a device or tire manufacturer that performed the testing. The program specifies pre-determined values for tire pressure systems and many weight reduction components for manufacturers to apply.

The following subsections describe the approved performance tests for tire rolling resistance and aerodynamic drag in this trailer program. See 40 CFR part 1037, subpart F, for a full description of the performance tests, in particular section 40 CFR 1037.515.

#### (a) Trailer Tire Performance Testing

Under Phase 1, tractor and vocational chassis manufacturers are required to input the tire rolling resistance level (TRRL) into GEM, and the agencies adopted the provisions in ISO 28580:2009(E)<sup>369</sup> to determine the rolling resistance of tires. The tire rolling resistance level (TRRL) is a declared value that is based on a measured value. As described in 40 CFR 1037.520(c), this measured value, expressed as C<sub>RR</sub>, is required to be the result of measurements of three different tires of a given design, giving a total of at least three data points. Manufacturers specify a C<sub>RR</sub> value for GEM that is less than or equal to the average of these three results. Tire rolling resistance may be determined by either the vehicle or tire manufacturer. In the latter case, the tire manufacturer provides a signed statement confirming that it conducted testing in accordance with this part.

The Phase 1 tire testing provisions for rolling resistance apply to all of the regulated trailers in the Phase 2 program. In the Phase 2 program, full- and partial-aero box van manufacturers,

subject to the trailer performance-based standards, apply their declared TRRL in the compliance equation. Non-box trailer and non-aero box vans, subject to the design-based standards, simply report the TRRL as part of their certification application. Based on the current practice for Phase 1, we expect the trailer manufacturers to obtain these data from tire manufacturers, but trailer manufacturers have the option to perform tire testing themselves.

The agencies requested comment on adopting a program for tire manufacturers similar to the provision described in Section IV.E.(3)(b)(v) for aerodynamic device manufacturers, through which tire manufacturers would seek preliminary approval of the performance of their trailer tires. 80 FR 40278. CARB supported this option and further requested that EPA create a public database of the tire rolling resistance data submitted to the agency in such preliminary approvals. RMA's comments opposed making tire data available to the public without first developing a rating system for medium and heavy truck tires. The agencies have chosen not to pursue provisions for pre-approved trailer tire rolling resistance data or a public database of this information in this rulemaking, recognizing the overall unresolved issues relating to standard HD truck and trailer testing within the tire industry (as discussed in the Tractor section of this Preamble, Section III.E(1)(e)). Instead, trailer tire manufacturers provide tire rolling resistance values directly to the trailer manufacturers and that information is shared with EPA and NHTSA for certification.

#### (b) Trailer Aerodynamic Performance Testing

As discussed earlier, manufacturers of trailers subject to performance standards (*i.e.*, most box vans), need to provide EPA with aerodynamic performance data at the time of certification. The purpose of our trailer aerodynamic test procedures is to establish an estimate of the aerodynamic drag experienced by a tractor-trailer vehicle in real-world operation. We based these procedures on the current tractor aerodynamic procedures, including coastdown, wind tunnel, and computational fluid dynamics (CFD) modeling. More specifically, the tests are conducted according to the same test procedures for tractors and trailers, but different provisions apply for the test articles and the data analysis. In the tractor program, the resulting C<sub>dA</sub> value represents the absolute aerodynamic drag of a tested tractor assumed to be pulling a specified standard trailer. In the trailer program,

<sup>369</sup> See [http://www.iso.org/iso/iso\\_catalogue/catalogue\\_tc/catalogue\\_detail.htm?csnumber=44770](http://www.iso.org/iso/iso_catalogue/catalogue_tc/catalogue_detail.htm?csnumber=44770).

the tests measure the difference in  $C_{dA}$  value between the tested trailer as pulled by a standard tractor and a reference trailer pulled by the same standard tractor. In other words, the trailer test procedure is intended to measure the aerodynamic improvements rather than the absolute aerodynamic performance. The agencies chose to base the standards on measurements of aerodynamic improvements in part to reflect the market reality that many trailer manufacturers rely on manufacturers of bolt-on aerodynamic devices for the improvements rather than redesigning their trailer or developing their own components.

To minimize the testing burden, the program specifies that all aerodynamic devices for long box vans (*i.e.*, those greater than 50-feet in length) be evaluated based on 53-foot box vans, and that devices for all trailers 50-feet and shorter be evaluated based on 28-foot box vans. In other words, a manufacturer can use test data from a single trailer to certify all trailers in the same subcategory. As noted previously in Section IV.D.(1) and demonstrated in Chapter 2.10.2.1.2.6 of the RIA, the performance of aerodynamic devices on these two trailer lengths is expected to provide a conservative estimate of the performance on the longer trailers within the same length category. We believe that this compliance approach effectively represents the performance of such devices on the majority of box vans, yet limits the number of such vans that a manufacturer needs to track and evaluate.

The program provides for manufacturers to have flexibility in the devices (or packages of devices) they install on box vans with lengths that differ from 53-feet or 28-feet. In such situations, a manufacturer could use devices that they believe would be more appropriate for the length of the trailer they are producing, consistent with good engineering judgement. For example, they could test skirts on a 28-foot trailer and use longer skirts on 40-foot trailers that they make. No additional testing would be required in order to validate the appropriateness of using the alternate devices on these trailers.

The agencies have structured the final regulations to make wind tunnel testing the primary method for measuring trailer aerodynamic performance. While coastdown testing measures performance of full-scale vehicles, which is generally the agencies' preference for performance testing, wind tunnel testing achieves similar results in terms of delta  $C_{dA}$ , with the added benefit of measuring wind-

averaged values in the same test. In addition, wind tunnel testing is inexpensive relative to other aero test methods and does not require as much time to complete. Thus, it has generally been the preferred method for the trailer industry. Nevertheless, the program provides for manufacturers to use coastdown or CFD methods as described below and fully in 40 CFR 1037.526(b) and 1037.150(x).

The agencies considered making coastdown testing the primary test method for trailers, as it is for the tractor program. However, the delta  $C_{dA}$  approach for the trailer aerodynamic program would require multiple tests to evaluate most configurations. Coastdown testing is a full-scale test method that requires the vehicle, which includes the trailer and an appropriately aerodynamic tractor, be driven on a road or track that meets specified conditions. An important challenge with coastdown testing is that wind and weather restrictions can limit the days in which testing can be performed. Additionally, coastdown testing has higher natural variability due to environmental variability in an uncontrolled system. We have placed an additional restriction on the allowable difference in yaw angles for delta  $C_{dA}$  measurements to reduce this variability (see 40 CFR 1037.526(a)(2)). However, the combination of our test constraints (*e.g.*, restrictions on the wind, temperature, and road conditions), can make it challenging to measure a drag difference from two valid coastdown tests. These factors would make accurate coastdown testing for the trailer program even more time-consuming and expensive relative to the tractor program. Accordingly, we decided that wind tunnel testing is more appropriate for this newly regulated industry.

Coastdown testing has two significant advantages over wind tunnel testing. First, as a full-scale method, it can be directly applied to actual products. Second, full-scale methods may be the only way to reliably test small-scale devices that cannot be appropriately scaled or recreated in wind tunnel or CFD. Although these advantages justify allowing coastdown testing as an alternate method, they do not justify the additional costs that would occur if it were specified as the primary test method for trailers.

In making this determination, the agencies were cognizant of the limited financial ability of trailer manufacturers (and device manufacturers) to absorb testing costs. Unlike the tractor industry, most of the manufacturers in the trailer industry are small- to medium-sized companies. Even the

largest trailer manufacturers are much smaller than the companies that manufacture tractors. Had we established coastdown as the primary method, trailer manufacturers would have needed to not only perform extensive coastdown testing to show equivalency with their preferred methods, but would have also needed to maintain the ability to perform coastdowns on a regular basis like tractor manufacturers are required to under Phase 1 and Phase 2, including owning or maintaining access to an appropriate test tractor or tractors. While this is a manageable burden for the large tractor manufacturers, it would have been a substantial burden for trailer manufacturers, especially the smaller ones. TTMA commented that any of the larger manufacturers in its membership that may do testing would prefer wind tunnel or CFD testing to "contain costs." In conjunction with the NODA, EPA laid out principles related to aerodynamic testing that we intended to follow when applying our compliance oversight to trailers.<sup>370</sup> In particular, we indicated that we intended to rely more on our own confirmatory testing, recognizing that both trailer manufacturers and device manufacturers have less financial ability to perform Selective Enforcement Audit (SEA) testing than do tractor manufacturers (see Section IV.E.(4)(f) for more information on SEAs). Under the final regulations, the agencies can perform wind tunnel testing, but would also retain the right to perform coastdown testing, provided we adjusted any coastdown results to account for yaw differences. If we conducted confirmatory testing using coastdowns, we would also need to perform enough runs to minimize variability between the test conditions. Should we measure worse aerodynamic performance (after fully adjusting for methodological differences and accounting for test-to-test variability), we would require the manufacturer to use our test results as the official test results. It is important to emphasize that, because confirmatory testing generally occurs before we have issued a certificate of conformity and before the manufacturer has begun production, there are no penalties or other compliance actions that would result from EPA confirmatory testing. Thus, we do not expect manufacturers using wind tunnels to have any need to

<sup>370</sup> "Additional Discussion of Selective Enforcement Audit and Confirmatory Testing for Aerodynamic Parameters for Combination Tractors and for Trailers," February 19, 2015. Docket EPA-HQ-OAR-2014-0827-1625.

separately verify their results using coastdown procedures.

Details of the test procedures can be found in 40 CFR 1037.526 and a discussion of EPA's aerodynamic testing program as it relates to the trailer program is provided in the RIA Chapter 3.2. The following subsections outline the testing requirements for the long term trailer program, as well as simpler testing provisions that apply in the nearer term.

(i) A to B Testing for Trailer Aerodynamic Performance

The agencies expect a majority of the aerodynamic improvements for trailers will be accomplished by adding bolt-on technologies. As just explained above, a key difference between the tractor program and the trailer program is that while the tractor test procedures provide a direct measurement of an absolute  $C_dA$  value for each tractor model, aerodynamic improvements for trailers are evaluated by measuring a change in  $C_dA$  ( $\Delta C_dA$ ) relative to a baseline without aerodynamic improvements. Specifically, trailer tests are performed as "A to B" tests, comparing the aerodynamic performance of a tractor-trailer without a trailer aerodynamic device (or package of devices) to one with the device (or package) installed. As noted below, this approach can be applied if changes are made to the aerodynamic design of a trailer as well. See RIA Chapter 2.10.2.1.2 for more justification for this A to B approach.

In essence, an A to B test is a pair of tests: one test of a baseline tractor-trailer in a "no-control" configuration with zero trailer aerodynamic improvements (A), and one test that includes the aerodynamic improvements to be tested (B). However, because an A test relates to a B test only with respect to the test method and the basic tractor-trailer vehicle, one A test could be used for many different B test configurations. This type of testing results in a  $\Delta C_dA$  value instead of an absolute  $C_dA$  value. For the trailer program, the vehicle configuration in the A test includes a standard tractor that meets specified characteristics (40 CFR 1037.501(h)), and a baseline trailer with no aerodynamic improvements. The entity conducting the testing (*e.g.*, the trailer manufacturer, a contractor, or an aerodynamic device manufacturer, as discussed below) performs the test for this configuration according to the procedures in 40 CFR 1037.526 and repeats the test for the B configuration, which includes the trailer aerodynamic package/device(s) being tested. The  $\Delta C_dA$  value for that trailer with that

aerodynamic improvement is the difference between the  $C_dA$  values obtained in the A and B tests.

The agencies note that it was relatively straightforward in Phase 1 to establish a standard trailer with enough specificity to ensure consistent testing of tractors, since there are relatively small differences in aerodynamic performance of base-model dry box vans. However, as discussed in Chapter 2.10 of the RIA, small differences in tractor design can have a significant impact on overall tractor-trailer aerodynamic performance. An advantage of an A to B test approach for trailers is that many of the effects due to differences in tractor design are minimized, which allows different models of tractors to be used as standard tractors in testing without compromising the evaluation of the trailer aerodynamic technology. Thus, the relative approach does not require the agencies to precisely specify a standard tractor, nor does it require trailer manufacturers to purchase, modify or retain a specific tractor model in order to evaluate their trailers.

In the event that a trailer manufacturer makes major changes to the aerodynamic design of its trailer in lieu of installing add-on devices, it could use the same baseline trailer for the A configuration as could be used for bolt-on features. In both cases, the baseline trailer would be a manufacturer's standard box van. Thus, the manufacturer of a redesigned trailer would get full credit for any aerodynamic improvements it made.

As discussed in Chapter 2.10 of the RIA, measured drag coefficients and drag areas can vary slightly depending on the test method used. In general, absolute wind-averaged  $C_dA$  values measured using wind tunnels and CFD tend to be higher than values measured using the near-zero yaw coastdown method. The Phase 1 and Phase 2 tractor program use coastdown testing as the reference test method, and the agencies require tractor manufacturers to perform at least one test using that method to establish a correction factor to apply to each of the alternative test methods. The proposed trailer regulations referred to coastdown as our reference method, although we noted that the size of the bins and the use of  $\Delta C_dA$  (as opposed to absolute values) minimized the significance of variability between test methods. 80 FR 40280. CARB recommended that we require a reference method in our aerodynamic testing, but provided no data to support their recommendation.

As noted already, the agencies have established the wind tunnel method as

the primary method. Like the tractor program, the allowance to use alternate aerodynamic test procedures provides for adjustments to make the measurements equivalent to the primary method. This is done to ensure that the manufacturer is neither advantaged nor disadvantaged by using the alternate method, relative to results they would have obtained using the primary method. However, because determining equivalency between methods can be burdensome, the agencies are adopting in 40 CFR 1037.150(x) an interim allowance to use certain specific approximations based on data currently available to us. Manufacturers would not be required to justify using these approximations or to seek prior approval for them. Nevertheless, in the unlikely event that we determine that these approximations overstate actual aerodynamic performance for a particular trailer or device, we would not allow the manufacturer to use the approximated values for certification and they would be required to use other more reasonable adjustments.

Our test results shown in Chapter 2.10 of the RIA, show that wind tunnel and CFD produce wind-averaged  $\Delta C_dA$  values within the same bin for the devices tested. Thus, this interim provision allows CFD results to be used without adjustment. Coastdown  $\Delta C_dA$  results, which are not wind-averaged, may be in the same bin, but we note that the tails showed more yaw dependence and coastdown tests under-predicted the performance of tails relative to wind-averaged methods. We anticipate some additional current and future devices may be sensitive to yaw angle, and our interim provision accounts for this. Manufacturers that choose to use coastdown testing can use their results without adjustment, or, if they suspect their device is affected by yaw angle, they can use other testing or analytical methods to demonstrate a means of adjusting their near-zero yaw results to a wind-averaged equivalent 4.5-degree value. The bin values in Section IV.E.(3)(b)(iv), which were updated based on additional aerodynamic test data collected between the NPRM and final rules, are based on our wind tunnel testing results, though our results suggest that most CFD and coastdown results will fit into the same bins. See RIA Chapter 2.10.2.1.3.

(ii) Standard Tractor for Aerodynamic Testing in the Trailer Program

The agencies are adopting a set of characteristics that qualify a tractor to be used in trailer aerodynamic compliance testing. EPA's trailer testing program investigated the impact of

tractor aerodynamics on the performance of trailer aerodynamic technologies, as mentioned in Chapter 2.10.2.1.2.2 of the RIA. We found the A to B test strategy reduces the degree of precision with which the standard tractor needs to be specified. Instead of identifying a specific make and model of a tractor to be used over the entire duration of the program, the agencies identified an appropriate aerodynamic performance threshold that maintains a relatively consistent level of performance between trailers. Tractors used in trailer aerodynamic tests must meet Phase 2 aerodynamic Bin III or better tractor requirements. We believe the majority of tractors in the U.S. trucking fleet will be Bin III or better in the timeframe of this rulemaking, and trailer manufacturers have the option to choose higher-performing tractors in later years as tractor technology improves. See Section III.D.2.c.i. The standard tractor for long-box vans is a Class 8 high-roof sleeper cab. The standard tractor for short box vans is a Class 7 or 8 high roof day cab with a single drive axle (*i.e.*, 4x2 axle configuration). Trailer or device manufacturers are free to choose any standard tractor that meets these criteria in their aerodynamic performance testing. See 40 CFR 1037.501.

The compliance equation used to determine compliance with the trailer standards is based on GEM, so our discussion of the feasibility of our standards (Section IV.D.(2)) includes a description of the tractor-trailer vehicle used in GEM. The agencies proposed to require use of a 6x4 Class 8 sleeper cab for long box van aerodynamic testing, and a 6x4 Class 8 day cab for short box van testing. 80 FR 40279. We believe Class 8 tractors are more widely available, which will make it easier for the trailer industry to obtain a qualified tractor if they choose to perform trailer testing. In order to align with the test procedures, we also proposed to consistently model a Class 8 tractor across all trailer subcategories in GEM. CARB supported the use of Class 8 tractors in their comments. However, EPA encountered difficulty in meeting the test procedure-specified tractor-trailer gap width when using a dual drive axle day cab in one of our short box van wind tunnel tests due to the location of the landing gear relative to the kingpin. As a result, we are changing the standard tractor specifications for aerodynamic testing to require the use of a 4x2 tractor for short trailers. While we expect most manufacturers will use tractor-trailer models in wind tunnel or CFD testing,

we recognize that there are fewer 4x2 tractors available for full-scale testing, and we are adopting provisions that testers can use either a Class 8 or Class 7 day cab tractor to address availability concerns. We believe the external aerodynamic characteristics of Class 7 and Class 8 day cabs are very similar and the engine performance differences between the two tractor classes would not impact the aerodynamic performance in terms of delta  $C_dA$ . Note that a Class 7 4x2 day cab tractor is used for all short van default tractor-trailer vehicles within GEM and represented in the GEM-based equation (see Table IV–8).

Daimler requested that we choose a *single* tractor for all trailer testing to ensure consistency over time. As stated above, the agencies agree that the tractor does have the potential to influence the aerodynamic performance of trailers. As discussed above, however, we believe that influence is reduced with use of a delta  $C_dA$ . Additionally, we believe it would be a significant burden on the trailer industry to require manufacturers and suppliers to acquire a specific tractor make and model over the timeframe of the rules. Thus, the final trailer program does not require the use of a specific tractor make for the Phase 2 trailer program.

#### (iii) Accounting for Wind Impacts When Measuring Aerodynamic Performance

The agencies proposed to determine the delta  $C_dA$  for trailer aerodynamic performance using the zero-yaw (or head-on wind) values from any of the approved test procedures. However, based on comments received, we are revising the final program to be based on wind-averaged results, similar to the tractor program. The agencies recognize the value of wind-averaging to better reflect the performance expected in real-world operation, but at the time of proposal, we believed the use of a zero-yaw delta  $C_dA$  would reduce the number of tests compared to generating a wind-averaged value from a sweep of yaw angles. Additionally, it is relatively straightforward to generate wind-averaged  $C_dA$  values from wind tunnel and CFD, but there is a significant increase in test burden to obtain wind-averaged results from coastdown tests. Our intent was to ensure parity between test procedures, such that manufacturers would have the several options to test aerodynamic performance.

The agencies received comment on this issue, in the context of the proposed tractor standards, suggesting that the  $C_dA$  measured at a yaw angle of 4.5 degrees is very similar to the wind-averaged  $C_dA$  calculated at 7 degrees/65

MPH. The agencies evaluated our own test data using an average of +4.5 degrees and –4.5 degrees to minimize the effect of potential facility asymmetry, and found that the results were within two percent of the corresponding wind-averaged values (See Section III.E.2.a and Chapter 3.2 of the RIA). Adoption of this surrogate angle approach reduces the cost of generating a wind-averaged value from wind tunnel and CFD procedures.<sup>371</sup> Consequently, the tractor program uses an average  $C_dA$  measured at +4.5 and –4.5 degree yaw angles as a surrogate wind-averaged value (see RIA Chapter 3.2 for more information). However, it does not address the increased burden for conducting coastdown tests.

The agencies received comment from TTMA that “repetitive” coastdown testing would rarely be used by its trailer manufacturer members. Instead, manufacturers that do choose to perform their own testing will likely rely on CFD and wind tunnel tests. Because we are establishing the wind tunnel method as the primary method, and because we expect it to also be the most commonly used method, we no longer have test burden concerns about requiring wind-averaging. Therefore, the agencies believe we can adopt aerodynamic test procedures for trailers that require wind-averaged delta  $C_dA$  values, as represented by an average of results from +4.5 and –4.5 degree yaw angles, for compliance. We believe that coastdown testing will be chosen by a small number of manufacturers and the burden of performing this optional test on the overall industry will be relatively small. EPA may rely on coastdown testing in its own confirmatory testing, and the agency will accept the additional burden of correcting to a wind-averaged value.

#### (iv) Bins for Aerodynamic Performance

As mentioned in Section IV.D., the trailer program uses aerodynamic bins to account for testing variability and to provide consistency in the performance values used for compliance. We developed these bins in terms of delta  $C_dA$  ranges, and we designed them to be broad enough to cover the range of uncertainty seen in our aerodynamic testing program in terms of test-to-test variability as well as variability due to

<sup>371</sup> CFD test contracts are often priced for individual yaw angles. Wind tunnel test contracts are often priced for an entire yaw sweep. Limiting our measurement requirement to one or two yaw angles is expected to reduce the cost of generating a wind-averaged value from CFD, but will only reduce the cost from wind tunnel tests if the manufacturer chooses to do individual yaw angles in lieu of the customary sweep.

differences in test method, tractor models, trailer models and device models. The bins are somewhat different than in the proposal, as discussed in Section IV.D.(1)(a)(ii) above RIA Chapter 2.10.2.1.3.

TABLE IV–25—AERODYNAMIC BINS USED TO DETERMINE INPUTS FOR TRAILER CERTIFICATION

Delta C <sub>d</sub> A measured in testing	Bin	Delta C <sub>d</sub> A input for compliance
<0.1 .....	Bin I .....	0.0
0.10–0.39 .....	Bin II .....	0.1
0.40–0.69 .....	Bin III .....	0.4
0.70–0.99 .....	Bin IV .....	0.7
1.00–1.39 .....	Bin V .....	1.0
1.40–1.79 .....	Bin VI .....	1.4
≥1.8 .....	Bin VII .....	1.8

A manufacturer that wishes to perform testing first identifies a standard tractor according to 40 CFR 1037.501(h) and a representative baseline trailer with no aerodynamic features (or models of these vehicles), then performs the A to B tests with and without aerodynamic improvements to obtain a delta C<sub>d</sub>A value. The manufacturer uses Table IV–25 to determine the appropriate bin based on their measured delta C<sub>d</sub>A. Each bin has a corresponding delta C<sub>d</sub>A threshold value that is the value manufacturers insert into the compliance equation.

(v) Aerodynamic Device Testing Compliance Path

The agencies recognize that much of the trailer manufacturing industry may have little experience with aerodynamic performance testing. For this reason, the program includes a compliance option that we believe minimizes the testing burden for trailer manufacturers, and at the same time meets the requirements of the Clean Air Act and of EISA by providing reasonable assurance that the anticipated CO<sub>2</sub> and fuel consumption benefits of the program will be realized in real-world operation. This approach provides an opportunity for trailer manufacturers to choose technologies with pre-approved test data for installation on their new trailers without performing their own aerodynamic testing. We note that this testing option is consistent with recommendations of the Small Business Advocacy Review (SBAR) Panel, which is summarized in Section XIV.D and Chapter 12 of the RIA.

The trailer program provides for trailer aerodynamic device manufacturers to seek preliminary approval of the performance of their devices (or combinations of devices)

based on the same performance tests described previously. Trailer manufacturers could then choose to use these devices and apply the approved performance levels in the certification application for their trailer families. A device manufacturer would need to perform the required A to B testing using a tractor-trailer that meets the requirements specified in 40 CFR 1037.211 and 1037.526 and submit the performance results, in terms of delta C<sub>d</sub>A, directly to EPA.<sup>372</sup> EPA would require much of the same information from the device manufacturers as it would normally require during certification, including the technology name, a description of its proper installation procedure, and its corresponding delta C<sub>d</sub>A derived from the approved test procedures. See 40 CFR 1037.211.

Once a device manufacturer has obtained this preliminary approval, it could supply the same information to any trailer manufacturers that wish to install its devices. When the trailer manufacturer certifies, the agencies would merely verify that the values in the trailer manufacturer’s certification application are those already approved for the device manufacturer. To ease the transition for MYs 2018 through 2020, we proposed and are adopting a flexibility to allow pre-approval of certain data accepted by the EPA SmartWay aerodynamic verification program. Section IV.E.(5)(c) below describes how a device manufacturer can use certain test data generated for SmartWay verification as a part of its pre-approval in the early years of the program.

The program also allows trailer manufacturers to use multiple devices with individually pre-approved test data on a single trailer configuration, provided each device does not impair the effectiveness of the other(s), consistent with good engineering judgment.<sup>373</sup> 40 CFR 1037.211 outlines a process for combining the effects of multiple devices to determine an appropriate delta C<sub>d</sub>A value for compliance. More specifically, manufacturers would fully count the technology with largest delta C<sub>d</sub>A value,

<sup>372</sup> Note that in the event a device manufacturer submits false or inaccurate data to EPA, it could incur liability for causing a regulated entity to commit a prohibited act. See 40 CFR 1068.101(c). This same potential liability exists with respect to information provided by a device manufacturer directly to a trailer manufacturer.

<sup>373</sup> A trailer manufacturer needs to use good engineering judgement (as defined in 40 CFR 1068.5) in combining devices for compliance in order to avoid combinations that are not intended to work together (e.g., both a side skirt and an under-body device).

discount the second by 10 percent, and discount each of the remaining additional technologies by 20 percent. This discounting acknowledges the complex interactions that can occur among individual aerodynamic devices and provides a conservative value for the impact of the combined devices (see the analysis of device combinations in RIA Chapter 2.10). For example, a manufacturer applying three separately tested devices with delta C<sub>d</sub>A values of 0.40, 0.30, and 0.10 would calculate the combined delta C<sub>d</sub>A as:

$$\text{Delta } C_{dA} = 0.40 + 0.90 * 0.30 + 0.80 * 0.10 = 0.75 \text{ m}^2$$

The agencies believe that discounting the delta C<sub>d</sub>A values of individually-tested devices used as a combination provides a modest incentive for trailer or device manufacturers to test and get EPA pre-approval of the combination as an aerodynamic system for compliance. To avoid this discounting, device manufacturers can test a trailer incorporating a combination of devices and receive EPA pre-approval for data from that combination. Trailer manufacturers could then use the test results from that specific combination for certification.

Note that the aerodynamic bins of Table IV–25 do not apply to aerodynamic data that device manufacturers submit to EPA for pre-approval. The pre-approved data will have greater precision than the bin-averaged values shown in Table IV–25. Therefore, trailer manufacturers calculating a delta C<sub>d</sub>A value based on combinations of pre-approved data use the exact numbers submitted by the device manufacturers to calculate the discounted delta C<sub>d</sub>A, and thus select an appropriate bin value for compliance based on that result. The process to obtain approval is outlined in 40 CFR 1037.211.

The agencies note that many of the largest van manufacturers are already performing aerodynamic test procedures to some extent, and the agencies expect other van manufacturers will increasingly be capable of and interested in performing these tests as the program progresses. The device testing approach is intended to allow trailer manufacturers to focus on and become familiar with the certification process in the early years of the program and, if they wish, begin to perform testing in the later years, when it may be more appropriate for their individual companies. This approach does not preclude trailer manufacturers from performing their own testing at any time, even if the technologies they wish to install are already pre-approved. For

example, a manufacturer that believed a specific trailer actually performed in a more synergistic manner with a given device than the device's pre-approved delta  $C_dA$  value suggested could perform its own testing and submit the results to EPA for certification.

STEMCO, an aerodynamic device manufacturer, commented in support of the proposed pre-approval option, but also supported the agencies publishing information about the testing performed by device manufacturers for their devices to be pre-approved. The agencies are not committing to publish the pre-approved aerodynamic data at this time. We do note that once data are submitted to EPA and the device is introduced into commerce, the data are available to the public at their request and the information gathered may be published by outside stakeholders.

#### (4) Additional Certification and Compliance Provisions

##### (a) Trailer Useful Life

Section 202(a)(1) of the CAA specifies that EPA is to propose emission standards that are applicable for the "useful life" of the vehicle. NHTSA is adopting EPA's proposed useful life requirements for trailers, to ensure that manufacturers consider in their design process the need for fuel efficiency standards to apply for the same duration as the EPA standards. Based on our own research and discussions with trailer manufacturers, EPA and NHTSA are adopting a regulatory useful life value for trailers of 10 years, as proposed. This useful life value represents the average duration of the initial use of trailers, before they are moved into less rigorous duty (e.g., limited use or storage). We note that the useful life value is 10 years or a mileage threshold for other heavy-duty vehicles. However, unlike for the other vehicles, the program does not include a parallel mileage value for trailers. This would require odometers on trailers, and we do not believe that mandating odometers would be appropriate for this purpose.

With this useful life provision, trailer manufacturers are responsible for designing and building their trailers so that they will be able to meet the CO<sub>2</sub> emissions and fuel consumption standards for 10 years after the trailer is produced, provided that they are properly maintained. For technologies at issue here, we believe that this requirement is essentially the same as customers' existing durability expectations. The useful life requirements do not include liability for damage to or removal of devices by users. Instead, trailer manufacturers

must ensure at the time of sale that devices are properly installed and able to maintain functionality throughout the useful life. We believe that manufacturers will be able to demonstrate at certification that their trailers, including all bolt-on technologies used as emissions controls, will comply with the CO<sub>2</sub> and fuel consumption standards for the useful life of the trailers without separate durability testing. The aerodynamic technologies that we expect manufacturers to use to comply with the trailer standards, including side skirts and boat tails, are designed to continue to provide their full potential benefit indefinitely as long as no serious damage occurs.

Regarding a useful life value for trailer tires, we recognize that the original lower rolling resistance tires will wear over time and will be replaced several times during the useful life of a trailer, either with new or retreaded tires. As with the Phase 1 tractor program, to help ensure that trailer owners have sufficient knowledge of which replacement tires to purchase in order to retain the as-certified emission and fuel consumption performance of their trailer for its useful life, the trailer program requires that trailer manufacturers supply adequate information in the owners manual to allow the trailer owner to purchase replacement tires meeting or exceeding the rolling resistance performance of the original equipment tires. (Note that the "owners manual" need not be a physical document, but could be made available on line). We believe that the favorable fuel consumption benefit of continued use of LRR tires generally results in proper replacements throughout the 10-year useful life. Finally, the program requires that tire pressure systems remain effective for at least the 10-year useful life, although some servicing may be necessary by the customer. See also the related discussions below in Section IV.E.(4)(c) (Emission-Related Warranty) and Section IV.E.(4)(d) (Maintenance).

##### (b) Emission Control Labels

Historically, EPA-certified vehicles are required to have a permanent emission control label affixed to the vehicle. The label facilitates identification of the vehicle as a certified vehicle. For the trailer program, EPA requires that the labels include the same basic information as we require for tractor labels in Phase 1. For trailers, this information includes the manufacturer, a trailer identifier such as the Vehicle Identification Number, the trailer family and

regulatory subcategory, the date of manufacture, and compliance statements. Although the Phase 2 label for tractors does not include emission control system identifiers (as previously required for tractors in the Phase 1 program in 40 CFR 1037.135(c)(6)), the trailer program requires that these identifiers be included in the trailer labels. See 40 CFR 1037.135 for a list of general requirements for emissions labels, which includes a reference to Appendix III for appropriate abbreviations for trailer technologies.

##### (c) Emission-Related Warranty

Section 207 (a) of the CAA requires manufacturers to warrant their products to be free from defects that could otherwise cause non-compliance with emission standards. For purposes of the trailer program, EPA requires trailer manufacturers to warrant all components that form the basis of the certification to the CO<sub>2</sub> emission standards. The emission-related warranty covers all aerodynamic devices, lower rolling resistance tires, tire pressure systems, and other components that may be included in the certification application. Note that the emission-related warranty is completely separate from any other warranties a manufacturer might offer.

The trailer manufacturer needs to warrant that these emission-related components and systems are designed to remain functional for the warranty period. We note that this emission-related warranty, and the trailer manufacturer's financial responsibility for repairs, does not apply to components that are damaged in collisions or through abuse; nor does it cover components that experience wear with normal use. This warranty is meant to apply to defects in the product or improper installation by the manufacturer. Based on the historical practice of requiring emissions warranties to apply for half of the useful life, we are adopting a warranty period for trailers of five years for everything except tires. For trailer tires, we apply a warranty period of one year.

Utility and Great Dane noted in their comments that the warranty of current ATIS that they are aware of is limited to three years. However, we view this as a business decision by the ATIS manufacturers, rather than as a reflection of the actual durability of the systems. With proper maintenance, we are aware of no reason that these systems would be unable to meet the durability requirements of the trailer program or to be designed to last the full useful life of the trailer if properly maintained. See the Maintenance



discussion at IV.E.(4)(d) below. We believe a five year emission-related warranty is justified, but we note that trailer manufacturers can specify that their warranty depends on the proper maintenance of components. Manufacturers can offer a more generous warranty if they choose; however, the emission-related warranty may not be shorter than any other warranty they offer without charge for the trailer. NHTSA is not adopting any warranty requirements relating to its trailer fuel consumption program.

At the time of certification, manufacturers need to supply a copy of the warranty statement that they supply to the end customer. This document outlines what is covered under the GHG emissions related warranty as well as the duration of coverage. Customers also need to have clear access to the terms of the warranty, the repair network, and the process for obtaining warranty service.

#### (d) Maintenance

In general, EPA requires that vehicle manufacturers specify schedules for any maintenance needed to keep their product in compliance with emission standards throughout the useful life of the vehicle (CAA section 207(a)). For trailers, such maintenance could include adjustments to fairings or service to tire pressure systems. EPA believes that any such maintenance is likely to be performed by operators to maintain the fuel savings of the components. If manufacturers believe that the durability of their trailer's performance is contingent on proper maintenance of these systems, they must include a corresponding maintenance schedule in their certification applications.

Since lower rolling resistance tires are key emission control components under this program, and they will likely require replacement at multiple points within the life of a vehicle, it is important to clarify how tires fit into the emission-related maintenance requirements. Although the agencies encourage the exclusive use of LRR tires throughout the life of trailers vehicles, we do not hold trailer manufacturers responsible for the actions of end users. We do not see this as problematic because, as noted above, we believe that trailer end users have a genuine financial motivation for ensuring their vehicles are as fuel efficient as possible, which includes purchasing LRR replacement tires and that they will continue to use them once they are accustomed to their use. Therefore, as mentioned in Section IV.E.(4) above, to help ensure that trailer owners have

sufficient knowledge of which replacement tires to purchase in order to retain the as-certified emission and fuel consumption performance of their trailer, the program requires that trailer manufacturers supply adequate information in the owners manual to allow the trailer owner to purchase tires meeting or exceeding the rolling resistance performance of the original equipment tires. (As discussed above, note that the "owners manual" need not be a physical document, but could be made available on line). Manufacturers submit these instructions to EPA as part of the application for certification.

#### (e) Post-Useful Life Modifications

The Clean Air Act generally prohibits any person from removing or rendering inoperative any emission control device installed for compliance, such as those needed to comply with the requirements of 40 CFR part 1037. However, in 40 CFR 1037.655 EPA clarifies that certain vehicle modifications are allowed after a vehicle reaches the end of its regulatory useful life. This section applies to trailers, since it applies to all vehicles subject to 40 CFR part 1037.

The provisions of 40 CFR 1037.655 clarify that owners may modify a vehicle for the purpose of reducing emissions, provided they have a reasonable technical basis for knowing that such modification will not increase emissions of any other pollutant, but emphasizes that EPA presumes such modifications to be more appropriate for second owners. In the case of trailers, an owner would need to have information that would lead an engineer or other person familiar with trailer design and function to reasonably believe that the modifications will not increase emissions of any regulated pollutant. In the absence of such information, modifications during or after the trailer's useful life would constitute tampering with an emission control system. Thus, this provision does not provide a blanket allowance for modifications after the useful life.

This section does not specifically apply with respect to modifications that occur within the useful life period, other than to note that many such modifications to the vehicle during the useful life are presumed to violate CAA section 203(a)(3)(A). EPA notes, however, that this is merely a presumption, and would not prohibit modifications during the useful life where the owner clearly has a reasonable technical basis for knowing the modifications will not cause the vehicle to exceed any applicable standard.

#### (f) Confirmatory Testing and Selective Enforcement Audits (SEA) for GEM Inputs

In Phase 2, vehicle performance for box vans (except non-aero box vans) is measured using a GEM-based equation, which accepts input parameters related to aerodynamics, tire rolling resistance, and trailer weight. Trailer manufacturers are responsible for obtaining performance measures for these parameters through valid testing according to the specified test procedures. The Clean Air Act authorizes EPA to perform its own testing to confirm the manufacturer's data. This testing, which is called confirmatory testing, is conducted prior to issuing a certificate. The Act also authorizes EPA to require manufacturers to conduct Selective Enforcement Audits (SEA), which would involve testing performed on production vehicles before they enter into commerce.

The agencies are finalizing a list of lightweight trailer components that can be installed by trailer manufacturers and used in certification. Additionally, we are assigning a set percent reduction value to qualifying tire pressure systems (*i.e.*, ATIS and TPMS) that manufacturers can apply if they install these systems. Thus, because these are agency-default values rather than the manufacturers' measured or declared values, we will not hold trailer manufacturers responsible for the accuracy of these values. Additionally, we expect most trailer manufacturers will obtain LRR tire information directly from the tire manufacturers and many trailer manufacturers will install aerodynamic devices with data that was pre-approved by EPA. Information provided by a third party (such as a tire or device manufacturer) to a regulated entity for compliance is treated as though it was submitted directly to EPA. EPA has the authority to verify such data and hold the third party responsible for any falsified data, since submission of such data could incur liability for causing a regulated entity to commit a prohibited act. See 40 CFR 1068.101(c).

Of all of the performance measures for trailers, we believe aerodynamic testing has the greatest potential for variability and these results are likely to receive the most scrutiny. In the NPRM, we proposed to generally apply the same SEA and confirmatory testing structures to tractors and trailer with respect to aerodynamics. However, we also proposed to retain the authority to require *component* manufacturers to perform SEAs where certification relies



on their test data. See, *e.g.* section 1037.301(d)(4) of the proposed regulations.

We are revising the SEA and confirmatory testing structures for trailers based on further consideration and comments received from the trailer manufacturing industry (TTMA). In general, the final regulations reflect the following principles:

- Due to the smaller number of possible trailer configurations (compared to tractor configurations), it would be more possible for EPA to rely on confirmatory testing for trailer aerodynamics.
- Since test-to-test variability for individual coastdown runs can be high, confirmatory test determinations should be based on average values from multiple runs.
- Trailer manufacturers and trailer component manufacturers have less financial ability to perform SEAs than do tractor manufacturers. Nevertheless, EPA should retain the authority to require trailer and trailer component manufacturers to perform SEAs, especially where EPA has reason to believe the trailers are non-compliant.
- Given the limited ability to eliminate uncertainty, compliance determinations should consider the statistical confidence that a true value lies outside a bin.

EPA will generally try to duplicate a manufacturer's test setup in any confirmatory testing (which would include the standard tractor) unless we have reason to believe an inappropriate setup was used. While our test results presented in Chapter 2.10 of the RIA show that the trailer program's delta C<sub>dA</sub> approach reduces the tractor's impact on trailer results, to the extent practical, EPA will use the same standard tractors that manufacturers used in their testing.

We believe that, although the final compliance structure for trailers is simpler than for tractors, it will still provide a strong incentive for manufacturers to act in good faith. In particular, the regulations emphasize the final value of EPA's auditing records and inspecting production components, rather than requiring manufacturers to perform expensive testing. Thus, EPA expects to require manufacturers to perform SEA testing only when we have reasonable evidence leading us to believe a manufacturer have not provided accurate test data. See Section III.E.(2)(a)(ix) for a discussion of how EPA would conduct an aerodynamic SEA.

#### (g) Importation of New Trailers

Manufacturers have raised concerns about enforcement of emission standards for new trailers that are imported into the United States. This poses unique challenges at the point of entry, because new trailers may be carrying cargo and are therefore nearly indistinguishable from trailers that have already been imported or otherwise placed into service. We are not adopting any new or different compliance provisions in this rulemaking to address this; however, we intend to work cooperatively with Customs and Border Protection and other agencies to ensure that first-time state registration of new trailers includes verification that the trailer manufacturers have certified them to meet U.S. emission and fuel consumption standards. We expect this to be similar to the current system for ensuring that new, imported trailers meet NHTSA safety standards.

A related concern applies for foreign-based trailers traveling in the United States for importing or exporting cargo. Such trailers are not subject to emission and fuel consumption standards unless they are considered imported into the United States. U.S. cabotage law prohibits foreign truck drivers from carrying product from one point to another within the United States. Effective enforcement of this cabotage law will help prevent manufacturers of noncompliant foreign-produced trailers from gaining a competitive advantage over manufacturers of compliant domestic trailers.

#### (5) Flexibilities

The trailer program that the agencies are adopting incorporates a number of provisions that have the effect of providing flexibility and easing the compliance burden on trailer manufacturers while maintaining the expected CO<sub>2</sub> and fuel consumption benefits of the program. Among these is the basic approach we used in setting the trailer standards, including the staged phase-in of the standards, which gradually increase the CO<sub>2</sub> and fuel consumption reductions that manufacturers need to achieve over time as they also increase their experience with the program. As described in Section IV.E.(3)(b)(v), another of these is the process for device manufacturers to submit test data directly to EPA for review by the agencies in advance of formal certification, allowing a trailer manufacturer to reduce the amount of testing needed to demonstrate compliance or avoid it altogether.

In addition to these provisions inherent to the trailer program, this

section describes additional options the agencies are adopting that we believe will be valuable to many trailer manufacturers.

#### (a) Limited Allowance of Non-Complying Trailers

As described in Section IV.B. above the agencies are not finalizing the proposed provisions that would have allowed manufacturers to comply with the trailer standards using averaging before MY 2027. As a result, in the absence of mitigating provisions, manufacturers would need to comply with the applicable standards for all of their trailers. The agencies received comment, primarily from trailer manufacturers, that, without the flexibility of averaging, trailer manufacturers should be allowed to "carve-out" a set percentage of their sales that would not be required to meet the standards. Stoughton Trailers suggested a 20 percent carve-out.

The agencies considered this concept and this final program provides each manufacturer with a limited "allowance" of trailers that do not need to meet the standards. In determining an appropriate value for this allowance, the agencies sought to balance the need for some degree of flexibility in the absence of averaging while minimizing changes in the competitive relationships among larger and smaller trailer manufacturers. An allowance of 20 percent, as suggested by Stoughton, is problematic, since the annual production for individual trailer manufacturers varies so widely. An allowance of 20 percent for a very large manufacturer could very well represent the same volume of trailers as an entire year's sales for a small manufacturer. This in turn could result in a situation where a large number of non-complying trailers would be on the market, potentially attracting customers away from smaller manufacturers that needed to market complying trailers.

Because of this, the agencies estimated a representative volume of trailers based on the 2015 Trailer Production Figures published by Trailer-BodyBuilders.com.<sup>374</sup> The smallest box van manufacturer in the list produced 1800 dry freight vans in 2015. Twenty percent of that production is 360 trailers. The agencies are adopting an interim provision providing box van manufacturers an allowance of 20 percent of their production (up to a maximum of 350 units) that are not

<sup>374</sup> 2015 Trailer Production Figures Table. Schenk, Paul. March 4, 2016. Accessed January 4, 2016. Available at: <http://trailer-bodybuilders.com/trailer-output/2015-trailer-production-figures-table>.

required to meet the standards for model years 2018 through 2026 when we do not include averaging. All lengths of box vans, including both dry and refrigerated, produced by a given manufacturer count toward the allowance.

While averaging does not apply for partial- and non-aero box trailers at any point in the program, the agencies believe manufacturers can also benefit from the ability to exempt some trailers from these subcategories in the early years as they transition into the full program. For MY 2018 through 2026, manufacturers can include partial- and non-aero box trailers in their 350 box van allowance. In MY 2027, we believe all partial- and non-aero box vans can meet the reduced standards for their given subcategories.

Non-box trailers have design-based tire standards and averaging thus does not apply for this subcategory. Similar to the partial- and non-aero box vans, we also believe non-box manufacturers can benefit from a transitional exemption allowance. The agencies are adopting a separate allowance for non-box trailers, because their production volumes differ and many non-box trailer manufacturers do not build box vans. Using the same trailer production figures, we found that the smallest non-box trailer manufacturer in the list produced 1325 trailers in 2015 and twenty percent of that production is 265 trailers. From MY 2018 through 2026, non-box trailer manufacturers can exempt 20 percent or 250 trailers from the applicable tire standards. By MY 2027, we believe all non-box trailers can incorporate the tire technologies required by the design standards.

The agencies estimate that the box van and non-box trailer allowances translate on average to less than two percent of production across the trailer industry, and the agencies believe that this minor degree of loss of emission and fuel consumption reduction benefits is more than offset by the flexibility which, as pointed out earlier, may be needed by this newly regulated industry segment. These allowances are specified in 40 CFR 1037.150 and 49 CFR 535.3.

#### (b) Averaging Provisions for the Late Years of the Trailer Program

The agencies proposed to allow trailer manufacturers to use averaging throughout the phase-in of the program as one option for complying with the trailer standards. As noted, we received nearly unanimous comments, in response to the pre-proposal SBREFA panel and to the NPRM, from trailer manufacturers opposing averaging.

Specifically, the commenters cited their concern that the unique aspects of the trailer market tend to mean that the value of averaging as a tool is less than it has been for manufacturers in other industries, and the potential for negative consequences to some manufacturers is substantial. The trailer manufacturing industry is very competitive, and manufacturers must be highly responsive to their customers' diverse demands. Compared to other industry sectors, they can have little control over what kinds of trailer models their customers demand and thus limited ability to manage the mix and volume of different products. Additionally, one of the larger, more diverse manufacturers could potentially supply a customer with trailers that had few if any aerodynamic features, while offsetting this part of their business with over-complying trailers that they were able to sell to another customer; many smaller companies with limited product offerings might not be able to compete for those customers.

As a result of the many comments opposing averaging from trailer manufacturers—the very stakeholders meant to benefit from an averaging program—the agencies have reconsidered how averaging is incorporated into the program. The final program does not allow averaging as a compliance option in the early years of the program, in MY 2018 through MY 2026. In those years, all box vans sold (beyond a manufacturer's allowance of non-complying trailers) must meet the standards using any combination of available technologies.

However, the agencies have concluded that by late in the program, the value of an averaging option to many trailer manufacturers may well outweigh the concerns they have expressed. In addition, the final stage of the phase-in of the standards for MY 2027 represents the most stringent standards in the program, and additional flexibility may be welcome by trailer manufacturers. Therefore, the final program will provide a limited optional averaging program for MY 2027 and later full-aero box vans. By that time, we believe that the trailer manufacturers will be experienced and comfortable with the program, and the industry will be more familiar with the technologies.

The MY 2027 and later averaging provisions are identical in most respects to those we proposed for the other Phase 2 vehicle programs. One notable difference involves use of credits. As in the proposed trailer program, the averaging provisions for trailers focus on each individual model year's

production. A manufacturer choosing to use the averaging provisions could not “bank” compliance credits for a future model year or “trade” (sell) credits to another manufacturer, since these provisions would disproportionately benefit the few large trailer manufacturers. Under these averaging provisions, a full-aero box van manufacturer that produces some MY 2027 or later box vans that perform better than required by the applicable standard could produce a number of vans in the same family that do not meet the standards, provided that the average compliance levels of the trailers it produces in any given model year is at or below the applicable standards for that family.

As in the proposed program, averaging is only available for full-aero box vans. The program is already designed to offer reduced standards for box vans designated as partial-aero, and the additional flexibility of averaging is not available. Also, averaging is inherently incompatible with design standards for non-aero box vans and non-box trailers, since those manufacturers cannot choose among compliance paths.

The agencies are adopting averaging sets for full-aero box vans based on trailer length. Trailers in a family are certified to a single standard, but individual trailers within the family may be grouped to certify to a family emissions limit (FEL) that is higher or lower than the standard, provided the production-weighted average of all FELs in a family can be averaged to the standard or better. By allowing averaging sets to include both refrigerated and dry vans similar length categories, a manufacturer that over-complies, on average, in one family, can use the credits generated toward compliance in the other family. For example, if a manufacturer has two subfamilies in each of its long dry and long refrigerated van families, and the over-compliance of one dry van subfamily exceeds the under-compliance of the other dry van subfamily, the additional over-compliance beyond the dry van family's standard become credits that can be used to offset any under-compliance in the refrigerated van family.

In order to avoid backsliding with the use of averaging, the agencies are adopting a provision to require a minimum level of technology adoption in MY 2027 and later. No FEL can exceed the MY 2018 standard for the given trailer subcategory. For example, a manufacturer could not over-comply on some trailers and expect to produce a fraction of their trailers with zero

technologies installed; every trailer must, at minimum, include enough technologies to meet the corresponding MY 2018 standard. See 40 CFR 1037.107(a)(5) and 49 CFR 535.5(e).

As mentioned previously, manufacturers with a trailer family that performed better than the standard at the end of the year would not be allowed to bank credits for a future model year. However, the agencies understand that it is possible for a manufacturer to misjudge production and come up short at the end of the model year. In such a case, the program provides for a manufacturer to generate a credit deficit, if necessary, as a temporary recourse for unexpected challenges in a given model year.<sup>375</sup> The agencies would closely monitor the certification applications for the following model year, to ensure the manufacturer can make progress in reducing the deficit. Any such credit deficits would need to be resolved within the following three model years, and the manufacturer would need to generate credits from over-compliance in subsequent years to address deficits from prior model years. See 40 CFR 1037.745.

The agencies believe that limiting the availability of averaging provisions to the final stage of the program will ease a number of the competitive concerns that trailer manufacturers have raised, since the trailer program will be familiar and the value of averaging may be greater as the most stringent standards phase in. Small business manufacturers raised concerns in our pre-proposal small business outreach that averaging would disproportionately benefit larger manufacturers with larger production volumes and greater product diversity. We are limiting our averaging program to single model year averaging (*i.e.*, no banking or trading) to help address this concern. Similarly, we are adopting a maximum FEL based on the MY 2018 standard to ensure that larger manufacturers will not be able to produce large volumes of trailers with little or no technologies at the expense of manufacturers that cannot accumulate sufficient over-compliance within their annual production. To the extent that concerns about the MY 2027 and later averaging provisions remain as that model year approaches, the agencies look forward to working with manufacturers as they consider using averaging.

<sup>375</sup> Section IV.E.(1)(b) describes the process of identifying trailer families and sub-families based on basic trailer characteristics. 40 CFR 1037.710 describes the provisions for establishing subfamilies within a trailer family and the Family Emission Limits that are averaged among the subfamilies.

#### (c) Aerodynamic Device Testing Using SmartWay-Verified Data

The agencies expect some trailer manufacturers and aerodynamic device manufacturers to continue to submit test data to the SmartWay program for verification. Since many manufacturers have some experience with EPA's SmartWay program, the agencies have designed the trailer program and aerodynamic testing to recognize the significant synergy with the SmartWay Technology Program. Section IV.E.(3)(b)(v) describes the compliance path available to trailer manufacturers to use pre-approved performance data for aerodynamic devices. As an additional interim option, any device manufacturer that attains SmartWay verification for a device prior to January 1, 2018 is eligible to submit its previous SmartWay-verified data to EPA's Compliance Division for pre-approval, provided their test results come from one of SmartWay's 2014 test protocols that measure a delta  $C_{dA}$ . The protocols for coastdown, wind tunnel, and computational fluid dynamics analyses result in a  $C_{dA}$  value. Note that SmartWay's 2014 protocols allow SAE J1321 Type 2 track testing, which generates fuel consumption results, not  $C_{dA}$  values. Two commenters (a device manufacturer and an NGO) requested that we allow SAE J1321 track test results, but did not suggest a means of converting from the fuel consumption results to an appropriate delta  $C_{dA}$  value for use in compliance. As a result, the agencies will not accept J1321 data for pre-approval.

Beginning on January 1, 2018, EPA will require that device and trailer manufacturers that seek approval of new aerodynamic technologies for trailer certification use one of the approved test methods for Phase 2 (*i.e.*, coastdown, wind tunnel or CFD) and the test procedures found in 40 CFR 1037.526. Aerodynamic technologies that were pre-approved using performance data from SmartWay's 2014 Protocols will maintain their approved status through December 31, 2020. Beginning January 1, 2021, all pre-approval of device performance will need to be based on testing using the Phase 2 test procedures.

#### (d) Off-Cycle Technologies

The Phase 1 and Phase 2 programs include provisions for manufacturers to request the use of off-cycle technologies that are not recognized in GEM and were not in common use before MY 2010. During the development of the trailer proposal, the agencies were not aware of any technologies that could

improve CO<sub>2</sub> and fuel consumption performance that would not be captured in the trailer test protocols, and we did not propose a process to evaluate off-cycle trailer technologies. We continue to believe that effective trailer aerodynamic technologies that would not be captured by the test protocols are unlikely to emerge. However, Wabash provided comments requesting a process for evaluating future trailer weight reduction options. They suggested that these options could include lightweight components that are not listed in our regulations as approved material substitution components, or overall trailer weight reduction strategies that are not limited to individual components.

In light of these comments and further consideration of the issue, the agencies believe that the off-cycle technology process is an appropriate way for certain box van manufacturers—that is, those using the compliance equation and not subject to the design standards—to receive credit for future lightweighting or other technologies that are not recognized in the compliance equation. For this reason, we have incorporated box vans into the existing off-cycle provisions. In the case of lightweighting, a measured difference in trailer weight could substitute for the weight component of the compliance equation. For other such technologies (should any exist), the general off-cycle provisions apply. See 40 CFR 1037.515(e).

#### (e) Small Business Regulatory Flexibility Provisions

As a part of our small business obligations under the Regulatory Flexibility Act, EPA and NHTSA have considered additional flexibility provisions aimed at this segment of the trailer manufacturing industry. EPA convened a Small Business Advocacy Review (SBAR) Panel as required by the Small Business Regulatory Enforcement Fairness Act (SBREFA), and much of the information gained and recommendations provided by this process form the basis of the proposed flexibilities.<sup>376</sup> As in previous rulemakings, our justification for including provisions specific to small businesses is that these entities generally have a greater degree of difficulty in complying with the

<sup>376</sup> Additional information regarding the findings and recommendations of the Panel are available in Section XIV, Chapter 12 of the RIA, and in the Panel's final report titled "Final Report of the Small Business Advocacy Review Panel on EPA's Planned Proposed Rule: Greenhouse Gas Emissions and Fuel Efficiency Standards for Medium- and Heavy-Duty Engines and Vehicles: Phase 2" (See Docket EPA-HQ-OAR-2014-0827).

standards compared to other entities. Thus, as discussed below, we are adopting several regulatory flexibility provisions for small trailer manufacturers that we believe will reduce the burden on them while achieving the goals of the program.

The agencies identified 178 trailer and tank manufacturers for our analysis and we believe 147 qualify as small business (*i.e.*, less than 1000 employees).<sup>377</sup> The agencies designed many of the program elements and flexibility provisions available to all trailer manufacturers with the large fraction of small business trailer manufacturers in mind. For the small van manufacturers, we believe the option to choose pre-approved aerodynamic data will significantly reduce the compliance burden and eliminate the requirement for all manufacturers to perform testing. We are also limiting the final non-box trailer program to tanks, flatbeds, and container chassis. All other non-box trailers are exempt from the Phase 2 trailer program, with no regulatory requirements. This exemption reduces the number of small businesses in the trailer program from 147 to 74 companies at the time of the development of this rulemaking. With no regulatory requirements, these companies have zero burden under the trailer program. We are also adopting the proposed design standards for the remaining non-box trailers, such that they can certify by installing tire technologies only, with no testing requirements. The agencies are also adopting provisions that would increase the number of eligible tire pressure systems that can be installed for compliance. In addition to ATIS, TPMS is a recognized technology in the final rulemaking. Furthermore, the non-box trailers, which have design-based tire standards, comply if they have either a TPMS or an ATIS, and appropriate lower rolling resistance tires. The inclusion of the less expensive TPMS as a tire pressure system option will improve the availability of technologies and reduce the technology cost for many small businesses.

As noted above, the small trailer manufacturers raised concerns that their businesses could be harmed by provisions allowing averaging, banking, and trading of emissions and fuel

consumption performance, since they will not be able to generate the same volume of credits as large manufacturers. The agencies are not adopting banking and trading provisions in any part of the program, and are limiting the option to average to manufacturers of full-aero dry and refrigerated box trailers and delaying the averaging until MY 2027. Similarly, we are adopting a maximum FEL based on the MY 2018 standard to ensure that larger manufacturers will not be able to produce large volumes of trailers with little or no technologies at the expense of manufacturers that cannot accumulate sufficient over-compliance within their annual production. We expect that the familiarity of the industry, including small business manufacturers, with the trailer program by this stage of the program, and the requirement that all trailers meet at least the MY 2018 level of control, will reduce the concerns of small manufacturer compared to an earlier or broader averaging program.

For all small business trailer manufacturers, the agencies are adopting a one-year delay in the beginning of implementation of the program, until MY 2019. We believe that this allows small businesses additional needed lead time to make the necessary staffing adjustments and process changes, and possibly add new infrastructure to meet the requirements of the program. TTMA commented that all trailer manufacturers are “small businesses” relative to other heavy-duty industries and that the one-year delay would divert sales to small businesses for that model year. Wabash argued that providing a flexibility is not required by the RFA and not authorized by the Clean Air Act. The agencies believe that small businesses do not have the same resources available to become familiar with the regulations, make process and staffing changings, or evaluate and market new technologies as their larger counterparts. We believe a one-year delay provides additional time for small businesses to address these issues, without a large CO<sub>2</sub> and fuel consumption impact or substantial negative competitive effects. The cumulative annual production of all of the small business box trailer manufacturers is estimated to be less than 15 percent of the industry’s total production, which is significantly less than the annual production of the four largest manufacturers.<sup>378</sup> We expect any diverted sales for this one year will be

a small fraction of the large manufacturers’ production and we are finalizing the one-year delay for all small business trailer manufacturers.

Chapter 12 of the RIA presents the agencies’ Final Regulatory Flexibility Analysis. In this chapter, we discuss the recommendations of the Panel, what we proposed, and what we finalized for the small businesses regulated in Phase 2. We also estimate the economic effect of the rulemaking on these businesses based on their annual revenue. Considering the flexibilities adopted in this rulemaking, our estimate of compliance burden indicates that only 15 of the 147 small trailer manufacturers (about 10 percent) will have an economic impact greater than one percent of their annual revenue. Therefore, we believe the trailer provisions in this rulemaking do not have a significant impact on small businesses.

## V. Class 2b–8 Vocational Vehicles

### A. Summary of Phase 1 Vocational Vehicle Standards

Class 2b–8 vocational vehicles include a wide variety of vehicle types, and serve a wide range of functions. Some examples include service for urban delivery, refuse hauling, utility service, dump, concrete mixing, transit service, shuttle service, school bus, emergency, motor homes, and tow trucks. In the HD Phase 1 Program, the agencies defined Class 2b–8 vocational vehicles as all heavy-duty vehicles that are not included in the Heavy-duty Pickup Truck and Van or the Class 7 and 8 Tractor categories. In effect, the rules classify heavy-duty vehicles that are not a combination tractor or a pickup truck or van as vocational vehicles. Class 2b–8 vocational vehicles and their engines emit approximately 17 percent of the GHG emissions and burn approximately 17 percent of the fuel consumed by today’s heavy-duty truck sector.<sup>379</sup>

Most vocational vehicles are produced in a two-stage build process, though some are built from the “ground up” by a single entity. In the two-stage process, the first stage sometimes is completed by a chassis manufacturer that also builds its own proprietary components such as engines or transmissions. This is known as a vertically integrated manufacturer. The first stage can also be completed by a chassis manufacturer who procures all

<sup>377</sup> In the period between the SBAR Panel and Initial Regulatory Flexibility Analysis and issuing of the final rule, the Small Business Administration (SBA) finalized new size standards for small business classification. For trailers, the threshold to qualify as small changed from 500 employees to 1000 employees. We have updated our analysis to reflect the new size standards.

<sup>378</sup> See Figure 1–3 of Chapter 1 in the RIA comparing the 2015 trailer output from the top 28 trailer manufacturers.

<sup>379</sup> Memorandum to the Docket “Runspeccs, Model Inputs, MOVES Code and Database for HD GHG Phase 2 FRM Emissions Modeling.” July 2016. See also EPA’s MOVES Web page at <https://www3.epa.gov/otaq/models/moves/index.htm>.

components, including the engine and transmission, from separate suppliers. The product completed at the first stage is generally either a stripped chassis, a cowed chassis, or a cab chassis. A stripped chassis may include a steering column, a cowed chassis may include a hood and dashboard, and a cab chassis may include an enclosed driver compartment. Many of the same companies that build Class 7 and 8 tractors also sell vocational chassis in the medium heavy- and heavy heavy-duty weight classes. Similarly, some of the companies that build Class 2b and 3 pickups and vans also sell vocational chassis in the light heavy-duty weight classes.

The second stage is typically completed by a final stage manufacturer or body builder, which installs the primary load carrying device or other work-related equipment, such as a dump bed, delivery box, or utility boom. There are over 200 final stage manufacturers in the U.S., most of which are small businesses. Even the large final stage manufacturers are specialized, producing a narrow range of vehicle body types. These businesses also tend to be small volume producers. In 2011, the top four producers of truck bodies sold a total of 64,000 units, which is about 31 percent of sales in that year.<sup>380</sup> In that same year, 74 percent of final stage manufacturers produced less than 500 units.

The businesses that act both as the chassis manufacturer and the final stage manufacturer are those that build the vehicles from the “ground up.” These entities generally produce custom products that are sold in lower volumes than those produced in large commercial processes. Examples of vehicles produced with this build process include fire apparatus and transit buses.

The diversity in the vocational vehicle segment can be primarily attributed to the variety of customer needs for specialized vehicle bodies and added equipment, rather than to the chassis. For example, a body builder can build either a Class 6 bucket truck or a Class 6 delivery truck from the same Class 6 chassis. The aerodynamic difference between these two vehicles due to their bodies leads to different in-use fuel consumption and GHG emissions. However, the baseline fuel consumption and emissions due to the components included in the common chassis (such as the engine, drivetrain, frame, and tires) may be the same between these two types of vehicles.

Owners of vocational vehicles that are upfitted with high-priced bodies that are purpose-built for particular applications tend to keep them longer, on average, than owners of vehicles such as pickups, vans, and tractors, which are traded in broad markets that include many potential secondary markets. The fact that vocational vehicles also generally accumulate far fewer annual miles than tractors further contributes to lengthy trade cycles among owners of these vehicles. To the extent vocational vehicle owners may be similar to owners of tractors in terms of business profiles, they are more likely to resemble private fleets or owner-operators than for-hire fleets. A 2013 survey conducted by NACFE found that the trade cycle of private tractor fleets ranged from seven to 12 years.<sup>381</sup>

The Phase 1 standards for this vocational vehicle category generally apply at the chassis manufacturer level. For the same reasons given in Phase 1, the agencies are applying the Phase 2 vocational vehicle standards at the chassis manufacturer level.<sup>382</sup>

The Phase 1 regulations prohibit the introduction into commerce of any heavy-duty vehicle without a valid certificate or exemption. 40 CFR 1037.622, originally codified as 40 CFR 1037.620, allows for a temporary exemption for the chassis manufacturer if it produces the chassis for a secondary manufacturer that holds a certificate. The agencies received several comments on the requirements for secondary manufacturers. A discussion of temporary exemptions and obligations of secondary manufacturers can be found in Section V.D.(2).

In Phase 1, the agencies adopted two equivalent sets of standards for Class 2b–8 vocational vehicles. For vehicle-level (chassis) emissions, EPA adopted CO<sub>2</sub> standards expressed in grams per ton-mile. For fuel efficiency, NHTSA adopted fuel consumption standards expressed in gallons per 1,000 ton-miles. The Phase 1 engine-based standards vary based on the expected weight class and usage of the vehicle into which the engine will be installed. We adopted Phase 1 vehicle-based standards that vary according to one key attribute, GVWR, based on the same groupings of vehicle weight classes used for the engine standards—light heavy-duty (LHD, Class 2b–5), medium heavy-duty (MHD, Class 6–7), and heavy heavy-duty (HHD, Class 8).

In Phase 1, the agencies defined a special regulatory category called

vocational tractor, which generally operate more like vocational vehicles than line haul tractors.<sup>383</sup> As described above in Section III.C.4, under the Phase 1 rules, a vocational tractor is certified under standards for vocational vehicles, not those for tractors. In Phase 2, the agencies are revising the vocational tractor definition to remove heavy-haul tractors, as we are adopting tractor standards for these. The agencies received many comments pertaining to vocational tractors, which are described in Section III.C.4 and Section V.B.

Manufacturers are required to use GEM to determine compliance with the Phase 1 vocational vehicle standards, where the primary vocational vehicle manufacturer-generated input is the measure of tire rolling resistance. The GEM assumes the use of a typical representative, compliant engine in the simulation, resulting in one overall value for CO<sub>2</sub> emissions and one for fuel consumption. The manufacturers of engines intended for use in vocational vehicles are subject to separate Phase 1 engine-based standards. Manufacturers also may demonstrate compliance with the CO<sub>2</sub> standards in whole or in part using credits reflecting CO<sub>2</sub> reductions resulting from technologies not reflected in the GEM testing regime. See 40 CFR 1037.610.

In Phase 1, EPA and NHTSA also adopted provisions designed to give manufacturers a degree of flexibility in complying with the standards. Most significantly, we adopted an ABT program to allow manufacturers to comply on average within a given averaging set. See 40 CFR part 1037, subpart H. These provisions enabled the agencies to adopt overall standards that are more stringent than we could have considered with a less flexible program.<sup>384</sup>

#### *B. Phase 2 Standards for Vocational Vehicles*

Since proposal, in addition to considering substantive written public comments, the agencies have held dozens of meetings with manufacturers, suppliers, non-governmental organizations (NGOs), and other stakeholders to better understand the opportunities and challenges involved with regulating vocational vehicles. These meetings have helped us to better

<sup>383</sup> See EPA’s regulation at 40 CFR 1037.630 and NHTSA’s regulation at 49 CFR 523.2.

<sup>384</sup> As noted earlier, NHTSA notes that it has greater flexibility in the HD program to include consideration of credits and other flexibilities in determining appropriate and feasible levels of stringency than it does in the light-duty CAFE program. *Cf.* 49 U.S.C. 32902(h), which applies to light-duty CAFE but not to heavy-duty fuel efficiency under 49 U.S.C. 32902(k).

<sup>380</sup> Specialty Transportation.net, 2012. Truck Body Manufacturing in North America.

<sup>381</sup> See 2013 ICCT Barriers Report, Note 364 above.

<sup>382</sup> See 76 FR 57120.

develop final Phase 2 standards. As an example, we have updated our industry characterization to better describe the vocational vehicle market, including the custom chassis manufacturers.<sup>385</sup> We believe these information exchanges have enabled us to develop these rules with an appropriate balance of achievable reductions at reasonable cost with a reasonably small risk of unintended consequences.

#### (1) Final Subcategories and Test Cycles

The Phase 2 vocational vehicle standards are based on the performance of a wider array of control technologies than the Phase 1 rules. In particular, as proposed, the Phase 2 vocational vehicle standards recognize detailed characteristics of powertrains and drivelines. As described below, driveline improvements present a significant opportunity for reducing fuel consumption and CO<sub>2</sub> emissions from vocational vehicles. However, there is no single package of driveline technologies that will be equally suitable for the majority of vocational vehicles, because there is an extremely broad range of driveline configurations available in the market. This is due in part to the variety of build processes, ranging from a purpose built custom chassis to a commercial chassis that may be intended as a multi-purpose stock vehicle. Further, the wide range of applications and driving patterns of these vehicles leads manufacturers to offer a variety of drivelines, as each performs differently in use. For example, depending on whether the transmission has an overdrive gear, drive axle ratios for Class 7 and 8 tractors can generally be found in the range of 2.5:1 to 4.1:1. By contrast, across all types of vocational vehicles, drive axle ratios can range from 3.1:1 (delivery vehicle) to 9.8:1 (transit bus).<sup>386</sup> Other components of the driveline also have a broader range of product in vocational vehicles than in tractors, including transmission gears, tire sizes, and engine speeds. Each of these design features affects the GHG emission rate and fuel consumption of the vehicle. It therefore is reasonable to define more than one baseline configuration of vocational vehicle, to

encompass a range of drivelines. A detailed list of the technologies the agencies project could be adopted to meet the vocational vehicle standards is described in Section V.C, and in the RIA Chapter 2.9, along with a description of the differences in technology effectiveness that are projected to be demonstrated through GEM under different test cycles. The agencies have found that the ranges of effectiveness of a majority of the technologies are significant enough to merit creation of subcategories with different test cycles.

#### (a) Basis for Duty Cycles and Subcategories

The agencies are relying on work conducted by the U.S. Department of Energy at the National Renewable Energy Laboratory (NREL), as well as duty cycle information provided in public comments, in establishing the weighting factors for the test cycles to be used in the certification of heavy-duty vocational vehicles to the final Phase 2 standards. NREL's methodology and findings are described in a report in the docket for this rulemaking.<sup>387</sup> The data from NREL have also informed our segmentation process, and to some extent the technology assessment. For example, without data regarding the amount of parked idle observed by vocational vehicles in the NREL database, we would not have been able to sufficiently identify and recognize technologies that separately reduce either drive idle or parked idle emissions.<sup>388</sup> Based on available fleet data, NREL identified three general clusters of vehicle behavior: one cluster of vehicles most often driving with slower speeds and frequent stops; one with higher average speeds and fewer stops; and one multi-modal cluster with vehicles that may operate similarly to either of the other clusters on any given day. In Chapter 2.2 of the NREL report, an alternate bi-modal clustering analysis is also presented, where instead of having a distinct middle cluster, vehicles with highly variable driving patterns are grouped as either high speed or low speed. A preliminary update provided by NREL includes cycle weightings that correspond with this two cluster depiction of vehicle

behavior.<sup>389</sup> Based on the NREL report and other information, the agencies believe it is appropriate to finalize a regulatory subcategory structure that includes a drive cycle appropriate for mixed use vehicles; especially considering that the ultimate application of incomplete chassis is unknown at the time of certification. In other words, we are adopting a program structure that follows NREL's three cluster depiction of vehicle behavior. The final rules' primary vocational standards thus have subcategories for Regional, Multi-purpose, and Urban drive cycles in each of the three weight classes (LHD, MHD and HHD), which results in nine unique subcategories.

In the final weeks before promulgation, the agencies received significant new comments from a number of vehicle manufacturers, along with new data characterizing in detail the distribution of powertrain configurations of their vehicles.<sup>390</sup> These recent comments suggested some uncertainty with respect to the three drive cycle structure, and the manufacturers expressed related concerns regarding assumptions about transmissions in our baseline vehicle configurations, which they believe could result in some OEMs being put at competitive disadvantage. The agencies appreciate these new comments and data; however, we determined that it would not be appropriate to alter this regulatory action so late in the rulemaking process based solely upon this newly submitted information, which was not made available for broader public comment. Instead, the agencies will continue to analyze this new information and any other new information we receive. We will also continue to actively engage with manufacturers and other stakeholders to determine if future revisions to the vocational vehicle program structure are warranted, based on this and any other new information. For example, it is possible that further analysis of new data could lead us to consider proposing amendments to adopt the two cluster approach for one or more of the vehicle weight classes, or to consider amending the regulatory constraints limiting the choice of drive cycle subcategory that we are adopting to prevent potential adverse impacts of vehicle misclassification. However, at this time the final program structure, including these constraints, will remain in place

<sup>385</sup> See Chapter 1 of the RIA.

<sup>386</sup> See Dana Spicer Drive Axle Application Guidelines, available at [http://www.dana.com/wps/wcm/connect/133007004bd8422b9ea8be14e7b6dae0/DEXT-daag2012\\_0712\\_DriveAxlesAppGuide\\_LR.pdf?MOD=AJPERES&CONVERT\\_TO=url&CACHEID=133007004bd8422b9ea8be14e7b6dae0](http://www.dana.com/wps/wcm/connect/133007004bd8422b9ea8be14e7b6dae0/DEXT-daag2012_0712_DriveAxlesAppGuide_LR.pdf?MOD=AJPERES&CONVERT_TO=url&CACHEID=133007004bd8422b9ea8be14e7b6dae0). See also ZF Driveline and Chassis Technology brochure, available at [http://www.zf.com/media/media/en/document/corporate\\_2/downloads/1/flyer\\_and\\_brochures/bus\\_driveline\\_technology\\_flyer/Busbrochure\\_12\\_DE\\_final.pdf](http://www.zf.com/media/media/en/document/corporate_2/downloads/1/flyer_and_brochures/bus_driveline_technology_flyer/Busbrochure_12_DE_final.pdf).

<sup>387</sup> National Renewable Energy Laboratory July 2016, "The Development of Vocational Vehicle Drive Cycles and Segmentation," NREL/TP-5400-65921.

<sup>388</sup> While drive idle can generally be thought of as in-gear and parked idle can generally be thought of as out-of-gear, NREL has data on driving patterns for trucks with manual transmissions and has considered the fact that these are always out of gear when the vehicle has zero speed. See Section 5.5 of the final NREL report for more details.

<sup>389</sup> See memorandum dated July 2016 titled, "NREL Bi-Modal Vocational Vehicle Cluster Information."

<sup>390</sup> See memorandum dated July 2016 titled, "Summary of Late Comments on Vocational Transmissions and N/V."

unless and until the agencies determine that revisions to the vocational vehicle program structure are warranted, in which case the agencies would undertake a notice and comment rulemaking proposing to amend the programmatic structure, consistent with such a determination. In considering whether to undertake further action, the agencies will necessarily be mindful of statutory lead time requirements and other practical considerations.

NREL also synthesized a new transient test cycle using statistical targets and the DRIVE tool. Eaton commented that the new transient cycle developed by NREL is similar to cycles they use to calibrate shift controls, and is more representative of how trucks are driven than the current ARB Transient certification test cycle. Although there is some reason to believe this new cycle may actually be more representative of nationwide operation than the ARB transient cycle, the agencies recognize that sufficient uncertainty remains that we are not prepared to adopt this new NREL transient cycle for Phase 2 certification at this time. The agencies also note that, although GEM has been extensively validated for the ARB transient cycle, we have not conducted a similar validation for the NREL cycle. Nevertheless, we will continue to evaluate this cycle and may reconsider it as part of a future rulemaking. The most significant shortfall identified by NREL in their comparison of real world vocational vehicle operation and the ARB transient cycle is a gap in measurement points between speeds of 48 and 55 mph. We have remedied this shortfall by adjusting the composite weighting factor of the 55 mph cruise cycle. Because vehicles tested in GEM over our final road grade profile have been observed to decrease speed well below 55 mph during this cycle, those measurement points that are absent from the ARB transient cycle are captured in the nominally 55 mph test cycle.

Other commenters questioned whether the vehicles from which NREL collected data for the cycle were

sufficiently representative, or whether sufficient data existed to justify the NREL weightings, while other commenters supported use of the data. Daimler supported making changes to reflect the NREL-recommended weightings to align with real-world data. ACEEE supported using the more realistic NREL cycle weightings to revisit stringency where certain technologies may be more effective over the new cycles. Both Volvo and Navistar expressed concerns that the NREL study fleet doesn't appear to be representative. Navistar believes that the NREL data has too few refuse trucks, and Volvo believes that the NREL data has too few class 8 vehicles. In fact, 35 percent of the vehicles in the NREL database that were evaluated for the drive cycle analysis are class 8, which we believe is (if anything) *over-representative* of the percent of new HHD vehicles manufactured each year. Because the full NREL database also contains over five percent refuse trucks and our MOVES model estimates that refuse trucks comprise only three percent of newly manufactured vocational vehicles each year, we directed NREL to remove excess refuse trucks from their final analysis, to avoid skewing the data by over-representing refuse trucks.<sup>391</sup> A similar process was followed for removing excess school buses and transit buses. More details are available in the NREL report.<sup>392</sup> While some discrepancies may remain between the NREL vehicle distribution and the national fleet, we are confident they are sufficiently small to allow us to use this report to establish weighting factors for different types of operation. Moreover, the agencies believe the more relevant question to be whether or not the cycles exercise the technologies over enough of the range of in-use operation to effect in-use reductions, and to reasonably estimate the extent of those reductions. In this context, the weighting factors and duty-cycles are fully adequate.

After considering all the comments, the agencies are establishing nine subcategories of vocational vehicles in Phase 2, based on the three weight class

groups of vocational vehicles described above that are continuing from the Phase 1 program, plus Regional, Multipurpose and Urban duty cycle groups, as shown in Table V-1 below. For reasons described below in Section V.C.(2)(a) we are not establishing distinct subcategories for SI-powered vocational vehicles in the HHD weight class. Thus, with nine diesel subcategories and six gasoline subcategories, we are essentially setting 15 separate numerical performance standards. As described in Section V.B.2, we are also adopting optional standards for seven subcategories of custom vocational chassis.

This structure enables the technologies that perform best at highway speeds and those that perform best in urban driving to each be properly recognized over appropriate drive cycles, while avoiding unintended results of forcing vocational vehicles that are designed to serve in different applications to be measured against a single drive cycle. The agencies intend for these three drive cycles to balance the competing pressures to recognize the varying performance of technologies, serve the wide range of customer needs, and maintain reasonable regulatory simplicity. In light of the very recent comments noted above, if the agencies were to determine in the future that revisions to the vocational vehicle program structure are warranted, we would intend to propose any revisions in a way that would be consistent with the technology feasibility and cost-benefit analyses of this final rulemaking. In other words, the agencies do not anticipate any changes to the technology basis for, or the effective stringency of, the final standards. Rather, potential changes in program structure would only be to better assure that the projected reductions are achieved in use, consistent with the projected technology packages on whose performance the stringency of the final standards are based, and consistent with the costs we projected for that compliance pathway.

TABLE V-1—REGULATORY SUBCATEGORIES FOR VOCATIONAL VEHICLES

Weight class	Light heavy-duty class 2b-5	Medium heavy-duty class 6-7	Heavy heavy-duty class 8 (CI only)
Duty Cycle .....	Regional ..... Multi-Purpose ..... Urban .....	Regional ..... Multi-Purpose ..... Urban .....	Regional. Multi-Purpose. Urban.

<sup>391</sup> MOVES 2014. See Note 379 above.

<sup>392</sup> National Renewable Energy Laboratory July 2016, "The Development of Vocational Vehicle

Drive Cycles and Segmentation," NREL/TP-5400-65921.



In the NREL Fleet DNA clustering analysis, the mediod of each cluster was characterized using eight drive cycle metrics, and distance histograms were created for each statistically representative vehicle. By summing the miles accumulated at different driving speeds (including zero speed idle), NREL was able to recommend composite cycle weightings. Commenters suggested that the proposed weightings of both highway cruise and idle were too low for some vehicles. When the agencies released additional data for comment in February 2016, an early draft of NREL’s duty cycle report was included. Most commenters supported the draft NREL duty cycles. Volvo commented that NREL’s cycle weightings didn’t match their extensive telematics database for their class 8 vocational vehicles, and recommended specific changes to increase the weighting of 65 mph for Urban and Multipurpose HHD vehicles.

A description of the drive cycle data submitted to the agencies by Volvo in support of the final test cycles is found in the RIA Chapter 3.4.3.1. In response, we have adjusted our composite test weightings for Urban and Multipurpose HHD vehicles in consideration of Volvo’s data. Although Volvo also suggested specific cycle weightings for coach buses, we have established optional coach bus standards (one example of the custom chassis standards the agencies are adopting) with the same weightings as for other Regional vehicles for reasons described below in V.B.2.b. The final cycle weightings shown in Table V–2 reflect NREL’s recommendations along with consideration of public comments. Although both NREL and Volvo data showed vehicles whose behavior would logically be classified as Urban accumulating some miles (from one to seven percent) in the 65 mph range, the agencies are applying a zero weighting

factor to the 65 mph cycle for all Urban vehicles for certification purposes. Instead, those miles are assigned to the 55 mph cycle. We believe it is important to have a test cycle available in the primary program for vehicles that may regularly drive on urban or local highways, but are not expected (or designed) to drive on rural highways. Further, the final rules include the refinement of a split idle cycle (parked idle and drive idle), since NREL’s final report includes analysis of data characterizing the percent of time in a work day that vocational vehicles idle when parked as distinct from idling time when stopped in traffic. More details on the characterization of parked and drive idle are found in the RIA Chapter 2.9.3.4. More details of the NREL clustering analysis are found in the RIA Chapter 2.9.2, and more details on the data behind the final composite cycle weightings are found in the RIA Chapter 3.4.3.

TABLE V–2—COMPOSITE TEST CYCLE WEIGHTINGS (IN PERCENT) FOR VOCATIONAL VEHICLES

	ARB transient	55 mph Cruise with road grade <sup>a</sup>	65 mph Cruise with road grade <sup>a</sup>	Parked idle	Drive idle
Regional .....	0.20	0.24	0.56	0.25	0.00
Multi-Purpose (2b–7) .....	0.54	0.29	0.17	0.25	0.17
Multi-Purpose (class 8) .....	0.54	0.23	0.23	0.25	0.17
Urban (2b–7) .....	0.92	0.08	0.00	0.25	0.15
Urban (class 8) .....	0.90	0.10	0.00	0.25	0.15

**Note:**

<sup>a</sup> As described in Section II, the agencies have adopted highway cruise test cycles with revised road grade profiles.

We recognize that by adopting a few meaningful duty cycles that “bound” how vocational vehicles are generally used, we cannot perfectly match how every vocational vehicle is actually used. There are a few vehicle applications we have identified, for which these general cycles are likely to be poorly representative. We received several comments that our proposed duty cycles are particularly unrepresentative of real world behavior of transit buses and refuse trucks, for example. These vehicles also generally have chassis characteristics unlike those in the reference GEM vehicles used to establish the subcategory baselines. The agencies have determined that it is impractical, from a regulatory perspective, to establish separate, unique test cycles for transit buses or refuse trucks. In considering the challenges of such an undertaking, as well as the market structure of manufacturers who produce such vehicles, the agencies are instead adopting separate standards for transit buses and refuse trucks as part of the

final Phase 2 program for custom vocational chassis, as described in Section V.B.(2)(b).

Vocational vehicles neither qualifying under the optional custom chassis program nor meeting eligibility for exemption as low speed/off road vehicles will need to be certified in one of the primary subcategories established in this rulemaking. Below in Section V.C, the agencies explain the technology basis supporting the standards for each vehicle weight class.

The agencies received extensive comment on how to define attributes of vehicles in each subcategory to provide regulatory certainty to manufacturers. The proposed approach was to set criteria by which a vehicle manufacturer would know in which vocational subcategory—Regional, Urban, or Multipurpose—the vehicle should be certified, by use of cut-points defined using calculations relating engine speed to vehicle speed. Two commenters suggested we reinstate the Phase 1 approach with a one-size-fits-all drive cycle. Six commenters agreed with the

proposed approach on subcategorization, though some recommended slight adjustments. The final rules allow manufacturers to generally choose the subcategory of each vocational chassis, with a revised set of constraints essentially reflecting types of equipment on the vehicle (especially transmission type). In Section V.C.(2)(a) and the RIA Chapter 2.9, we describe changes since proposal with respect to the baseline vehicle configurations. In Section V.C.(2)(d), we describe the changes since proposal reflecting use of fleet average sales mixes in the standard-setting process. In Section V.D.(1)(e), we describe the constraints we are adopting regarding selection of subcategories by manufacturers. Taken together, these analyses demonstrate why we are confident that even if (generally against its own interests) a manufacturer chooses to certify a vehicle over a less appropriate test cycle, that choice would not result in a loss of environmental benefit. Continuing the averaging scheme from Phase 1, each manufacturer will



generally be able to average within each vehicle weight class (*i.e.* averaging sets are not further limited by the Regional, Multi-purpose, Urban subcategorization).

(b) Vocational Tractors

As discussed in Section V.A., the Phase 1 program includes a special regulatory category called vocational tractors, which covers vehicles that are technically tractors but generally operate more like vocational vehicles than line haul tractors. Heavy-haul, off-road, and certain intra-city delivery tractors are eligible for this category in the Phase 1 program, but manufacturers may also choose to certify them as conventional tractors. The agencies proposed to keep this program in Phase 2, but to exclude heavy-haul tractors. With the removal of heavy-haul tractors from the vocational tractor definition (see 40 CFR 1037.630 and 49 CFR 523.2), the agencies have re-assessed the vehicles remaining in this group, and the most appropriate way for them to be certified. One typically thinks of beverage tractors in this group, though it may also include drayage tractors, vehicle carriers, construction vehicles, and many vehicles with unusual axle configurations. NREL observed drayage tractors with operational patterns consistent with the Regional duty cycle.<sup>393</sup> Volvo also commented that their vocational tractors would logically fall in the Regional duty cycle. The agencies have therefore concluded that these vehicles may reasonably be represented by our final regulatory duty cycles, and are requiring that vocational tractors not meeting other exemption criteria must use one of the vocational vehicle duty cycles.

There is a separate question of whether vocational tractors may have their performance fairly measured against the agencies' defined baseline vocational configurations. The agencies requested comment on whether vocational tractors would be deficit-generating vehicles if certified in the proposed vocational vehicle subcategories. When a vehicle is designed with a higher power engine or higher number of axles to carry a heavier payload than presumed in the GEM baseline for that subcategory, GEM may return a value that poorly represents the real world performance of that vehicle. We received comments from the chassis manufacturers who

certify vocational tractors, plus two other comments. These comments consistently asked the agencies to allow some tractors with GVWR over 120,000 lbs but not qualifying as heavy-haul tractors to remain as vocational vehicles rather than be forced to certify to the primary tractor standards. Volvo submitted written comments stating that a separate regulatory subcategory with unique performance standard is warranted for vocational tractors. However, during a subsequent telephone conversation, Volvo stated that their vocational tractors would be adequately represented by the other defined subcategories, and a unique subcategory was not necessary.<sup>394</sup> See Section III.C.(4) for a discussion of the attributes adopted by the agencies as distinguishing vocational tractors from regular or heavy-haul tractors.

Based on comments and our technical analysis, the agencies have concluded that the technologies determined to be feasible for regular vocational vehicles are also feasible for vocational tractors, with similar adoption rates and package costs. Further, we are not aware of any non-diversified chassis manufacturers producing vocational tractors. One implication is that we believe that all manufacturers certifying vocational tractors will be able to take advantage of our ABT program flexibilities. According to MY 2014 certification data, less than 14,000 vocational tractors were certified between the three manufacturers, including an unidentifiable number that would likely qualify as heavy-haul tractors, if that definition existed in Phase 1. Thus, possible deficits (if any) generated by the small sales volume of vocational tractors in Phase 2 could likely be accommodated within each company's overall compliance plan.

(2) GHG and Fuel Consumption Standards for Vocational Vehicles

EPA is adopting CO<sub>2</sub> standards and NHTSA is adopting fuel consumption standards for manufacturers of chassis for new vocational vehicles. As described in Sections II.C.(1) and II.D.(1) above, the agencies are adopting test procedures so that engine performance will be evaluated within the GEM simulation tool. These test procedures include corrections for the test fuel, enabling vocational vehicles to be certified with many different types of CI and SI engines. In addition, EPA is establishing HFC leakage standards for air conditioning systems in vocational vehicles, as described in Section

V.B.(2)(c), with more details available in the RIA Chapter 2.9.3.8 and Chapter 5.3.4.

This section describes the standards and implementation dates that the agencies are adopting for the 15 regulatory subcategories of vocational vehicles, plus the optional standards for the seven custom vocational chassis categories. The agencies have performed a technology analysis to determine the level of standards that we believe will be available at reasonable cost, cost-effective, technologically feasible, and appropriate in the lead time provided. More details of this analysis are described in the RIA Chapter 2.9. This analysis considered the following for each of the regulatory subcategories:

- The level of technology that is incorporated in current new vehicles,
- forecasts of manufacturers' product redesign schedules,
- the available data on CO<sub>2</sub> emissions and fuel consumption for these vehicles,
- technologies that will reduce CO<sub>2</sub> emissions and fuel consumption and that are judged to be feasible and appropriate for these vehicles through the 2027 model year,
- the effectiveness and cost of these technologies,
- a projection of the technologically feasible application rates of these technologies, in this time frame, and
- projections of future U.S. sales for different types of vehicles and engines.

The final Phase 2 program described here and throughout the rulemaking documents is derived from the preferred alternative, referred to as Alternative 3 in the NPRM.

(a) Primary Fuel Consumption and CO<sub>2</sub> Standards

The agencies' final standards will phase in over a period of seven years, beginning in the 2021 model year, consistent with the requirement in EISA that NHTSA's standards provide four full model years of regulatory lead time and three full model years of regulatory stability, and provide sufficient time "to permit the development and application of the requisite technology" for purposes of CAA section 202(a)(2). The Phase 2 program will progress in three-year stages with an intermediate set of standards in MY 2024 and will continue to reduce fuel consumption and CO<sub>2</sub> emissions well beyond the full implementation year of MY 2027. The agencies have identified a technology path for each of these levels of improvement, as described below.

Combining engine and vehicle technologies, vocational vehicles powered by CI engines are projected to achieve improvements as much as 24

<sup>393</sup> Comparing the vocational Regional duty cycle to the day cab tractor duty cycle, vocational Regionals have one percent greater weighting of the ARB Transient, 6 percent more weighting of the 55 cycle, 8 percent less weighting of the 65 cycle, plus 25 percent parked idle.

<sup>394</sup> See call log for L. Steele, conversation with M. Miller, dated January 18, 2016.

percent in MY 2027 over the MY 2017 baseline, as described below and in the RIA Chapter 2.9. The agencies project up to 18 percent improvement in fuel consumption and CO<sub>2</sub> emissions in MY 2027 from SI-powered vocational vehicles, as shown in Table V-3. The

incremental Phase 2 vocational vehicle standards will ensure steady progress toward the MY 2027 standards, with improvements for CI-powered vehicles in MY 2021 of up to 12 percent and improvements for CI-powered vehicles in MY 2024 of up to 20 percent over the

MY 2017 baseline vehicles, as shown in Table V-3.

The agencies' analyses, as discussed in this Preamble and in the RIA Chapter 2, show that these standards are appropriate under each agency's respective statutory authority.

TABLE V-3—PROJECTED VOCATIONAL VEHICLE CO<sub>2</sub> AND FUEL USE REDUCTIONS (IN PERCENT) FROM 2017 BASELINE

Model year	Engine type	Heavy heavy-duty Class 8	Medium heavy-duty Class 6-7	Light heavy-duty Class 2b-5
2021	CI Engine	7-9	6-11	7-12
	SI Engine		5-7	6-8
2024	CI Engine	12-16	11-18	11-20
	SI Engine		9-12	9-14
2027	CI Engine	14-20	12-22	13-24
	SI Engine		10-16	11-18

Based on our analysis and research, and our consideration of the public comments, the agencies conclude that the improvements in vocational vehicle fuel consumption and CO<sub>2</sub> emissions can be achieved through deployment and utilization of a greater set of technologies than formed the technology basis for the Phase 1 standards. Further, since proposal, our assessment of technology effectiveness has changed primarily due to revisions in duty cycles and in some cases, the technologies themselves. The agencies received comments addressing the vocational vehicle standards broadly, including baselines, structure, and technologies. In response, in developing the final standards, the agencies have reevaluated the current levels of fuel consumption and emissions, the kinds of technologies that could be utilized by manufacturers to reduce fuel consumption and emissions, the associated lead time, the associated costs for the industry, fuel savings for the owner/operator, and the magnitude of the CO<sub>2</sub> reductions and fuel savings that may be achieved. After reexamining the possibilities of vehicle improvements, the agencies are basing the final standards on the performance of workday idle reduction technologies, improved transmissions including mild hybrid powertrains, axle technologies, weight reduction, electrified accessories, tire pressure systems, and further tire rolling resistance improvements. The EPA-only air conditioning standard is based on leakage improvements. These are largely the same technologies as we considered for the proposal, although some technologies that had been available only to tractors at proposal are now recognized for vocational vehicles. Our updated analysis shows that more

stringent standards than proposed are feasible, based in large part on our new assessment of the effectiveness of workday idle controls.

The agencies' evaluation indicates that some of the above vehicle technologies are commercially available today, though often in limited volumes. Other technologies will need additional time for development. Those that we believe are available today and may be adopted to a limited extent in some vehicles include improved tire rolling resistance, weight reduction, some types of conventional transmission improvements, neutral idle, and air conditioning leakage improvements. However, the first model year for the final Phase 2 standards will not be until MY 2021.<sup>395</sup> As at proposal, the EPA continues to believe that any potential benefits that could be achieved by implementing rules requiring some technologies on vocational vehicles earlier than MY 2021 to be outweighed by several disadvantages. For one, manufacturers will need lead time to develop compliance tracking tools. Also, if the Phase 2 vocational vehicle standards began in a different year than the tractor standards, this could create unnecessary added complexity, and could strongly detract from the fuel savings and GHG emission reductions that could otherwise be achieved. Therefore the Phase 1 standards will continue to apply in model years 2018 to 2020. No commenter suggested otherwise.

Vehicle technologies that we expect will be available in the near term include neutral idle, low rolling resistance tires, improved axle

efficiency, and part-time 6x2 axles. Vehicle technologies that we have determined will benefit from even more development time to integrate engine and vehicle systems include stop-start idle reduction and hybrid powertrains. The agencies have analyzed the technological feasibility of achieving the fuel consumption and CO<sub>2</sub> standards, based on projections of what actions manufacturers may be expected to take to reduce fuel consumption and emissions to achieve the standards, and believe that the standards are technologically feasible throughout the regulatory useful life of the program. The basis for this finding is discussed below in Section V.C.3. EPA and NHTSA estimated vehicle package costs are found in Section V.C.(2).

Table V-4 and Table V-5 present EPA's CO<sub>2</sub> standards and NHTSA's fuel consumption standards, respectively, for chassis manufacturers of Class 2b through Class 8 vocational vehicles for the beginning model year of the program, MY 2021. As in Phase 1, the standards are in the form of the mass of emissions, or gallons of fuel, associated with carrying a ton of cargo over a fixed distance. The EPA standards are measured in units of grams CO<sub>2</sub> per ton-mile and the NHTSA standards are in gallons of fuel per 1,000 ton-miles. With the mass of freight in the denominator of this term, the program is designed to measure improved efficiency in terms of freight efficiency. As in Phase 1, the Phase 2 program assigns a fixed default payload in GEM for each vehicle weight class group (heavy heavy-duty, medium heavy-duty, and light heavy-duty). Even though this simplification does not allow individual vehicle freight efficiencies to be recognized, the general capacity for larger vehicles to carry more payload is represented in the

<sup>395</sup> NHTSA is unable to adopt mandatory amended standards in those model years since there will be less than the statutorily-prescribed amount of lead time available. 49 U.S.C. 32902(k)(3)(A).

numerical values of these standards for each weight class group.

For each model year of the standards described below, the standards for vehicles powered by CI engines reflect improvements that correspond with performance of technologies projected to meet the separate CI engine standard in that year, as modeled over the GEM vehicle cycles. In other words, the CI vehicle standard directly reflects, and keeps pace with, the increasing stringency of the CI engine standard. As described above in Section II.D, the SI engine standard is remaining unchanged from Phase 1. However, the standards in each model year for vocational vehicles powered by SI engines are based in part on the performance of some additional engine technologies beyond what is required to meet the SI engine standards. In other words, certain SI engine improvements are reflected in the stringency of the SI vehicle standard.

EPA’s vocational vehicle CO<sub>2</sub> standards and NHTSA’s fuel

consumption standards for the MY 2024 stage of the program are presented in Table V-6 and Table V-7, respectively. These reflect broader adoption rates of vehicle technologies already considered in the technology basis for the MY 2021 standards. EPA’s vocational vehicle CO<sub>2</sub> standards and NHTSA’s fuel consumption standards for the full implementation year of MY 2027 are presented in Table V-8 and Table V-9, respectively. These reflect even greater adoption rates of the same vehicle technologies considered as the basis for the previous stages of the Phase 2 standards.

These standards are based on highway cruise cycles that include a final road grade profile that has been refined as a result of comment. This enables the standard and the GEM certification results to better reflect real world driving and to help recognize engine and driveline technologies while seeking to assure that technologies result in real world benefit. See the RIA Chapter 3.4.2.1.

As described in Section I, the agencies are continuing the Phase 1 approach to averaging, banking and trading (ABT), allowing ABT within vehicle weight classes. For Phase 2, continuing this approach means allowing averaging between CI-powered vehicles and SI-powered vehicles of any subcategory belonging to the same weight class group, which have the same regulatory useful life. However these averaging sets exclude vehicles certified to the separate custom chassis standards. Although we are further subdividing each vocational weight class group into Urban, Multi-Purpose, and Regional subcategories, we are not restricting credit exchanges between them. This is similar to the allowance to trade between vocational vehicles and tractors within a weight class. It is also consistent with the Phase 1 program, where the different types of vehicles within a weight class were included in a single averaging set.

TABLE V-4—EPA CO<sub>2</sub> STANDARDS FOR MY 2021 CLASS 2b-8 VOCATIONAL VEHICLES

Duty cycle	Light heavy-duty Class 2b-5	Medium heavy-duty Class 6-7	Heavy heavy-duty Class 8
<b>EPA Standard for Vehicle with CI Engine Effective MY 2021 (gram CO<sub>2</sub>/ton-mile)</b>			
Urban .....	424	296	308
Multi-Purpose .....	373	265	261
Regional .....	311	234	205
<b>EPA Standard for Vehicle with SI Engine Effective MY 2021 (gram CO<sub>2</sub>/ton-mile)</b>			
Duty cycle	Light heavy-duty Class 2b-5	Medium heavy-duty Class 6-7 (and C8 gasoline)	
Urban .....	461	328	
Multi-Purpose .....	407	293	
Regional .....	335	261	

TABLE V-5—NHTSA FUEL CONSUMPTION STANDARDS FOR MY 2021 CLASS 2b-8 VOCATIONAL VEHICLES

Duty cycle	Light heavy-duty Class 2b-5	Medium heavy-duty Class 6-7	Heavy heavy-duty Class 8
<b>NHTSA Standard for Vehicle with CI Engine Effective MY 2021 (Fuel Consumption gallon per 1,000 ton-mile)</b>			
Urban .....	41.6503	29.0766	30.2554
Multi-Purpose .....	36.6405	26.0314	25.6385
Regional .....	30.5501	22.9862	20.1375
<b>NHTSA Standard for Vehicle with SI Engine Effective MY 2021 (Fuel Consumption gallon per 1,000 ton-mile)</b>			
Duty cycle	Light heavy-duty Class 2b-5	Medium heavy-duty Class 6-7 (and C8 gasoline)	
Urban .....	51.8735	36.9078	
Multi-Purpose .....	45.7972	32.9695	

TABLE V-5—NHTSA FUEL CONSUMPTION STANDARDS FOR MY 2021 CLASS 2b-8 VOCATIONAL VEHICLES—Continued

Duty cycle	Light heavy-duty Class 2b-5	Medium heavy-duty Class 6-7	Heavy heavy-duty Class 8
Duty cycle	Light heavy-duty Class 2b-5	Medium heavy-duty Class 6-7 (and C8 gasoline)	
Regional .....	37.6955	29.3687	

TABLE V-6—EPA CO<sub>2</sub> STANDARDS FOR MY 2024 CLASS 2b-8 VOCATIONAL VEHICLES

Duty cycle	Light heavy-duty Class 2b-5	Medium heavy-duty Class 6-7	Heavy heavy-duty Class 8
<b>EPA Standard for Vehicle with CI Engine Effective MY 2024 (gram CO<sub>2</sub>/ton-mile)</b>			
Urban .....	385	271	283
Multi-Purpose .....	344	246	242
Regional .....	296	221	194

**EPA Standard for Vehicle with SI Engine Effective MY 2024 (gram CO<sub>2</sub>/ton-mile)**

Duty cycle	Light heavy-duty Class 2b-5	Medium heavy-duty Class 6-7 (and C8 gasoline)	
Urban .....	432	310	
Multi-Purpose .....	385	279	
Regional .....	324	251	

TABLE V-7—NHTSA FUEL CONSUMPTION STANDARDS FOR MY 2024 CLASS 2b-8 VOCATIONAL VEHICLES

Duty cycle	Light heavy-duty Class 2b-5	Medium heavy-duty Class 6-7	Heavy heavy-duty Class 8
<b>NHTSA Standard for Vehicle with CI Engine Effective MY 2024 (Fuel Consumption gallon per 1,000 ton-mile)</b>			
Urban .....	37.8193	26.6208	27.7996
Multi-Purpose .....	33.7917	24.1650	23.7721
Regional .....	29.0766	21.7092	19.0570

**NHTSA Standard for Vehicle with SI Engine Effective MY 2024 (Fuel Consumption gallon per 1,000 ton-mile)**

Duty cycle	Light heavy-duty Class 2b-5	Medium heavy-duty Class 6-7 (and C8 gasoline)	
Urban .....	48.6103	34.8824	
Multi-Purpose .....	43.3217	31.3942	
Regional .....	36.4577	28.2435	

TABLE V-8—EPA CO<sub>2</sub> STANDARDS FOR MY 2027 CLASS 2b-8 VOCATIONAL VEHICLES

Duty cycle	Light heavy-duty Class 2b-5	Medium heavy-duty Class 6-7	Heavy heavy-duty Class 8
<b>EPA Standard for Vehicle with CI Engine Effective MY 2027 (gram CO<sub>2</sub>/ton-mile)</b>			
Urban .....	367	258	269
Multi-Purpose .....	330	235	230
Regional .....	291	218	189

TABLE V-8—EPA CO<sub>2</sub> STANDARDS FOR MY 2027 CLASS 2b-8 VOCATIONAL VEHICLES—Continued

Duty cycle	Light heavy-duty Class 2b-5	Medium heavy-duty Class 6-7	Heavy heavy-duty Class 8
<b>EPA Standard for Vehicle with SI Engine Effective MY 2027 (gram CO<sub>2</sub>/ton-mile)</b>			
Duty cycle	Light heavy-duty Class 2b-5	Medium heavy-duty Class 6-7 (and C8 gasoline)	
Urban .....	413	297	
Multi-Purpose .....	372	268	
Regional .....	319	247	

TABLE V-9—NHTSA FUEL CONSUMPTION STANDARDS FOR MY 2027 CLASS 2b-8 VOCATIONAL VEHICLES

Duty cycle	Light heavy-duty Class 2b-5	Medium heavy-duty Class 6-7	Heavy heavy-duty Class 8
<b>NHTSA Standard for Vehicle with CI Engine Effective MY 2027 (Fuel Consumption gallon per 1,000 ton-mile)</b>			
Urban .....	36.0511	25.3438	26.4244
Multi-Purpose .....	32.4165	23.0845	22.5933
Regional .....	28.5855	21.4145	18.5658
<b>NHTSA Standard for Vehicle with SI Engine Effective MY 2027 (Fuel Consumption gallon per 1,000 ton-mile)</b>			
Duty cycle	Light heavy-duty Class 2b-5	Medium heavy-duty Class 6-7 (and C8 gasoline)	
Urban .....	46.4724	33.4196	
Multi-Purpose .....	41.8589	30.1564	
Regional .....	35.8951	27.7934	

As with the other regulatory categories of heavy-duty vehicles, NHTSA and EPA are adopting standards that apply to Class 2b-8 vocational vehicles at the time of production, and EPA is adopting standards for a specified period of time in use (e.g., throughout the regulatory useful life of the vehicle). The derivation of the standards for these vehicles, as well as details about the provisions for certification and implementation of these standards, are discussed in more detail in Sections V.C. and V.D and in the RIA Chapter 2.9.

(b) Custom Chassis Fuel Consumption and CO<sub>2</sub> Standards

The agencies proposed a simplified compliance procedure and less stringent standards for emergency vehicles, while requesting comment on extending these flexibilities to other custom chassis such as recreational vehicles and buses. 80 FR 40292-40293. As described below, the agencies are finalizing a broader allowance that will also apply for vehicles other than emergency vehicles.

In response to the proposed provisions for emergency vehicles, we

received comments in support of adopting separate, less stringent standards for emergency vehicles through a simplified GEM process. Based on the reasoning set forth at proposal, and supported in the public comments, these final rules include optional emergency vehicle standards based on the same technologies as described in the proposal, and using a simplified version of GEM available through the custom chassis program. The use of a default engine in GEM avoids penalizing emergency vehicle manufacturers from installing engines that are likely to be credit-using engines against the separate engine standard, and avoids forcing emergency vehicles to be measured against an unrepresentative baseline over an unrepresentative drive cycle.

(i) Justification for an Expanded Custom Chassis Program

In the proposal, we requested comment on other manufacturers who could benefit from a similar regulatory approach, such as those offering such a narrow range of products that averaging is not of practical value as a compliance

flexibility, and for whom there are not large sales volumes over which to distribute technology development costs, as well as having drive cycles and functions that may make the primary standards either unrepresentative or unsuitable. Although this issue has some implications for our consideration of small business concerns, the custom chassis provisions discussed in the proposal were not intended to be limited to small businesses, and the final custom chassis standards are generally applicable (albeit optional). It is important to consider that for some vocational applications the custom-chassis manufacturers can have substantial market share. For example, Blue Bird is a manufacturer of school buses and school bus chassis with a substantial market share of its narrow product line.

We received comments in support of separate standards based on a different technology mix than the primary program for seven vocational vehicle applications. Gillig, New Flyer and Allison commented in support of separate standards for transit buses. RVIA, Newell Coach, Allison and Tiffin

Motor Homes commented in support of separate standards for motor homes. OshKosh commented in support of separate standards for cement mixers. Autocar and Volvo commented in support of separate standards for refuse trucks. Volvo and ABC Bus Companies commented in support of separate standards for motor coaches. Daimler and the School Bus Manufacturers Technical Council commented in support of separate standards for school buses.

The agencies received favorable comment on using a simplified compliance procedure for custom chassis from most commenters, but some expressed concerns. Autocar claimed that the simplified GEM interface would not sufficiently reduce the administrative compliance burden of small businesses, and recommended an engine-only certification method.

Custom chassis manufacturers that are not small businesses must comply with the Phase 1 standards and are generally doing so, by installing a mix of tires that, on average, meet the target coefficient of rolling resistance. Large manufacturers were not enthusiastic about offering a different approach for some vehicles, and urged that custom chassis standards, if adopted, be generally available as a compliance option. Based on public comment and extensive stakeholder outreach, the agencies have identified over a dozen chassis manufacturers serving the U.S. vocational market who produce a narrow spectrum of vehicles for which many technologies underlying the primary standards will either be less effective than projected, or are infeasible. Innovus commented that regulatory flexibility should only be offered to small volume producers who are also small entities. However, we do not believe it is warranted to force any of these specialized manufacturers to certify their narrow product line of vehicles to the primary standards, where stringency is premised on performance of some technologies unsuited for their specialized type of vehicle. Thus, the agencies have developed optional standards tailored for these vehicle types, and are not limiting eligibility to small entities.

Any manufacturer may certify their vehicles that we have identified as custom chassis vehicles under the primary standards. We expect that diversified chassis manufacturers selling a small number of their products into these defined custom applications could likely meet the primary Phase 2 standards on average, using internal credits. However, because the baseline configurations and duty cycles for these

custom applications would be less representative and some technologies would either be less effective or infeasible for them, these custom applications would likely be credit-using vehicles in the averaging set. Even so, we believe the primary Phase 2 standards are both feasible and appropriate for diversified manufacturers, as their broad mix of products allows them to average across their fleets, and some vehicles are likely to over-comply because their in-use applications are more compatible with the full range of available technologies. This is a feature of setting performance-based average standards with less than 100 percent adoption rates of technologies. Because we agree with commenters, including OshKosh who noted this is an expected market practice, we believe it is essential to not only set feasible targets for chassis manufacturers offering a narrow range of products and for whom fleet averaging will provide a smaller degree of compliance flexibility, but to also make this option available to diversified manufacturers. To address stakeholder concerns about large, diversified manufacturers having greater ability to produce credit-using vehicles than smaller, less diversified manufacturers, we are adopting additional flexibilities for manufacturers certifying to the custom chassis standards, including some flexibilities that will be available only for small businesses.

We do not view these standards as achieving less improvement than the primary program for these vehicles, and thus, we are not adopting any sales limits. Nevertheless, we requested comments on an appropriate sales volume that might be considered as a criterion to qualify for the numerically less stringent standards, where vehicle quantities above such sales threshold would need to be certified to the primary standards. We received comments from Allison, Autocar, Innovus, the School Bus Manufacturers Technical Council, and RVIA suggesting appropriate low-volume thresholds ranging from 200 to 26,000 vehicles per year. We received adverse comment from Daimler stating it would be unfair to make less stringent standards available solely on the basis of sales volume, because if a technology exists for one manufacturer, it is available to all manufacturers. We received adverse comment from OshKosh that less stringent regulations on a limited production volume stifles a custom chassis manufacturers' opportunity to grow their business. For each of the applications listed below in Table V-10,

the agencies have identified at least one manufacturer who produces chassis regulated under the Phase 2 program that are generally finished as a single vehicle type, as well as at least one competitor who is more diversified. After considering these comments, we continue to believe that no sales limits are needed.

After considering the comments on possible separate standards for custom chassis, the agencies have evaluated the feasibility of technologies for these vehicles on an application-specific basis. We shared draft custom chassis technology packages with affected stakeholders and received feedback.<sup>396</sup> See Section V.C.1.a below discussing the feasibility of each technology as it applies for custom chassis vehicles. Section V.C.(2)(b) discusses the technology adoption rates from which the stringency of the optional custom chassis standards are derived.

Navistar commented with concerns that separate standards for custom chassis could create an unlevel playing field for manufacturers. ACEEE commented that the agencies should strengthen the primary vocational vehicle standard by one percent to offset the weaker standards for the custom chassis. ACEEE also commented that if chassis manufacturers can identify the vehicle application with enough specificity to take advantage of the custom chassis program, then they should also be able to take advantage of the most appropriate fuel-saving technologies, resulting in target stringencies that are not weaker than the main program. Although we agree that the custom chassis program should not result in a weakening of the overall vocational program, we disagree with ACEEE's recommendation to arbitrarily add back stringency. The agencies did not remove custom chassis in the final stage of a feasibility analysis of the primary program; rather, we separately considered the custom chassis vehicles as an integral part of developing the feasibility analysis in support of the final standards. The optional final standards are technology-advancing, appropriate, and maximum feasible for these applications. No arbitrary offset is needed or justified.

We disagree with claims made by commenters expressing concerns with respect to a shortfall or gap in emissions reductions between the primary vocational vehicle program and the custom chassis program. Some commenters have attempted to quantify

<sup>396</sup> See record of Webinar on Vocational Custom Chassis, March 2016, Docket ID EPA-HQ-OAR-2014-0827-1944.

a difference in stringency by comparing select technology packages for custom chassis described in a February 2016 memorandum with the proposed technology packages for comparable subcategories.<sup>397</sup> Because most of the baseline configurations for the custom chassis are tailored for each vocational vehicle, the only vehicle types where this comparison is straightforward is school buses and motor homes. In comparing the MY 2027 stringency of the medium heavy-duty Urban subcategory with the optional MY 2027 standard for school buses, for example, it can be seen that diesel vehicles in the primary program are projected to achieve 22 percent improvement on average, while school buses are expected to achieve 18 percent improvement on average. This is nowhere near the gap posited by certain commenters. Moreover, the difference in stringency reflects the reasonable conclusion that certain transmission technologies are not feasible for school buses.

This comparison is not straightforward for motor coaches and other custom chassis types, however, because the baselines are different and the vehicle attributes are not similar.

For example, our baseline configuration for coach buses includes a 350 hp 11-liter engine with a 6-speed automatic transmission. However, the primary program includes a baseline for heavy heavy-duty Regional vehicles that is a weighted average of 95 percent with 455 hp 15-liter engine with 10-speed manual transmission and 5 percent with a 350 hp 11-liter engine with a 6-speed automatic transmission. Due to the difference in performance of these configurations in GEM, a non-diversified coach bus manufacturer may find its fleet significantly “in the hole” in the first year of this program due solely to baseline differences. As an example of a technology difference, we have determined that regular HHD Regional chassis may reasonably apply AES on average at a rate of 90 percent by MY 2027, whereas we find that AES is not feasible at all for a conventional coach bus. A diversified manufacturer choosing to certify a coach bus in the HHD-R subcategory to the primary standards is likely to need to apply other technologies or use credits from other types of vehicles to meet the standard on average. A non-diversified coach bus manufacturer would be unlikely to achieve the HHD-R primary

program standard unless some very advanced technology is applied (at costs necessarily very different from those analyzed to be reasonable here). Therefore, we do not believe it is accurate to draw a comparison, as certain commenters maintained, between the HHD-R primary program stringency of 14 percent and the coach bus MY 2027 stringency of 11 percent.

Nonetheless, because these optional custom chassis standards are numerically less stringent than the primary Phase 2 vocational vehicle standards, the agencies are adopting a more restrictive approach to averaging, banking and trading (ABT), allowing averaging only within each subcategory for vehicles certified to these optional standards. Trading and banking will not be permitted except that small businesses certifying vehicles to these optional standards may use traded credits to comply. We are adopting these provisions to prevent generation of windfall credits against the less numerically stringent custom chassis standard. If a manufacturer wishes to generate tradeable credits from production of these vehicles, one or more families may be certified to the primary vocational vehicle standards.

TABLE V-10—CUSTOM CHASSIS POPULATION ESTIMATES

Application type	Percent of new MY 2018 vocational population	Average VMT in first year <sup>a</sup>
Coach (Intercity) Bus .....	1	85,000
Motor Home .....	13	2,000
School Bus .....	10	14,000
Transit Bus .....	1	64,000
Refuse Truck .....	3	34,000
Cement Mixer <sup>b</sup> .....	1	16,000
Emergency Vehicle <sup>c</sup> .....	1	6,000

**Notes:**

<sup>a</sup> Source: MOVES 2014 for all except mixer and emergency.<sup>398</sup>

<sup>b</sup> Source for cement mixer is UCS.<sup>399</sup>

<sup>c</sup> Source for emergency is ICCT (2009)<sup>400</sup> and FAMA (2004).<sup>401</sup>

As shown in Table V-10, some of these vehicle types are produced in moderate volumes, and some are driven moderate distances annually. However, those that are produced in slightly higher volumes (motor homes and school buses) are among those driven the fewest miles. Similarly, those driven the most miles (coach and transit buses)

are among those produced in the smallest volumes. Collectively, the agencies estimate that the vehicles defined as custom vocational chassis in Phase 2 comprise less than 30 percent of the projected new vocational vehicle sales in MY 2018. Even so, because of the collectively small number of miles driven, the agencies believe that setting

less numerically stringent GHG and fuel consumptions standards for these vehicles will not detract from the greater benefits of this rulemaking, and that such separate standards are warranted in any case.

As proposed and discussed in the RIA Chapter 12, the agencies are adopting a provision for chassis manufacturers qualifying as small businesses to have

<sup>397</sup> See memorandum dated February 2016 on Vocational Vehicle Technology Packages for Custom Chassis, Docket ID EPA-HQ-OAR-2014-0827-1719.

<sup>398</sup> Vehicle populations are estimated using MOVES2014. More information on projecting populations in MOVES is available in the following report: USEPA (2015). “Population and Activity of

On-road Vehicles in MOVES2014—Draft Report” Docket No. EPA-HQ-OAR-2014-0827.

<sup>399</sup> National Ready Mixed Association Fleet Benchmarking and Costs Survey, <http://www.nxtbook.com/naylor/NRCQ/NRCQ0315/index.php#/22>, from UCS Custom Chassis Recommendations, May 2016.

<sup>400</sup> ICCT, May 2009, “Heavy-Duty Vehicle Market Analysis: Vehicle Characteristics & Fuel Use, Manufacturer Market Shares.”

<sup>401</sup> Fire Apparatus Manufacturer’s Association, Fire Apparatus Duty Cycle White Paper, August 2004, available at <http://www.deepriverct.us/firehouselstudy/reports/Apparatus-Duty-Cycle.pdf>.

one extra year of lead time to comply with the initial Phase 2 standards.<sup>402</sup> Daimler stated it only supported additional lead time if it was provided equally to all custom chassis manufacturers. Because the SBA threshold in this sector is generally 1,500 employees, we believe that small entities have fewer in-house resources to collect and analyze compliance data than do manufacturers with more employees. Due to these resource constraints, the agencies believe it is appropriate to offer this only to small businesses—the entities that need further lead time. However, many custom chassis manufacturers do not qualify as small entities under the SBA regulations. We received comment from OshKosh that additional time to meet an impossible stringency target is not helpful, a comment addressed by adopting the separate custom chassis standards. The final program offers both a feasible standard, as described below, and additional lead time for small businesses.

Vehicles certifying to the optional custom chassis standards will be simulated in GEM using a default EPA engine map as well as many other EPA default parameters that are required inputs for vehicles in the primary program. While this is very similar to the Phase 1 GEM, more inputs are available in the Phase 2 custom chassis program than in Phase 1. Section V.D.(1) below describes the regulatory subcategory identifiers that must be input to GEM to call default vehicle specifications as part of obtaining valid simulation results for custom chassis in GEM.

The optional custom chassis standards will phase in over the same period as the primary vocational vehicle standards, beginning in the 2021 model year. However, there are no intermediate standards in MY 2024, so the optional MY 2021 custom chassis standards will continue until the full implementation year of MY 2027. The agencies have identified a technology path for each of these levels of improvement, as described below.

Combining engine and vehicle technologies, custom chassis are projected to achieve improvements from 6 to 18 percent in MY 2027 over the MY 2017 baseline, as summarized in Table V–11. The incremental standard in MY 2021 will achieve improvements of up to 10 percent over the MY 2017 baseline vehicles when including improvements

from MY 2021 diesel engines, as shown in Table V–11.

The agencies’ analyses, summarized immediately below and discussed in detail in the RIA Chapter 2.9, show that these optional standards are justified under each agency’s respective statutory authority. We note that for each model year of the Phase 2 custom chassis standards, the numerical value of the vehicle-level standard represents the performance of a diesel engine meeting that year’s separate CI engine standard. Put another way, although the agencies are adopting distinct standards for custom chassis vocational vehicles, those vehicles must still use engines certified to the applicable Phase 2 engine standard. As in Phase 1, the chassis manufacturer is free to install any certified engine, and because GEM will run using a default map, the choice of engine will not affect the GEM result.

TABLE V–11—CUSTOM CHASSIS CO<sub>2</sub> AND FUEL USE REDUCTIONS (IN PERCENT) FROM 2017 BASELINE

Vehicle type	Model year	
	2021	2027
Coach Bus .....	7	11
Motor Home .....	6	9
School Bus .....	10	18
Transit .....	7	14
Refuse .....	4	12
Mixer .....	3	7
Emergency .....	1	6

It is worth noting that because the custom chassis version of GEM will not recognize certain technology improvements that some of these manufacturers will include based on market forces (after they have been introduced into the market as a result of the primary program), we expect actual in-use improvements for some of these vehicles to be slightly greater than is required by the standards. For example, we project that transmission manufacturers will improve the overall efficiency of their transmissions to enable vehicle manufacturers to comply with the primary standards. Once these transmissions have been developed and made available, we would not expect custom chassis manufacturers (or customers) to resist using them simply because they would not impact compliance with the standards.

(ii) GEM-Based Custom Chassis Standards

Table V–12 and Table V–13 present EPA’s CO<sub>2</sub> standards and NHTSA’s fuel consumption standards, respectively, for custom vocational chassis. The agencies have analyzed the

technological feasibility of achieving the fuel consumption and CO<sub>2</sub> standards, based on projections of actions manufacturers may take to reduce fuel consumption and emissions to achieve the standards, and believe that the standards are technologically feasible throughout the regulatory useful life of the program. EPA and NHTSA describe costs of the custom chassis standards in Section V.C.(2). In all cases we expect the technology package costs to be less than those of the primary Phase 2 standards, reflecting that the full set of technologies on which the stringency of the primary standards are based is not suitable for custom chassis applications. The costs of these standards are reasonable in the context of the reductions achieved, should be offset by fuel savings over the life of the vehicles.

These custom vehicle-level standards are predicated on a simpler set of vehicle technologies than the primary Phase 2 standard for vocational vehicles. (As already noted, these custom chassis vehicles will be required to use engines meeting the Phase 2 engine standards, and thus, should generally incorporate the same *engine improvements* as other vocational vehicles). In developing these optional standards, the agencies have evaluated the current levels of fuel consumption and emissions, the kinds of technologies that could be utilized by custom chassis manufacturers to reduce fuel consumption and emissions, the associated lead time, the associated costs for the industry, fuel savings for the owner/operator, and the magnitude of the CO<sub>2</sub> reductions and fuel savings that may be achieved. After examining the possibilities of vehicle improvements, the agencies are basing the optional vehicle-level standards for motor homes on adoption of TPMS and low rolling resistance tires. We are basing the optional standards for transit buses and refuse trucks on the performance of workday idle reduction technologies, tire pressure systems, simplified transmission improvements, and further tire rolling resistance improvements. The agencies are basing the standards for coach buses and school buses on all of the above technologies as well as simplified transmission improvements. The agencies are basing the standards for concrete mixers and emergency vehicles on use of tires with current average levels of rolling resistance. The EPA-only air conditioning standard is based on leakage improvements. Of these technologies, we believe that improved tire rolling resistance, neutral idle, and air conditioning leakage improvements

<sup>402</sup> See SBA regulations at 13 CFR 121.201. Thresholds effective February 2016 are available at <http://www.regulations.gov/#/documentDetail;D=SBA-2014-0011-0031>, 81 FR 4469.



are available today and may be adopted as early as MY 2021. As described in the RIA 2.9.3.4 and 2.9.5, the vehicle technology that we believe will benefit from more development time for engine and vehicle integration is stop-start idle reduction.

EPA’s custom chassis CO<sub>2</sub> standards and NHTSA’s fuel consumption standards for the full implementation year of MY 2027 reflect even greater adoption rates of the same vehicle technologies considered as the basis for the MY 2021 standards, described in more detail in Section V.C below.

As with the other regulatory categories of heavy-duty vehicles, NHTSA and EPA are adopting standards that apply to custom chassis vocational vehicles at the time of production, and EPA is adopting standards for a specified period of time in use (e.g., throughout the regulatory useful life of the vehicle). The derivation of the standards for these vehicles, as well as details about the provisions for certification and implementation of these standards, are discussed in more detail later in this document and in the RIA 2.9.3 to 2.9.6.

The optional standards shown below were derived using baseline vehicle models with many attributes similar to those developed for the primary program, with adjustments that are described below in Section V.C.(2)(a). Details of these configurations are provided in the RIA Chapter 2.9.2. For better transparency with respect to the incremental difference between the MY 2021 and MY 2027 vehicle standards, we have modeled a certified MY 2027 engine for both vehicle model years of optional custom chassis standards. Thus, chassis manufacturers who do not make their own engines may compare the two model years of standards presented in Table V–12 and Table V–13 and know that any differences are due solely to vehicle-level technologies.

**TABLE V–12—EPA EMISSION STANDARDS FOR CUSTOM CHASSIS**  
[Gram CO<sub>2</sub>/ton-mile]

	MY 2021	MY 2027
Coach Bus .....	210	205
Motor Home .....	228	226
School Bus .....	291	271
Transit .....	300	286
Refuse .....	313	298
Mixer .....	319	316
Emergency .....	324	319

**TABLE V–13—NHTSA FUEL CONSUMPTION STANDARDS FOR CUSTOM CHASSIS**

[Gallon per 1,000 ton-mile]

	MY 2021	MY 2027
Coach Bus .....	20.6287	20.1375
Motor Home .....	22.3969	22.2004
School Bus .....	28.5855	26.6208
Transit .....	29.4695	28.0943
Refuse .....	30.7466	29.2731
Mixer .....	31.3360	31.0413
Emergency .....	31.8271	31.3360

The agencies are adopting definitional provisions for each of the custom chassis subcategories to ensure that only eligible chassis will be able to certify to these numerically less stringent standards. The category with the most diversity and the greatest need for regulatory clarification is refuse. We received comments from OshKosh that there are seven distinct types of refuse trucks, including roll-on-roll-off vehicles, type T container haulers (hauling trailers containing waste), as well as residential front loaders, side loaders, and rear loaders. After considering these comments and other available information, we have determined that refuse trucks that do not compact waste are ineligible to certify to the custom chassis standards. For example, roll-off trucks do not engage in neighborhood waste collection and typically transfer full containers to and from regional landfills and construction sites. Furthermore, their driving patterns are more likely to resemble our Regional cycle than the Urban cycle. These trucks do engage in some PTO operation while parked when loading or unloading waste containers using hydraulically operated beds and possibly a winch or other onboard lift system; however, they do not use the PTO while driving. The relevant definitions and certification provisions for refuse and other vehicle types are discussed below in Section V.D.

As discussed above, we are not restricting the optional custom chassis program to small businesses, nor is there a production cap. Because we are allowing diversified manufacturers to certify some vehicles to the optional custom chassis standards, but some large manufacturers may not have a system for tracking what the final build of a vehicle is, we are adopting compliance procedures to assure that the final intended build will be one of the defined vehicle types. This approach is intended to level the playing field by allowing large manufacturers to choose this option

where their tracking (and/or controls imposed on the vehicle) is sufficient to know at the time of certification what the final build will be. This avoids restricting this path to a small subset of manufacturers.

(iii) Design Standards for Select Custom Chassis

The agencies are adopting an additional set of optional standards where manufacturers of motor home, cement mixer, and emergency vehicle chassis may elect to certify one or more families of vehicles to an equivalent standard. Certification would not require use of GEM if a manufacturer selects this option. Instead, certification using this option requires installation of specific technologies on every vehicle. This option does not allow any averaging, banking, or trading. These standards are equivalent in stringency to the GEM-based option for these three types of chassis. As mentioned above, the agencies received compelling public comment from Autocar suggesting that use of even the simplified GEM was unreasonably burdensome, and that further simplification was warranted in some cases. For small businesses especially, the certification burden of collecting data and running even a simplified version of GEM can present a disproportionately high burden, especially where there are very limited GEM inputs. Thus, the agencies sought to offer an option that minimizes the certification burden, recognizing the lesser complexity of the technology package associated with the standards for these chassis.

These equivalent technology-based standards are not available for manufacturers of coach bus, school bus, transit bus, and refuse truck chassis, as the technology packages for these chassis are more complex and cannot be projected to be installed at 100 percent adoption rates.

Table V–14 lists the technologies required to be applied to every vehicle sold by a manufacturer as part of a family certified to the optional non-GEM vocational vehicle standards. In addition, the vehicle must have a certified Phase 2 engine and comply with the separate standard to prevent leakage of HFC from the mobile air conditioning system. The combined tire CRR values shown in the table are obtained using Equation V–1.

Equation V–1 Vocational Tire CRR Level Formula  
Steer tire CRR × 0.3 + Drive tire CRR × 0.7

Although manufacturers choosing this option will not have access to the

heavy-duty ABT program, this formula provides a small degree of freedom to allow for some product variability while meeting the target for every vehicle.

TABLE V-14—OPTIONAL DESIGN (NON-GEM) STANDARDS

Vehicle type	Required technology	
	MY 2021	MY 2027
Motor Home .....	Combined CRR 6.7 kg/ton or less, and either TPMS or ATIS.	Combined CRR 6.0 kg/ton or less, and either TPMS or ATIS.
Emergency .....	Combined tire CRR 8.7 kg/ton or less .....	Combined tire CRR 8.4 kg/ton or less.
Mixer .....	Combined tire CRR 7.6 kg/ton or less .....	Combined tire CRR 7.1 kg/ton or less.

(c) HFC Leakage Standards

The Phase 1 GHG standards do not include standards to control direct HFC emissions from air conditioning systems on vocational vehicles. EPA deferred such standards due to “the complexity in the build process and the potential for different entities besides the chassis manufacturer to be involved in the air conditioning system production and installation.” See 76 FR 57194. During our stakeholder outreach conducted for Phase 2, we learned that the majority of vocational vehicles are sold as cab-completes with the dashboard-mounted air conditioning systems installed by the chassis manufacturer. For those vehicles that have A/C systems installed by a second stage manufacturer, EPA is adopting revisions to our regulations that resolve the issues identified in Phase 1, in what we believe is a practical and feasible manner, as described below in Section V.D.2.

EPA received comments generally supportive of adoption of A/C refrigerant leakage standards for Class 2b–8 vocational vehicles, beginning with the 2021 model year. Chassis sold as cab-completes typically have air conditioning systems installed by the chassis manufacturer. For these configurations, the process for certifying that low leakage components are used will follow the system in place currently for comparable systems in tractors. In the case where a chassis manufacturer will rely on a second stage manufacturer to install a compliant air conditioning system, the chassis manufacturer must follow the certifying manufacturer’s installation instructions to ensure that the final vehicle assembly is in a certified configuration.

(3) Exemptions and Exclusions

This section describes exemptions and exclusions related to vocational vehicles, including some that are available only in Phase 1 and some on which we asked for comment but did not adopt in the final program.

(a) Small Business Flexibilities

Although the Phase 1 program deferred the requirements for small businesses, the Phase 2 program will require small businesses to certify their affected vehicles. The RIA Chapter 12 presents a complete discussion of the outreach process that EPA conducted to solicit input from small businesses on the Phase 2 program. The RIA Chapter 12 explains why the agencies are adopting one year of additional lead time for all small businesses in Phase 2. Thus, the first compliance year for small entities is MY 2022 rather than MY 2021. The Small Business Advocacy Review Panel included representatives who produce vocational vehicle chassis, including emergency vehicles and concrete mixers. Discussions specific to vocational vehicle chassis during that process included exploration of a low volume production threshold below which some manufacturers may avoid some obligations of this regulation. Consistent with the recommendations of the Panel, the agencies requested comments on how to design a small business vocational vehicle program, including comments on a possible small volume threshold below which some small business exemption may be available.<sup>403</sup> Innovus commented in support of a small volume threshold for vocational small businesses of either 200 vehicles per year or a different threshold set based on the market share of the entity. We received comments from Allison, Autocar, the School Bus Manufacturers Technical Council, and RVIA each suggesting different low-volume vocational chassis thresholds ranging as high as 26,000 vehicles per year. We received adverse comment from Daimler stating it would be unfair to make less stringent standards available solely on the basis of sales volume, because if a technology exists for one manufacturer, it is available to all manufacturers. We received adverse comment from OshKosh that less

<sup>403</sup> See proposed rules at 80 FR 40295, July 13, 2015.

stringent regulations on a limited production volume stifles a custom chassis manufacturers’ opportunity to grow their business. Upon consideration of these comments, the agencies are not finalizing a broad sales volume threshold below which a vocational chassis manufacturer may reduce their compliance burden. Instead we are adopting the custom chassis program, and we are revising some of the exemptions that are carrying forward from Phase 1.

Autocar requested further consideration of the small business concerns of manufacturers of specialty vehicle applications, specifically recommending a low volume threshold if the agencies are not inclined to use a manufacturer’s business size as grounds for an exemption. Examples of specialty vehicles listed by Autocar include street sweepers, asphalt blasters, aircraft deicers, sewer cleaners, and concrete pumpers. Innovus also requested additional flexibility for meeting OBD requirements. Capacity Trucks commented that the terminal tractor industry is primarily comprised of small businesses who produce a total of less than 6,000 terminal tractors per year, 70 percent of which are fully off-road vehicles. See Section V.B.(3)(c) for a discussion of how we are addressing Innovus’ comment. See the discussion in Section V.B.(3)(b) for a discussion of how we are addressing the comments on vehicles that are off-road and low-speed.

(b) Off-Road and Low-Speed Vocational Vehicle Exemptions

In considering the above comments regarding additional vehicles that have significant operation at low speeds or off-road, the agencies are revising the exemptions adopted in Phase 1 for off-road and low-speed vocational vehicles at 40 CFR 1037.631 and 49 CFR 523.2. See generally 76 FR 57175.

These provisions already apply in Phase 1 for vehicles that are defined as “motor vehicles” per 40 CFR 85.1703, but may conduct most of their operations off-road, such as drill rigs, mobile cranes and yard hostlers.

Vehicles qualifying under these provisions must be built with engines certified to meet the applicable engine standard, but need not comply with a vehicle-level GHG or fuel consumption standard. To date, according to EPA records, vehicles exempted under this provision using the axle rating criterion included airport fire apparatus, airport service, fire service, oil field service, utility repair, refuse, and truck crane. Only two vehicles were exempted using the 45 mph speed criterion, however those also had rear axles with GAWR of 29,000 lbs. No vehicles were exempted under this provision using the 33 mph criterion. Two manufacturers exempted several vehicles under this provision using the 55-mph speed-limited tire criterion, including oil field, mining, construction, rock body, and fertilizer spreader applications.<sup>404</sup> RMA commented that the agencies should not discontinue the speed-limited tire exemption criterion, as was proposed. However, their argument that it would be detrimental for a vehicle to drive above 55 mph with speed-limited tires is not compelling. It is too easy for a vehicle to be sold with speed-limited tires and subsequently have replacement tires fitted that are appropriate for higher speed operation. Although we are discontinuing the criterion for exemption based solely on use of tires with maximum speed rating at or below 55 mph, we are adding a new criterion whereby a vehicle qualifies to be exempted under this provision if it would exceed 95 percent of maximum engine test speed when traveling at 54 mph or with tamper-proof equivalent electronic controls. We are retaining the qualifying criteria related to design and use of the vehicle.

In considering the long list of specialty vehicle types raised by Capacity, Autocar and others, the agencies note that many of these may be primarily off-road vehicles in many respects, although some may not qualify as either off-road or low-speed under our regulations. In considering the drive cycle of those whose primary purpose is to transport an affixed device to an off-road work site for extended PTO operation, the agencies have concluded that the technologies we have determined to be feasible for concrete mixers are also feasible for this type of vehicle, and thus we are adopting a flexibility where vocational chassis that meet one of the two sets of criteria at 40 CFR 1037.631(a) (but not both) may be optionally certified under the custom chassis program to the standards

established for concrete mixers. These technologies include certified engines, low-leakage air conditioning components, and by MY 2027, steer tires with level 3V rolling resistance and drive tires with level 2v rolling resistance. We have similarly determined these technologies are feasible and reasonable to apply for vehicles whose primary purpose is to conduct work at slow speeds, but do not have affixed devices designed to be used at off-road work sites. This may include street sweepers and some terminal tractors.

We interpret the comments from Capacity to mean that many terminal tractors are produced in very small volumes by a large number of non-diversified small businesses. This is corroborated by comments from Autocar. Based on data from EPA's Smartway program, the drive cycles of some port drayage tractors can include a significant amount of highway time as well as idle time. According to available records, the average fraction of highway operation of 1,740 participating port dray tractors was 59 percent, and the average annual idle time was 762 hours.<sup>405</sup> In considering this drive cycle information along with vehicle attributes, the agencies have determined that workday idle reduction technologies, transmission technologies, low rolling resistance tires, and other technologies factored into the primary vocational vehicle standards are feasible for drayage tractors that are not speed-limited. Therefore, the agencies believe that a standard reflecting performance of this type of technology package has potential applicability for this subset of drayage tractors. There is a competing consideration, however. As discussed above regarding our justifications for an expanded custom chassis program, we believe it is essential to set feasible targets for those chassis manufacturers who offer a narrow range of products. This is because fleet averaging provides a smaller degree of compliance flexibility for such manufacturers. Therefore we have determined that some type of alternative standard is warranted for non-diversified manufacturers who produce non-speed-limited drayage tractors. The transit bus custom chassis subcategory has a baseline with characteristics reasonably similar to drayage tractors, and is predicated on use of some but not all of the technologies that are feasible for drayage tractors. The agencies are adopting this as an alternative standard for non-speed-limited drayage tractors,

with one caveat. We are concerned that offering an optional standard based on adoption of fewer technologies than are actually feasible for drayage tractors could result in a loss of emission reductions that are technically feasible. To address this concern, the agencies are limiting the number of non-speed-limited drayage tractors that may be certified under the alternative standard.<sup>406</sup> As stated above in Section V.B.(3)(a), Innovus commented that 200 vehicles per year would be an appropriate small volume threshold. Further, Autocar's written comments as well as information provided during follow-up meetings indicate that this threshold would accommodate their production of non-speed-limited drayage tractors. Therefore the agencies are adopting a flexibility exclusively for small businesses to optionally certify up to 200 drayage tractors annually under the custom chassis program to the standards established for transit buses. Otherwise manufacturers may elect to either certify their drayage tractors to the primary standards or design them to satisfy the eligibility criteria of 40 CFR 1037.631 (*i.e.*, to be speed-limited). We are adopting this as an interim provision (although there is no automatic sunset) to allow small businesses time to develop experience in the certification process as well as to develop future product plans.

### (c) Specialty Vehicle Exemption

As described in Section XIII of this Preamble, the agencies are adopting alternate engine standards for specialty vehicles as part of the final Phase 2 program. Because some vocational vehicles may have engines certified under these specialty vehicle provisions found at 40 CFR 1037.605, we are clarifying here how these provisions interact. According to the regulations at 40 CFR 1037.605, a manufacturer may produce no more than 1,000 hybrid vehicles in a single model year under this option, and no more than 200 amphibious vehicles, speed-limited vehicles, or all-terrain vehicles. Under this provision, speed-limited vehicles are those that cannot exceed 45 mi/hr by tamper-proof calibration. Only vehicles with hybrid drivetrains that certify engines under this provision must also have a vehicle-level Phase 2 certificate, as required under 40 CFR 1037.105. The three other types would be exempt from the vehicle standards. Depending on the manufacturer and vehicle type, this may mean that such hybrid vehicles may need to meet the primary vocational

<sup>404</sup> See memorandum dated July 2016 with data on exempted off-road vocational vehicles.

<sup>405</sup> See memorandum dated July 2016 titled, "Summary of SmartWay Port Dray 2014 Data".

<sup>406</sup> See Note 403, above.

vehicle standards or one of the custom chassis standards.

### C. Feasibility of the Vocational Vehicle Standards

This section describes the agencies' technological feasibility and cost analysis. Further detail on all of these technologies can be found in the RIA Chapter 2.4 and Chapter 2.9. The variation in the design and use of vocational vehicles has led the agencies to project different technology solutions for each regulatory subcategory. Manufacturers may also find additional means to reduce emissions and lower fuel consumption than the technologies identified by the agencies, and of course may adopt any compliance path they deem most advantageous. This section includes discussion of the feasibility of the final standards for non-custom vocational vehicles using the full Phase 2 certification path, as well as the final optional standards for custom chassis standards.

NHTSA and EPA collected information on the cost and effectiveness of fuel consumption and CO<sub>2</sub> emission reducing technologies from several sources. The primary sources of information were the Southwest Research Institute evaluation of heavy-duty vehicle fuel efficiency and costs for NHTSA,<sup>407</sup> the 2010 National Academy of Sciences report of Technologies and Approaches to Reducing the Fuel Consumption of Medium- and Heavy-Duty Vehicles,<sup>408</sup> TIAX's assessment of technologies to support the NAS panel report,<sup>409</sup> the technology cost analysis conducted by ICF for EPA,<sup>410</sup> and the 2009 report from Argonne National Laboratory on Evaluation of Fuel Consumption Potential of Medium and Heavy Duty Vehicles through Modeling and Simulation.<sup>411</sup>

(1) What technologies are the Agencies considering to reduce the CO<sub>2</sub> emissions and fuel consumption of vocational vehicles?

In assessing the feasibility of the final Phase 2 vocational vehicle standards,

<sup>407</sup> Reinhart, T. (February 2016). *Commercial Medium- and Heavy-Duty (MD/HD) Truck Fuel Efficiency Technology Study—Report #2*. Washington, DC: National Highway Traffic Safety Administration. EPA-HQ-OAR-2014-0827-1623.; and Schubert, R., Chan, M., Law, K. 2015, *Commercial Medium- and Heavy-Duty (MD/HD) Truck Fuel Efficiency Cost Study*. Washington, DC: National Highway Traffic Safety Administration.

<sup>408</sup> See NAS Report, Note 229 above.

<sup>409</sup> See TIAX 2009, Note 230 above.

<sup>410</sup> See ICF 2010, Note 232 above.

<sup>411</sup> Argonne National Laboratory, "Evaluation of Fuel Consumption Potential of Medium and Heavy Duty Vehicles through Modeling and Simulation." October 2009.

the agencies evaluated a suite of technologies, including workday idle reduction, improved tire rolling resistance, tire pressure monitoring or inflation systems, improved transmissions including hybrids, improved axles, improved accessories, and weight reduction, as well as their impact on reducing fuel consumption and GHG emissions. The agencies also evaluated aerodynamic technologies and full electric vehicles.

As discussed above, vocational vehicles may be powered by either SI or CI engines. The technologies and feasibility of the engine standards are discussed in Section II. At the vehicle level, the agencies have considered the same suite of technologies and have applied the same reasoning for including or rejecting these vehicle-level technologies as part of the basis for the final standards, regardless of whether the vehicle is powered by a CI or SI engine, since the vehicle level technologies are not a function of engine type. Generally, the analysis below does not distinguish between vehicles with different types of engines. The resulting vehicle standards do reflect the differences arising from the performance of CI (primarily diesel) or SI (primarily gasoline) engines over the GEM cycles. Note that vehicles powered by engines using fuels other than diesel or gasoline are subject to either the SI or CI vehicle standards, as specified in 40 CFR 1037.101.

#### (a) Vehicle Technologies Considered in Standard-Setting

The agencies note that the effectiveness values estimated for the technologies have been obtained using a variety of methods, including average literature values, engineering calculation, and GEM simulation. They do not reflect the potentially-limitless combination of possible values that could result from adding the technology to different vehicles. For example, while the agencies have estimated an effectiveness of one percent for e-accessories, each vehicle could experience a unique effectiveness depending on the actual accessory load for that vehicle. On-balance the agencies believe this is the most practicable approach for determining effectiveness for the technologies in the Phase 2 vocational vehicle program. This section is organized to first present the agencies' analyses of technology feasibility and effectiveness in Section V.C.(1), and below in Section V.C.(2) we present our projected technology adoption rates and estimated costs. Where other details are not given, the feasibility sections set forth our rationale for the projected

adoption rates. Average vehicle technology package costs by regulatory subcategory are presented below in Section V.C.(2)(e). Individual technology costs are summarized in the RIA Chapter 2.9.3, and full details behind all these costs are presented in RIA Chapter 2.11, including the markups and learning effects applied for each of the technologies.

#### (i) Transmissions

Transmission improvements present a significant opportunity for reducing fuel consumption and CO<sub>2</sub> emissions from vocational vehicles. Transmission efficiency is important for all vocational vehicles as their duty cycles involve significant amounts of driving under transient operation. Even Regional vocational vehicles have 20 percent of their composite score based on the transient test cycle. The three categories of transmission improvements the agencies proposed to consider as part of a compliance path used to determine standard stringency were driveline optimization, architectural improvements, and hybrid powertrain systems. As a result of comments and enhanced capabilities of GEM, we are adopting standards based on performance of a revised set of transmission technologies. For each technology, we have adjusted our projected penetration rates where we found that comments provided a persuasive reason to do so, and the effectiveness values are all updated according to the current GEM over the new drive cycle weightings.

The technology we described at proposal as driveline integration, 80 FR 40296, is now defined as use of an advanced shift strategy. At proposal the agencies included shift strategy, aggressive torque converter lockup, and a high efficiency gearbox among the technologies defined as driveline integration that would only be recognized by use of powertrain testing. We also proposed a 70 percent adoption rate in MY 2027 on the basis that this approach to improving fuel efficiency is highly cost-effective and technically feasible in a wide range of applications, and that the additional lead time would enable manufacturers to overcome barriers related to the non-integrated nature of businesses serving this sector. We received persuasive comments from manufacturers emphasizing the diversity of their product lines and the extent of testing that would be needed to apply this technology to 70 percent of their sales, and as a result we have reduced our projected adoption rates for this technology. The agencies continue to believe that an effective way to derive

efficiency improvements from a transmission is by optimizing it with the engine and other driveline components to balance both performance needs and fuel savings. One example of an engine manufacturer partnering with a transmission manufacturer to achieve an optimized driveline is the SmartAdvantage powertrain.<sup>412</sup> The agencies project transmission shift strategies, including those that make use of enhanced communication between engine and driveline, can yield efficiency improvements ranging from three percent for Regional vehicles to nearly six percent for Urban vehicles, using engineering calculations (see RIA 2.9.3.1) to estimate the benefits that can be demonstrated over the powertrain test. We received comment that we had poorly defined the technology that can bring about improvements related to drive line integration. In considering the comments and available information, we believe it is reasonable to project that transmissions may feature advanced shift strategies where they make use of an additional sensor to improve fuel efficiency such as by detecting payload or road grade. See Section V.D.(1) and the RIA Chapter 3.6 for a discussion of the powertrain test procedure.

The agencies have revised the GEM simulation tool to recognize additional transmission technologies beyond what was possible at the time of proposal. We are adopting a transmission efficiency test to recognize improved mechanical gear efficiency and reduced transmission friction, where the test results can be submitted as GEM inputs to override the default efficiency values. Because this test can be conducted with a bare transmission without needing to be paired with an engine, each test will be valid for a much broader range of vehicle configurations than for a powertrain test. The agencies project vehicle fuel efficiency can be improved by up to one percent from improved transmission gear efficiency, which we are projecting to be the same during each of the driving cycles and zero while idling. RIA 2.9.3.1.1. Actual test results are likely to show that some gears have more room for improvement than others, especially where a direct drive gear is already highly efficient. Commenters requested that the minimum torque converter lockup gear be enabled as a GEM input without requiring powertrain testing. In response, final GEM also requires an input field for torque converter lockup gear. The baseline configurations with

automatic transmissions were run in GEM using lockup in third gear. The agencies project vehicle fuel efficiency can be improved up to three percent on a cycle average for torque converter lockup in first gear. RIA 2.9.3.1.1. Using the library of agency transmission files, GEM gives a different effectiveness value in every subcategory, because this is influenced by the gear ratios, drive cycle, and torque converter specifications. Manufacturers will obtain slightly different results with their own driveline specifications. The RIA at Chapter 2.9.3.1 includes a table that summarizes the various effectiveness values for different types of transmission improvements.

Although not factored into our stringency calculations, other non-hybrid transmission technologies that can also be recognized by powertrain testing include use of architectures not recognized by GEM such as dual clutch systems, and designs with reduced parasitic losses.

Most vocational vehicles currently use torque converter automatic transmissions (AT), especially in Classes 2b–6. Automatic transmissions offer acceleration benefits over drive cycles with frequent stops, which can enhance productivity. With the diversity of vocational vehicles and drive cycles, other kinds of transmission architectures can meet customer needs, including automated manual transmissions (AMT), dual clutch transmissions (DCT), as well as manual transmissions (MT).<sup>413</sup> As at proposal, dual clutch transmissions are simulated as AMT's in GEM. A manufacturer may elect to conduct powertrain testing to obtain specific improvements for use of a DCT. The RIA Chapter 4 explains the EPA default shift strategy and the losses associated with each transmission type, and discusses changes that have been made since proposal. Although the representation of transmissions has improved since proposal, the differences between AT and AMT are too difficult to isolate for purposes of figuring this into our stringency calculations. Although we expect manufacturers to have a reasonable model of transmission behavior for certification purposes, we could not estimate relative improvement values between AT and AMT for vocational vehicles using any defensible estimation method. The agencies have not been able to obtain conclusive data that could support a final vocational vehicle

standard, in any subcategory, predicated on adoption of an AMT or DCT with a predictable level of improvement over an AT. As a result, the only architectural changes on which the final vocational vehicle standards are based are increasing the number of gears and automation compared with a manual transmission.

The benefit of adding more gears varies depending on whether the gears are added in the range where most operation occurs. The TIAX 2009 report projected that 8-speed transmissions could incrementally reduce fuel consumption by 2 to 3 percent over a 6-speed automatic transmission, for Class 3–6 box and bucket trucks, refuse haulers, and transit buses.<sup>414</sup> We have run GEM simulations comparing 5-speed, 6-speed, 7-speed, and 8-speed automatic transmissions where some cases hold the total spread constant, some hold the high end ratio constant, and some hold the low-end ratio constant, where all cases use a third gear lockup and axle ratios are held constant. We have observed mixed results, with some improvements over the highway cruise cycles as high as six percent, and some cases where additional gears increased fuel consumption. As proposed, we are allowing GEM to determine the improvement, where manufacturers will enter the number of gears and gear ratios and the model will simulate the efficiency over the applicable test cycle. The agencies have revised GEM based on comment, and we are confident that it fairly represents the fuel efficiency of transmissions with different gear ratios. Consistent with literature values, we are using engineering calculations to estimate that two extra gears has an effectiveness of one percent improvement during transient driving and two percent improvement during highway driving. Weighting these improvements using our final composite duty cycles (zero improvement at idle), for purposes of setting stringency, we are conservatively estimating that adding two gears will improve vocational vehicle efficiency between 0.9 and 1.7 percent.

The final Phase 2 GEM has been calibrated to reflect a fixed two percent difference between manual transmissions and automated transmissions during the driving cycles (zero at idle). As in the HHD Regional subcategory baseline, manual transmissions simulated in GEM perform two percent worse than similarly-gear AMT. This fixed

<sup>412</sup> See Cummins-Eaton partnership at <http://smartadvantagepowertrain.com/>.

<sup>413</sup> See <http://www.truckinginfo.com/channel/equipment/article/story/2014/10/2015-medium-duty-trucks-the-vehicles-and-trends-to-look-for/page/3.aspx> (downloaded November 2014).

<sup>414</sup> See TIAX 2009, Table 4–48.

improvement is discussed further in the RIA Chapter 2.4.

Hybrid powertrain systems are included under transmission technologies because, depending on the design and degree of hybridization, they may either replace a conventional transmission or be deeply integrated with a conventional transmission. Further, these systems are often manufactured by companies that also manufacture conventional transmissions.

The agencies are including hybrid powertrains as a technology on which some of the vocational vehicle standards are predicated. We proposed ten percent overall adoption of strong hybrids by MY 2027, which meant approximately 18 percent adoption in the Multipurpose and Urban subcategories in that model year. 80 FR 40297. We received extensive comments on the ability of the vocational vehicle market to adopt hybrid drivetrains. EDF and Parker both highlighted the successful demonstrations of Parker hydraulic hybrids for refuse applications with effectiveness near 40 percent over refuse duty cycles. Autocar commented that a significant portion of their refuse truck sales have hydrostatic hybrid drives. Fleets such as Pepsico and the City of Bloomington highlighted that they are actively purchasing hybrids. ATA and UPS commented that hybrid technology applications continue to be of interest to the trucking industry, but expressed concern over the high costs that can deter uptake in the market. Eaton commented that a combination of factors is needed to re-ignite the hybrid business: lower battery costs and increased efficiency of the hybrid systems for Class 6–8, lower cost mild hybrid powertrains in Class 3–5, and continued regulatory pull. Eaton says the hybrid market is still very fragile and they do not see market conditions improving for hybrid commercial vehicles except for a few mild hybrids. Securing America's Future Energy and ACEEE also commented in favor of including mild hybrids as part of the vocational vehicle compliance package.

After considering all these comments, we agree with commenters that mild hybrids are more likely than strong hybrids to succeed initially in the vocational sector, especially outside of the bus market. We are projecting adoption of two types of mild hybrids, defined using system parameters based on actual systems commercially available in the market today.<sup>415</sup> NTEA

and the Green Truck Association both commented that a common way that today's hybrids are installed is by secondary or intermediate manufacturers. We have taken this into consideration by assuming that some mild hybrid systems will be integrated with an engine sufficient to enable use of an engine stop-start feature, while some mild hybrids will not be integrated and these "bolt-on" systems will only provide transient benefits related to regenerative braking.

Allison believes that hybrid vehicles should be certified on a duty cycle on the same basis as non-hybrid vehicles because the vehicles must perform the same work regardless of the powertrain technology. We agree and the Phase 2 test cycles are the same for conventional and hybrid drivelines. The Sierra Club asked the agencies to consider real world duty cycle data to account for the effectiveness of hybrids for vocational vehicles. Allison says investments for heavy-duty hybrids will be made by component suppliers, not by the vehicle manufacturers. The battery, inverter, and motor suppliers must make investments in addition to the system supplier. In this regard—for a small market like the heavy-duty hybrids—a significant investment, under current conditions, are seen as risky and unlikely to occur according to Allison. Allison commented that even though the transit bus industry has had commercially available hybrids for over a decade, the adoption rate of hybrids in the U.S. transit bus market is only 13.2 percent and that to achieve an overall 5 percent adoption rate of hybrid technology, the economics of the hybrid ownership would have to substantially change over the period of time covered by this rulemaking. In light of these concerns, we have adjusted our projected adoption rates of hybrid technology as described below in Section V.C.(2)(b)(i).

We also have reconsidered our effectiveness estimation method as a result of comments. Instead of relying on previously published road tests over varying drive cycles, we are applying engineering calculations to account for defined hybrid system capacities and inefficiencies over our certification test cycle. We are using a spreadsheet model that calculates the recovered energy of a hybrid system using road loads of the default baseline GEM vehicles over the ARB Transient test cycle. See RIA Chapter 2.9.3.1.3 to read more about the assumed motor and battery capacity, swing in the state of charge, and system

inefficiencies. The effectiveness is assumed (conservatively) to be zero for the highway cruise cycles to obtain the projected cycle-weighted effectiveness. For the non-integrated models, the same system was assessed for all weight classes (not scaled up for heavier vehicles); however, for the integrated models with stop-start we have scaled up the system specifications to account for the larger road loads, to ensure the projected effectiveness is not decreased for systems on heavier vehicles relative to that projected for lighter vehicles.

For the non-integrated mild hybrids, we are estimating an eight to 13 percent fuel efficiency improvement as measured over the powertrain test, depending on the duty cycle (*i.e.* Multi-purpose or Urban) in GEM for the applicable subcategory. See RIA 2.9.3.1. For the integrated mild hybrids, we have combined the effectiveness calculated for the scaled-up mild hybrid system with the effectiveness of stop-start, described below. Id. 2.9.3.1. These combined effectiveness values range from 18 to 21 percent efficiency improvement, depending on the duty cycle (*i.e.* Multi-purpose or Urban). Even though the actual improvement from hybrids in Phase 2 will be evaluated using the powertrain test, because the model uses the same vehicle test cycle and conservative estimates of realistic configurations, the agencies have concluded it is reasonable to use these spreadsheet-based estimates as a basis for setting stringency in the final rules.

Based on the public comments from hybrid suppliers and other innovators providing evidence of hybrid systems in the market today ranging from prototypes to commercialized, the agencies believe the Phase 2 rulemaking timeframes will offer sufficient lead time to develop, demonstrate, and conduct reliability testing for hybrid technologies to enable market adoptions in the range that we are projecting for the final rules.

The agencies are working to reduce barriers related to hybrid vehicle certification. In Phase 1, there is a significant burden associated with the optional test for demonstrating the GHG and fuel efficiency performance of vehicles with hybrid powertrain systems. If manufacturers wish to earn Phase 1 credit for a hybrid, they must obtain a conventional vehicle that is identical to the hybrid vehicle in every way except the transmission, test both, and compare the results.<sup>416</sup> In Phase 2,

<sup>415</sup> For example, see XL Hybrids at <http://www.xlhybrids.com/content/assets/Uploads/XL-BoxTruck-US-FLY-8.5x11-0519-LR.pdf>, and

Crosspoint Kinetics at <http://crosspointkinetics.com/members/kinetics-hybrid-partners/>.

<sup>416</sup> See test procedures at 40 CFR 1037.555. In Phase 1, evaluation of hybrid powertrain systems is

manufacturers will conduct powertrain testing on the hybrid system itself, and the results of that testing will become inputs to GEM for simulation of the non-powertrain features of the hybrid vehicle, removing a significant test burden. We will continue to work with hybrid suppliers and manufacturers to address other test burden issues, including test procedures to determine a balanced state of charge and number of default configurations needed for the cycle average map.

Hybrid manufacturers commented that meeting the on-board diagnostic requirements for criteria pollutant engine certification continues to be a potential impediment to adoption of hybrid systems. See Section XIII.A.1 for a discussion of regulatory changes to reduce the non-GHG certification burden for engines paired with hybrid powertrain systems. The agencies have also received comments on a letter from the California Air Resources Board requesting consideration of supplemental NO<sub>x</sub> testing of hybrids.<sup>417</sup> Allison provided comment on CARB's recommendations, noting that it is not possible to draw conclusions about hybrid vehicles compared with conventional vehicles using the method recommended by CARB. Allison suggests that EPA gather additional data and conduct a future analysis based on data from both low-kinetic intensity and high kinetic intensity vehicles. In the final Phase 2 program, NO<sub>x</sub> emissions will be measured and reported as a part of powertrain testing. This will allow EPA to monitor NO<sub>x</sub> performance and identify potential problems long before sales increase to a point at which significant in-use impacts could occur. The information collected will also be used to inform EPA as to the merits of future rulemaking. However, EPA believes that finalizing the approach recommended at this time could represent an undue burden for this emerging technology.

Based on comments received and stakeholder outreach, we have reason to believe that some custom chassis manufacturers are better positioned than others to adopt transmission technology to improve fuel efficiency. Most have little or no in-house research capacity, and purchase off-the-shelf transmissions. Some, such as Gillig and Autocar, have partnered with suppliers to successfully implement hybrids on

their vehicles. Some bus chassis manufacturers are exploring the benefits of applying transmissions with additional gears. In real world driving, vehicles with a lot of transient operation, including custom chassis, can see real fuel savings from adoption of improved transmissions, including those with more efficient gears and advanced shift strategies. We expect that suppliers will continue to develop improved transmissions for vocational vehicles including some custom chassis, and that manufacturers will continue to select transmissions that deliver reliable products to fuel-conscious customers. Specifically, we believe that bus manufacturers will continue to have choices of competing products that offer performance characteristics that improve over time. Below in V.C.(2)(b) we discuss the reasons why we believe that a final Phase 2 program that is largely blind to these transmission-based improvements for custom chassis will avoid adverse unintended consequences.

#### (ii) Axles

The agencies are predicating part of the stringency of the final vocational vehicle standards on performance of two types of axle technologies. The first is advanced low friction axle lubricants and efficiency as demonstrated using the separate axle test procedure described in the RIA Chapter 3.8 and 40 CFR 1037.560. The agencies received adverse comment on the proposal to assign a fixed 0.5 percent improvement for this technology. In consideration of comments, the agencies are instead assigning default axle efficiencies to all vocational vehicles. Manufacturers may submit test data to over-ride axle efficiency values in GEM. Our cost analysis for the final rulemaking includes maintenance costs of replacing axle lubricants on a periodic basis. See the RIA Chapter 7.1.3. Based on supplier information, some advanced lubricants have a longer drain interval than traditional lubricants. We are estimating the axle lubricating costs for HHD to be the same as for tractors since those vehicles likewise typically have three axles. However, for LHD and MHD vocational vehicles, we scaled down the cost of this technology to reflect the presence of a single rear axle. We expect that improved axle efficiency is technically feasible on all vocational vehicles including custom chassis. However, it's likely that axle suppliers may be more likely to invest in design and lubrication improvements for high sales volume products, such as axles that can serve both tractor and vocational markets. Further, to the

extent that extreme duty cycles require lubricants with special performance features, it's likely that the most advanced low-friction lubricants may not be feasible for some custom chassis such as refuse trucks.

The second axle technology applies only for HHD vocational vehicles, which typically are built with two rear axles. Part time 6x2 configuration or axle disconnect is a design that enables one of the rear axles to temporarily disconnect or otherwise behave as if it's a non-driven axle. The agencies proposed to base the HHD vocational vehicle standard on some use of both part time and full time 6x2 axles. The agencies received adverse comment on the application of the permanent 6x2 configuration for vocational vehicles. The disconnect configuration is one that keeps both drive axles engaged only during some types of vehicle operation, such as when operating at construction sites or in transient driving where traction especially for acceleration is vital. Instead of calculating a fixed improvement as at proposal, the agencies have refined GEM to recognize this configuration as an input, and the benefit will be actively simulated over the applicable drive cycle. Effectiveness based on simulations with EPA axle files is projected to be as much as one percent for HHD Regional vehicles. Further information about this technology is provided in RIA Chapter 2.4.5. The feasibility of this technology depends on whether the baseline axle configuration is a 6x4 and whether the vehicle is likely to spend significant amounts of time on the highway. For vocational vehicles, this is largely limited to Regional and Multipurpose HHD vehicles. To the extent that any motor homes and coach buses with GVWR over 33,000 lbs are built with two rear axles, this technology could be technically feasible. However, because these vehicles generally operate on paved roads and may not need the traction of a 6x4, a popular axle configuration for these vehicles is a permanent 6x2.

#### (iii) Lower Rolling Resistance Tires

Tires are the second largest contributor to energy losses of vocational vehicles, as found in the energy audit conducted by Argonne National Lab.<sup>418</sup> The two most helpful sources of data in establishing the projected vocational vehicle tire rolling resistance levels for the final Phase 2 standards are the comments from RMA and actual certification data for model

<sup>418</sup> See Argonne National Laboratory 2009 report, Note 411, page 91.

an option for which advanced technology credits are available.

<sup>417</sup> California Air Resources Board. Letter from Michael Carter to Matthew Spears dated December 29, 2014. CARB Request for Supplemental NO<sub>x</sub> Emission Check for Hybrid Vehicles. Docket EPA-HA-OAR-2014-0827.



year 2014. At proposal, we projected that all vocational vehicle subcategories could achieve average steer tire coefficient of rolling resistance (CRR) of 6.4 kg/ton and drive tire CRR of 7.0 kg/ton by MY 2027. These new data have informed our analysis to enable us to differentiate the technology projections by subcategory. The RMA comments included CRR values for a wide range of vocational vehicle tires, for rim sizes from 17.5 inches to 24.5 inches, for steer/all position tires as well as drive tires. The RMA data, while illustrating a range of available tires, are not sales weighted. The 2014 certification data include actual production volumes for each vehicle type, thus both steer and drive tire population-weighted data are available for emergency vehicles, cement mixers, school buses, motor homes, coach buses, transit buses, and other chassis cabs. The certification data are consistent with the RMA assessment of the range of tire CRR currently available. We also agree with RMA's suggestion to set a future CRR level where a certain percent of current products can meet future GEM targets. We disagree with RMA that the MY 2027 target should be a level that 50 percent of today's product can meet. With programmatic averaging, such a level would mean essentially no improvements overall from tire rolling resistance, because today when manufacturers comply on average, half their tires are above the target and half are below. Further, with Phase 2 GEM requiring many more vehicle inputs than tire CRR, manufacturers have many more degrees of freedom to meet the performance standard than they do in Phase 1. In these final rules, the agencies are generally projecting adoption of LRR tires in MY 2027 at levels currently met by 25 to 40 percent of today's vocational products, on a sales-weighted basis.<sup>419</sup> We are differentiating the improvement level by weight class and duty cycle, recognizing that heavier vehicles designed for highway use can generally apply tires with lower rolling resistance than other vehicle types, and will see a greater benefit during use. None of the rolling resistance levels projected for adoption in MY 2027 are lower than the 25th percentile of tire CRR on actual vocational vehicles sold in MY 2014. Thus, we believe the improvements will be achievable without need to develop new tires not yet available. Further

details are presented in the RIA Chapter 2.9.

In simulation, the benefit of LRR tires is reflected in GEM differently for vehicles of different weight classes and duty cycles. Based on simulations using the projected tire CRR, the agencies project fuel efficiency improvements by MY 2027 for LRR tires on Regional vocational vehicles between two and three percent, for Multipurpose vehicles between one and three percent, and for Urban vehicles up to one percent. This technology is also feasible on all custom chassis, with similarly larger improvements feasible for coach buses and motor homes with typically regional drive cycles, and similarly smaller improvements feasible for school and transit buses, refuse trucks, and concrete mixers with typically urban drive cycles.

As proposed, the agencies will continue the light truck (LT) tire CRR adjustment factor that was adopted in Phase 1. 80 FR 40299; see generally 76 FR 57172–57174. In Phase 1, the agencies developed this adjustment factor by dividing the overall vocational test average CRR of 7.7 by the LT vocational average CRR of 8.9. This yielded an adjustment factor of 0.87. Because the MY 2014 certification data for LHD vocational vehicles may have included some CRR levels to which this adjustment factor may have already been applied, and because we did not receive adverse comment on our proposal to continue this, the agencies have concluded that we do not have a basis to discontinue allowing the measured CRR values for LT tires to be multiplied by a 0.87 adjustment factor before entering the values in the GEM for compliance.

In Table V–15, the descriptors 1v through 5v refer to levels of rolling resistance that have been identified among the population of tires installed on vocational vehicles certified for MY 2014. Each of these levels is in production today and represents tires that have been fitted on a certified vehicle. The agencies have defined these levels for purposes of estimating the manufacturing costs associated with applying improved tire rolling resistance to vocational vehicles. These levels are not applicable for estimating degrees of improvement or costs of LRR tires on tractors, trailers, or HD pickups and vans as part of this rulemaking. Furthermore, these levels do not represent the full range of tire CRR available for vocational vehicles. There are both steer and drive tires on certified vocational vehicles today with CRR ranging from 5 kg/ton to 15 kg/ton. We expect this full range of tires will

continue to be available in the market well into the future.

TABLE V–15—DEFINED LEVELS OF VOCATIONAL TIRE CRR

Rolling resistance level descriptor	Range min.	Range max.
LRR level 1v .....	7.5	8.1
LRR level 2v .....	7.0	7.49
LRR level 3v .....	6.6	6.99
LRR level 4v .....	6.3	6.59
LRR level 5v .....	5.8	6.29

(iv) Workday Idle Reduction

The Phase 2 idle reduction technologies considered for vocational vehicles are those that reduce workday idling, unlike the overnight or driver rest period idling of sleeper cab tractors. Idle reduction technology is one type of technology that is particularly duty-cycle dependent. In light of new information, the agencies have learned that our proposal had mischaracterized the idling operation of vocational vehicles, significantly underestimating the extent of this mode of operation, and incorrectly calculating it using a drive idle cycle when significant idling also occurs while parked. As described above in Section V.B.(1), in these final rules we have revised our test cycles to better reflect real world idle operation, including both parked idle and drive idle test conditions. At proposal, we identified two types of idle reduction technologies to reduce workday idle emissions and fuel consumption for vocational vehicles: neutral idle and stop-start. After considering the new duty cycle information and the many comments received, we are basing our final vocational vehicle standards in part on the performance of three types of workday idle reduction technologies: neutral idle, stop-start, and automatic engine shutdown; which we believe are effective, feasible, and cost-effective, as discussed further in this section.

Neutral idle is essentially a transmission technology, but it also requires a compatible engine calibration. Torque converter automatic transmissions traditionally place a load on engines when a vehicle applies the brake while in drive, which we call curb idle transmission torque (CITT). When an engine is paired with a manual or automated manual transmission, the CITT is naturally lower than when paired with an automatic, as a clutch disengagement must occur for the vehicle to stop without stalling the engine. We did not receive adverse comment on our proposal to include this technology in our standard-setting for vocational vehicles. The engineering

<sup>419</sup> See memorandum dated May 2016 titled, Vocational Vehicle Tire Rolling Resistance Certification Data.



required to program sensors to detect the brake position and vehicle speed, and enable a smooth re-engagement when the brake pedal is released makes this a relatively low complexity technology that can be deployed broadly. Navistar commented that idle reduction strategies must have sufficient engine, aftertreatment and occupant protections in place such that any fuel cost savings are a net benefit for the owner/operator without compromising safety. We agree, and for neutral idle we believe an example of an allowable override is if a vehicle is stopped on a hill. Skilled drivers operating manual transmissions can safely engage a forward gear from neutral when stopped on upslopes with minimal roll-back. With an AT, the vehicle's computer would need to handle such situations automatically. In addition, engagement of the PTO while driving will be an allowable over-ride condition. In the Phase 2 certification process, transmission suppliers will attest whether the transmission has this feature present and active, and certifying entities will be able to enter Yes or No as a GEM input for the applicable field. The effectiveness of this technology will be calculated using data points collected during the engine test, and the appropriate fueling over the drive idle cycle and the transient cycle will be used. Based on GEM simulations using the final vocational vehicle test cycles, the agencies project neutral idle to provide fuel efficiency improvements up to seven percent for diesel vehicles, and up to two percent for gasoline vehicles, depending on the regulatory subcategory.<sup>420</sup> The lesser effectiveness for gasoline vehicles is due to lower curb idle transmission torque present in the baseline configurations for gasoline than the diesel vehicles, as documented in the SwRI report.<sup>421</sup>

Neutral idle may be programmed on any automatic transmission, and can reasonably be applied for vocational vehicles where this feature would not frequently encounter an over-ride condition. Vehicles with high PTO operation can apply this technology, although they would see reduced effectiveness in use.

Automatic engine shutdown (AES) is an engine technology that is widely available in the market today, but has seen more adoption in the tractor market than for vocational vehicles. Although we did not propose to include this technology, we received many

comments suggesting this would be appropriate. Some commenters may have conflated the concept of stop-start with AES, such as a comment we received asking us to consider the on-board need to power accessories while the vehicle is in stationary mode. We believe that automatic engine shutdown is effective and feasible for many different types of vehicles, depending on how significant a portion of the work day is spent while parked. Most truck operators are aware of the cost of fuel consumed while idling, and importantly, the wear on the engine due to idling. Engine manufacturers caution owners to monitor the extent of idling that occurs for each work truck and to reduce the oil change interval if the idle time exceeds ten percent of the work day.<sup>422</sup> Accordingly, many utility truck operators track their oil change intervals in engine hours rather than in miles.

NTEA provided the agencies with a report with survey results on which work truck fleets are adopting AES with backup power, and their reasons for doing so.<sup>423</sup> The most common reason given in the survey is to allow an engine to shut down and still have vehicle power available to run flashing safety lights. Some vocational vehicles also need to conduct work using a power take-off (PTO) while stationary for hours, such as on a boom truck. The agencies are adopting an allowable AES over-ride for PTO use. Technologies that can reduce fuel consumption during this type of high-load idle are discussed below in V.C.(1)(c)(iii). We are also adopting an allowable AES over-ride if the battery state of charge drops below a safe threshold. This would ensure there is sufficient power to operate any engine-off accessories up to a point where the battery capacity has reached a critical point. Where a vocational vehicle has such extensive stationary accessory demands that an auxiliary power source is impractical or that an over-ride condition would be experienced frequently, we would not consider AES to be feasible. In the Phase 2 certification process, engine suppliers will attest whether this feature is present and tamper-proof, and certifying entities will be able to enter Yes or No as a GEM input for the applicable field.<sup>424</sup> As with neutral idle described

above, the effectiveness of AES will be calculated in GEM using data obtained through engine testing. The appropriate data points over the parked idle cycle will be used for calculating the fueling. Based on GEM simulations using the final vocational vehicle test cycles, the agencies project AES to provide fuel efficiency improvements ranging from one to seven percent, depending on the regulatory subcategory.

The agencies proposed to predicate the vocational vehicle standards in part on 70 percent adoption of stop-start in MY 2027. We received numerous comments from manufacturers and suppliers with concerns about all aspects of this technology, including its feasibility, its effectiveness, and the lead time to make it commercially available. As discussed above, our assessment of workday idle reduction technologies has been refined since proposal, and part of this refinement includes less reliance on adoption of stop-start than at proposal.

Stop-start is a technology that requires an integration between engine and vehicle systems, and is seeing increasing acceptance in today's passenger vehicle market. The agencies are aware that for a vocational vehicle's engine to turn off during workday driving conditions, there must be a minimal reserve source of energy to maintain engine-protection and safety functions such as power steering, transmission pressure, engine lubrication and cooling, among others. As such, stop-start systems can be viewed as having a place on the low-cost end of the hybridization continuum. Effenco commented that a minimum of additional hardware is required to deliver enough power to frequently and seamlessly restart a large engine as well as to keep accessories and equipment operational with the engine turned off. Navistar commented persuasively that coking can occur if the cooling and lubricating oil is removed. The agencies therefore would consider electrified water and oil pumps to be part of the stop-start technology package. However, we must be clear to distinguish this technology from the AES described above. Stop-start technologies will be recognized only over the drive idle cycle and the transient cycle in GEM, not the parked idle cycle (whereas AES is recognized only over the parked idle cycle). Accordingly, the purpose of the additional hardware is to protect the engine for short duration stops such as at traffic lights, not to power accessories while the vehicle is parked.

Volvo commented that stop-start is not feasible for HHD engines (generally 11L and larger), and claims engine

<sup>422</sup> See Ford powerstroke guide at <https://www.fleet.ford.com/truckbbas/non-html/DeiselTips/DLSIDLETIMESS.pdf> (accessed March 2016); see also Cummins maintenance schedule, available at [http://www.cumminsbridgeway.com/pdf/parts/Recommended\\_Maintenance\\_Schedule.pdf](http://www.cumminsbridgeway.com/pdf/parts/Recommended_Maintenance_Schedule.pdf) (accessed March 2016).

<sup>423</sup> NTEA, 2015 Work Truck Electrification and Idle Management Study.

<sup>424</sup> We will consider non-tamper-proof AES as off-cycle technologies for a lesser credit.

<sup>420</sup> See spreadsheet file dated July 2016 titled, "FRM\_Vocational-Standards\_GEMpostprocess.xls". See EPA-HQ-OAR-2014-0827.

<sup>421</sup> See Reinhart 2015, Note 345 above.

development costs will be very high since stop-start cycling tests can only be accelerated by a limited amount before the failure mechanisms are altered. However, their objections relate more to the challenges of stop-start for HHD engines and do not actually show the technology to be infeasible. Although we disagree with Volvo that stop-start is infeasible for HHD engines, we understand it may require more development time and cost than for engines in lighter vehicles. It's possible that some time may be needed for development work where manufacturers elect to shift away from reliance on batteries for starting the engine and begin to rely instead on ultracapacitors, which do not have the same problems with cold weather operation and long term fatigue as do batteries.<sup>425</sup> Volvo and EMA commented that main and rod bearings as well as other bearing surfaces would need to be strengthened and improvements may be needed for starters and lubrication systems. We agree with commenters that this type of development work would likely be part of bringing this technology to the vocational vehicle market, and thus we have included costs for upgrades similar to those described for all sizes of engines, not just those over 11L. In the event that an engine manufacturer needs to delay adoption of stop start to roll these changes in to a planned platform redesign, we believe our relatively modest adoption rate of 30 percent in MY 2027 will accommodate this. Descriptions of costs for stop-start may be found in the RIA Chapter 2.11.6.6.

We are not aware of stop-start systems that are commercially available for conventional vocational vehicles today, but this feature is available as part of some current hybrid systems. We are aware of one supplier who is demonstrating today a capacitor-based stop-start system with on-board electronics sufficient to protect a HHD engine and even power a PTO.<sup>426</sup> Furthermore, other manufacturers and suppliers are researching this.<sup>427</sup> Therefore we are confident heavy-duty stop-start systems for conventional vehicles will be feasible in the time frame of Phase 2. Where stop-start is relied upon as part of a certified configuration with components installed by a secondary manufacturer, these will be subject to specifications

and installation instructions of the certifying manufacturer.

In response to comments, we are adopting some permissible over-ride conditions under which a stop-start system may either restart sooner than otherwise or not shut down an engine. Navistar, Waste Management and others commented that vehicles with a significant power take-off (PTO) load will not be able to accommodate start/stop technology. As with neutral idle, we agree that engagement of the PTO while driving should be an allowable over-ride condition, as there are some vehicles that must conduct PTO work while underway. For example, cement mixers must continually rotate the drum and refuse trucks routinely compact their load throughout their neighborhood collection activity. Additional over-rides are discussed in the RIA Chapter 2.9.3.4. If a manufacturer designs a system that does not need as many over-rides due to additional electrification or other on-board systems, then an application for off-cycle credit may be submitted, to recognize a greater effectiveness. The regulations at 40 CFR 1037.660 specify the allowable over-rides.

The effectiveness of stop-start as recognized in GEM will be engine-dependent. Engines with high emissions/fuel consumption at idle will see greater reductions. Also, vehicles that idle frequently will see greater reductions. Based on GEM simulations using the final vocational vehicle test cycles, the agencies project stop-start to provide fuel efficiency improvements up to 14 percent for diesel vehicles, and up to 11 percent for gasoline vehicles, depending on the regulatory subcategory. See RIA 2.9.3.4. The data points for calculating the fueling over the transient and drive idle cycles are obtained from the engine map, and vehicle certifiers may input Yes or No when running GEM, to indicate whether the engine shuts off within five seconds of zero vehicle speed with the service brake applied. Allison commented that GEM should calculate fueling only for a couple seconds before assuming the engine shuts down in a stop-start system. Navistar suggested that we recognize that some fleets—*e.g.* heavy haul, refuse, mixer trucks and tow trucks—may elect to have this feature set as a programmable parameter to ensure maximum safety is maintained. We believe that five seconds is appropriate because we expect a wide variety of stop-start solutions to be deployed in the vocational vehicle market, and we anticipate modest use of over-ride conditions. Setting a shorter duration before shutdown could over-

estimate the reductions achieved by this technology in use. We believe this is a fair way to represent that the system may not have the designed effectiveness under all conditions.

As with the other idle reduction technologies described above, stop-start can reasonably be applied for vocational vehicles where this feature would not frequently encounter an over-ride condition. Vehicles with very little driving in transient conditions or with high PTO operation can apply this technology, although they would see reduced effectiveness in use. Chassis manufacturers certifying refuse trucks to the optional custom chassis standards may enter Yes in the input field in GEM for stop-start and the effectiveness will be computed based on the default 350 hp engine with 5-speed HHD automatic transmission. Manufacturers opting to certify refuse trucks to the primary standards will have an option to be recognized for enhanced stop-start systems through the powertrain test See RIA 2.9.3.4 and 2.9.5.1.4.

The agencies received comments from Allison Transmission where they observed a seven percent NO<sub>x</sub> co-benefit of stop-start idle reduction technology on transit buses. Daimler also commented that it is investigating the potential for improving heat retention in the SCR system via stop-start, but because of early stages of development it cannot verify or quantify actual benefits. The agencies also conducted independent NO<sub>x</sub> testing of engines at idle; however, the data are not conclusive enough for the agencies to quantify the NO<sub>x</sub> co-benefits of vocational workday idle reduction as part of this rulemaking.

#### (v) Weight Reduction

The agencies are predicating the final vocational vehicle standards in part on use of material substitution for weight reduction. The method of recognizing this technology is similar to the method used for tractors. The agencies have created a menu of vocational chassis components with fixed reductions in pounds that may be entered in GEM when substituting a component made of a more lightweight material than the base component made of mild steel. According to the 2009 TIAX report, there are freight-efficiency benefits to reducing weight on vocational vehicles that carry heavy cargo, and tax savings potentially available to vocational vehicles that remain below excise tax weight thresholds. This report also estimates that the cost effectiveness of weight reduction over urban drive cycles is potentially greater than the cost effectiveness of weight reduction

<sup>425</sup> Maxwell Technologies, How Ultracapacitors Improve Starting Reliability for Truck Fleets, 2016.

<sup>426</sup> See comment submitted by Effenco describing such a system designed for a refuse packer.

<sup>427</sup> See phone log for L. Steele, conversation with B. Van Amburg, May 2016.

for long haul tractors and trailers. We are adopting as proposed a GEM allocation of half the weight reduction to payload and half to reduced chassis weight. We did not receive comment suggesting a different weight allocation. The menu of components available for a vocational vehicle weight reduction in GEM is presented in Section V.D.1 and in the RIA Chapter 2.9, and is in the regulations at 40 CFR 1037.520. It includes fewer options than proposed, due to persuasive comments from Allison that aluminum transmission cases and clutch housings are standard for automatic transmissions. The American Iron and Steel Institute (AISI) commented that light weight values for high strength steel should be adjusted upward, citing light-duty vehicle weight reduction approaches using high strength steel and saying these improvements should apply to the heavy-duty sector as well. AISI also commented against the inclusion of any light-weight components as a compliance mechanism for vocational vehicles without technical data to support the weight saving values. At proposal, we based our weight reduction values for class 8 vocational vehicles on the values adopted for use in certifying tractors in Phase 1. We proposed to scale these values down for lighter weight vehicles based either on number of axles or other attributes based on engineering judgment. We also considered information supplied by expert members of the Aluminum Transportation Group.<sup>428</sup> The final rules reflect revised weight reduction values in response to the comments from AISI, and in further consideration of information provided by the Aluminum Transportation Group. We were unable to make use of the additional references submitted by AISI as part of this standard-setting process, either because the technology requires redesign rather than material substitution, or because we did not see a way to apply the light-duty information to heavy-duty vehicles. For setting stringency, however, we do not rely on any values in the lookup table except those for aluminum wheels (although these performance-based standards may be achieved in the manner deemed most cost-effective by manufacturers). The stringency of the final vocational vehicle standards for custom chassis transit buses and vehicles in the primary program is based in part on use of aluminum wheels in 10 positions on 3-axle vocational vehicles (250 lbs) and in 6 wheel positions on 2-axle

vocational vehicles (150 lbs). Based on the TIAX report and experience with the tractor program, the agencies are confident that manufacturers who choose to incorporate weight reduction on vocational vehicles will have a number of feasible material substitution choices at the chassis level, which could add up to weight savings of hundreds of pounds. The agencies do not have information about any subset of vocational vehicles that would be unable to adopt aluminum wheels, thus our projected adoption rates are much higher than at proposal. Our projected adoption rate is revised upward based on the determination that the technology package is smaller (fewer pounds removed than at proposal) and that aluminum wheels are widely available and feasible. We have learned through stakeholder outreach that weight-sensitive applications such as ready-mix concrete and refuse have already extensively applied weight reduction technologies, for freight efficiency reasons.<sup>429</sup> Therefore the agencies have not predicated the standards for these custom chassis on further weight reduction.

Based on the default payloads in GEM, and depending on the vocational vehicle subcategory, the agencies estimate a reduction of 250 lbs would offer a fuel efficiency improvement of up to one percent for HHD vehicles, and a reduction of 150 pounds would offer a fuel efficiency improvement up to 0.8 percent for MHD vehicles, and up to 1.5 percent for LHD vehicles. See RIA 2.9.3.5.

The agencies received comment that the HD Phase 2 program should recognize the enhanced benefit of weight reduction of rotating components, but the agencies lack sufficient data to incorporate the necessary programming in GEM to enable this feature. Manufacturers wishing to obtain credit for lightweight components beyond those on the menu in the regulations or for use of lightweighting technologies that are more effective than we have projected, may apply for off-cycle credits.

#### (vi) Electrified Accessories

Although we did not propose to allow pre-defined credit for electrified accessories as was proposed for tractors, we received comment requesting that this be allowed for vocational vehicles. As discussed above, the agencies are projecting that some electrified accessories will be necessary as part of

the development of stop-start idle reduction systems for vocational vehicles. The technology package for vocational stop-start includes costs for high-efficiency alternator, electric water pump, electric cooling fan, and electric oil pump. However, because the GEM algorithm for determining the fuel benefit of stop-start does not account for any e-accessories, vehicles certified with stop-start are also eligible to be certified using an improvement value in the e-accessories column.

Daimler, ICCT, Bendix, Gentherm, Navistar, Odyne, and CARB asked the agencies to consider electric cooling fans, variable speed water pumps, clutched air compressors, electric air compressors, electric power steering, electric alternators, and electric A/C compressors. ICCT cautioned that certain accessories would be recognized over an engine test and credit should not be duplicated at the vehicle level. Bosch suggested that high-efficiency alternators be considered, and suggested use of a standard component-level test for alternators to determine their efficiency, and establishment of a minimum efficiency level that must be attained. Although there are industry-accepted test procedures for measuring the performance of alternators, we do not have sufficient information about the baseline level performance of alternators to define an improved level that would qualify for a benefit at certification. We are not able to set a fixed improvement for electric cooling fans or clutched accessories due to similar challenges related to baselines and defining the qualifying technology. In consideration of ICCT's comment, we are not including water pumps and oil pumps among the components eligible for a fixed improvement because we believe that our engine test procedure will recognize improvements that would be seen in the real world from electrifying these. Thus, we believe it is appropriate to offer a fixed technology improvement for use of electric power steering and an electric A/C compressor as an input to GEM.

The agencies have conducted modeling in GEM to compare configurations with different default accessory loads, and have demonstrated there is a measurable effect of reducing 1 kW of accessory load for each vocational subcategory (see RIA 2.9.3.6). The agencies have incorporated information from this GEM modeling with information from comments provided by ICCT, the TIAX 2009 technology report, CARB's Driveline Optimization report, and the 2010 NAS report to assign fixed improvement values for the defined technologies as

<sup>428</sup> See email to L. Steele from D. Richman dated March 19, 2015 with attachments.

<sup>429</sup> See phone log for L. Steele, conversation with Terex (Aug 2015) and meeting with Autocar (April 2016).

shown in Table V–16. These values are consistent with the TIAX study that used 2 to 4 percent fuel consumption improvement for accessory

electrification, with the understanding that electrification of accessories will have more effect in short haul/urban applications and less benefit in line-

haul applications.<sup>430</sup> The RIA Chapter 2.9 explains how these effectiveness values were obtained.

TABLE V–16—EFFECTIVENESS OF VOCATIONAL E-ACCESSORIES

Technology	Effectiveness %	Subcategories
Electric A/C Compressor .....	0.5 1.0	HHD. MHD & LHD.
Electric Power Steering .....	0.5 1.0	Regional. Multipurpose & Urban.

Optimization and improved pressure regulation may significantly reduce the parasitic load of the water, air and fuel pumps. Electrification may result in a reduction in power demand, because electrically-powered accessories (such as the air compressor or power steering) operate only when needed if they are electrically powered, but they impose a parasitic demand all the time if they are engine-driven. In other cases, such as cooling fans or an engine’s water pump, electric power allows the accessory to run at speeds independent of engine speed, which can reduce power consumption. Electrification of accessories can individually improve fuel consumption, regardless of whether the drivetrain is a strong hybrid. Some vocational vehicle applications have much higher accessory loads than is assumed in the default GEM configurations. In the real world, there may be some vehicles for which there is a much larger potential improvement available than those listed above, as well as some for which electrification is not cost-effective. To date, accessory electrification has been associated only with hybrids, although CalStart commented they are optimistic that accessory electrification will become more widespread among conventional vehicles in the time frame of Phase 2.

Electric power steering (EPS) or Electrohydraulic power steering (EHPS) provides a potential reduction in CO2 emissions and fuel consumption over hydraulic power steering because of reduced overall accessory loads. This eliminates the parasitic losses associated with belt-driven power steering pumps which consistently draw load from the engine to pump hydraulic fluid through the steering actuation systems even when the wheels are not being turned. EPS is an enabler for all vehicle hybridization technologies since it provides power steering when the engine is off. EPS is feasible for most vehicles with a standard 12V system.

Some heavier vehicles may require a higher voltage system which may add cost and complexity.

Manufacturers wishing to obtain credit for technologies that are more effective than we have projected, or technologies beyond the scope of this defined technology improvement, may apply for off-cycle credits.

(vii) Tire Pressure Systems  
TPMS

The agencies did not propose to base the vocational vehicle standards on the performance of tire pressure monitoring systems (TPMS). However, we received comment that we should consider this technology. See discussion in Section III.D.1.b. In addition to comments related to tractors and trailers, RMA commented that TPMS can also apply to the class 2b–6 vehicles, and if the agencies add TPMS to the list of recognized technologies, that this choice should also be made available to class 2b–6 vehicles. Bendix commented that TPMS is a proven product, readily available from a number of truck, bus, and motor coach OEMs. Autocar commented that TPMS is useful for refuse truck applications. Tirestamp said that TPMS is ideal for trucks and buses that are unable to apply ATIS due to difficulties plumbing air lines externally of the axles. The agencies find these comments to be persuasive. As a result, we are finalizing vocational vehicle standards that are predicated on the performance of TPMS in all subcategories, including all custom chassis except emergency vehicles and concrete mixers. Available information indicates that it is feasible to utilize TPMS on all vocational vehicles, though systems for heavy vehicles in duty cycles where the air in the tires becomes very hot must be ruggedized so that the sensors are protected from this heat. Such devices are commercially available, though they cost more. To account for this in our analysis, we have

projected a lower adoption rate for TPMS in Urban vehicles than for Regional or Multipurpose vehicles, rather than by increasing the cost and applying an equal adoption rate. We are assigning a fixed improvement in GEM for use of this technology in vocational vehicles of one percent for Regional vehicles including motor coaches and RV’s (the same as for tractors and trailers) and 0.9 percent for Multipurpose, Urban, and other custom chassis vocational vehicles, recognizing that the higher amount of idle is likely to reduce the effectiveness for these vehicles. These values will be specified as GEM inputs in the column designated for tire pressure systems.

ATIS

The agencies did not propose to base the vocational vehicle standards on the performance of automatic tire inflation systems (ATIS), otherwise known as central tire inflation (CTI). However, we did receive comment indicating that it is feasible on some vocational vehicles. Air CTI commented that central tire inflation is not only feasible but enhances safety on vehicles such as dump trucks and heavy haul vehicles that need higher tire pressures under certain driving conditions, such as when loaded, but need lower tire pressures when running empty or operating off-road. Tirestamp commented that ATIS can be plumbed externally for trucks and buses, but such systems have a propensity for damage and Autocar has provided information about how much extra weight this plumbing adds to the chassis. ATA commented that some onboard air pressure systems may not be able to pressurize tires sufficiently for very heavy vehicles. The primary vocational vehicle standards are not predicated on any adoption of this because the agencies do not have sufficient information about which chassis will have an onboard air supply for purposes

<sup>430</sup> TIAX 2009, pp. 3–5.

of an air suspension or air brakes. ATIS would logically only be adopted for vehicles that already need an onboard air supply for other reasons. Comments received for custom chassis were supportive of standards predicated on ATIS for buses with air suspensions. These comments are again persuasive. As a result, we are basing the optional standards for refuse trucks, school buses, coach buses, and transit buses in part on the adoption of ATIS. Although many motor homes have onboard air supply for other reasons making ATIS technically feasible, it is sufficiently costly that it is not practically feasible. Furthermore, for the same reasons stated above about the disadvantages of installing external plumbing for ATIS on some trucks and buses, we have determined it is not feasible for emergency vehicles or concrete mixers. Nonetheless, we are allowing vocational vehicles including all custom chassis to obtain credit for the performance of ATIS through a GEM input with a fixed improvement of 1.2 percent for Regional vehicles including motor coaches and RV's (the same as for tractors and trailers) and 1.1 percent for Multipurpose, Urban, and other custom chassis vocational vehicles, recognizing that the higher amount of idle is likely to reduce the effectiveness for these vehicles. These values will be specified as GEM inputs in the column designated for tire pressure systems. See discussion in Section III.D.1.b for our reasoning behind this effectiveness value.

(viii) HFC Refrigerant From Cabin Air Conditioning (A/C) Systems

Manufacturers can reduce direct A/C leakage emissions by utilizing leak-tight components. EPA's HFC direct emission leakage standard is independent of the CO<sub>2</sub> vehicle standard. Manufacturers may choose components from a menu of leak-reducing technologies sufficient to comply with the standard, as opposed to using a test to measure performance. See 76 FR 57194. A discussion of comments regarding use of low global warming potential refrigerants and EPA's responses to those comments can be found in Section I.F of this Preamble.

In Phase 1, EPA adopted a HFC leakage standard to assure that high-quality, low-leakage components are used in each air conditioning system installed in HD pickup trucks, vans, and combination tractors (see 40 CFR 1037.115). We did not adopt a HFC leakage standard in Phase 1 for systems installed in vocational vehicles. In the final Phase 2 program, as proposed, EPA is extending the HFC leakage standard to all vocational vehicles. Beginning in the 2021 model year, vocational vehicle

air conditioning systems with a refrigerant capacity of greater than 733 grams must meet a leakage rate of 1.50 percent leakage per year and systems with a refrigerant capacity of 733 grams or lower meet a leakage standard of 11.0 grams per year. EPA has determined that an approach of having a leak rate standard for lower capacity systems and a percent leakage per year standard for higher capacity systems will result in reduced refrigerant emissions from all air conditioning systems, while still allowing manufacturers the ability to produce low-leak, lower capacity systems in vehicles which require them.

Research has demonstrated that reducing A/C system leakage is both highly cost-effective and technologically feasible. The availability of low leakage components is being driven by the air conditioning program in the light-duty GHG rule which began in the 2012 model year and the HD Phase 1 rule that began in the 2014 model year. The cooperative industry and government Improved Mobile Air Conditioning program has demonstrated that new-vehicle leakage emissions can be reduced by 50 percent by reducing the number and improving the quality of the components, fittings, seals, and hoses of the A/C system.<sup>431</sup> All of these technologies are already in commercial use and exist on some of today's systems, and EPA does not anticipate any significant improvements in sealing technologies for model years beyond 2021. However, EPA has recognized some manufacturers utilize an improved manufacturing process for air conditioning systems, where a helium leak test is performed on 100 percent of all o-ring fittings and connections after final assembly. By leak testing each fitting, the manufacturer or supplier is verifying the o-ring is not damaged during assembly (which is the primary source of leakage from o-ring fittings), and when calculating the yearly leak rate for a system, EPA will allow a relative emission value equivalent to a 'seal washer' to be used in place of the value normally used for an o-ring fitting, when 100 percent helium leak testing is performed on those fittings.

We received comments from CARB and Daimler in support of applying these leakage standards to vocational vehicles. Daimler specifically expressed support for excluding A/C systems used to cool the cargo area of trucks, as well as for allowing helium testing as a compliance option. Thus, we are adopting these provisions as proposed. EMA commented with concerns about

<sup>431</sup> Team 1-Refrigerant Leakage Reduction: Final Report to Sponsors, SAE, 2007.

the burden of certifying A/C systems that are installed by secondary manufacturers. Section V.D.2 discusses how we have addressed the concerns related to secondary manufacturers. We also received comments from RVIA asking for clarification whether the cargo area exclusion also applied to A/C units that cool the living space of recreational vehicles. In response, we are adding clarifying language to the regulations at 40 CFR 1037.115 excluding A/C systems that are not powered by the vehicle's propulsion engine.

The A/C system leakage control costs presented in the RIA Chapter 2.9 and 2.11 are applied to all heavy-duty vocational vehicles. EPA views these costs as minimal and the reductions of potent GHGs to be easily feasible and reasonable in the lead times provided by the final rules.

(b) Engine Technologies Considered in Vehicle Standard-Setting

Section II explains the technical basis for the agencies' proposed separate engine standards. The agencies are not predicating the vocational vehicle standards on different diesel engine technology packages than those presumed for compliance with the separate diesel engine standards. However, for each model year of the Phase 2 standards, the agencies are predicating the SI-powered vocational vehicle standards on a gasoline engine technology package that includes additional technologies beyond those presumed for compliance with the MY 2016 gasoline engine standard. Put another way, the stringency of certain of the vocational vehicle standards, and those for vehicles using SI engines in particular, reflect in part improvements in engine efficiency which are not measured in the engine standard or in engine certification.

The primary vocational vehicle standards vary depending on whether the engines powering those vehicles are compression-ignition or spark-ignition.<sup>432</sup> As in Phase 1, this is not the case for the custom chassis standards, because GEM uses a default engine that is the same for every regulated custom chassis type, regardless of the actual engine being installed. As described above in Section II, the Phase 2 vehicle certification tool, GEM, requires manufacturers certifying to the primary standards to enter specific engine performance data, where emissions and

<sup>432</sup> Specifically, EPA is adopting CO<sub>2</sub>, N<sub>2</sub>O, and CH<sub>4</sub> emission standards for new heavy-duty engines over an EPA specified useful life period (See Section II).

fuel consumption profiles will differ significantly depending on the engine's architecture.<sup>433</sup>

As explained in Section II.A.2, engines will continue to be certified over the FTP test cycle via direct testing, not GEM simulation. The FTP test cycle that is applicable for bare vocational engines is very different than the test cycles for vocational vehicles in GEM. The FTP is a very demanding transient cycle that exercises the engine over its full range of capabilities. In contrast, the cycles evaluated by GEM measure emissions over more frequently used engine operating ranges. The ARB Transient vehicle cycle represents city driving, and the highway cruise cycles measure engine operation that is closer to steady state. Each of these cycles is described in the RIA Chapter 3.4.2. A consequence of recognizing engine performance at the vehicle level is that further engine improvements (*i.e.* improvements measureable by duty cycles that more precisely represent driving patterns for specific subcategories of vocational vehicles) can be evaluated as components of a technical basis for a vocational vehicle standard.<sup>434</sup> For this reason, the agencies considered whether any different engine technologies should be included in the feasibility analysis for the vehicle standards (and potentially, in the standard stringency).

We did not propose to predicate any diesel vocational vehicle standard on additional engine technology, including engine waste heat recovery (WHR). We do not believe this technology would show significant benefit in vocational vehicle applications due to their driving cycles, which have fewer highway miles than tractors. Thus, the final vocational vehicle standards assume that diesel engines perform at the level of the certified engine configuration.

The agencies received extensive comment on our assessment of SI engine technologies, and how these could be included in the vocational vehicle technology packages. We predicated the proposed MY 2027 SI-powered vocational vehicle standards on additional friction reduction, for a 0.6 percent fuel efficiency improvement. UCS, EDF, NRDC, and ICCT ask the agencies to rely on the 2015 SwRI study suggesting 8 percent improvement is possible. UCS highlights packages #16 and #22 of the SwRI report for the

agencies' further consideration. These packages were assembled by SwRI to simulate the combined performance of engine technologies over some well-known vehicle drive cycles. Because none of the technical data referenced by these commenters provides information on how these technologies perform over the HD gasoline engine FTP test procedure, the agencies are considering these to be comments on the GEM-based vocational vehicle standards, not comments on the separate FTP-based SI engine standard. Please see Section II.D.2(b) of this Preamble for the agencies' response to comments on the stringency of the separate SI engine standard.

SwRI package #16 applies variable valve actuation and exhaust gas recirculation to a 3.5 liter V6 engine. SwRI package #22 applies stoichiometric direct gas injection, exhaust gas recirculation, dual cam phasers, and advanced friction reduction to a 6.2 liter V8 engine. All of the SwRI packages compare the future vehicle performance to a pre-Phase 1 baseline, thus counting all the improvements already presumed in the MY 2016 engine standard, so the delta between what the commenter seeks and what the agencies proposed is considerably less than initially appears (and than the commenter appeared to believe). The agencies' default SI engine map for setting the SI-powered vocational vehicle standards is a MY 2016 6.8 liter V8 engine. The RIA Chapter 2.9.1 presents the EPA default map that meets the MY 2016 engine standard. We are adhering to the proposed approach of recognizing SI engine improvements only in the vocational vehicle standard. In response to comments, the agencies are adopting final vehicle-level standards for SI-powered vocational vehicles that are predicated in part on adoption of cylinder deactivation in addition to the advanced friction reduction reflected in the proposal, both of which have incremental costs beyond those needed to meet the separate FTP-based engine standard, and both of which will be recognized over the GEM vehicle cycles. Indeed, cylinder deactivation would not be expected to be recognized at all over the engine FTP cycle (another reason the improvement is reflected in the final vehicle standard). As proposed, the effectiveness and adoption rate of Level 2 engine friction reduction yields a fuel efficiency improvement of 0.6 percent. By adding 30 percent adoption of cylinder deactivation with a vehicle-cycle average effectiveness of 1 percent, and accounting for a dis-synergy factor

of 0.9, this yields an overall package effectiveness of 0.8 percent. Upon consideration of comments and the data in the SwRI reports, we are not including EGR as a technology for stringency purposes. EGR is potentially feasible, is not already presumed to be adopted in the 2016 engine standard, and may possibly be recognized over the GEM vehicle cycles to some extent. However, we did not have sufficient data to confidently project an effectiveness or adoption rate for this technology on vocational SI engines. Further, the Phase 2 HD pickup truck and van standards are not predicated on any adoption of EGR technologies for SI vehicles. The RIA Chapter 2.9.1 describes how each of the SI engine technologies are expected to perform over the GEM vehicle cycles, as well as the method for projecting that the fuel efficiency improvement will be 0.8 percent compared to the baseline SI vehicle performance.

With respect to standards for engines used in custom chassis, we understand that engines designed for heavy-duty emergency vehicles are generally higher-emitting than other engines. However, because we are maintaining a separate engine standard and regulatory flexibility such as ABT, fire apparatus manufacturers will be able to obtain engines that, on average, meet the Phase 2 engine standards. The agencies further recognize that the engine map inputs to GEM in the primary program could pose a difficulty for emergency vehicle manufacturers. If we required engine-specific inputs then these manufacturers will have to apply extra vehicle technologies to compensate for the necessary but higher-emitting engine. The agencies are therefore not recognizing vehicle-specific engine performance as part of the vehicle standard for emergency vehicles (although the standards for emergency vehicles and custom chassis do presume use of a certified Phase 2 engine). Manufacturers of these vehicles must install an engine that is certified to the applicable separate Phase 2 engine standard. However, under the custom chassis program emergency vehicle manufacturers need not follow the otherwise applicable Phase 2 approach of entering an engine map in GEM. Instead, use of a custom chassis subcategory identifier will instruct GEM to simulate the vehicle using an EPA default engine.

<sup>433</sup> See Section II.D.5 for an explanation of which engine architecture will need to meet which standard.

<sup>434</sup> As noted in Section II.B.2 above, manufacturers also have greater flexibility to meet a vehicle standard if engine improvements can be evaluated as part of compliance testing.

## (c) Technologies the Agencies Assessed But Did Not Use In Standard-Setting

## (i) Aerodynamics

The agencies did not propose to include aerodynamic improvements as a basis for the Phase 2 vocational vehicle standards. However, we did request comment on an option to allow credits for use of aerodynamic devices such as fairings on a very limited basis. We received public comments from AAPC in support of offering this as an optional credit, with a suggestion to allow this option for a wide range of vehicle sizes, and suggesting that the grams per ton-mile benefit could be scaled down for larger vehicles. CARB commented in support of a Phase 2 program that would include use of aerodynamic improvements as a basis for the stringency, suggesting that a large fraction of the vocational vehicle fleet could see real world benefits from use of aerodynamic devices. Because we do not have sufficient fleet information to establish a projected application rate for this technology, we are not basing any of the final standards for vocational vehicles on use of aerodynamic improvements. See 80 FR 40303. In consideration of comments, however, we are adopting provisions for vocational vehicles to optionally receive an improved GEM result by certifying use of a pre-approved aerodynamic device, and are expanding eligibility criteria from the relatively narrow criteria proposed.

Based on testing supported by CARB, the agencies have developed a list of specific aerodynamic devices with pre-defined improvement values (in delta  $C_{DA}$  units), as well as criteria regarding which vehicles are eligible to earn credit in this manner. See Chapter 2.9.4.1 of the RIA. In response to comments, we are allowing a wide range of vehicles to be eligible to use this option. Regional vocational vehicles in any weight class may use this option, subject to restrictions on the size of the chassis (see 40 CFR 1037.520). The degree of change in  $C_{DA}$  for each pre-approved device has been set at conservative values due to the small number of configurations tested and the uncertainty inherent in those results. Manufacturers wishing to receive credit for other aerodynamic technologies or on other vehicle configurations may seek credit using the test procedures described in 40 CFR 1037.527. Manufacturers using this credit provision may enter the pre-defined delta  $C_{DA}$  as an input to GEM, and the simulation will determine the effectiveness over the duty cycle. Using this approach, we do not need to set a

scaled benefit for different sizes of vehicles. When the vehicle weight class and duty cycle is specified, a default chassis mass and payload are simulated in GEM. When the pre-defined delta  $C_{DA}$  is entered, the simulation returns a resulting improved performance with respect to the specified chassis configuration. GEM will logically return a smaller improvement for heavier vehicles.

The final Regional composite duty cycle in GEM for vocational vehicles has a weighted average speed of 38 mph, increased from the average speed at proposal due to a heavier 56 percent composite weighting of the 65 mph drive cycle. The agencies have learned from the NREL duty cycle analysis that vocational vehicles with operational behavior of a regional nature accumulate more miles at highway speeds than previously assumed.

Using GEM simulation results, the agencies estimate the fuel efficiency benefit of improving the  $C_{DA}$  of a Class 6 box truck by 11 percent (0.6 m<sup>2</sup> delta  $C_{DA}$  off of a default of 5.4 m<sup>2</sup>) at approximately five percent over the Regional composite test cycle. This same delta  $C_{DA}$  simulated in GEM on a class 8 Regional vocational vehicle results in an overall improvement of less than four percent because the default  $C_{DA}$  in GEM for class 8 vocational vehicles is 6.86 m<sup>2</sup> so the change in  $C_{DA}$  is only nine percent. Although in actual operation the added weight of aerodynamic fairings may reduce the operational benefits of these technologies when driving at low speeds, the agencies are not applying any weight penalty as part of the certification process for vocational aerodynamic devices.

As described in the NPRM, we are requiring chassis manufacturers employing this option to provide assurances to the agencies that these devices will be installed as part of the certified configuration, even if the installation is completed by another entity. We received many comments on the requirements for secondary manufacturers as they apply for vocational aerodynamics as well as other technologies that may be specified by a chassis manufacturer but installed later. See Section I.F.2 and Section V.D.2 for further discussion of delegated assembly issues.

## (ii) Full Electric Trucks

Given the high up-front costs and the developing nature of this technology, the agencies do not project fully electric vocational vehicles to be widely commercially available in the time frame of the final rules. For this reason,

the agencies have not based the Phase 2 standards on adoption of full-electric vocational vehicles. We received many comments on electric trucks and buses. Specifically, EEI provided information on the total cost of ownership for electric trucks, and some applications may see attractive long term cost scenarios for electric trucks or buses, when considering maintenance savings. While we are not predicating the final vocational vehicle standards on adoption of full electric trucks or buses, we have reinstated an advanced technology credit multiplier, in response to comment. See Section I.C.1.(b) for a discussion of credit multipliers.

To the extent this technology is able to be brought to market in the time frame of the Phase 2 program, there is currently a certification path for these chassis from Phase 1, as described in EPA's regulations at 40 CFR 1037.150 and NHTSA's regulations at 49 CFR 535.8.

## (iii) E-PTO

Although the primary program does not simulate vocational vehicles over a test cycle that includes PTO operation, the agencies are adopting a revised hybrid-PTO test procedure. See 76 FR 57247 and 40 CFR 1037.540. Recall that we regulate vocational vehicles at the incomplete stage when a chassis manufacturer may not know at the time of certification whether a PTO will be installed or how the vehicle will be used. Chassis manufacturers may rarely know whether the PTO-enabled vehicle will use this capability to maneuver a lift gate on a delivery vehicle, to operate a utility boom, or merely to keep it as a reserve item to add value in the secondary market. For these reasons, it would not be fair to require every vocational vehicle to certify to a standard test procedure with a PTO cycle in it. Thus, we are not basing the final standards on use of technology that reduces emissions in PTO mode.

There are products available today that can provide auxiliary power, usually electric, to a vehicle that needs to work in PTO mode for an extended time, to avoid idling the main engine. There are different designs of electrified PTO systems on the market today. Some designs have auxiliary power sources, typically batteries, with sufficient energy storage to power an onboard tool or device for a short period of time, and are intended to be recharged during the workday by operating the main engine, either while driving between work sites, or by idling the engine until a sufficient state of charge is reached that the engine may shut off. Other designs have



sufficient energy storage to power an onboard tool or device for many hours, and are intended to be recharged as a plug-in hybrid at a home garage. In cases where a manufacturer can certify that a PTO with an idle-reduction technology will be installed either by the chassis manufacturer or by a second stage manufacturer, the hybrid-PTO test cycle may be utilized by the certifying manufacturer to measure an improvement factor over the GEM duty cycle that otherwise applies to that vehicle. In addition, the delegated assembly provisions will apply (see Section V.D). See RIA Chapter 3.7.4 for a discussion of the revisions to the PTO test cycle.

The agencies will continue the hybrid-PTO test option that was available in Phase 1, with a few revisions. See the regulations at 40 CFR 1037.540. The calculations recognize fuel savings over a portion of the test that is determined to be charge-sustaining as well as a portion that is determined to be charge-depleting for systems that are designed to power a work truck during the day and return to the garage where recharging from an external source occurs during off-hours. The agencies requested comment on this idea, and received comment from Odyne relating to the population and energy storage capacity of plug-in e-PTO systems, for which a charge-depleting test cycle may be more appropriate. We also partnered with DOE-NREL to characterize the PTO operation of over 80 trucks with over 1,500 total operating days, and our final regulations include a utility factor table based on these data for use in determining the effectiveness of a hybrid PTO system.<sup>435</sup> Manufacturers wishing to conduct testing as specified may apply for off-cycle credits derived from e-PTO or hybrid PTO technologies.

## (2) Projected Vehicle Technology Package Effectiveness and Cost

### (a) Baseline Vocational Engine and Vehicle Performance

The baseline vocational vehicle configurations for each of the nine regulatory subcategories for CI-powered and six SI-powered vehicles are described in RIA Chapter 2.9.1, as well as the seven baseline custom chassis configurations. The agencies set the baseline rolling resistance coefficient for the 2017 vocational vehicle fleet at 7.7 kg/metric ton, which assumes that 100 percent of tires meet the Phase 1 standard.

In the agencies' Phase 2 baseline configurations, we need to specify transmission type, gear number, and gear ratios, as well as axle ratios and tire sizes because these were all defaults in Phase 1. Phase 1 GEM modeled all vehicles with a manual transmission, but as explained elsewhere, the majority of vocational vehicles in today's U.S. fleet have automatic transmissions. By specifying a mix of manual and automatic transmissions with different sets of gears in the baseline, we are not applying technology beyond what is needed to comply with Phase 1, we are merely defining an appropriate set of baselines. We do not consider these specifications to represent technology that improves fuel efficiency beyond Phase 1, it is merely a better representation of today's fleet than the Phase 1 GEM that had 100 percent default manual transmissions. In the Regional HHD diesel subcategory, the baseline is a weighted average of two vehicle specs: 95 percent being a 455 hp engine paired with a manual transmission with ten forward gears, and five percent being a 350 hp engine paired with a 6-speed automatic transmission. The HHD Multipurpose subcategory is a weighted average of three vehicle specs: 80 percent being a 350 hp engine paired with a 6-speed automatic transmission, 10 percent being a 455 hp engine paired with a 10-speed manual transmission, and 10 percent being a 350 hp engine paired with a 10-speed manual. The automatic transmissions specified in the LHD, MHD, and HHD Regional and Multipurpose subcategories have six forward gears in the baseline, while automatic transmissions in the Urban subcategories have five forward gears in the baseline. This is based on market research, stakeholder outreach, and comments received on the NODA. No vehicle-level efficiency-improving technology is included in the baseline vehicles, nor in the agencies' analyses for the no-action reference case. Specifically, we have assumed zero adoption rates for other types of transmissions, other numbers of gears, idle reduction, and technologies other than Phase 1 compliant LRR tires in both the nominally flat baseline and the dynamic baseline reference cases. Technology adoption rates for Alternative 1a (nominally flat baseline) can be found in the RIA Chapter 2.11. Chapter 2.11.8 presents the adoption rates for tires on vocational vehicles with different levels of rolling resistance, including the 100 percent

adoption rate of tires with Level 1 CRR in the reference case and in model years preceding Phase 2. In this manner, we have defined a reference vocational vehicle fleet that meets the Phase 1 standards and includes reasonable representations of vocational vehicle technology and configurations.

The agencies note that the baseline performance derived for the final rules varies between regulatory subcategories—as noted above, this is one of the reasons the agencies are adopting multiple subcategories with discrete standards. The range of performance at baseline is due to the range of attributes and modeling parameters, such as transmission characteristics, final drive ratio, and vehicle weight, which were selected to represent a range of performance across this diverse segment. The agencies received persuasive comment regarding the appropriateness of the baseline configurations, and have made revisions accordingly. For example, we have reduced the LHD default aerodynamic drag area from 5.4 to 3.4 square meters. We are confident these adequately represent a reasonable range of vocational chassis configurations currently manufactured in the US. Details of the vehicle configurations, including reasons why they are reasonably included as baseline technologies, are discussed in the RIA Chapter 2.9.2.

At proposal the agencies adjusted the vocational vehicle GEM numerical baselines using assumptions about the sales mix in the vocational fleet before applying the reductions from technologies. 80 FR 40308. In this process, we developed proposed baseline values that we believed would minimize inappropriate incentives for manufacturers to certify chassis in an inappropriate subcategory. The proposed approach included testing each baseline vehicle over all three duty cycles and applying weighted average adjustments to each GEM output to create normalized baselines, 80 FR 40308. We received adverse comment on this approach from many commenters—indeed, no commenter supported this “normalization” approach. The proposed normalization approach was an attempt to adjust for instances where the agencies' information on baseline configurations was not fully complete. Most commenters either opposed or were confused by the proposed normalization process. As explained in this Section V., the agencies are adopting final standards for vocational vehicles using the same methodology as for all the other standards in this rulemaking, and

<sup>435</sup> National Renewable Energy Laboratory July 2016, “Characterization of PTO and Idle Behavior for Utility Vehicles,” NREL/TP-5400-66747.



so are neither normalizing nor equalizing any of the data relating to either the baseline or the standard. (Equalization is discussed separately in Section V.C.(2)(d) below.) The agencies have received a great deal of information from manufacturers since proposal which rectify weaknesses in our baselines, and make any normalization unnecessary.<sup>436</sup> In the final rules we have applied other methods (chiefly certain equipment-based constraints) to avoid creating inappropriate incentives for manufacturers to certify chassis in inappropriate subcategories. The final standards are calculated by applying improvements as described below in

Section V.C.(2)(c) to the GEM results presented in Table V-17 and Table V-18—the same methodology as used to develop the other Phase 2 standards.

Diesel engines used in vocational vehicles can be either Light, Medium, or Heavy Heavy-duty Diesel engines. The Light Heavy-duty Diesel engines typically range between 4.7 and 6.7 liters displacement. The Medium Heavy-duty Diesel engines typically have some overlap in displacement with the Light Heavy-duty Diesel engines and range between 6.7 and 9.3 liters. The Heavy Heavy-duty Diesel engines typically are represented by engines between 10.8 and 16 liters. Because of these differences, the GEM simulation of

baseline vocational CI engines includes four engines—one for LHD, one for MHD, and two for HHD. Detailed descriptions can be seen in Chapter 4 of the RIA. These four engine models have been employed in setting the vocational vehicle baselines, as described in the RIA Chapter 2.9.1.

The four baseline diesel engines represent fuel consumption improvements beyond currently available engines to achieve the performance level of a 2017 model year diesel engine, as described in the RIA Chapter 2.9.1. Using the values for compression-ignition engines, the baseline performance of vocational vehicles is shown in Table V-17.

TABLE V-17—BASELINE VOCATIONAL VEHICLE PERFORMANCE WITH CI ENGINES

Duty cycle	Light heavy-duty Class 2b-5	Medium heavy-duty Class 6-7	Heavy heavy-duty Class 8
<b>Baseline Emissions Performance in CO<sub>2</sub> gram/ton-mile</b>			
Urban .....	482	332	338
Multi-Purpose .....	420	294	287
Regional .....	334	249	220
<b>Baseline Fuel Efficiency Performance in gallon per 1,000 ton-mile</b>			
Urban .....	47.3477	32.6130	33.2024
Multi-Purpose .....	41.2574	28.8802	28.1925
Regional .....	32.8094	24.4597	21.6110

The agencies have developed a model in GEM of a MY 2016-compliant gasoline engine. The agencies received comments on the process for mapping gasoline engines for simulation purposes, as well as information about the power rating and displacement that should be considered as a baseline SI engine for vocational vehicle standard-setting purposes. Upon consideration of comments, and based on information obtained through testing at Southwest Research (see Chapter 5.5 of the SwRI report), we are adopting revised test procedures as described in the RIA Chapter 3.1 that apply for mapping of both SI and CI engines.<sup>437</sup>

The baseline performance levels for vocational vehicles powered by SI engines were derived using the EPA default fuel map described in the RIA Chapter 2.9.1, for a 6.8 liter, V-8, 300 hp engine. We have used the same

engine rating and map for all weight classes of SI vocational vehicles. This is because SI engines are not certified with a regulatory structure that calls for declaring an intended service class that is associated with a vehicle weight class. The agencies requested comments on the merits of setting distinct numerical standards for HHD vocational vehicles powered by SI engines, as well as comments on an alternative approach that would have required any class 8 SI vocational vehicles to certify to the standards for CI powered HHD vocational vehicles, or to the MHD standards for SI vocational vehicles. In response to comments expressing concern about orphaned vehicles as well as concerns about mismatched engine and vehicle useful life, the agencies are not finalizing distinct HHD SI vocational vehicle standards. We are finalizing six subcategories for SI

vocational vehicles: Three LHD and three MHD. Where a manufacturer wishes to certify a gasoline SI vocational vehicle with a GVWR over 33,000 lbs, the final regulations allow that vehicle to be certified in one of the MHD vehicle subcategories. Where a manufacturer wishes to certify an alternative-fueled vocational vehicle with a GVWR over 33,000 lbs, the regulations at 40 CFR 1036.108 specify whether that vehicle should be treated as SI or CI for purposes of certification to the final Phase 2 standards. See Section II.D.5 of this Preamble for a discussion of these provisions.

Table V-18 presents the baseline performance level for each weight class computed by GEM by calculating the work done by the default engine to move the GEM reference vehicles over the test cycles.

<sup>436</sup> See memorandum dated July 2016 titled, "Summary of Comments on Vocational Vehicle Baselines," see Docket EPA-HQ-OAR-2014-0827.

<sup>437</sup> Michael Ross, Validation Testing for Phase 2 Greenhouse Gas Test Procedures and the Greenhouse Gas Emission Model (GEM) for Medium

and Heavy-Duty Engines and Powertrains, Final Report to EPA, Southwest Research Institute, June 2016.

TABLE V-18—BASELINE VOCATIONAL VEHICLE PERFORMANCE WITH SI ENGINES

Duty cycle	Light heavy-duty Class 2b-5	Medium heavy-duty Class 6-7 (and Gasoline c8) <sup>a</sup>
<b>Baseline Emissions Performance in CO<sub>2</sub> gram/ton-mile</b>		
Urban .....	502	354
Multi-Purpose .....	441	314
Regional .....	357	275
<b>Baseline Fuel Efficiency Performance in gallon per 1,000 ton-mile</b>		
Urban .....	56.4870	39.8335
Multi-Purpose .....	49.6230	35.3325
Regional .....	40.1710	30.9441

**Note:**

<sup>a</sup> Vocational vehicles with GVWR over 33,000 lbs powered by alternate fueled engines must certify to the vehicle standard corresponding with the applicable engine standard.

(b) Technology Packages for Derivation of Final Standards

Prior to developing the numerical values for the final standards, the agencies projected the mix of new technologies and technology improvements that will be feasible within the available lead time. We note that for some technologies, the adoption rates and effectiveness may be very similar across subcategories. However, for other technologies, either the adoption rate, effectiveness, or both differ across subcategories. Where a technology performs differently over different test cycles, these differences are reflected in the derivation of the stringency of the standard. As discussed in Section I.C.1, we assume manufacturers will incorporate appropriate compliance margins for all measured GEM inputs. In other words, they will declare values slightly higher than their measured values. As discussed in Section II.D.5, compliance margins associated with fuel maps are likely to be approximately one percent. For tire rolling resistance, our feasibility rests on the Phase 1 standards, consistent with our expectation that manufacturers will continue to incorporate the compliance margins they considered necessary for Phase 1. With respect to optional axle and/or transmission power loss maps, we believe manufacturers will need very small compliance margins. These power loss procedures require high precision so measurement uncertainty will likely be on the order of 0.1 percent of the transmitted power. All of these margins are reflected in our projections of the emission levels that will be technologically feasible, as well as the associated costs.

In the package descriptions that follow, individual technology costs are

not presented, rather these can be found in the RIA Chapter 2.9 and 2.11. Section V.C.(2)(d) includes the costs estimated for packages of technologies the agencies project can be applied to vocational vehicles to meet the final Phase 2 standards.

(i) Transmission Packages

The agencies project an adoption rate of 50 percent in MY 2021, 60 percent in MY 2024, and nearly 70 percent in MY 2027 of transmissions with improved gear efficiencies, with inputs over-riding the GEM defaults obtained over the separate transmission efficiency test. We are projecting an adoption rate of 10 percent in MY 2021, 20 percent in MY 2024, and nearly 30 percent in MY 2027 of advanced shift strategies, with demonstration of improvements recognized over the separate powertrain test.

We are predicating the Phase 2 standards on zero adoption of added gears in the HHD Regional subcategory, because it is modeled with a 10-speed transmission, and vehicles already using that number of gears are not expected to see any real world improvement by increasing the number of available gears. For the Multipurpose and Urban HHD subcategories, the MY 2021 projected adoption of adding gears is 5 percent, increasing to 10 percent for MY 2024 and MY 2027. We are projecting 10 percent of adding two gears in each of the other six subcategories for MY 2021, increasing to 20 percent for MY 2024 and MY 2027. Commenters supported the inclusion of this technology as part of the basis for the standards. Allison commented that they have configured an 8-speed vocational transmission. Eaton's new MHD dual clutch transmission has seven forward gears. There is also a likelihood that suppliers of 8-speed transmissions for HD pickups

and vans may sell some into the LHD vocational vehicle market.

We are also predicating the optional custom chassis standards for school and coach buses in part on adoption of transmissions with additional gears. In MY 2021, this adoption rate is five percent, increasing to 10 percent in MY 2024 and 15 percent in MY 2027. Manufacturers who certify these vehicles to the primary standards will use GEM to model the actual gears and gear ratios; however, manufacturers using custom chassis regulatory subcategory identifiers will not have this flexibility. The agencies have estimated the cycle-average benefit of adding an extra gear for school buses (modeled as MHD Urban vehicles) at 0.9 percent and coach buses (with 6 gears in the baseline) at 1.7 percent; therefore, manufacturers using custom chassis regulatory subcategory identifiers for these vehicles will be permitted to enter these pre-defined improvement values at the time of certification.

Based on comment regarding our regulatory baselines, both the HHD Regional and HHD Multipurpose subcategories now have manual transmissions in the baseline configuration. For these vehicles, the agencies project upgrades to automated transmissions such as either AMT, DCT, or automatic, at an adoption rate of 30 percent in MY 2021, 50 percent in MY 2024, and 80 percent in MY 2027 for Regional vehicles. For Multipurpose, beginning with 20 percent manuals in the baseline, the adoption rate of automated transmissions is five percent in MY 2021 and 20 percent in MY 2024. Consistent with our projections of technology adoption, the regulations require that any vocational vehicles with manual transmissions must be certified as Regional in MY 2024 and beyond. This progression of

transmission automation is consistent with the agencies' projection of 10 percent manuals and 90 percent automated transmissions in the day cab tractor subcategories in MY 2027. See Table III-13. HHD vocational vehicles in regional service have many things in common with day cab tractors, including the same assumed engine size and typical transmission type, and a similar duty cycle. Thus, it is reasonable for the agencies to make similar projections about the fraction of automated vs manual transmissions adopted over the next decade among these sectors. Also consistent with tractors, GEM simulates each of these with a two percent fixed effectiveness improvement over the performance of the MT in the baseline. To the extent any of these transmissions provide additional effectiveness over the GEM cycles with actual OEM data entered, it is not considered in the stringency of the vocational vehicle HHD Regional standard (but would be recognized at certification). The agencies have been unable to characterize the relative effectiveness of DCT compared with AT sufficiently to apply it as a technology on which stringency is predicated. This is consistent with the public comment on this issue: Daimler did not support inclusion of DCT as a technology with different effectiveness than AMT, and Allison did not support treatment of either DCT or AMT as different as AT.

In the seven subcategories (*i.e.* all of the remaining subcategories) in which automatic transmissions are the base technology, the agencies project that ten percent of the HHD vehicles will apply an aggressive torque converter lockup strategy in MY 2021, and 30 percent in the LHD and MHD subcategories. These adoption rates are projected to increase to 20 percent for HHD and 40 percent for LHD and MHD in MY 2024. We project adoption of aggressive torque converter lockup for HHD automatics of 30 percent in MY 2027, and 50 percent for LHD and MHD.

In setting the standard stringency, we have projected that non-integrated (bolt-on) mild hybrids will not have the function to turn off the engine at stop, while the integrated mild hybrids will have this function. The agencies have estimated the effectiveness for vehicles certified in the Urban subcategories will achieve as much as 13 percent improvement, and integrated systems that turn off at stop will see up to 21 percent improvement depending on the subcategory. We have also projected zero hybrid adoption rate (mild or otherwise) by vehicles in the Regional subcategories, expecting that the benefit of hybrids for those vehicles will be too

low to merit use of that type of technology. However, there is no fixed hybrid value assigned in GEM and, for any vehicles utilizing hybrid technology, the actual improvement over the applicable test cycle will be determined by powertrain testing, which would likely reflect some benefit of hybrids on Regional vehicles. By the full implementation year of MY 2027, the agencies are projecting an overall vocational vehicle adoption rate of 12 percent mild hybrids, which we estimate will be 14 percent of vehicles certified in the Multi-Purpose and Urban subcategories (six percent integrated and eight percent non-integrated). We are projecting a low adoption rate in the early years of the Phase 2 program, zero integrated hybrid systems and two percent of the bolt-on systems in these subcategories in MY 2021, and three percent integrated mild hybrids in MY 2024 for vehicles certified in the Multi-Purpose and Urban subcategories, plus 5 percent non-integrated mild hybrids in MY 2024. Based on our assumptions about the populations of vehicles in different subcategories, these hybrid adoption rates are about two percent overall in MY 2021 and six percent overall in MY 2024.

Navistar commented with concerns that the agencies may be double counting some of the improvements of deep integration. For example, the addition of a gear to a transmission may reduce the added benefit of deep integration, as the transmission may already achieve a more optimal operation state more often due to the greater number of gears. The agencies have been careful to project adoption rates and effectiveness of transmission technologies in a way that that avoids over-estimating the achievable reductions. For example, as we developed the packages, we reduced the adoption rate of advanced shift strategy by the adoption rate of integrated hybrids, and we reduced the adoption rate of transmission gear efficiency by the amount of non-integrated hybrids. This is because we do not project that any driveline will undergo testing over both the powertrain test and the separate transmission efficiency test. Because we have projected adoption of combinations of transmission technologies in some subcategories, the sum of adoption rates of individual transmission technologies may exceed 100 percent in some cases. However, the effectiveness values have not been summed because we agree with the commenter that we should not double count benefits. Instead of summing the

combined efficiencies, we combine multiplicatively as described in Equation V-1, below. Thus, we have fairly accounted for dis-synergies of effectiveness where multiple technologies are applied to a similar vehicle system.

Custom chassis manufacturers have provided compelling comment that the absence of recognition in the certification process of improved transmission technology will not deter them from its adoption. Therefore, although some types of improved transmissions are feasible for some custom chassis, these vehicles are typically assembled from off-the-shelf parts in low production volumes. For most components, this is not a significant obstacle. However, this dynamic can limit their access to the most advanced transmission technologies. Transmission manufacturers would generally be willing to supply advanced transmissions they developed for a larger customer, but would be less likely to invest in developing a special low volume transmission for the custom chassis. Similar circumstances would apply for hybrids. Further, for the reasons described above about non-representative drivelines in the baseline configurations, we believe that allowing these to be certified with a default driveline is a reasonable program structure. For school buses and others, if a manufacturer wishes to be recognized beyond the levels described for adopting improved transmissions, it has the option of certifying to the primary standards. Nevertheless, technology improvements that some of these manufacturers will include based on market forces (after they have been introduced into the market as a result of the primary program) will likely result in actual in-use improvements for many these vehicles beyond what is projected by the standards.

(ii) Axle Packages

The agencies project that 10 percent of vocational vehicles in all subcategories will adopt high efficiency axles in MY 2021, 20 percent in MY 2024, and 30 percent in MY 2027. Fuel efficient lubricant formulations are widespread across the heavy-duty market, though advanced synthetic formulations are currently less popular.<sup>438</sup> Axle lubricants with improved viscosity and efficiency-enhancing performance are projected to

<sup>438</sup> See meeting log for proposed rule, specifically the April 2014 meeting with Dana. <https://www.regulations.gov/document?D=EPA-HQ-OAR-2014-0827-0702>

be widely adopted by manufacturers in the time frame of Phase 2. Such formulations are commercially available and the agencies see no reason why they could not be feasible for most vehicles. Nonetheless, we have refrained from projecting full adoption of this technology. The agencies do not have specific information regarding reasons why axle manufacturers may specify a specific type of lubricant over another, and whether advanced lubricant formulations may not be recommended in all cases. The agencies received adverse comment on allowing fixed credit for use of high efficiency axles, whether from lubrication or other mechanical designs. In response, we are adopting a separate axle efficiency test, which can be used as an input to GEM to over-ride default axle efficiency values. The low overall adoption rate indicates that we expect axle suppliers to only offer high-efficiency axles for their most high production volume products, especially those that can serve both the tractor and vocational market. Therefore, we believe it is unlikely that high-efficiency axles will be adopted in custom chassis applications. Because we are no longer offering a fixed improvement for this technology as at proposal, this is only available for vocational vehicles that are certified to the primary program.

The agencies estimate that 10 percent of HHD Regional vocational vehicles and five percent of HHD Multipurpose vehicles will adopt part time 6x2 axle

technology in MY 2021. This technology is most likely to be applied to Class 8 vocational vehicles (with 2 rear axles) that are designed for frequent highway trips. The agencies project a 20 percent adoption rate for HHD Regional and 15 percent adoption rate for HHD Multipurpose for part time 6x2 axle technologies in MY 2024. In MY 2027, we project 30 percent adoption of part time 6x2 for HHD Regional and 25 percent for HHD Multipurpose. We are establishing a custom chassis baseline configuration for coach buses with a 6x2 axle, in consideration of comments from UCS and manufacturers stating this is the standard axle configuration for these vehicles. If a HHD coach bus is sold with a 6x4 or part time 6x2 axle, the manufacturer must enter the as-built axle configuration as a GEM input. This is true whether the vehicle is in the primary program or if it is certified to the custom chassis standard. Because the optional custom chassis standard assumes a 6x2 axle in the coach bus baseline, manufacturers may only qualify to obtain a reduced GEM result from use of the 300 pound weight reduction value (specified in 40 CFR 1037.520 associated with use of a permanent 6x2 axle) when certifying coach buses to the primary standards.

(iii) Tire Packages

The agencies estimate that the per-vehicle average level of rolling resistance from vocational vehicle tires could be reduced by up to 13 percent for many vehicles by full implementation of

the Phase 2 program in MY 2027, based on broader adoption of vocational vehicle tires currently available. We estimate this will yield reductions in fuel use and CO<sub>2</sub> emissions of up to 3.3 percent for these vehicles. All of our estimates of vehicle-level tire CRR improvements employ a weighted average using an assumed axle load distribution of 30 percent on the steer tires and 70 percent on the drive tires, as was proposed.<sup>439</sup> The projected adoption rates of tires with improved CRR for chassis in the primary program are presented in Table V–19. The levels noted in the table are defined above in Table V–15. By applying the assumed axle load distribution, the estimated vehicle CRR improvement projected as part of the MY 2021 standards ranges from 5 to 8 percent, which we project will achieve up to 1.9 percent reduction in fuel use and CO<sub>2</sub> emissions, depending on the vehicle subcategory. The agencies estimate the vehicle CRR improvement in MY 2024 will range from 5 to 13 percent, yielding reductions in fuel use and CO<sub>2</sub> emissions up to 3.2 percent, depending on the vehicle subcategory.

The agencies believe that these tire packages recognize the variety of tire purposes and performance levels in the vocational vehicle market, and maintain choices for manufacturers to use the most efficient tires (*i.e.* those with lowest rolling resistance) only where it makes sense given these vehicles' differing purposes and applications.

TABLE V–19—PROJECTED LRR TIRE ADOPTION RATES

	Regional		Multipurpose		Urban	
	Steer	Drive	Steer	Drive	Steer	Drive
2021 HHD	100% LRR 5v ..	100% LRR 2v ..	100% LRR 5v ..	100% LRR 2v ..	100% LRR 4v ..	100% LRR 1v.
2021 MHD	100% LRR 3v ..	100% LRR 1v ..	100% LRR 3v ..	100% LRR 1v ..	100% LRR 3v ..	100% LRR 1v.
2021 LHD	100% LRR 3v ..	100% LRR 3v ..	100% LRR 3v ..	100% LRR 3v ..	100% LRR 2v ..	100% LRR 2v.
2024 HHD	100% LRR 5v ..	100% LRR 3v ..	100% LRR 5v ..	100% LRR 2v ..	100% LRR 4v ..	100% LRR 1v.
2024 MHD	100% LRR 5v ..	100% LRR 3v ..	100% LRR 3v ..	50% LRR 1v, 50% LRR 2v	100% LRR 3v ..	100% LRR 1v.
2024 LHD	100% LRR 5v ..	100% LRR 3v ..	100% LRR 3v ..	100% LRR 3v ..	100% LRR 2v ..	100% LRR 2v.
2027 HHD	100% LRR 5v ..	100% LRR 3v ..	100% LRR 5v ..	100% LRR 3v ..	100% LRR 5v ..	100% LRR 2v.
2027 MHD	100% LRR 5v ..	100% LRR 3v ..	100% LRR 5v ..	100% LRR 3v ..	100% LRR 3v ..	50% LRR 1v, 50% LRR 2v.
2027 LHD	100% LRR 5v ..	100% LRR 3v ..	100% LRR 5v ..	100% LRR 3v ..	100% LRR 3v ..	50% LRR 2v, 50% LRR 3v.

Table V–20 presents the projected adoption rates of LRR tires for custom chassis. As noted above in Section V.C.(1)(a)(iii), the adoption rates generally represent improvements in the range of the 25th to 40th percentile using data from actual vehicles in each application that were certified in MY

2014. A summary of these data is provided in a memorandum to the docket.<sup>440</sup> An exception to this is emergency vehicles. The final emergency vehicle standards reflect adoption of tires that progress to the 50th percentile by MY 2027, using steer and drive tire data for certified

emergency vehicles. At these adoption rates, manufacturers need not change any of the tires they are currently fitting on emergency vehicles, and they will comply on average.

<sup>439</sup> See Vehicle Valuation Services Quick Reference Guide, available at <http://www.vvsi.com/training/TrainingGuide.pdf>, (accessed June 2014),

the draft RIA at Chapter 2.9.2, and Docket ID EPA–HQ–OAR–2014–0827–0434.

<sup>440</sup> See memorandum on tire data, Note 419, above.

TABLE V-20—PROJECTED LRR TIRE ADOPTION RATES FOR CUSTOM CHASSIS

	MY 2021		MY 2027	
	Steer	Drive	Steer	Drive
Coach .....	100% LRR 4v.	100% LRR 4v.	100% LRR 5v.	100% LRR 5v.
RV .....	100% LRR 5v.	100% LRR 5v.	100% LRR 5v.	100% LRR 5v.
School ....	100% LRR 4v.	100% LRR 2v.	100% LRR 5v.	100% LRR 4v.
Transit ....	100% LRR 1v.	100% LRR 1v.	100% LRR 3v.	100% LRR 3v.
Refuse ....	100% LRR 1v.	100% LRR 1v.	100% LRR 3v.	100% LRR 3v.
Mixer .....	100% LRR 2v.	100% LRR 1v.	100% LRR 3v.	100% LRR 2v.
Emer- gency.	100% LRR 2v.	100% LRR 1v.	100% LRR 4v.	100% LRR 1v.

(iv) Idle Reduction Packages

In these rules, the adoption rate of AES for HHD Regional vehicles is 40 percent in MY 2021, 80 percent in MY 2024, and 90 percent in MY 2027. This is because these vehicles have driving patterns with a significant amount of parked idle, and the vast majority have relatively modest accessory demands such that only a few would have such large demands for backup power that turning the engine off while parked

would not be feasible. For all weight classes of Regional vehicles except coach buses, the neutral idle and stop start adoption rates remain zero in all model years because these vehicles have driving patterns with such a small amount of transient driving that this drive-idle technology would not likely provide real world benefits. For coach buses we are predicating the optional custom chassis standard in part on adoption of neutral idle for several reasons. First, according to Volvo, we are underestimating the amount of transient time for these vehicles by applying only a 20 percent weighting of the transient cycle instead of 25 percent as noted in their comment. Second, we estimate that neutral idle is a low cost technology that would easily pay for itself with the miles accumulated by coach buses. Finally, in the custom chassis program manufacturers are able to qualify for a reduced emission rate in GEM through selection of neutral idle even if the transmission architecture inherently functions with neutral idle such as with an AMT or DCT. The Regional vehicles carry a 40 percent, 80 percent, and 90 percent adoption rate of AES in MYs 2021, 2024, and 2027 respectively because these vehicles are not projected to apply any other idle reduction technology and as long as large accessory loads are not required this technology is widely feasible. As reflected in the Multipurpose and Urban

duty cycles with an overall composite test weighting of zero speed operation of 50 percent with 25 percent composite weighting of the parked idle cycle, idle reduction is a significant technology for these vehicles. We are projecting 30 percent adoption of AES in all weight classes of Multipurpose and Urban vocational vehicles in MY 2021, increasing to 60 percent in MY 2024 and 70% in MY 2027. This is less than for Regional because we expect a larger fraction of vehicles in these subcategories will need to run PTO or other accessories while parked, such that fewer will be able to reasonably apply the low-cost AES that we have identified in this rulemaking. Because we are considering stop-start and neutral idle to be mutually exclusive on a per-vehicle basis, the sum of these two technologies does not exceed 90 percent in MY 2027, and gradually ramps up to this level from the 50 to 60 percent range in MY 2021. Neutral idle adoption rates are greater in the early years because we expect this will not need much lead time, if any. An exception to the 90 percent maximum adoption rate is transit buses, where we believe all vehicles of this type can reasonably apply some form of drive idle reduction technology. The adoption rates of idle reduction technologies for vocational vehicles in MY 2027 is presented in Table V-21.

TABLE V-21—MY 2027 ADOPTION RATES OF IDLE REDUCTION TECHNOLOGIES

Technology	Heavy heavy-duty			Medium heavy-duty			Light heavy-duty		
	Regional	Multi-purpose	Urban	Regional	Multi-purpose	Urban	Regional	Multi-purpose	Urban
Neutral Idle .....	0	70	70	0	60	60	0	60	60
Stop-Start .....	0	20	20	0	30	30	0	30	30
AES .....	90	70	70	90	70	70	90	70	70

Although it is possible that a vehicle could have both neutral idle and stop-start, our stringency calculations only consider emissions reductions where a vehicle either has one or the other of these technologies. The final GEM input file allows users to apply multiple idle reduction technologies within a single vehicle configuration.

Because we have included costs to maintain engine protection during periods of shut-off, as well as over-rides to recognize instances where it may not be safe to shut off an engine, we believe stop-start can safely be applied at the rates described above in the time frames described. Also, because we have defined two idle cycles where the

automatic engine shutoff technology addresses the condition of being parked with the brake off, we believe this alleviates many of the concerns expressed by commenters about stop-start. We believe many commenters were (erroneously) imagining that stop-start systems would be required to function during periods of extended parking.

We agree with commenters that stop-start is not feasible for emergency vehicles and concrete mixers. We further believe that stop-start would not provide any real world benefit for coach buses or motor homes. However, for school buses, transit buses, and refuse trucks, we believe stop-start is feasible

and likely to result in real world benefits. The only custom chassis standards that we are basing on adoption of AES is school buses, because for the others, we believe the simple shutdown timer would be likely to encounter an over-ride condition frequently enough to yield a very small benefit from this technology. To make AES practical for a coach or transit bus for example, a much larger auxiliary power source would be needed than the one projected as part of this rulemaking. Although many school buses have voluntarily adopted idle reduction strategies for other reasons, we do not believe many have tamper-proof automatic shutdown systems.

TABLE V-22—CUSTOM CHASSIS WORKDAY IDLE ADOPTION RATES

Technology	MY	AES	NI	Stop-start
Coach .....	2021 .....	.....	40 .....	.....
	2027 .....	.....	70 .....	.....
School .....	2021 .....	30 .....	60 .....	5 .....
	2027 .....	70 .....	60 .....	30 .....
Transit .....	2021 .....	.....	60 .....	10 .....
	2027 .....	.....	70 .....	30 .....
Refuse .....	2021 .....	.....	30 .....	0 .....
	2027 .....	.....	50 .....	20 .....

As described above, the agencies are excluding refuse trucks that do not compact waste from the optional custom chassis vocational vehicle standards. We believe trucks that do not compact waste have sufficiently low PTO operation (usually only while parked) to make application of drive idle reduction technologies (and other technologies projected for regular vocational chassis) quite feasible. Front-loading refuse collection vehicles tend to have a relatively low number of stops per day as they tend to collect waste from central locations such as commercial buildings and apartment complexes. Because these have a relatively low amount of PTO operation, we expect stop-start will be reasonably effective for these vehicles. Rear-loading and side-loading neighborhood waste and recycling collection trucks are the refuse trucks where the largest number of stop-start and neutral idle over-ride conditions are likely to be encountered. Because chassis manufacturers, even those with small production volumes and close customer relationships, do not always know whether a refuse truck chassis will be fitted with a body designed for front loading, rear loading, or side loading, we are applying an adoption rate of 20 percent stop-start in 2027 to refuse trucks certified as custom chassis. In the case where a chassis manufacturer certifies a refuse truck to the primary standards under the HHD Urban subcategory, the MY 2027 adoption rate of stop-start is also 20 percent as shown in Table V-21. The stringency in both cases assumes a sufficiently capable stop-start system to not require an excessive use of over-rides. Manufacturers opting to certify refuse trucks to the primary standards will have an option to be recognized for enhanced stop-start systems through the powertrain test.

It may take some minor development effort to apply neutral idle to high-torque automatic transmissions designed for the largest vocational vehicles. Based on stakeholder input, the designs needed to avoid an uncomfortable re-engagement bump

when returning to drive from neutral may require some engineering refinement as well as some work to enable two-way communication between engines and transmissions. Nonetheless, this technology should be available in the near term for many vehicles and is low cost compared to many other technologies we considered. Commenters asked for over-rides such as when on a steep hill and we agree and are adopting this provision.

For the reasons described above, we see the above idle reduction technologies being technically feasible on the majority of vocational vehicles. The RIA Chapter 2.9.3.4 and RIA Chapter 2.9.5.1.4 provide additional discussion on workday idle reduction technologies for vocational vehicles.

(v) Weight Reduction Packages

As described in the RIA Chapter 2.11.10.3, weight reduction is a relatively costly technology, at approximately \$3 to \$10 per pound for a 200-lb package. Even so, for vehicles in service classes where dense, heavy loads are frequently carried, weight reduction can translate directly to additional payload. The agencies project that modest weight reduction is feasible for all vocational vehicles. The agencies are predicating the final standards on adoption of weight reduction comparable to what can be achieved through use of aluminum wheels (an easy material switch that does not alter load distribution on the chassis). This package is estimated at 150 pounds for LHD and MHD vehicles, and 250 pounds for HHD vehicles, based on six and 10 wheels, respectively. This value is revised upward since proposal based on compelling comments from the Aluminum Association recommending that we set the same level of weight reduction for lightweight aluminum alloys as for regular aluminum, at 25 pounds per wheel. More details on these comments may be found in the Response to Comments Chapter 5. In MY 2021, we project an adoption rate of 10 percent, 30 percent in MY 2024, and

50 percent in MY 2027 for all subcategories in the primary program.

The agencies project manufacturers will have sufficient options of other components eligible for material substitution so that this level of weight reduction will be feasible even where aluminum wheels are not selected by customers. Based on comments, we have removed aluminum transmission cases and aluminum clutch housings from the vocational lookup table.

We are not predicating the custom chassis standards on any use of weight reduction. We have learned that manufacturers of concrete mixers, refuse trucks, and some high end buses have already made extensive use of lightweighting technologies in the baseline fleet. We also received persuasive comment cautioning us not to base the school bus standards on weight reduction due to potential conflicts with safety standards. In considering this information, we are allowing all vehicles certified using custom chassis regulatory subcategory identifiers to make use of weight reduction as a compliance flexibility. We received compelling comment from UCS that weight reduction should be considered feasible for transit buses. Upon consideration of this comment as well as information regarding the preponderance of city buses with overloaded axles, we are predicating standard stringency for transit buses on use of aluminum wheels at the same adoption rate as for the primary program. See the RIA at Chapter 2.9.5.1.5 for more information about transit bus axles.

(vi) Electrified Accessory Packages

The agencies are predicating the final vocational vehicle standards in part on an adoption rate of five percent in MY 2021 of an electrified accessory package that achieves one percent fuel efficiency improvement. The discussion in Section V.C.(1)(a)(vi) describes some pre-defined e-accessory improvements that are available in GEM for all vocational vehicles. In MY 2024 we increase this adoption rate to ten percent, and in MY

2027 the projected adoption rate is 15 percent, applicable in all subcategories excluding custom chassis. Although we believe some components could be electrified for some custom chassis, we do not have sufficient information to estimate an incremental cost associated with electrifying the more complex systems on custom chassis such as buses, or to project a specific adoption rate for this type of improvement.

(vii) Tire Pressure System Packages

The agencies are predicating the vocational vehicle standards in part on

widespread adoption of tire pressure monitoring systems. These are readily accepted by fleets as a cost-effective safety and fuel-saving measure. Because there may be some minor challenges in applying this technology to some vehicles where the payload and duty cycle lead to very high tire temperatures and pressures (as described above), we are applying a lower adoption rate to Urban and Multi-purpose vehicles than to Regional vehicles, as shown in Table V-23. We are applying similarly lower adoption rates for refuse trucks and

transit buses. We are not predicating the emergency vehicle or cement mixer standards on adoption of TPMS.

We are predicating the optional school bus, coach bus, transit bus, and refuse truck standards in part on limited adoption of automatic tire inflation systems (ATIS), as shown in Table V-23. These are more costly than TPMS, and require an onboard air supply and sometimes extensive plumbing of air lines.

TABLE V-23—VOCATIONAL TIRE PRESSURE SYSTEM ADOPTION RATES

Technology	TPMS			ATIS	
	MY 2021	MY 2024	MY 2027	MY 2021	MY 2027
Regional .....	60	75	90	.....	.....
Multi-Purpose .....	50	65	80	.....	.....
Urban .....	40	55	70	.....	.....
School .....	70	.....	80	.....	20
Coach .....	50	.....	75	10	25
Transit .....	40	.....	50	10	20
Refuse .....	40	.....	50	10	15
Motor Home .....	60	.....	90	.....	.....

(c) GEM Inputs for Derivation of Vocational Vehicle Standards

To account for engine-level improvements consistent with those projected to meet Phase 2 vocational engine standards, and which will be reflected over the GEM vehicle test cycles, the agencies developed a suite of fuel consumption maps for use with the GEM: One set of maps that represent engines meeting the MY 2021 vocational diesel engine standards, a second set of maps representing engines meeting the MY 2024 vocational diesel engine standards, and a third set of maps representing engines meeting the MY 2027 vocational diesel engine standards.<sup>441</sup> By incorporating the engine technology packages projected to be adopted to meet the Phase 2 vocational CI engine standards, the agencies employed GEM engine models in deriving the stringency of the Phase 2 CI-powered vocational vehicle standards. Similarly, to account for the performance of Phase 2 SI engines in deriving the stringency of the Phase 2 SI-powered vocational vehicle standards, the agencies employed our baseline SI GEM engine model. The extra engine technology on which the Phase 2 SI vocational vehicle standards

are based was applied in post-processing the GEM results, not modeled with an improved GEM map. See the RIA Chapter 2.9.1 for more details about the vocational engines used in standard-setting.

The derivation of the vocational vehicle standards incorporates several methods because some GEM inputs lend themselves to fleet-average values, some are vehicle specific (either on or off) and some improvements are not directly modeled in GEM. For each model year of standards, the agencies derived a scenario vehicle for each subcategory using the future model year engine map with fleet average input values for tire rolling resistance and weight reduction. For example, the MY 2021 HHD weight reduction input value was derived as follows: 250 pounds times 10 percent adoption yields 25 pounds. Those scenario vehicle performance results were combined in a post-process method with subcategory-specific improvements from idle reduction, axle disconnect, torque converter lockup, and transmission automation, using directly modeled GEM improvements comparing results with these technologies on or off the scenario vehicle. Subsequently, these performance values were combined

with estimated improvement values of technologies not modeled in GEM, including TPMS, hybrids, and transmission gear efficiency.

The set of fleet-average inputs for tire CRR and weight reduction for MY 2021, as modeled in GEM is shown in Table V-24, along with the respective adoption rates for idle reduction, axle disconnect, and torque converter lockup. The agencies derived the level of the MY 2024 standards by using the GEM inputs and adoption rates shown in Table V-25, below. The agencies derived the level of the MY 2027 standards by using the GEM inputs and adoption rates shown in Table V-26, below. Post-processing improvements for technologies not directly modeled, including TPMS, e-accessories, hybrids, and axle and transmission improvements are presented as a combined driveline improvement factor in Table V-27, below. The values in this table for SI-powered vocational vehicles include improvements due to adoption of SI engine technology. The methodology for estimating these improvements is described in the RIA Chapter 2.9.1. The final standards are presented in Table V-4 through Table V-9.

<sup>441</sup> See Section II.D.2 of this Preamble for the derivation of the engine standards.

TABLE V-24—GEM INPUTS USED TO DERIVE FINAL MY 2021 VOCATIONAL VEHICLE STANDARDS

Class 2B-5			Class 6-7			Class 8		
Urban	Multi-purpose	Regional	Urban	Multi-purpose	Regional	Urban	Multi-purpose	Regional
<b>SI Engine</b>								
2018 MY 6.8L, 300 hp engine								
<b>CI Engine</b>								
2021 MY 7L, 200 hp Engine			2021 MY 7L, 270 hp Engine			2021 MY 11L, 350 hp Engine	2021 MY 11L, 350 hp Engine and 2021 MY 15L 455hp Engine <sup>a</sup>	
<b>Torque Converter Lockup in 1st (adoption rate)</b>								
30% .....	30%	30%	30%	30%	30%	10%	10%	0%
<b>6 x 2 Disconnect Axle (adoption rate)</b>								
0% .....	0%	0%	0%	0%	0%	0%	5%	10%
<b>AES (adoption rate)</b>								
30% .....	30%	40%	30%	30%	40%	30%	30%	40%
<b>Stop-Start (adoption rate)</b>								
10% .....	10%	0%	10%	10%	0%	0%	0%	0%
<b>Neutral Idle (adoption rate)</b>								
50% .....	50%	0%	50%	50%	0%	50%	50%	0%
<b>Steer Tires (CRR kg/metric ton)</b>								
7 .....	6.8	6.8	6.8	6.7	6.7	6.4	6.2	6.2
<b>Drive Tires (CRR kg/metric ton)</b>								
7.2 .....	6.9	6.9	7.8	7.5	7.5	7.8	7.5	7.5
<b>Weight Reduction (lb)</b>								
15 .....	15	15	15	15	15	25	25	25

**Note:**

<sup>a</sup> The Multipurpose and Regional HHD standards are established using averages of configurations with different engines as described in RIA Chapter 2.9.2.

TABLE V-25—GEM INPUTS USED TO DERIVE FINAL MY 2024 VOCATIONAL VEHICLE STANDARDS

Class 2b-5			Class 6-7			Class 8		
Urban	Multi-purpose	Regional	Urban	Multi-purpose	Regional	Urban	Multi-purpose	Regional
<b>SI Engine</b>								
2018 MY 6.8L, 300 hp engine								
<b>CI Engine</b>								
2024 MY 7L, 200 hp Engine			2024 MY 7L, 270 hp Engine			2024 MY 11L, 350 hp Engine	2024 MY 11L, 350 hp Engine and 2024 MY 15L 455hp Engine <sup>a</sup>	
<b>Torque Converter Lockup in 1st (adoption rate)</b>								
40% .....	40%	40%	40%	40%	40%	20%	20%	0%



TABLE V-25—GEM INPUTS USED TO DERIVE FINAL MY 2024 VOCATIONAL VEHICLE STANDARDS—Continued

Class 2b-5			Class 6-7			Class 8		
Urban	Multi-purpose	Regional	Urban	Multi-purpose	Regional	Urban	Multi-purpose	Regional
<b>6 x 2 Disconnect Axle (adoption rate)</b>								
0% .....	0%	0%	0%	0%	0%	0%	15%	20%
<b>AES (adoption rate)</b>								
60% .....	60%	80%	60%	60%	80%	60%	60%	80%
<b>Stop-Start (adoption rate)</b>								
20% .....	20%	0%	20%	20%	0%	10%	10%	0%
<b>Neutral Idle (adoption rate)</b>								
70% .....	70%	0%	70%	70%	0%	70%	70%	0%
<b>Steer Tires (CRR kg/metric ton)</b>								
7.0 .....	6.8	6.2	6.8	6.7	6.2	6.4	6.2	6.2
<b>Drive Tires (CRR kg/metric ton)</b>								
7.2 .....	6.9	6.9	7.8	7.5	6.9	7.8	7.5	6.9
<b>Weight Reduction (lb)</b>								
45 .....	45	45	45	45	45	75	75	75

**Note:**  
<sup>a</sup> The Multipurpose and Regional HHD standards are established using averages of configurations with different engines as described in RIA Chapter 2.9.2.

TABLE V-26—GEM INPUTS USED TO DERIVE FINAL MY 2027 VOCATIONAL VEHICLE STANDARDS

Class 2b-5			Class 6-7			Class 8		
Urban	Multi-purpose	Regional	Urban	Multi-purpose	Regional	Urban	Multi-purpose	Regional
<b>SI Engine</b>								
2018 MY 6.8L, 300 hp engine								
<b>CI Engine</b>								
2027 MY 7L, 200 hp Engine			2027 MY 7L, 270 hp Engine			2027 MY 11L, 350 hp Engine	2027 MY 11L, 350 hp Engine and 2027 MY 15L 455hp Engine <sup>a</sup>	
<b>Torque Converter Lockup in 1st (adoption rate)</b>								
50% .....	50%	50%	50%	50%	50%	30%	30%	0%
<b>6 x 2 Disconnect Axle (adoption rate)</b>								
0% .....	0%	0%	0%	0%	0%	0%	25%	30%
<b>AES (adoption rate)</b>								
70% .....	70%	90%	70%	70%	90%	70%	70%	90%
<b>Stop-Start (adoption rate)</b>								
30% .....	30%	0%	30%	30%	0%	20%	20%	0%
<b>Neutral Idle (adoption rate)</b>								
60% .....	60%	0%	60%	60%	0%	70%	70%	0%

TABLE V-26—GEM INPUTS USED TO DERIVE FINAL MY 2027 VOCATIONAL VEHICLE STANDARDS—Continued

	Class 2b-5			Class 6-7			Class 8		
	Urban	Multi-purpose	Regional	Urban	Multi-purpose	Regional	Urban	Multi-purpose	Regional
<b>Steer Tires (CRR kg/metric ton)</b>									
6.8 .....	6.2	6.2	6.2	6.7	6.2	6.2	6.2	6.2	6.2
<b>Drive Tires (CRR kg/metric ton)</b>									
6.9 .....	6.9	6.9	6.9	7.5	6.9	6.9	7.5	6.9	6.9
<b>Weight Reduction (lb)</b>									
75 .....	75	75	75	75	75	75	125	125	125

**Note:**

<sup>a</sup>The Multipurpose and Regional HHD standards are established using averages of configurations with different engines as described in RIA Chapter 2.9.2.

TABLE V-27—VOCATIONAL DRIVELINE IMPROVEMENT FACTORS

	Class 2b-5			Class 6-7			Class 8		
	Urban	Multi-purpose	Regional	Urban	Multi-purpose	Regional	Urban	Multi-purpose	Regional
CI 2021 .....	0.019	0.018	0.018	0.019	0.019	0.019	0.019	0.018	0.017
CI 2024 .....	0.041	0.036	0.029	0.041	0.036	0.029	0.040	0.036	0.026
CI 2027 .....	0.061	0.053	0.037	0.061	0.053	0.037	0.060	0.052	0.034
SI 2021 .....	0.027	0.026	0.026	0.028	0.027	0.027	.....	.....	.....
SI 2024 .....	0.048	0.044	0.037	0.049	0.044	0.037	.....	.....	.....
SI 2027 .....	0.067	0.059	0.045	0.068	0.060	0.045	.....	.....	.....

(d) Role of Fleet Averaging and Constraints in Vocational Vehicle Standards

In part to avoid potentially creating incentives to misclassify vehicles, the agencies proposed to “equalize” the standards for each of the subcategories. 80 FR 40308. Thus, at proposal, the standards for the Regional, Multipurpose, and Urban subcategories reflected the arithmetic mean of the Regional, Multipurpose and Urban stringency levels (*i.e.*, all three drive cycle subcategory percent improvements averaged together) in each weight class.<sup>442</sup> Most commenters criticized this proposed approach. For example, Navistar commented that equalization could inappropriately benefit one manufacturer over another based on their product mix. We also note that the equalization process, if adopted, would have made the standards for the Regional vehicles unattainable using the technology pathway identified by the agencies, thus motivating manufacturers to select less appropriate test cycles for vehicles that are designed for Regional service. Therefore, we have decided not to apply “equalization” for finalizing the

vocational vehicle standards. Instead, we have developed the final vocational vehicle standards using the same methodology as for all of the other Phase 2 standards, where we apply fleet average technology mixes to fleet average baseline vehicle configurations, and each average baseline and technology mix is unique for each vehicle subcategory. Along with this standard-setting approach, the agencies are also adopting certain interim constraints on the otherwise generally manufacturer-selected assignment of vehicle configurations to one of the three drive cycle subcategories, as explained in Section V.D.(1)(e) below.

Elsewhere in this rulemaking we present overall costs and benefits, which are based on our projected distribution of vocational vehicles in each subcategory. This projection includes our most updated population distributions by weight class, which we have adjusted in part in response to comments on the draft NREL report in the NODA and based on an analysis of telematics data from Ryder’s leased vehicles. We intend to monitor whether our projection of distribution of vehicles among subcategories is consistent with outcomes. Under the three drive cycle subcategory structure, manufacturers must use good engineering judgment

(subject to the provisions of 40 CFR 1068.5) to choose a subcategory for each vehicle configuration that represents the type of operation the vehicle is configured to experience in use, and the agencies expect the manufacturer and customer to specify a technology mix that is most effective for that vehicle’s likely operation. In other words, as long as manufacturers work with their customers, the general rule describing this greater flexibility in choice of subcategory could be that the “customer knows best.” In fact, our standards are predicated on the premise that willful misclassification not reflecting good engineering judgment will be rare, and thus environmentally inconsequential.

In considering our approach for setting the final standards, we compared the relative stringencies in each subcategory with each respective baseline, and we observed that Regional vehicles are generally able to achieve the smallest percent improvement from the lowest (most efficient) baseline. By contrast, the Urban vehicles are generally able to achieve the greatest percent improvement from the highest (least efficient) baseline. We are not particularly concerned that adopting final standards with these unequal percent improvements poses a danger of losing environmental benefits from this

<sup>442</sup> See proposed rules at 80 FR 40308, July 13, 2015.

program, as long as vehicle configurations are properly classified at the time of certification. To test the potential impacts of misclassification, we compared the performance of each of our baseline configurations over all three drive cycles. This analysis is presented in a memorandum to the docket.<sup>443</sup> Results for LHD and MHD weight classes were generally consistent with the rule’s projections across each drive cycle. Results for HHD were equivocal in some instances, particularly for our baseline vehicles equipped with manual transmissions. This issue appears to be related to both the difference in the weighting of time spent in the drive idle mode in the Regional versus Urban and Multi-purpose drive cycles, and whether or not automatic transmissions are part of a baseline. In the analysis, that combination of circumstances showed how manual transmission-equipped vehicles could potentially become credit generators without any further addition of technology, if certified to the Urban or Multi-purpose cycles. The agencies are concerned that if this circumstance were to be left unconstrained, it could create an incentive to misclassify some Regional vehicles into one of the other two drive cycle subcategories, even though manual transmissions are generally best suited for Regional driving patterns, as discussed further below.

In light of this analysis, and consistent with recent comments from chassis manufacturers mentioned above in Section V.B.(1)(a), the agencies are adopting some constraints to the otherwise generally manufacturer-selected assignment of vocational chassis to regulatory subcategories. These constraints are described in Section V.D.(1)(e). A subset of the constraints prevents inappropriate classification based on transmission type. These constraints restrict classification options where a vocational vehicle is certifying with a manual transmission or in some cases an automated manual transmission. We are adopting these constraints as interim provisions in response to

manufacturers’ concerns that the manual transmission constraints could present competitive disadvantages, where different manufacturers produce very different sales mixes of vehicles equipped with different transmission types.<sup>444</sup> However, at this time the final program structure, including these constraints, will remain in place unless and until the agencies determine that revisions to the vocational vehicle program structure are warranted, in which case the agencies would undertake a notice and comment rulemaking proposing to amend the programmatic structure, consistent with such a determination.

It is important to clarify that we would consider all relevant factors together before deciding whether to propose any revisions. If we find that a significant discrepancy arises between our projections and outcomes, such that our estimated GHG and fuel consumption benefits are not being achieved because of the program structure, we may revisit relevant aspects of the program structure, including the drive cycles, subcategories and classification constraints. If we propose to revise the structure in the future, it might also be necessary to propose revising the numerical values of the standards to maintain equivalence with the final stringency being established in this rulemaking. We would of course find it acceptable if manufacturers implemented more cost-effective technologies than we projected, while still achieving the projected reductions in use. Similarly, if the structure results in manufacturers generally adopting the projected cost-effective technologies on the appropriate vehicles, but somehow this fails to fully achieve the projected reductions in use, we do not believe revisions necessarily would be warranted.

(e) Technology Package Costs Associated With Primary Vocational Vehicle Standards

The agencies have estimated the costs of the technologies that could be used to comply with the final Phase 2

vocational vehicle standards. The estimated costs are shown in Table V–28 for MY 2021, in Table V–29 for MY 2024, and Table V–30 for MY 2027. Fleet average costs are shown for light, medium and heavy HD vocational vehicles in each duty-cycle-based subcategory—Urban, Multi-Purpose, and Regional. As shown in Table V–28, in MY 2021 these range from approximately \$900 for MHD and LHD Regional vehicles, up to \$2,600 for HHD Regional vehicles. Those two lower-cost packages reflect zero hybrids, and the higher-cost package reflects significant adoption of automated transmissions. Many changes have been made to the cost estimates since proposal. In the RIA Chapter 2.12.2, the agencies present vocational vehicle technology package costs differentiated by MOVES vehicle type. These costs do not indicate the per-vehicle cost that may be incurred for any individual technology. For more specific information about the agencies’ estimates of per-vehicle costs, please see the RIA Chapter 2.11. The engine costs listed represent the cost of an average package of diesel engine technologies as set out in Section II. Individual technology adoption rates for engine packages are described in Section II.D. For gasoline vocational vehicles, the agencies are projecting adoption of Level 2 engine friction reduction plus cylinder deactivation (*i.e.*, all engine improvements are reflected exclusively in the vehicle standard) for an estimated \$138 added to the average SI vocational vehicle package cost beginning in MY 2021. Further details on how the SI vocational vehicle costs were estimated are provided in the RIA Chapter 2.9.

The details behind all these costs are presented in RIA Chapter 2.11, including the markups and learning effects applied and how the costs shown here are weighted to generate an overall cost for the vocational segment. These estimates have changed significantly from those presented in the proposal, due to changes in projected technology adoption rates as well as changes in direct costs that reflect comments received.

TABLE V–28—FINAL VOCATIONAL VEHICLE TECHNOLOGY INCREMENTAL COSTS IN THE 2021 MODEL YEAR<sup>a b</sup>  
[2013\$]

	Light HD			Medium HD			Heavy HD		
	Urban	Multi-purpose	Regional	Urban	Multi-purpose	Regional	Urban	Multi-purpose	Regional
Engine <sup>c</sup> .....	\$298	\$298	\$298	\$275	\$275	\$275	\$275	\$275	\$275

<sup>443</sup> See spreadsheet file dated July 2016 titled, VocationalStringencyComparison.xlsx.

<sup>444</sup> See memorandum dated July 2016 titled, “Summary of Late Comments on Vocational Transmissions and N/V.”

TABLE V-28—FINAL VOCATIONAL VEHICLE TECHNOLOGY INCREMENTAL COSTS IN THE 2021 MODEL YEAR<sup>a b</sup>—Continued  
[2013\$]

	Light HD			Medium HD			Heavy HD		
	Urban	Multi-purpose	Regional	Urban	Multi-purpose	Regional	Urban	Multi-purpose	Regional
Tires .....	0	27	27	9	9	9	13	13	13
Tire Pressure Monitoring .....	123	154	184	123	154	184	233	292	350
Transmission .....	217	217	217	217	217	217	186	413	1,519
Axle related .....	13	13	13	13	13	13	20	26	32
Weight Reduction .....	69	69	69	69	69	69	250	250	250
Idle reduction .....	155	155	12	160	160	12	68	68	12
Hybridization .....	178	178	0	178	178	0	178	178	0
Air Conditioning <sup>d</sup> .....	22	22	22	22	22	22	22	22	22
Other <sup>e</sup> .....	30	30	30	49	49	49	89	89	89
<b>Total .....</b>	<b>1,106</b>	<b>1,164</b>	<b>873</b>	<b>1,116</b>	<b>1,146</b>	<b>851</b>	<b>1,334</b>	<b>1,625</b>	<b>2,562</b>

**Notes:**

<sup>a</sup>Costs shown are for the 2021 model year and are incremental to the costs of a vehicle meeting the Phase 1 standards. These costs include indirect costs via markups along with learning impacts. For a description of the markups and learning impacts considered in this analysis and how it impacts technology costs for other years, refer to Chapter 2 of the RIA (see RIA 2.11).

<sup>b</sup>Note that values in this table include adoption rates. Therefore, the technology costs shown reflect the average cost expected for each of the indicated vehicle classes. To see the actual estimated technology costs exclusive of adoption rates, refer to Chapter 2 of the RIA (see RIA 2.11 in particular).

<sup>c</sup>Engine costs are for a light HD, medium HD or heavy HD diesel engine. We are projecting \$138 of additional costs beyond Phase 1 for gasoline vocational engines.

<sup>d</sup>EPA's air conditioning standards are presented in Section V.C above.

<sup>e</sup>Other incremental technology costs include electrified accessories and advanced shift strategy.

The estimated fleet average vocational vehicle package costs are shown in Table V-29 for MY 2024. As shown, these range from approximately \$1,300 for MHD and LHD Regional vehicles, up to \$4,000 for HHD Regional vehicles.

The increased costs above the MY 2021 values reflect increased adoption rates of individual technologies, while the individual technology costs are generally expected to remain the same or decrease, as explained in the RIA

Chapter 2.11. The engine costs listed represent the average costs associated with the MY 2024 vocational diesel engine standard described in Section II.D.

TABLE V-29—FINAL VOCATIONAL VEHICLE TECHNOLOGY INCREMENTAL COSTS IN THE 2024 MODEL YEAR<sup>a b</sup>  
[2013\$]

	Light HD			Medium HD			Heavy HD		
	Urban	Multi-purpose	Regional	Urban	Multi-purpose	Regional	Urban	Multi-purpose	Regional
Engine <sup>c</sup> .....	\$446	\$446	\$446	\$413	\$413	\$413	\$413	\$413	\$413
Tires .....	0	31	33	10	10	33	13	13	53
Tire Pressure Monitoring .....	155	183	211	155	183	211	294	347	401
Transmission .....	276	276	276	276	276	276	222	1,032	2,193
Axle related .....	24	24	24	24	24	24	37	54	60
Weight Reduction .....	186	186	186	186	186	186	684	684	684
Idle reduction .....	248	248	21	256	256	21	242	242	21
Hybridization .....	550	550	0	653	653	0	844	844	0
Air Conditioning <sup>d</sup> .....	20	20	20	20	20	20	20	20	20
Other <sup>e</sup> .....	54	54	54	89	89	89	162	162	162
<b>Total .....</b>	<b>1,959</b>	<b>2,018</b>	<b>1,272</b>	<b>2,082</b>	<b>2,110</b>	<b>1,274</b>	<b>2,932</b>	<b>3,813</b>	<b>4,009</b>

**Notes:**

<sup>a</sup>Costs shown are for the 2024 model year and are incremental to the costs of a vehicle meeting the Phase 1 standards. These costs include indirect costs via markups along with learning impacts. For a description of the markups and learning impacts considered in this analysis and how it impacts technology costs for other years, refer to Chapter 2 of the RIA (see RIA 2.11).

<sup>b</sup>Note that values in this table include adoption rates. Therefore, the technology costs shown reflect the average cost expected for each of the indicated vehicle classes. To see the actual estimated technology costs exclusive of adoption rates, refer to Chapter 2 of the RIA (see RIA 2.9 in particular).

<sup>c</sup>Engine costs are for a light HD, medium HD or heavy HD diesel engine. We are projecting \$136 additional costs beyond Phase 1 for gasoline vocational engines.

<sup>d</sup>EPA's air conditioning standards are presented in Section V.C above.

<sup>e</sup>Other incremental technology costs include electrified accessories and advanced shift strategy.

The estimated fleet average vocational vehicle package costs are shown in Table V-30 for MY 2027. As shown,

these range from approximately \$1,500 for MHD and LHD Regional vehicles, up to \$5,700 for HHD Regional vehicles.

These per-vehicle technology package costs were averaged using our projections of vehicle populations in the

nine regulatory subcategories and do not correspond to the MOVES vehicle types. The engine costs shown represent the average costs associated with the MY 2027 vocational diesel engine standard described in Section II.D.

Purchase prices of non-custom vocational vehicles can range from \$60,000 for a light heavy-duty stake-bed landscape truck to over \$300,000 for a

heavy heavy-duty boom truck. The costs of the vocational vehicle standards can be put into perspective by comparing estimated package costs with typical prices for those vehicles. For example, a package cost of \$3,000 on a \$60,000 landscaping truck represents an incremental increase of about five percent of the vehicle purchase price.

Similarly, a package cost of \$4,000 on a \$300,000 boom truck represents an incremental increase of less than two percent of the vehicle purchase price. The vocational vehicle industry characterization report in the docket includes additional examples of vehicle prices for a variety of vocational applications.<sup>445</sup>

TABLE V-30—FINAL VOCATIONAL VEHICLE TECHNOLOGY INCREMENTAL COSTS IN THE 2027 MODEL YEAR<sup>a b</sup> [2013\$]

	Light HD			Medium HD			Heavy HD		
	Urban	Multi-purpose	Regional	Urban	Multi-purpose	Regional	Urban	Multi-purpose	Regional
Engine <sup>c</sup> .....	\$481	\$481	\$481	\$446	\$446	\$446	\$446	\$446	\$446
Tires .....	12	24	24	6	24	24	12	36	36
Tire Pressure Monitoring .....	187	214	240	187	214	240	355	405	456
Transmission .....	271	271	293	271	271	293	220	990	3,269
Axle related .....	35	35	35	35	35	35	52	82	87
Weight Reduction .....	294	294	294	294	294	294	1,102	1,102	1,102
Idle reduction .....	303	303	23	314	314	23	365	365	23
Hybridization .....	857	857	0	1,032	1,032	0	1,353	1,353	0
Air Conditioning <sup>d</sup> .....	20	20	20	20	20	20	20	20	20
Other <sup>e</sup> .....	73	73	77	122	122	127	227	227	231
Total .....	2,533	2,571	1,486	2,727	2,771	1,500	4,151	5,025	5,670

**Notes:**

<sup>a</sup> Costs shown are for the 2027 model year and are incremental to the costs of a vehicle meeting the Phase 1 standards. These costs include indirect costs via markups along with learning impacts. For a description of the markups and learning impacts considered in this analysis and how it impacts technology costs for other years, refer to Chapter 2 of the RIA (see RIA 2.11).

<sup>b</sup> Note that values in this table include adoption rates. Therefore, the technology costs shown reflect the average cost expected for each of the indicated vehicle classes. To see the actual estimated technology costs exclusive of adoption rates, refer to Chapter 2 of the RIA (see RIA 2.9 in particular).

<sup>c</sup> Engine costs are shown for a light HD, medium HD or heavy HD diesel engine. For gasoline-powered vocational vehicles we are projecting \$125 of additional engine-based costs beyond Phase 1.

<sup>d</sup> EPA's air conditioning standards are presented in Section V.C above.

<sup>e</sup> Other incremental technology costs include electrified accessories and advanced shift strategy.

(f) Custom Chassis Cost Estimates

The agencies have performed the above-described cost analysis using the assumption that all custom chassis vocational vehicles are certified to the primary standards, with full technology packages and use of the regular Phase 2 GEM. In terms of costs, we expect that a manufacturer will choose to certify a vehicle family to the optional custom chassis standards only if it is less costly to do so. The cost-benefit analysis found in the RIA Chapter 7 presents some estimates of what the technology package costs of the primary standards are in terms of MOVES vehicle types. For the MOVES types where a custom chassis option is available, these are conservatively high cost estimates. Table 6 and Table 7 of the RIA Executive Summary present estimates of average custom chassis technology packages associated with the final

optional standards in MY 2021 and MY 2027, respectively.

The agencies are not aware of any custom chassis manufacturer that produces engines. Thus, the engine costs will be borne by engine manufacturers. While some of the added engine costs may be passed on to vehicle manufacturers, and some vehicle costs may be passed on to owners/operators, the overall technology costs of the custom chassis standards are significantly less than the Phase 2 vocational vehicle technology costs, which, as shown directly below, are highly cost-effective.

(3) Consistency of the Vocational Vehicle Standards With the Agencies' Legal Authority

NHTSA and EPA project these standards to be achievable within known design cycles, and we believe these standards, although technology-advancing, will allow many different

paths to compliance in addition to the technology paths on which standard stringency is predicated. These standards are predicated on manufacturers implementing technologies that we expect will be available in the time frame of these final rules. We are projecting that most vehicles can adopt certain of the technologies. For example, we project a 70 to 90 percent application rate for TPMS. However, for other technologies, such as electrified accessories, we are projecting an adoption rate of 15 percent. These standards offer manufacturers the flexibility to apply the technologies that make sense for their business and for customer needs.

As discussed above, average per-vehicle costs associated with the 2027 MY standards are projected to be generally less than five percent of the overall price of a new vehicle. The annual cost-effectiveness of these vocational vehicle standards in dollars

<sup>445</sup> See Heavy Duty Vocational Vehicle Industry Characterization, EPA Contract No. EP-C-12-011, September 2013.

per metric ton is presented in the RIA Chapter 7 in Table 7–47. As shown in that table, without fuel savings the cost per metric ton of the final vocational vehicle standards in calendar year 2021 is \$710, decreasing to \$100 by 2030. The cost effectiveness estimated for heavy-duty pickup trucks and vans in this rulemaking is presented in Table 7–46 in that same chapter of the RIA. Those Phase 2 standards have an estimated annual cost per metric ton without fuel savings of \$2,800 in 2020, decreasing to \$110 (about the same as for vocational) by calendar year 2030. The annual cost per ton of the MY 2017–2025 light-duty greenhouse gas standards for pickup trucks as reported in 2010 dollars without fuel savings is \$430 in calendar year 2020, decreasing to \$142 in 2030.<sup>446</sup> The agencies have found these standards to be highly cost effective. In addition, the vocational vehicle standards are clearly effective from a net benefits perspective (see RIA Chapter 11.2). Therefore, the agencies regard the cost of the final standards as reasonable, even without considering that the costs are recovered due decreased fuel consumption.

The agencies note that while the projected costs are significantly greater than the costs projected for Phase 1, we still consider these costs to be reasonable, especially given that the first vehicle owner may see the technologies pay for themselves in many cases. As discussed above, the usual period of ownership for a vocational vehicle reflects a lengthy trade cycle that may often exceed seven years. For most vehicle types evaluated, the cost of these technologies, if passed on fully to customers, will likely be recovered within four years or less due

to the associated fuel savings, as shown in the payback analysis included in Section IX.M and in the RIA Chapter 7.1. Specifically, in RIA Chapter 7.2.4, a summary is presented with estimated payback periods for each of the MOVES vocational vehicle types, using the annual vehicle miles traveled from the MOVES model for each vehicle type. As noted above, the cost analysis presented for this rulemaking assumes that all vocational vehicles are certified to the primary standard. Using this assumption, the vocational vehicle type with the shortest payback is intercity buses (less than one year), while most other vehicles (with the exception of school buses and motor homes) are projected to see paybacks in the fourth year or sooner. We expect that manufacturers will certify to the optional custom chassis standards where it is more cost-effective to do so; therefore, our analysis may be overly conservative where it indicates very long paybacks for some vocational vehicles.

The agencies note further that although the rules are technology-advancing (especially with respect to driveline improvements) and the estimated costs for each subcategory vary considerably (by a factor of five in some cases), these costs represent only one of many possible pathways to compliance for manufacturers. Manufacturers retain leeway to develop alternative compliance paths, increasing the likelihood of the standards’ successful implementation. Based on available information, the agencies believe the final vocational vehicle standards are technically feasible within the lead time provided, are cost effective while accounting for the fuel savings

(see RIA Chapter 7.1.4), and have no apparent adverse collateral potential impacts (e.g., there are no projected negative impacts on safety or vehicle utility).

The final standards thus appear to represent a reasonable choice under section 202(a) of the CAA and are maximum feasible under NHTSA’s EISA authority at 49 U.S.C. 32902(k)(2). The agencies believe that the final standards are consistent with their respective authorities.

(4) Alternative Vocational Vehicle Standards Considered

The agencies developed and considered other alternative levels of stringency for the Phase 2 program. The results of the analysis of these alternatives, and comments received on alternatives, are discussed below in Section X of the Preamble and the RIA Chapter 11. For vocational vehicles, the agencies developed alternatives as shown in Table V–31. The agencies are not adopting standards reflecting Alternative 2, because as already described, technically feasible standards are available that provide for greater emission reductions and reduced fuel consumption than provided under Alternative 2. The agencies are not adopting standards reflecting Alternative 4 or Alternative 5 because we do not believe these standards to be feasible considering lead time and other relevant factors. Nevertheless, we have reevaluated each of the technology projections proposed for Alternative 4 and have determined that some engine and tire reductions will be feasible on the Alternative 4 timeline.

TABLE V–31—SUMMARY OF ALTERNATIVES CONSIDERED FOR THE FINAL RULEMAKING

Alternative 1 and 1b	No action alternatives
Alternative 2 .....	Less stringent than the preferred alternative in the proposal, applying off-the-shelf technologies.
Final HD Phase 2 program .....	Fully phased-in by MY 2027.
Alternative 4 .....	Same stringency as preferred alternative in the proposal, phasing in by MY 2024.
Alternative 5 .....	More stringent alternative, based on higher adoption rates of advanced technologies.

D. Compliance Provisions for Vocational Vehicles

We are adopting many changes in the compliance provisions for vocational vehicles compared with what we proposed, as described in this section.

(1) Application and Certification Process

The agencies are adopting changes in the final Phase 2 version of GEM, as described in Section II of this Preamble. Below we provide cross-references to test procedures either that are either required or optional, for generation of Phase 2 GEM input values. See Section

II.D.1 for details of engine testing and GEM inputs for engines.

As described above in Section I, the agencies will continue the Phase 1 compliance process in terms of the manufacturer requirements prior to the effective model year, during the model year, and after the model year. The information that will be required to be submitted by manufacturers is set forth

<sup>446</sup> See Chapter 5.3 of the final RIA for the MY 2017–2025 Light-Duty GHG Rule, available at

<http://www3.epa.gov/otaq/climate/documents/420r12016.pdf>.

in 40 CFR 1037.205, 49 CFR 537.6, and 49 CFR 537.7. EPA will continue to issue certificates upon approval based on information submitted through the VERIFY database (see 40 CFR 1037.255). End of year reports will continue to include the GEM results for all of the configurations built, along with credit/deficit balances, if applicable (see 40 CFR 1037.250 and 1037.730).

(a) GEM Inputs

In Phase 1, there were two inputs to GEM for vocational vehicles:

- Steer tire coefficient of rolling resistance, and
- Drive tire coefficient of rolling resistance

As discussed above in Section II and III.D, there are several additional inputs that we are adopting for Phase 2. In addition to the steer and drive tire CRR, the inputs include the following:

- Engine input file with fuel map, full-load torque curve, and motoring curve,
- Transmission input file including architecture type, gear number and ratios, and minimum lockup gear for transmissions with torque converters,
  - Drive axle ratio,
  - Axle configuration,
  - Tire size in revs/mi for drive and steer tires,
  - Idle Reduction,
  - Weight Reduction,
  - Vehicle Speed Limiter,
  - Aerodynamic Drag Area, and
  - Pre-defined technology inputs for

Accessory Load and Tire Pressure Systems

(i) Driveline Inputs

As with tractors, for each engine family, engine fuel maps, full load

torque curve, and motoring curve will be generated by engine manufacturers and supplied to chassis manufacturers in a format compatible with GEM. The test procedures for the torque and motoring curves are found in 40 CFR part 1065. Section II.D.1.b describes these procedures as well as the procedures for generating the engine fuel maps. We require the steady state map approach for the 55 and 65 mph cruise speed cycles, while the cycle average approach is required for the ARB transient cycle. As an option, the cycle average map may also be used for 55 and 65 mph cruise speed cycles. Also similar to tractors, transmission specifications will be input to GEM. Any number of gears may be entered with a numerical ratio for each, and transmission type must be entered as either a Manual, Automated Manual, or Automatic transmission.

As part of the driveline information needed to run GEM, drive axle ratio will be a user input. If a configuration has a two-speed axle, the agencies are adopting regulations to instruct a manufacturer to enter the ratio that is expected to be engaged for the greatest driving distance. We requested comment on whether the agencies should allow this choice, and what the GEM input instructions should be. Both Dana and Meritor commented that there should be an option to recognize two-speed axles, but neither axle supplier offered a preference for how the agencies should implement this. Two-speed axles are typically specified for heavy-haul vehicles, where the higher numerical ratio axle is engaged during transient driving conditions and to deliver performance needed on work

sites, while the lower numerical ratio axle may be engaged during light-load highway driving.

Tire size is a Phase 2 input to GEM that is necessary for the model to simulate the performance of the vehicle. As a result of comment and further technical analysis, we are adopting the tire size input as measured in revs/mile, rather than the measure of loaded radius in meters, as was proposed. The RIA Chapter 3 includes a description of how to measure tire size. For each model and nominal size of a tire, there are numerous possible sizes that could be measured, depending on whether the tire is new or “grown,” meaning whether it has been broken in for at least 200 miles. Size can also vary based on load and inflation levels, air temperature, and tread depth. The agencies requested comment on aspects of measuring and reporting tire size. The revised test procedure is described in the RIA Chapter 3.3.4.

For manufacturers electing to certify a vocational vehicle to the optional custom chassis standards, none of the above driveline inputs are applicable. In this case manufacturers must input one of the custom chassis regulatory subcategory identifiers shown in Table V–32. After the remaining input fields are either completed with values or N/A, GEM will simulate the vehicle by calling the default engine and transmission files, tire size, and axle radius from the GEM library. The following subsections describe the required and optional inputs for custom chassis.

TABLE V–32—CUSTOM CHASSIS SUBCATEGORY NAMES

Vehicle type	Regulatory subcategory GEM identifier	Default weight class and duty cycle
Motor Home .....	MHD_CC_MH .....	MHD Regional.
School Bus .....	MHD_CC_SB .....	MHD Urban.
Coach Bus .....	HHD_CC_CB .....	HHD Regional.
Emergency Vehicle .....	HHD_CC_EM .....	HHD Urban.
Concrete Mixer .....	HHD_CC_CM .....	HHD Urban.
Transit and Other bus .....	HHD_CC_OB .....	HHD Urban.
Refuse Truck .....	HHD_CC_RF .....	HHD Urban.

The agencies requested comments on the merits of using an equation-based compliance approach for emergency vehicle manufacturers, similar to the approach for trailer manufacturers described in Section IV.F. CARB commented in support of an equation-based compliance approach, but in the same comment they also expressed support for using a Phase 1-style GEM interface with a default engine

simulated in GEM as appropriate for the emergency vehicle category. We received adverse comment on the equation-based approach from Daimler, because they believed it would make the compliance process more complex if some vehicles needed to be tracked differently. Our intent in soliciting comment on an equation-based approach was to assess whether running GEM was a burden for non-diversified

manufacturers of low-technology vehicles. Because we received sufficient support from non-diversified manufacturers that a simplified GEM would meet their needs, we did not pursue an equation-based approach.

The final certification approach is consistent with the approach recommended by the Small Business Advocacy Review Panel, which believed it will be feasible for small emergency

vehicle manufacturers to install a Phase 2-compliant engine, but recommended a simplified certification approach to reduce the number of required GEM inputs.

(ii) Idle Reduction Inputs

The agencies proposed two different idle reduction inputs for vocational vehicles: Neutral idle and stop-start. Based on comment, we are adding a third type of idle reduction input: Automatic engine shutdown. Based on user inputs derived from engine testing described in Section II and RIA Chapter 3.1, GEM will calculate CO<sub>2</sub> emissions and fuel consumption at both zero torque (neutral idle) and with torque set to Curb-Idle Transmission Torque for automatic transmissions in “drive” (as described in the RIA Chapter 3.4.2.3) for use in the CO<sub>2</sub> emission calculation in 40 CFR 1037.510(b). At proposal, neutral idle and stop-start were not recognized during the ARB transient cycle, they were recognized only during the separate idle cycle. The agencies received comments requesting recognition of neutral idle during the ARB transient test cycle. We agree this is desirable and have adopted changes in GEM to accomplish this. Also, with the adoption of the alternative engine mapping procedure for the ARB transient cycle, the computation for idle reduction has changed. Please see RIA

Chapter 4.4.1.7 for a description of how GEM recognizes idle reduction.

For vocational custom chassis certified to the optional standards, all three idle reduction inputs will be available, however, the computation will be based on the EPA default engine. As described in the GEM User Guide, users will enter Y or N, and GEM will return a predefined improvement.

(iii) Weight Reduction Inputs

In Phase 1, the agencies adopted tractor regulations that provided manufacturers with the ability to utilize high strength steel and aluminum components for weight reduction without the burden of entering the curb weight of every tractor produced. In Phase 2, the agencies are adopting a lookup table of lightweight components for use in certifying vocational vehicles, similar to the process for tractors. As noted above, the agencies will recognize weight reduction by allocating one half of the weight reduction to payload in the denominator, while one half of the weight reduction will be subtracted from the overall weight of the vehicle in GEM.

The agencies are adopting lookup values for components on vocational vehicles in all HD weight classes. Components available for vocational vehicle manufacturers to select for weight reduction are shown below in

Table V–33, below. All of these weight reduction inputs will be available for manufacturers of custom chassis certifying to the optional standards. We received comments from Allison Transmission noting that aluminum transmission cases and clutch housings are standard for automatic transmissions so we agree it is inappropriate to include these components in the lookup table. We have revised the values in response to adverse comments from AISI, and after reevaluating information available at proposal. Although we are not projecting any adoption of permanent 6x2 axles for non-custom vocational vehicles, if a manufacturer chooses to apply this technology for class 8 vocational vehicles, users may enter an appropriate weight reduction compared to the traditional 6x4 axle configuration.<sup>447</sup> We received adverse comments on the proposal to assign a fixed weight increase to natural gas fueled vehicles to reflect the weight increase of natural gas fuel tanks versus gasoline or diesel tanks. Based on comments and further technical analysis, we have determined that to provide equitable treatment to technologies, we will not require a weight penalty for any technology applied to achieve certification in Phase 2. We accounted for adoption of weight-increasing technologies in our MOVES modeling.

TABLE V–33—PHASE 2 WEIGHT REDUCTION TECHNOLOGIES FOR VOCATIONAL VEHICLES

Component	Material	Vocational vehicle class		
		Class 2b–5	Class 6–7	Class 8
Axle Hubs—Non-Drive .....	Aluminum .....	40		40
Axle Hubs—Non-Drive .....	High Strength Steel .....	5		5
Axle—Non-Drive .....	Aluminum .....	60		60
Axle—Non-Drive .....	High Strength Steel .....	15		15
Brake Drums—Non-Drive .....	Aluminum .....	60		60
Brake Drums—Non-Drive .....	High Strength Steel .....	42		42
Axle Hubs—Drive .....	Aluminum .....	40		80
Axle Hubs—Drive .....	High Strength Steel .....	10		20
Brake Drums—Drive .....	Aluminum .....	70		140
Brake Drums—Drive .....	High Strength Steel .....	37		74
Suspension Brackets, Hangers .....	Aluminum .....	67		100
Suspension Brackets, Hangers .....	High Strength Steel .....	20		30
Crossmember—Cab .....	Aluminum .....	10	15	15
Crossmember—Cab .....	High Strength Steel .....	2	5	5
Crossmember—Non-Suspension .....	Aluminum .....	15	15	15
Crossmember—Non-Suspension .....	High Strength Steel .....	5	5	5
Crossmember—Suspension .....	Aluminum .....	15	25	25
Crossmember—Suspension .....	High Strength Steel .....	6	6	6
Driveshaft .....	Aluminum .....	12	40	50
Driveshaft .....	High Strength Steel .....	5	10	12
Frame Rails .....	Aluminum .....	120	300	440
Frame Rails .....	High Strength Steel .....	40	40	87
Wheels—Dual .....	Aluminum .....	150	150	250
Wheels—Dual .....	High Strength Steel .....	48	48	80
Wheels—Wide Base Single .....	Aluminum .....	294	294	588

<sup>447</sup> See NACFE Confidence Findings on the Potential of 6x2 Axles.



TABLE V-33—PHASE 2 WEIGHT REDUCTION TECHNOLOGIES FOR VOCATIONAL VEHICLES—Continued

Component	Material	Vocational vehicle class		
		Class 2b-5	Class 6-7	Class 8
Wheels—Wide Base Single .....	High Strength Steel .....	168	168	336
Permanent 6x2 Axle Configuration .....	Multi .....	N/A	N/A	300

(iv) Other Inputs

Certifying manufacturers may enter values in GEM as applicable for vehicle speed limiters, fairings to reduce aerodynamic drag area, electrified accessories, and tire pressure systems where such features meet the criteria in the regulations at 40 CFR 1037.520.

(b) Test Procedures

Powertrain families are defined in Section II.C.3.b, and powertrain test procedures are discussed in the RIA Chapter 3.6. The results from testing a powertrain configuration using the matrix of tests described in RIA Chapter 3.6 can be applied broadly across all vocational vehicles in which that powertrain will be installed. Powertrain test results become a GEM input file that replaces both the engine input file and transmission input file.

As in Phase 1, the rolling resistance of each tire will be measured using the ISO 28850 test method for drive tires and steer tires planned for fitment to the vehicle being certified. Once the test CRR values are obtained, a manufacturer will declare TRRLs (which may be equal to or higher than the measured values) for the drive and steer tires separately to be input into the GEM. For Phase 2 vocational vehicles, GEM will distribute the vehicle load with 30 percent of the load over the steer tires and 70 percent of the load over the drive tires. With these data entered, the amount of GHG reduction attributed to tire rolling resistance will be incorporated into the overall vehicle compliance value.

The final Phase 2 GEM will accept as inputs results from a transmission efficiency test. A procedure for this was discussed in the NPRM, and received favorable comment. The transmission efficiency test will be optional, but will allow manufacturers to reduce the CO<sub>2</sub> emissions and fuel consumption by designing better transmissions with lower friction due to better gear design and/or mandatory use of better lubricants.

In lieu of a fixed value for low friction axle lubricants as was proposed, the agencies are adopting an axle efficiency test procedure, as was discussed in the NPRM. See 80 FR 40323. The axle efficiency test will be optional, but will allow manufacturers to reduce CO<sub>2</sub>

emissions and fuel consumption through improved axle gear designs and/or mandatory use of low friction lubricants. The agencies are not finalizing any other paths to recognize low friction axle lubricants.

(c) Useful Life and In-Use Standards

Section 202(a)(1) of the CAA specifies that emission standards are to be applicable for the useful life of the vehicle. The standards that EPA and NHTSA are adopting will apply to individual vehicles and engines at production and in use. NHTSA is not adopting in-use standards for vehicles or engines.

Manufacturers may be required to submit, as part of the application for certification, an engineering analysis showing that emission control performance will not deteriorate during the useful life, with proper maintenance. If maintenance will be required to prevent or minimize deterioration, a demonstration may be required that this maintenance will be performed in use. See 40 CFR 1037.241.

EPA will continue the Phase 1 approach to adjustment factors and deterioration factors for vehicles. The technologies on which the Phase 1 vocational vehicle standards were predicated were not expected to have any deterioration of GHG effectiveness in use. However, the regulations provided a process for manufacturers to develop deterioration factors (DF) if they needed. We anticipate that some hybrid powertrain systems may experience some deterioration of effectiveness with age of the energy storage device. We believe the regulations in place currently provide adequate instructions to manufacturers for developing DF where needed. We received comments from Daimler on deterioration factors for engines and the process for extrapolating where DF's are nonlinear. See Section 3.7 of the RTC. Allison Transmission commented that the amount of credits generated for a hybrid system should be dependent, in part, on design limits of batteries. We do not believe any changes are needed because the regulations do account for this by basing the FELs on the highest emissions during the useful life, including any effects from deterioration.

As with engine certification, a chassis manufacturer must design their vehicles to be durable enough to maintain compliance through the regulatory useful life of the vehicle. Factors influencing vehicle-level GHG performance over the life of the vehicle fall into two basic categories: Vehicle attributes and maintenance items. Each category merits different treatment from the perspective of assessing useful life compliance, as each has varying degrees of manufacturer versus owner/operator responsibility. The agencies require manufacturers to explain how they meet these requirements as part of certification.

For vocational vehicles, attributes generally refers to components that are installed by the manufacturer to meet the standard, whose reduction properties are assessed at the time of certification, and which are expected to last the full life of the vehicle with effectiveness maintained as new for the life of the vehicle with no special maintenance requirements. To assess useful life compliance, we will follow a design-based approach that will ensure that the manufacturer has robustly designed these features so they can reasonably be expected to last the useful life of the vehicle.

For vocational vehicles, maintenance items generally refers to items that are replaced, renewed, cleaned, inspected, or otherwise addressed in the preventative maintenance schedule specified by the vehicle manufacturer. Replacement items that have a direct influence on GHG emissions are primarily tires and lubricants, but may also include hybrid system batteries. Synthetic engine oil may be used by vehicle manufacturers to reduce the GHG emissions of their vehicles. Manufacturers may specify that these fluids be changed throughout the useful life of the vehicle. If this is the case, the manufacturer should have a reasonable basis that the owner/operator will use fluids having the same properties. This may be accomplished by requiring (in service documentation, labeling, etc.) that only these fluids can be used as replacements. We received comments from EMA asking us to consider maintenance costs for hybrids. In these final rules, we have quantified

maintenance costs for tire replacement, stop-start, axle lubrication, and hybrids, as described in Section IX.D and the RIA Chapter 7.1.

Aside from those technologies identified above, if the vehicle remains in its original certified condition throughout its useful life, it is not believed that GHG emissions will increase as a result of service accumulation. As in Phase 1, the agencies will therefore allow the use of an assigned deterioration factor of zero where appropriate in Phase 2; however this does not negate the responsibility of the manufacturer to ensure compliance with the emission standards throughout the useful life.<sup>448</sup> Under both Phase 1 and the new Phase program, manufacturers must apply good engineering judgment when considering deterioration and may not ignore any evidence that the emissions performance will decline during actual use. The agencies may require vehicle manufacturers to provide engineering analyses at the time of certification demonstrating that vehicle attributes will last for the full useful life of the vehicle. We anticipate this demonstration would often need only show that components are constructed of sufficiently robust materials and design practices so as not to become dysfunctional under normal operating conditions.

In Phase 1, EPA set the useful life for engines and vehicles with respect to GHG emissions equal to the respective useful life periods for criteria pollutants. In April 2014, as part of the Tier 3 light-duty vehicle final rule, EPA extended the regulatory useful life period for criteria pollutants to 150,000 miles or 15 years, whichever comes first, for Class 2b and 3 pickup trucks and vans and some light-duty trucks (79 FR 23414, April 28, 2014). Class 2 through Class 5 heavy-duty vehicles subject to the GHG standards described in this section for vocational applications generally use the same kinds of engines, transmissions, and emission controls as the Class 2b and 3 vehicles that are chassis-certified to the criteria standards under 40 CFR part 86, subpart S. In Phase 2, EPA and NHTSA are adopting a useful life of 150,000 miles or 15 years for vocational vehicles at or below 19,500 lbs GVWR. In many cases, this will result in aligned useful-life values for criteria and GHG standards. Where this longer useful life is not aligned with the useful life that applies for criteria

<sup>448</sup> For most technologies, manufacturers may presume zero deterioration unless good engineering judgment does not support such a presumption. For example, it would not be appropriate to presume no deterioration in hybrid battery performance.

standards (generally in the case of engine-based certification under 40 CFR part 86, subpart A), EPA may revisit the useful-life values for both criteria and GHG standards in a future rulemaking. For medium heavy-duty vehicles (19,500 to 33,000 lbs GVWR) and heavy heavy-duty vehicles (above 33,000 lbs GVWR) EPA will keep the useful-life values from Phase 1, which are 185,000 miles (or 10 years) and 435,000 miles (or 10 years), respectively. EPA received comments in support of this approach, including support for the numerical values and the overall process envisioned for achieving the long-term goal of adopting harmonized useful-life specifications for criteria pollutant and GHG standards that properly represent the manufacturers' obligation to meet emission standards over the expected service life of the vehicles.

We received comment on what policies we should adopt to address the situation where the engine and the vehicle are subject to emission standards over different useful-life periods. For example, a medium heavy-duty engine may power vehicles in weight classes ranging from 2b to 8, with correspondingly different regulatory useful lives for those vehicles. Please see Section I.F.2.f for a discussion of revisions made to the final regulations to address this situation. The Response to Comments also addresses this issue at Chapter 1.4.

#### (d) Definitions of Custom Chassis

Eligible emergency vehicles for Phase 2 purposes are ambulances and fire trucks. The agencies requested comment on aligning the definition of emergency vehicle for purposes of the Phase 2 program with the definition of emergency vehicle for purposes of the light-duty GHG provisions under 40 CFR 86.1818, which includes additional vehicles such as those used by law enforcement.<sup>449</sup> Daimler commented in support of aligning these definitions of emergency vehicle. Daimler further requested the agencies consider adopting the same definition as in 13 CCR 1956.8(a)(6), the California regulations. We are adopting the narrow definition as was proposed, with agency discretion to apply these provisions to similar vehicles.

RVIA commented in favor of adopting a motor home definition consistent with NHTSA's definition at 49 CFR 571.3: *Motor home* means a multipurpose passenger vehicle with motive power that is designed to provide temporary residential accommodations, as

<sup>449</sup> See 40 CFR 86.1803-01 for the applicable definition of emergency vehicle.

evidenced by the presence of at least four of the following facilities: Cooking; refrigeration or ice box; self-contained toilet; heating and/or air conditioning; a potable water supply system including a faucet and a sink; and a separate 110–125 volt electrical power supply and/or propane. The agencies are adopting a definition of motor home that is generally consistent with this, without specifying detailed features.

Since 2003, NHTSA has implemented a broad definition of school bus that includes multifunction school activity buses that don't have stop arms or flashing lights, need not be painted yellow, and do not have an upper weight limit. These are a category of school bus that must meet the school bus structural standards or the equivalent set forth in 49 Code of Federal Regulations Part 571, and the emergency exit requirements specified in FMVSS No. 217 for school buses, as well as FMVSS 222 for passenger seating and crash protection. This definition was created in part to allow for use of safe buses to transport school age children on trips other than those between home and school. The agencies are adopting Phase 2 provisions such that buses eligible to certify to the custom chassis school bus standards are those that meet NHTSA's definition of school bus, including multifunction school activity buses.<sup>450</sup>

The most definitive attribute we have identified to distinguish over-the-road coach buses from transit buses is whether passengers are permitted to stand while the vehicle is driving. Therefore the only buses permitted to certify to the final custom chassis coach bus standards are those subject to NHTSA's Occupant Crash Protection Rule.<sup>451</sup>

Allied Specialty Vehicles (aka Rev Group) commented on the need for a clear distinction between transit buses and school buses.<sup>452</sup> If the pupils transported are not K–12 students, such as may be the case for buses serving college campuses, then the chassis may not be easily distinguishable from transit buses. The agencies are adopting provisions in Phase 2 such that buses not qualifying as eligible to certify as coach buses or school buses must meet the custom chassis standards for transit

<sup>450</sup> See 68 FR 44892—Federal Motor Vehicle Safety Standards; Definition of Multifunction School Activity Bus; <https://www.govinfo.gov/content/pkg/FR-2003-07-31/pdf/03-19457.pdf>.

<sup>451</sup> See Occupant Crash Protection rule, November 25, 2013, 78 FR 70415, 49 CFR 571, FMVSS 208 <https://www.gpo.gov/fdsys/pkg/FR-2013-11-25/html/2013-28211.htm>, accessed February 2016.

<sup>452</sup> Phone conversation March 2016, see L. Steele phone log.

buses. Buses serving college campuses do not have the same design and safety restrictions as those intended to transport primary and secondary school children, and may apply the same technologies as general-purpose urban buses.

Therefore, we are requiring refuse trucks that do not compact waste to be certified to the primary vocational vehicle standards. Front-loading refuse collection vehicles tend to have a relatively low number of stops per day as they tend to collect waste from central locations such as commercial buildings and apartment complexes. Because these have a relatively low amount of PTO operation, we expect stop-start will be reasonably effective for these vehicles. Rear-loading and side-loading neighborhood waste and recycling collection trucks are the refuse trucks where the largest number of stop-start and neutral idle over-ride conditions are likely to be encountered. Because chassis manufacturers, even those with small production volumes and close customer relationships, do not always know whether a refuse truck will be a front-loader, rear-loader, or side loader, we are grouping these together in a subcategory.

We received comment on the need to clarify whether vehicles designed to pump and convey concrete at a job site, but which do not carry the wet mix concrete to the job site, would be included in the definition of cement mixers. Although we are not defining other vehicles as cement mixers, we are allowing miscellaneous vocational vehicles meeting some but not all of the eligibility criteria at 40 CFR 1037.631 to be certified under the custom chassis program, using technology equivalent to the cement mixer package, as described above in Section V.B.

#### (e) Assigning Vehicles to Subcategories

In the NPRM, the agencies proposed criteria by which a vehicle manufacturer would know in which vocational subcategory—Regional, Urban, or Multipurpose—the vehicle should be certified. These cut-points were defined using calculations relating engine speed to vehicle speed. 80 FR 40287–40288. Specifically, we proposed a cutpoint for the Urban duty cycle where a vehicle at 55 mph would have an engine working above 90 percent of maximum engine test speed for vocational vehicles powered by diesel engines and above 50 percent for vocational vehicles powered by gasoline engines. Similarly, we proposed a cutpoint for the Regional duty cycle where a vehicle at 65 mph would have an engine working below 75 percent of maximum engine test speed

for vocational vehicles powered by diesel engines and below 45 percent for vocational vehicles powered by gasoline engines. We received several comments that identified weaknesses in that approach. Specifically, Allison explained that vehicles with two shift schedules would need clarification which top gear to use when calculating the applicable cut-point. Also, Daimler noted that, to the extent that downspeeding occurs in this sector over the next decade or more, cutpoints based on today's fleet may not be valid for a future fleet. Allison noted that the presence of additional top gears could strongly influence the subcategory placement of vocational vehicles. These comments highlight the possibility of misclassification, and the potential pitfalls in a mandated classification scheme.

Two commenters pointed out important weaknesses in this approach, namely that future trends in engine speeds, torque curves, and transmission gear ratio spreads may cause the vocational fleet of 2027 to have drivelines that are sufficiently different than those of the baseline fleet, so that segment cut-points based on the 2016 fleet may not be valid a decade or more into the future. For example, if data on today's fleet indicated an appropriate cut-point for Regional HHD diesel vehicles of 1,400 rpm engine speed with a vehicle speed of 65 mph, while a future fleet might show that Regional vehicles operated at 1,200 rpm at 65 mph, then having a cut-point set by rule at 1,400 rpm could result in an excess of future vehicles certifying as Regional. However, we have further assessed the impact of manufacturers shifting certification of chassis from Multipurpose to Regional subcategories, and we have concluded this is not an unacceptable outcome. As explained above in Section V.C.(2)(d), we are not particularly concerned that adopting final standards with unequal percent improvements poses a danger of losing environmental benefits from this program, as long as vehicle configurations are properly classified at the time of certification.

In a regulatory structure where baselines are equal but future standards for vehicles in different subcategories have different stringencies, the agencies would typically assign subcategorization based on regulatory criteria rather than allowing the manufacturers unconstrained choice because manufacturers would have a strong incentive to simply choose the least stringent standards. However, because the baseline performance levels of the different vocational vehicle

regulatory subcategories widely differ, the agencies have determined that it is acceptable to adopt standards with unequal percent stringencies. Further discussion of our reasons for this determination is presented above in Section V.C.(2)(d). Another weakness in the proposed approach was that even though we have obtained a great deal of data thanks to manufacturer cooperation and NREL duty cycle analysis, the only one of the proposed regulatory cut-points in which we have a high degree of confidence is the cut-point between Regional and Multipurpose class 8 diesels. Any cut-points we could establish based on available data for lower weight class diesels or for gasoline powered vocational vehicles would be less robust. These weaknesses have led the agencies to take a different approach to assigning vehicles to subcategories. The agencies are adopting final regulations that generally allow manufacturers to choose a subcategory, with a revised set of constraints as well as a provision requiring use of good engineering judgment. The constraints discussed here are being adopted as interim provisions in response to manufacturers' concerns that some of them could present competitive disadvantages, where different manufacturers produce very different sales mixes of vehicles equipped with different transmission types, as discussed above in Section V.C.(2)(d).

Because the baseline configurations against which vehicles in the Urban subcategories will measure their future performance do not include any manual transmissions, we have determined that vocational vehicles with manual transmissions may not be certified as Urban. In the real world, we do not expect any vehicles intended to be used in urban driving patterns will be specified with manual transmissions. Driver fatigue and other performance problems make this an illogical choice of transmission, and thus it is appropriate for us to adopt this constraint. As described in Chapter 2.9.2 of the RIA, both the HHD Regional and HHD Multipurpose baselines have a blend of manual transmissions, although the majority of manuals are in the HHD Regional baseline. Further, by MY 2024, our adoption rate of transmission technology reflects zero manuals in HHD Multipurpose. Thus, beginning in MY 2024, any vocational vehicle certified with a manual transmission must be classified in a Regional subcategory, except a vehicle with a hybridized manual transmission may be certified in a Multipurpose subcategory beyond MY 2024.

We are not adopting constraints on vehicles with automated manual transmissions certifying in either Regional or Multipurpose subcategories, because we believe this is a technology that can provide real world benefits for vehicles with those driving patterns. However, we are adopting an interim constraint to prevent vehicles with AMT from being certified as Urban for a reason similar to one described above for manuals, namely that in the real world, we do not expect any vehicles intended to be used in urban driving patterns will be specified with transmissions that do not have powershifts. Lack of smooth shifting characteristics during low speed accelerations and decelerations make AMT an illogical choice of transmission for urban vehicles, and thus it is appropriate for us to adopt this constraint.

Dual clutch transmissions have very recently become available for medium heavy-duty vocational vehicles and very little data are available on their design or performance. We anticipate that in the future, some designs may have features that make them perform similarly to AMT's while others may have features that make them more similar to automatics with torque converters. Because we are not confident that we know in which duty cycle(s) they are best suited, we are adopting a partial constraint on these, namely that dual clutch transmissions without powershifting must also be constrained out of Urban. We are finalizing as proposed that any vehicle whose engine is exclusively certified over the SET must be certified in the Regional subcategory. Further, to the extent manufacturers of intercity coach buses and recreational vehicles certify these to the primary standards, these also must be certified as Regional vehicles.<sup>453</sup>

In the final regulatory structure, although the standards for vehicles in different subcategories have different percent stringencies from each baseline, the agencies can allow the manufacturers to choose without risking a loss of environmental benefits because a standard that may appear less stringent in terms of relative improvement from each respective baseline may also be numerically lower (and farther away from current model

performance) due to a comparatively better-performing regulatory baseline. As explained above, the final standards described above in Section V.C.(2)(c) are derived directly from the technology packages without applying any assumptions about fleet averages. Thus, unlike at proposal, the final regulations will generally allow manufacturers to certify in the particular duty-cycle subcategory they believe to be most appropriate. Manufacturers may make this choice as part of the certification process and will not be allowed to change it after the vehicle has been introduced into commerce. Under this structure, the agencies expect manufacturers to choose a subcategory for each vehicle configuration that best represents the type of operation that vehicle will actually experience in use (presuming the manufacturer and customer would specify the technologies to reflect such operation).

## (2) Other Compliance Provisions

### (a) Emission Control Labels

As proposed, EPA is removing the requirement to include the emission control system identifiers required in 40 CFR 1037.135(c)(6) and in Appendix III to 40 CFR part 1037 from the emission control labels for vehicles certified to the Phase 2 standards. For vehicles certified to the optional custom chassis standards, the label should meet the requirements of 40 CFR 1037.105(h). Please see Section I.C.(1)(g) of this Preamble for additional discussion of labeling.

### (b) End of Year Reports

In the Phase 1 program, manufacturers participating in the ABT program provided 90 day and 270 day reports to EPA and NHTSA after the end of the model year. The agencies adopted two reports for the initial program to help manufacturers become familiar with the reporting process. For the HD Phase 2 program, the agencies proposed to simplify reporting such that manufacturers would only be required to submit the final report 90 days after the end of the model year with the potential to obtain approval for a delay up to 30 days. We requested comments on this approach. EMA, PACCAR, Navistar, Daimler, and Cummins recommended keeping the 270 day report to allow sufficient time after the production period is completed. We are accordingly keeping both the 90 day and 270 day reports, with the ability of the agencies' to waive the 90 day report.

### (c) Delegated Assembly

The final standards for vocational vehicles are based on the application of

a wide range of technologies. Certifying vehicle manufacturers manage their compliance demonstration to reflect this range of technologies by describing their certified configurations in the application for certification. In most cases, these technologies are designed and assembled (or installed) directly by the certifying vehicle manufacturer, which is typically the chassis manufacturer. In these cases, it is straightforward to assign the responsibility to the certifying vehicle manufacturer for ensuring that vehicles are in their proper certified configuration before they are introduced into commerce. In Phase 1, the only vehicle technology available for certified vocational vehicles is LRR tires. Because these are generally installed by the chassis manufacturer, there is no need to rely on a second stage manufacturer for purposes of certification in Phase 1, unless innovative credits are sought. Thus, the Phase 1 regulations did not specify precise procedures for this.

In Phase 2, the agencies are projecting adoption of certain technologies where the certifying vehicle manufacturer may want or need to rely on a downstream manufacturing company (a secondary vehicle manufacturer) to take steps to assemble or install certain components or technologies to bring the vehicle into a certified configuration. A similar relationship between manufacturers applies with aftertreatment devices for certified engines. EPA previously adopted "delegated assembly" provisions for engines at 40 CFR 1068.261 to describe how manufacturers can share compliance responsibilities through these cooperative assembly procedures, and proposed to also apply it for vehicle-based GHG standards in 40 CFR part 1037, including the vocational vehicle standards.

The delegated assembly provisions being finalized for Phase 2 vehicle standards are only invoked if a certifying manufacturer includes in its certified configuration a technology that it does not install itself. Examples may include fairings to reduce aerodynamic drag, air conditioning systems, automatic tire inflation systems, or hybrid systems. We are clarifying this regulatory process to enable manufacturers to include technologies in their compliance plans that might otherwise not be considered on the basis of what they can install themselves. To the extent certifying manufacturers rely on secondary vehicle manufacturers to bring the vehicle into a certified configuration, the following provisions will apply:

<sup>453</sup> Based on NREL drive cycle analysis of the existing fleet, we imagine that HHD vehicles with a diesel engine rpm of 1,400 and below when the vehicle is at 65 mph would be appropriately certified as Regional vehicles. However, this is illustrative only, and the final rules do not include an engine speed cutpoint as a criterion in subcategory selection.

- The certifying manufacturer will describe its approach to delegated assembly in the application for certification.
- The certifying manufacturer will create installation instructions to describe how the secondary vehicle manufacturer will bring the vehicle into a certified configuration.
- The certifying manufacturer must take additional steps for certified configurations that include hybrid powertrain components, auxiliary power units, aerodynamic devices, or natural gas fuel tanks. In these cases, the certifying manufacturer must have a contractual agreement with each affected secondary vehicle manufacturer obligating the secondary vehicle manufacturer to build each vehicle into a certified configuration and to provide affidavits confirming proper assembly procedures, and to provide information regarding deployment of each type of technology (if there are technology options that relate to different GEM input values).

See Section I.F of this Preamble and Section 1.4.4 of the RTC for further discussion of the comments received on delegated assembly provisions.

The agencies have developed the delegated-assembly and other provisions in 40 CFR 1037.620—1037.622 to clarify how manufacturers have shared and separate responsibilities for complying with the regulations. Vocational vehicles are the most likely vehicle types to involve both primary and secondary manufacturers; however, other types of vehicles may also involve multiple manufacturers, so these regulatory provisions apply to all vehicles.

Secondary manufacturers (such as body builders) that build complete vehicles from certified chassis are obligated to comply with the emission-related installation instructions provided by the certifying manufacturer. Secondary manufacturers that build complete vehicles from exempted chassis are similarly obligated to comply with all of the regulatory provisions related to the exemption.

#### (d) Demonstrating Compliance With HFC Leakage Standards

EPA's requirements for vocational chassis manufacturers to demonstrate reductions in direct emissions of HFC in their A/C systems and components through a design-based method. The method for calculating A/C leakage is the same as was adopted in Phase 1 for tractors and HD pickups and vans. It is based closely on an industry-consensus leakage scoring method, described below. This leakage scoring method is

correlated to experimentally-measured leakage rates from a number of vehicles using the different available A/C components. As is done currently for other HD vehicles, vocational chassis manufacturers will choose from a menu of A/C equipment and components used in their vehicles in order to establish leakage scores, to characterize their A/C system leakage performance. The percent leakage per year will then be calculated as this score divided by the system refrigerant capacity. We received comments from transit bus manufacturers with concerns that the air conditioning systems on their vehicles are much larger and more complex than systems on typical heavy-duty trucks. As such, they questioned whether our HFC leakage compliance process was valid for their vehicles. Based on information provided by suppliers of air conditioning systems for large buses, we believe some unusually large systems may include components not adequately represented by those listed in the standard compliance procedure, namely the hoses, fittings or seals may not be listed with realistic leakage rates. Therefore EPA is adopting in this final rule provisions allowing use of an alternate compliance procedure where an air conditioning system with refrigerant charge capacity greater than 3,000 grams is installed in a Phase 2 vocational vehicle.

Consistent with the light-duty rule and the Phase 1 program for other HD vehicles, vocational chassis manufacturers will compare the components of a vehicle's A/C system with a set of leakage-reduction technologies and actions that is based closely on that developed through the Improved Mobile Air Conditioning program and SAE International (as SAE Surface Vehicle Standard J2727, "HFC-134a, Mobile Air Conditioning System Refrigerant Emission Chart," August 2008 version). See generally 75 FR 25426. The SAE J2727 approach was developed from laboratory testing of a variety of A/C related components, and EPA believes that the J2727 leakage scoring system generally represents a reasonable correlation with average real-world leakage in new vehicles. This approach associates each component with a specific leakage rate in grams per year that is identical to the values in J2727 and then sums together the component leakage values to develop the total A/C system leakage. Unlike the light-duty program, in the heavy-duty vehicle program, the total A/C leakage score is divided by the value of the total refrigerant system capacity to develop a percent leakage per year.

EPA concludes that the design-based approach results in estimates of likely leakage emissions reductions that are comparable to those that would result from performance-based testing. Where a manufacturer installs an air conditioning system in a vocational vehicle that has a working fluid consisting of an alternate refrigerant with a lower global warming potential than HFC-134a, compliance with the leakage standard is addressed in the regulations at 40 CFR 1037.115. Please see Section I.F.(2)(b) for a discussion related to alternative refrigerants.

Consistent with the HD Phase 1 program and the light-duty rule, where we require that manufacturers attest to the durability of components and systems used to meet the CO<sub>2</sub> standards (see 75 FR 25689), we are requiring that manufacturers of heavy-duty vocational vehicles attest to the durability of these systems, and provide an engineering analysis that demonstrates component and system durability.

#### (e) Glider Vehicles

EPA and NHTSA requested comment on gliders and received extensive comment. The main issues involve standards for rebuilt engines installed in new glider vehicles. These issues are fully addressed in Preamble Section XIII.B and RTC Section 14.2. Of relevance for the vocational vehicle sector, the final standards contain a number of provisions allowing donor engines that are still within their regulatory useful life to be used in new glider vehicles provided the engine meets all standards applicable to the year in which the engine was originally manufactured and also meets one of the following criteria:

- The engine is still within its original useful life in terms of both miles and years.
- The engine has less than 100,000 miles of engine operation.
- The engine is less than three years old.

Thus, if a donor engine meeting one of the above criteria was manufactured before the Phase 1 GHG standards, it would not be subject to those standards when installed in a glider vehicle. Similarly, if such an engine was manufactured before 2010, it would be subject to the pre-2010 criteria pollutant standards corresponding to its year of manufacture. EPA is adopting this provision consistent with the original purpose of glider vehicles as providing a means of salvaging of relatively new powertrains from vehicle chassis that have been damaged or have otherwise failed prematurely. See Section XIII.B of the Preamble.

**(3) Compliance Flexibility Provisions**

EPA and NHTSA are adopting several flexibility provisions in the Phase 2 program. Program-wide compliance flexibilities include an averaging, banking and trading program for CO<sub>2</sub> emissions and fuel consumption credits, provisions for off-cycle credits for technologies that are not included as inputs to the GEM, and advanced technology credits. These are described below as well as in Section I.B.3 to I.C.1. Provisions that are not program-wide include optional chassis certification and a revised interim loose engines provision, as described below.

**(a) Averaging, Banking, and Trading (ABT) Program**

Averaging, banking, and trading of emission credits have been an important part of many EPA mobile source programs under CAA Title II. ABT provisions provide manufacturers flexibilities that assist in the efficient development and implementation of new technologies and therefore enable new technologies to be implemented at a more aggressive pace than without ABT. NHTSA and EPA are carrying-over the Phase 1 ABT provisions for vocational vehicles into Phase 2, as it is an important way to achieve each agency's programmatic goals. ABT is also discussed in Section I and Section III.F.1.

Consistent with the Phase 1 averaging sets, the agencies are allowing chassis manufacturers to average SI-powered vocational vehicle chassis with CI-powered vocational vehicle chassis, within the same vehicle weight class group. In Phase 1, all vocational and tractor chassis within a vehicle weight class group were able to average with each other, regardless of whether they were powered by a CI or SI engine. The Phase 2 approach continues this. The only difference is that in Phase 2, there are different numerical standards set for the SI-powered and CI-powered vehicles, but that does not alter the basis for averaging. This is consistent with the Phase 1 approach where, for example, Class 8 day cab tractors, Class 8 sleeper cab tractors and Class 8 vocational vehicles each have different numerical standards, while they all belong to the same averaging set.

As discussed in V.D.(1)(c), EPA and NHTSA are adopting a revised useful life for LHD vocational vehicles for GHG emissions from the current 10 years/110,000 miles to 15 years/150,000 miles, to be consistent with the useful life of criteria pollutants recently updated in EPA's Tier 3 rule. For the same reasons, EPA and NHTSA are also adopting a

useful life adjustment for HD pickups and vans, as described in Section VI.E.(1). According to the credits calculation formula at 40 CFR 1037.705 and 49 CFR 535.7, useful life in miles is a multiplicative factor included in the calculation of CO<sub>2</sub> and fuel consumption credits. In order to ensure that banked credits will maintain their value in the transition from Phase 1 to Phase 2, NHTSA and EPA are adopting an interim vocational vehicle adjustment factor of 1.36 for credits that are carried forward from Phase 1 to the MY 2021 and later Phase 2 standards.<sup>454</sup> Without this adjustment factor the change in useful life would effectively result in a discount of banked credits that are carried forward from Phase 1 to Phase 2, which is not the intent of the change in the useful life. The agencies do not believe that this adjustment will result in a loss of program benefits because there is little or no deterioration anticipated for CO<sub>2</sub> emissions and fuel consumption over the life of the vehicles. Also, the carry-forward of credits is an integral part of the program, helping to smooth the transition to the Phase 2 standards. The agencies believe that effectively discounting carry-forward credits from Phase 1 to Phase 2 is unnecessary and could negatively impact the feasibility of the Phase 2 standards. EPA and NHTSA requested comment on all aspects of the averaging, banking, and trading program. A complete discussion of the comments on credits and ABT can be found in the RTC Section 1.4.

**(b) Innovative and Off-Cycle Technology Credits**

In Phase 1, the agencies adopted an emissions and fuel consumption credit generating opportunity that applied to innovative technologies that reduce fuel consumption and CO<sub>2</sub> emissions. Eligible technologies were required to not be in common use with heavy-duty vehicles before the 2010MY and not reflected in the GEM simulation tool (*i.e.*, the benefits are "off-cycle"). See 76 FR 57253. In Phase 2, the agencies are re-designating it as an off-cycle technology program. The agencies are maintaining the requirement that, in order for a manufacturer to receive credits for Phase 2, the off-cycle technology must not have been in common use prior to MY 2010.

The agencies recognize that there are emerging technologies today that are being developed, but will not be accounted for in the GEM tool, and therefore will be considered off-cycle. For vocational vehicles, this could

include technologies whose scope and effectiveness surpass those defined and pre-approved in the HD Phase 2 program, such as aerodynamics and electrified accessories. Any credits for these technologies will need to be based on real-world fuel consumption and GHG reductions that can be measured with verifiable test methods using representative driving conditions typical of the engine or vehicle application. More information about off-cycle technology credits can be found at Section I.C.1.c.

As in Phase 1, the agencies will continue to provide two paths for approval of the test procedure to measure the CO<sub>2</sub> emissions and fuel consumption reductions of an off-cycle technology used in vocational vehicles. See 40 CFR 1037.610 and 49 CFR 535.7. The first path will not require a public approval process of the test method. A manufacturer may use "pre-approved" test methods for HD vehicles including the A-to-B chassis testing, powerpack testing or on-road testing. A manufacturer may also use any developed test procedure that has known quantifiable benefits. A test plan detailing the testing methodology will be required to be approved prior to collecting any test data. The agencies are also continuing the second path, which includes a public approval process of any testing method that could have questionable benefits (*i.e.*, an unknown usage rate for a technology). Furthermore, the agencies are adopting revisions to clarify what documentation must be submitted for approval, aligning them with provisions in 40 CFR 86.1869–12. NHTSA is prohibiting credits from technologies addressed by any of its crash avoidance safety rulemakings (*i.e.*, congestion management systems). See also 77 FR 62733 (discussion of similar issue in the light duty greenhouse gas/fuel economy regulations). We received extensive comment on the off-cycle technology approval process. In response to requests to develop a streamlined path for off-cycle technology approval, we are not making fundamental changes from the proposal at this time; however, we remain open to working with stakeholders to look for ways to simplify the process. For example, although we are including specific provisions to recognize certain electrified accessories, recognizing others would require the manufacturer to go through the off-cycle process. However, it is quite possible that the agencies could gather sufficient data to allow us to adopt specific provisions in a future rulemaking to recognize other accessories in a simpler

<sup>454</sup> See 40 CFR 1037.150(o) and 49 CFR 535.7.

manner. Please see Section I.C. of this Preamble for further discussion of off-cycle credits.

There are some technologies that are entering the market today, and although our model does not have the capability to simulate the effectiveness over the test cycles, there are reliable estimates of effectiveness available to the agencies. These will be recognized in our HD Phase 2 certification procedures as pre-defined technologies, and will not be considered off-cycle. Examples of such technologies for vocational vehicles include narrowly-defined types of electrified accessories or aerodynamic improvements. The agencies are specifying default effectiveness values to be used as valid inputs to GEM for each of these. The projected effectiveness of each vocational vehicle technology is discussed in the RIA Chapter 2.9.3.

The agencies' approval for Phase 1 innovative technology credits (approved prior to 2021 MY) will be carried into the Phase 2 program on a limited basis for those technologies where the benefit is not accounted for in the Phase 2 test procedure. Therefore, the manufacturers will not be required to request new approval for any innovative credits carried into the off-cycle program, but will have to demonstrate, as part of the MY 2021 certification, the extent to which the new cycle does not account for these improvements. The agencies believe this is appropriate because technologies, such as those related to the transmission or driveline, may no longer be "off-cycle" because of the addition of these technologies into the Phase 2 version of GEM.

#### (c) Advanced Technology Credits

As described above in Section I, the agencies proposed to discontinue advanced technology credits in Phase 2, which had been intended to promote the early implementation of advanced technologies that were not expected to be widely adopted in the market in the 2014 to 2018 time frame. These technologies were defined in Phase 1 as hybrid powertrains, Rankine cycle engines, all-electric vehicles, and fuel cell vehicles (see 40 CFR 1037.150(p)), at a 1.5 credit value. We requested and received comments on the need for such incentives, and as a result we are not only continuing these credits, we are adopting even greater multipliers than before. See Section I of this Preamble for further discussion of the comments received and the agencies' response regarding advanced technology credits.

#### (d) Optional Chassis Certification

In Phase 2, the agencies are continuing the Phase 1 option to chassis certify vehicles over 14,000 lbs GVWR, but only if there is a family with vehicles at or below 14,000 pounds GVWR that can properly accommodate the bigger vehicles as part of the same family. As adopted in this final rule, chassis-certified vehicles above 14,000 pounds GVWR may not rely on a work factor that is greater than the largest work factor that applies for vehicles at or below 14,000 pounds GVWR from the same family. Applying this work factor constraint avoids the need to set a specific upper GVWR limit on vehicles eligible to use this flexibility. See Section XIII.A.2 of this Preamble, and Section 14.3.2 of the RTC, for further discussion of this issue.

#### (e) Certifying Loose SI Engines in Vocational Vehicles in Phase 2

The agencies proposed not to continue the Phase 1 interim flexibility known as the "loose engine" provision, receiving favorable comment from Cummins and adverse comment on this from Isuzu and AAPC. 80 FR 40331. Under this provision, SI engines produced by manufacturers of HD pickup trucks and vans and sold to chassis manufacturers and intended for use in vocational vehicles need not meet the separate SI engine standard, and instead may be averaged with the manufacturer's HD pickup and van fleet (see 40 CFR 86.1819-14(k)(8)). The agencies are adopting a Phase 2 SI engine standard that is no more stringent than the MY 2016 SI engine standard adopted in Phase 1, while the Phase 2 standards for the HD pickup and van fleet is progressively more stringent through MY 2027. The primary certification path designed in the Phase 1 program for both CI and SI engines sold separately and intended for use in vocational vehicles is that they are engine certified while the vehicle is GEM certified under the GHG rules.

This provision was adopted primarily to address small volume sales of engines used in complete vehicles that are also sold to other manufacturers. The Phase 1 final rules explain that we set the effective date of the Phase 1 SI engine standard as MY 2016 because we projected by this time all manufacturers would have redesigned their gasoline engine offerings to adopt the technologies needed to reduce FTP-cycle emissions by five percent; technologies that cannot simply be bolted on to an existing engine but can only be effectively applied through an integrated design and development

process (76 FR 57180, 57235). The Phase 1 final rules also explain that the compliance flexibility provided by the loose engine provision is technically appropriate because it provides manufacturers with an option to focus their energy on improving the GHG and fuel consumption performance of their complete vehicle products (including engine improvements), rather than on concurrently calibrating for both vehicle and engine test compliance (76 FR 57260). At proposal we noted that although gasoline engine manufacturers have accomplished extensive improvements to comply with HD pickup and vans standards as well as the light-duty vehicle standards, the agencies had not seen evidence of the engine redesigns that we had projected to occur by 2016, and we concluded that discontinuation of this flexibility by MY 2021 was appropriate to provide regulatory certainty on the date beyond which engine certification would be mandatory for HD SI engines.

However, in response to persuasive comments from a chassis manufacturer that purchases these engines, we are adopting a narrow extension of this interim flexibility, where for MYs 2021-2023, each SI engine manufacturer may sell an annual maximum of 10,000 SI engines certified under this provision.<sup>455</sup> We believe this three-year extension is needed to prevent market disruptions. We are concerned that SI engine manufacturers might not choose to certify any SI engines that can be sold to other vocational chassis manufacturers, which would significantly disrupt the market. With this limited extension, we are ensuring no loss of environmental benefits because any vehicle certified by a chassis manufacturer who obtains a high-emitting SI engine must apply additional technology as needed to meet the applicable vocational vehicle standard. We are generally not allowing custom chassis manufacturers to use SI engines that have been certified under this loose engine provision, if they are certifying using one of the custom chassis regulatory subcategories. However, manufacturers certifying motor homes or emergency vehicles to the optional standards may install engines certified through the interim loose engine provision. The typical annual miles driven by these vehicles is very low, usually between 2,000 and 5,000 miles for either motor homes or emergency vehicles, and thus their contribution to emissions and fuel consumption is very small. See Section II of this Preamble for a discussion of

<sup>455</sup> Meeting with Isuzu dated April 22, 2016.



the comments received and the agencies' response on the separate engine standard for SI engines intended for vocational vehicles.

(f) On-Board Diagnostics for Hybrid Vehicle Systems

In HD Phase 1, EPA adopted provisions to delay the onboard diagnostics (OBD) requirements for heavy-duty hybrid powertrains (see 40 CFR 86.010–18(q)). This provision delayed full OBD requirements for hybrids until MY 2016 and MY 2017. The agencies have received comments from hybrid manufacturers regarding their progress toward meeting the on-board diagnostic requirements for criteria pollutant engine certification related to hybrid systems. See Section XIII.A.1 for a discussion of comments received and EPA's response related to certification of engines paired with hybrid powertrain systems.

## VI. Heavy-Duty Pickups and Vans

In the NPRM, the agencies conducted coordinated and complementary analyses using two analytical methods for the heavy-duty pickup and van segment, both of which used the same version of NHTSA's CAFE model to analyze technology. The agencies have also used two analytical methods for the joint final rule. However, unlike the NPRM, for the joint final rule, the agencies are using different versions of NHTSA's CAFE model to analyze technology. The Method B approach continues to use the same version of the model and inputs that was used for the NPRM. Method A uses an updated version of the CAFE model and some updated inputs.

### A. Summary of Phase 1 HD Pickup and Van Standards

In the Phase 1 rule, EPA and NHTSA established GHG and fuel consumption standards and a program structure for complete Class 2b and 3 heavy-duty vehicles (referred to in these rules as "HD pickups and vans"), as described below. The Phase 1 standards began to be phased-in in MY 2014 and the agencies believe the program is working well. The agencies are retaining most elements from the structure of the program established in the Phase 1 rule for the Phase 2 program while establishing more stringent Phase 2 standards for MY 2027, phased in over MYs 2021–2027, that will require additional GHG reductions and fuel consumption improvements. As discussed below, the agencies are adopting the Phase 2 standards as proposed. The MY 2027 standards will

remain in place unless and until amended by the agencies.

Heavy-duty vehicles with GVWR between 8,501 and 10,000 lbs. are classified in the industry as Class 2b motor vehicles. Class 2b includes vehicles classified as medium-duty passenger vehicles (MDPVs) such as very large SUVs. Because MDPVs are frequently used like light-duty passenger vehicles, they are regulated by the agencies under the light-duty vehicle rules. Thus, the agencies did not adopt additional requirements for MDPVs in the Phase 1 rule and are not adopting additional requirements for MDPVs in this rulemaking. Heavy-duty vehicles with GVWR between 10,001 and 14,000 lbs are classified as Class 3 motor vehicles. Class 2b and Class 3 heavy-duty vehicles together emit about 23 percent of today's GHG emissions from the heavy-duty vehicle sector.

About 90 percent of HD pickups and vans are  $\frac{3}{4}$ -ton and 1-ton pickup trucks, 12- and 15-passenger vans, and large work vans that are sold by vehicle manufacturers as complete vehicles, with no secondary manufacturer making substantial modifications prior to registration and use. Most of these vehicles are produced by companies with major light-duty markets in the United States, primarily Ford, General Motors, and Fiat Chrysler. Often, the technologies available to reduce fuel consumption and GHG emissions from this segment are similar to the technologies used for the same purpose on light-duty pickup trucks and vans, including both engine efficiency improvements (for gasoline and diesel engines) and vehicle efficiency improvements.

In the Phase 1 rule, EPA adopted GHG standards for HD pickups and vans based on the whole vehicle (including the engine), expressed as grams of CO<sub>2</sub> per mile, consistent with the way these vehicles are regulated by EPA today for criteria pollutants. NHTSA adopted corresponding gallons per 100 mile fuel consumption standards that are likewise based on the whole vehicle. This complete vehicle approach adopted by both agencies for HD pickups and vans was consistent with the recommendations of the NAS Committee in its 2010 Report. EPA and NHTSA adopted a structure for the Phase 1 HD pickup and van standards that in many respects paralleled long-standing NHTSA CAFE standards and more recent coordinated EPA GHG standards for manufacturers' fleets of new light-duty vehicles. These commonalities include a new vehicle fleet average standard for each manufacturer in each model year and

the determination of these fleet average standards based on production volume-weighted targets for each model, with the targets varying based on a defined vehicle attribute. Vehicle testing for both the HD and light-duty vehicle programs is conducted on chassis dynamometers using the drive cycles from the EPA Federal Test Procedure (Light-duty FTP or "city" test) and Highway Fuel Economy Test (HFET or "highway" test).<sup>456</sup>

For the light-duty GHG and fuel economy<sup>457</sup> standards, the agencies factored in vehicle size by basing the emissions and fuel economy targets on vehicle footprint (the wheelbase times the average track width).<sup>458</sup> For those standards, passenger cars and light trucks with larger footprints are assigned higher GHG and lower fuel economy target levels in acknowledgement of their inherent tendency to consume more fuel and emit more GHGs per mile. EISA requires that NHTSA study "the appropriate metric for measuring and expressing commercial medium- and heavy-duty vehicle and work truck fuel efficiency performance, taking into consideration, among other things, the work performed by such on-highway vehicles and work trucks . . ." See 49 U.S.C. 32902(k)(1)(B).<sup>459</sup> For HD pickups and vans, the agencies also set standards based on a vehicle attribute, but used a work-based metric as the attribute rather than the footprint attribute utilized in the light-duty vehicle rulemaking. Work-based measures such as payload and towing capability are key among the parameters that characterize differences in the design of these vehicles, as well as differences in how the vehicles will be utilized. Buyers consider these utility-based attributes when purchasing a HD pickup or van. EPA and NHTSA therefore finalized Phase 1 standards for HD pickups and vans based on a "work factor" attribute that combines the vehicle's payload and towing capabilities, with an added adjustment

<sup>456</sup> The Light-duty FTP is a vehicle driving cycle that was originally developed for certifying light-duty vehicles and subsequently applied to HD chassis testing for criteria pollutants. This contrasts with the Heavy-duty FTP, which refers to the transient engine test cycles used for certifying heavy-duty engines (with separate cycles specified for diesel and spark-ignition engines).

<sup>457</sup> Light duty fuel *economy* standards are expressed as miles per gallon (mpg), which is inverse to the HD fuel *consumption* standards which are expressed as gallons per 100 miles.

<sup>458</sup> EISA requires CAFE standards for passenger cars and light trucks to be attribute-based; See 49 U.S.C. 32902(b)(3)(A).

<sup>459</sup> The NAS 2010 report likewise recommended standards recognizing the work function of HD vehicles. See 76 FR 57161.



for 4-wheel drive vehicles. See generally 76 FR 57161–57162.

For Phase 1, the agencies adopted provisions such that each manufacturer’s fleet average standard is based on production volume-weighting of target standards for all vehicles that in turn are based on each vehicle’s work factor. These target standards are taken

from a set of curves (mathematical functions). The Phase 1 curves are shown in the figures below for reference and are described in detail in the Phase 1 final rule.<sup>460</sup> The agencies established separate curves for diesel and gasoline HD pickups and vans. The agencies will continue to use the work-based attribute and gradually declining standards

approach for the Phase 2 standards, as discussed in Section VI.B. below. Note that this approach does not create an incentive to reduce the capabilities of these vehicles because less capable vehicles are required to have proportionally lower emissions and fuel consumption targets.

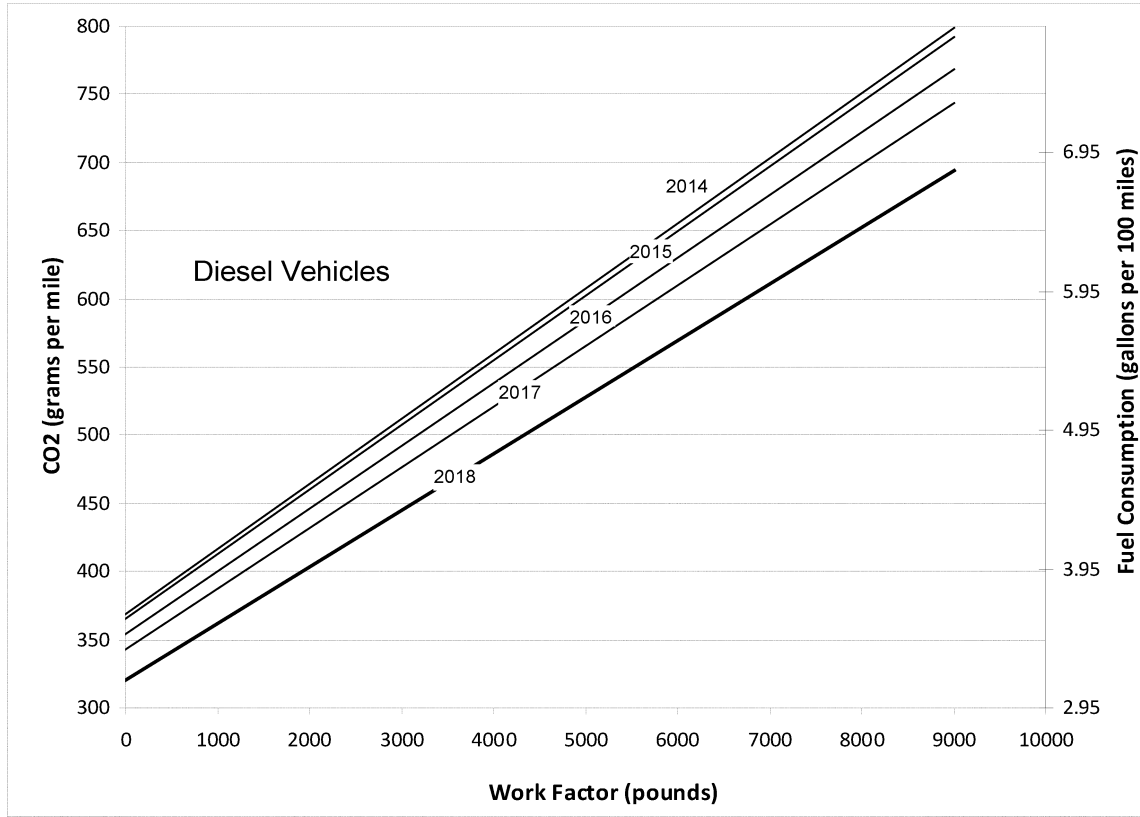

Figure VI-1 EPA Phase 1 CO<sub>2</sub> Target Standards and NHTSA Fuel Consumption Target Standards for Diesel HD Pickups and Vans<sup>461</sup>

<sup>460</sup> The Phase 1 Final Rule provides a full discussion of the standard curves including the equations and coefficients. See 76 FR 57162–57165, September 15 2011. The standards were previously provided in the regulations at 40 CFR 1037.104, but

they are now being redesignated as 40 CFR 86.1819–14.

<sup>461</sup> The NHTSA program provides voluntary standards for model years 2014 and 2015. Target

line functions for 2016–2018 are for the second NHTSA alternative described in the Phase 1 Preamble Section II.C.(d)(ii).

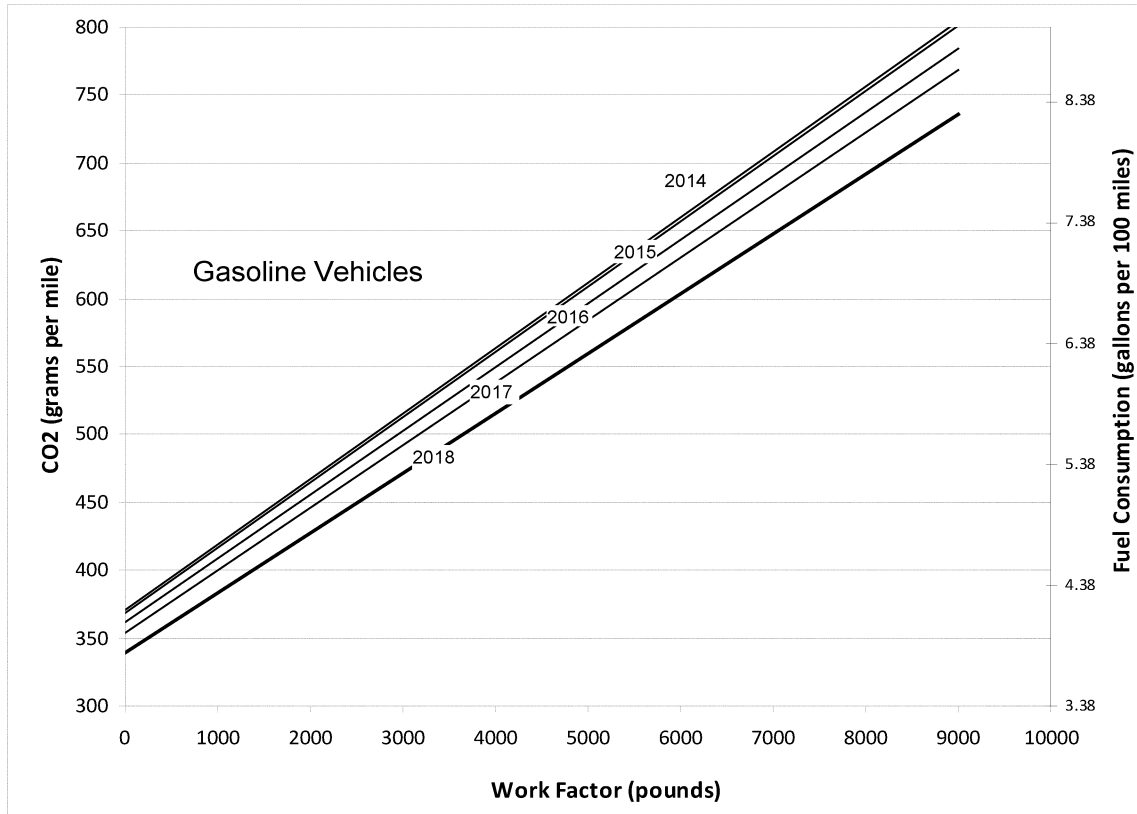

**Figure VI-2 EPA Phase 1 CO<sub>2</sub> Target Standards and NHTSA Fuel Consumption Target Standards for Gasoline HD Pickups and Vans**

EPA phased in its CO<sub>2</sub> standards gradually starting in the 2014 model year, at 15–20–40–60–100 percent of the model year 2018 standards stringency level in model years 2014–2015–2016–2017–2018, respectively. The phase-in takes the form of the set of target standard curves shown above, with increasing stringency in each model year. The final EPA Phase 1 standards for 2018 (including a separate standard to control air conditioning system leakage) represent an average per-vehicle reduction in GHGs of 17 percent for diesel vehicles and 12 percent for gasoline vehicles, compared to a common MY 2010 baseline. EPA also finalized a compliance alternative whereby manufacturers can phase in different percentages: 15–20–67–67–67–100 percent of the model year 2019 standards stringency level in model years 2014–2015–2016–2017–2018–

2019, respectively. This compliance alternative parallels and is equivalent to NHTSA’s first alternative described below.

NHTSA’s Phase 1 program allows manufacturers to select one of two fuel consumption standard alternatives for model years 2016 and later. The first alternative defines individual gasoline vehicle and diesel vehicle fuel consumption target curves that will not change for model years 2016–2018, and are equivalent to EPA’s 67–67–67–100 percent target curves in model years 2016–2017–2018–2019, respectively. This option is consistent with EISA requirements that NHTSA provide 4 years lead-time and 3 years of stability for standards. See 49 U.S.C. 32902(k)(3). The second alternative uses target curves that are equivalent to EPA’s 40–60–100 percent target curves in model years 2016–2017–2018, respectively.

This option is also consistent with EISA lead-time and stability requirements. Stringency for the alternatives in Phase 1 was selected by the agencies to allow a manufacturer, through the use of the credit carry-forward and carry-back provisions that the agencies also finalized, to meet both NHTSA fuel efficiency and EPA GHG emission standards using a single compliance strategy. If a manufacturer cannot meet an applicable standard in a given model year, it may make up its shortfall by over-complying in a subsequent year. NHTSA also allows manufacturers to voluntarily opt into the NHTSA HD pickup and van program in model years 2014 or 2015. For these model years, NHTSA’s fuel consumption target curves are equivalent to EPA’s target curves. The Phase 1 phase-in options are summarized in Table VI–1.

**TABLE VI-1—PHASE 1 STANDARDS PHASE-IN OPTIONS**

	2014 %	2015 %	2016 %	2017 %	2018 %	2019 %
EPA Primary Phase-in .....	15	20	40	60	100	100
EPA Compliance Option .....	15	20	67	67	67	100

TABLE VI-1—PHASE 1 STANDARDS PHASE-IN OPTIONS—Continued

	2014 %	2015 %	2016 %	2017 %	2018 %	2019 %
NHTSA First Option .....	0	0	67	67	67	100
NHTSA Second Option .....	0	0	40	60	100	100

The form and stringency of the Phase 1 standards curves are based on the performance of a set of vehicle, engine, and transmission technologies expected (although not required) to be used to meet the GHG emissions and fuel economy standards for model year 2012–2016 light-duty vehicles, with full consideration of how these technologies are likely to perform in heavy-duty vehicle testing and use. All of these technologies are already in use or have been announced for upcoming model years in some light-duty vehicle models, and some are in use in a portion of HD pickups and vans as well. The technologies include:

- advanced 8-speed automatic transmissions
- aerodynamic improvements
- electro-hydraulic power steering
- engine friction reductions
- improved accessories
- low friction lubricants in powertrain components
- lower rolling resistance tires
- lightweighting
- gasoline direct injection
- diesel aftertreatment optimization
- air conditioning system leakage reduction (for EPA program only)

*B. HD Pickup and Van Final Phase 2 Standards*

As described in this section, NHTSA and EPA are adopting as proposed Phase 2 standards that will be phased in over model years 2021–2027 and continue thereafter unless and until amended. These standards are identical to those proposed as Alternative 3 (the preferred alternative at proposal). The agencies are adopting standards based on a year-over-year increase in stringency of 2.5 percent over MYs 2021–2027 for a total increase in stringency for the Phase 2 program of about 16 percent compared to the MY 2018 Phase 1 standard. Note that an individual manufacturer’s fleet-wide target may differ from this stringency increase due to changes in vehicle sales mix and changes in work factor. We believe the standards the agencies are adopting are feasible in the time frame of this rule.

As discussed in detail below in Sections C through F, the agencies performed separate analyses, which we refer to as “Method A” and “Method B.”

NHTSA considered Method A as the central analysis in its determination of the stringency of the Phase 2 standards. EPA considered the results of Method B as the central analysis for its determination of the stringency of the Phase 2 standards. These analyses are complementary, and independently support the same conclusion.

In the proposal, the agencies also sought comment on a number of alternatives, including an alternative (‘Alternative 4’) which would have resulted in approximately the same stringency increase, but would have done so two years earlier (in MY 2025 rather than MY 2027), so that the effective year-over-year stringency would have been 3.5%. The agencies are not adopting this alternative. The agencies’ analyses show that the additional lead-time provided by the Phase 2 standards that the agencies are adopting will allow manufacturers to more fully utilize lower cost technologies over vehicle life-cycles. In addition, under the method B analysis, this would reduce the projected adoption rate of more advanced higher cost technologies such as strong hybrids compared to Alternative 4. As discussed in more detail in E.1 below, both of the considered phase-ins are projected to require comparable penetration rates of several non-hybrid technologies with some approaching 100 percent penetration. However, as discussed below, the additional lead-time provided by the final standards will allow manufacturers more flexibility to implement technologies at later redesigns and refreshes. The agencies received several comments regarding the timing and stringency of the standards. These comments are discussed in detail in Section E.1 below and in Chapter 7 of the Response to Comments document.

When considering potential Phase 2 standards, the agencies anticipate that the technologies listed above that were considered in Phase 1 will continue to be available in the future, if not already applied under Phase 1 standards, and that additional technologies will also be available:

- advanced engine improvements for friction reduction and low friction lubricants

- improved engine parasitics, including fuel pumps, oil pumps, and coolant pumps
- valvetrain variable lift and timing
- cylinder deactivation
- direct gasoline injection
- cooled exhaust gas recirculation
- turbo downsizing of gasoline engines
- Diesel engine efficiency improvements
- downsizing of diesel engines
- 8-speed automatic transmissions
- electric power steering
- high efficiency transmission gear boxes and driveline
- further improvements in accessory loads
- additional improvements in aerodynamics and tire rolling resistance
- low drag brakes
- mass reduction
- mild hybridization
- strong hybridization

Sections VI.C below and Section 2 of the RIA provide a detailed analysis of these and other potential technologies for Phase 2, including their feasibility, costs, and effectiveness and projected application rates for reducing fuel consumption and CO<sub>2</sub> emissions when utilized in HD pickups and vans. Sections VI.D and Section X also discuss the selection of the Phase 2 standards and the alternatives considered.

In addition to EPA’s CO<sub>2</sub> emission standards and NHTSA’s fuel consumption standards for HD pickups and vans, EPA in Phase 1 also finalized standards for two additional GHGs—N<sub>2</sub>O and CH<sub>4</sub>, as well as standards for air conditioning-related HFC emissions. EPA will continue these standards in Phase 2. Also, consistent with CAA section 202(a)(1), EPA finalized Phase 1 standards that apply to HD pickups and vans in use and EPA is likewise adopting in-use standards for these vehicles in Phase 2. All of these standards are discussed in more detail below. Program flexibilities and compliance provisions related to the standards for HD pickups and vans are discussed in Section VI.E.

A relatively small number of HD pickups and vans are sold by vehicle manufacturers as incomplete vehicles, without the primary load-carrying device or container attached. A sizeable

subset of these incomplete vehicles, often called cab-chassis vehicles, are sold by the vehicle manufacturers in configurations with complete cabs plus many of the components that affect GHG emissions and fuel consumption identical to those on complete pickup truck or van counterparts—including engines, cabs, frames, transmissions, axles, and wheels. The Phase 1 program includes provisions that allow manufacturers to include these incomplete vehicles, as well as some Class 4 through 6 vehicles, to be regulated under the chassis-based HD pickup and van program (*i.e.* subject to the standards and chassis certification for HD pickups and vans), rather than under the vocational vehicle program.<sup>462</sup> The agencies are continuing to allow such incomplete vehicles the option of certifying under either the heavy duty pickup and van standards or the standards for vocational vehicles. As in Phase 1, if such an incomplete vehicle is certified as a vocational vehicle, the engine would have to be certified separately to the applicable engine standard.

Phase 1 also includes optional compliance paths for spark-ignition engines identical to engines used in heavy-duty pickups and vans to comply with 2b/3 standards. See 40 CFR 1037.150(m) and 49 CFR 535.5(a)(7). Manufacturers sell such engines as “loose engines” or install these engines in incomplete vehicles that are not cab-complete vehicles. The agencies are providing a temporary loose engine provision for Phase 2 as described in Section V.D.3.e, under Compliance Flexibility Provisions. These program elements are discussed above in Section V.D. on vocational vehicles and XIII.A.2 on engines.

#### (1) Vehicle-Based Standards

For Phase 1, EPA and NHTSA chose to set vehicle-based standards whereby the entire vehicle is chassis-tested. The agencies will retain this approach for Phase 2. About 90 percent of Class 2b and 3 vehicles are pickup trucks, passenger vans, and work vans that are sold by the original equipment manufacturers as complete vehicles, ready for use on the road. In addition, most of these complete HD pickups and vans are covered by CAA vehicle emissions standards for criteria pollutants (*i.e.*, they are chassis tested similar to light-duty), expressed in grams per mile. This distinguishes this category from other, larger heavy-duty vehicles that typically have engines

covered by CAA engine emission standards for criteria pollutants, expressed in grams per brake horsepower-hour. As a result, Class 2b and 3 complete vehicles share both substantive elements and a regulatory structure much more in common with light-duty trucks than with the other heavy-duty vehicles.

Three of these features in common are especially significant: (1) Over 95 percent of the HD pickups and vans sold in the United States are produced by Ford, General Motors, and Fiat Chrysler—three companies with large light-duty vehicle and light-duty truck sales in the United States; (2) these companies typically base their HD pickup and van designs on higher sales volume light-duty truck platforms and technologies, often incorporating new light-duty truck design features into HD pickups and vans at their next design cycle, and (3) at this time most complete HD pickups and vans are certified to vehicle-based rather than engine-based EPA criteria pollutant and GHG standards. There is also the potential for substantial GHG and fuel consumption reductions from vehicle design improvements beyond engine changes (such as through optimizing aerodynamics, weight, tires, and accessories), and a single manufacturer is generally responsible for both engine and vehicle design. All of these factors together suggest that it is still appropriate and reasonable to base standards on performance of the vehicle as a whole, rather than to establish separate engine and vehicle GHG and fuel consumption standards, as is being done for the other heavy-duty categories. The chassis-based standards approach for complete vehicles is also consistent with NAS<sup>463</sup> recommendations and there was consensus in the public comments in the Phase 1 rulemaking supporting this approach. For all of these reasons, the agencies proposed to continue this approach, and there was again supporting consensus in the public comments.

#### (a) Work-Based Attributes

In developing the Phase 1 HD rulemaking, the agencies emphasized creating a program structure that achieves reductions in fuel consumption and GHGs based on how vehicles are used and on the work they perform in the real world. Work-based measures such as payload and towing capability are key among the things that characterize differences in the design of vehicles, as well as differences in how

the vehicles will be used. Vehicles in the 2b and 3 categories have a wide range of payload and towing capacities. These work-based differences in design and in-use operation are key factors in evaluating technological improvements for reducing CO<sub>2</sub> emissions and fuel consumption. Payload has a particularly important impact on the test results for HD pickup and van emissions and fuel consumption, because testing under existing EPA procedures for criteria pollutants and the Phase 1 standards is conducted with the vehicle loaded to half of its payload capacity (rather than to a flat 300 lbs. as in the light-duty program), and the correlation between test weight and fuel use is strong.

Towing, on the other hand, does not directly factor into test weight as nothing is towed during the test. Hence, setting aside any interdependence between towing capacity and payload, only the higher curb weight caused by any heavier truck components plays a role in affecting measured test results. However towing capacity can be a significant factor to consider because HD pickup truck towing capacities can be quite large, with a correspondingly large effect on vehicle design.

We note too that, from a purchaser perspective, payload and towing capability typically play a greater role than physical dimensions in influencing purchaser decisions on which heavy-duty vehicle to buy. For passenger vans, seating capacity is of course a major consideration, but this correlates closely with payload weight.

For these reasons, as noted above, EPA and NHTSA set Phase 1 standards for HD pickups and vans based on a “work factor” attribute that combines vehicle payload capacity and vehicle towing capacity, in lbs., with an additional fixed adjustment for four-wheel drive (4wd) vehicles. This adjustment accounts for the fact that 4wd, critical to enabling many off-road heavy-duty work applications, adds roughly 500 lbs. to the vehicle weight. The work factor is calculated as follows: 75 percent maximum payload + 25 percent of maximum towing + 375 lbs. if 4wd. Under this approach, target GHG and fuel consumption standards are determined for each vehicle with a unique work factor (analogous to a target for each discrete vehicle footprint in the light-duty vehicle rules). These targets will then be production weighted and summed to derive a manufacturer’s annual fleet average standard for its heavy-duty pickups and vans. There was widespread support (and no opposition) for the work factor-based approach to standards and fleet average approach to compliance expressed in

<sup>462</sup> See 76 FR 57259–57260, September 15, 2011 and 78 FR 36374, June 17, 2013.

<sup>463</sup> The NAS 2010 report. See 76 FR 57161.

the comments we received on the Phase 1 rule.

For Phase 2, the agencies proposed to continue using the work-based attribute. The agencies received a variety of comments on the details of the work factor approach. The agencies received comments from The American Council for an Energy-Efficient Economy (ACEEE) regarding the definition of payload and towing and manufacturer's discretion at determining GVWR, GCWR and curb weight of the vehicle. In response, the formula for payload, GVWR minus curb weight, is specified such that it uses the same definition of the input terms as those which have always been used by the agencies for light and heavy duty vehicle regulations, including criteria pollutant emission standards and safety related designations. The agencies feel that there is no ambiguity in the definition of these terms and therefore that payload calculation remains clearly defined with little or no opportunity for manipulation. The agencies have successfully used the previously established definitions of GVWR and curb weight to implement emissions and safety related programs and have not experienced any adverse issues in applying these definitions. The same is true for the definitions of terms used to calculate towing—GCWR minus GVWR. While this definition for towing capacity does not match the method used by manufacturers in their consumer advertising, the agencies determined that the inputs of GCWR and GVWR are clearly defined in our regulations and used for many other emission and safety related determinations and therefore also remain a clear and consistent method to define towing for the purposes of calculating work factor. Again, the agencies have successfully used the previously established definitions of GCWR and have not experienced any issues that would warrant a change to the definition or use of these parameters.

ACEEE commented on recent announcements from two manufacturers that reported increases in payload capacity in their pick-ups due to a decrease in the curb weight of the vehicles from changes to light-weight materials. A reduction in vehicle weight while maintaining the same GVWR will result in a higher payload capacity which will then increase that vehicle's calculated work factor and therefore result in a higher (less stringent) target GHG and fuel consumption standard. Similar to the light-duty (LD) footprint based approach which allows increases in GHG emissions and fuel consumption

with increasing footprints, the work factor is designed to allow increases in GHG emissions and fuel consumption with increases in capability to do work, primarily hauling payload and towing. Decreases in curb weight as described in the comment actually demonstrate that the work factor is operating both appropriately and as the agencies intended. By reducing curb weight, these manufacturers are increasing the work capability of their trucks specifically purchased by consumers to transport payload and (sometimes) to tow. Additional payload capacity, while not always needed, will allow the user to transport more goods resulting in an overall reduction in GHGs and fuel used versus taking additional trips to do the same work. This may differ from light-duty pick-ups where transportation of goods may not be the primary use of the vehicle. Additionally, the reduction in curb weight will be beneficial in all other situations of unloaded and partially loaded transport of goods because a reduction in curb weight of the vehicle results in less energy wasted simply to move the vehicle regardless of payload. For this reason, the agencies included mass reduction as among the technologies on which the stringency of the final standards (as well as the phase 1 standards) is based. Mass reduction is discussed in detail in the technology descriptions section below.

Most of the comments supported the continued use of work factor-based standards for heavy duty pickups and vans. The agencies received several comments regarding surplus towing. The American Automotive Policy Council (AAPC) commented that existing NHTSA Federal Motor Vehicle Safety Standards effectively cap the towing and GCWR in this vehicle segment. Cummins noted that the curves were data-based in Phase 1 and any changes to the curves would require a full study, similar to Phase 1, in order to ensure feasibility and a fair framework for all OEMs. Daimler commented in support of changing weighting of payload to 80 percent and towing to 20 percent of work factor formula and did not oppose a cap on towing. Several commenters supported adopting a mechanism to minimize the incentive the standards provide to increase work factor. ACEEE supported further considering changing the shape of the standards curves, shown below in Figure VI-3 and Figure VI-4, to be flatter at higher work factors. Honeywell commented that towing capacity has increased significantly over the last five years, beyond the needs of most buyers, and that the curves should be flattened

starting at 7,500 lbs, noting that this change would impact less than 10 percent of all class 2b/3 vehicles. The International Council on Clean Transportation (ICCT) similarly suggested a cut point of 5,500 lbs. for gasoline trucks and 8,000 lbs. for diesels, based on these cutpoints being near the 90th percentile for the model year 2014 fleet. The Union of Concerned Scientists (UCS) (like ACEEE) commented that light-weighting is being used to increase payload and also supported leveling off the curves to eliminate the incentive to add payload and towing capacity.

After considering these comments, the agencies concluded that the work factor approach established in the Phase 1 rule appropriately accounts for the different utility aspects of heavy-duty vehicles. While trucks and vans may be used differently depending on the required job, the three main attributes of payload, towing and four wheel drive remain properly accounted for at this time in the work factor equation at the current weightings. While a small portion of the fleet may be considered to have excess towing capacity relative to the actual required towing capacity by the customer, the agencies determined that the work factor design does not necessarily result in an incentive for manufacturers to build excessive towing into the vehicle design. Towing capacity increases require improvements to vehicle powertrains, cooling and brakes, generally at the expense of payload, and therefore the work factor reasonably balances an increase in towing with a reduction in payload. Additionally, increases in vehicle weight for additional towing capacity may result in an increase in the emission test weight, further penalizing unnecessary towing capacity. Moreover, as AAPC discusses in their comments, towing and payload are effectively already capped by existing NHTSA safety requirements in this segment. Consumers will ultimately decide on the appropriate balance of payload and towing for their applications, and the agencies therefore believe that establishing a work factor cap for the small percentage of vehicles with the highest towing capabilities is not necessary and will not result in emission increases or fuel consumption reductions under the high towing conditions for which those vehicles were purchased.

The agencies also received comments regarding making changes to the work factor formula for vans. AAPC commented that the payload, towing, and 4wd inputs do not fully represent the intended uses of cargo and passenger vans, where cargo or

passenger volumes are of primary importance. AAPC recommended that the agencies add a volumetric term to the work factor for vans with high (208 cubic feet or greater) cargo and passenger volumes. Vans with high volumes would have higher work factors and therefore less stringent targets with the AAPC recommended formula compared to the current formula. ACEEE commented that the work factor is a far better predictor of fuel efficiency for pickups than for vans and offered general support for adopting different work factor formulas for pickups and vans.

While it is likely that a portion of the vans are used exclusively for cargo volume and that towing is not an important attribute for these vans, the commenter failed to provide sufficient new information to support a new work factor metric specifically to address cargo focused vans. The commenter's suggested modification does not sufficiently represent the different van cargo volumes available to consumers today. A cargo volume based modification requires a complete industry van analysis of all available van cargo volumes and GHG and fuel economy performance levels from which an appropriately normalized adjustment would be determined, consistent with the approach used to establish the existing work factor equation for the attributes of payload, towing and four wheel drive. The agencies did not receive the level of detailed information required to determine the impact of cargo volume and establish a work factor correlation. Accordingly, the agencies are not incorporating the suggested change to the work factor for vans.

As noted in the Phase 1 rule, the attribute-based CO<sub>2</sub> and fuel consumption standards are meant to be as consistent as practicable from a stringency perspective. Vehicles across the entire range of the HD pickup and van segment have their respective target values for CO<sub>2</sub> emissions and fuel consumption, and therefore all HD pickups and vans will be affected by the standard. With this attribute-based standards approach, EPA and NHTSA continue to believe there should be no significant effect on the relative distribution of vehicles with differing capabilities in the fleet, which means that buyers should still be able to purchase the vehicle that meets their needs.

#### (b) Standards

The agencies are adopting Phase 2 standards as proposed based on analyses performed to determine the

appropriate HD pickup and van Phase 2 standards and the most appropriate phase in of those standards. These analyses, described below and in the Final RIA, considered:

- projections of future U.S. sales for HD pickups and vans
- the estimates of corresponding CO<sub>2</sub> emissions and fuel consumption for these vehicles
- forecasts of manufacturers' product redesign schedules
- the technology available in new MY 2014 HD pickups and vans to specify preexisting technology content to be included in the analysis fleet (the fleet of vehicles used as a starting point for analysis) extending through MY 2030
- the estimated effectiveness, cost, applicability, and availability of technologies for HD pickup and vans
- manufacturers' ability to use credit carry-forward
- the levels of technology that are projected to be added to the analysis fleet through MY 2030<sup>464</sup> considering improvements needed in order to achieve compliance with the Phase 1 standards (thus defining the reference fleet—*i.e.*, under the No-Action Alternative—relative to which to measure incremental impacts of Phase 2 standards), and
- the levels of technology that are projected to be added to the analysis fleet through MY 2030 considering further improvements needed in order to achieve compliance with standards defining each regulatory (action) alternative for Phase 2.

Based on this analysis, EPA is adopting as proposed CO<sub>2</sub> attribute-based target standards shown in Figure VI-3 and Figure VI-4, and NHTSA is adopting as proposed the equivalent attribute-based fuel consumption target standards, also shown in Figure VI-3 and Figure VI-4, applicable in model year 2021–2027. As shown in these figures, the Phase 2 standards will be phased in year-by-year commencing in MY 2021. The agencies did not propose and are not adopting changes to the standards for 2018–2020 and therefore the standards will remain at the MY 2018 Phase 1 levels for MYs 2019 and 2020. EISA requires four years of lead-time and three years stability for NHTSA standards and this period of lead-time and stability for 2018–2020 is thus consistent with the EISA requirements. For MYs 2021–2027, the agencies are finalizing as proposed annual reductions (*i.e.*, increases in

stringency) in the standards. These standards become 16 percent more stringent overall between MY 2020 and MY 2027, compared to the MY 2018 Phase 1 levels. This approach to the Phase 2 standards as a whole can be considered a phase-in or implementation schedule of the MY 2027 standards (which, as noted, will apply thereafter unless and until amended).

For EPA, Section 202(a) (1) provides the Administrator with the authority to establish standards, and to revise those standards "from time to time," thus providing the Administrator with considerable discretion in deciding when to revise the Phase 1 MY 2018 standards. As noted above, EISA requires that NHTSA provide four full model years of regulatory lead time and three full model years of regulatory stability for its fuel economy standards. See 49 U.S.C. 32902(k)(3).

Congress has not spoken directly to the meaning of the words "regulatory stability." NHTSA believes that the "regulatory stability" requirement exists to ensure that manufacturers will not be subject to new standards in repeated rulemakings too rapidly, given that Congress did not include a minimum duration period for the MD/HD standards.<sup>465</sup> NHTSA further believes that standards, which as set provide for increasing stringency during the period that the standards are applicable under this rule to be the maximum feasible during the regulatory period, are within the meaning of the statute. In this statutory context, NHTSA interprets the phrase "regulatory stability" in Section 32902(k)(3)(B) as requiring that the standards remain in effect for three years before they may be increased by amendment. It does not prohibit standards which contain predetermined stringency increases."

Consistent with these authorities, the agencies are adopting more stringent standards beginning with MY 2021, and ending with MY 2027, that consider the level of technology we judge can be applied to new vehicles at reasonable cost to meet the standards. EPA believes the Phase 2 standards are consistent with CAA requirements regarding lead-time, cost, feasibility, and safety. NHTSA believes the Phase 2 standards are the maximum feasible under EISA. Manufacturers in the HD pickup and van market segment have relatively few vehicle lines and redesign cycles are typically longer compared to light-duty vehicles. Also, the timing of vehicle

<sup>464</sup> Although the final standards are implemented in MY 2027, the model looks out to MY 2030 to help account for the potential use of credit carry-forward provisions.

<sup>465</sup> In contrast, light-duty standards must remain in place for "at least 1, but not more than 5, model years." 49 U.S.C. 32902(b)(3)(B).

redesigns differs among manufacturers. To provide lead time needed to accommodate these longer redesign cycles, the Phase 2 GHG standards will not reach their highest stringency until 2027. Although these standards will become more stringent each year between MYs 2021 and 2027, the agencies expect manufacturers will likely make improvements as part of planned redesigns, such that some model years will likely involve significant advances, while other model years will likely involve little change. The agencies also expect manufacturers to use program flexibilities (*e.g.*, credit carry-forward provisions and averaging and banking provisions) to help achieve compliance without compressing redesign schedules and to efficiently manage resources and capital over time. The MY 2018 standards are unchanged in MYs 2019–2020 to provide necessary lead time for the Phase 2 standards. However, some manufacturers may choose to begin implementing technologies earlier (in some cases potentially as soon as MY 2017) depending on their vehicle redesign cycles. Although standards are not changing in MYs 2019–2020, manufacturers may introduce additional technologies in order to earn credits that may be carried-forward under the 5 year credit carry-forward provisions established in Phase 1 and continuing for Phase 2.

The agencies received several comments on the Phase 2 standards and the technological basis and feasibility of the standards. The comments are discussed in Sections VI.D and 0below, which provide additional discussion of vehicle redesign cycles and the feasibility of the final Phase 2 standards, and also in Section 7 of the Response to Comments document.

Recognizing that it is unlikely that there is a phase-in approach that equally fits with all manufacturers' unique product redesign schedules, the agencies requested comments on other ways the Phase 2 standards could be phased in. The agencies suggested one alternative approach would be to phase in the standards in a few step changes, for example in MYs 2021, 2024 and 2027 (as with the standards for vocational vehicles, tractors, trailers, and the heavy duty engine standards). Under this example, if the step changes on the order of 5 percent, 10 percent,

and 16 percent improvements from the MY 2020 baseline in MYs 2021, 2024 and 2027 respectively, the program would provide CO<sub>2</sub> reductions and fuel improvements roughly equivalent to the approach being adopted. EPA did not receive comments on this alternative phase-in approach, which closely resembles the phase-in approach used for the other sectors.

AAPC commented in support of an alternative year-over-year phase-in that would phase-in stringency more gradually than proposed (and now adopted). AAPC recommended that rather than a 2.5 percent per year improvement, the increase should be at 1.75 percent per year through MY 2024 and then 3.5 percent per year for MY 2025 through 2027 with the MY 2027 level of stringency equally the proposed level. AAPC commented that this more gradual approach was consistent with the Phase 1 phase-in approach and would help manufacturers manage the long lead time associated with developing the new vehicles and powertrains that will be required in order to comply with the Phase 2 proposal.

The agencies are finalizing the proposed phase-in rather than adopting the approach recommended by AAPC. The more gradual phase-in recommended by AAPC would result in a loss of program benefits in each of the interim years of the program compared to the promulgated standards until the phase-in caught up with that phase-in in MY 2027. Because of the slower phase-in, the overall reduction in each interim year is lower than the phase-in being finalized. The phase-in adopted for Phase 1 with a more gradual ramp-up in standards took into consideration the shorter lead time associated with the Phase 1 standards and the uncertainty associated with implementing a new program. Phase 2 provides more lead-time than Phase 1 and the agencies believe based on their analyses of the standards that the lead-time provided is sufficient, particularly considering the flexibility also provided by credit carry-forward and carry-back provisions.

As with Phase 1 (and like the light-duty vehicle standards), the Phase 2 standards must be met on a production-weighted fleet average basis. No individual vehicle will have to meet a particular target (or the individual fleet average level). Each manufacturer will

also have its own fleet average standard. Specifically, each manufacturer will have its own unique fleet average requirement based on the production-weighted average of the heavy duty pickups and vans it chooses to produce. Moreover, averaging, banking, and trading provisions, just alluded to and discussed further below, will provide significant additional compliance flexibility in implementing the standards. It is important to note, however, that while the standards will differ numerically from manufacturer to manufacturer, effective stringency should be essentially the same for each manufacturer. The agencies did not receive comments suggesting changes to this general averaging approach to establishing the standards.

Also, as with the Phase 1 standards, the agencies proposed and are finalizing separate Phase 2 targets for gasoline-fueled (and any other Otto-cycle) vehicles and diesel-fueled (and any other diesel-cycle) vehicles. See 80 FR 40337. The targets will be used to determine the production-weighted fleet average standards that apply to the combined diesel and gasoline fleet of HD pickups and vans produced by a manufacturer in each model year. The stringency increase discussed above for Phase 2 applies equally to the separate gasoline and diesel targets. For the proposal, the agencies considered different rates of increase for the gasoline and diesel targets in order to more equally balance compliance burdens across manufacturers with varying gasoline/diesel fleet mixes. However, at least among major HD pickup and van manufacturers, our analyses suggested limited potential for such optimization, especially considering uncertainties involved with manufacturers' future fleet mix. The agencies did not receive comments on the specific topic of maintaining equivalent rates of increase for gasoline and diesel-fueled vehicles. The agencies, however, received several comments regarding maintaining separate standards for the two vehicle types. Some of the comments recommended closing the gap between diesel and gasoline-fueled vehicles by making the gasoline-fueled vehicle standards more stringent. These comments are discussed below.

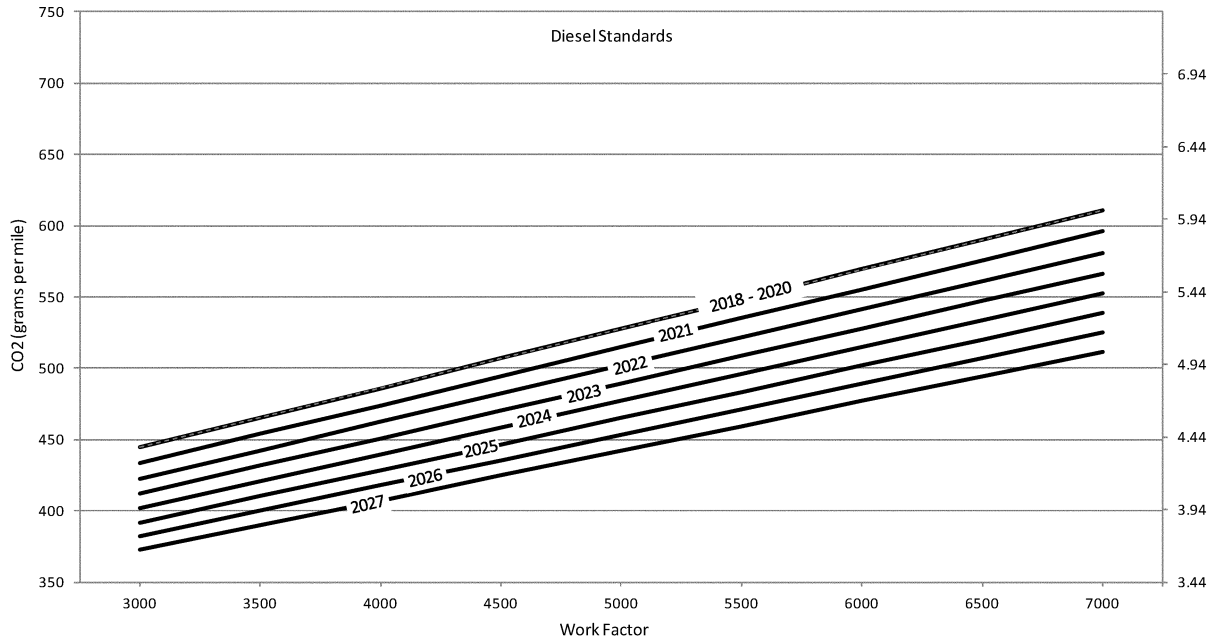

Figure VI-3 EPA Phase 2 CO<sub>2</sub> Target Standards and NHTSA Fuel Consumption Target Standards for Diesel HD Pickups and Vans

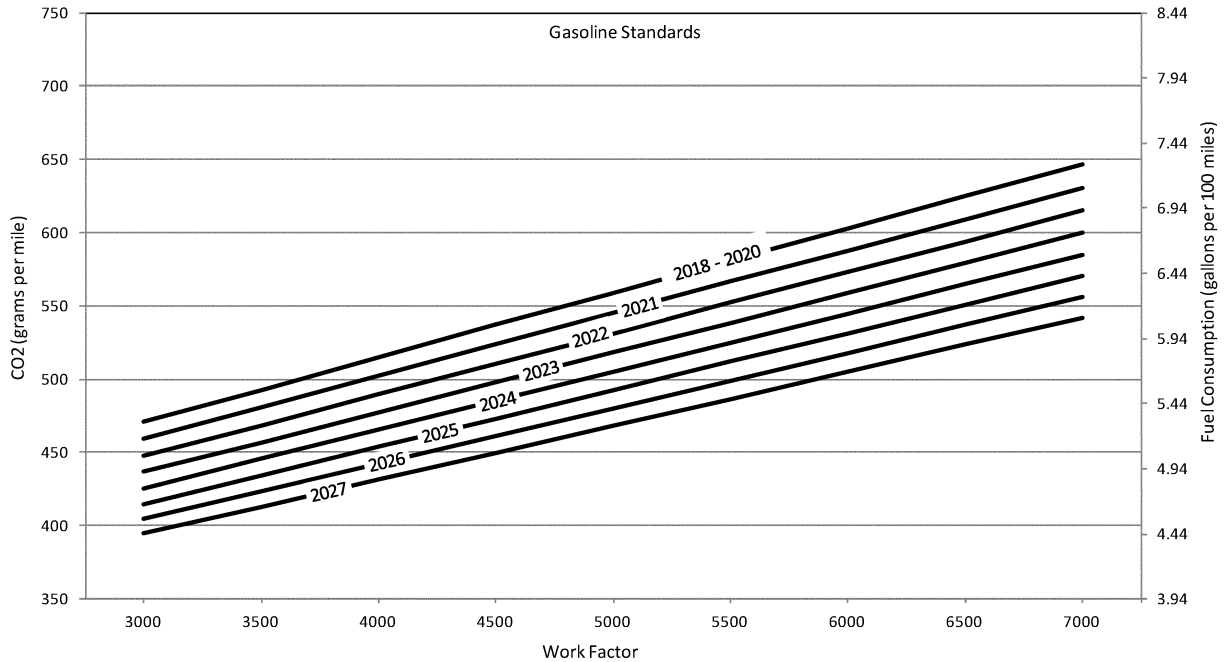

Figure VI-4 EPA Phase 2 CO<sub>2</sub> Target Standards and NHTSA Fuel Consumption Target Standards for Gasoline HD Pickups and Vans

Described mathematically, EPA's and NHTSA's target standards are defined by the following formulas:

$$\text{EPA CO}_2 \text{ Target (g/mile)} = \frac{a \times \text{WF}}{b} +$$

$$\text{NHTSA Fuel Consumption Target (gallons/100 miles)} = [c \times \text{WF}] + d$$

Where:

$$\text{WF} = \text{Work Factor} = [0.75 \times (\text{Payload Capacity} + \text{xwd})] + [0.25 \times \text{Towing Capacity}]$$

$$\text{Payload Capacity} = \text{GVWR (lb.)} - \text{Curb Weight (lb.)}$$

xwd = 500 lbs. if the vehicle is equipped with 4wd, otherwise equals 0 lbs.

$$\text{Towing Capacity} = \text{GCWR (lb.)} - \text{GVWR (lb.)}$$

Coefficients a, b, c, and d are taken from Table VI-2.



TABLE VI-2—PHASE 2 COEFFICIENTS FOR HD PICKUP AND VAN TARGET STANDARDS

Model year	a	b	c	d
<b>Diesel Vehicles</b>				
2018–2020 <sup>a</sup> .....	0.0416	320	0.0004086	3.143
2021 .....	0.0406	312	0.0003988	3.065
2022 .....	0.0395	304	0.0003880	2.986
2023 .....	0.0386	297	0.0003792	2.917
2024 .....	0.0376	289	0.0003694	2.839
2025 .....	0.0367	282	0.0003605	2.770
2026 .....	0.0357	275	0.0003507	2.701
2027 and later .....	0.0348	268	0.0003418	2.633
<b>Gasoline Vehicles</b>				
2018–2020 <sup>a</sup> .....	0.044	339	0.0004951	3.815
2021 .....	0.0429	331	0.0004827	3.725
2022 .....	0.0418	322	0.0004703	3.623
2023 .....	0.0408	314	0.0004591	3.533
2024 .....	0.0398	306	0.0004478	3.443
2025 .....	0.0388	299	0.0004366	3.364
2026 .....	0.0378	291	0.0004253	3.274
2027 and later .....	0.0369	284	0.0004152	3.196

**Note:**

<sup>a</sup>Phase 1 primary phase-in coefficients. Alternative phase-in coefficients are different in MY 2018 only.

As noted above, the agencies did not propose and are not adopting changes from the final Phase 1 standards for MYs 2018–2020. The MYs 2018–2020 standards are shown in the figures and tables above for reference. The agencies did not receive comments recommending changes to the standards in these model years.

NHTSA and EPA have also analyzed regulatory alternatives to these standards, as discussed in Sections VI.D and 0and Section X. below. The agencies requested comment on all of the alternatives analyzed for the proposal, but requested comment on Alternative 4 in particular. The agencies did not propose Alternative 4 because EPA and NHTSA had outstanding questions regarding relative risks and benefits of Alternative 4 due to the timeframe envisioned by that alternative. As noted above, Alternative 4 would have provided less lead time for the complete phase-in of the Phase 2 standards based on an annual improvement of 3.5 percent per year in MYs 2021–2025 compared to the Alternative 3 per year improvement of 2.5 percent in MYs 2021–2027.

In the proposal, the agencies requested comments, data, and information that would help inform determination of the maximum feasible (for NHTSA) and appropriate (for EPA) stringency for HD pickups and vans and are particularly interested in information and data related to the expected adoption rates of different emerging technologies, such as mild and strong hybridization. The agencies received comments both in support of

and not in support of Alternative 4 and also received comments in support of standards more stringent than either the proposal or the Alternative 4 pull ahead. The comments regarding stringency and feasibility are discussed in Sections VI.D and E. As described in these sections, and in Section X and RIA Chapter 11, NHTSA and EPA believe the final Phase 2 standards represent, respectively, the maximum feasible standards under EISA and the most stringent standards reasonably achievable under the CAA considering lead-time, reasonable cost, feasibility, and safety.

As with Phase 1 standards, to calculate a manufacturer's HD pickup and van fleet average standard, the agencies proposed and are finalizing separate target curves for gasoline and diesel vehicles in Phase 2. While diesel and gasoline vehicles have separate work factor-based target standard curves, all of a manufacturer's vehicles are averaged together as a single averaging set to demonstrate compliance. As noted above, the agencies' Phase 2 standards are estimated to result in approximately 16 percent reductions in CO<sub>2</sub> and fuel consumption for both diesel and gasoline vehicles relative to the MY 2018 Phase 1 standards for HD pickup trucks and vans.

The agencies requested comment on both the level of stringency of the standards and the continued separate targets for gasoline and diesel HD pickups and vans. AAPC supported the agencies' proposal to maintain separate targets noting that the approach ensures

that manufacturers of either engine type will implement the latest CO<sub>2</sub> reducing technologies. AAPC further commented that significant technological and market-based differences exist between heavy-duty gasoline and heavy-duty diesel engines. According to the commenter, maintaining separate but comparably stringent spark ignition and compression ignition targets will allow customers for specific applications to take advantage of the combustion technology that best meets their specific application requirements.

Several commenters did not support the proposed approach but instead supported setting a single fuel-neutral set of targets. Cummins commented that there is sufficient lead-time and technology to create a pathway to fuel-neutral targets, and that fuel neutral targets would eliminate any competitive advantage or preference to a particular GHG/FE technology and maintain the environmental benefits envisioned for the program. Daimler, Honeywell, and MEMA similarly commented in support of fuel-neutral standards. Honeywell and Motor and Equipment Manufacturers Association (MEMA) suggested basing the standards on a 16 percent improvement from the projected MY 2018 gasoline/diesel combined baseline. ACEEE and ICCT commented in support of a single set of standards set at or close to the capabilities of diesel technology. These commenters suggested that gasoline engines should be subject to more stringent standards than proposed and that gasoline and diesel engines should be held to the same performance-based standards.

Bosch disagreed with maintaining separate targets for gasoline and diesel HD pickups and vans. Bosch recommended that targets be fuel neutral, as they are in the light-duty vehicle programs. Bosch commented that it “believes that a market shift towards spark-ignited vehicles and away from HD pickups and vans powered by “fundamentally more efficient” CI engines would be a very real possibility under Phase 2 if the separate gasoline and diesel targets are finalized as proposed.” Bosch continues that “any such shift would signify not only a move towards less efficient internal combustion engines, but would be counterproductive from a programmatic/environmental and energy standpoint.” Bosch further commented that “diesels from a criteria pollutant (especially NO<sub>x</sub> emissions perspective, have made far greater strides over the years than gasoline engines, and for that reason have incurred greater technological development costs than the latter. While equivalent CO<sub>2</sub> target values may be more expensive, comparatively speaking, for SI engines to achieve (based on the agencies’ cost analysis), the additional cost imposed on these engines likely would not rise to the level of, much less overtake CI engines’ historically higher technological development and system costs.”

The agencies generally prefer to set standards that do not distinguish between fuel types where technological or market-based reasons do not strongly argue otherwise. However, as with Phase 1, we continue to believe that fundamental differences between spark ignition and compression ignition engines warrant unique fuel standards, which is also important in ensuring that our program maintains product choices available to vehicle buyers. In fact, gasoline and diesel fuel behave so differently in the internal combustion engine that they have historically required unique test procedures, emission control technologies and emission standards. These technological differences between gasoline and diesel engines for GHGs and fuel consumption exist presently and will continue to exist after Phase 1 and through Phase 2 until advanced research evolves the gasoline fueled engine to diesel-like efficiencies. This will require significant technological breakthroughs currently in early stages of research such as homogeneous charge compression ignition (HCCI) or similar concepts. Because these technologies are still in the early research stages, we believe the separate fuel type standards are

appropriate in the timeframe of this rule to assure the availability of both gasoline and diesel engines. We also project that these separate standards will result in roughly equivalent redesign burdens for engines of both fuel types as evidenced by feasibility and cost analysis in RIA Chapter 10. For the same reasons, the agencies are adopting separate standards for diesel and SI vocational engines. See Section V. above.

In order to maintain the same overall level of stringency as proposed for the program, a fuel neutral standard would result in an increase in stringency for gasoline or spark ignition vehicles with a matching relaxation of stringency for diesel or compression ignition vehicles relative to the separate numerical levels established in the proposal for gasoline and diesel vehicles. Based on the analysis of available technologies for both types of vehicles, the agencies do not feel it is appropriate to adopt such a change for either gasoline or diesel vehicles. This change could lead to an undesirable reduction in penetration of fuel efficient technologies in diesels, particularly from manufacturers who produce predominately diesel vehicles, while requiring a higher penetration of advanced technologies like strong hybridization in gasoline vehicles, distorting consumer choice. Additionally, the agencies do not agree with the comment stating that maintaining separate gasoline and diesel targets of equal increases in stringency of 2.5 percent per year from the Phase 1 final standards will result in a shift to less efficient gasoline vehicles. The agencies determined that manufacturers have similar technology challenges and corresponding costs regardless of fuel type and therefore manufacturers do not have an easier or lower cost long term path to compliance by simply shifting production from one fuel type to the other.

Note further that a manufacturer’s fleet average standard is the production weighted average of *all* its targets, both gasoline and diesel. Thus, there is no separate gasoline vehicle standard, or separate diesel standard. Commenters may have been confused on this point (several of the commenters referred to gasoline ‘standards’, or diesel ‘standards’). This averaging feature of the standard further increases incentives to add advanced technologies to either gasoline or diesel vehicles if manufacturers perceive it advantageous to do so, since the benefit is experienced fleet wide, not just for the gasoline or diesel segment of a manufacturer’s production line.

The NHTSA fuel consumption target curves and EPA GHG target curves are equivalent. The agencies established the target curves using the direct relationship between fuel consumption and CO<sub>2</sub> using conversion factors of 8,887 g CO<sub>2</sub>/gallon for gasoline and 10,180 g CO<sub>2</sub>/gallon for diesel fuel.

It is expected that measured performance values for CO<sub>2</sub> will generally be equivalent to fuel consumption. However, Phase 1 established a provision that EPA is not changing for Phase 2 that allows manufacturers, if they choose, to use CO<sub>2</sub> credits to help demonstrate compliance with N<sub>2</sub>O and CH<sub>4</sub> emissions standards, by expressing any N<sub>2</sub>O and CH<sub>4</sub> under compliance in terms of their CO<sub>2</sub>-equivalent and applying CO<sub>2</sub> credits as needed. For test families that do not use this compliance alternative, the measured performance values for CO<sub>2</sub> and fuel consumption will be equivalent because the same test runs and measurement data will be used to determine both values, and calculated fuel consumption will be based on the same conversion factors that are used to establish the relationship between the CO<sub>2</sub> and fuel consumption target curves (8,887 g CO<sub>2</sub>/gallon for gasoline and 10,180 g CO<sub>2</sub>/gallon for diesel fuel). For manufacturers that choose to use EPA provision for CO<sub>2</sub> credit use in demonstrating N<sub>2</sub>O and CH<sub>4</sub> compliance, compliance with the CO<sub>2</sub> standard will not be directly equivalent to compliance with the NHTSA fuel consumption standard.

(2) What are the HD pickup and van test cycles and procedures?

The Phase 1 program established testing procedures for HD pickups and vans and NHTSA and EPA are maintaining these testing protocols. The vehicles will continue to be tested using the same heavy-duty chassis test procedures currently used by EPA for measuring criteria pollutant emissions from these vehicles, including the city fuel economy test cycle (FTP) and the highway fuel economy test cycle (HFET). These test procedures are used by manufacturers for certification and emissions compliance demonstrations and by the agencies for compliance verification and enforcement. While the FTP and the HFET driving patterns are identical to that of the light-duty test cycles, other test parameters for running them, such as test vehicle loaded weight, are specific to complete heavy-duty vehicles. Please see Section II.C (2) of the Phase 1 Preamble (76 FR 57166) for a discussion of how HD pickups and vans are tested.

The test procedures for HD pickups and vans currently specify using a fuel with properties established under the light-duty (LD) vehicle Tier 2 program. EPA recently finalized new emission standards under the Tier 3 program for both LD vehicles and HD pickups and vans which will begin to phase-in in MY 2017 for LD vehicles and MY 2018 for vehicles over 6000 pounds GVWR, including HD pickups and vans. As part of the Tier 3 program, new test procedures for gasoline-fueled vehicles requiring the use of a new test fuel containing 10 percent ethanol which is more representative of in-use fuel that the vehicles will encounter. The agencies are investigating any potential impact of changes to the fuel properties on GHG emissions and fuel consumption and have committed to providing appropriate adjustment to the test procedures if necessary to ensure no change in stringency of the Phase 1 or the Phase 2 standards.

AAPC commented that the current methodology of grouping vehicles by the Equivalent Test Weight (ETW) in increments of 500 pounds for determining their GHG and FE performance is too large to capture weight reductions that may occur within a 500 pound grouping. Under the current test procedures, vehicles are tested at 500 lb. increments of inertial weight classes when testing at or above 5500 lbs. test weight. For example, the commenter stated that all vehicles having a calculated test weight basis of 11,251 to 11,750 lbs. are tested at 11,500 lbs. (*i.e.*, the midpoint of the range). However, for some vehicles, the existence of these bins and the large intervals between bins may reduce or eliminate the incentive for mass reduction for some vehicles, as a vehicle may require significant mass reduction before it could switch from one test weight bin to the next lower bin. For other vehicles, these bins may unduly reward relatively small reductions of vehicle mass, as a vehicle's mass may be only slightly greater than that needed to be assigned a 500-pound lighter inertia weight class. For example, for a vehicle with a calculated test weight basis of 11,700 lbs., a manufacturer would receive no regulatory benefit for reducing the vehicle weight by 400 lbs., because the vehicle would stay within the same weight bracket.

The agencies believe this (and similar comments) have some merit. In response, the agencies are finalizing an option allowing manufacturers to divide vehicle models into finer weight groupings of vehicles for the different Adjusted Loaded Vehicle Weights (ALVW) for purposes of more precise

calculation of CO<sub>2</sub> emissions performance within the 500 pound increment test weight classes. Manufacturers will be able to select 50, 100, 250, or 500 weight groups for reporting emissions. ALVW will vary within a single ETW largely depending on the varying models curb weights from customer option selection and other production variations. The calculation of CO<sub>2</sub> emissions performance for the finer groupings is performed as described in 40 CFR 86.1819–14(g)) for analytically adjusting CO<sub>2</sub> (ADCO<sub>2</sub>) emissions. The test results at the existing 500 pound increment ETWs will be used to determine the CO<sub>2</sub> emissions performance level of the new groupings using the analytically derived equation. This new ADCO<sub>2</sub> emissions level is only used for this new grouping and cannot be used to extend determination of other ALVW groupings emission performance levels. The vehicle specific values used to determine the change in ETW in the ADCO<sub>2</sub> emissions calculation to estimate the performance of the smaller grouping should be consistent with value used to calculate the single work factor of that same grouping. This change does not impact the ETW of a group of vehicle models that are contained in the 500 pound increment of ETW when performing testing nor does it eliminate any vehicle in that grouping from being responsible for emission performance at the 500 pound increment test weight classes. As described, this change only allows for more precise CO<sub>2</sub> emissions estimation for the potentially different curb weights of vehicles grouped in a single ETW class for purposes of fleet average calculation. If a manufacturer chooses to use less than 500 pound increments, they are required to use this option for all of their HD vehicles that are chassis certified (including loose engines).

### (3) Fleet Average Standards

As proposed, and as noted above, NHTSA and EPA are retaining the fleet average standards approach finalized in the Phase 1 rule and structurally similar to light-duty Corporate Average Fuel Economy (CAFE) and GHG standards. The fleet average standard for a manufacturer is a production-weighted average of the work factor-based targets assigned to unique vehicle configurations within each model type produced by the manufacturer in a model year, with separate targets for gasoline and diesel vehicles (which are then combined into a production weighted average which comprises that manufacturer's fleet average standard). Each manufacturer will continue to

have an average GHG requirement and an average fuel consumption requirement unique to its new HD pickup and van fleet in each model year, depending on the characteristics (payload, towing, and drive type, as well as gasoline and diesel) of the vehicle models produced by that manufacturer, and on the U.S.-directed production volume of each of those models in that model year. Vehicle models with larger payload/towing capacities and/or four-wheel drive have individual targets at numerically higher CO<sub>2</sub> and fuel consumption levels than less capable vehicles, as discussed in Section VI.B.(1). The agencies did not receive comments suggesting changes to this fundamental approach to the standards.

The fleet average standard with which the manufacturer must comply will continue to be based on its final production figures for the model year, and thus a final assessment of compliance will occur after production for the model year ends. The assessment of compliance also must consider the manufacturer's use of carry-forward and carry-back credit provisions included in the averaging, banking, and trading program. Because compliance with the fleet average standards depends on actual test group production volumes, it is not possible to determine compliance at the time the manufacturer applies for and receives an (initial) EPA certificate of conformity for a test group. Instead, at certification the manufacturer will demonstrate a level of performance for vehicles in the test group, and make a good faith demonstration that its fleet, regrouped by unique vehicle configurations within each model type, is expected to comply with its fleet average standard when the model year is over. EPA will issue a certificate for the vehicles covered by the test group based on this demonstration, and will include a condition in the certificate that if the manufacturer does not comply with the fleet average, then production vehicles from that test group will be treated as not covered by the certificate to the extent needed to bring the manufacturer's fleet average into compliance. As in the parallel program for light-duty vehicles, additional "model type" testing will be conducted by the manufacturer over the course of the model year to supplement the initial test group data. The emissions and fuel consumption levels of the test vehicles will be used to calculate the production-weighted fleet averages for the manufacturer, after application of the appropriate deterioration factor to each result to obtain a full useful life value.

Please see Section II.C.(3)(a) of the Phase 1 Preamble (76 FR 57167) for further discussion of the fleet average approach for HD pickups and vans.

#### (4) In-Use Standards

Section 202(a)(1) of the CAA specifies that EPA set emissions standards that are applicable for the useful life of the vehicle. EPA will continue the in-use standards approach for individual vehicles that EPA finalized for the Phase 1 program. NHTSA did not adopt Phase 1 in-use standards and did not propose in-use standards for Phase 2. For the EPA program, compliance with the in-use standard for individual vehicles and vehicle models does not impact compliance with the fleet average standard, which will be based on the production-weighted average of the new vehicles. Vehicles that fail to meet their in-use emission standards will be subject to recall to correct the noncompliance. NHTSA is finalizing the use of EPA's useful life requirements to ensure manufacturers consider in the design process the need for fuel efficiency standards to apply for the same duration and mileage as EPA standards. NHTSA will limit such penalties to situations in which it determined that the vehicle or engine manufacturer failed to comply with the standards.

As with Phase 1, the in-use Phase 2 GHG standards for HD pickups and vans will be established by adding an adjustment factor to the full useful life emissions used to calculate the GHG fleet average. Each model's in-use CO<sub>2</sub> standard will be the model-specific level used in calculating the fleet average, plus 10 percent. No adverse comments were received on this provision. Please see Section II.C.(3)(b) of the Phase 1 Preamble (76 FR 57167) for further discussion of in-use standards for HD pickups and vans. This provision, along with the continuation of the Phase 1 test procedures, eliminates that need for the agencies to include any additional compliance margin in our feasibility analysis.

For Phase 1, EPA aligned the useful life for GHG emissions with the useful life that was in place for criteria pollutants: 11 years or 120,000 miles, whichever occurs first (40 CFR 86.1805–04(a)). Since the Phase 1 rule was finalized, EPA updated the useful life for criteria pollutants as part of the Tier 3 rulemaking.<sup>466</sup> The new useful life implemented for Tier 3 is 150,000 miles or 15 years, whichever occurs first. As

proposed, the useful life for GHG emissions and fuel consumption will also be 150,000 miles/15 years starting in MY 2021 when the Phase 2 standards begin so that the useful life remains aligned for GHG and criteria pollutant standards long term. The agencies did not receive adverse comments on this provision.

#### (5) Other GHG Standards for HD Pickups and Vans

This section addresses greenhouse gases other than CO<sub>2</sub>. Note that since these are greenhouse gases not directly related to fuel consumption, NHTSA does not have equivalent standards.

##### (a) Nitrous Oxide (N<sub>2</sub>O) and Methane (CH<sub>4</sub>)

In the Phase 1 rule, EPA established emission standards for HD pickups and vans for both nitrous oxide (N<sub>2</sub>O) and methane (CH<sub>4</sub>). Similar to the CO<sub>2</sub> standard approach, the N<sub>2</sub>O and CH<sub>4</sub> emission levels of a vehicle are based on a composite of the light-duty FTP and HFET cycles with the same 55 percent city weighting and 45 percent highway weighting. The N<sub>2</sub>O and CH<sub>4</sub> standards were both set by EPA at 0.05 g/mile. Unlike the CO<sub>2</sub> standards, averaging between vehicles is not allowed. The standards are designed to prevent increases in N<sub>2</sub>O and CH<sub>4</sub> emissions from current levels, *i.e.*, a no-backsliding standard. EPA did not propose and is not adopting any changes the N<sub>2</sub>O or CH<sub>4</sub> standards or related provisions established in the Phase 1 rule. Please see Phase 1 Preamble Section II.E. (76 FR 57188–57193) for additional discussion of N<sub>2</sub>O and CH<sub>4</sub> emissions and standards.

Across both current gasoline- and diesel-fueled heavy-duty vehicle designs, emissions of CH<sub>4</sub> and N<sub>2</sub>O are relatively low and the intent of the cap standards is to ensure that future vehicle technologies or fuels do not result in an increase in these emissions. Given the global warming potential (GWP) of CH<sub>4</sub>, the 0.05 g/mile cap standard is equivalent to about 1.7 g/mile CO<sub>2</sub>, which is much less than 1 percent of the overall GHG emissions of most HD pickups and vans.<sup>467</sup> The effectiveness of oxidation of CH<sub>4</sub> using a three-way or diesel oxidation catalyst is limited by the activation energy, which tends to be higher where the number of carbon atoms in the hydrocarbon molecule is low and thus CH<sub>4</sub> is very stable. At this time we are not aware of any technologies beyond the already present catalyst systems

which are highly effective at oxidizing most hydrocarbon species for gasoline and diesel fueled engines that would further lower the activation energy across the catalyst or increase the energy content of the exhaust (without further increasing fuel consumption and CO<sub>2</sub> emissions) to further reduce CH<sub>4</sub> emissions at the tailpipe. The CH<sub>4</sub> standard remains an important backstop to prevent future increases in CH<sub>4</sub> emissions. EPA did not receive adverse comments regarding the proposal to not change the CH<sub>4</sub> standard for HD pickups and vans.

N<sub>2</sub>O is emitted from gasoline and diesel vehicles mainly during specific catalyst temperature conditions conducive to N<sub>2</sub>O formation. The 0.05 g/mile standard, which translates to a CO<sub>2</sub>-equivalent value of 14.9 g/mile, ensures that systems are not designed in a way that emphasizes efficient NO<sub>x</sub> control while allowing the formation of significant quantities of N<sub>2</sub>O. The Phase 1 N<sub>2</sub>O standard of 0.05 g/mile for pickups and vans was finalized knowing that it is more stringent than the Phase 1 N<sub>2</sub>O engine standard of 0.10 g/hp-hr, which is being continued for Phase 2, as discussed in Section II.D.3. EPA continues to believe that the 0.05 g/mile standard provides the necessary assurance that N<sub>2</sub>O will not significantly increase, given the mix of gasoline and diesel fueled engines in this market and the upcoming implementation of the light-duty and heavy-duty (up to 14,000 lbs. GVWR) Tier 3 NO<sub>x</sub> standards. EPA knows of no technologies that would lower N<sub>2</sub>O emissions beyond the control provided by the precise emissions control systems already being implemented to meet EPA's criteria pollutant standards. Therefore, EPA continues to believe the 0.05 g/mile N<sub>2</sub>O standard remains appropriate.

The California Air Resources Board (CARB) suggested that EPA investigate the feasibility of more stringent tailpipe standards. EPA may consider more stringent standards in the future if data is available to support adjustments to the standards as appropriate and consistent with the CAA, but we repeat that at present we know of no further emission reduction technologies for either N<sub>2</sub>O or CH<sub>4</sub>.

If a manufacturer is unable to meet the N<sub>2</sub>O or CH<sub>4</sub> cap standards, the EPA program allows the manufacturer to comply using CO<sub>2</sub> credits. In other words, a manufacturer may offset any N<sub>2</sub>O or CH<sub>4</sub> emissions above the standard by taking steps to further reduce CO<sub>2</sub>. A manufacturer choosing this option would use GWPs to convert its measured N<sub>2</sub>O and CH<sub>4</sub> test results that are in excess of the applicable

<sup>466</sup> 79 FR 23492, April 28, 2014 and 40 CFR 86.1805–17.

<sup>467</sup> N<sub>2</sub>O has a GWP of 298 and CH<sub>4</sub> has a GWP of 34 according to the IPCC AR5.

standards into CO<sub>2</sub>eq to determine the amount of CO<sub>2</sub> credits required. For example, for Phase 1, a manufacturer would use 25 Mg of positive CO<sub>2</sub> credits to offset 1 Mg of negative CH<sub>4</sub> credits or use 298 Mg of positive CO<sub>2</sub> credits to offset 1 Mg of negative N<sub>2</sub>O credits.<sup>468</sup> By using the GWP of N<sub>2</sub>O and CH<sub>4</sub>, the approach recognizes the inter-correlation of these compounds in impacting global warming and is environmentally neutral for demonstrating compliance with the individual emissions caps. Because fuel conversion manufacturers certifying under 40 CFR part 85, subpart F, do not participate in ABT programs, EPA included in the Phase 1 rule a compliance option for fuel conversion manufacturers to comply with the N<sub>2</sub>O and CH<sub>4</sub> standards that is similar to the credit program described above. See 76 FR 57192. The compliance option will allow conversion manufacturers, on an individual engine family basis, to convert CO<sub>2</sub> over compliance into CO<sub>2</sub> equivalents (CO<sub>2</sub> eq) of N<sub>2</sub>O and/or CH<sub>4</sub> that can be subtracted from the CH<sub>4</sub> and N<sub>2</sub>O measured values to demonstrate compliance with CH<sub>4</sub> and/or N<sub>2</sub>O standards. EPA did not include similar provisions allowing over compliance with the N<sub>2</sub>O or CH<sub>4</sub> standards to serve as a means to generate CO<sub>2</sub> credits because the CH<sub>4</sub> and N<sub>2</sub>O standards are cap standards representing levels that all but the worst vehicles should already be well below. Allowing credit generation against such cap standard would provide a windfall credit without any true GHG reduction. As proposed, EPA is maintaining these provisions for Phase 2 as they provide important flexibility without reducing the overall GHG benefits of the program.

EPA requested comments on updating GWPs used in the calculation of credits discussed above. For Phase 2, EPA is updating the GWP for methane from 25 to 34 based on IPCC AR5. Please see the full discussion of this issue provided in Sections II.D and XI.D.

CARB suggested that EPA consider eliminating or at least phasing out the use of CO<sub>2</sub> credits in lieu of compliance with tailpipe methane standards. In contrast, NGV America strongly supported extending this compliance option, noting that the ability to offset methane (and also nitrous oxide) emissions with CO<sub>2</sub> credits is critical for new natural gas engines and vehicles. Cummins also commented in support of continuing to allow the use of CO<sub>2</sub>-equivalent credits to comply with N<sub>2</sub>O

and CH<sub>4</sub> standards. Cummins commented that the flexibility has been applied by various manufacturers in Phase 1 and is necessary for Phase 2. Review of MY 2014 certification GHG data confirmed that several manufacturers utilized this Phase 1 program flexibility for either N<sub>2</sub>O or CH<sub>4</sub> debits on their diesel vehicles. EPA continues to believe this flexibility is appropriate as it provides important flexibility to manufacturers in an environmentally neutral manner.

*(b) Air Conditioning Related Emissions*

Air conditioning systems contribute to GHG emissions in two ways—direct emissions through refrigerant leakage and indirect exhaust emissions due to the extra load on the vehicle's engine to provide power to the air conditioning system. HFC refrigerants, which are powerful GHG pollutants, can leak from the A/C system. This includes the direct leakage of refrigerant as well as the subsequent leakage associated with maintenance and servicing, and with disposal at the end of the vehicle's life.<sup>469</sup> Currently, the most commonly used refrigerant in automotive applications—R134a, has a high GWP. Due to the high GWP of R134a, a small leakage of the refrigerant has a much greater global warming impact than a similar amount of emissions of CO<sub>2</sub> or other mobile source GHGs.

In Phase 1, EPA finalized low leakage requirement for all air conditioning systems installed in 2014 model year and later HDVs, with the exception of Class 2b–8 vocational vehicles. As discussed in Section V.B.(2)(c), EPA is extending leakage standards to vocational vehicles for Phase 2. For air conditioning systems with a refrigerant capacity greater than 733 grams, EPA finalized a leakage standard which is a “percent refrigerant leakage per year” to assure that high-quality, low-leakage components are used in each air conditioning system design. EPA finalized a standard of 1.50 percent leakage per year for heavy-duty pickup trucks and vans and Class 7 and 8 tractors. See Section II.E.5. of the Phase 1 Preamble (76 FR 57194–57195) for further discussion of the A/C leakage standard. The leakage standard continues to apply for Phase 2 regardless of the refrigerant used in the A/C system. See Section I.F. for how the Phase 2 program handles the use of alternative refrigerants.

In addition to direct emissions from refrigerant leakage, air conditioning

systems create indirect exhaust emissions due to the extra load on the vehicle's engine to provide power to the air conditioning system. These indirect emissions are in the form of the additional CO<sub>2</sub> emitted from the engine when A/C is being used due to the added loads. Unlike direct emissions which tend to be a set annual leak rate not directly tied to usage, indirect emissions are fully a function of A/C usage. These indirect CO<sub>2</sub> emissions are associated with air conditioner efficiency, since (as just noted) air conditioners create load on the engine. See 74 FR 49529. In Phase 1, the agencies did not set air conditioning efficiency standards for vocational vehicles, combination tractors, or heavy-duty pickup trucks and vans. The CO<sub>2</sub> emissions due to air conditioning systems in these heavy-duty vehicles were estimated to be minimal compared to their overall emissions of CO<sub>2</sub>. 76 FR 57194–57196. This continues to be the case. For this reason, EPA did not propose and is not establishing A/C efficiency standards for Phase 2. This differs from light-duty vehicles where CO<sub>2</sub> emissions related to A/C systems can be a significant portion of overall vehicle CO<sub>2</sub> emissions and EPA has established appropriate standards and test procedures.

AAPC and Nissan commented that the agencies should provide A/C efficiency credits similar to those included in the light-duty vehicle program. AAPC also commented that the AC17 test, included in the light-duty vehicle program to confirm A/C system performance, would be impractical and should not be required for heavy-duty vehicles. The agencies did not propose and are not adopting A/C efficiency credits for heavy-duty pickups and vans. AAPC suggests that the agencies could allow the same credits as are available in the light-duty vehicle program but no data is provided regarding the appropriateness of the credits. The EPA would need to resolve a number of open issues relating to environmental implications of A/C efficiency credits for these vehicles (among them, potential credit generation rate, whether credits would be windfall, implications for the standard stringency) before considering adopting an A/C efficiency credit regime. Also, the AC17 test is an integral part of the light-duty vehicle program serving as a confirmation that the credits are based on actual performance improvements. EPA does not believe that it would be appropriate to provide credits based only on the presumption that systems similar to those used in light-duty trucks will

<sup>468</sup> IPCC AR4 included a N<sub>2</sub>O GWP of 298 and a CH<sub>4</sub> GWP of 25. These factors are used in the Phase 1 rule credits calculations.

<sup>469</sup> The U.S. EPA has reclamation requirements for refrigerants in place under Title VI of the Clean Air Act. See 40 CFR part 82 Subpart B.

provide the same improvements in heavy-duty pickups and vans with no confirmation through testing.

AAPC also recommended that EPA provide credits for reduced refrigerant leakage and alternative refrigerant usage similar to the light-duty vehicle program. In response, as discussed above and in Section I.F, EPA has established standards for refrigerant leakage. EPA does not believe that it would be appropriate to provide credits for items that are essentially required. Providing such credits without an increase in total program stringency similar to the light-duty approach to A/C efficiency and refrigerant leakage would result in a loss of program benefits.

### C. Use of the CAFE Model in Heavy-Duty Rulemaking

NHTSA developed the CAFE model in 2002 to support the 2003 issuance of CAFE standards for MYs 2005–2007 light trucks. NHTSA has since significantly expanded and refined the model, and has applied the model to support every ensuing CAFE rulemaking for both light-duty and heavy-duty. For this analysis, the model was reconfigured to use the work based attribute metric of “work factor” established in the Phase 1 rule instead of the light duty “footprint” attribute metric.

Past analyses conducted using the CAFE model have been subjected to extensive and detailed review and comment, much of which has informed the model’s expansion and refinement. NHTSA’s use of the model was considered and supported in *Center for Biological Diversity v. National Highway Traffic Safety Admin.*, 538 F.3d 1172, 1194 (9th Cir. 2008). For further discussion see 76 FR 57198, and the model has been subjected to formal peer review and review by the General Accounting Office (GAO) and National Research Council (NRC). NHTSA makes public the model, source code, and—except insofar as doing so will compromise confidential business information (CBI) manufacturers have provided to NHTSA—all model inputs and outputs underlying published rulemaking analyses.

Although the CAFE model can also be used for more aggregated analysis (e.g., involving “representative vehicles,” single-year snapshots, etc.), NHTSA designed the model with a view toward (a) detailed simulation of manufacturers’ potential actions given a defined set of standards, followed by (b) calculation of resultant impacts and economic costs and benefits. The model is intended to describe actions

manufacturers *could* take in light of defined standards and other input assumptions and estimates, not to predict actions manufacturers *will* take in light of competing product and market interests (e.g. engine power, customer features, technology acceptance, etc.).

For the proposal, the agencies conducted coordinated and complementary analyses using two analytical methods for the heavy-duty pickup and van segment by employing both NHTSA’s CAFE model and EPA’s MOVES model. The agencies used EPA’s MOVES model to estimate fuel consumption and emissions impacts for tractor-trailers (including the engine that powers the tractor), and vocational vehicles (including the engine that powers the vehicle). Additional calculations were performed to determine corresponding monetized program costs and benefits. For heavy-duty pickups and vans, the agencies performed complementary analyses, which we refer to as “Method A” and “Method B.”

For the final rule, NHTSA’s Method A uses a modified version of the CAFE model developed since the NPRM, as well as accompanying updates to CAFE model inputs, to project a pathway the industry could use to comply with each regulatory alternative and the estimated effects on fuel consumption, emissions, benefits and costs were industry to do so. Method A is presented below in Section D and differs from the Method A analysis provided in the NPRM. NHTSA considered the results of the Method A analysis for decision making for the final rule.

EPA’s Method B analysis continues to use the CAFE model and inputs developed for the NPRM to identify technology pathways the industry could potentially use to comply with each regulatory alternative, along with resultant impacts on per vehicle costs should that compliance path be utilized, and the MOVES model was used to calculate corresponding changes in total fuel consumption and annual emissions. The results are presented in Section E. Additional calculations were performed to determine corresponding monetized program costs and benefits. NHTSA’s consideration of the Method A analysis and EPA’s consideration of the Method B analysis led the agencies to the same conclusions regarding the selection of the Phase 2 standards. See Sections D and E for additional discussion of these two methods and the feasibility of the standards.

### (1) Overview of the CAFE Model

As a starting point, the model makes use of an input file defining the analysis fleet—that is, a set of specific vehicle models (e.g., Ford F250) and model configurations (e.g., Ford F250 with 6.2-liter V8 engine, 4WD, and 6-speed manual transmission) estimated or assumed to be produced by each manufacturer in each model year to be included in the analysis. The analysis fleet includes key engineering attributes (e.g., curb weight, payload and towing capacities, dimensions, presence of various fuel-saving technologies) of each vehicle model, engine, and transmissions, along with estimates or assumptions of future production volumes. It also specifies the extent to which specific vehicle models share engines, transmissions, and vehicle platforms, and describes each manufacturer’s estimated or assumed product cadence (i.e., timing for freshening and redesigning different vehicles and platforms). This input file also specifies a payback period used to estimate the potential that each manufacturer might apply technology to improve fuel economy beyond levels required by standards.

A second input file to the model contains a variety of contextual estimates and assumptions. Some of these inputs, such as future fuel prices and vehicle survival and mileage accumulation (versus vehicle age), are relevant to estimating manufacturers’ potential application of fuel-saving technologies. Some others, such as fuel density and carbon content, vehicular and upstream emission factors, the social cost of carbon dioxide emissions, and the discount rate, are relevant to calculating physical and economic impacts of manufacturers’ application of fuel-saving technologies.

A third input file contains estimates and assumptions regarding the future applicability, availability, efficacy, and cost of various fuel-saving technologies. Efficacy is expressed in terms of the percentage reduction in fuel consumption, cost is expressed in dollars, and both efficacy and cost are expressed on an incremental basis (i.e., estimates for more advanced technologies are specified as increments beyond less advanced technologies). The input file also includes “synergy factors” used to make adjustments accounting for the potential that some combinations of technologies may result fuel savings or costs different from those indicated by incremental values. Thus, the model itself does not evaluate which technologies will be available, nor does it evaluate how effective or reliable they

will be. The technological availability and effectiveness are rather predefined inputs to the model based on the agencies' judgements and not outputs from the model, which is simply a tool for calculating the effects of combining input assumptions.

Finally, a fourth model input file specifies standards to be evaluated. Standards are defined on a year-by-year basis separately for each regulatory class (passenger cars, light trucks, and heavy-duty pickups and vans). Regulatory alternatives are specified as discrete scenarios, with one scenario defining the no-action alternative or "baseline," all other scenarios defining regulatory alternatives to be evaluated relative to that no-action alternative.

Given these inputs, the model estimates each manufacturer's potential year-by-year application of fuel-saving technologies to each engine, transmission, and vehicle. Subject to a range of engineering and planning-related constraints (e.g., secondary axle disconnect can't be applied to 2-wheel drive vehicles, many major technologies can only be applied practicably as part of a vehicle redesign, and applied technologies carry forward between model years), the model attempts to apply technology to each manufacturer's fleet in a manner that minimizes "effective costs" (accounting, in particular, for technology costs and avoided fuel outlays), continuing to add improvements as long as doing so will help toward compliance with specified standards or will produce fuel savings that "pay back" at least as quickly as specified in the input file mentioned above.

After estimating the extent to which each manufacturer might add fuel-saving technologies under each specified regulatory alternative, the model calculates a range of physical impacts, such as changes in highway travel (i.e., VMT), changes in fleetwide fuel consumption, changes in highway fatalities, and changes in vehicular and upstream greenhouse gas and criteria pollutant emissions. The model also applies a variety of input estimates and assumptions to calculate economic costs and benefits to vehicle owners and society, based on these physical impacts. These are considered Method A results.

Since the manufacturers of HD pickups and vans generally only have one basic pickup truck and van with different versions (i.e., different wheelbases, cab sizes, two-wheel drive, four-wheel drive, etc.) there exists less flexibility than in the light-duty fleet to coordinate model improvements over several years. As such, the CAFE model

allows changes to the HD pickups and vans to meet new standards according to estimated redesign cycles included as a model input. As noted above, the opportunities for large-scale changes (e.g., new engines, transmission, vehicle body and mass) thus occur less frequently than in the light-duty fleet, typically at spans of eight or more years for this analysis. However, opportunities for gradual improvements not necessarily linked to large scale changes can occur between the redesign cycles (i.e., model refresh). Examples of such improvements are upgrades to an existing vehicle model's engine, transmission and aftertreatment systems.

(2) How did the agencies develop the analysis fleet for the NPRM?

As discussed above, both agencies used a version of NHTSA's CAFE modeling system to estimate technology costs and application rates under each regulatory alternative considered. The modeling system relies on many inputs, including an analysis fleet. In order to estimate the impacts of potential standards, it is necessary to estimate the composition of the future vehicle fleet. Doing so enables estimation of the extent to which each manufacturer may need to add technology in response to a given series of attribute-based standards, accounting for the mix and fuel consumption of vehicles in each manufacturer's regulated fleet. The agencies create an analysis fleet in order to track the volumes and types of fuel economy-improving and CO<sub>2</sub>-reducing technologies that are already present in the existing vehicle fleet. This aspect of the analysis fleet helps to keep the CAFE model from adding technologies to vehicles that already have these technologies, which will result in "double counting" of technologies' costs and benefits. An additional step involved projecting the fleet sales into MYs 2019–2030. This represents the fleet volumes that the agencies believe will exist in MYs 2019–2030. The following presents an overview of the information and methods applied to develop the analysis fleet, and some basic characteristics of that fleet.

Most of the information about the vehicles that make up the 2014 analysis fleet (used in the NPRM and Method B of this FRM) and the 2015 analysis fleet (used in Method A of this FRM) was gathered from the 2014 and 2015 Pre-Model Year Reports submitted to EPA by the manufacturers under Phase 1 of Fuel Efficiency and GHG Emission Program for Medium- and Heavy-Duty Trucks, MYs 2014–2018. The major manufacturers of class 2b and class 3

trucks (Chrysler, Ford and GM) were asked to voluntarily submit updates to their Pre-Model Year Reports. The agencies used these updated data in constructing the analysis fleet for these manufacturers. The agencies agreed to treat this information as Confidential Business Information (CBI) until the publication of the proposed rule. This information can be made public at this time because by now all MY 2014 and MY 2015 vehicle models have been produced, which makes data about them essentially public information.

In addition to information about each vehicle, the agencies need additional information about the fuel economy-improving/CO<sub>2</sub>-reducing technologies already on those vehicles in order to assess how much and which technologies to apply to determine a path toward future compliance. To correctly account for the cost and effectiveness of adding technologies, it is necessary to know the technology penetration in the existing vehicle fleet. Otherwise, "double-counting" of technology could occur. Thus, in their respective analysis fleets, the agencies augmented this information with data from public and commercial sources<sup>470</sup> that include more complete technology descriptions, e.g. for specific engines and transmissions.

The resultant analysis fleets are provided in detail at NHTSA's Web site, along with all other inputs to and outputs from both the NPRM and the current analysis. The agencies invited but did not receive comment on this analysis.

#### (a) Vehicle Redesign Schedules and Platforms

Product cadence in the Class 2b and 3 pickup market has historically ranged from 7–9 years between major redesigns. However, due to increasing competitive pressures and consumer demands the agency anticipates that manufacturers will generally shift to shorter design cycles resembling those of the light duty market. Pickup truck manufacturers in the Class 2b and 3 segments are shown to adopt redesign cycles of six years, allowing two redesigns prior to the end of the regulatory period in 2025.

The Class 2b and 3 van market has changed markedly from five years ago. Ford, Nissan, Ram and Daimler have adopted vans of "Euro Van" appearance, and in many cases now use smaller turbocharged gasoline or diesel engines in the place of larger, naturally-aspirated V8s. The 2014 and 2015 model years used in this analysis

<sup>470</sup> e.g., manufacturers' Web sites, Wards Automotive.



represent a period where most manufacturers, with the exception of General Motors, have recently introduced a completely redesigned product after many years. The van segment has historically been one of the slowest to be redesigned of any product segment, with some products going two decades or more between redesigns.

Due to new entrants in the field and increased competition, the agencies anticipate that most manufacturers will increase the pace of product redesigns in the van segment, but that they will continue to trail other segments. The cycle time used in this analysis is approximately ten years between major redesigns, allowing manufacturers' only one major redesign during the regulatory period. The agencies did not receive comment on this anticipated product design cycle.

Additional detail on product cadence assumptions for specific manufacturers is located in Chapter 10 of the RIA.

(b) Sales Volume Forecast

Since each manufacturer's required average fuel consumption and GHG levels are sales-weighted averages of the fuel economy/GHG targets across all model offerings, sales volumes play a critical role in estimating that burden. The CAFE model requires a forecast of sales volumes, at the vehicle model-variant level, in order to simulate the

technology application necessary for a manufacturer to achieve compliance in each model year for which outcomes are simulated.

As stated above, the agencies relied on the pre-model-year compliance submissions from manufacturers to provide sales volumes at the model level based on the level of disaggregation in which the models appear in the compliance data. However, the agencies only use these reported volumes without adjustment for the reference fleet model year (MY 2014 or MY 2015). For all future model years, we combine the manufacturer submissions with sales projections from the 2014 (for the NPRM and Method B of the FRM) or 2015 (for Method A of the FRM) Annual Energy Outlook Reference Case and IHS Automotive to determine model variant level sales volumes in future years.<sup>471</sup> The projected sales volumes by class that appear in the Annual Energy Outlook as a result of a collection of assumptions about economic conditions, demand for commercial miles traveled, and technology migration from light-duty pickup trucks in response to the concurrent light-duty CAFE/GHG standards. These are shown in Chapter 2 of the RIA.

The projection of total sales volumes for the Class 2b and 3 market segment

was based on the total volumes in the 2014 AEO Reference Case in the NPRM and for Method B of this FRM. For the purposes of this analysis, the AEO2014 calendar year volumes have been used to represent the corresponding model-year volumes. While AEO2014 provides enough resolution in its projections to separate the volumes for the Class 2b and 3 segments, the agencies deferred to the vehicle manufacturers and chose to rely on the relative shares present in the pre-model-year compliance data. This methodology remains the same for the Method A FRM analysis, but we have replaced the 2014 AEO reference case with the 2015 AEO reference case.

The relative sales share by vehicle type (van or pickup truck, in this case) was derived from a sales forecast that the agencies purchased from IHS Automotive, and applied to the total volumes in the AEO2014 projection. Table VI-3 shows the implied shares of the total new 2b/3 vehicle market broken down by manufacturer and vehicle type. The same methodology was applied using 2015 IHS/Polk projections, and the total volumes from the AEO2015 projection for Method A of the FRM. The results of the 2015-based projections are presented in the following section about changes made to the model since the NPRM.

TABLE VI-3—IHS AUTOMOTIVE MARKET SHARE FORECAST FOR 2B/3 VEHICLES

Manufacturer	Style	Model year market share						
		2015 (%)	2016 (%)	2017 (%)	2018 (%)	2019 (%)	2020 (%)	2021 (%)
Daimler	Van	3	3	3	3	3	3	3
Fiat Chrysler	Van	2	2	2	2	2	2	3
Ford	Van	16	17	17	17	18	18	18
General Motors	Van	12	12	11	12	13	13	13
Nissan	Van	2	2	2	2	2	2	2
Daimler	Pickup	0	0	0	0	0	0	0
Fiat Chrysler	Pickup	14	14	14	14	11	12	12
Ford	Pickup	28	27	30	30	30	27	26
General Motors	Pickup	23	23	21	21	21	22	23
Nissan	Pickup	0	0	0	0	0	0	0

Within those broadly defined market shares, volumes at the manufacturer/model-variant level were constructed by applying the model-variant's share of manufacturer sales in the pre-model-year compliance data for the relevant vehicle style, and multiplied by the total volume estimated for that manufacturer and that style.

After building out a set of initial future sales volumes based on the sources described above, the agencies

attempted to incorporate new information about changes in sales mix that are not captured by either the existing sales forecasts or the simulated technology changes in vehicle platforms. In particular, Ford has announced intentions to phase out their existing Econoline vans, gradually shifting volumes to the new Transit platform for some model variants (notably chassis cabs and cutaways

variants) and eliminating offerings outright for complete Econoline vans as early as model year 2015. In the case of complete Econoline vans, the volumes for those vehicles were allocated to MY 2015 Transit vehicles based on assumptions about likely production splits for the powertrains of the new Transit platform. The volumes for complete Econoline vans were shifted at ratios of 50 percent, 35 percent, and 15

<sup>471</sup> Tables from AEO's forecast are available at <http://www.eia.gov/oiaf/aeo/tablebrowser/>. The

agencies also made use of the IHS Automotive Light Vehicle Production Forecast (August 2014).



percent for 3.7 L, 3.5 L Eco-boost, and 3.2 L diesel, respectively. Within each powertrain, sales were allocated based on the percentage shares present in the pre-model-year compliance data. The chassis cab and cutaway variants of the Econolines were phased out linearly between MY 2015 and MY 2020, at which time the Econolines cease to exist in any form and all corresponding volume resides with the Transits.

### (3) Other Analysis Inputs

In addition to the inputs summarized above, the analysis of potential standards for HD pickups and vans makes use of a range of other estimates and assumptions specified as inputs to the CAFE modeling system. Some significant inputs (*e.g.*, estimates of future fuel prices) also applicable to other MDHD segments are discussed below in Section IX. Others more specific to the analysis of HD pickups and vans are as follows:

#### (a) Vehicle Survival and Mileage Accumulation

The analysis estimates the travel, fuel consumption, and emissions over the useful lives of vehicles produced during model years 2014–2030. Doing so requires initial estimates of these vehicles' survival rates (*i.e.*, shares expected to remain in service) and mileage accumulation rates (*i.e.*, anticipated annual travel by vehicles remaining in service), both as a function of vehicle vintage (*i.e.*, age). These estimates are based on an empirical analysis of changes in the fleet of registered vehicles over time from HIS/Polk data, in the case of survival rates. The NPRM and Method A of the FRM use data collected as part of the last Vehicle In Use Survey (the 2002 VIUS) for the mileage accumulation schedule. Method A of the FRM uses mileage accumulation schedules from 2014 Polk/IHS odometer reading data. The changes to the VMT schedules for Method A of the current analysis are further described below in the Method A FRM specific changes.

#### (b) Rebound Effect

Expressed as an elasticity of mileage accumulation with respect to the fuel cost per mile of operation, the agencies have applied a rebound effect of 10 percent for today's analysis. Other rebound effects are considered in sensitivity analyses in Sections D.

#### (c) On-Road "Gap"

The model was run with a 20 percent adjustment to reflect differences between on-road and laboratory performance.

#### (d) Fleet Population Profile

Though not reported here, cumulative fuel consumption and CO<sub>2</sub> emissions are presented in the accompanying EIS, and these calculations utilize estimates of the numbers of vehicles produced in each model year remaining in service in calendar year 2014. The initial age distribution of the registered vehicle population in 2014 is based on vehicle registration data acquired by NHTSA from R.L. Polk Company. For Method A, these values were updated to reflect newer data acquired by NHTSA from Polk.

#### (e) Past Fuel Consumption Levels

Though not reported here, cumulative fuel consumption and CO<sub>2</sub> emissions are presented in the accompanying EIS, and these calculations require estimates of the performance of vehicles produced prior to model year 2014. Consistent with AEO 2014, the model was run with the assumption that gasoline and diesel HD pickups and vans averaged 14.9 mpg and 18.6 mpg, respectively, with gasoline versions averaging about 48 percent of production. For Method A, these values were updated to reflect AEO2015, such that gasoline and diesel versions were projected to average 16.0 mpg and 20.0 mpg, respectively.

#### (f) Long-Term Fuel Consumption Levels

Though not reported here, longer-term estimates of fuel consumption and emissions are presented in the accompanying EIS. These estimates include calculations involving vehicle produced after MY 2030 and, consistent with AEO 2014, the model was run with the assumption that fuel consumption and CO<sub>2</sub> emission levels will continue to decline at 0.05 percent annually (compounded) after MY 2030.

#### (g) Payback Period

To estimate in what sequence and to what degree manufacturers might add fuel-saving technologies to their respective fleets, the CAFE model iteratively ranks remaining opportunities (*i.e.*, applications of specific technologies to specific vehicles) in terms of effective cost, primary components of which are the technology cost and the avoided fuel outlays, attempting to minimize effective costs incurred.<sup>472</sup> Depending on inputs, the model also assumes manufacturers may improve fuel consumption beyond requirements insofar as doing so will involve applications of technology at negative effective cost—*i.e.*, technology

application for which buyers' up-front costs are quickly paid back through avoided fuel outlays. This calculation includes only fuel outlays occurring within a specified payback period. For both Method A and Method B, a payback period of 6 months was applied for the dynamic baseline case, or Alternative 1b. Thus, for example, a manufacturer already in compliance with standards is projected to apply a fuel consumption improvement projected to cost \$250 (*i.e.*, as a cost that could be charged to the buyer at normal profit to the manufacturer) and reduce fuel costs by \$500 in the first year of vehicle operation. The agencies have conducted the same analysis applying a payback period of 0 months for the flat baseline case, or Alternative 1a. For Method A, Alternative 1b is the primary analysis, and Alternative 1a is one of a range of cases included in the sensitivity analysis.

#### (h) Civil Penalties in the NHTSA Analysis

EPCA and EISA require that a manufacturer pay civil penalties if it does not have enough credits to cover a shortfall with one or both of the light-duty CAFE standards in a model year. While these provisions do not apply to HD pickups and vans, at this time, the CAFE model will show civil penalties owed in cases where available technologies and credits are estimated to be insufficient for a manufacturer to achieve compliance with a standard. These model-reported estimates have been excluded from this analysis. For Method A, this aspect of the model has been modified to also exclude from the calculation of "effective cost" used to select among available options to add specific technologies to specific vehicles.

#### (i) Coefficients for Fatality Calculations

Both the NPRM and the current analysis consider the potential effects on crash safety of the technologies manufacturers may apply to their vehicles to meet each of the regulatory alternatives. NHTSA research has shown that vehicle mass reduction affects overall societal fatalities associated with crashes<sup>473</sup> and, most relevant to this rule, mass reduction in heavier light- and medium-duty vehicles has an overall beneficial effect on societal fatalities. Reducing the mass of a heavier vehicle involved in a crash with another vehicle(s) makes it less

<sup>472</sup> Volpe CAFE Model, available at <http://www.nhtsa.gov/fuel-economy>.

<sup>473</sup> U.S. DOT/NHTSA, *Relationships Between Fatality Risk Mass and Footprint in MY 2000–2007 PC and LTVs*, ID: NHTSA–2010–0131–0336, Posted August 21, 2012.

likely there will be fatalities among the occupants of the other vehicles. In addition to the effects of mass reduction, the analysis anticipates that these standards, by reducing the cost of driving HD pickups and vans, will lead to increased travel by these vehicles and, therefore, more crashes involving these vehicles. The Method B analysis considers overall impacts considering both of these factors, using a methodology similar to NHTSA's analyses for the MYs 2017–2025 CAFE and GHG emission standards.

The Method B analysis includes estimates of the extent to which HD pickups and vans produced during MYs 2014–2030 may be involved in fatal crashes, considering the mass, survival, and mileage accumulation of these vehicles, taking into account changes in mass and mileage accumulation under each regulatory alternative. These calculations make use of the same coefficients applied to light trucks in the MYs 2017–2025 CAFE rulemaking analysis. Baseline rates of involvement in fatal crashes are 13.03 and 13.24 fatalities per billion miles for vehicles with initial curb weights above and below 4,594 lbs, respectively. Considering that the data underlying the corresponding statistical analysis included observations through calendar year 2010, these rates are reduced by 9.6 percent to account for subsequent impacts of recent Federal Motor Vehicle Safety Standards (FMVSS) and anticipated behavioral changes (*e.g.*, continued increases in seat belt use). For vehicles above 4,594 lbs—*i.e.*, the majority of the HD pickup and van fleet—mass reduction is estimated to reduce the net incidence of highway fatalities by 0.34 percent per 100 lbs. of removed curb weight. For the few HD pickups and vans below 4,594 lbs, mass reduction is estimated to increase the net incidence of highway fatalities by 0.52 percent per 100 lbs. Consistent with DOT guidance, the social cost of highway fatalities is estimated using a value of statistical life (VSL) of \$9.36m in 2014, increasing thereafter at 1.18 percent annually.

The Method A analysis uses the same methodology as described above, but applies coefficients that have been updated to reflect more current data, updated statistical analysis by NHTSA staff, and updated DOT guidance regarding the VSL. Baseline rates of involvement in fatal crashes are 16.06 and 14.35 fatalities per billion miles for pickups and vans with initial curb weights above and below 4,947 lbs, respectively. Considering that the data underlying the corresponding statistical analysis included observations through

calendar year 2012, these rates are reduced by 9.6 percent to account for subsequent impacts of recent Federal Motor Vehicle Safety Standards (FMVSS) and anticipated behavioral changes (*e.g.*, continued increases in seat belt use). For vehicles above 4,947 lbs—*i.e.*, the majority of the HD pickup and van fleet—mass reduction is estimated to reduce the net incidence of highway fatalities by 0.72 percent per 100 lbs. of removed curb weight. For HD pickups and vans below 4,947 lbs (accounting for any applied mass reduction), mass reduction is estimated to reduce the net incidence of highway fatalities by 0.10 percent per 100 lbs. Consistent with DOT guidance, the social cost of highway fatalities is estimated using a value of statistical life (VSL) of \$9.4m from 2015 forward.

#### (j) Compliance Credit Provisions

Today's analysis accounts for the potential to over comply with standards and thereby earn compliance credits, applying these credits to ensuring compliance requirements. In doing so, the agencies treat any unused carried-forward credits as expiring after five model years, consistent with current and standards. For today's analysis, the agencies are not estimating the potential to “borrow”—*i.e.*, to carry credits back to past model years.

#### (k) Emission Factors

While CAFE model calculates vehicular CO<sub>2</sub> emissions directly on a per-gallon basis using fuel consumption and fuel properties (density and carbon content), the model calculates emissions of other pollutants (methane, nitrogen oxides, ozone precursors, carbon monoxide, sulfur dioxide, particulate matter, and air toxics) on a per-mile basis. In doing so, the Method A analysis used corresponding emission factors estimated using EPA's MOVES model.<sup>474</sup> To estimate emissions (including CO<sub>2</sub>) from upstream processes involved in producing, distributing, and delivering fuel, NHTSA has applied emission factors—all specified on a gram per gallon basis—derived from Argonne National Laboratory's GREET model.<sup>475</sup>

#### (l) Refueling Time Benefits

To estimate the value of time savings associated with vehicle refueling, the Method A analysis used estimates that

an average refueling event involves refilling 60 percent of the tank's capacity over the course of 3.5 minutes, at an hourly cost of \$27.22.

#### (m) External Costs of Travel

Changes in vehicle travel will entail economic externalities. To estimate these costs, the Method A analysis used estimates that congestion-, crash-, and noise-related externalities will total 5.1¢/mi., 2.8¢/mi., and 0.1¢/mi., respectively.

#### (n) Ownership and Operating Costs

Method A results predict that the total cost of vehicle ownership and operation will change not just due to changes in vehicle price and fuel outlays, but also due to some other costs likely to vary with vehicle price. To estimate these costs, NHTSA has applied factors of 5.5 percent (of price) for taxes and fees, 15.3 percent for financing, 19.2 percent for insurance, 1.9 percent for relative value loss. The Method A analysis also estimates that average vehicle resale value will increase by 25 percent of any increase in new vehicle price.

#### (4) What Technologies Did the Agencies Consider

The agencies considered over 35 vehicle technologies that manufacturers could use to improve the fuel consumption and reduce CO<sub>2</sub> emissions of their vehicles during MYs 2021–2027. The majority of the technologies described in this section are readily available, well known and proven in other vehicle sectors, and could be incorporated into vehicles once production decisions are made. Other technologies considered may not currently be in production, but are beyond the research phase and under development, and are expected to be in production in highway vehicles over the next few years. These are technologies that are capable of achieving significant improvements in fuel economy and reductions in CO<sub>2</sub> emissions, at reasonable costs. The agencies did not consider technologies in the research stage because there is insufficient time for such technologies to move from research to production during the model years covered by this final action.

The technologies considered in the agencies' analysis are briefly described below. They fall into five broad categories: Engine technologies, transmission technologies, vehicle technologies, electrification/accessory technologies, and hybrid technologies.

In this class of trucks and vans, diesel engines are installed in about half of all vehicles. The buyer's decision to purchase a diesel versus gasoline engine

<sup>474</sup> EPA MOVES model available at <http://www3.epa.gov/otaq/models/moves/index.htm> (last accessed Feb 23, 2015).

<sup>475</sup> GREET (Greenhouse Gases, Regulated Emissions, and Energy Use in Transportation) Model, Argonne National Laboratory, <https://greet.es.anl.gov/>.

depends on several factors including initial purchase price, fuel operating costs, durability, towing capability and payload capacity amongst other reasons. As discussed in VI.B. above, the agencies generally prefer to set standards that do not distinguish between fuel types where technological or market-based reasons do not strongly argue otherwise. However, as with Phase 1, we continue to believe that fundamental differences between spark ignition and compression ignition engines warrant unique fuel standards, which is also important in ensuring that our program maintains product choices available to vehicle buyers. Therefore, as discussed in Section B.1, we are maintaining separate standards for gasoline and diesel vehicles. In the context of our technology discussion for heavy-duty pickups and vans, we are treating gasoline and diesel engines separately so each has a set of baseline technologies. We discuss performance improvements in terms of changes to those baseline engines. Our cost and inventory estimates contained elsewhere reflect the current fleet baseline with an appropriate mix of gasoline and diesel engines. Note that we are not basing these standards on a targeted switch in the mix of diesel and gasoline vehicles. We believe our standards require similar levels of technology development and cost for both diesel and gasoline vehicles. Hence the program is not intended to force, nor discourage, changes in a manufacturer's fleet mix between gasoline and diesel vehicles.

The following contains a description of technologies the agencies considered as potentially available in the rule timeframe, and hence, having potential to be part of a compliance pathway for these vehicles. Additionally, the agencies did not receive any comments indicating that the technology effectiveness estimates used in the determination of potential reductions in GHGs and fuel consumption are not representative of the expected ranges for expected duty cycles.

#### (a) Engine Technologies

The agencies reviewed the engine technology estimates used in the 2017–2025 light-duty rule, the 2014–2018 heavy-duty rule, and the 2015 NHTSA Technology Study. In doing so the agencies reconsidered all available sources and updated the estimates as appropriate. The section below describes both diesel and gasoline engine technologies considered for this program.

#### (i) Low Friction Lubricants

One of the most basic methods of reducing fuel consumption in both gasoline and diesel engines is the use of lower viscosity engine lubricants. More advanced multi-viscosity engine oils are available today with improved performance in a wider temperature band and with better lubricating properties. This can be accomplished by changes to the oil base stock (e.g., switching engine lubricants from a Group I base oils to lower-friction, lower viscosity Group III synthetic) and through changes to lubricant additive packages (e.g., friction modifiers and viscosity improvers). The use of 5W–30 motor oil is now widespread and auto manufacturers are introducing the use of even lower viscosity oils, such as 5W–20 and 0W–20, to improve cold-flow properties and reduce cold start friction. However, in some cases, changes to the crankshaft, rod and main bearings and changes to the mechanical tolerances of engine components may be required. In all cases, durability testing will be required to ensure that durability is not compromised. The shift to lower viscosity and lower friction lubricants will also improve the effectiveness of valvetrain technologies such as cylinder deactivation, which rely on a minimum oil temperature (viscosity) for operation.

#### (ii) Engine Friction Reduction

In addition to low friction lubricants, manufacturers can also reduce friction and improve fuel consumption by improving the design of both diesel and gasoline engine components and subsystems. Approximately 10 percent of the energy consumed by a vehicle is lost to friction, and just over half is due to frictional losses within the engine.<sup>476</sup> Examples include improvements in low-tension piston rings, piston skirt design, roller cam followers, improved crankshaft design and bearings, material coatings, material substitution, more optimal thermal management, and piston and cylinder surface treatments. Additionally, as computer-aided modeling software continues to improve, more opportunities for evolutionary friction reductions may become available. All reciprocating and rotating components in the engine are potential candidates for friction

<sup>476</sup> "Impact of Friction Reduction Technologies on Fuel Economy," Fenske, G. Presented at the March 2009 Chicago Chapter Meeting of the 'Society of Tribologists and Lubricated Engineers' Meeting, March 18th, 2009. Available at: <http://www.chicagostle.org/program/2008-2009/Impact%20of%20Friction%20Reduction%20Technologies%20on%20Fuel%20Economy%20-%20with%20VGs%20removed.pdf> (last accessed July 9, 2009).

reduction, and minute improvements in several components can add up to a measurable fuel efficiency improvement.

#### (iii) Engine Parasitic Demand Reduction

In addition to physical engine friction reduction, manufacturers can reduce the mechanical load on the engine from parasitics, such as oil, fuel, and coolant pumps. The high-pressure fuel pumps of direct-injection gasoline and diesel engines have particularly high demand. Example improvements include variable speed or variable displacement water pumps, variable displacement oil pumps, more efficient high pressure fuel pumps, valvetrain upgrades and shutting off piston cooling when not needed.

#### (iv) Coupled Cam Phasing

Valvetrains with coupled (or coordinated) cam phasing can modify the timing of both the inlet valves and the exhaust valves an equal amount by phasing the camshaft of an overhead valve engine.<sup>477</sup> For overhead valve engines, which have only one camshaft to actuate both inlet and exhaust valves, couple cam phasing is the only variable valve timing (VVT) implementation option available and requires only one cam phaser.<sup>478</sup> We also considered variable valve lift (VVL), which alters the intake valve lift in order to reduce pumping losses and more efficiently ingest air.

#### (v) Cylinder Deactivation

In conventional spark-ignited engines throttling the airflow controls engine torque output. At partial loads, efficiency can be improved by using cylinder deactivation instead of throttling. Cylinder deactivation can improve engine efficiency by disabling or deactivating (usually) half of the cylinders when the load is less than half of the engine's total torque capability—the valves are kept closed, and no fuel is injected—as a result, the trapped air within the deactivated cylinders is simply compressed and expanded as an air spring, with reduced friction and

<sup>477</sup> Although couple cam phasing appears only in the single overhead cam and overhead valve branches of the decision tree, it is noted that a single phaser with a secondary chain drive would allow couple cam phasing to be applied to direct overhead cam engines. Since this would potentially be adopted on a limited number of direct overhead cam engines NHTSA did not include it in that branch of the decision tree.

<sup>478</sup> It is also noted that coaxial camshaft developments would allow other variable valve timing options to be applied to overhead valve engines. However, since they would potentially be adopted on a limited number of overhead valve engines, NHTSA did not include them in the decision tree.

heat losses. The active cylinders combust at almost double the load required if all of the cylinders were operating. Pumping losses are significantly reduced as long as the engine is operated in this "part-cylinder" mode.

Cylinder deactivation control strategy relies on setting maximum manifold absolute pressures or predicted torque within a range in which it can deactivate the cylinders. Noise and vibration issues reduce the operating range to which cylinder deactivation is allowed, although manufacturers are exploring vehicle changes that enable increasing the amount of time that cylinder deactivation might be suitable. Some manufacturers may choose to adopt active engine mounts and/or active noise cancellations systems to address Noise Vibration and Harshness (NVH) concerns and to allow a greater operating range of activation.

Cylinder deactivation has seen a recent resurgence thanks to better valvetrain designs and engine controls. General Motors and Fiat Chrysler have incorporated cylinder deactivation across a substantial portion of their V8-powered lineups, including some heavy duty applications.

#### (vi) Stoichiometric Gasoline Direct Injection

SGDI engines inject fuel at high pressure directly into the combustion chamber (rather than the intake port in port fuel injection). SGDI requires changes to the injector design, an additional high pressure fuel pump, new fuel rails to handle the higher fuel pressures and changes to the cylinder head and piston crown design. Direct injection of the fuel into the cylinder improves cooling of the air/fuel charge within the cylinder, which allows for higher compression ratios and increased thermodynamic efficiency without the onset of combustion knock. Recent injector design advances, improved electronic engine management systems and the introduction of multiple injection events per cylinder firing cycle promote better mixing of the air and fuel, enhance combustion rates, increase residual exhaust gas tolerance and improve cold start emissions. SGDI engines achieve higher power density and match well with other technologies, such as boosting and variable valvetrain designs.

Most manufacturers have introduced vehicles with SGDI engines in light duty sectors, including GM and Ford and have announced their plans to increase dramatically the number of SGDI engines in their portfolios. SGDI has not been introduced on heavy duty

applications at this time however as these largely dedicated heavy duty engines approach their redesign window, they are expected to become SGDI engines.

#### (vii) Turbocharging and Downsizing

The specific power of a naturally aspirated engine is primarily limited by the rate at which the engine is able to draw air into the combustion chambers. Turbocharging and supercharging (grouped together here as boosting) are two methods to increase the intake manifold pressure and cylinder charge-air mass above naturally aspirated levels. Boosting increases the airflow into the engine, thus increasing the specific power level, and with it the ability to reduce engine displacement while maintaining performance. This effectively reduces the pumping losses at lighter loads in comparison to a larger, naturally aspirated engine.

Almost every major manufacturer currently markets a vehicle with some form of boosting. While boosting has been a common practice for increasing performance for several decades, turbocharging has considerable potential to improve fuel economy and reduce CO<sub>2</sub> emissions when the engine displacement is also reduced. Specific power levels for a boosted engine often exceed 100 hp/L, compared to average naturally aspirated engine power densities of roughly 70 hp/L. As a result, engines can be downsized roughly 30 percent or higher while maintaining similar peak output levels. In the last decade, improvements to turbocharger turbine and compressor design have improved their reliability and performance across the entire engine operating range. New variable geometry turbines and ball-bearing center cartridges allow faster turbocharger spool-up (virtually eliminating the once-common "turbo lag") while maintaining high flow rates for increased boost at high engine speeds. Low speed torque output has been dramatically improved for modern turbocharged engines. However, even with turbocharger improvements, maximum engine torque at very low engine speed conditions, for example launch from standstill, is increased less than at mid and high engine speed conditions. The potential to downsize engines may be less on vehicles with low displacement to vehicle mass ratios for example a very small displacement engine in a vehicle with significant curb weight, in order to provide adequate acceleration from standstill, particularly up grades or at high altitudes.

The use of GDI in combination with turbocharging and charge air cooling

reduces the fuel octane requirements for knock limited combustion enabling the use of higher compression ratios and boosting pressures. Recently published data with advanced spray-guided injection systems and more aggressive engine downsizing targeted towards reduced fuel consumption and CO<sub>2</sub> emissions reductions indicate that the potential for reducing CO<sub>2</sub> emissions for turbocharged, downsized GDI engines may be as much as 15 to 30 percent relative to port-fuel-injected engines.<sup>14 15 16 17 18</sup> Confidential manufacturer data suggests an incremental range of fuel consumption and CO<sub>2</sub> emission reduction of 4.8 to 7.5 percent for turbocharging and downsizing. Other publicly-available sources suggest a fuel consumption and CO<sub>2</sub> emission reduction of 8 to 13 percent compared to current-production naturally-aspirated engines without friction reduction or other fuel economy technologies: A joint technical paper by Bosch and Ricardo suggesting fuel economy gain of 8 to 10 percent for downsizing from a 5.7 liter port injection V8 to a 3.6 liter V6 with direct injection using a wall-guided direct injection system; a Renault report suggesting a 11.9 percent NEDC fuel consumption gain for downsizing from a 1.4 liter port injection in-line 4-cylinder engine to a 1.0 liter in-line 4-cylinder engine, also with wall-guided direct injection; and a Robert Bosch paper suggesting a 13 percent NEDC gain for downsizing to a turbocharged DI engine, again with wall-guided injection. These reported fuel economy benefits show a wide range depending on the SGDI technology employed.

Note that for this analysis the agencies determined that this technology path is only applicable to heavy duty applications that have operating conditions more closely associated with light duty vehicles. This includes vans designed mainly for cargo volume or modest payloads and having similar GCWR to light duty applications. These vans cannot tow trailers heavier than similar light duty vehicles and are largely already sharing engines of significantly smaller displacement and cylinder count compared to heavy duty vehicles designed mainly for trailer towing.

ACEEE commented that 10 percent of pick-ups in the heavy duty sector are candidates for turbocharging and downsizing if they do not require higher payloads or towing capacity. Other commenters suggested that downsizing that has occurred in light duty could also occur in heavy duty. As discussed above, the agencies evaluated turbocharging and downsizing in

vehicles like vans which are not typically designed for extensive trailer towing. When we looked at pick-ups, we determined that consumers needing a pick-up without higher payload or trailer towing requirements would migrate to the lower cost light-duty versions which are typically identical in cabin size and seating as the heavy-duty versions but have less work capability. Because of this, in the agencies' assessment, the heavy-duty pickups retained the high trailer towing and payload requirements and the corresponding larger engines. AAPC comments supported this approach as the correct combination of engine to intended use and even provided in their comments data indicating that turbocharged and downsized engines are more fuel efficient at lighter loads however under working conditions expected of a heavy-duty pick-up they are actually less fuel efficient than the larger engines.

#### (viii) Cooled Exhaust-Gas Recirculation

Cooled exhaust gas recirculation or Boosted EGR is a combustion concept that involves utilizing EGR as a charge diluent for controlling combustion temperatures and cooling the EGR prior to its introduction to the combustion system. Higher exhaust gas residual levels at part load conditions reduce pumping losses for increased fuel economy. The additional charge dilution enabled by cooled EGR reduces the incidence of knocking combustion and obviates the need for fuel enrichment at high engine power. This allows for higher boost pressure and/or compression ratio and further reduction in engine displacement and both pumping and friction losses while maintaining performance. Engines of this type use GDI and both dual cam phasing and discrete variable valve lift. The EGR systems considered in this final rule, consistent with the rule, will use a dual-loop system with both high and low pressure EGR loops and dual EGR coolers. The engines will also use single-stage, variable geometry turbocharging with higher intake boost pressure available across a broader range of engine operation than conventional turbocharged SI engines. Such a system is estimated to be capable of an additional 3 to 5 percent effectiveness relative to a turbocharged, downsized GDI engine without cooled-EGR. The agencies have also considered a more advanced version of such a cooled EGR system that employs very high combustion pressures by using dual stage turbocharging.

#### (ix) Lean-Burn Combustion

The agencies considered the concept that gasoline engines that are normally stoichiometric mainly for emission reasons can run lean over a range of operating conditions and utilize diesel like aftertreatment systems to control NO<sub>x</sub>. For this analysis, we determined that the modal operation nature of this technology is currently only beneficial at light loads and will not be appropriate for a heavy duty application purchase specifically for its high work and load capacity.

#### (b) Diesel Engine Technologies

Diesel engines have several characteristics that give them superior fuel efficiency compared to conventional gasoline, spark-ignited engines. Pumping losses are much lower due to lack of (or greatly reduced) throttling. The diesel combustion cycle operates at a higher compression ratio, with a very lean air/fuel mixture, and turbocharged light-duty diesels typically achieve much higher torque levels at lower engine speeds than equivalent-displacement naturally-aspirated gasoline engines. Additionally, diesel fuel has a higher energy content per gallon.<sup>479</sup> However, diesel fuel also has a higher carbon to hydrogen ratio, which increases the amount of CO<sub>2</sub> emitted per gallon of fuel used by approximately 15 percent over a gallon of gasoline.

Based on confidential business information and the 2010 NAS Report, two major areas of diesel engine design could be improved during the timeframe of this final rule. These areas include aftertreatment improvements and a broad range of engine improvements.

#### (i) Aftertreatment Improvements

The HD diesel pickup and van segment has largely adopted the SCR type of aftertreatment system to comply with criteria pollutant emission standards. As the experience base for SCR expands over the next few years, many improvements in this aftertreatment system such as construction of the catalyst, thermal management, and reductant optimization may result in a reduction in the amount of fuel used in the process. However, due to uncertainties with these improvements regarding the extent of current optimization and future criteria emissions obligations, the agencies are not considering aftertreatment improvements as a fuel-

<sup>479</sup> Burning one gallon of diesel fuel produces about 15 percent more carbon dioxide than gasoline due to the higher density and carbon to hydrogen ratio.

saving technology in the rulemaking analysis.

#### (ii) Engine Improvements

Diesel engines in the HD pickup and van segment are expected to have several improvements in their base design in the 2021–2027 timeframe. These improvements include items such as improved combustion management, optimal turbocharger design, and improved thermal management.

#### (c) Transmission Technologies

The agencies have also reviewed the transmission technology estimates used in the 2017–2015 light-duty and 2014–2018 heavy-duty final rules. In doing so, NHTSA and EPA considered or reconsidered all available sources including the 2015 NHTSA Technology Study and updated the estimates as appropriate. The section below describes each of the transmission technologies considered for this rule.

#### (i) Automatic 8-Speed Transmissions

Manufacturers can also choose to replace 6-speed automatic transmissions with 8-speed automatic transmissions. Additional ratios allow for further optimization of engine operation over a wider range of conditions, but this is subject to diminishing returns as the number of speeds increases. As additional gear sets are added, additional weight and friction are introduced requiring additional countermeasures to offset these losses. Some manufacturers are replacing 6-speed automatics already, and 7 to 10-speed automatics have entered production.

#### (ii) High Efficiency Transmission

For this rule, a high efficiency transmission refers to some or all of a suite of incremental transmission improvement technologies that should be available within the 2019 to 2027 timeframe. The majority of these improvements address mechanical friction within the transmission. These improvements include but are not limited to: Shifting clutch technology improvements, improved kinematic design, dry sump lubrication systems, more efficient seals, bearings and clutches (reducing drag), component superfinishing and improved transmission lubricants.

#### (iii) Secondary Axle Disconnect

The ability to disconnect some of the rotating components in the front axle on 4wd vehicles when the secondary axle is not needed for traction. This will reduce friction and increase fuel economy.

## (d) Electrification/Accessory Technologies

## (i) Electrical Power Steering or Electrohydraulic Power Steering

Electric power steering (EPS) or Electrohydraulic power steering (EHPS) provides a potential reduction in CO<sub>2</sub> emissions and fuel consumption over hydraulic power steering because of reduced overall accessory loads. This eliminates the parasitic losses associated with belt-driven power steering pumps which consistently draw load from the engine to pump hydraulic fluid through the steering actuation systems even when the wheels are not being turned. EPS is an enabler for all vehicle hybridization technologies since it provides power steering when the engine is off. EPS may be implemented on most vehicles with a standard 12V system. Some heavier vehicles may require a higher voltage system which may add cost and complexity.

## (ii) Improved Accessories

The accessories on an engine, including the alternator, coolant and oil pumps are traditionally mechanically-driven. A reduction in CO<sub>2</sub> emissions and fuel consumption can be realized by driving them electrically, and only when needed (“on-demand”).

Electric water pumps and electric fans can provide better control of engine cooling. For example, coolant flow from an electric water pump can be reduced and the radiator fan can be shut off during engine warm-up or cold ambient temperature conditions which will reduce warm-up time, reduce warm-up fuel enrichment, and reduce parasitic losses.

Indirect benefit may be obtained by reducing the flow from the water pump electrically during the engine warm-up period, allowing the engine to heat more rapidly and thereby reducing the fuel enrichment needed during cold operation and warm-up of the engine. Faster oil warm-up may also result from better management of the coolant warm-up period. Further benefit may be obtained when electrification is combined with an improved, higher efficiency engine alternator used to supply power to the electrified accessories.

Intelligent cooling can more easily be applied to vehicles that do not typically carry heavy payloads, so larger vehicles with towing capacity present a challenge, as these vehicles have high cooling fan loads.<sup>480</sup> However, towing vehicles tend to have large cooling

system capacity and flow scaled to required heat rejection levels when under full load situations such as towing at GCWR in extreme ambient conditions. During almost all other situations, this design characteristic may result in unnecessary energy usage for coolant pumping and heat rejection to the radiator.

The agencies considered whether to include electric oil pump technology for the rulemaking. Because it is necessary to operate the oil pump any time the engine is running, electric oil pump technology has insignificant effect on efficiency. Therefore, the agencies decided to not include electric oil pump technology.

## (iii) Mild Hybrid

Mild hybrid systems offer idle-stop functionality and a limited level of regenerative braking and power assist. These systems replace the conventional alternator with a belt or crank driven starter/alternator and may add high voltage electrical accessories (which may include electric power steering and an auxiliary automatic transmission pump). The limited electrical requirements of these systems allow the use of lead-acid batteries or supercapacitors for energy storage, or the use of a small lithium-ion battery pack.

## (iv) Strong Hybrid

A hybrid vehicle is a vehicle that combines two significant sources of propulsion energy, where one uses a consumable fuel (like gasoline), and one is rechargeable (during operation, or by another energy source). Hybrid technology is well established in the U.S. light-duty market and more manufacturers are adding hybrid models to their lineups. Hybrids reduce fuel consumption through three major mechanisms:

- The internal combustion engine can be optimized (through downsizing, modifying the operating cycle, or other control techniques) to operate at or near its most efficient point more of the time. Power loss from engine downsizing can be mitigated by employing power assist from the secondary power source.
- A significant amount of the energy normally lost as heat while braking can be captured and stored in the energy storage system for later use.
- The engine is turned off when it is not needed, such as when the vehicle is coasting or when stopped.

Hybrid vehicles utilize some combination of the three above mechanisms to reduce fuel consumption and CO<sub>2</sub> emissions. The effectiveness of fuel consumption and CO<sub>2</sub> reduction

depends on the utilization of the above mechanisms and how aggressively they are pursued. One area where this variation is particularly prevalent is in the choice of engine size and its effect on balancing fuel economy and performance. Some manufacturers choose not to downsize the engine when applying hybrid technologies. In these cases, overall performance (acceleration) is typically improved beyond the conventional engine. However, fuel efficiency improves less than if the engine was downsized to maintain the same performance as the conventional version. The non-downsizing approach is used for vehicles like trucks where towing and/or hauling are an integral part of their performance requirements. In these cases, if the engine is downsized, the battery can be quickly drained during a long hill climb with a heavy load, leaving only a downsized engine to carry the entire load. Because towing capability is currently a heavily-marketed truck attribute, manufacturers are hesitant to offer a truck with a downsized engine, which can lead to a significantly diminished towing performance when the battery state of charge level is low, and therefore engines are traditionally not downsized for these vehicles. In assessing the cost of this technology, the agencies consequently assumed the cost of a full size engine.

Strong Hybrid technology utilizes an axial electric motor connected to the transmission input shaft and connected to the engine crankshaft through a clutch. The axial motor is a motor/generator that can provide sufficient torque for launch assist, all electric operation, and the ability to recover significant levels of braking energy.

## (e) Vehicle Technologies

## (i) Mass Reduction

Mass reduction is a technology that can be used in a manufacturer's strategy to meet the Heavy Duty Greenhouse Gas Phase 2 standards. Vehicle mass reduction (also referred to as “down-weighting” or “light-weighting”), decreases fuel consumption and GHG emissions by reducing the energy demand needed to overcome inertia forces, and rolling resistance. Automotive companies have worked with mass reduction technologies for many years and a lot of these technologies have been used in production vehicles. The weight savings achieved by adopting mass reduction technologies offset weight gains due to increased vehicle size, larger powertrains, and increased feature content (sound insulation,

<sup>480</sup>In the CAFE model, improved accessories refers solely to improved engine cooling.

entertainment systems, improved climate control, panoramic roof, etc.). Sometimes mass reduction has been used to increase vehicle towing and payload capabilities.

Manufacturers employ a systematic approach to mass reduction, where the net mass reduction is the addition of a direct component or system mass reduction, also referred to as primary mass reduction, plus the additional mass reduction taken from indirect ancillary systems and components, also referred to as secondary mass reduction or mass compounding. There are more secondary mass reductions achievable for light-duty vehicles compared to heavy-duty vehicles, which are limited due to the higher towing and payload requirements for these vehicles.

Mass reduction can be achieved through a number of approaches, even while maintaining other vehicle functionalities. As summarized by NAS in its 2011 light duty vehicle report,<sup>481</sup> there are two key strategies for primary mass reduction: (1) Changing the design to use less material; (2) substituting lighter materials for heavier materials.

The first key strategy of using less material compared to the baseline component can be achieved by optimizing the design and structure of vehicle components, systems and vehicle structure. Vehicle manufacturers have long used these continually-improving CAE tools to optimize vehicle designs. For example, the Future Steel Vehicle (FSV) project<sup>482</sup> sponsored by WorldAutoSteel used three levels of optimization: Topology optimization, low fidelity 3G (Geometry Grade and Gauge) optimization, and subsystem optimization, to achieve 30 percent mass reduction in the body structure of a vehicle with a mild steel unibody structure. Using less material can also be achieved through improving the manufacturing process, such as by using improved joining technologies and parts consolidation. This method is often used in combination with applying new materials.

The second key strategy to reduce mass of an assembly or component involves the substitution of lower density and/or higher strength materials. Material substitution includes replacing materials, such as mild steel,

with higher-strength and advanced steels, aluminum, magnesium, and composite materials. In practice, material substitution tends to be quite specific to the manufacturer and situation. Some materials work better than others for particular vehicle components, and a manufacturer may invest more heavily in adjusting to a particular type of advanced material, thus complicating its ability to consider others. The agencies recognize that like any type of mass reduction, material substitution has to be conducted not only with consideration to maintaining equivalent component strength, but also to maintaining all the other attributes of that component, system or vehicle, such as crashworthiness, durability, and noise, vibration and harshness (NVH).

If vehicle mass is reduced sufficiently through application of the two primary strategies of using less material and material substitution described above, secondary mass reduction options may become available. Secondary mass reduction is enabled when the load requirements of a component are reduced as a result of primary mass reduction. If the primary mass reduction reaches a sufficient level, a manufacturer may use a smaller, lighter, and potentially more efficient powertrain while maintaining vehicle acceleration performance. If a powertrain is downsized, a portion of the mass reduction may be attributed to the reduced torque requirement which results from the lower vehicle mass. The lower torque requirement enables a reduction in engine displacement, changes to transmission torque converter and gear ratios, and changes to final drive gear ratio. The reduced powertrain torque enables the downsizing and/or mass reduction of powertrain components and accompanying reduced rotating mass (e.g., for transmission, driveshafts/halfshafts, wheels, and tires) without sacrificing powertrain durability. Likewise, the combined mass reductions of the engine, drivetrain, and body in turn reduce stresses on the suspension components, steering components, wheels, tires, and brakes, which can allow further reductions in the mass of these subsystems. Reducing the unsprung masses such as the brakes, control arms, wheels, and tires further reduce stresses in the suspension mounting points, which will allow for further optimization and potential mass reduction. However, pickup trucks have towing and hauling requirements which must be taken into account when determining the amount of secondary

mass reduction that is possible and so it is less than that of passenger cars.

In 2015, EPA completed a multi-year study with FEV North America, Inc. on the lightweighting of a light-duty pickup truck, a 2011 GMC Silverado, titled "Mass Reduction and Cost Analysis—Light-Duty Pickup Trucks Model Years 2020–2025."<sup>483</sup> Results contain a cost curve for various mass reduction percentages with the main solution being evaluated for a 20.8 percent (510 kg/1122 lb.) mass reduction resulting in an increased direct incremental manufacturing cost of \$2228. In addition, the report outlines the compounding effect that occurs in a vehicle with performance requirements including hauling and towing. Secondary mass evaluation was performed on a component level based on an overall 20 percent vehicle mass reduction. Results revealed 84 kg of the 510 kg, or 20 percent of the overall mass reduction, were from secondary mass reduction. Information on this study is summarized in SAE paper 2015-01-0559. NHTSA has also sponsored an ongoing pickup truck lightweighting project. This project uses a more recent baseline vehicle, a MY 2014 GMC Silverado, and the project will be finished in 2016. Both projects will be utilized for the light-duty GHG and CAFE Midterm Evaluation mass reduction baseline characterization and may be used to update assumptions of mass reduction for HD pickups and vans for the final Phase 2 rulemaking.

In order to determine if technologies identified on light duty trucks are applicable to heavy-duty pickups, EPA contracted with FEV North America, Inc. to perform a scaling study in order to evaluate whether the technologies identified for the light-duty truck would be applicable for a heavy-duty pickup truck. In this study a 2013MY Silverado 2500, a 2007 Mercedes Sprinter and a 2010 Renault Master<sup>484</sup> were analyzed. A 2013MY Silverado 2500 was purchased and torn down. The mass reduction results were 18.9 percent mass reduction at a cost of \$2,372 and focused on aluminum intensive with AHSS frame. The Mercedes Sprinter and Renault Master analyses were performed based on information from the A2Mac1 database. The results were 18.15 percent mass reduction at a cost add of \$2,293 for the Mercedes Sprinter

<sup>481</sup> Committee on the Assessment of Technologies for Improving Light-Duty Vehicle Fuel Economy; National Research Council, "Assessment of Fuel Economy Technologies for Light-Duty Vehicles," 2011. Available at [http://www.nap.edu/catalog.php?record\\_id=12924](http://www.nap.edu/catalog.php?record_id=12924) (last accessed Jun 27, 2012).

<sup>482</sup> SAE World Congress, "Focus B-pillar 'tailor rolled' to 8 different thicknesses," Feb. 24, 2010. Available at <http://www.sae.org/mags/AEI/7695> (last accessed Jun. 10, 2012).

<sup>483</sup> "Mass Reduction and Cost Analysis—Light-Duty Pickup Trucks Model Years 2020–2025," FEV, North America, Inc., April 2015, Document no. EPA-420-R-15-006.

<sup>484</sup> "Mass Reduction and Cost Analysis Heavy Duty Pickup Truck and Light Commercial Vans," 2016, EPA-420-D-16-003.



and 18.55 percent mass reduction at a cost add of \$2,293 for the Master.

In September 2015, Ford announced that its MY 2017 F-Series Super duty pickup (F250) would be manufactured with an aluminum body and overall the truck will be 350 lbs. lighter (5 percent–6 percent) than the current generation truck with steel.<sup>485 486</sup> This is less overall mass reduction than the resultant lightweighting effort on the MY 2015 F–150, which achieved up to 750 lb. decrease in curb weight (12 percent–13 percent) per vehicle.<sup>487</sup> Strategies were employed by Ford in the F250 to “improve the productivity of the Super Duty.” In addition, Ford added several safety systems (and consequent mass) including cameras, lane departure warning, brake assist, etc. More details on the F250 will be known once it is released; however, a review of the F150 vehicle aluminum intensive design shows that it has an aluminum cab structure, body panels, and suspension components, as well as a high strength steel frame and a smaller, lighter and more efficient engine. The Executive Summary to Ducker Worldwide’s 2014 report<sup>488</sup> states that the MY 2015 F–150 contains 1080 lbs. of aluminum with at least half being aluminum sheet and extrusions for body and closures. Ford’s engine range for its light duty truck fleet includes a 2.7L EcoBoost V–6. The integrated loop, between Ford and the aluminum sheet suppliers, of aluminum manufacturing scrap and new aluminum sheet is integral to making aluminum a feasible lightweighting technology option for Ford. It is also possible that the strategy of aluminum body panels will be applied to the heavy duty F–350 version when it is redesigned.<sup>489</sup>

The RIA for this rulemaking shows that 10 percent or less mass reduction is part of the projected strategy for compliance for HD pickups and vans. The cost and effectiveness assumptions for mass reduction technology are described in the RIA.

<sup>485</sup> <http://www.techtimes.com/articles/87961/20150925/ford-s-2017-f-250-super-duty-with-an-aluminum-body-is-the-toughest-smartest-and-most-capable-super-duty-ever.htm>, September 25, 2015.

<sup>486</sup> <https://www.ford.com/trucks/superduty/2017/>.

<sup>487</sup> “2008/9 Blueprint for Sustainability,” Ford Motor Company. Available at: <http://www.ford.com/go/sustainability> (last accessed February 8, 2010).

<sup>488</sup> “2015 North American Light Vehicle Aluminum Content Study—Executive Summary,” June 2014, <http://www.drivealuminum.org/research-resources/PDF/Research/2014/2014-ducker-report> (last accessed February 26, 2015).

<sup>489</sup> <http://www.foxnews.com/leisure/2014/09/30/ford-confirms-increased-aluminum-use-on-next-gen-super-duty-pickups/>.

#### (ii) Low Rolling Resistance Tires

Tire rolling resistance is the frictional loss associated mainly with the energy dissipated in the deformation of the tires under load and thus influences fuel efficiency and CO<sub>2</sub> emissions. Other tire design characteristics (e.g., materials, construction, and tread design) influence durability, traction (both wet and dry grip), vehicle handling, and ride comfort in addition to rolling resistance. A typical LRR tire’s attributes will include: Increased tire inflation pressure, material changes, and tire construction with less hysteresis, geometry changes (e.g., reduced aspect ratios), and reduction in sidewall and tread deflection. These changes will generally be accompanied with additional changes to suspension tuning and/or suspension design.

#### (iii) Aerodynamic Drag Reduction

Many factors affect a vehicle’s aerodynamic drag and the resulting power required to move it through the air. While these factors change with air density and the square and cube of vehicle speed, respectively, the overall drag effect is determined by the product of its frontal area and drag coefficient, Cd. Reductions in these quantities can therefore reduce fuel consumption and CO<sub>2</sub> emissions. Although frontal areas tend to be relatively similar within a vehicle class (mostly due to market-competitive size requirements), significant variations in drag coefficient can be observed. Significant changes to a vehicle’s aerodynamic performance may need to be implemented during a redesign (e.g., changes in vehicle shape). However, shorter-term aerodynamic reductions, with a somewhat lower effectiveness, may be achieved through the use of revised exterior components (typically at a model refresh in mid-cycle) and add-on devices that currently being applied. The latter list will include revised front and rear fascias, modified front air dams and rear valances, addition of rear deck lips and underbody panels, and lower aerodynamic drag exterior mirrors.

#### (f) Air Conditioning Technologies

These technologies include improved hoses, connectors and seats for leakage control. They also include improved compressors, expansion valves, heat exchangers and the control of these components for the purposes of improving tailpipe CO<sub>2</sub> emissions as a result of A/C use.<sup>490</sup>

<sup>490</sup> See RIA Chapter 2.3 for more detailed technology descriptions.

(5) How did the agencies determine the costs and effectiveness of each of these technologies?

Building on the technical analysis underlying the 2017–2025 MY light-duty vehicle rule, the 2014–2018 MY heavy-duty vehicle rule, and the 2015 NHTSA Technology Study, the agencies took a fresh look at technology cost and effectiveness values for purposes of this rule. For costs, the agencies reconsidered both the direct (or “piece”) costs and indirect costs of individual components of technologies. For the direct costs, the agencies followed a bill of materials (BOM) approach employed by the agencies in the light-duty rule as well as referencing costs from the 2014–2018 MY heavy-duty vehicle rule and a new cost survey performed by Tetra Tech in 2014.

For two technologies, stoichiometric gasoline direct injection (SGDI) and turbocharging with engine downsizing, the agencies relied to the extent possible on the available tear-down data and scaling methodologies used in EPA’s ongoing study with FEV, Incorporated. This study consists of complete system tear-down to evaluate technologies down to the nuts and bolts to arrive at very detailed estimates of the costs associated with manufacturing them.<sup>491</sup>

For the other technologies, considering all sources of information and using the BOM approach, the agencies worked together intensively to determine component costs for each of the technologies and build up the costs accordingly. Where estimates differ between sources, we have used engineering judgment to arrive at what we believe to be the best cost estimate available today, and explained the basis for that exercise of judgment.

Once costs were determined, they were adjusted to ensure that they were all expressed in 2012 dollars, and indirect costs were accounted for using a methodology consistent with the new ICM approach developed by EPA and used in the Phase 1 rule, and the 2012–2016 and 2017–2025 light-duty rules. NHTSA and EPA also reconsidered how costs should be adjusted by modifying or scaling content assumptions to account for differences across the range of vehicle sizes and functional requirements, and adjusted the associated material cost impacts to account for the revised content. We present the individual technology costs used in this analysis in Chapter 2.11 of the RIA.

<sup>491</sup> U.S. Environmental Protection Agency, “Draft Report—Light-Duty Technology Cost Analysis Pilot Study,” Contract No. EP–C–07–069, Work Assignment 1–3, September 3, 2009.



Regarding estimates for technology effectiveness, the agencies used the estimates from the 2014 Southwest Research Institute study as a baseline, which was designed specifically to inform this rulemaking. In addition, the agencies used 2017–2025 light-duty rule as a reference, and adjusted these estimates as appropriate, taking into account the unique requirement of the heavy-duty test cycles to test at curb weight plus half payload versus the light-duty requirement of curb plus 300 lbs. The adjustments were made on an individual technology basis by assessing the specific impact of the added load on each technology when compared to the use of the technology on a light-duty vehicle. The agencies also considered other sources such as the 2010 NAS Report, recent compliance data, and confidential manufacturer estimates of technology effectiveness. The agencies reviewed effectiveness information from the multiple sources for each technology and ensured that such effectiveness estimates were based on technology hardware consistent with the BOM components used to estimate costs. Together, the agencies compared the multiple estimates and assessed their validity, taking care to ensure that common BOM definitions and other vehicle attributes such as performance and drivability were taken into account.

The agencies note that the effectiveness values estimated for the technologies may represent average values applied to the baseline fleet described earlier, and do not reflect the potentially limitless spectrum of possible values that could result from adding the technology to different vehicles. For example, while the

agencies have estimated an effectiveness of 0.5 percent for low friction lubricants, each vehicle could have a unique effectiveness estimate depending on the baseline vehicle’s oil viscosity rating. Similarly, the reduction in rolling resistance (and thus the improvement in fuel efficiency and the reduction in CO<sub>2</sub> emissions) due to the application of LRR tires depends not only on the unique characteristics of the tires originally on the vehicle, but on the unique characteristics of the tires being applied, characteristics which must be balanced between fuel efficiency, safety, and performance. Aerodynamic drag reduction is much the same—it can improve fuel efficiency and reduce CO<sub>2</sub> emissions, but it is also highly dependent on vehicle-specific functional objectives. For purposes of this final rule, the agencies believe that employing average values for technology effectiveness estimates is an appropriate way of recognizing the potential variation in the specific benefits that individual manufacturers (and individual vehicles) might obtain from adding a fuel-saving technology.

The assessment of the technology effectiveness and costs was determined from a combination of sources. First an assessment was performed by SwRI under contract with the agencies to determine the effectiveness and costs on several technologies that were generally not considered in the Phase 1 GHG rule time frame. Some of the technologies were common with the light-duty assessment but the effectiveness and costs of individual technologies were appropriately adjusted to match the expected effectiveness and costs when implemented in a heavy-duty

application. Finally, the agencies performed extensive outreach to suppliers of engine, transmission and vehicle technologies applicable to heavy-duty applications to get industry input on cost and effectiveness of potential GHG and fuel consumption reducing technologies. The agencies did not receive comments disputing the expected technology effectiveness values or costs developed with input from industry.

To achieve the levels of the Phase 2 standards for gasoline and diesel powered heavy-duty vehicles, a combination of the technologies previously discussed will be required respective to unique gasoline and diesel technologies and their challenges. Although some of the technologies may already be implemented in a portion of heavy-duty vehicles, none of the technologies discussed are considered ubiquitous in the heavy-duty fleet. Also, as will be expected, the available test data show that some vehicle models will not need the full complement of available technologies to achieve these standards. Furthermore, many technologies can be further improved (e.g., aerodynamic improvements) from today’s best levels, and so allow for compliance without needing to apply a technology that a manufacturer might deem less desirable.

Technology costs for HD pickups and vans are shown in Table VI–4. These costs reflect direct and indirect costs to the vehicle manufacturer for the 2021 model year. See Chapter 2.11. of the RIA for a more complete description of the basis of these costs.

TABLE VI–4—TECHNOLOGY COSTS FOR HD PICKUPS & VANS INCLUSIVE OF INDIRECT COST MARKUPS FOR MY 2021 [2012\$]

Technology	Gasoline	Diesel
Engine changes to accommodate low friction lubes .....	6	6
Engine friction reduction—level 1 .....	116	116
Engine friction reduction—level 2 .....	254	254
Dual cam phasing .....	183	183
Cylinder deactivation .....	196	N/A
Stoichiometric gasoline direct injection .....	451	N/A
Turbo improvements .....	N/A	16
Cooled EGR .....	373	373
Turbocharging & downsizing <sup>a</sup> .....	671	N/A
“Right-sized” diesel from larger diesel .....	N/A	0
8s automatic transmission (increment to 6s automatic transmission) .....	457	457
Improved accessories—level 1 .....	82	82
Improved accessories—level 2 .....	132	132
Low rolling resistance tires—level 1 .....	10	10
Passive aerodynamic improvements (aero 1) .....	51	51
Passive plus Active aerodynamic improvements (aero 2) .....	230	230
Electric (or electro/hydraulic) power steering .....	151	151
Mass reduction (10% on a 6500 lb vehicle) .....	318	318
Driveline friction reduction .....	139	139
Stop-start (no regenerative braking) .....	539	539
Mild HEV .....	2730	2730

TABLE VI-4—TECHNOLOGY COSTS FOR HD PICKUPS & VANS INCLUSIVE OF INDIRECT COST MARKUPS FOR MY 2021—  
Continued  
[2012\$]

Technology	Gasoline	Diesel
Strong HEV, without inclusion of any engine changes .....	6779	6779

**Note:**

<sup>a</sup>Cost to downsize from a V8 OHC to a V6 OHC engine with twin turbos.

As explained above, the CAFE model works by adding technologies in an incremental fashion to each particular vehicle in a manufacturer’s fleet until that fleet complies with the imposed standards. It does this by following a predefined set of decision trees whereby the particular vehicle is placed on the appropriate decision tree and it follows the predefined progression of

technology available on that tree. At each step along the tree, a decision is made regarding the cost of a given technology relative to what already exists on the vehicle along with the fuel consumption improvement it provides relative to the fuel consumption at the current location on the tree, prior to deciding whether to take that next step on the tree or remain in the current

location. Because the model works in this way, the input files must be structured to provide costs and effectiveness values for each technology relative to whatever technologies have been added in earlier steps along the tree. Table VI-5 presents the cost and effectiveness values used in the CAFE model input files.

TABLE VI-5—CAFE MODEL INPUT VALUES FOR COST & EFFECTIVENESS FOR GIVEN TECHNOLOGIES <sup>a</sup>

Technology	FC savings (%)	Incremental cost (2012\$) <sup>a b c</sup>		
		2021	2025	2027
Improved Lubricants and Engine Friction Reduction .....	1.60	24	24	23
Coupled Cam Phasing (SOHC) .....	3.82	48	43	39
Dual Variable Valve Lift (SOHC) .....	2.47	42	37	34
Cylinder Deactivation (SOHC) .....	3.70	34	30	27
Intake Cam Phasing (DOHC) .....	0.00	48	43	39
Dual Cam Phasing (DOHC) .....	3.82	46	40	37
Dual Variable Valve Lift (DOHC) .....	2.47	42	37	34
Cylinder Deactivation (DOHC) .....	3.70	34	30	27
Stoichiometric Gasoline Direct Injection (OHC) .....	0.50	71	61	56
Cylinder Deactivation (OHV) .....	3.90	216	188	172
Variable Valve Actuation (OHV) .....	6.10	54	47	43
Stoichiometric Gasoline Direct Injection (OHV) .....	0.50	71	61	56
Engine Turbocharging and Downsizing				
Small Gasoline Engines .....	8.00	518	441	407
Medium Gasoline Engines .....	8.00	-12	-62	-44
Large Gasoline Engines .....	8.00	623	522	456
Cooled Exhaust Gas Recirculation .....	3.04	382	332	303
Cylinder Deactivation on Turbo/downsized Eng .....	1.70	33	29	26
Lean-Burn Gasoline Direct Injection .....	4.30	1,758	1,485	1,282
Improved Diesel Engine Turbocharging .....	2.51	22	19	18
Engine Friction & Parasitic Reduction				
Small Diesel Engines .....	3.50	269	253	213
Medium Diesel Engines .....	3.50	345	325	273
Large Diesel Engines .....	3.50	421	397	334
Downsizing of Diesel Engines (V6 to I-4) .....	11.10	0	0	0
8-Speed Automatic Transmission <sup>d</sup> .....	5.00	482	419	382
Electric Power Steering .....	1.00	160	144	130
Improved Accessories (Level 1) .....	0.93	93	83	75
Improved Accessories (Level 2) .....	0.93	57	54	46
Stop-Start System .....	1.10	612	517	446
Integrated Starter-Generator .....	3.20	1,040	969	760
Strong Hybrid Electric Vehicle .....	17.20	3,038	2,393	2,133
Mass Reduction (5%) .....	1.50	0.28	0.24	0.21
Mass Reduction (additional 5%) .....	1.50	0.87	0.75	0.66
Reduced Rolling Resistance Tires .....	1.10	10	9	9
Low-Drag Brakes .....	0.40	106	102	102
Driveline Friction Reduction .....	0.50	153	137	124
Aerodynamic Improvements (10%) .....	0.70	58	52	47
Aerodynamic Improvements (add'l 10%) .....	0.70	193	182	153

**Notes:**

<sup>a</sup> Values for other model years available in CAFE model input files available at NHTSA Web site.

<sup>b</sup> For mass reduction, cost reported on mass basis (per pound of curb weight reduction).

<sup>c</sup> The model output has been adjusted to 2013\$.

<sup>d</sup> 8-speed automatic transmission costs include costs for high efficiency gearbox and aggressive shift logic whereas those costs were kept separate in prior analyses.

In addition to the base technology cost and effectiveness inputs described above, the CAFE model accommodates inputs to adjust accumulated effectiveness under circumstances when combining multiple technologies could result in underestimation or overestimation of total incremental effectiveness relative to an “unevolved”

baseline vehicle. These so-called synergy factors may be positive, where the combination of the technologies results in greater improvement than the additive improvement of each technology, or negative, where the combination of the technologies is lower than the additive improvement of each technology. The synergy factors used in

the NPRM and Method B of the FRM are described in Table VI–6 Method A of the FRM uses synergies derived from a simulation project NHTSA undertook with Autonomie Argonne National Lab. A description of these changes is given in Section D.(8).

TABLE VI–6—TECHNOLOGY PAIR EFFECTIVENESS SYNERGY FACTORS FOR HD PICKUPS AND VANS

Technology pair	Adjustment (%)	Technology pair	Adjustment (%)
8SPD/CCPS	–4.60	IATC/CCPS	–1.30
8SPD/DEACO	–4.60	IATC/DEACO	–1.30
8SPD/ICP	–4.60	IATC/ICP	–1.30
8SPD/TRBDS1	4.60	IATC/TRBDS1	1.30
AERO2/SHEV1	1.40	MR1/CCPS	0.40
CCPS/IACC1	–0.40	MR1/DCP	0.40
CCPS/IACC2	–0.60	MR1/VVA	0.40
DCP/IACC1	–0.40	MR2/ROLL1	–0.10
DCP/IACC2	–0.60	MR2/SHEV1	–0.40
DEACD/IATC	–0.10	NAUTO/CCPS	–1.70
DEACO/IACC2	–0.80	NAUTO/DEACO	–1.70
DEACO/MHEV	–0.70	NAUTO/ICP	–1.70
DEACS/IATC	–0.10	NAUTO/SAX	–0.40
DTURB/IATC	1.00	NAUTO/TRBDS1	1.70
DTURB/MHEV	–0.60	ROLL1/AERO1	0.10
DTURB/SHEV1	–1.00	ROLL1/SHEV1	1.10
DVVDL/8SPD	–0.60	ROLL2/AERO2	0.20
DVVDL/IACC2	–0.80	SHFTOPT/MHEV	–0.30
DVVDL/IATC	–0.60	TRBDS1/MHEV	0.80
DVVDL/MHEV	–0.70	TRBDS1/SHEV1	–3.30
DVVL/8SPD	–0.60	TRBDS1/VVA	–8.00
DVVL/IACC2	–0.80	TRBDS2/EPS	–0.30
DVVL/IATC	–0.50	TRBDS2/IACC2	–0.30
DVVL/MHEV	–0.70	TRBDS2/NAUTO	–0.50
		VVA/IACC1	–0.40
		VVA/IACC2	–0.60
		VVA/IATC	–0.60

The CAFE model also accommodates inputs to adjust accumulated incremental costs under circumstances when the application sequence could result in underestimation or overestimation of total incremental costs relative to an “unevolved” baseline vehicle. For today’s analysis, the agencies have applied one such adjustment, increasing the cost of medium-sized gasoline engines by \$513 in cases where turbocharging and engine downsizing is applied with variable valve actuation.

The analysis performed using Method A also applied cost inputs to address some costs encompassed neither by the agencies’ estimates of the direct cost to apply these technologies, nor by the agencies’ methods for “marking up” these costs to arrive at increases in the new vehicle purchase costs. To account for the additional costs that could be incurred if a technology is applied and then quickly replaced, the CAFE model accommodates inputs specifying a “stranded capital cost” specific to each

technology. For this analysis, the model was run with inputs to apply about \$78 of additional cost (per engine) if gasoline engine turbocharging and downsizing (separately for each “level” considered) is applied and then immediately replaced, declining steadily to zero by the tenth model year following initial application of the technology. The model also accommodates inputs specifying any additional changes owners might incur in maintenance and post-warranty repair costs. For this analysis, the model was run with inputs indicating that vehicles equipped with less rolling-resistant tires could incur additional tire replacement costs equivalent to \$21–\$23 (depending on model year) in additional costs to purchase the new vehicle. The agencies did not, however, include inputs specifying any potential changes repair costs that might accompany application of any of the above technologies. A sensitivity analysis using Method A, discussed below, includes a case in which repair costs are

estimated using factors consistent with those underlying the indirect cost multipliers used to markup direct costs for the agencies’ central analysis.

(6) Regulatory Alternatives Considered by the Agencies

As discussed above, the model considers regulatory alternatives. The results of regulatory alternatives are considered relative to a “no action” alternative where existing standards persist, but no further regulatory action is taken (in this case the MY 2018 standards from Phase I are the last regulatory action taken). The agencies also considered four regulatory alternatives. The preferred alternative with a standard that increases 2.5 percent in stringency annually for MY’s 2021–2027, and three others with annual increases in stringency of: 2.0 percent, 3.5 percent, and 4.0 percent for MY’s 2021–2025. For each of the “action alternatives” (i.e., those involving stringency increases beyond the no-action alternative), the annual

stringency increases are applied as follows: An annual stringency increase of  $r$  is applied by multiplying the model year 2020 target functions (identical to those applicable to model year 2018) by

$1 - r$  to define the model year 2021 target functions, multiplying the model year 2021 target functions by  $1 - r$  to define the model year 2022 target functions, continuing through 2025 for

all alternatives except for the preferred Alternative 3 which extends through 2027. In summary, the agencies have considered the following five regulatory alternatives in the CAFE model.

TABLE VI-7—CONSIDERED REGULATORY ALTERNATIVES

Regulatory alternative	Annual stringency increase		
	2019–2020	2021–2025	2026–2027
1: No Action .....	None .....	None .....	None.
2: 2.0%/y .....	None .....	2.0% .....	None.
3: 2.5%/y .....	None .....	2.5% .....	2.5%.
4: 3.5%/y .....	None .....	3.5% .....	None.
5: 4.0%/y .....	None .....	4.0% .....	None.

(7) NPRM Modifications of the Model

The NPRM analysis (and the current analysis) reflect several changes made to the model since 2012, when NHTSA used the model to estimate the effects, costs, and benefits of final CAFE standards for light-duty vehicles produced during MYs 2017–2021, and augural standards for MYs 2022–2025. Some of these changes specifically enable analysis of potential fuel consumption standards (and, hence, CO<sub>2</sub> emissions standards harmonized with fuel consumption standards) for heavy-duty pickups and vans; other changes implement more general improvements to the model. Key changes include the following:

- Changes to accommodate standards for heavy-duty pickups and vans, including attribute-based standards involving targets that vary with “work factor.”
- Explicit calculation of test weight, taking into account test weight “bins” and differences in the definition of test weight for light-duty vehicles (curb weight plus 300 pound) and heavy-duty pickups and vans (average of GVWR and curb weight).
- Procedures to estimate increases in payload when curb weight is reduced, increases in towing capacity if GVWR is reduced, and calculation procedures to correspondingly update calculated work factors.
- Expansion of model inputs, procedures, and outputs to accommodate technologies not included in prior analyses.
- Changes to the algorithm used to apply technologies, enabling more explicit accounting for shared vehicle platforms and adoption and “inheritance” of major engine changes.

These changes are reflected in updated model documentation available at NHTSA’s Web site, the documentation also providing more information about the model’s purpose,

scope, structure, design, inputs, operation, and outputs. The agencies invited but did not receive comments on the CAFE model used for the NPRM analysis and used in this final rule for the Method B analysis.

(a) Product Cadence

Past comments on the CAFE model have stressed the importance of product cadence—*i.e.*, the development and periodic redesign and freshening of vehicles—in terms of involving technical, financial, and other practical constraints on applying new technologies, and NHTSA has steadily made changes to the model with a view toward accounting for these considerations. For example, early versions of the model added explicit “carrying forward” of applied technologies between model years, subsequent versions applied assumptions that most technologies would be applied when vehicles are freshened or redesigned, and more recent versions applied assumptions that manufacturers would sometimes apply technology earlier than “necessary” in order to facilitate compliance with standards in ensuing model years. Thus, for example, if a manufacturer is expected to redesign many of its products in model years 2018 and 2023, and the standard’s stringency increases significantly in model year 2021, the CAFE model will estimate the potential that the manufacturer will add more technology than necessary for compliance in MY 2018, in order to carry those product changes forward through the next redesign and contribute to compliance with the MY 2021 standard.

The model also accommodates estimates of overall limits (expressed as “phase-in caps” in model inputs) on the rates at which manufacturers’ may practicably add technology to their respective fleets. So, for example, even if a manufacturer is expected to redesign

half of its production in MY 2016, if the manufacturer is not already producing any strong hybrid electric vehicles (SHEVs), a phase-in cap can be specified in order to assume that manufacturer will stop applying SHEVs in MY 2016 once it has done so to at least 3 percent of its production in that model year.

After the light-duty rulemaking analysis accompanying the 2012 final rule regarding post-2016 CAFE standards and related GHG emissions standards, NHTSA staff began work on CAFE model changes expected to better reflect additional considerations involved with product planning and cadence. These changes, summarized below, interact with preexisting model characteristics discussed above.

(b) Platforms and Technology

The term “platform” is used loosely in industry, but generally refers to a common structure shared by a group of vehicle variants. The degree of commonality varies, with some platform variants exhibiting traditional “badge engineering” where two products are differentiated by little more than insignias, while other platforms be used to produce a broad suite of vehicles that bear little outer resemblance to one another.

Given the degree of commonality between variants of a single platform, manufacturers do not have complete freedom to apply technology to a vehicle: while some technologies (*e.g.* low rolling resistance tires) are very nearly “bolt-on” technologies, others involve substantial changes to the structure and design of the vehicle, and therefore necessarily are constant between vehicles that share a common platform. NHTSA staff has, therefore, modified the CAFE model such that all mass reduction and aero technologies are forced to be constant between variants of a platform. The agencies requested but did not receive comment on the suitability of this viewpoint, and

which technologies can deviate from one platform variant to another.

Within the analysis fleet, each vehicle is associated with a specific platform. As the CAFE model applies technology, it first defines a platform “leader” as the vehicle variant of a platform with the highest technology utilization vehicle of mass reduction and aerodynamic technologies. As the vehicle applies technologies, it effectively harmonizes to the highest common denominator of the platform. If there is a tie, the CAFE model begins applying aerodynamic and mass reduction technology to the vehicle with the lowest average sales across all available model years. If there remains a tie, the model begins by choosing the vehicle with the highest average MSRP across all available model years. The model follows this formulation due to previous market trends suggesting that many technologies begin deployment at the high-end, low-volume end of the market as manufacturers build their confidence and capability in a technology, and later expand the technology across more mainstream product lines.

In the HD pickup and van market, there is a relatively small amount of diversity in platforms produced by manufacturers: Typically 1–2 truck platforms and 1–2 van platforms. However, accounting for platforms will take on greater significance in future analyses involving the light-duty fleet. The agency requested but did not receive comments on the general use of platforms within CAFE rulemaking.

#### (c) Engine and Transmission Inheritance

In practice, manufacturers are limited in the number of engines and transmissions that they produce. Typically a manufacturer produces a number of engines—perhaps six or eight engines for a large manufacturer—and tunes them for slight variants in output for a variety of car and truck applications. Manufacturers limit complexity in their engine portfolio for much the same reason as they limit complexity in vehicle variants: They face engineering manpower limitations, and supplier, production and service costs that scale with the number of parts produced.

In previous usage of the CAFE model, engines and transmissions in individual models were allowed relative freedom in technology application, potentially leading to solutions that would, if followed, involve unaccounted-for costs associated with increased complexity in the product portfolio. The lack of a constraint in this area allowed the model to apply different levels of technology to the engine in each vehicle

at the time of redesign or refresh, independent of what was done to other vehicles using a previously identical engine.

In the current version of the CAFE model, engines and transmissions that are shared between vehicles must apply the same levels of technology in all technologies dictated by engine or transmission inheritance. This forced adoption is referred to as “engine inheritance” in the model documentation.

As with platform-shared technologies, the model first chooses an “engine leader” among vehicles sharing the same engine. The leader is selected first by the vehicle with the lowest average sales across all available model years. If there is a tie, the vehicle with the highest average MSRP across model years is chosen. The model applies the same logic with respect to the application of transmission changes. As with platforms, this is driven by the concept that vehicle manufacturers typically deploy new technologies in small numbers prior to deploying widely across their product lines.

#### (d) Interactions Between Regulatory Classes

Like earlier versions, the current CAFE model provides for integrated analysis spanning different regulatory classes, accounting both for standards that apply separately to different classes and for interactions between regulatory classes. Light vehicle CAFE standards are specified separately for passenger cars and light trucks. However, there is considerable sharing between these two regulatory classes. Some specific engines and transmissions are used in both passenger cars and light trucks, and some vehicle platforms span these regulatory classes. For example, some sport-utility vehicles are offered in 2WD versions classified as passenger cars and 4WD versions classified as light trucks. Integrated analysis of manufacturers’ passenger car and light truck fleets provides the ability to account for such sharing and reduce the likelihood of finding solutions that could involve impractical levels of complexity in manufacturers’ product lines. In addition, integrated analysis provides the ability to simulate the potential that manufacturers could earn CAFE credits by over complying with one standard and use those credits toward compliance with the other standard (*i.e.*, to simulate credit transfers between regulatory classes).

HD pickups and vans are regulated separately from light-duty vehicles. While manufacturers cannot transfer credits between light-duty and MDHD

classes, there is some sharing of engineering and technology between light-duty vehicles and HD pickups and vans. For example, some passenger vans with GVWR over 8,500 lbs. are classified as medium-duty passenger vehicles (MDPVs) and thus included in manufacturers’ light-duty truck fleets, while cargo vans sharing the same nameplate are classified as HD vans.

#### (e) Phase-In Caps

The CAFE model retains the ability to use phase-in caps (specified in model inputs) as proxies for a variety of practical restrictions on technology application. Unlike vehicle-specific restrictions related to redesign, refreshes or platforms/engines, phase-in caps constrain technology application at the vehicle manufacturer level. They are intended to reflect a manufacturer’s overall resource capacity available for implementing new technologies (such as engineering and development personnel and financial resources), thereby ensuring that resource capacity is accounted for in the modeling process.

In previous CAFE rulemakings, redesign/refresh schedules and phase-in caps were the primary mechanisms to reflect an OEM’s limited pool of available resources during the rulemaking time frame and the years leading up to the rulemaking time frame, especially in years where many models may be scheduled for refresh or redesign. The newly-introduced representation platform-, engine-, and transmission-related considerations discussed above augment the model’s preexisting representation of redesign cycles and accommodation of phase-in caps. Considering these new constraints, inputs for today’s analysis de-emphasize reliance on phase-in caps.

In the NPRM and Method B of the FRM application of the CAFE model, phase-in caps are used only for the most advanced technologies included in the analysis, *i.e.*, SHEVs and lean-burn GDI engines, considering that these technologies are most likely to involve implementation costs and risks not otherwise accounted for in corresponding input estimates of technology cost. For these two technologies, the agencies have applied caps that begin at 3 percent (*i.e.*, 3 percent of the manufacturer’s production) in MY 2017, increase at 3 percent annually during the ensuing nine years (reaching 30 percent in the MY 2026), and subsequently increasing at 5 percent annually for four years (reaching 50 percent in MY 2030). Note that the agencies did not feel that lean-burn engines were feasible in the

timeframe of this rulemaking, so decided to reject any model runs where they were selected. (In any case, due to the cost ineffectiveness of this technology, it was never chosen). The agencies did not receive comments specifically on this approach for phase-in caps. The agencies received comments regarding the general feasibility of SHEVs in this market segment, with some commenters commenting that SHEVs are not feasible for HD pickups and vans. These comments are discussed in Section C.8. While the agencies have retained the above approach for SHEV phase-in caps, the agencies have conducted a sensitivity analysis setting the SHEV caps at zero, showing that the Phase 2 standards are feasible and appropriate without the use of SHEVs. This sensitivity analysis is described in Section E.

For Method A of the NPRM the phase-in caps have been set to 100 percent, so that the model no longer relies on phase-in caps to limit the early-year application of advanced technologies. This change is further described in the Method B of the FRM specific section below.

#### (f) Impact of Vehicle Technology Application Requirements

Compared to prior analyses of light-duty standards, these model changes, along with characteristics of the HD

pickup and van fleet result in some changes in the broad characteristics of the model's application of technology to manufacturers' fleets. First, since the number of HD pickup and van platforms in a portfolio is typically small, compliance with standards may appear especially "lumpy" (compared to previous applications of the CAFE model to the more highly segmented light-duty fleet), with significant over compliance when widespread redesigns precede stringency increases, and/or significant application of carried-forward (aka "banked") credits.

Second, since the use of phase-in caps has been de-emphasized and manufacturer technology deployment remains tied strongly to estimated product redesign and freshening schedules, technology penetration rates may jump more quickly as manufacturers apply technology to high-volume products in their portfolio.

By design, restrictions that enforce commonality of mass reduction and aerodynamic technologies on variants of a platform, and those that enforce engine inheritance, will result in fewer vehicle-technology combinations in a manufacturer's future modeled fleet. These restrictions are expected to more accurately capture the true costs associated with producing and maintaining a product portfolio.

(g) Accounting for Test Weight, Payload, and Towing Capacity

As mentioned above, NHTSA has also revised the CAFE model to explicitly account for the regulatory "binning" of test weights used to certify light-duty fuel economy and HD pickup and van fuel consumption for purposes of evaluating fleet-level compliance with fuel economy and fuel consumption standards. For HD pickups and vans, test weight (TW) is based on adjusted loaded vehicle weight (ALVW), which is defined as the average of gross vehicle weight rating (GVWR) and curb weight (CW). TW values are then rounded, resulting in TW "bins":

ALVW ≤ 4,000 lb.: TW rounded to nearest 125 lb.

4000 lb. < ALVW ≤ 5,500 lb.: TW rounded to nearest 250 lb.

ALVW > 5,500 lb.: TW rounded to nearest 500 lb.

This "binning" of TW is relevant to calculation of fuel consumption reductions accompanying mass reduction. Model inputs for mass reduction (as an applied technology) are expressed in terms of a percentage reduction of curb weight and an accompanying estimate of the percentage reduction in fuel consumption, setting aside rounding of test weight. Therefore, to account for rounding of test weight, NHTSA has modified these calculations as follows:

$$\Delta FC_{rounded\_TW} = \Delta TW \times \frac{\Delta FC_{unrounded\_TW}}{\Delta CW}$$

Where:

$\Delta CW$  = % change in curb weight (from model input),

$\Delta FC_{unrounded\_TW}$  = % change in fuel consumption (from model input), without TW rounding,

$\Delta TW$  = % change in test weight (calculated), and

$\Delta FC_{rounded\_TW}$  = % change in fuel consumption (calculated), with TW rounding.

As a result, some applications of vehicle mass reduction will produce no compliance benefit at all, in cases where the changes in ALVW are too small to change test weight when rounding is taken into account. On the other hand, some other applications of vehicle mass reduction will produce significantly more compliance benefit than when rounding is not taken into account, in cases where even small changes in ALVW are sufficient to cause vehicles' test weights to increase by, e.g., 500 lbs.

when rounding is accounted for. Model outputs now include initial and final TW, GVWR, and GCWR (and, as before, CW) for each vehicle model in each model year. The agencies invited but did not receive comment on how TW is modeled.

In addition, considering that the regulatory alternatives in the agencies' analysis all involve attribute-based standards in which underlying fuel consumption targets vary with "work factor" (defined by the agencies as the sum of three quarters of payload, one quarter of towing capacity, and 500 lb. for vehicles with 4WD), NHTSA has modified the CAFE model to apply inputs defining shares of curb weight reduction to be "returned" to payload and shares of GVWR reduction to be returned to towing capacity. The standards' dependence on work factor provides some incentive to increase

payload and towing capacity, both of which are buyer-facing measures of vehicle utility. In the agencies' judgment, this provides reason to assume that if vehicle mass is reduced, manufacturers are likely to "return" some of the change to payload and/or towing capacity. For this analysis, the agencies have applied the following assumptions:

- GVWR will be reduced by half the amount by which curb weight is reduced. In other words, 50 percent of the curb weight reduction will be returned to payload.
- GCWR will not be reduced. In other words, 100 percent of any GVWR reduction will be returned to towing capacity.
- GVWR/CW and GCWR/GVWR will not increase beyond levels observed among the majority of similar vehicles (or, for outlier vehicles, initial values):

TABLE VI-8 RATIOS FOR MODIFYING GVW AND GCW AS A FUNCTION OF MASS REDUCTION

Group	Maximum ratios assumed enabled by mass reduction	
	GVWR/CW	GCWR/GVWR
Unibody .....	1.75	1.50
Gasoline pickups > 13k GVWR .....	2.00	1.50
Other gasoline pickups .....	1.75	2.25
Diesel SRW pickups .....	1.75	2.50
All other .....	1.75	2.25

The first of two of these inputs are specified along with standards for each regulatory alternative, and the GVWR/CW and GCWR/GVWR “caps” are specified separately for each vehicle model in the analysis fleet.

In addition, NHTSA has changed the model to prevent HD pickup and van GVWR from falling below 8,500 lbs. when mass reduction is applied (because doing so will cause vehicles to be reclassified as light-duty vehicles), and to treat any additional mass for hybrid electric vehicles as *reducing* payload by the same amount (e.g., if adding a strong HEV package to a vehicle involves a 350 pound penalty, GVWR is assumed to remain unchanged, such that payload is also reduced by 350 lbs).

The agencies invited but did not receive comment on estimating how changes in vehicle mass may impact fuel consumption, GVWR, and GCWR.

(8) Subsequent Changes to the CAFE Model (for Method A)

Since issuing the NPRM, NHTSA has made further changes to the CAFE model, in order to estimate the potential impacts of simultaneous standards for both light-duty vehicles and HD pickups and vans. Among the updates most relevant to analysis supporting the final standards for HD pickups and vans, the current model: includes refinements to enable accounting for platforms, engines, and transmissions sharing between light-duty and HD pickups and vans; reflects refinements to how models for the first application of new technology are identified among shared platforms, engines, and transmissions; allows payback period, discount rate, survival rates, and mileage accumulation schedules to be specified separately for each vehicle class; makes use of large scale simulation modeling to more accurately account for synergies among technologies to estimate the fuel consumption impact of different combinations of technologies; provides the ability to selectively exclude fine payment from the “effective cost” calculation used to simulation manufacturers’ decisions regarding the

application of fuel-saving technologies; and expands the use of forward planning to estimate decisions to use credits that would otherwise expire. Changes to the CAFE model are discussed at greater length below and in the CAFE model documentation.

Also since issuing the NPRM, NHTSA has revised many model inputs to reflect information that has become available since the proposal. Among the updates most relevant to analysis supporting the final rule, these inputs reflect: an updated vehicle-level market forecast based on data regarding the 2015 model year fleet and a new commercially-available manufacturer- and segment-level market forecast, and spanning light-duty vehicles and HD pickups and vans; newer fuel prices and total vehicle production volumes from the Energy Information Administration’s Annual Energy Outlook 2015; a database, based on a large-scale full vehicle simulation study, of estimates of the effect of thousands of different combinations of technologies on fuel consumption; and updated mileage accumulation schedules based on a database of more than 70 million odometer readings.

NHTSA implemented these changes to the CAFE model and accompanying inputs to support both today’s final rule promulgating new fuel consumption standards for HD pickups and vans and the Draft Technical Assessment Report regarding agency’s consideration of CAFE standards for light duty vehicles for model years 2022–2025. This provided a basis to analyze the fleets simultaneously, accounting for interactions between the fleets; the draft RIA (p. 10–18) accompanying the NPRM identified this as a planned improvement for the final rule, and some stakeholders’ comments (e.g., CARB,<sup>492</sup> UCS,<sup>493</sup> and CBD<sup>494</sup>)

<sup>492</sup> CARB, Docket No. NHTSA–2014–0132–0125, at 17–18; 52–53.

<sup>493</sup> UCS, Docket No. EPA–HQ–OAR–2014–0827–1329, at pages 23–24.

<sup>494</sup> CBD, Docket No. NHTSA–2014–0132–0101 at pages 8–9.

indicated that such interactions should be accounted for.

The remainder of this section summarizes changes to the CAFE model and inputs made subsequent to the NPRM analysis, summarizes results of the updated analysis, and discusses.

(a) Interactions Between Regulatory Classes

Like earlier versions, the current CAFE model provides for integrated analysis spanning different regulatory classes, accounting both for standards that apply separately to different classes and for interactions between regulatory classes. Light vehicle CAFE standards are specified separately for passenger cars and light trucks. However, there is considerable sharing between these two regulatory classes. Some specific engines and transmissions are used in both passenger cars and light trucks, and some vehicle platforms span these regulatory classes. For example, some sport-utility vehicles are offered in 2WD versions classified as passenger cars and 4WD versions classified as light trucks. Integrated analysis of manufacturers’ passenger car and light truck fleets provides the ability to account for such sharing and reduce the likelihood of finding solutions that could involve impractical levels of complexity in manufacturers’ product lines. In addition, integrated analysis provides the ability to simulate the potential that manufactures could earn CAFE credits by over complying with one standard and use those credits toward compliance with the other standard (i.e., to simulate credit transfers between regulatory classes).

HD pickups and vans are regulated separately from light-duty vehicles. While manufacturers cannot transfer credits between light-duty and MDHD classes, there is some sharing of engineering and technology between light-duty vehicles and HD pickups and vans. For example, some passenger vans with GVWR over 8,500 pounds are classified as medium-duty passenger vehicles (MDPVs) and thus included in manufacturers’ light-duty truck fleets,

while cargo vans sharing the same nameplate are classified as HD vans.

The FRM Method A analysis uses an overall analysis fleet spanning both the light-duty and HD pickup and van fleets. As discussed below, doing so shows some technology “spilling over” to HD pickups and vans due, for example, to the application of technology in response to current light-duty standards. For most manufacturers, these interactions appear relatively small. For Nissan, however, they appear considerable, because Nissan’s heavy-duty vans use engines also used in Nissan’s light-duty SUVs. Unlike the Method A analysis, the Method B analysis is independent from the light-duty program.

In the NPRM proposing new standards for heavy-duty pickups and vans, NHTSA and EPA requested comment on the expansion of the analysis fleet such that the impacts of new HD pickup and van standards can be estimated within the context of an integrated analysis of light-duty vehicles and HD pickups and vans, accounting for interactions between the fleets. As mentioned above, some environmental organizations specifically cited commonalities and overlap between light- and heavy-duty products.

#### (b) Phase-In Caps

The model also accommodates estimates of overall limits (expressed as “phase-in caps” in model inputs) on the rates at which manufacturers’ may practicably add technology to their respective fleets. So, for example, even if a manufacturer is expected to redesign half of its production in MY 2016, if the manufacturer is not already producing any strong hybrid electric vehicles (SHEVs), a phase-in cap can be specified in order to assume that manufacturer will stop applying SHEVs in MY 2016 once it has done so to at least 3 percent of its production in that model year. Today’s analysis sets all of these caps at 100 percent, relying on other model constraints (in particular, the assumption that many technologies are

most practicably applied as part of a vehicle freshening or redesign) to estimate practicable technology application pathways.

The CAFE model retains the ability to use phase-in caps (specified in model inputs) as proxies for a variety of practical restrictions on technology application. Unlike vehicle-specific restrictions related to redesign, refreshes or platforms/engines, phase-in caps constrain technology application at the vehicle manufacturer level. Introduced in the 2006 version of the CAFE model, they were intended to reflect a manufacturer’s overall resource capacity available for implementing new technologies (such as engineering and development personnel and financial resources), thereby ensuring that resource capacity is accounted for in the modeling process.

In previous fuel efficiency rulemakings, redesign/refresh schedules and phase-in caps were the primary mechanisms to reflect an OEM’s limited pool of available resources during the rulemaking time frame and the years leading up to the rulemaking time frame, especially in years where many models may be scheduled for refresh or redesign. The newly-introduced representation platform-, engine-, and transmission-related considerations discussed above augment the model’s preexisting representation of redesign cycles, and as discussed above, inputs for today’s analysis de-emphasize reliance on phase-in caps.

#### (c) Accounting for Credits

The changes discussed above relate specifically to the model’s approach to simulating manufacturers’ potential addition of fuel-saving technology in response to fuel efficiency standards and fuel prices within an explicit product planning context. The model’s approach to simulating compliance decisions also accounts for the potential to earn and use fuel consumption credits, as provided by EPCA/EISA. Like past versions, the current CAFE model can be used to simulate credit carry-

forward (a.k.a. banking) between model years and transfers between the passenger car and light truck fleets, but not credit carry-back (a.k.a. borrowing) between model years or trading between manufacturers. Unlike past versions, the current CAFE model provides a basis to specify (in model inputs) fuel consumption credits available from model years earlier than those being simulated explicitly. For example, with today’s analysis representing model years 2015–2032 explicitly, credits specified as being available from model year 2014 are made available for use through model year 2019 (given the current 5-year limit on carry-forward of credits).

As discussed in the CAFE model documentation, the model’s default logic attempts to maximize credit carry-forward—that is to “hold on” to credits for as long as possible.<sup>495</sup> Although the model uses credits before expiry if needed to cover shortfalls when insufficient opportunity to add technology is available to achieve compliance with a standard, the model will otherwise carry forward credits until they are about to expire, at which point it will use them before adding technology. As further discussed in the CAFE model documentation, model inputs can be used to adjust this logic to shift the use of credits ahead by one or more model years.

The example presented below illustrates how some of aspects of the current model logic around credits impacts estimation of technology application by a manufacturer within the context of a specified set of standards, focusing here on the model’s estimate of Ford’s potential technology application under the preferred alternative. Overall results for Ford and other manufacturers are summarized in Section VI.D.

<sup>495</sup> Volpe CAFE Model Documentation, July 2016, pg 64. Available at <http://www.nhtsa.gov/Laws%20&%20Regulations/CAFE%20-%20Fuel%20Economy/cape-volpe-model>.



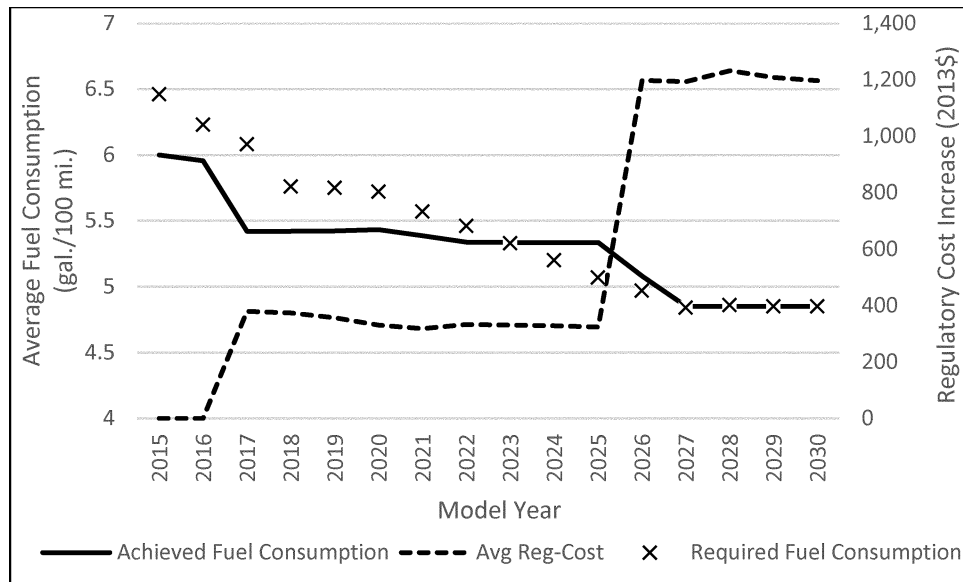

Figure VI-5 Example of a Possible Compliance Strategy for Ford

Several aspects of the estimated achieved and required fuel consumption levels shown above are notable. First, the characteristics of Ford's fleet as represented in today's analysis fleet are such that the heavy duty pickup and van fleet falls short of average fuel efficiency standard in MY's 2023 through 2027. However, they exceed their standard for MY's 2016 through 2022. The current analysis uses logic that reflect the potential that Ford could use the 5-year carry forward provision to use fuel efficiency credits earned in MY's 2018 through MY 2022, to cover the shortfalls for MY's 2023 to 2027. The model assumes Ford will use as many of the MY 2018 expiring credits as necessary to cover the shortfall in MY 2023. For MY 2024 they will use all available MY 2019 credits before applying any additional MY 2020 credits necessary to cover the shortfall (in this particular case there are enough MY 2019 credits to cover the shortfall in MY 2024). This pattern continues for all model years where there is a shortfall—the model applies the oldest remaining credits first. Even so, today's analysis indicates Ford could be required to pay civil penalties for noncompliance without the addition of modest fuel savings in MY 2027. The change to the model which accounts for credits earned prior to MY 2015 is not illustrated in this example. However, Ford comes in with fuel consumption credits from MY's prior to MY 2015; if they had come in with an initial shortfall, they could have used these

banked credits to cover, at least a portion, of that shortfall.

As discussed above, these results provide an estimate, based on analysis inputs, of one way General Motors *could* add fuel-saving technologies to its products under the preferred alternative considered here, and are not a prediction of what General Motors *would* do under this alternative. In addition, it should be recognized that specific results vary among manufacturers and among regulatory alternatives (and under different analytical inputs). Still, the example should serve to illustrate how the ability to model credit banking can impact results.

#### (d) Integrating Vehicle Simulation Results Into the Synergy Values

The CAFE model does not itself evaluate which technologies will be available, nor does it evaluate how effective or reliable they will be. The technological availability and effectiveness rather, are predefined inputs to the model based on the agencies' judgements and not outputs from the model, which is simply a tool for calculating the effects of combining input assumptions.

In previous versions of the CAFE Model, technology effectiveness values entered into the model as a single number for each technology (for each of several classes), intended to represent the incremental improvement in fuel consumption achieved by applying that technology to a vehicle in a particular class. At a basic level, this implied that

successive application of new vehicle technologies resulted in an improvement in fuel consumption (as a percentage) that was the product of the individual incremental effectiveness of each technology applied. Since this construction fails to capture interactive effects—cases where a given technology either improves or degrades the impact of subsequently applied technologies—the CAFE Model applied “synergy factors.” The synergy factors were defined for a relatively small number of technology pairs, and were intended to represent the result of physical interactions among pairs of technologies—attempting to account for situations where  $2 \times 2 \neq 4$ .

For a more specific example, for a vehicle with an initial fuel consumption of  $FC_0$ , if two technologies are applied, one with an incremental effectiveness of 5 percent, and a second with an incremental effectiveness of 10 percent, the effectiveness after the application of both technologies without consideration of synergies could be expressed as follows:

$$FC_0 * (1 - .05) * (1 - .1)$$

Which is equivalent to:

$$FC_0 * (1 - .145)$$

This suggests that the combined effectiveness of the two technologies is 14.5 percent. The synergy factors aim to correct for cases where fuel consumption improvements are not perfectly multiplicative, and the combined fuel consumption in the example above is either greater than or less than 14.5 percent.

For this analysis, the CAFE Model has been modified to accommodate the results of the large-scale vehicle simulation study conducted by Argonne National Laboratory (described in more detail in the light-duty Draft TAR). While *Autonomie*, Argonne's vehicle simulation model, produces absolute fuel consumption values for each simulation record, the results have been modified in a way that preserves much of the existing structure of the CAFE Model's compliance logic, but still faithfully reproduces the totality of the simulation outcomes present in the database. Fundamentally, the implementation represents a translation of the absolute values in the simulation database into incremental improvements and a substantially expanded set of synergy factors.

Since the simulation efforts only included light-duty vehicles, the effectiveness values for heavy duty were not integrated into the heavy-duty fleet; for future rule-makings NHTSA hopes to extend the vehicle simulation efforts to include simulations that would be relevant for heavy-duty pickups and vans. While the effectiveness values for individual technologies remain the same, the synergies between two or more technologies incorporate information from *Autonomie* Argonne's light-duty pickup simulations. While these synergy values are not a perfect approximation of the interaction of technology applications particular to heavy-duty vehicles, it is consistent with what we did in the NPRM (where we also used synergy values from light-duty pickups).

Updating the synergy values to use Argonne's simulation efforts does two things: (1) It allows that these synergies may occur between more than two technologies, and (2) because the synergies are multiplicative, rather than additive, it allows for the consideration that the order of other technology applications matter in determining the incremental percentage improvement correction of the synergy value. Instead of having one additive incremental percentage synergy value for a pair of technologies, regardless of the order of technology application between these pair of technologies, the synergy values are dependent on the initial state and ending point of a vehicle within the database.

As stated, in the past, synergy values in the Volpe model were represented as pairs. However, the new values are 7-tuples and there is one for every point in the database. The synergy factors are based (entirely) on values in the Argonne database, producing one for each unique technology combination for

each technology class, and are calculated as

$$S_k = \frac{FC_k}{FC_0 \cdot \prod(1 - x_i)}$$

where  $S_k$  is the synergy factor for technology combination  $k$ ,  $FC_0$  is the fuel consumption of the reference vehicle (in the database),  $x_i$  is the fuel consumption improvement of each technology  $i$  represented in technology combination  $k$  (where some technologies are present in combination  $k$ , and some are precedent technologies that were applied, incrementally, before reaching the current state on one of the paths).

In order to incorporate the results of the Argonne database, while still preserving the basic structure of the CAFE model's technology module, it was necessary to translate the points in the database into locations on the technology tree.<sup>496</sup> By recognizing that most of the paths on the technology tree are unrelated, or separable, it is possible to decompose the technology tree into a small number of paths and branches by technology type. To achieve this level of linearity, we define technology groups—only one of which is new. They are: engine cam configuration (CONFIG), engine technologies (ENG), transmission technologies (TRANS), electrification (ELEC), mass reduction levels (MR), aerodynamic improvements (AERO), and rolling resistance (ROLL). The combination of technology levels along each of these paths define a unique technology combination that corresponds to a single point in the database for each technology class. These technology state definitions are more important for defining synergies than for determining incremental effectiveness, but the paths are incorporated into both. Again, because we did not simulate results applicable to the heavy-duty fleet, we did not use the database to define the incremental technology effectiveness, but only to adjust for the unique interaction of different combinations of technology.

As an example, a technology state vector describing a vehicle with a SOHC engine, variable valve timing (only), a 6-speed automatic transmission, a belt-integrated starter generator, mass reduction (level 1), aerodynamic improvements (level 2), and rolling resistance (level 1) would be specified as SOHC;VVT;AT6;BISG;MR1;AERO2;ROLL1. Once a vehicle is assigned a technology state (one of the tens of

thousands of unique 7-tuples, defined as CONFIG;ENG;TRANS;ELEC;MR;AERO;ROLL), adding a new technology to the vehicle simply represents progress from one technology state to another. The vehicle's fuel consumption is:

$$FC_i = FC_0 \cdot (1 - FCI_i) \cdot S_k / o$$

where  $FC_i$  is the fuel consumption resulting from the application of technology  $i$ ,  $FC_0$  is the vehicle's fuel consumption before technology  $i$  is applied,  $FCI_i$  is the incremental fuel consumption (percentage) improvement associated with technology  $i$ ,  $S_k$  is the synergy factor associated with the combination,  $k$ , of technologies the vehicle technology  $i$  is applied, and  $S_0$  the synergy factor associated with the technology state that produced fuel consumption  $FC_0$ . The synergy factor is defined in a way that captures the incremental improvement of moving between points in the database, where each point is defined uniquely as a 7-tuple describing its cam configuration, highest engine technology, transmission, electrification type, mass reduction level, and level of aerodynamic or rolling resistance improvement. For the current heavy-duty adoption, it is only these synergy values that were used in the current analysis. While, like with the individual fuel consumption improvements, there is likely not a simple mapping from light-duty pickups to heavy-duty pickups (size and power matter), the previous synergy values were also an adoption from light-duty pickups. The integration of the simulation data allows for a more complete set of synergies that account for the order of technology application and the interaction of more than two individual technologies.

#### (e) Updating Mileage Accumulation Schedules

In order to develop new mileage accumulation schedules for vehicles regulated under NHTSA's fuel efficiency and CAFE programs (classes 1–3), NHTSA purchased a data set of vehicle odometer readings from IHS/Polk (Polk). Polk collects odometer readings from registered vehicles when they encounter maintenance facilities, state inspection programs, or interactions with dealerships and OEMs. The (average) odometer readings in the data set NHTSA purchased are based on over 74 million unique odometer readings across 16 model years (2000–2015) and vehicle classes present in the data purchase (all registered vehicles less than 14,000 lbs. GVW).

The Polk data provide a measure of the cumulative lifetime vehicle miles

<sup>496</sup> The technology tree used to create the synergies for this rule are presented in the light-duty draft TAR.

traveled (VMT) for vehicles, at the time of measurement, aggregated by the following parameters: make, model, model year, fuel type, drive type, door count, and ownership type (commercial or personal). Within each of these subcategories they provide the average odometer reading, the number of odometer readings in the sample from which Polk calculated the averages, and the total number of that subcategory of vehicles in operation. From these NHTSA was able to develop new estimates of vehicle miles traveled by age as inputs for the CAFE Model.

#### (f) Impact of Vehicle Technology Application Requirements

Compared to prior analyses of light-duty standards, these model changes result in some changes in the broad characteristics of the model's application of technology to manufacturers' fleets. Since the use of phase-in caps has been de-emphasized

and manufacturer technology deployment remains tied strongly to estimated product redesign and freshening schedules, technology penetration rates may jump more quickly as manufacturers apply technology to high-volume products in their portfolio.

By design, restrictions that enforce commonality of mass reduction and aerodynamic technologies on variants of a platform, and those that enforce engine inheritance, will result in fewer vehicle-technology combinations in a manufacturer's future modeled fleet. As explained in the NPRM proposing new standards for HD pickups and vans, these restrictions are expected to more accurately capture the true costs associated with producing and maintaining a product portfolio.

#### (i) Updated Schedules

The new medium-duty van/pickup schedule in Figure VI-6 predicts higher

annual VMT for vehicles between ages one through five years, and lower annual VMT for all other vehicle ages, than the old schedule. Over the first 30-year span, the new schedule predicts that medium-duty vans/pickups drive 24,249 (9 percent) fewer miles than the old schedule. We predict the maximum average annual VMT for medium-duty vehicles (23,307 miles) at age two. These changes to the schedule will have important implications on certain benefits of the standards. More monetary fuel savings will occur during the first five years of a vehicle's life under the new schedule, but a decrease in fuel savings will occur overall while using these schedules. For payback periods shorter than 5 years, the new schedule will show shorter payback periods than the old schedule. Section 10 of the RIA offers similar figures for light-duty vehicles types. It also offers further explanation about the shape of the new annual VMT schedule.

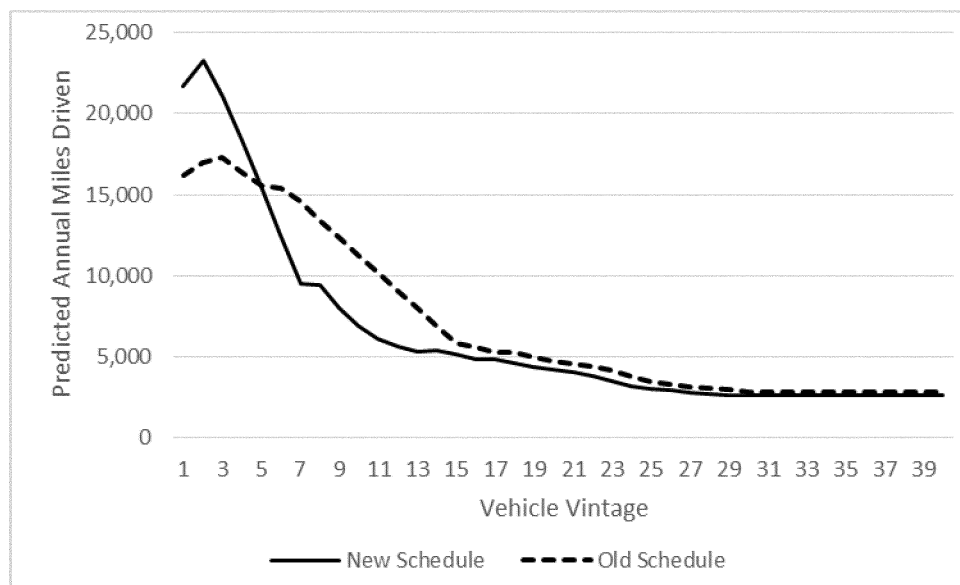

Figure VI-6 A Comparison of the New and Old Heavy-Duty Van/Pickup Schedules

Table VI-9 offers a summary of the comparison of lifetime VMT (by class) under the new schedule, compared with lifetime VMT under the old schedule. In addition to the total lifetime VMT expected under each schedule for vehicles that survive to their full useful

life, Table VI-9 also shows the survival-weighted lifetime VMT for both schedules. This represents the average lifetime VMT for all vehicles, not only those that survive to their full useful life. The percentage difference between the two schedules is not as stark for the

survival-weighted schedules: The percentage decrease of survival-weighted lifetime VMT under the new schedules range from 6.5 percent (for medium-duty trucks and vans) to 21.2 percent (for passenger vans).

TABLE VI-9—SUMMARY COMPARISON OF LIFETIME VMT OF THE NEW AND OLD SCHEDULES

	Lifetime VMT			Survival-Weighted		
	Lifetime VMT			Lifetime VMT		
	New	Old	% difference	New	Old	% difference
Car .....	204,233	301,115	32.2	142,119	179,399	20.8
Van .....	237,623	362,482	34.4	155,115	196,725	21.2
SUV .....	237,623	338,646	29.8	155,115	193,115	19.7
Pickup .....	265,849	360,982	26.4	157,991	188,634	16.2
2b/3 .....	246,413	270,662	9.0	176,807	189,020	6.5

## (ii) Data Description

While the Polk data set contains model-level average odometer readings, the CAFE model assigns lifetime VMT schedules at a lower resolution based on vehicle body style. For the purposes of VMT accounting, the CAFE model classifies every vehicle in the analysis fleet as being one of the following: passenger car, SUV, pickup truck, passenger van, or medium-duty pickup/van. In order to use the Polk data to develop VMT schedules for each of the (VMT) classes in the CAFE model, we constructed a mapping between the classification of each model in the Polk data and the classes in the CAFE model. The only difference between the mapping for the VMT schedules and the rest of the CAFE model is that we merged the SUV and van body styles into one class (for reasons described in our discussion of the SUV/van schedule in Section 10 of the RIA). This mapping allowed us to predict the lifetime miles traveled, by the age of a vehicle, for the categories in the CAFE model.

In estimating the VMT models, we weighted each data point (make/model classification) by the share of each make/model in the total population of the corresponding CAFE class. This weighting ensures that the predicted odometer readings, by class and model year, represent each of vehicle classification among observed vehicles (*i.e.*, the vehicles for which Polk has odometer readings), based on each vehicles' representation in the registered vehicle population of its class. Implicit in this weighting scheme, is the assumption that the samples used to calculate each average odometer reading by make, model, and model year are representative of the total population of vehicles of that type. Several indicators suggest that this is a reasonable assumption.

First, the majority of each vehicle make/model is well-represented in the sample. For more than 85 percent of make/model combinations, the average odometer readings are collected for 20 percent or more of the total population.

Most make/model observations have sufficient sample sizes, relative to their representation in the vehicle population, to produce meaningful average odometer totals at that level.

We also considered whether the representativeness of the odometer sample varies by vehicle age, since VMT schedules in the CAFE model are specific to each age. To investigate, we calculated the percentage of vehicle types (by make, model, and model year) that did not have odometer readings. All model years, apart from 2015, have odometer readings for 96 percent or more of the total types of vehicles observed in the fleet.

While the preceding discussion supports the *coverage* of the odometer sample across makes/models by each model year, it is possible that, for some of those models, an insufficient number of odometer readings is recorded to create an average that is likely to be representative of all of those models in operation for a given year. For all model years other than 2015, about 95 percent or more of vehicles types are represented by at least 5 percent of their population. For this reason, we included observations from all model years, other than 2015, in the estimation of the new VMT schedules.

It is possible that the odometer sample is biased. If certain vehicles are over-represented in the sample of odometer readings relative to the registered vehicle population, a simple average, or even one weighted by the number of odometer observations will be biased. However, while weighting by the share of each vehicle in the population will account for this bias, it would not correct for a sample that entirely omits a large number of makes/models within a model year. We tested for this by computing the proportion of the count of odometer readings for each individual vehicle type—within a class and model year—to the total count of readings for that class and model year. We also compared the population of each make/model—within each class and model year—to the population of the corresponding class and model year.

The difference of these two ratios shows the difference of the representation of a vehicle type—in its respective class and model year—in the sample versus the population. All vehicle types are represented in the sample within 10 percent of their representation in the population, and the variance between the two representations is normally distributed. This suggests that, on average, the likelihood that a vehicle is in the sample is comparable to its proportion in the relevant population, and that there is little under or over sampling of certain vehicle makes/models.<sup>497</sup>

## (iii) Estimation

Since model years are sold in in the fall of the previous calendar year, throughout the same calendar year, and even into the following calendar year—not all registered vehicles of a make/model/year will have been registered for at least a year (or more) until age 3. The result is that some MY 2014 vehicles may have been driven for longer than one year, and some less, at the time the odometer was observed. In order to consider this in our definition of age, we assign the age of a vehicle to be the difference between the average reading date of a make/model and the average first registration date of that make/model. The result is that the continuous age variable reflects the amount of time that a car has been registered at the time of odometer reading, and presumably the time span that the car has accumulated the miles.

After creating the “Age” variable, we fit the make/model lifetime VMT data points to a weighted quartic polynomial regression of the age of the vehicle (stratified by class). The predicted values of the quartic regressions are used to calculate the marginal annual VMT by age for each class by calculating differences in estimated lifetime mileage accumulation by age. However, the Polk data acquired by NHTSA only contains

<sup>497</sup> For figures that support the conclusions about the representativeness of the IHS/Polk data see Section 10 of the RIA.

observations for vehicles newer than 16 years of age. In order to estimate the schedule for vehicles older than the age 15 vehicles in the Polk data, we combined information about that portion of the schedule from the VMT schedules used in both the 2017–2021 Final Light Duty Rule and 2019–2025 Medium-Duty NPRM. The light-duty schedules were derived from the survey data contained in the 2009 National Household Travel Survey (NHTS) and the 2001 Vehicle in Use Survey (VIUS), for medium-duty trucks.

Based on the vehicle ages for which we have data (from the Polk purchase), the newly estimated annual schedules differ from the previous version in important ways. Perhaps most significantly, the annual mileage associated with ages beyond age 8 begin to, and continue to, trend much lower. The approach taken here attempts to preserve the results obtained through estimation on the Polk observations, while leveraging the existing (NHTS-based) schedules to support estimation of the higher ages (age 16 and beyond). Since the two schedules are so far apart, simply splicing them together would have created not only a discontinuity, but also precluded the possibility of a monotonically decreasing scale with age (which is consistent with previous schedules, the data acquired from Polk, and common sense).

From the old schedules, we expect that the annual VMT is decreasing for all ages. Towards the end of our sample, the predictions for annual VMT increase. In order to force the expected monotonicity, we perform a triangular smoothing algorithm until the schedule is monotonic. This performs a weighted average which weights the observations close to the observation more than those farther from it. The result is a monotonic function, which predicts similar lifetime VMT for the sample span as the original function. Since we do not have data beyond 15 years of age,

we are not able to correctly capture that part of the annual VMT curve using only the new dataset. For this reason, we use trends in the old data to extrapolate the new schedule for ages beyond the sample range.

In order to use the VMT information from the newer data source for ages outside of the sample, we use the final in-sample age (15 years) as a seed and then apply the proportional trend from the old schedules to extrapolate the new schedules out to age 30. To do this, we calculated the annual percentage difference in VMT of the old schedule for ages 15–30. The same annual percentage difference in VMT is applied to the new schedule to extend beyond the final in-sample value. This assumes that the overall proportional trend in the outer years is correctly modeled in the old VMT schedule, and imposes this same trend for the outer years of the new schedule. The extrapolated schedules are the final input for the VMT schedules in the CAFE model.

(iv) Comparison to Previous Schedules

The new VMT data suggests that the VMT schedule used in the last Light-Duty CAFE Final Rule likely does not represent current annual VMT rates. Across all classes, the previous VMT schedules overestimate the average annual VMT. The previous schedules are based on data that is outdated and self-reported, while the observations from Polk are between 5 and 7 years newer than those in the NHTS and represent valid odometer readings (rather than self-reported information).

Additionally, while the NHTS may be a representative sample of *households*, it is less likely to be a representative sample of *vehicles*. However, by properly accounting for vehicle population weights in the new averages and models, we corrected for this issue in the derivation of the new schedules.

Insofar as these changes better represent actual VMT, they lead to

better estimates of actual impacts, such as avoided fuel consumption and GHG emissions, safety impacts, and monetized benefits.

(v) Future Direction

In consultation with other agencies closely involved with VMT estimation (*e.g.*, FHWA), NHTSA will continue to seek means to further refine estimated mileage accumulation schedules. For example, one option under consideration would be to obtain odometer reading data from successive calendar years, thus providing a more robust basis to consider, for example, the influence of changing fuel prices or economic conditions on the accumulation of miles by vehicles of a given age.

(g) Updated Analysis Fleet

For the current analysis we updated the reference fleet from MY 2014, to the latest available MY 2015. The projection of total sales volumes for the Class 2b and 3 market segment was based on the total volumes in the 2015 AEO Reference Case. For the purposes of this analysis, the AEO2015 calendar year volumes have been used to represent the corresponding model-year volumes. While AEO2015 provides enough resolution in its projections to separate the volumes for the Class 2b and 3 segments, the agencies deferred to the vehicle manufacturers and chose to rely on the relative shares present in the pre-model-year compliance data.

The relative sales share by vehicle type (van or pickup truck, in this case) was derived from a sales forecast that the agencies purchased from IHS Automotive, and applied to the total volumes in the AEO2015 projection. Table VI–10 shows the implied shares of the total new 2b/3 vehicle market broken down by manufacturer and vehicle type.

TABLE VI–10—2015 IHS AUTOMOTIVE MARKET SHARE FORECAST FOR 2B/3 VEHICLES

Manufacturer	Style	Model year market share					
		2016	2017	2018	2019	2020	2021
Daimler .....	Van .....	2%	2%	2%	3%	3%	3%
Fiat Chrysler .....	Van .....	3	3	3	3	3	3
Ford .....	Van .....	16	16	16	17	18	19
General Motors .....	Van .....	7	7	7	7	8	8
Nissan .....	Van .....	1	1	1	1	2	2
Daimler .....	Pickup .....	0	0	0	0	0	0
Fiat Chrysler .....	Pickup .....	14	14	14	14	15	14
Ford .....	Pickup .....	29	30	31	31	28	28
General Motors .....	Pickup .....	28	27	26	25	24	24
Nissan .....	Pickup .....	0	0	0	0	0	0

Within those broadly defined market shares, volumes at the manufacturer/model-variant level were constructed by applying the model-variant's share of manufacturer sales in the pre-model-year compliance data for the relevant vehicle style, and multiplied by the total volume estimated for that manufacturer and that style.

(h) Changes to Costs

(i) Use of Retail Price Equivalent (RPE) Multiplier To Calculate Indirect Costs

To produce a unit of output, vehicle manufacturers incur direct and indirect costs. Direct costs include cost of materials and labor costs. Indirect costs are all the costs associated with producing the unit of output that are not direct costs—for example, they may be related to production (such as research and development [R&D]), corporate operations (such as salaries, pensions, and health care costs for corporate staff),

or selling (such as transportation, dealer support, and marketing). Indirect costs are generally recovered by allocating a share of the costs to each unit of good sold. Although it is possible to account for direct costs allocated to each unit of good sold, it is more challenging to account for indirect costs allocated to a unit of goods sold. To make a cost analysis process more feasible, markup factors, which relate total indirect costs to total direct costs, have been developed. These factors are often referred to as retail price equivalent (RPE) multipliers.

Cost analysts and regulatory agencies (including both NHTSA and EPA) have frequently used these multipliers to predict the resultant impact on costs associated with manufacturers' responses to regulatory requirements. The best approach, if it were possible, to determining the impact of changes in direct manufacturing costs on a

manufacturer's indirect costs would be to actually estimate the cost impact on each indirect cost element. However, doing this within the constraints of an agency's time or budget is not always feasible, and the technical, financial, and accounting information to carry out such an analysis may simply be unavailable.

The one empirically derived metric that addresses the markup of direct costs to consumer costs is the RPE multiplier, which is measured from manufacturer 10-K accounting statements filed with the Securities and Exchange Commission. Over roughly a three decade period, the measured RPE has been remarkably stable, averaging 1.5, with minor annual variation. The National Research Council notes that, "Based on available data, a reasonable RPE multiplier would be 1.5." The historical trend in the RPE is illustrated in Figure VI.13.

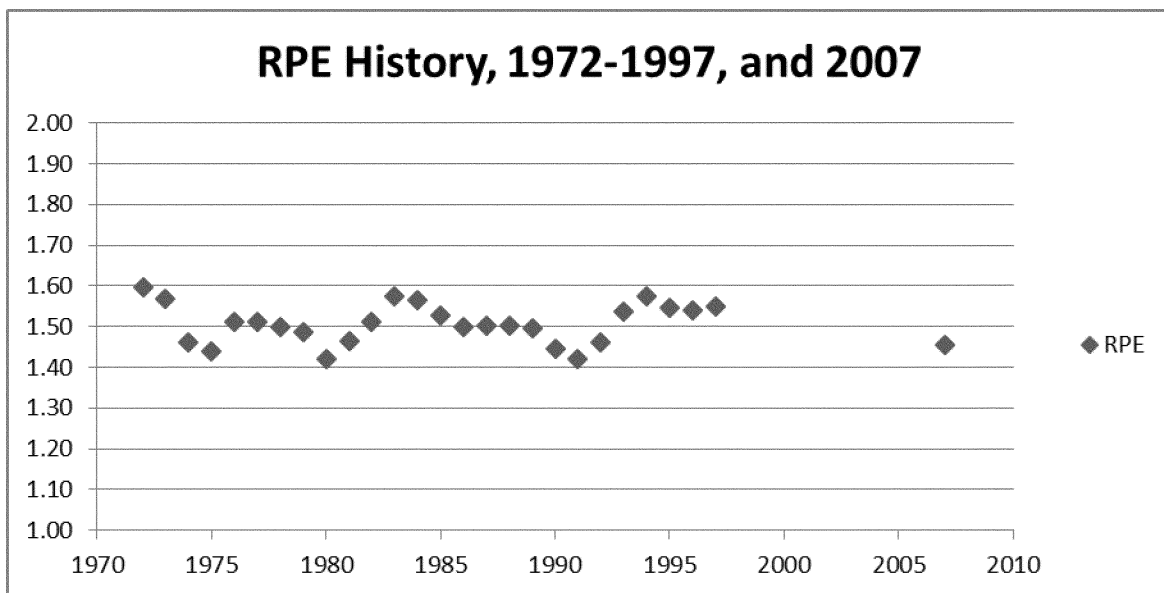

Figure VI-7 RPE History 1972-1997 and 2007

RPE multipliers provide, at an aggregate level, the relationship between revenue and direct manufacturing costs. They are measured by dividing total revenue by direct costs. However, because this provides only a single aggregate measure, using RPE multipliers results in the application of a common incremental markup to all technologies. It assures that the aggregate cost impact across all technologies is consistent with empirical data, but does not allow for indirect cost discrimination among different technologies. Thus, a concern

in using the RPE multiplier in cost analysis for new technologies added in response to regulatory requirements is that the indirect costs of vehicle modifications are not likely to be the same for all different technologies. For example, less complex technologies could require fewer R&D efforts or less warranty coverage than more complex technologies. In addition, some simple technological adjustments may, for example, have no effect on the number of corporate personnel and the indirect costs attributable to those personnel. The use of RPEs, with their assumption

that all technologies have the same proportion of indirect costs, is likely to overestimate the costs of less complex technologies and underestimate the costs of more complex technologies. However, for regulations such as the CAFE and GHG emission standards under consideration, which drive changes to nearly every vehicle system, overall average indirect costs should align with the RPE value. Applying RPE to the cost for each technology assures that alignment.

Modified multipliers have been developed by EPA, working with a

contractor, for use in rulemakings.<sup>498</sup> These multipliers are referred to as indirect cost multipliers (or ICMs). ICMs assign unique incremental changes to each indirect cost contributor at several different technology levels.

$$\text{ICM} = (\text{direct cost} + \text{adjusted indirect cost}) / (\text{direct cost})$$

Developing the ICMs from the RPE multipliers requires developing adjustment factors based on the complexity of the technology and the time frame under consideration: The less complex a technology, the lower its ICM, and the longer the time frame for applying the technology, the lower the ICM. This methodology was used in the cost estimation for the recent light-duty MYs 2012–2016 and MYs 2017–2025 rulemaking and for the heavy-duty MYs 2014–2018 rulemaking. The ICMs for the light-duty context were developed in a peer-reviewed report from RTI International and were subsequently discussed in a peer-reviewed journal article.<sup>499</sup> Importantly, since publication of that peer-reviewed journal article, the agencies have revised the methodology to include a return on capital (*i.e.*, profits) based on the assumption implicit in ICMs (and RPEs) that capital costs are proportional to direct costs, and businesses need to be able to earn returns on their investments.

Since their original development in February 2009, the agencies have made some changes to both the ICMs factors and to the method of applying those factors relative to the factors developed by RTI and presented in their reports. We have described and explained those changes in several rulemakings over the years, most notably the 2017–2025 FRM for light vehicles and the more recent Heavy-duty GHG Phase 2 NPRM.<sup>500</sup> In the 2015 NAS study, the committee stated a conceptual agreement with the ICM method since ICM takes into account design challenges and the activities required to implement each technology. However, although endorsing ICMs as a concept, the NAS Committee stated that “. . . the empirical basis for such multipliers is still lacking, and, since their application depends on expert judgment, it is not possible to determine whether the Agencies’ ICMs are accurate or not.” NAS also states that “. . . the specific

values for the ICMs are critical since they may affect the overall estimates of costs and benefits for the overall standards and the cost effectiveness of the individual technologies.” The committee did encourage continued research into ICMs given the lack of empirical data for them to evaluate the ICMs used by the agencies in past analyses. EPA, for its part, continues to study the issue surrounding ICMs but has not pursued further efforts given resource constraints and demands in areas such as technology benchmarking and cost teardowns.

On balance, NHTSA believes that the empirically derived RPE is a more reliable basis for estimating indirect costs. To ensure overall indirect costs in the analysis align with the RPE value, NHTSA has developed its primary analysis based on applying the RPE value of 1.5 to each technology. NHTSA also has conducted a sensitivity analysis examining the impact of applying the ICM approach in the sensitivity analysis portion later in this Section. This marks a change from the NPRM where we use the ICM multiplier to calculate indirect costs as the central analysis and the RPE multiplier as a sensitivity case.

(ii) Updates to Mass Reduction Based on 2014 Silverado Study

As proposed in the NPRM we have updated the HD pickup and van mass reduction cost curves with a MY 2014 GMC Silverado EDAG study. The updated mass reduction study suggests that mass reduction will be more costly for heavy-duty vans and pickups than was suggested in the NPRM. This can explain the reduction in mass reduction in the current analysis compared to the NPRM.

NHTSA awarded a contract to EDAG to conduct a vehicle weight reduction feasibility and cost study of a 2014MY full size pick-up truck. The light weighted version of the full size pick-up truck (LWT) used manufacturing processes that will likely be available during the model years 2025–2030 and be capable of high volume production. The goal was to determine the maximum feasible weight reduction while maintaining the same vehicle functionalities, such as towing, hauling, performance, noise, vibration, harshness, safety, and crash rating, as the baseline vehicle, as well as the functionality and capability of designs to meet the needs of sharing components across same or cross vehicle platform. Consideration was also given to the sharing of engines and other components with vehicles built on other platforms to achieve manufacturing economies of scale, and

in recognition of resource constraints which limit the ability to optimize every component for every vehicle.

A comprehensive teardown/benchmarking of the baseline vehicle was conducted for the engineering analysis. The analysis included geometric optimization of load bearing vehicle structures, advanced material utilization along with a manufacturing technology assessment that would be available in the 2017 to 2025 time frame. The baseline vehicle’s overall mass, center of gravity and all key dimensions were determined. Before the vehicle teardown, laboratory torsional stiffness tests, bending stiffness tests and normal modes of vibration tests were performed on baseline vehicles so that these results could be compared with the CAE model of the light weighted design. After conducting a full tear down and benchmarking of the baseline vehicle, a detailed CAE model of the baseline vehicle was created and correlated with the available crash test results. The project team then used computer modeling and optimization techniques to design the light-weighted pickup truck and optimized the vehicle structure considering redesign of structural geometry, material grade and material gauge to achieve the maximum amount of mass reduction while achieving comparable vehicle performance as the baseline vehicle. Only technologies and materials projected to be available for large scale production and available within two to three design generations (*e.g.* model years 2020, 2025 and 2030) were chosen for the LWT design. Three design concepts were evaluated: (1) A multi-material approach; (2) an aluminum intensive approach; and (3) a Carbon Fiber Reinforced Plastics approach. The multi-material approach was identified as the most cost effective. The recommended materials (advanced high strength steels, aluminum, magnesium and plastics), manufacturing processes, (stamping, hot stamping, die casting, extrusions, and roll forming) and assembly methods (spot welding, laser welding, riveting and adhesive bonding) are currently used, although some to a lesser degree than others. These technologies can be fully developed within the normal product design cycle using the current design and development methods.

The design of the LWT was verified, through CAE modeling, that it meets all relevant crash tests performance. The LS-DYNA finite element software used by the EDAG team is an industry standard for crash simulation and modeling. The researchers modeled the crashworthiness of the LWT design

<sup>498</sup> RTI International, “Automobile Industry Retail Price Equivalent and Indirect Cost Multipliers,” February 2009; EPA-420-R-09-003; <http://www3.epa.gov/otaq/ld-hwy/420r09003.pdf>.

<sup>499</sup> Rogozhin, A., et al., “Using indirect cost multipliers to estimate the total cost of adding new technology in the automobile industry,” International Journal of Production Economics (2009), doi:10.1016/j.ijpe.2009.11.031.

<sup>500</sup> 80 FR 40137.

using the NCAP Frontal, Lateral Moving Deformable Barrier, and Lateral Pole tests, along with the IIHS Roof, Lateral Moving Deformable Barrier, and Frontal Offset (40 percent and 25 percent) tests. All of the modeled tests were comparable to the actual crash tests performed on the 2014 Silverado in the NHTSA database. Furthermore, the FMVSS No. 301 rear impact test was modeled and it showed no damage to the fuel system.

The baseline 2014 MY Chevrolet Silverado's platform shares components across several platforms. Some of the chassis components and other structural components were designed to accommodate platform derivatives, similar to the components in the baseline vehicle which are shared across platforms such as GMT 920 (GM Tahoe, Cadillac Escalade, GMC Yukon), GMT 930 platform (Chevy Suburban, Cadillac Escalade ESV, GMC Yukon XL), and GMT 940 platform (Chevy Avalanche and Cadillac Escalade EXT) and GMT 900 platform (GMC Sierra). As per the National Academy of Science's guidelines, the study assumes engines would be downsized or redesigned for mass reduction levels at or greater than 10 percent. As a consequence of mass reduction, several of the components used designs that were developed for other vehicles in the weight category of light-weighted designed vehicles were used to maximize economies of scale and resource limitations. Examples

include brake systems, fuel tanks, fuel lines, exhaust systems, wheels, and other components.

Cost is a key consideration when vehicle manufacturers decide which fuel-saving technology to apply to a vehicle. Incremental cost analysis for all of the new technologies applied to reduce mass of the light-duty full-size pickup truck designed were calculated. The cost estimates include variable costs as well as non-variable costs, such as the manufacturer's investment cost for tooling. The cost estimates include all the costs directly related to manufacturing the components. For example, for a stamped sheet metal part, the cost models estimate the costs for each of the operations involved in the manufacturing process, starting from blanking the steel from coil through the final stamping operation to fabricate the component. The final estimated total manufacturing cost and assembly cost are a sum total of all the respective cost elements including the costs for material, tooling, equipment, direct labor, energy, building and maintenance.

The information from the LWT design study was used to develop a cost curve representing cost effective full vehicle solutions for a wide range of mass reduction levels. At lower levels of mass reduction, non-structural components and aluminum closures provide weight reduction which can be incorporated independently without the redesign of

other components and are stand-alone solutions for the LWV. The holistic vehicle design using a combination of AHSS and aluminum provides good levels of mass reduction at reasonably acceptable cost. The LWV solution achieves 17.6 percent mass reduction from the baseline curb mass. Further two more analytical mass reduction solutions (all aluminum and all carbon fiber reinforced plastics (CFRP)) were developed to show additional mass reduction that could be potentially achieved beyond the LWV mass reduction solution point. The aluminum analytical solution predominantly uses aluminum including chassis frame and other components. The carbon fiber reinforced plastics analytical solution predominantly uses CFRP in many of the components. The CFRP analytical solution shows higher level of mass reduction but at very high costs. Note here that both all-Aluminum and all CFRP mass reduction solutions are analytical solutions only and no computational models were developed to examine all the performance metrics.

An analysis was also conducted to examine the cost sensitivity of major vehicle systems to material cost and production volume variations.

Table VI-11 lists the components included in the various levels of mass reduction for the LWV solution. The components are incorporated in a progression based on cost effectiveness.

TABLE VI-11—COMPONENTS INCLUDED FOR DIFFERENT LEVELS OF MASS REDUCTION

Vehicle component/system	Cumulative mass saving (kg)	Cumulative MR (%)	Cumulative cost (\$)	Cumulative cost (\$/kg)
Interior Electrical Wiring .....	1.38	0.06%	(28.07)	- 20.34
Headliner .....	1.56	0.06	(29.00)	- 18.59
Trim—Plastic .....	2.59	0.11	(34.30)	- 13.24
Trim—misc. ....	4.32	0.18	(43.19)	- 10.00
Floor Covering .....	4.81	0.20	(45.69)	- 9.50
Headlamps .....	6.35	0.26	(45.69)	- 7.20
HVAC System .....	8.06	0.33	(45.69)	- 5.67
Tail Lamps .....	8.46	0.35	(45.69)	- 5.40
Chassis Frame .....	54.82	2.25	2.57	0.05
Front Bumper .....	59.93	2.46	7.89	0.13
Rear Bumper .....	62.96	2.59	11.04	0.18
Towing Hitch .....	65.93	2.71	14.13	0.21
Rear Doors .....	77	3.17	28.09	0.36
Wheels .....	102.25	4.20	68.89	0.67
Front Doors .....	116.66	4.80	92.53	0.79
Fenders .....	128.32	5.28	134.87	1.05
Front/Rear Seat & Console .....	157.56	6.48	272.57	1.73
Steering Column Assy .....	160.78	6.61	287.90	1.79
Pickup Box .....	204.74	8.42	498.35	2.43
Tailgate .....	213.14	8.76	538.55	2.53
Instrument Panel .....	218.66	8.99	565.06	2.58
Instrument Panel Plastic Parts .....	221.57	9.11	580.49	2.62
Cab .....	304.97	12.54	1,047.35	3.43
Radiator Support .....	310.87	12.78	1,095.34	3.52
Powertrain .....	425.82	17.51	1246.68	2.93



A fitted curve was developed based on the above listed mass reduction points to derive cost per kilogram at distinct mass reduction points. The current curve shows costs per kilogram approximately six times as expensive for 5 percent mass reduction (MR1) than in the NPRM, and approximately twice as expensive per kilogram for 7.5 percent mass reduction (MR2), which explains the reduction in mass reduction in the current analysis relative to the NPRM.

*D. NHTSA CAFE Model Analysis of the Regulatory Alternatives for HD Pickups and Vans: Method A*

EPCA and EISA require NHTSA to “implement a commercial medium- and heavy-duty on-highway vehicle and work truck fuel efficiency improvement program designed to achieve the maximum feasible improvement” and to establish corresponding fuel consumption standards “that are appropriate, cost-effective, and technologically feasible.”<sup>501</sup> For both the NPRM and the current analysis of potential standards for HD pickups and vans, NHTSA applied NHTSA’s CAFE Compliance and Effects Modeling System (sometimes referred to as “the CAFE model” or “the Volpe model”) to aid in determination of the maximally feasible standards. The subsequent analysis, referred to as “Method A,”

includes several updates to the model and to accompanying inputs, as discussed above in section 6.C. The “Method A” results are used as the primary basis for NHTSA’s final determination of the suitability of the Phase 2 standards. Further discussion of the determination are provided after the discussion of the “Method A” modeling results in Section 6.C.(9) of this document.

(1) Baseline Costs Across Manufacturers

As in the NPRM, the main analysis of Method A considers costs, benefits and other effects of regulatory alternatives relative to the dynamic baseline—or a baseline which assumes that manufacturers will apply all technologies with associated cost that pays back from retail-priced fuel savings within 6 months of purchase. The assumption is that consumers are willing to pay additional technology costs that return in fuel savings within 6-months of purchase, and that as a result, manufacturers will adopt these technologies regardless of fuel efficiency standards. We considered alternative runs with voluntary overcompliance of technologies with a payback period of 0-months (manufacturers will not voluntarily overcomply if there is a cost associated with a technology), 12-months, 18-months, and 24-months in the sensitivity analysis.

Before considering the effects of increases in the standards, it is important to discuss the baseline costs. These costs are assumed to be incurred even if no additional regulatory action is taken to increase standards beyond the existing MY 2018 standards. Table VI-12 shows the baseline average and total technology costs for each manufacturer in the heavy duty market, and for the heavy duty industry as a whole for the MY 2021 fleet (cost increases relative to the MY 2015 fleet). The updated CAFE model suggests that under no further increases to stringency beyond MY 2018, manufacturers would spend \$136 million—an industry average of \$180 per vehicle—on technologies that improve fuel economy in MY 2021. The additional baseline costs are not distributed across all manufacturers proportional to their fleet size. The average technology costs of an individual manufacturer fleet range from \$80 per vehicle for Fiat/Chrysler to \$350 per vehicle for General Motors. In order to explain this heterogeneity it is important to consider the sources of increased technology costs: compliance actions, inheritance from heavy duty vehicles, spillover inheritance from the light-duty vehicles, and voluntary overcompliance.

TABLE VI-12—MY 2021 COSTS (2013\$) UNDER ALTERNATIVE 1b (CENTRAL BASELINE) FOR 2b3 MARKET

Manufacturer	Average per vehicle technology cost (2013\$)	Total technology cost (million 2013\$)	Estimated MY 2015 fuel consumption (g/100 mi)	Estimated MY 2018 standard (g/100 mi)
Daimler .....	150	3	4.50	4.84
FCA .....	80	10	6.23	5.95
Ford .....	90	33	6.00	5.76
GM .....	350	86	6.52	5.94
Nissan .....	230	3	6.01	5.63
Industry .....	180	136	6.18	5.83

One reason manufacturers incur technology costs in the baseline for MY 2021 vehicles is to achieve compliance with Phase 1 standards, which end their stringency increases in MY 2018. Manufacturers will have different standards and different starting positions relative to these standards. In order to indicate which manufacturers make compliance actions which increase their baseline technology costs, Table VI-12 includes the MY 2015 estimated average fuel consumption and the estimated MY 2018 fuel consumption standard—manufacturers

with higher average fuel consumption in MY 2015 than the estimated MY 2018 fuel consumption standard, will apply technology costs to comply with the final MY 2018 standards. The fuel consumption standards are determined by setting work factor based targets and computing the manufacturer’s sales-weighted average of these targets. While the individual vehicle targets based on work factor are the same for all vehicles of the same work factor for model years 2018 and beyond, the overall fuel efficiency standard for a manufacturer may change from model year to model

year with changes to the work factors of individual vehicle models, as well as changes in relative production volumes of each vehicle model. The model does not capture all means by which a manufacturer’s average fuel efficiency standard may change under the MY 2018 attribute-based standards, but does capture changes to work factor—and therefore individual vehicle targets—due to application of mass reduction. The model also predicts changes to the fleet mix of each manufacturer using inputs created from AEO2015 and 2015 IHS/Polk production projections. The

<sup>501</sup> 49 U.S.C. 32902(k)(2).

technology cost for a manufacturer to meet MY 2018 standards is primarily driven by the fuel consumption gap between the MY 2015 (baseline) compliance level and the 2018 standard. From Table VI.4 it can be seen that only Daimler meets its most-stringent fuel consumption standard in 2015 and does not have to apply technology in the baseline to comply with Phase 1 standards.

A second source of technology costs is from inheritance; vehicles with shared platforms are assumed to inherit technologies applied to the platform leader at their next redesign or refresh to avoid creating a new body or engine platform,<sup>502</sup> even if these actions are no longer necessary to reach compliance. Manufacturers produce a limited set of engine and body platforms as a strategy to reduce their costs; there is no reason to indicate they will modify this strategy to comply with standards, for this reason this is an important constraint in the CAFE model. A similar source of technology costs are costs associated with spillover from the light-duty MY 2017–2021 standards. Regulatory agencies distinctly define the heavy duty and light duty classes, but from the manufacturer perspective these classes are not clearly delineated. They share some engine and body platforms across regulatory classes, and sometimes the most cost-effective choice to comply with standards will involve making changes to these shared platforms. Comments in the NPRM recommended

that we run the model with the ability to capture this spillover effect between the light-duty and heavy-duty fleets—in response to these comments, in the current analysis we run the two fleets together with all existing standards from the light-duty fleet included for all scenarios. Since the MY 2017–2021 light-duty CAFE standards are final, these and their effects are included in the baseline of the model—they will be in effect whether or not additional action is taken with heavy-duty standards. While we have included the ability for the standards from one fleet to affect the other, our modeling has shown that the spillover effect from the light-duty fleet into the heavy-duty fleet, and from the heavy-duty fleet into the light-duty fleet is small. We hope to further develop the model's ability to capture the spillover effects in future versions of the model.

The final way that manufacturers might accrue additional technology costs in the MY 2021 dynamic baseline scenario is through voluntary overcompliance. As already discussed: In the baseline case of the central analysis it is assumed that manufacturers will apply technologies which payback in fuel savings within 6 months of operation, regardless of whether or not the standards increase in stringency. Depending on the existing technologies and vehicles in a manufacturer's fleet, they may voluntarily overcomply by adding different technologies, or none at all.

The MY 2021 costs of the dynamic baseline scenario are lower in the updated analysis than they were in the

NPRM for all manufacturers other than Nissan and Daimler. The average technology costs across the industry are less than half the NPRM costs—dropping from \$440/vehicle to \$180/vehicle. The largest drop in average costs across the manufacturers is for GM; their costs dropped from \$780/vehicle to \$350/vehicle. The modeled costs for Nissan dropped from \$280 to \$230, and for FCA, from \$280 to \$80.

While considering MY 2021 allows for comparison to the NPRM analysis, not all baseline costs are incurred in MY 2021. Figure VI–8 shows the baseline total technology costs, and Figure VI–9, the average technology costs, by manufacturer for all model years. Like the NPRM analysis assumes manufacturers will likely apply most technologies as part of vehicle redesign or freshening; as a result their technology application comes in discrete blocks. GM applies \$20 million in total technology for their MY 2016 fleet, and an additional \$60 million in for MY 2018—their total technology costs vary slightly after this point with the projection of their fleet size and with the effects of technology learning. Similarly, Ford applies \$30 million for MY 2017 and an additional \$80 million in 2027. Chrysler/Fiat, Daimler, and Nissan apply technology in only one year—Chrysler/Fiat applies \$11 million in MY 2018, Daimler \$3 million for MY 2020, and Nissan \$3 million for MY 2021. While the total technology costs vary between manufacturers, the per-vehicle baseline costs range between \$0–\$350 for all manufacturers and model years.

<sup>502</sup> For a more complete discussion of inheritance in the model see Chapter 6, Section C.

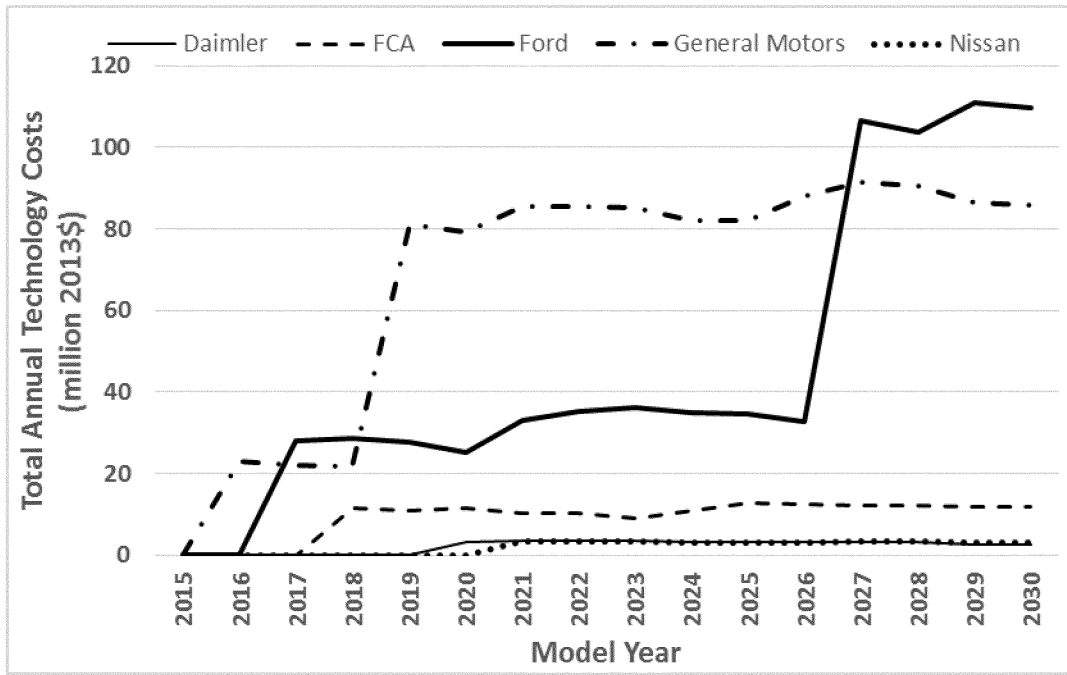

Figure VI-8 Total Annual Baseline Technology Costs (million 2013\$) by Model Year and Manufacturer

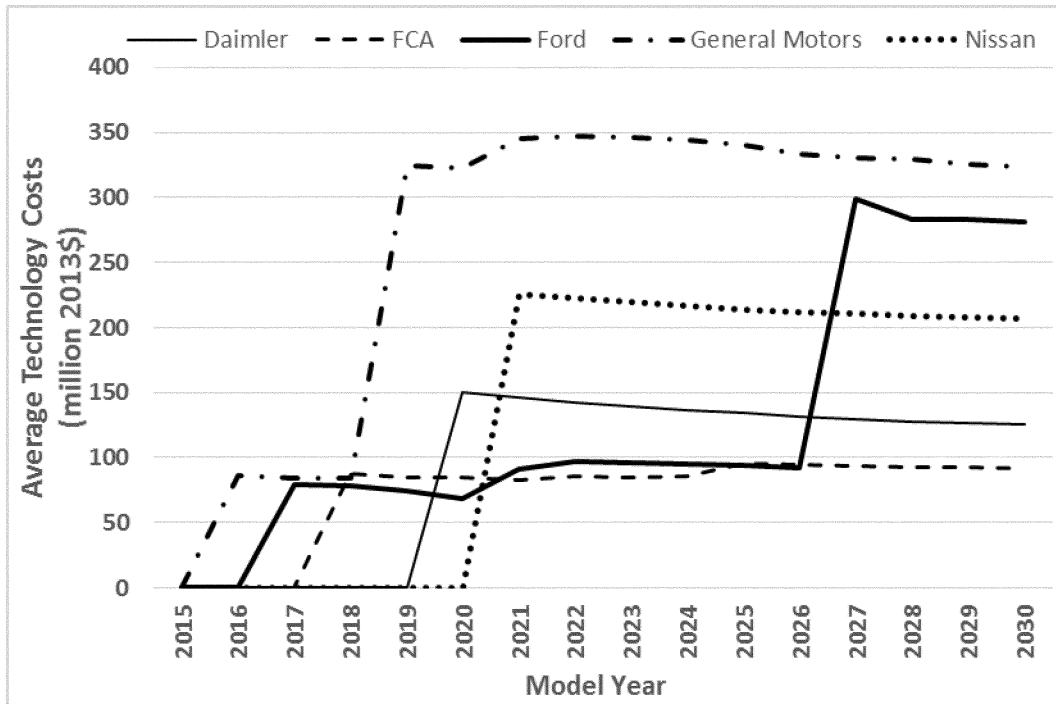

Figure VI-9 Per Vehicle Baseline Technology Costs (million 2013\$) by Model Year and Manufacturer

(2) Relevant Model Updates

There are changes to model that help explain the decrease in baseline technology costs for the current

analysis. The current analysis uses the synergies simulated by Argonne for the light-duty fleet, while the NPRM analysis uses a limited set of synergy values (also initially estimated for the

light-duty fleet. The changes in these synergy factors could impact which technologies are chosen, and how effective the model calculates them to

be.<sup>503</sup> Changes to the model input costs from the NPRM to the current analysis could also change which technologies get picked by the model, and the projected costs. One of the major changes to costs is a switch from the ICM cost mark-up methodology used in the NPRM to the RPE cost mark-up methodology of the current analysis.<sup>504</sup> A more specific change to the input costs is a change to the mass reduction curve to be based off of the newer 2014 Silverado study, which suggests that 5 percent and 10 percent mass reduction is significantly more expensive than was assumed in the NPRM.<sup>505</sup>

The final major input change is that the current model uses the 2015 fleet as its reference point, while the NPRM uses the 2014 fleet. This affects the starting point of each manufacturer in the model, and could change their predicted standard (through changes in sales mix and work factor). In order to consider the impacts of using the 2015

reference fleet it is helpful to consider the sales-weighted fuel economy and work factor distributions across the two reference fleets.

Figure VI-10 shows the sales-weighted empirical cumulative distribution function (CDF) for GM's work factor and fuel economy for the two reference fleets. The dashed line shows the values for the 2014 reference fleet, and the solid, for the 2015 reference fleet. The y-axis shows the cumulative share of the manufacturer's fleet against the two measures. For GM, the work factor CDF shifted to the right for work factors between 3500 and 5500, suggesting that the proportion of the fleet with work factors in this range increased in the GM fleet. Since increases in work factor will decrease the target value for individual vehicles, this average change in work factor decreases GM's initial CAFE standard.

It should also be noted that some methods of increasing work factor

(mainly, decreasing curb weight) can increase the fuel efficiency of a vehicle, while others (increasing the power) can decrease fuel efficiency. The empirical CDF for GM's sales-weighted fuel consumption shows GM's 2015 fleet as having more vehicles with fuel consumption below 6.3 gal/100 mi, fewer with fuel consumption around 6.3 gal/100 mi, significantly more vehicles with fuel consumption around 7.0 gal/100 mi. The average fuel consumption of GM's 2014 fleet was 6.27 gal/100 mi, where the average fuel consumption of GM's 2015 fleet is 6.52 gal/100 mi. The overall increase in GM's average fuel consumption diminishes the effect of the increase in work factor from MY 2014 to MY 2015 at improving their starting position in MY 2015 relative to MY 2014—their MY 2015 standard using the 2014 fleet was 6.36, and using the 2014 fleet and is 6.59. Considering this, their initial shortfall is about the same using either reference fleet.

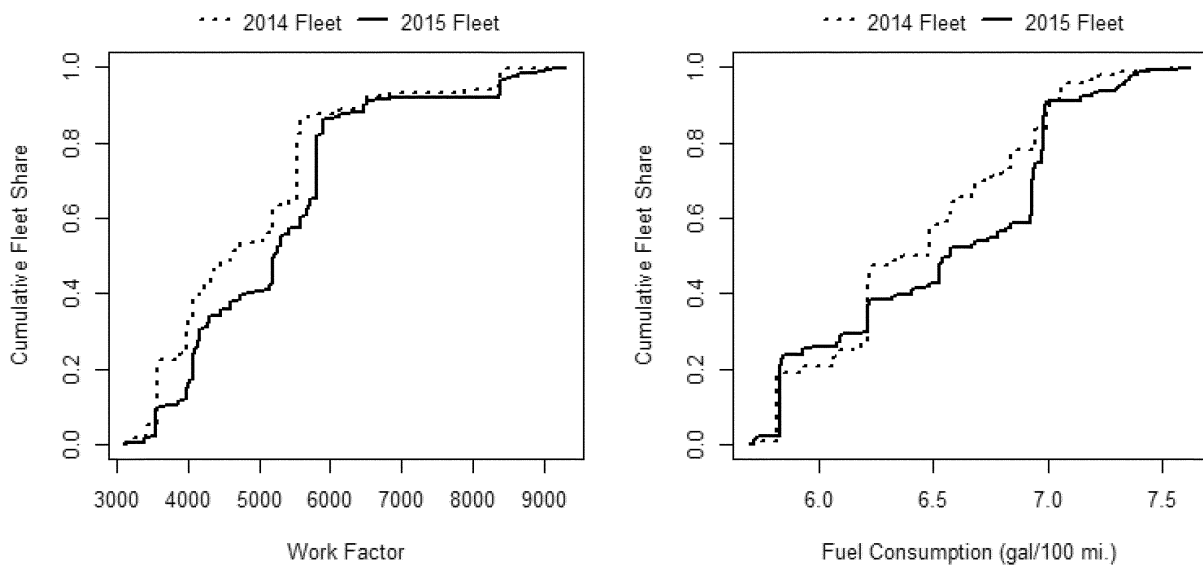

**Figure VI-10 2014 vs. 2015 Reference Fleet Work Factor and Fuel Efficiency for General Motors**

Figure VI-11 shows the same for Ford. There is a similar pattern of a higher proportion of heavy duty vehicles in Ford's fleet with work factors between 3500 and 5000. This will decrease Ford's initial standard in the model. Ford also shows a decrease in the proportion of heavy duty vehicles

with higher fuel consumption, which will result in an overall lower fuel consumption for the 2015 fleet. The result is that Ford will start with a lower standard by using the 2015 fleet rather than the 2014 fleet, and start with a higher fuel efficiency level—both of which will work in the same direction

to decrease Ford's shortfall to MY 2018 standards. This suggests that Ford will not need to apply as much technology to comply, and helps to explain their lower baseline technology costs in the current analysis.

<sup>503</sup> For a more complete discussion of the changes to the Argonne simulation synergies see Chapter 6, Section C.

<sup>504</sup> For further discussion on the switch from ICM to RPE for the final analysis see Chapter 6, Section C.

<sup>505</sup> More discussion of the change in mass reduction curves is present in Chapter 6, Section C.

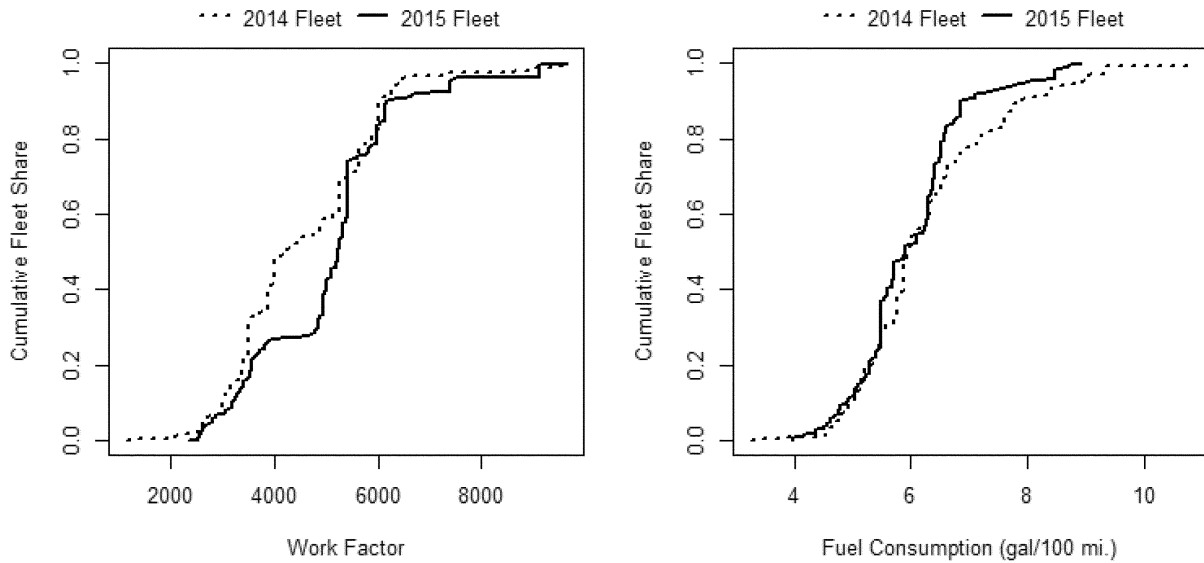
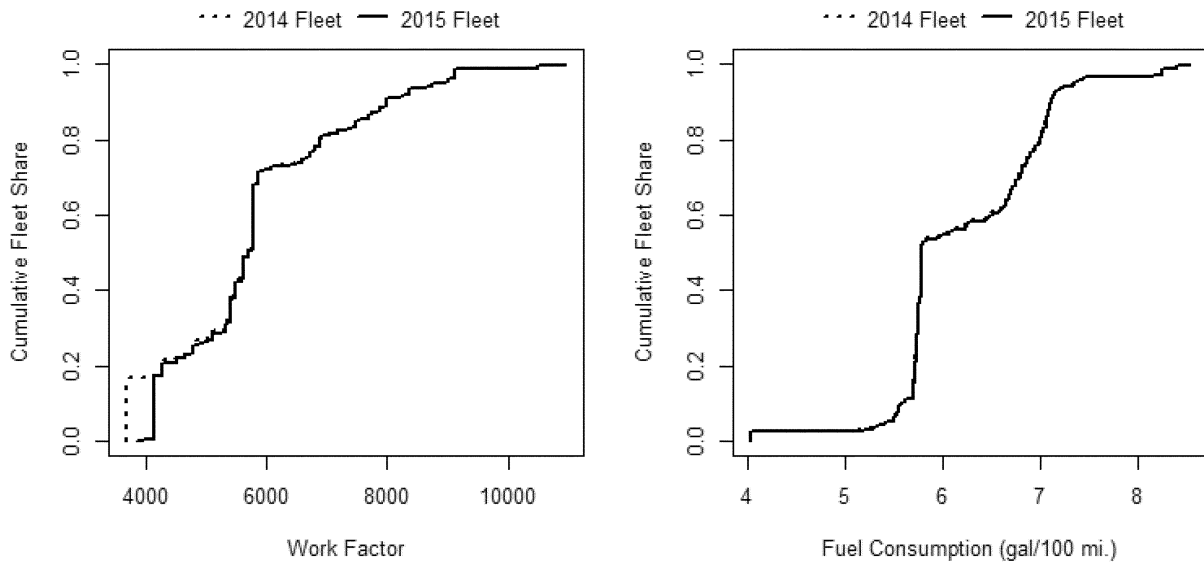

**Figure VI-11 2014 vs. 2015 Reference Fleet Work Factor and Fuel Economy for Ford**

Figure VI-12 shows the cumulative distribution function for the work factor of Fiat/Chrysler. Although there is some increase in the left tail of the distribution of FCA’s work factor for MY 2015 relative to MY 2014, it is smaller

than for the Ford and GM fleets. The CDF of fuel efficiency also shows that Fiat/Chrysler shows nearly identical distribution of fuel consumption between the 2014 and 2015 fleets. These two factors combine to explain why

Fiat/Chrysler did not show increases in costs from the NPRM to the current analysis—they did not have as much of a change in shortfall to MY 2018 standards as both GM and Ford.

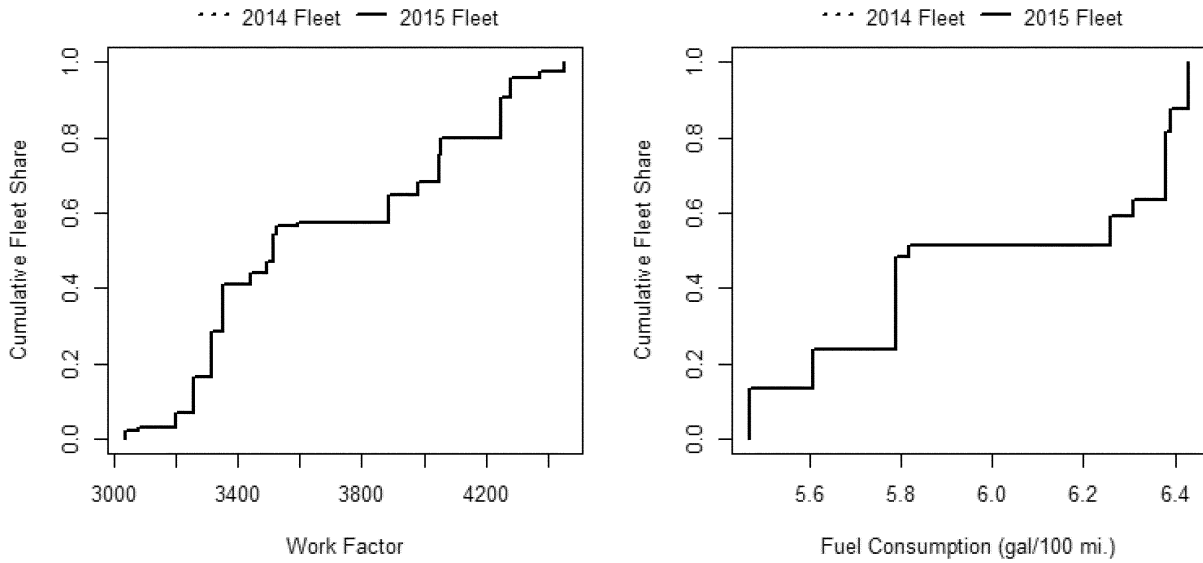

**Figure VI-12 2014 vs. 2015 Reference Fleet Work Factor and Fuel Economy for Fiat/Chrysler**

Figure VI-13 shows the same empirical distribution functions for Nissan. Both the distribution of work

factor and fuel consumption are comparable for Nissan’s 2014 and 2015 fleets. This helps explain the small

change in Nissan’s baseline costs between the two analyses.

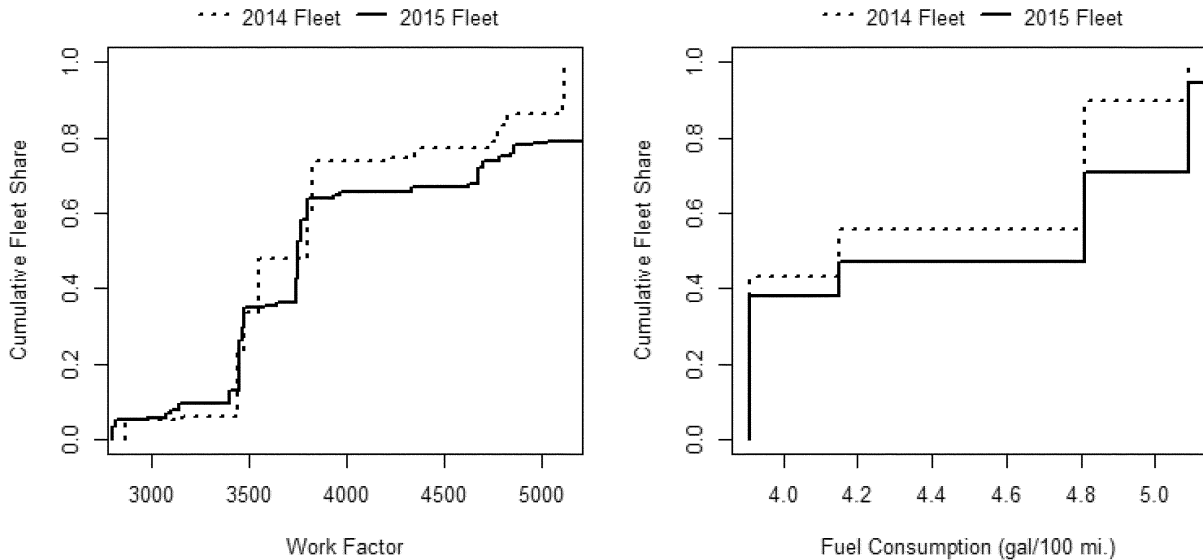

**Figure VI-13 2014 vs. 2015 Reference Fleet Work Factor and Fuel Economy for Nissan**

Figure VI-14 shows the cumulative distribution function for work factor and fuel consumption for Daimler for both the 2014 and 2015 fleets. The distribution of work factor shifted right for work factors above 3500. The fuel

consumption curve shifted right for all fuel consumptions. This suggests that Daimler will face a lower standard using the 2015 reference fleet, but that they may also start with a lower initial fuel efficiency level. The change to the 2015

reference fleet does not have clear implications on the relative starting point of Daimler in the analysis relative to the NPRM analysis.



**Figure VI-14 2014 vs. 2015 Reference Fleet Work Factor and Fuel Economy for Daimler**

**(3) Industry-Level Results of Regulatory Alternatives**

Table VI-13, below, summarizes the stringency of standards, the estimated required fuel efficiency the estimated achieved fuel efficiency, as well as the impacts of each alternative for the

overall industry for MY 2030. Using the updated fleet and analysis, the MY 2030 stringency is slightly less than in the NPRM (4.91 gallons/100 mile in today's analysis compared to 4.86 gallons/100 mile in the NPRM for the preferred alternative). As has been noted, the

standards are set based in part on the work factor of vehicles; by changing the average work factor of their fleet, manufacturers can change the average stringency of their standard. While the model does not simulate changes to work factor which would increase the

power or GVWR, it does simulate changes in work factor due to mass reduction. By lowering the curb weight and holding power constant, manufacturers can increase the payload of a vehicle; since payload is a component in calculating the work factor, by lowering curb weight

manufacturers can increase their work factor for a vehicle model and reduce its target. However, the average absolute and proportional curb weight reduction in the current analysis is less than it was in the NPRM analysis across all alternatives, which can be explained by the higher mass reduction costs under

the current curve. This suggests that the change in the average overall industry standard in today's analysis is likely due in major part to changes in the work factor between the 2014 and 2015 reference fleet, and not to changes in the work factor simulated within the model runs.

TABLE VI-13—SUMMARY OF IMPACTS ON THE MY 2030 HD INDUSTRY FLEET (VS. ALTERNATIVE 1b)

Alternative	2	3	4	5
<b>Stringency of Standards</b>				
Annual Increase in Stringency Beginning in MY 2021 .....	2.0%	2.5%	3.5%	4.0%
Increases Until MY 2025 .....	MY 2025	MY 2027	MY 2025	MY 2025
Total Increase in MY 2030 Stringency Relative to Final Phase 1 Standards <sup>a</sup> .....	9.6%	15.6%	15.6%	17.9%
<b>Estimated Average Fuel Economy (miles per gallon)</b>				
Required in MY 2030 .....	19.03	20.37	20.38	20.95
Achieved in MY 2030 .....	19.20	20.47	20.45	20.98
<b>Average Fuel Consumption (gallons/100 miles)</b>				
Required in MY 2030 .....	5.25	4.91	4.91	4.77
Achieved in MY 2030 .....	5.21	4.88	4.89	4.77
<b>Estimated Average Greenhouse Gas Emissions (grams per mile)</b>				
CO <sub>2</sub> Required in MY 2030 .....	494	462	462	450
CO <sub>2</sub> Achieved in MY 2030 .....	490	460	460	449
<b>Technology Penetration in MY 2030 (percent)</b>				
VVT and/or VVL .....	56	56	56	56
Cylinder Deactivation .....	4	4	4	4
Direct Injection Engine .....	17	27	26	29
Turbo Charged Engine .....	59	69	68	68
8 Speed Auto. Trans. ....	77	95	94	95
EPS, Accessories .....	52	80	80	96
12V Stop-start .....	0	0	3	11
Strong Hybrid .....	0	2	2	7
Aero. Improvements .....	46	80	80	98
<b>Mass Reduction (vs. No-Action)</b>				
Mass Reduction (lb.) .....	28	240	24	289
Mass Reduction (percent of curb weight) .....	0.43	3.6	3.7	4.3
<b>Technology Costs (vs. No-Action)</b>				
Average Vehicle (\$) .....	\$500	\$1470	\$1480	\$1890
Payback Period (m) <sup>b</sup> .....	19	30	31	33

**Notes:**

<sup>a</sup> This increase in stringency is based on the estimated percentage change in fuel consumption (gal/100mi) stringency projected by the model for the MY 2030 fleet under the final Phase 2 standards relative to the continuation of Phase 1 standards. Note that if manufacturers' have applied mass reduction to an individual vehicle model in the CAFE model that this will increase the work factor of that vehicle in the model, and make the individual target less stringent. Thus, where any mass reduction is applied in the model, the total increase in stringency of the fleet presented here will be lower than the total stringency increase of the fleet if no mass reduction were applied.

<sup>b</sup> Here payback period is calculated using estimated undiscounted retail fuel savings and the initial technology costs for MY 2030.

Today's Method A analysis using the updated version of the CAFE model and updated inputs shows that regulatory Alternatives 3 and 4 could be met with a small application of strong (P2) HEVs. However, Alternative 5 could be met with the considerably greater application of strong HEVs. Although there is some increase in the penetration rates between alternatives as stringency

increases, the current analysis suggests that under all alternatives, nearly all of the MY 2030 heavy-duty fleet could use 8-speed transmissions, VVT/VVL improvements and turbo-charged engines with application across more than half of the fleet, direct injection could be present in a quarter of the fleet, and cylinder deactivation could play a minor part in the HD fleet. EPS and

improved electrical accessories vary more between alternatives; present in 52 percent of the fleet in Alternative 2, 80 percent in Alternatives 3 and 4, and 96 percent in Alternative 5. Aerodynamic improvements and mass reduction follow a similar pattern; with a larger penetration of these technologies with Alternative 3 than with Alternative 2, a similar penetration under Alternatives 3

and 4, and a higher in penetration in Alternative 5.

A way to measure the cost-effectiveness of the technologies on consumers is to look at the payback period. In this context, the payback period is defined as the number of months of driving it will take a consumer to earn back the increased technology costs by the amount they save in fuel by driving a more fuel efficient vehicle. Under the current analysis, the average additional technology cost will payback in fuel savings in under 17 months for Alternative 2, 27 months for Alternatives 3 and 4, and 30 months for Alternative 5. It is important to note that there are inputs other than the cost and effectiveness of technologies which could affect the payback period; the fuel prices and mileage accumulation schedules will affect how quickly the cost of a fuel-saving technology pays back.

The current analysis uses updated fuel price estimates from AEO 2015 that are lower than in the NPRM analysis. Lower fuel prices will decrease the absolute amount of fuel savings (assuming the same number of gallons is consumed) and increase the payback period if the technologies, their cost, and their effectiveness are unchanged. Further, we have updated the vehicle use schedule (vehicle miles traveled, or VMT) based on actual vehicle odometer readings from IHS/Polk data as shown in Figure VI.6 While the overall survival-weighted schedules show 6.5

percent fewer lifetime miles for heavy-duty vehicles, they show more annual miles driven for the first 5-years of use for heavy-duty vehicles. The result is that the overall lifetime fuel savings will decrease, but the fuel savings will be higher for the first 5 years. Since the payback periods under both analyses are shorter than 5 years, using the updated vehicle schedules will show a shorter payback period (if other factors are unchanged) than in the NPRM analysis. The changes in fuel prices and the change in the mileage accumulation schedule work in opposite directions on the payback period; the total change in payback period is attributable to both of these input changes as well as to the changes in the cost<sup>506</sup> and effectiveness<sup>507</sup> of the different technology inputs, and the changes in the reference fleet.

Industry costs in MY 2030 provide one perspective on technology costs. Industry cost in each model year provides additional perspective on the timing, pace and the amount of resources and spending that would need to be allocated to implement technologies and is important in the consideration of the feasibility of the

<sup>506</sup> The costs now use RPE rather than ICM, and we updated the mass reduction curve to the 2014 Silverado.

<sup>507</sup> Nominal effectiveness input values are as for the NPRM analysis. Synergy factors applied to adjust fuel consumption impacts for specific combinations of technologies reflect current vehicle simulation work conducted for NHTSA by Argonne National Laboratory.

alternatives. Figures Figure VI–15 and Figure VI–16 show the total and average additional and total additional technology costs for the industry by model year and alternative. Note that the trend of the total and average costs are very similar, this is because the fleets size the AEO projections suggest a relatively constant fleet size during the considered MY's. The total and average technology costs increase with alternative stringency. It is important to note that Alternatives 3 and 4 both increase total stringency for the MY 2030 industry fleet by 15.6 percent. Also note that these estimations of stringency increases include the model projections of how the application of mass reduction will alter work factor and individual vehicle targets.<sup>508</sup> The annual average and total technology costs of Alternative 3 approach those of Alternative 4 by MY 2029 when both alternatives have reached maximum stringency. If manufacturers are to reach the same stringency level over a longer horizon, they will likely make similar technology choices, but be given longer to implement them. This will make the total technology costs lower, but should unsurprisingly make the marginal technology costs for model years where both standards have matured very similar.

**BILLING CODE 6560–50–P**

<sup>508</sup> The final Phase 2 standard target curves increase in stringency by 16.2 percent compared to final Phase 1 standards, as discussed in section VI.B.



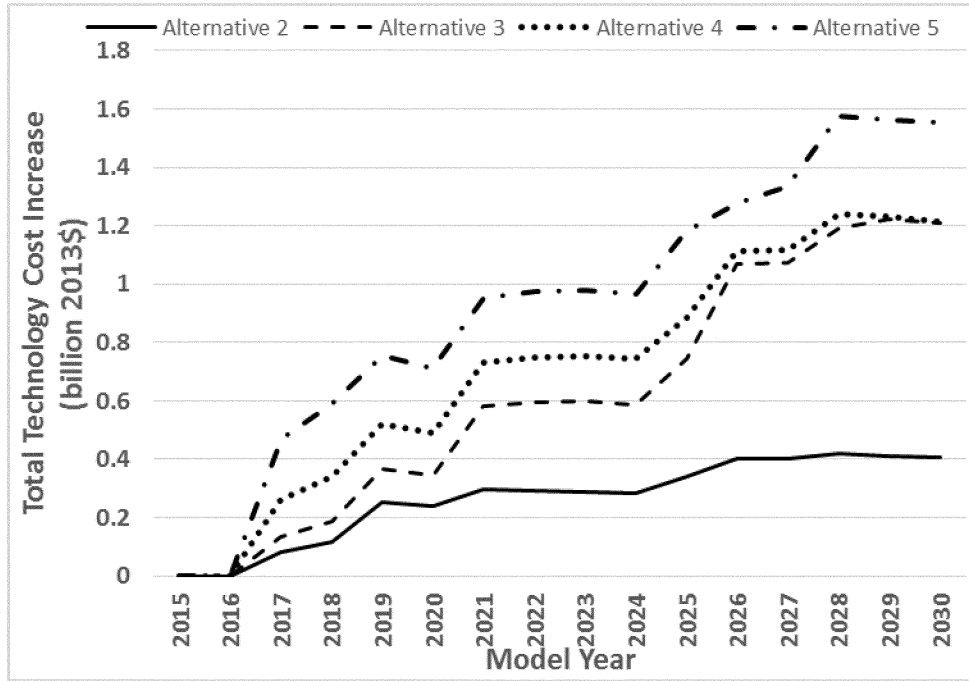

Figure VI-15 Industry Total Technology Cost Increase by Model Year and Alternative

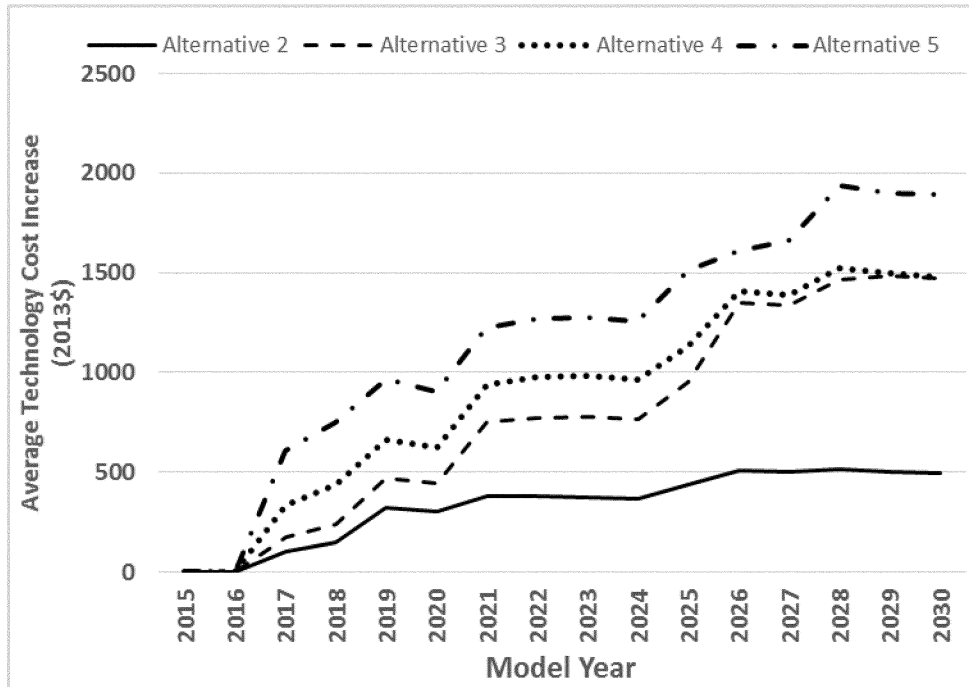

Figure VI-16 Industry Average Technology Cost Increase by Model Year and Alternative

The average incremental industry technology costs mature to around \$500 under Alternative 2, \$1500 under Alternatives 3 and 4, and \$1900 under Alternative 5. Figure VI-17 shows the

cumulative total industry costs by model year fleet. \$4.2 billion in additional technology costs for model years 2016–2030 are associated with Alternative 2, \$9.9 billion with

Alternative 3, \$11.4 billion with Alternative 4, and \$14.9 billion with Alternative 5. While the marginal technology costs of Alternative 3 approach those of Alternative 4 as the

total stringencies converge, the total costs of Alternative 4 are \$1.5 billion more by MY 2030. It is particularly noteworthy that costs and the rate of increase in costs would be significantly different in the MYs 2017–2021 timeframe among the alternatives. This

identifies the significant differences in the resources and capital that would be required to implement the technologies required to comply with each of the alternatives during this period, as well as the reduction in lead time to implement the technologies which

increases reliability risk. These differences are an important consideration for the feasibility of the alternatives and for the selection of the final standards, as discussed further below.

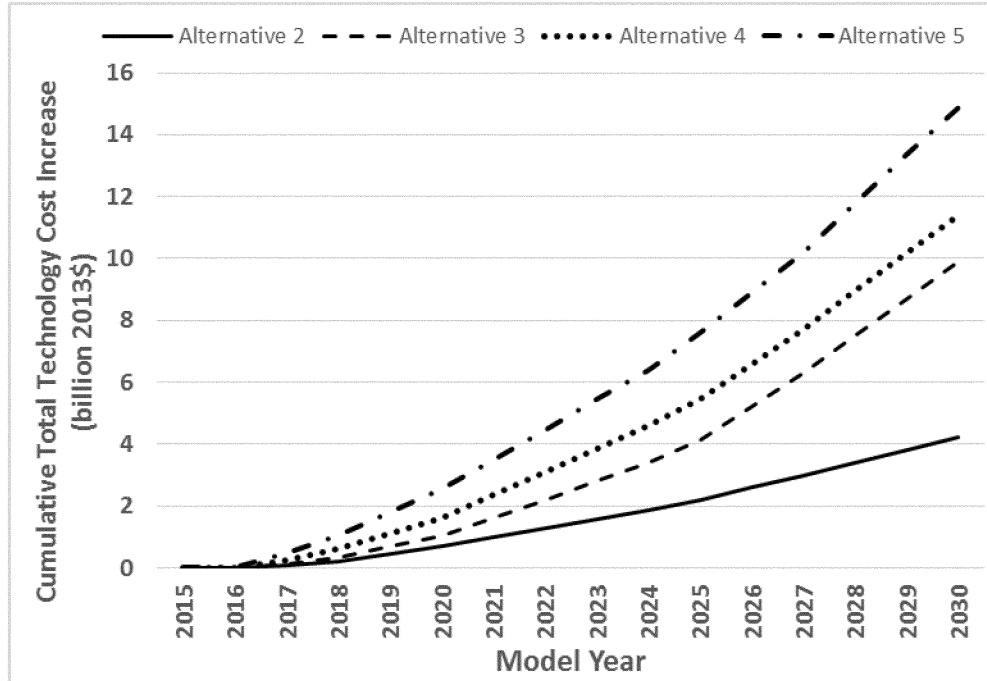

Figure VI-17 Industry Cumulative Total Technology Cost Increase by Model Year and Alternative

BILLING CODE 6560-50-C

(4) Manufacturer-Specific Results of Regulatory Alternatives

In addition to varying across scenario and model year, the impacts of the standards vary across manufacturers. Manufacturers will have different compliance strategies based on which technologies they have already invested

in, in both their heavy-duty and light-duty fleets, and based on the effectiveness of new technology applications specific to the vehicles in their heavy duty fleets. Table VI-14 summarizes the initial technology utilization in the 2015 fleet by manufacturer. Ford uses direct injection for 8 percent of their fleet, cylinder deactivation for 13 percent of their fleet,

and turbo-charged engines for 8 percent of their fleet. Daimler has already invested to equip all of its fleet with 8-speed automatic transmissions. These differences in initial technology levels affect the new investments each manufacturer would need to further improve the fuel efficiency of their fleets.

TABLE VI-14—SUMMARY OF MY 2015 REFERENCE FLEET TECHNOLOGY PENETRATION

Technology	Technology Penetration (percent)					
	GM	Ford	FCA	Daimler	Nissan	Industry
Cylinder Deactivation .....	0	0	13	0	0	2
Direct Injection Engine .....	0	8	0	0	0	4
Turbo Charged Engine .....	0	8	0	0	0	4
8 Speed Auto. Trans. ....	0	0	0	100	0	3
EPS, Accessories .....	0	0	0	0	0	0
12V Stop-start .....	0	0	0	0	0	0
Strong Hybrid .....	0	0	0	0	0	0
Aero. Improvements .....	0	0	0	0	0	0

Table VI-15 summarizes the alternatives, and a technology pathway General Motors could use to comply with each of the alternatives. The pathway includes implementing 8 speed automatic transmissions across its entire fleet. For Alternatives 2 and 3, no stop-start or HEVs are added to GM's fleet, for Alternative 4, 1 percent of GM's fleet uses stop-start, and for Alternative 5, 2 percent uses stop-start and 13 percent are HEVs. For all alternatives, nearly all

of the GM's fleet would use electric power steering and improved electric accessories.

For all alternatives, VVT/VVL is applied to 65 percent of its engines. For Alternative 2, none of its engines get direct injection and 43 percent get turbocharging and downsizing, while for Alternatives 3-5, direct injection is applied to 28 percent of its engines and turbocharging and downsizing is applied to 61 percent of its engines. For

all alternatives, all of GM's fleet gets aerodynamic improvements. The average mass reduction is 52 lbs. (0.78 percent of the average curb weight) under Alternative 2, and 350-380 lbs. (5.2-5.7 percent of the average curb weight) under Alternatives 3-5. Similar technology is applied for Alternatives 3 and 4 in MY 2030, but there are significantly more strong hybrids under Alternative 5.

TABLE VI-15—SUMMARY IMPACTS ON GENERAL MOTORS HD FLEET BY ALTERNATIVE (VS. ALTERNATIVE 1b)

Alternative	2	3	4	5
<b>Alternative Stringency</b>				
Annual Increase in Stringency Beginning in MY 2021 .....	2.0%	2.5%	3.5%	4.0%
Increases Until .....	MY 2025	MY 2027	MY 2025	MY 2025
Total Increase in MY 2030 Stringency Relative to Final Phase 1 Standards <sup>a</sup> .....	9.6%	15.2%	15.4%	17.7%
<b>Estimated Average Fuel Economy (miles per gallon)</b>				
Required in MY 2030 .....	18.69	19.92	19.96	20.53
Achieved in MY 2030 .....	18.70	20.04	20.04	20.6
<b>Average Fuel Consumption (gallons/100 miles)</b>				
Required in MY 2030 .....	5.35	5.02	5.01	4.87
Achieved in MY 2030 .....	5.35	4.99	4.99	4.85
<b>Estimated Average Greenhouse Gas Emissions (grams per mile)</b>				
CO <sub>2</sub> Required in MY 2030 .....	498	467	466	453
CO <sub>2</sub> Achieved in MY 2030 .....	496	464	464	452
<b>Technology Penetration in MY 2030 (percent)</b>				
VVT and/or VVL .....	65	65	65	65
Cylinder Deactivation .....	0	0	0	0
Direct Injection Engine .....	0	28	28	28
Turbo Charged Engine .....	33	61	61	61
8 Speed Auto. Trans .....	100	100	100	100
EPS, Accessories .....	100	100	100	100
12V Stop-start .....	0	0	2	2
Strong Hybrid .....	0	0	0	13
Aero. Improvements .....	100	100	100	100
<b>Mass Reduction (vs. No-Action)</b>				
Curb Weight Mass Reduction (lb.) .....	52	384	384	340
Mass Reduction (percent of curb weight) .....	0.78	5.7	5.7	5.1

**Note:**

<sup>a</sup>This increase in stringency is based on the estimated percentage change in fuel consumption (gal/100mi) stringency projected by the model for the MY 2030 fleet under the final Phase 2 standards relative to the continuation of Phase 1 standards. Note that if manufacturers' have applied mass reduction to an individual vehicle model in the CAFE model that this will increase the work factor of that vehicle in the model, and make the individual target less stringent. Thus, where any mass reduction is applied in the model, the total increase in stringency of the fleet presented here will be lower than the total stringency increase of the fleet if no mass reduction were applied.

Figure VI-18 and Figure VI-19 show the total and average incremental technology costs by alternative. Under Alternative 2 General Motors' incremental technology cost is \$140M in MY 2019, increasing to \$180M in MY 2021. The pathways for Alternatives 3 and 4 are very similar, which again should not be surprising given that the standards result in the same total

stringency increase in MY 2027 and beyond and the long redesign cycles in the segment. GM's incremental technology cost is \$190M in MY 2019, increasing to \$400M in MY 2021, and \$530M in MY 2028. Under Alternative 5 GM could have a similar compliance strategy as Alternative 3 and 4, but incremental technology cost is \$650M in MY 2028. The highest annual average

technology cost for GM is: \$750 under Alternative 2, \$1940 under Alternatives 3 and 4, and \$2370 under Alternative 5. In the case of GM, the added lead time of Alternative 4 does not significantly change the cost of their compliance strategy.

BILLING CODE 6560-50-P

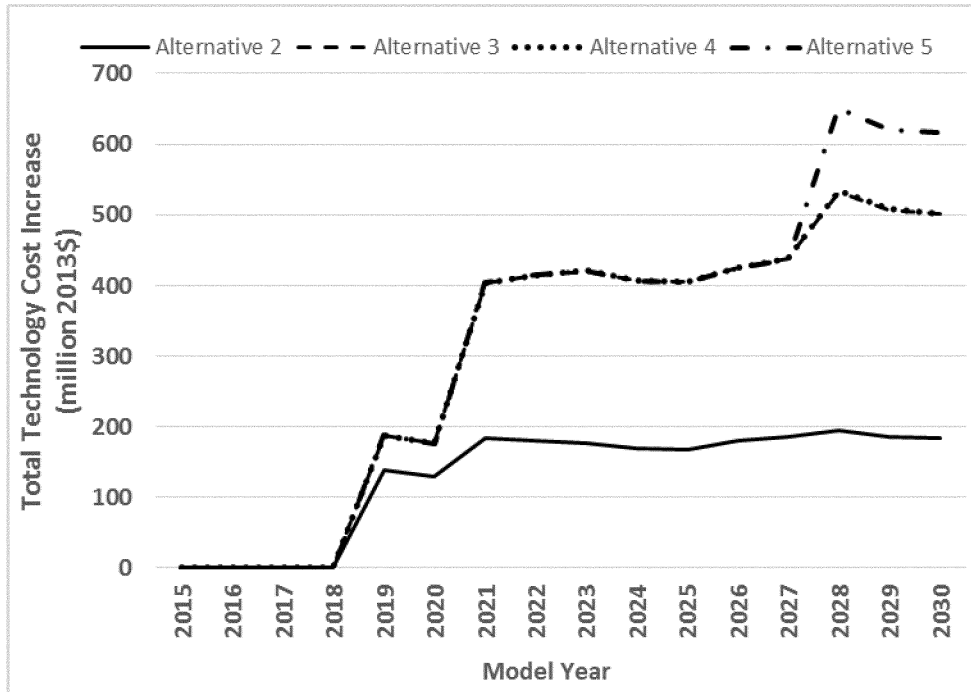

Figure VI-18 Total Technology Cost Increase for General Motors by Model Year and Alternative

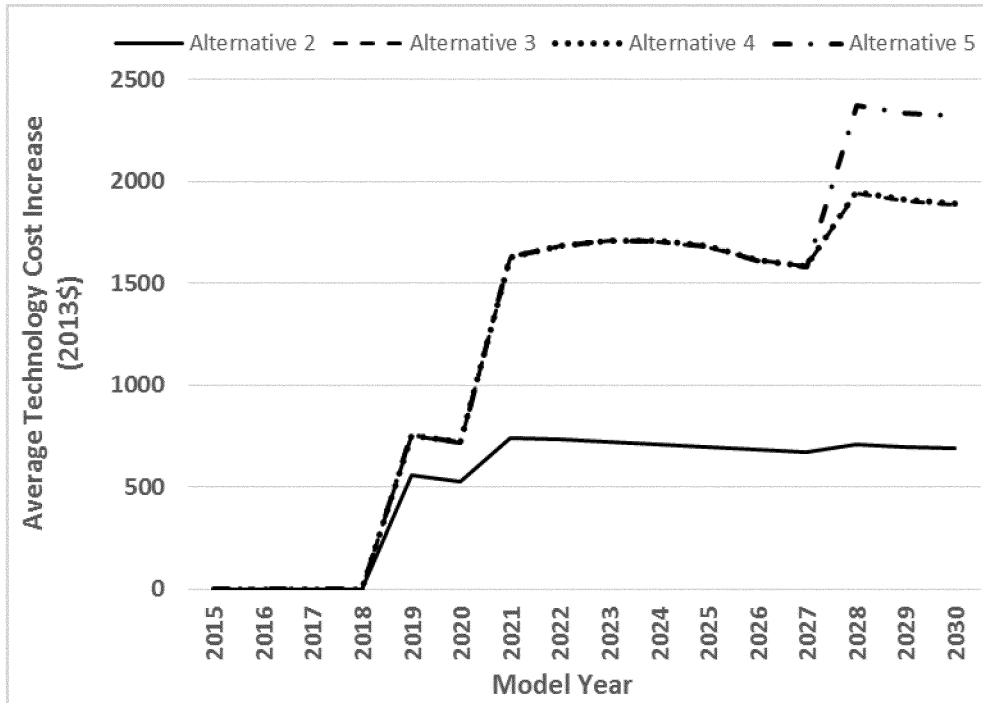

Figure VI-19 Average Technology Cost Increase for General Motors by Model Year and Alternative

Figure VI-20 shows the cumulative total incremental costs for GM under all alternatives. The total costs to comply

with Alternative 2 for GM for MY's 2016–2030 is \$2.1 billion, for

Alternatives 3 and 4 it is \$4.8 billion, and for Alternative 5 it is \$5.2 billion.

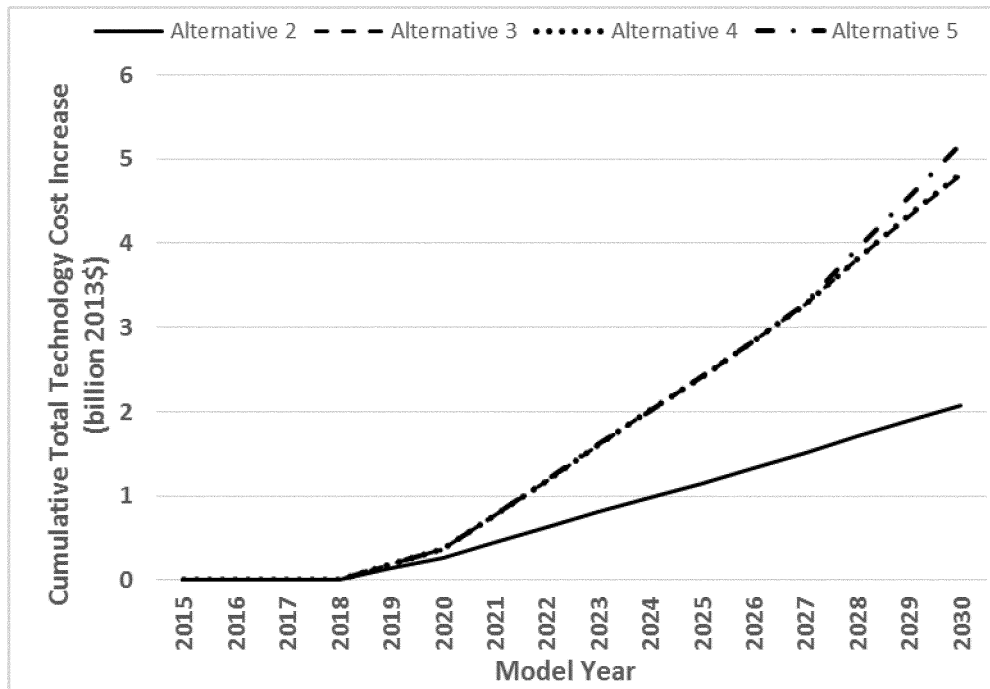

Figure VI-20 General Motors Cumulative Total Technology Cost Increase by Model Year and Alternative

BILLING CODE 6560-50-C

Table VI-16 gives the same summary of a potential compliance strategy for Ford's heavy-duty fleet. Similar to GM, to reach compliance Ford uses 8 speed automatic transmissions in their entire fleet. For Alternatives 3 and 4, Ford uses hybrid technologies in 4 percent of their fleet, and for Alternative 5, they use hybrid technologies in 7 percent of their fleet. In addition to strong hybrids, Ford uses 12v stop-start in 4 percent of their fleet in Alternative 4, and 12v stop-start in 19 percent of their fleet in Alternative 5. The compliance strategy in the NPRM analysis shows Ford using significantly more hybrids and 12v stop-start systems in Alternatives 4 and 5 than the current analysis which likely explains part of

the lowered cost for Ford in the current analysis.

Under the current analysis possible compliance strategy, the application of engine technologies for Ford come in discrete chunks, as with GM. Ford uses VVT/VVL in 58 percent of their fleet under all alternatives by MY 2030; they also started with 8 percent direct-injection engines, and end with 27 percent; they also started with 8 percent turbo-charged engines, but end with 69 percent for all scenarios. The application of EPS and improved accessories vary across the compliance strategies of different regulatory alternatives; under Alternative 2, only 13 percent of Ford's fleet improves these electrical features, while under

Alternatives 3-4, 64 percent, and Alternative 5, 96 percent.

For body-platform technologies, Ford applies in discrete chunks to the same platforms across some Alternatives. They apply an average of 77 lb. (1.2 percent) mass reduction across their fleet in Alternative 2 and 132-142 lb. (2.0-2.2 percent) in Alternative 3-5. Progressively less mass reduction is applied under Alternatives 4 and 5—this is likely because more of the fleet was hybridized and mass reduction to small platforms was no longer necessary to comply. Aerodynamic improvements are not applied in Alternative 2, but are applied to 64 percent of the fleet in Alternative 3 and 4, and to all of the fleet in Alternative 5.

TABLE VI-16—SUMMARY OF IMPACTS ON FORD HD FLEET BY ALTERNATIVE (VS. ALTERNATIVE 1b)

Alternative	2	3	4	5
<b>Alternative Stringency</b>				
Annual Increase in Stringency Beginning in MY 2021 .....	2.0%	2.5%	3.5%	4.0%
Increases Until .....	MY 2025	MY 2027	MY 2025	MY 2025
Total Increase in MY 2030 Stringency Relative to Final Phase 1 Standards <sup>a</sup>	9.6%	15.7%	15.7%	18.1%
<b>Estimated Average Fuel Economy (miles per gallon)</b>				
Required in MY 2030 .....	19.23	20.62	20.62	21.23
Achieved in MY 2030 .....	19.36	20.61	20.63	21.21
<b>Average Fuel Consumption (gallons/100 miles)</b>				
Required in MY 2030 .....	5.2	4.85	4.85	4.71
Achieved in MY 2030 .....	5.16	4.85	4.85	4.71

TABLE VI-16—SUMMARY OF IMPACTS ON FORD HD FLEET BY ALTERNATIVE (VS. ALTERNATIVE 1b)—Continued

Alternative	2	3	4	5
<b>Estimated Average Greenhouse Gas Emissions (grams per mile)</b>				
CO <sub>2</sub> Required in MY 2030 .....	488	456	455	443
CO <sub>2</sub> Achieved in MY 2030 .....	485	455	455	443
<b>Technology Penetration in MY 2030 (percent)</b>				
VVT and/or VVL .....	58	58	58	58
Cylinder Deactivation .....	0	0	0	0
Direct Injection Engine .....	27	27	27	27
Turbo Charged Engine .....	69	69	69	69
8 Speed Auto. Trans .....	64	100	100	100
EPS, Accessories .....	13	64	64	96
12V Stop-start .....	0	0	4	19
Hybridization .....	0	4	4	7
Aero. Improvements .....	0	64	64	100
<b>Mass Reduction (vs. No-Action)</b>				
Curb Weight Mass Reduction (lb.) .....	77	142	140	132
Mass Reduction (percent of curb weight) .....	1.2	2.2	2.1	2.0

**Note:**

<sup>a</sup>This increase in stringency is based on the estimated percentage change in fuel consumption (gal/100mi) stringency projected by the model for the MY 2030 fleet under the final Phase 2 standards relative to the continuation of Phase 1 standards. Note that if manufacturers' have applied mass reduction to an individual vehicle model in the CAFE model that this will increase the work factor of that vehicle in the model, and make the individual target less stringent. Thus, where any mass reduction is applied in the model, the total increase in stringency of the fleet presented here will be lower than the total stringency increase of the fleet if no mass reduction were applied.

**BILLING CODE 6560-50-P**

Figure VI-21 and Figure VI-22 show the total and average incremental technology costs for Ford by alternative and model year. Ford adds \$80 million in technology costs for MY 2017 and an additional \$40 million in MY 2026 in Alternative 2. For the Preferred Alternative, Ford adds \$130 million in MY 2017 and an additional \$300 million in MY 2026. Under Alternative 4, Ford adds \$260 million in MY 2017 and \$180 million in MY 2026. Similar to the industry pattern, Ford's compliance strategy involves less annual technology costs early in Alternative 3 than Alternative 4, but

their technology costs converge under the two alternatives as the final stringency level is reached under Alternative 3 in MY 2027.

It is important to note that the increase in costs and rate of the increase in costs is significantly different for MY 2017 among the alternatives—with the incremental total cost increase for MY 2017 being double those of Alternative 3 for Alternative 4, and more than double for Alternative 5. MY 2017 is the first redesign year and Ford does not have another scheduled redesign until MY 2026. Under the additional lead time of Alternative 3, the majority of Ford's cost increases occur in the MY

2026 redesign, while Alternatives 4 and 5 put most of the cost burden to reach compliance on the MY 2017 redesign (or would require an additional redesign be added between MY 2017 and 2026).

NHTSA judges the lack of lead time would make Alternatives 4 and 5 beyond maximum feasibility for Ford because its designs for MY 2017 are essentially complete and substantial resources and very high costs would be required to add another vehicle redesign between MY 2017 and MY 2026 to implement the technologies that would be needed to comply with those alternatives.

**BILLING CODE 6560-50-P**

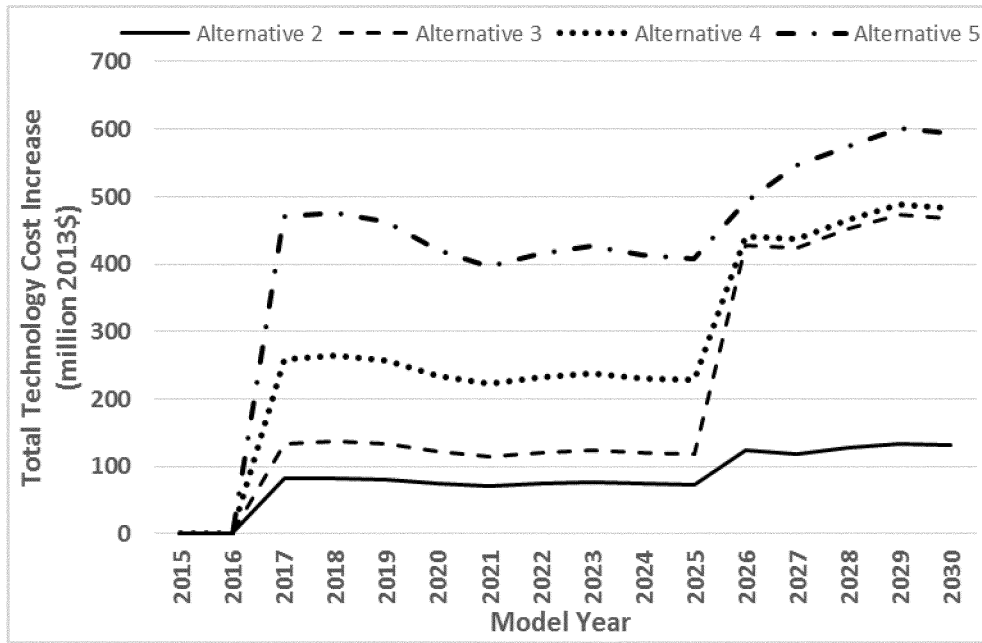

Figure VI-21 Total Technology Cost Increase for Ford by Model Year and Alternative

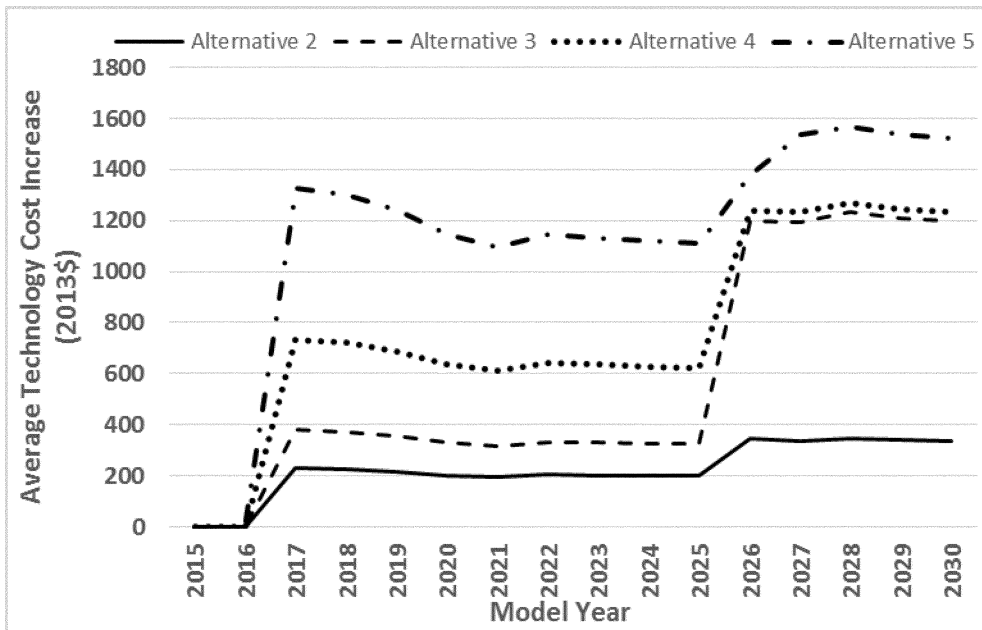

Figure VI-22 Average Technology Cost Increase for Ford by Model Year and Alternative

Figure VI-23 below shows the cumulative total costs for Ford under all action alternatives. The total costs for MY's 2015–2030 under Alternative 2 are \$1.3 billion, under Alternative 3 they

are \$3.4 billion, for Alternative 4 they are \$4.5 billion, and finally for Alternative 5 they are \$6.7 billion. This further illustrates the point that manufacturers act to minimize costs

over multiple model years. The added lead time from Alternative 4 allows them to delay some actions, which will allow them more time to make sure that they are well-implemented.

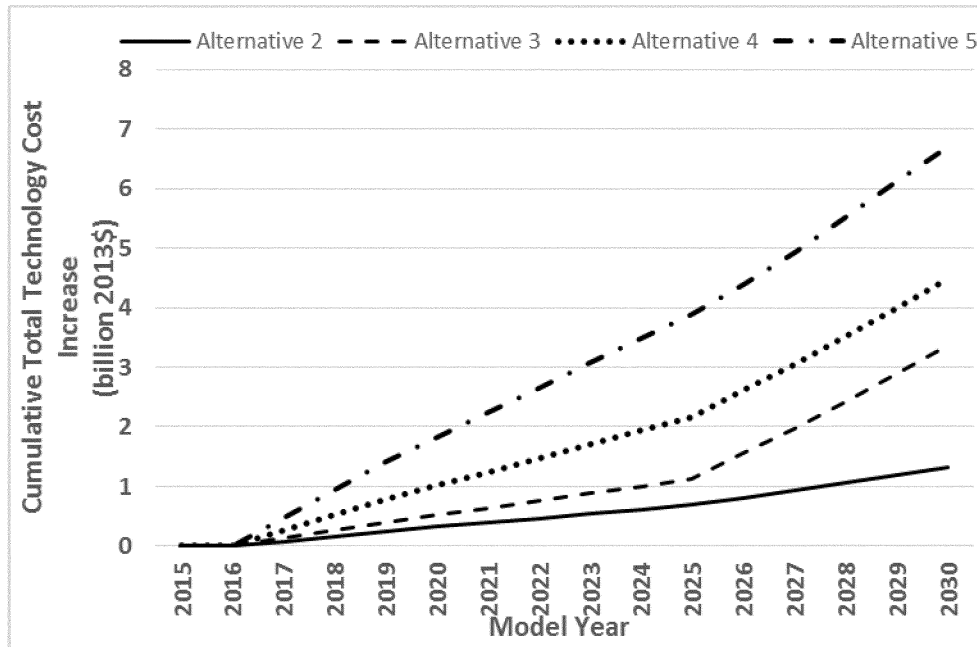

Figure VI-23 Ford Cumulative Technology Cost Increase by Model Year and Alternative

**BILLING CODE 6560-50-C**

Table VI-17 shows the MY 2030 summary for Fiat/Chrysler. Fiat/Chrysler is the only manufacturer which uses cylinder deactivation in their reference fleet, and they are the only manufacturer to use cylinder deactivation as a part of their possible compliance strategy. Under all scenarios, FCA increases their initial cylinder deactivation utilization of 13 percent to 24 percent. Under all scenarios turbo-charged engines are applied to 76 percent of FCA’s fleet by

MY 2030. Other technologies are applied to the FCA equally across all scenarios; 37 percent of their fleet uses VVT and/or VVL, and 64 percent uses 8-speed automatic transmissions under all scenarios.

The additional stringency from Alternative 2 to Alternatives 3-5 results in other increased technology applications in the FCA fleet. Under Alternatives 3-5, the presence of EPS/electrical accessories increases from the 82 percent to the entirety of the FCA fleet. Similarly, increased aerodynamic

improvements increase from 84 percent of the fleet to all of it. Finally, 12v stop-start enters 3 percent of the fleet under Alternatives 3-5. Alternatives 3 and 4 look much the same, except that Alternative 3 is the only alternative to use any (1 percent) SHEV-P2 hybrids. Alternative 5 uses twice as much mass reduction than Alternatives 3-4; it uses 37 percent direct injection versus the 24 percent in Alternatives 2-4. The resulting costs are comparable under Alternatives 3 and 4, and almost 50 percent higher under Alternative 5.

TABLE VI-17—SUMMARY OF IMPACTS ON FIAT/CHRYSLER HD FLEET BY ALTERNATIVE (VS. ALTERNATIVE 1b)

Alternative	2	3	4	5
<b>Alternative Stringency</b>				
Annual Increase in Stringency Beginning in MY 2021 .....	2.0%	2.5%	3.5%	4.0%
Increases Until .....	MY 2025	MY 2027	MY 2025	MY 2025
Total Increase in MY 2030 Stringency Relative to Final Phase 1 Standards <sup>a</sup>	9.6%	15.8%	15.8%	17.6%
<b>Estimated Average Fuel Economy (miles per gallon)</b>				
Required in MY 2030 .....	18.59	19.96	19.96	20.41
Achieved in MY 2030 .....	18.97	20.06	20.04	20.42
<b>Average Fuel Consumption (gallons/100 miles)</b>				
Required in MY 2030 .....	5.38	5.01	5.01	4.9
Achieved in MY 2030 .....	5.27	4.99	4.99	4.9
<b>Estimated Average Greenhouse Gas Emissions (grams per mile)</b>				
CO <sub>2</sub> Required in MY 2030 .....	520	485	485	474
CO <sub>2</sub> Achieved in MY 2030 .....	509	482	482	474
<b>Technology Penetration in MY 2030 (percent)</b>				
VVT and/or VVL .....	37	37	37	37



TABLE VI-17—SUMMARY OF IMPACTS ON FIAT/CHRYSLER HD FLEET BY ALTERNATIVE (VS. ALTERNATIVE 1b)—Continued

Alternative	2	3	4	5
Cylinder Deactivation .....	24	24	24	24
Direct Injection Engine .....	24	24	24	37
Turbo Charged Engine .....	76	76	76	76
8 Speed Auto. Trans. ....	64	64	64	64
EPS, Accessories .....	82	100	100	100
12V Stop-start .....	0	3	3	3
Hybridization .....	0	1	0	0
Aero. Improvements .....	84	100	100	100
<b>Mass Reduction (vs. No-Action)</b>				
Curb Weight Mass Reduction (lb.) .....	29	330	333	694
Mass Reduction (percent of curb weight) .....	0.4	4.6	4.6	9.6

**Note:**

<sup>a</sup>This increase in stringency is based on the estimated percentage change in fuel consumption (gal/100mi) stringency projected by the model for the MY 2030 fleet under the final Phase 2 standards relative to the continuation of Phase 1 standards. Note that if manufacturers' have applied mass reduction to an individual vehicle model in the CAFE model that this will increase the work factor of that vehicle in the model, and make the individual target less stringent. Thus, where any mass reduction is applied in the model, the total increase in stringency of the fleet presented here will be lower than the total stringency increase of the fleet if no mass reduction were applied.

Figures Figure VI-24 and Figure VI-25 show the incremental total and average technology costs for Chrysler/Fiat by model year and regulatory stringency. Chrysler/Fiat shows more technology costs for higher stringency alternatives, with annual technology costs of Alternative 3 approaching Alternative 4 annual technology costs as the Alternative 3 approaches the final stringency level in MY 2027. Under all alternatives Chrysler/Fiat incurs increased technology costs starting in MY 2018 and MY 2025, because they are estimated redesign years. The maximum annual technology costs for Chrysler are \$92M in Alternative 2,

\$213M in Alternative 3, \$227M in Alternative 4, and \$330M in Alternative 5. This results in average technology costs of: \$680, \$1640, \$1690, and \$2460, respectively.

As with Ford, the costs and the rate of increase in costs are significantly different in the MY 2018 timeframe among the alternatives, because MY 2018 is the first estimated model year for redesign, and the next estimated redesign opportunity is in MY 2025. Figure identifies the significant differences in the resources and capital that would be required to implement the technologies required to comply with each of the alternatives—with the

estimated MY 2018 technology cost increases being 48M under Alternative 3, 78M under Alternative 4, and 112M under Alternative 5. NHTSA judges the short lead time would make Alternatives 4 and 5 beyond maximum feasible for FCA because its designs for MY 2018 are nearing completion and substantial resources and very high costs would be required to add another vehicle redesign between MY 2018 and MY 2025 to implement the technologies that would be needed to comply with those alternatives.

**BILLING CODE 6560-50-P**

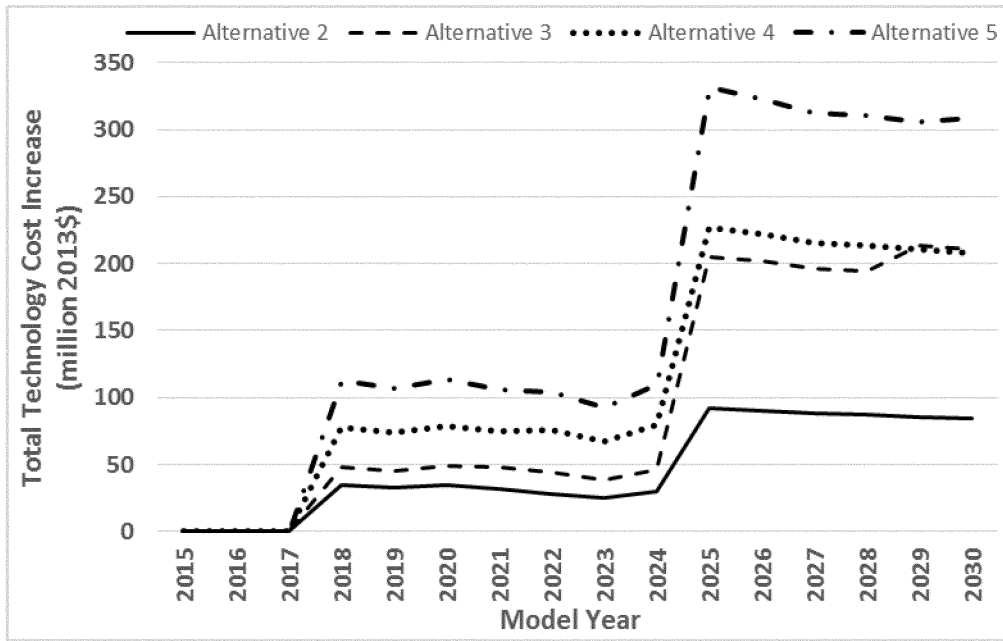

Figure VI-24 Total Technology Cost Increase for Fiat/Chrysler by Model Year and Alternative

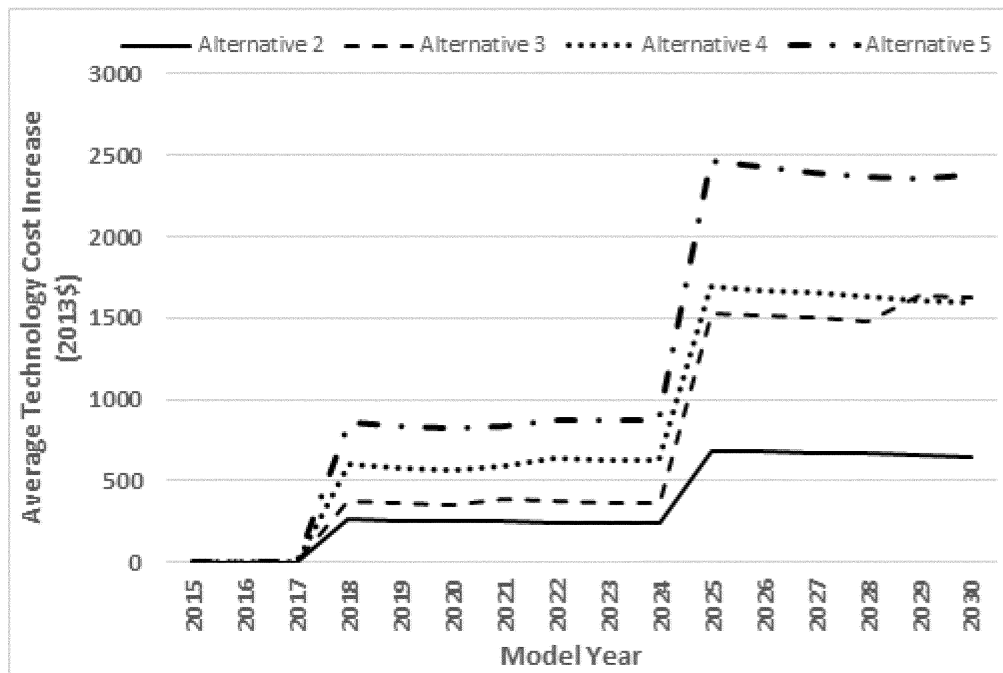

Figure VI-25 Average Technology Cost Increase for Fiat/Chrysler by Model Year and Alternative

The cumulative technology costs attributable to the action alternatives for FCA are represented in Figure VI-26

below. The total costs for MY's 2016–2030 under alter Alternative 2 are \$750 million, under Alternative 3, they are

\$1.5 billion, for Alternative 4, \$1.8 billion, and for Alternative 5 they are \$2.6 billion.

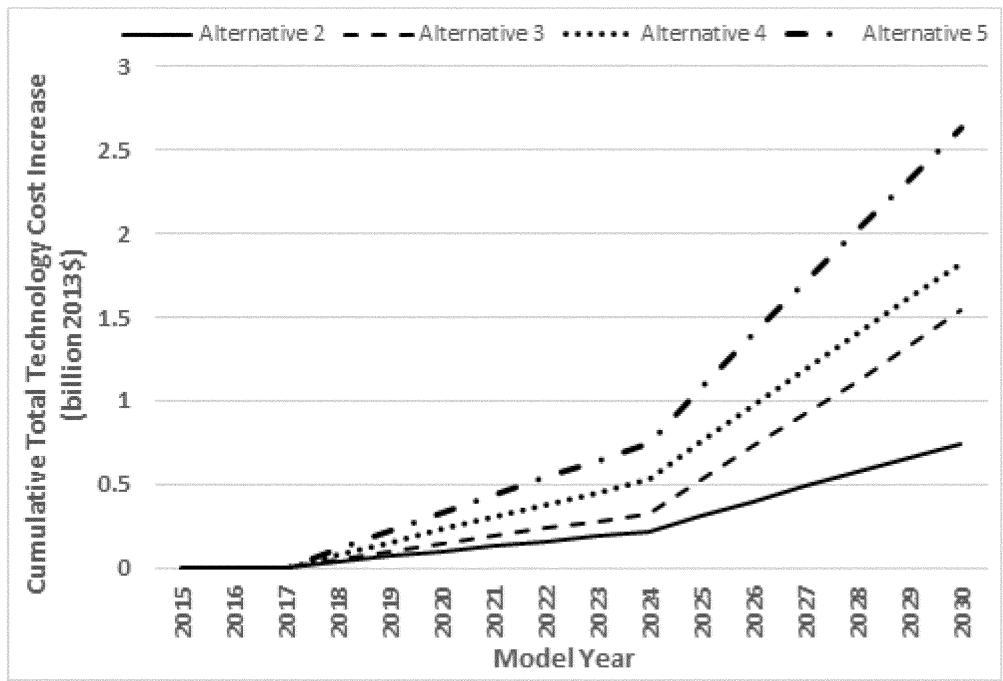

Figure VI-26 Fiat/Chrysler Cumulative Technology Cost Increase by Model Year and Alternative

**BILLING CODE 6560-50-C**

Table VI-18 shows the manufacturer-specific MY 2030 summary for Nissan. Nissan’s 2015 reference fleet uses VVT and/or VVL on all of their heavy-duty vehicles. Their fleet uses two engines on only one body-style platform. As a result, technologies applied to Nissan’s fleet are applied to large proportions of their fleet. Under all scenarios, their entire fleet gains 8-speed automatic transmissions. Under Alternatives 3-5, all of their fleet gets level-2 body-level aerodynamic improvements and all of their fleet gets electric accessory and/or EPS improvements. Under Alternatives 2, 4, and 5, one of Nissan’s two heavy-duty engines gets direct-injection, while under Alternative 3, both engines get the technology. Direct injection of their

entire fleet is the most cost-effective way to reach compliance under Alternative 2, applying 5 percent mass reduction to their entire fleet and direct injection of one of their engines is the most cost-effective strategy under Alternative 4, and applying 10 percent mass reduction to their entire fleet, direct injection to one of their engines, and making their other engine hybrid is the most cost-effective strategy under Alternative 5.

Note that without a change in the work factor or fleet mix, a manufacturer will face the same MY 2030 standard under Alternatives 3 and 4, and a more stringent standard under Alternative 5. However, by applying 5 percent mass reduction in Alternative 4, Nissan is able to reduce their standard by .27

MPG, and by applying 10 percent mass reduction in Alternative 5 to have the same MY 2030 standard under Alternatives 3 and 5. The result is that the CAFE level for Nissan is highest under Alternative 2, where direct injection of their entire fleet is the most cost-effective compliance strategy. We assume that manufacturers are able to make technologies more cost-effectively the longer they are on the market—this is called “learning.” A likely reason that the model prefers direct injection in Alternative 3 but not in Alternatives 4 and 5, is that the longer horizon of the stringency increase (until MY 2027) results in direct injection that is more cost-effective than the shorter time span of Alternatives 4 and 5.

TABLE VI-18—SUMMARY OF IMPACTS ON NISSAN HD FLEET BY ALTERNATIVE (VS. ALTERNATIVE 1b)

Alternative	2	3	4	5
<b>Alternative Stringency</b>				
Annual Increase in Stringency Beginning in MY 2021 .....	2.0%	2.5%	3.5%	4.0%
Increases Until .....	MY 2025	MY 2027	MY 2025	MY 2025
Total Increase in MY 2030 Stringency Relative to Final Phase 1 Standards <sup>a</sup>	9.6%	16.2%	15.1%	16.2%
<b>Estimated Average Fuel Economy (miles per gallon)</b>				
Required in MY 2030 .....	19.65	21.19	20.92	21.19
Achieved in MY 2030 .....	19.63	23.12	21.05	21.46
<b>Average Fuel Consumption (gallons/100 miles)</b>				
Required in MY 2030 .....	5.09	4.72	4.78	4.72
Achieved in MY 2030 .....	5.09	4.32	4.75	4.66

TABLE VI-18—SUMMARY OF IMPACTS ON NISSAN HD FLEET BY ALTERNATIVE (VS. ALTERNATIVE 1b)—Continued

Alternative	2	3	4	5
<b>Estimated Average Greenhouse Gas Emissions (grams per mile)</b>				
CO <sub>2</sub> Required in MY 2030 .....	452	419	425	420
CO <sub>2</sub> Achieved in MY 2030 .....	453	384	422	414
<b>Technology Penetration in MY 2030 (percent)</b>				
VVT and/or VVL .....	100	100	100	100
Cylinder Deactivation .....	0	0	0	0
Direct Injection Engine .....	51	100	51	51
Turbo Charged Engine .....	51	100	51	51
8 Speed Auto. Trans. ....	100	100	100	100
EPS, Accessories .....	37	100	100	100
12V Stop-start .....	0	0	0	49
Hybridization .....	0	0	0	0
Aero. Improvements .....	0	100	100	100
<b>Mass Reduction (vs. No-Action)</b>				
Curb Weight Mass Reduction (lb.) .....	0	0	307	615
Mass Reduction (percent of curb weight) .....	0	0	5	10

**Note:**

<sup>a</sup>This increase in stringency is based on the estimated percentage change in fuel consumption (gal/100mi) stringency projected by the model for the MY 2030 fleet under the final Phase 2 standards relative to the continuation of Phase 1 standards. Note that if manufacturers' have applied mass reduction to an individual vehicle model in the CAFE model that this will increase the work factor of that vehicle in the model, and make the individual target less stringent. Thus, where any mass reduction is applied in the model, the total increase in stringency of the fleet presented here will be lower than the total stringency increase of the fleet if no mass reduction were applied.

Figures Figure VI-27 and Figure VI-28 show the total and average incremental technology costs for Nissan across the different regulatory alternatives. Nissan applies technology in all alternatives in MY 2021; this is a redesign year for much of their fleet. As might be expected, they incur less

technology cost in less stringent scenarios at this redesign. However, under Alternative 3 they apply more technology in MY 2029, making their marginal technology costs under Alternative 3 for MY 2029 and after higher than the marginal technology costs under Alternative 4. They incur

less technology costs in the early years and more in MY's 2029 and beyond. In order to explain why the model predicts this action of Nissan it is useful to look at the cumulative total incremental costs in Figure VI-29.

**BILLING CODE 6560-50-P**

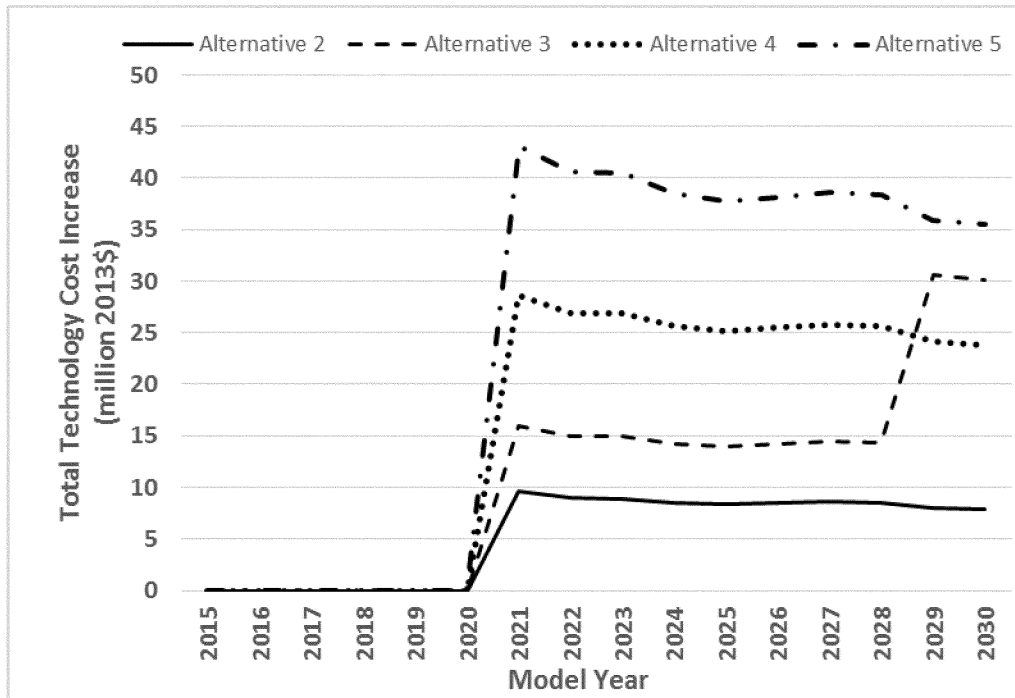

Figure VI-27 Total Technology Cost Increase for Nissan by Model Year and Alternative

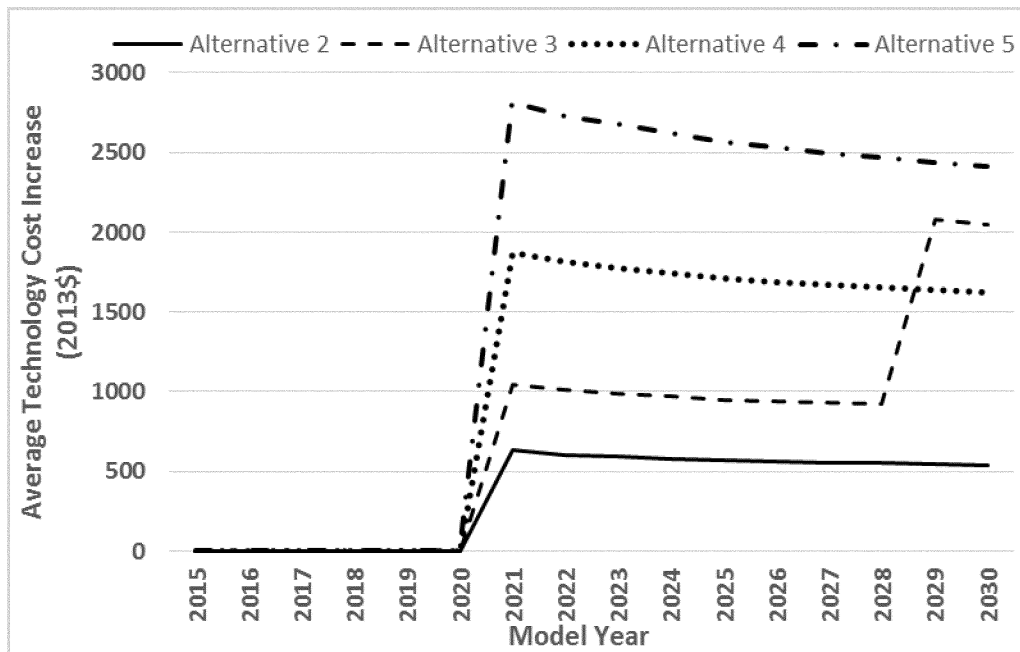

Figure VI-28 Average Technology Cost Increase for Nissan by Model Year and Alternative

By incurring less technology cost early, and more technology cost later, Nissan has a lower cumulative total cost for MY's 2016–2030 under Alternative 3 than Alternative 4. The total cumulative

cost for MY's 2016–2030 of Alternative 2 is \$86 million, \$178 million for Alternative 3, \$258 for Alternative 4, and \$387 for Alternative 5. Since Nissan is trying to minimize their total cost

under all model years, and not their marginal cost under any single model year, the model chooses a compliance strategy in this case which shows higher marginal costs for Nissan in Alternative

3 than 4 for some model years, but

lower cumulative total costs over all model years.

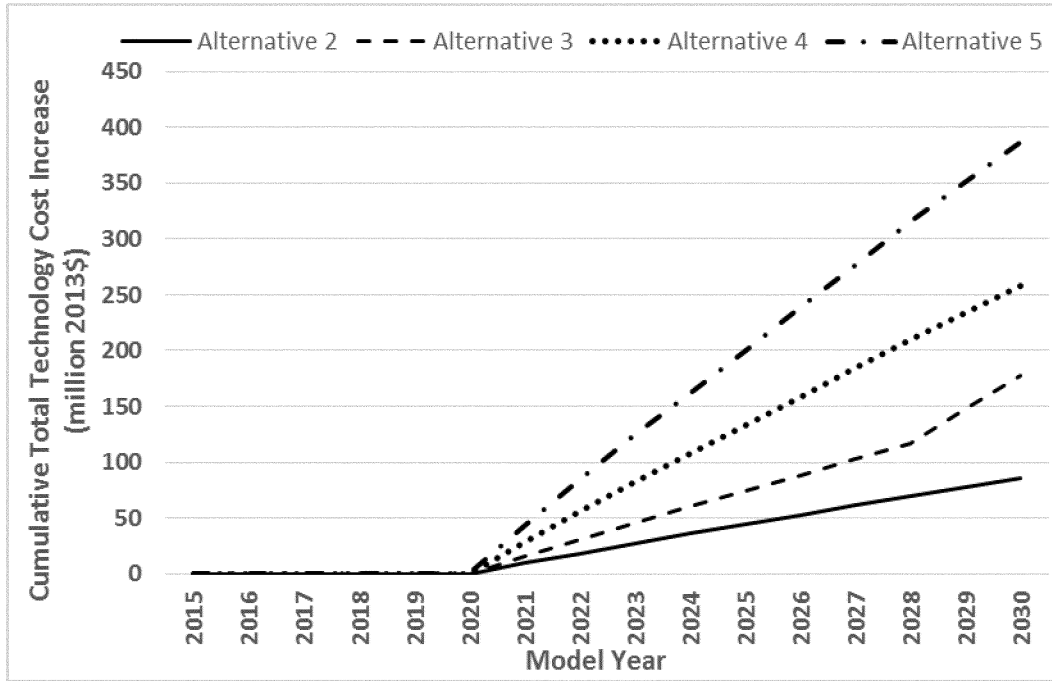

Figure VI-29 Nissan Cumulative Technology Cost Increase by Model Year and Alternative

**BILLING CODE 6560-50-C**

Nissan’s first redesign is in MY 2020, and they do not have another redesign scheduled until 2029. Under Alternative 4 and 5 all of their technological application is done in MY 2020, but under Alternative 3 the application can be spread out between the two redesign cycles. NHTSA judges the short lead time to apply technology would make Alternatives 4 and 5 beyond maximum feasibility for Nissan because it puts the burden of all technological application on the MY 2020 redesign. Substantial

resources and costs would be required to do so or to add another vehicle redesign between MY 2020 and MY 2029. Since manufacturers must spread out their capital for such deployment endeavors between the light and heavy duty fleets, the ability to spread costs between model years is important to consider.

Table VI-19 shows a MY 2030 summary for Daimler. Daimler came into the analysis with all of their fleet using 8-speed automatic transmissions. Their initial CAFE level in MY 2020 of

25.68 was sufficient to meet their standard under Alternatives 2-5. Their only action to turbo-charge all the engines in their fleet occurs in the dynamic baseline. As a result, no additional actions or costs are incurred under any of the alternatives. For this reason, a figure of their annual technology costs, nor their cumulative total technology costs has not been provided—if it were, it would be a horizontal line showing zero costs for all model years.

TABLE VI-19—SUMMARY OF IMPACTS ON DAIMLER HD FLEET BY ALTERNATIVE (VS. ALTERNATIVE 1b)

Alternative	2	3	4	5
<b>Alternative Stringency</b>				
Annual Increase in Stringency Beginning in MY 2021 .....	2.0%	2.5%	3.5%	4.0%
Increases Until .....	MY 2025	MY 2027	MY 2025	MY 2025
Total Increase in Stringency Relative to Final Phase 1 Standards <sup>a</sup> .....	9.7%	16.3%	16.3%	18.4%
<b>Estimated Average Fuel Economy (miles per gallon)</b>				
Required in MY 2030 .....	22.88	24.69	24.69	25.32
Achieved in MY 2030 .....	25.68	25.68	25.68	25.68
<b>Average Fuel Consumption (gallons/100 miles)</b>				
Required in MY 2030 .....	4.37	4.05	4.05	3.95
Achieved in MY 2030 .....	3.89	3.89	3.89	3.89

TABLE VI-19—SUMMARY OF IMPACTS ON DAIMLER HD FLEET BY ALTERNATIVE (VS. ALTERNATIVE 1b)—Continued

Alternative	2	3	4	5
<b>Estimated Average Greenhouse Gas Emissions (grams per mile)</b>				
CO <sub>2</sub> Required in MY 2030 .....	445	413	412	402
CO <sub>2</sub> Achieved in MY 2030 .....	396	396	396	396
<b>Technology Penetration in MY 2030 (percent)</b>				
VVT and/or VVL .....	0	0	0	0
Cylinder Deactivation .....	0	0	0	0
Direct Injection Engine .....	0	0	0	0
Turbo Charged Engine .....	100	100	100	100
8 Speed Auto. Trans. ....	100	100	100	100
EPS, Accessories .....	0	0	0	0
12V Stop-start .....	0	0	0	0
Hybridization .....	0	0	0	0
Aero. Improvements .....	0	0	0	0
<b>Mass Reduction (vs. No-Action)</b>				
Curb Weight Mass Reduction (lb.) .....	0	0	0	0
Mass Reduction (percent of curb weight) .....	0	0	0	0

**Note:**

<sup>a</sup>This increase in stringency is based on the estimated percentage change in fuel consumption (gal/100mi) stringency projected by the model for the MY 2030 fleet under the final Phase 2 standards relative to the continuation of Phase 1 standards. Note that if manufacturers' have applied mass reduction to an individual vehicle model in the CAFE model that this will increase the work factor of that vehicle in the model, and make the individual target less stringent. Thus, where any mass reduction is applied in the model, the total increase in stringency of the fleet presented here will be lower than the total stringency increase of the fleet if no mass reduction were applied.

(5) Summary of Consumer/Operator Impacts

Table VI-20 summarizes the impacts of the regulation on the consumer/operator of the heavy-duty vehicles. Consumers of more fuel efficient vehicles will benefit in several ways: They will spend less on fuel to operate vehicles for the same amount of travel, some will drive more because their per-mile travel costs less, and they will spend less time refueling vehicles. In order to estimate the fuel savings for each regulatory alternative, future gasoline prices must be predicted and the rebound effect (per-mile elasticity of operating a vehicle) must be assumed to account for the cost of additional driving. In the main analysis, the rebound effect is assumed to be 10 percent, so that, for example, a 10 percent reduction in the per-mile travel costs will result in a 1 percent increase in the amount of miles driven. Since the literature has also supported other rebound effects, NHTSA tests several sensitivity cases assuming different rebounds: 5 percent, 15 percent, and 20 percent. Based on the average miles driven of 2b/3 vans and trucks, the expected lifetime fuel savings for a heavy-duty vehicle under the preferred scenario is \$3636.

The other benefits of to the consumer of increasing fuel economy are increased mobility and a decreased amount of time spent refueling the vehicle. Because increasing the

efficiency of a vehicle makes per-mile travel cheaper to the operator, consumers of these vehicles can travel more, at less than the total amount they are willing to pay—this increase in welfare that is not accounted for by the cost of travel is the consumer surplus. The estimated mobility benefit is \$394 under the preferred alternative. The avoided time refueling also has a value. In order to estimate this value we make several assumptions outlined in more detail of the NPRM description of the model assumptions (Section E). Over the lifetime of a MY 2030 vehicle, we estimate the refueling surplus at \$94 under the preferred alternative.

It is also important to note that the average manufacturer costs will not be spread proportionally across the fleet—some vehicles will have incurred more technology costs than others. How manufacturers distribute costs among models will largely depend on the elasticity of particular models and the importance of fleet mix in meeting standards and on total profits. Without privity to this sort of information, we use average technology cost increase as a proxy for measuring the industry and consumer costs across different scenarios. The average technology cost increase is \$1472 under the preferred alternative. We assume that all of this cost will be passed onto the consumer in the form of an increase in price. However, we also consider that an

increase in price will have other costs to the operator of the vehicle.

More expensive vehicles will have higher taxes/fees associated with their purchase, will be more expensive to insure (these costs are related to the purchase price or value of a vehicle) and will be more expensive to finance (higher loan values will be taken out which result in higher amounts paid in total interest). The total additional costs to the average consumer from the sum of these sources is \$589 under the preferred alternative. It is important to keep in mind that the additional cost to finance a more expensive vehicle will have different effects depending on the budget constraint of the consumer. For consumers who are budget-constrained, they will finance more of the vehicle and the costs of financing will be higher for these already-constrained consumers. For consumers who do not have to finance the vehicle, there will be no costs—and therefore, no additional costs—to finance the vehicle. Since budget-constrained consumers likely have a more elastic demand for new vehicles, the increase in price and the heterogeneous increase in financing might work in the same direction to price proportionally more of the most budget-constrained consumers out of the new vehicle market.

Considering all the costs and benefits the standards will have to the consumer, the result is a net benefit to the consumer under all the considered alternatives. The net benefit to the

consumer is \$2,063 under the preferred alternative, higher than the net benefit under alternative 4. The payback period is another measure of the effect of the

rule on consumers—for all alternatives the payback period is under 3 years—suggesting that consumers that own vehicles for at least 3 years will receive

a net benefit from the preferred regulatory action.

TABLE VI-20—SUMMARY OF CONSUMER/OPERATOR IMPACTS FOR MY 2030 (VS. ALTERNATIVE 1b)

Alternative	2	3	4	5
<b>Alternative Stringency</b>				
Annual Increase .....	2.0%	2.5%	3.5%	4.0%
Increases Until .....	MY 2025	MY 2027	MY 2025	MY 2025
<b>Average Value of Lifetime Fuel Savings, \$2013 (vs. No-Action)</b>				
Pretax .....	\$1,713	\$3,256	\$3,229	\$3,804
Tax .....	200	381	377	448
Total .....	1,913	3,636	3,607	4,252
<b>Average Value of Additional Economic Benefits, \$2013 (vs. No-Action)</b>				
Mobility Increase .....	220	394	390	453
Avoided Refueling .....	49	94	93	112
<b>Average New Vehicle Purchase (vs. No-Action)</b>				
Price Increase (\$) .....	496	1,472	1,481	1,893
Additional Costs (\$) <sup>a</sup> .....	103	306	336	393
Payback (months) <sup>b</sup> .....	20	33	33	38
<b>Net Lifetime Consumer/Operator Benefits (vs. No-Action)</b>				
Total Net Benefit (\$) .....	1,488	2,063	1,989	2,167

**Notes:**

<sup>a</sup> Additional Costs include additional taxes, fees, maintenance costs, financing costs, and insurance costs incurred under the regulatory alternatives.

<sup>b</sup> The payback period from the consumer perspective uses a 7% discount rate of retail fuel savings starting at the time of purchase. The cost increases paid back include: Technology costs, maintenance costs, taxes, and fees.

## (6) Summary of Societal Impacts

Table VI-21 summarizes the overall societal impacts of the regulation under different scenarios (relative to the 1b baseline). Net social benefits increase with the stringency of the standards. The net benefits for the preferred alternative are \$18.8 billion. The largest

benefit of the program comes in the form of fuel savings. The fuel savings reported above do not include fuel tax savings, as taxes are considered a transfer, and not a loss, of societal well-being. The fuel savings are associated with a fuel security externality, which monetizes the economic risk associated

with potential fuel price spikes—as fewer gallons of oil are necessary for transportation, this risk decreases. The carbon externality represents the reduced cost of carbon damage when fuel economy increases (and carbon emissions decrease), and is also related directly with fuel savings.

TABLE VI-21—SUMMARY OF LIFETIME TOTAL SOCIETAL IMPACTS OF MY'S 2015–2029 (VS. ALTERNATIVE 1b)

Alternative	2	3	4	5
<b>Alternative Stringency</b>				
Annual Increase .....	2.0%	2.5%	3.5%	4.0%
Increases Until .....	MY 2025	MY 2027	MY 2025	MY 2025
<b>Fuel Purchases vs. No-Action (billion 2013\$)</b>				
Pretax Savings .....	\$11.1	\$17.8	\$20.2	\$22.7
<b>Fuel-Related Externalities vs. No-Action (billion 2013\$)</b>				
Energy Security .....	0.7	1.2	1.4	1.5
CO <sub>2</sub> Emissions .....	2.4	3.8	4.4	4.9
<b>VMT-Related Externalities vs. No-Action (billion 2013\$)</b>				
Driving Surplus .....	1.3	2.0	2.3	2.5
Refueling Surplus .....	0.3	0.6	0.6	0.7
Congestion .....	-0.3	-0.5	-0.5	-0.6
Crashes .....	-0.2	-0.2	-0.3	-0.3



TABLE VI-21—SUMMARY OF LIFETIME TOTAL SOCIETAL IMPACTS OF MY'S 2015–2029 (VS. ALTERNATIVE 1b)—  
Continued

Alternative	2	3	4	5
Noise .....	0.0	0.0	0.0	0.0
Fatalities .....	–0.7	–0.3	–0.4	0.7
Criteria Emissions .....	0.7	1.2	1.4	1.5
<b>Vehicle Purchase/Operating Costs vs. No-Action (billion 2013\$)</b>				
Technology Costs .....	2.9	6.5	7.7	10.2
Maintenance Costs .....	0.1	0.3	0.3	0.5
<b>Cost-Benefit Summary vs. No-Action (billion 2013\$)</b>				
Total Social Cost .....	4.2	7.8	9.2	11.6
Total Social Benefit .....	16.5	26.6	30.3	34.5
Net Social Benefit .....	12.3	18.8	21.1	22.9

Increasing fuel economy decreases the cost of per-mile travel. Since this reduction in the cost of travel results in an increase of total travel, it also results in an increase of externalities associated with increased total VMT. Of these, the driving surplus represents the societal net increase in benefit from increased mobility consumer surplus—the sum of the benefit to all operators of increased travel which is not captured by the total cost of travel. Defined from the societal perspective, the refueling benefit is the sum of all the value of the time saved on refueling by increasing the average fuel efficiency of the heavy duty fleet. Congestion represents the societal cost of increases in congestion on the roads—the lost value of additional time spent in traffic. The crash externality is the cost of the damage done by the additional crashes that will happen with more VMT exposure, and the noise externality represents the cost of a change in noise related to increases in vehicle travel (in this analysis, it is negligible for all alternatives).

Some VMT-related externalities are not always positive or negative, but depend on the stringency of the standards. For this analysis the criteria pollutant externality is always a benefit, but this need not be the case. Reduction in overall fuel consumed reduces emissions associated with production and distribution of fuels. Increases in VMT will result in more emission of vehicle criteria pollutants and more associated damages. However, increasing fuel-economy through vehicle technologies, such as aerodynamics, mass reduction and improved tire rolling resistance, will result in a decrease in vehicle emissions of and damages from criteria pollutants. Shifts

in technologies towards electric and hybrid-electric alternatives can increase the emissions of certain pollutants, and reduce the emissions of others. The stringency increases considered in the heavy-duty analysis do not require these technologies to penetrate the market at such a level that this is visible in the results. For these reasons the externality associated with changes in criteria pollutant emissions is always positive for this analysis.

The vehicle mass reduction in HD pickup and vans is estimated to reduce the net incidence of highway fatalities. By reducing mass on some HD pickup and vans, the fatality rate associated with crashes involving at least one HD pickup or van vehicles decreases. However, the analysis anticipates that the indirect effect of the proposed standards, by reducing the operating costs, would lead to increased travel by HD pickups and vans and, therefore, more crashes involving these vehicles. The sign of the fatality externality varies with the stringency of the standards. Over the lifetime of MY's 2016–2029, for Alternative 2 it is estimated approximately 120 additional fatalities could occur relative to the 30,200 heavy-duty crash-related fatalities in the baseline. For Alternatives 3 and 4 we estimate approximately 50 additional fatalities relative to the no-action alternative. The additional risk of fatality is represented as a social cost in Alternatives 2–4. For Alternative 5 we estimate approximately 110 fewer fatalities (represented as a positive externality). For Alternatives 2–4, the effect of removing mass from the heavier vehicles is less than the effect of increased VMT-exposure; for Alternative 5, it is larger, and the

alternative could result in a decrease of fatalities.

The major direct costs of the program are increased technology costs and costs associated with the resultant increase in new vehicle prices and changes in technologies. The sum of technology costs across the industry increase under all increases of stringency, as do the increases in associated additional costs. Additional costs include: additional costs of maintenance associated with certain technologies. These costs will mostly be borne by the consumer, and paid back in the form of fuel savings.

#### (7) Summary of Environmental Impacts

In addition to modeling the societal impacts from a monetary standpoint, the CAFE model also considers the absolute change in the physical emissions of various criteria pollutants across the Alternatives. Table VI-22 summarizes the total environmental impacts from increased fuel efficiency of MYs 2016–2030, taking into consideration the reduction in emissions from increased efficiency, the additional emissions associated with the increased VMT from cheaper per-mile travel, and changes in emissions due to the production and distribution of heavy-duty vehicles. Across all scenarios, the absolute reduction in emissions increases. For context, the percentage change of emissions relative to the baseline emission levels is also provided. The proportional reduction in criteria pollutants greatly varies; the greenhouse gases—carbon dioxide, methane, and nitrous oxide—as well as the criteria pollutants—sulfur dioxide and diesel particulate matter—show the largest proportional reductions across all scenarios.

TABLE VI-22—SUMMARY OF LIFETIME EMISSION IMPACTS OF MY'S 2015–2029 (VS. ALTERNATIVE 1b)

Alternative	2	3	4	5
Annual Increase .....	2.0%	2.5%	3.5%	4.0%
Increases Until .....	MY 2025	MY 2027	MY 2025	MY 2025
<b>Greenhouse Gas Emissions Reductions vs. No-Action</b>				
CO <sub>2</sub> (mmt) .....	66	107	120	135
CH <sub>4</sub> and N <sub>2</sub> O (tons) .....	97,925	160,044	180,557	202,666
<b>Greenhouse Gas Emissions Percent Reduction vs. No-Action</b>				
CO <sub>2</sub> .....	3.8%	6.1%	6.9%	7.7%
CH <sub>4</sub> and N <sub>2</sub> O .....	0.7%	1.2%	1.3%	1.5%
<b>Other Emissions Absolute Reduction vs. No-Action</b>				
CO (tons) .....	13,747	22,828	26,375	29,589
VOC and NO <sub>x</sub> (tons) .....	33,324	56,100	63,237	70,957
PM <sub>25</sub> (tons) .....	1,320	2,213	2,498	2,806
SO <sub>2</sub> (tons) .....	10,713	17,877	20,172	22,669
Air Toxics (tons) .....	53	75	84	94
Diesel PM <sub>10</sub> (tons) .....	2,357	3,944	4,450	5,004
<b>Other Emissions Percent Reduction vs. No-Action</b>				
CO .....	0.2	0.4	0.4	0.5
VOC and NO <sub>x</sub> .....	1.6	2.8	3.1	3.5
PM <sub>25</sub> .....	1.9	3.3	3.7	4.1
SO <sub>2</sub> .....	3.7	6.2	6.9	7.8
Air Toxics .....	0.2	0.2	0.2	0.3
Diesel PM <sub>10</sub> .....	3.5	5.8	6.5	7.3

#### (8) Sensitivity Analysis Evaluating Different Inputs to the NHTSA CAFE Model

This section describes some of the principal sensitivity results, obtained by running the various scenarios describing the policy alternatives with alternative inputs. OMB Circular A-4 indicates that “it is usually necessary to provide a sensitivity analysis to reveal whether, and to what extent, the results of the analysis are sensitive to plausible changes in the main assumptions and numeric inputs.”<sup>509</sup> Considering this guidance, a number of sensitivity analyses were performed using analysis Method A to examine important assumptions and inputs, including the following, all of which are discussed in greater detail in the accompanying RIA:

1. *Payback Period*: In addition to the 0 and 6 month payback periods discussed above, also evaluated cases involving payback periods of 12, 18, and 24 months.

2. *Fuel Prices*: Evaluated cases involving fuel prices from the AEO 2015 low and high oil price scenarios. (See AEO-Low and AEO-High in the tables).

3. *Fuel Prices and Payback Period*: Evaluated one side case involving a 0 month payback period combined with fuel prices from the AEO 2015 low oil

price scenario, and one side case with a 24 month payback period combined with fuel prices from the AEO 2014 high oil price scenario.

4. *Benefits to Vehicle Buyers*: The main Method A analysis assumes there is no loss in value to owner/operators resulting from vehicles that have an increase in price and higher fuel economy. NHTSA performed this sensitivity analysis assuming that there is a 25, or 50 percent loss in value to owner/operators—equivalent to the assumption that owner/operators will only value the calculated benefits they will achieve at 75, or 50 percent, respectively, of the main analysis estimates. (These are labeled as 75pctOwner/Operator Benefit and 50pctOwner/Operator Benefit.)

5. *7 Pct Discount Rate*: The main analysis results are considered using either a 0 or 3 percent discount rate. We also considered an alternative case where future savings/costs are discounted 7 percent annually.

6. *Value of Avoided GHG Emissions*: Evaluated side cases involving lower and higher valuation of avoided CO<sub>2</sub> emissions, expressed as the social cost of carbon (SCC).

7. *Rebound Effect*: Evaluated side cases involving rebound effect values of 5 percent, 15 percent, and 25 percent. (These are labeled as 05PctReboundEffect,

15PctReboundEffect and 25PctReboundEffect).

8. *ICM-based Markup*: Evaluated a side case using a retail price equivalent (ICM) markup factor.

9. *Mass-Safety Effect*: Evaluated side cases with the mass-safety impact coefficient at the values defining the 5th and 95th percent points of the confidence interval estimated in the underlying statistical analysis. (These are labeled MassFatalityCoeff05pct and MassFatalityCoeff95pct).

10. *VMT Schedules*: Evaluated side cases considering the NHTS considered in the NPRM analysis as a high-VMT case, and another considered schedule as a low-VMT case.

11. *Strong HEVs*: Evaluated a side case in which strong HEVs were excluded from the set of technology estimated to be available for HD pickups and vans through model year 2030. As in Section VI.C. (8), this “no SHEV” case allowed turbocharging and downsizing on all GM vans to provide a lower-cost path for compliance.

Table VI-23, below, summarizes key metrics for each of the cases included in the sensitivity analysis using Method A for the alternative. The table reflects the percent change in the metrics (columns) relative to the main analysis, due to the particular sensitivity case (rows) for the alternative 3. For each sensitivity run, the change in the metric can we

<sup>509</sup> Available at [http://www.whitehouse.gov/omb/circulars\\_a004\\_a-4/](http://www.whitehouse.gov/omb/circulars_a004_a-4/).

described as the difference between the baseline and the preferred alternative for the sensitivity case, minus the

difference between the preferred alternative and the baseline in the main analysis, divided by the difference

between the preferred alternative and the baseline in the main analysis. Or,

$$Table\ Metric = \frac{\Delta_{Alt\ sen\ case} - \Delta_{Alt\ main\ run}}{\Delta_{Alt\ main\ run}} \cdot 100$$

Each metric represents the sum of the impacts of the preferred alternative over the model years 2015–2029, and the

percent changes in the table represent percent changes to those sums. More detailed results for all alternatives are

available in the accompanying RIA Chapter 10.

TABLE VI–23—SENSITIVITY ANALYSIS RESULTS FROM CAFE MODEL IN THE HD PICKUP AND VAN MARKET SEGMENT USING METHOD A AND VERSUS THE DYNAMIC BASELINE, ALTERNATIVE 1b

[2.5% growth in stringency; Cells are percent change from base case]<sup>a</sup>

Sensitivity case	Fuel savings (gallons) (%)	CO <sub>2</sub> savings (MMT) (%)	Fuel savings (\$) (%)	Social costs (\$billion) (%)	Social benefits (\$billion) (%)	Social net benefits (\$billion) (%)
0 Month Payback .....	8.4	8.0	7.7	8.0	7.8	7.7
12 Month Payback .....	-13	-14	-15	-2.8	-14	-19
18 Month Payback .....	-30	-31	-32	-16	-31	-38
24 Month Payback .....	-47	-47	-48	-32	-48	-54
AEO-Low .....	-5.4	-5.8	-31	-19	-26	-29
AEO-High .....	-27	-28	18	-2.8	13	20
AEO-Low, 0 Month Payback .....	35	33	33	42	34	30
AEO-High, 24 Month Payback .....	-50	-50	-51	-37	-51	-57
7pct Discount Rate .....	0.0	0.0	-41	-31	-35	-37
50pct Owner/Operator Benefit .....	0.0	0.0	-50	0.0	-34	-48
75pct Owner/Operator Benefit .....	0.0	0.0	-25	0.0	-17	-24
Low SCC .....	0.0	0.0	0.0	0.0	-11	-16
High SCC .....	0.0	0.0	0.0	0.0	8.2	12
Very High SCC .....	0.0	0.0	0.0	0.0	30	43
5pct Rebound .....	4.6	4.6	4.6	-13	0.37	5.5
15pct Rebound .....	-4.6	-4.6	-4.6	12	-0.37	-5.5
25pct Rebound .....	-14	-14	-14	37	-1.1	-17
5th Percentile Mass Fatality Coefficient ..	0.0	0.0	0.0	-11	0.0	4.6
95th Percentile Mass Fatality Coefficient	0.0	0.0	0.0	15	0.0	-6.0
No SHEV–P2’s .....	0.18	0.29	0.29	-1.3	0.26	0.88
Non-CO <sub>2</sub> eq GHG Values .....	0.0	0.0	0.0	0.0	0.0	0.0
ICM-Based Mark-Up .....	-5.7	-6.0	-6.1	-16	-6.0	-1.8
High VMT .....	8.6	7.4	5.9	0.11	6.2	8.7
Low VMT .....	-7.7	-8.3	-8.0	-14	-7.8	-5.4

**Note:**

<sup>a</sup>For an explanation of analytical Methods A and B, please see Section I.D; for an explanation of the less dynamic baseline, 1a, and more dynamic baseline, 1b, please see Section X.A.1.

For some of the cases for which results are presented above, the sensitivity of results to changes in inputs is simple, direct, and easily observed. For example, changes to valuation of avoided GHG emissions impact only this portion of the estimated economic benefits; manufacturers’ responses and corresponding costs are not impacted. Similarly, a higher discount rate does not affect physical quantities saved (gallons of fuel and metric tons of CO<sub>2</sub> in the table), but reduces the value of the costs and benefits attributable to these standards in an intuitive way. Higher rebound results in fewer volumetric fuel savings and social net benefits, as drivers are assumed to be more responsive in their driving habits

to changes in the cost per mile of travel. Some other cases warrant closer consideration:

First, cases involving alternatives to the reference case involving voluntary over compliance of technologies that pay back in six-months involve different degrees of fuel consumption improvement. Increasing the length of the payback period assumption for voluntary over compliance amounts to increasing fuel economy improvements in the absence of the rule (the baseline), and manufacturers are compelled to add less technology in order to comply with the standards (in the regulatory alternatives). Because all estimated impacts of these standards are shown as incremental values relative to this baseline, longer voluntary over

compliance payback periods correspond to smaller estimates of incremental impacts.

Table VI–24 shows the effect of varying the voluntary over compliance assumption from the consumer perspective. The baseline over-compliance payback period is as described above—the number of months within which a technology must pay back to the consumer in the form of undiscounted retail fuel savings for a manufacturer to voluntarily apply that technology without regulatory action. The incremental per-vehicle technology cost is the average additional cost of technology applied to MY 2030 vehicles under the final regulation (incremental to the baseline) of each sensitivity case. The per-vehicle lifetime fuel savings is

the average lifetime retail value of fuel savings under each sensitivity case discounted at 7 percent annually starting at the time of purchase (MY 2030). Compliance payback period is the number of months of ownership it would take the average consumer to recoup the additional technology costs in discounted fuel savings.<sup>510</sup>

As can be seen, the baseline voluntary over compliance assumption changes how much of the technology costs and fuel savings are attributed to the regulation; both fewer fuel savings and fewer technology costs are attributed to the regulatory alternative as the payback period defining voluntary over compliance increases. Further, because the model only applies the technologies

with the shortest payback periods (the most cost-effective technologies) in the baseline, the fuel savings decrease at a greater proportion than the technology costs. The result is that the payback period of the regulatory alternative increases (and at an increasing rate) as manufacturers are assumed to apply more technology in the baseline.

TABLE VI—24—SENSITIVITY ANALYSIS OF THE VOLUNTARY OVER COMPLIANCE ASSUMPTION ON COMPLIANCE PAYBACK PERIOD AND KEY CONSUMER IMPACTS FOR THE MY 2030 MDHD FLEET

Baseline over-compliance payback (months)	Incremental per-vehicle technology cost	Per-vehicle lifetime fuel savings	Technology cost payback period (months) <sup>a</sup>
0	\$1,471	\$3,966	28
6	1,472	3,636	31
12	1,317	3,031	33
18	1,214	2,556	38
24	944	1,684	45

**Note:**

<sup>a</sup> Here the payback calculation uses a 7% discount rate of retail fuel savings starting at the time of purchase and only considers the additional costs of technology application.

Cases involving different fuel prices similarly involve different degrees of fuel economy improvement in the absence of the standard, as more, or less, improvement occurs as a result of more, or fewer, technologies appearing cost effective to owner/operators. Low fuel prices change the amount of fuel savings for each technology, since the choice in technology application also involves both the size of the cost and the fuel savings, lower fuel prices can change the rank of the technologies. Under low fuel prices, the model applies fewer SHEV-P2's. The result is a reduction in volumetric fuel savings, and an even larger reduction in monetary fuel savings, because the fuel savings are worth less. There is also a reduction in social costs, and social net benefits. Higher fuel prices correspond to reductions in the volumetric fuel savings attributable to these standards as, but lead to increases in the value of fuel saved (and net social benefits) because each gallon saved is worth more when fuel prices are high.

The low price and 0-month payback case leads to a significant increase in volumetric savings compared to the main analysis. Note that the fuel savings are higher than in the 0-month payback case alone. Part of the reason for this is that the lower fuel price case takes into consideration that when fuel prices are lower, consumers buy more heavy-duty vehicles (this is estimated from the

AEO2015 low fuel price case). Another piece of the explanation is that the lower fuel prices result in a different technology cost-effectiveness ranking of technologies, and that the 0 month payback baseline results in no voluntary over compliance in the baseline. Different technologies are picked than in the 0 month pay back sensitivity alone, and the most cost effective that would have been applied in the baseline, are now attributed to the preferred alternative. Similarly, the high price and 24-month payback case results in large reductions to volumetric savings that can be attributed to these standards because more is applied in the baseline. Further, the presence of high fuel prices is not sufficient to lead to increases in either the dollar value of fuel savings or net social benefits.

The case which involves the VIUS-based VMT schedules (the high VMT case) results in greater volumetric fuel and GHG-savings attributable to the standards. Under this case the higher estimate of VMT results in more fuel consumption in the baseline, and a higher absolute change in fuel consumption when fuel-saving technologies are applied in the preferred alternative. These higher amount of gallons saved, results in more monetary fuel savings, comparable social costs, and an increase in overall net social benefits attributed to the standards. The low-VMT schedule, developed as an

alternative to the adopted VMT-schedule from the IHS/Polk odometer readings, results in lower volumetric fuel consumption and GHG reductions under the preferred alternative. Lower VMT estimates result in less fuel consumption in the baseline, and a lower absolute change in fuel consumption under the preferred alternative. This schedule attributes lower costs to the standards—the lower fuel savings under the low-VMT schedule changes the technology application decisions of the model, since fewer fuel savings are considered in measure the cost-effectiveness of technologies. The result is lower absolute technology costs, but also lower social net benefits.

The case which makes SHEV-P2's unavailable involves relatively small increases to volumetric fuel savings and CO<sub>2</sub> reductions—not surprising, since SHEV-P2's play only a minor role in the compliance strategy of the preferred alternative in the Method A central analysis. These small increases in fuel savings are associated with small increases in social benefits, slightly larger proportional increases in social costs, but still result in a small increase in social net benefit.

The case that uses the ICM mark-up methodology rather than the RPE methodology results in a reduction of volumetric fuel savings and GHG reductions. The reduction in fuel

<sup>510</sup> This is based on the VMT schedules of average miles driven by age of MDHD pickups and vans and AEO fuel price projections.

savings is accompanied by a reduction in monetary fuel savings, social benefits, social costs, and social net benefits. This is likely due to shifts in technology applications due to different costs mark-

ups associated with different types of technologies under the ICM mark-up methodology.

If, instead of using the values in the main analysis, each sensitivity case

were itself the main analysis, the costs and benefits attributable to the final rule will be as they appear in Table VI–25, below.

TABLE VI–25—COSTS AND BENEFITS OF STANDARDS FOR MY 2015–2029 HD PICKUPS AND VANS UNDER ALTERNATIVE ASSUMPTIONS

Sensitivity case	Fuel savings (billion gallons)	CO <sub>2</sub> reduction (MMT)	Fuel savings (\$billion)	Social costs (\$billion)	Social benefits (\$billion)	Net social benefits (\$billion)
6 Month Payback .....	9.2	110	18	7.8	27	19
0 Month Payback .....	10	120	19	8.2	28	20
12 Month Payback .....	8.0	92	15	7.3	22	15
18 Month Payback .....	6.4	74	12	6.4	18	12
24 Month Payback .....	4.9	56	9.3	5.2	14	8.5
AEO-Low .....	8.7	100	12	6.1	19	13
AEO-High .....	6.7	77	21	7.3	30	22
AEO-Low, 0 Month Payback .....	12	140	24	11	35	24
AEO-High, 24 Month Payback .....	4.7	53	8.8	4.8	13	8.0
7pct Discount Rate .....	9.2	110	11	5.2	17	12
50pct Owner/Operator Benefit .....	9.2	110	8.9	7.5	17	9.7
75pct Owner/Operator Benefit .....	9.2	110	13	7.5	22	14
Low SCC .....	9.2	110	18	7.5	23	16
High SCC .....	9.2	110	18	7.5	28	21
Very High SCC .....	9.2	110	18	7.5	34	27
5pct Rebound .....	9.7	110	19	6.6	26	20
15pct Rebound .....	8.8	100	17	8.5	26	18
25pct Rebound .....	8.0	92	15	10	26	16
5th Percentile Mass Fatality Coefficient ..	9.2	110	18	6.7	26	19
95th Percentile Mass Fatality Coefficient	9.2	110	18	8.7	26	18
No SHEV–P2’s .....	9.3	110	18	7.5	26	19
Non-CO <sub>2</sub> eq GHG Values .....	9.2	110	18	7.5	26	19
ICM-Based Mark-Up .....	8.7	100	17	6.3	25	18
High-VMT .....	10	110	19	7.6	28	20
Low-VMT .....	8.5	98	16	6.5	24	18

(9) Discussion of the Maximum Feasibility of the Adopted Standards

As noted above, EPCA and EISA require NHTSA to “implement a commercial medium- and heavy-duty on-highway vehicle and work truck fuel efficiency improvement program designed to achieve the maximum feasible improvement” and to establish corresponding fuel consumption standards “that are appropriate, cost-effective, and technologically feasible.”<sup>511</sup> In order to determine which of the regulatory alternatives meets the requirements of the statute NHTSA has considered both the modeling results of “Method A” and comments offered on the proposed rulemaking.

(a) Consideration of Modeling Results

For both the NPRM and the current analysis of potential standards for HD pickups and vans, NHTSA applied NHTSA’s CAFE Compliance and Effects Modeling System (sometimes referred to as “the CAFE model” or “the Volpe model”), which DOT’s Volpe National Transportation Systems Center (Volpe

Center) developed, maintains, and applies to support NHTSA CAFE analyses and rulemakings. NHTSA used this model in its Method A analysis to evaluate regulatory alternatives for Phase 2 standards applicable to HD pickups and vans, and used results of this analysis to inform its selection of the regulatory alternative that will achieve the maximum feasible improvement in HD pickup and van fuel efficiency. This analysis includes several updates to the model and to accompanying inputs, as discussed above in this section.

In the proposal, the agencies proposed to adopt Alternative 3 from among the five regulatory alternatives under consideration.<sup>512</sup> As discussed in the NPRM, the agencies found that Alternative 2 would unduly forego significant fuel savings and avoided GHG emissions, and that Alternative 5 could involve rapid and early cost increases and necessitate significant application of the most advanced technologies considered by the agencies. 80 FR 40494–40495. The agencies have estimated the cost and efficacy of fuel-

saving technologies assuming performance and utility will be held constant or improved. In particular, we have assumed payload will be preserved (and possibly improved via reduced vehicle curb weight); however, some fuel-saving technologies, such as hybrid electric vehicles, could reduce payload via increased curb weight (due to the added electrical machine, batteries and controls, and because of the physical size of those components). If the increase in weight from the hybrid system is not offset with a weight reduction elsewhere in the vehicle, the payload capability will be reduced resulting in lost utility but also an increase in stringency due to changes in work factor. Further, it is also possible that applications such as vans where the advanced technologies of downsized gasoline and diesel engines could be used in conjunction with strong hybridization, extended high power demand resulting from a vehicle at full payload or towing, certain types of hybrid powertrains could experience a temporary loss of towing capacity if the capacity of the hybrid’s energy storage device (e.g., batteries, hydraulic accumulator) is insufficient for the

<sup>511</sup> 49 U.S.C. 32902(k)(2).

<sup>512</sup> These Alternatives are defined in Section C(6).

extended power demand required to maintain expected vehicle speeds.

The Method A analysis shows in the short term, MY 2017–2021 timeframe, that there are significant differences in the rate at which technologies would need to be applied among the alternatives. NHTSA believes the rates of technology application require for Alternatives 4 and 5 are beyond

maximum feasible when considering the availability of manufacturers' resources and capital to implement the technologies in that timeframe, and that Alternatives 4 and 5 would not provide adequate lead time for the industry to fully address reliability considerations.

Like the NPRM analysis (*i.e.* the Method B analysis), Method A indicates Alternative 4 would achieve little benefit

beyond that achieved by Alternative 3. For example, as shown in the following graph of estimated total fuel consumed by HD pickups and vans over time under the various regulatory alternatives, outcomes under Alternative 4 are nearly indistinguishable from those under Alternative 3. By 2030, the two are less than 0.5 percent apart.

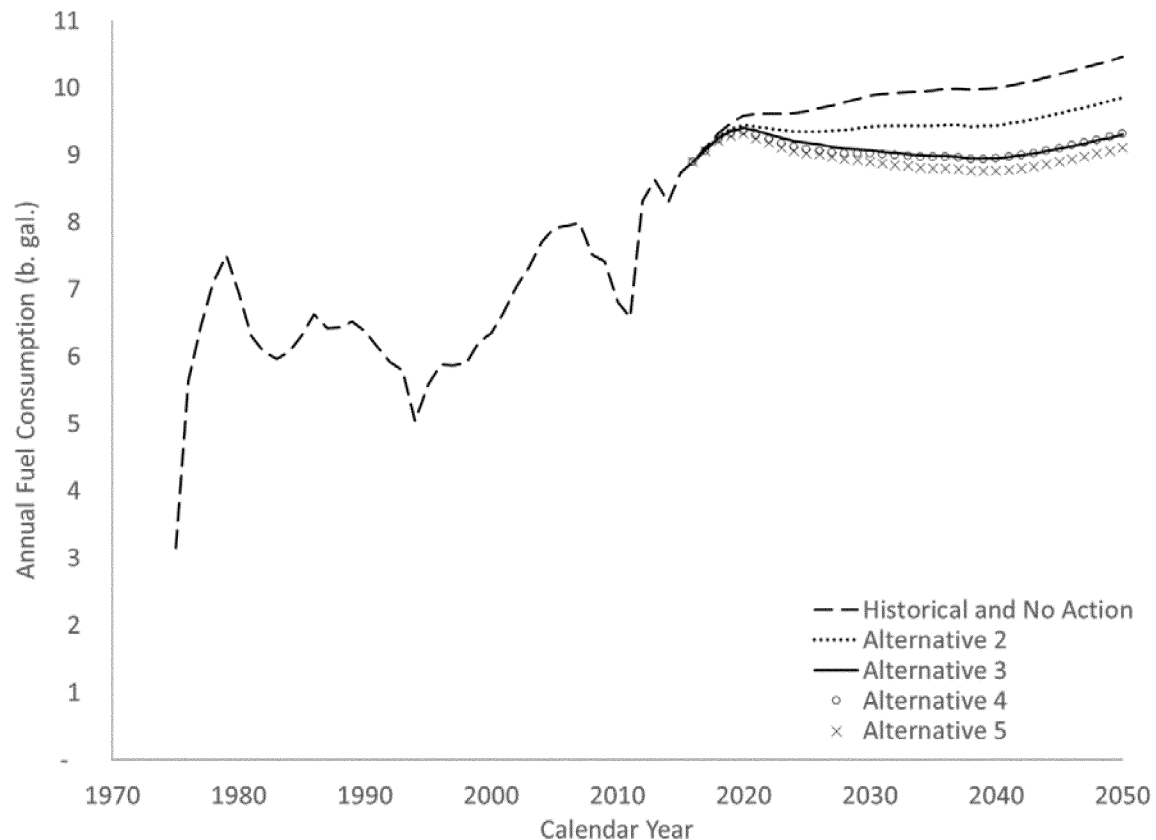

Figure VI-30 Method A Annual Fuel Consumption across Regulatory Alternatives

Weighing against the small additional benefit estimated to be potentially available under Alternative 4, NHTSA also considered the estimated additional costs. Method A analysis shows overall incremental costs (*i.e.*, costs beyond the No Action Alternative) under Alternative 4 to be about 12 percent more than under Alternative 3.

As mentioned above, these estimated differences were mostly small on a relative basis. Averaged over all model years included in the analysis, estimated incremental costs are \$106 higher under Alternative 4 than under Alternative 3. For Daimler and General Motors, there is little or no estimated difference in costs under these two Alternatives. For FCA, Ford, and Nissan, differences are somewhat larger, averaging \$120, \$173, and \$272,

respectively. However, as explained in greater detail above, NHTSA's method A analysis shows considerably greater total and average additional costs in earlier model years under Alternative 4 than under Alternative 3.

Although NHTSA's Method A analysis also indicates that some manufacturers could need to apply additional technology as soon as MY 2016 under baseline standards defining the No-Action Alternative, average estimated costs (versus continuation today's technology) in MY 2017 are two thirds more under Alternative 4 than under the No Action Alternative.

Beyond these directly-estimated costs, the agencies also considered factors beyond those addressed quantitatively in either the NPRM analysis or the updated analysis. In general, these other

factors reflect risk and uncertainty involved with standards for HD pickups and vans. These risks and uncertainty appear considerably greater than for light-duty vehicles. The HD pickup and van market has significantly fewer vehicle models than the light-duty market making forecasting uncertainty a greater risk to compliance. All current manufacturers of HD pickups and vans also produce light-duty vehicles. These manufacturers' light-duty offerings span wide ranges of models, configurations, shared vehicle platforms, engines, transmissions, and design schedules. As a result, if some specific aspects of production do not progress as initially planned for light-duty vehicles (*e.g.*, if mass reduction on some platform does not achieve as much benefit as planned, or if a new engine does not perform as

well as projected, or if limited engineering resources make it necessary to delay a redesign), these manufacturers should have ample opportunity to comply with light-duty CAFE and GHG standards by making

adjustments among other models, platforms, engines, and transmissions. This is not the case for HD pickups and vans. Current HD PUV manufacturers offer products spanning only 1–3 platforms, at most half a dozen engines

or transmissions, and only 1–3 schedules for redesigns. As summarized below, this provides 5–10 times less flexibility than for light-duty vehicles.

TABLE VI–26—MY 2015 BODY AND ENGINE PLATFORMS BY MANUFACTURER FOR LIGHT- AND HEAVY-DUTY PICKUPS

	Platforms		Engines		Transmissions		Design Schedules	
	Light-duty	HD PUV	Light-duty	HD PUV	Light-duty	HD PUV	Light-duty	HD PUV
Daimler .....	12	1	29	2	20	2	18	1
FCA .....	15	3	24	5	21	6	24	3
Ford .....	9	2	22	5	27	3	18	2
General Motors .....	17	2	26	5	39	3	21	2
Nissan .....	6	1	13	2	21	2	23	1

Considering further that credits from other manufacturers are not potentially available as for light-duty vehicles (e.g., several manufacturers currently have excess light-duty CAFE credits that could be traded to other OEMs), this means that overestimating the industry’s capability to improve fuel efficiency and reduce GHG emissions, and consequently setting standards at too stringent of a level, poses a much greater compliance risk for HD PUV fleets than for light-duty fleets. If the factors discussed here, for which the agencies are currently unable to account in our analysis, lead manufacturers to fail to comply with the standards, then the additional benefits of setting standards at slightly more stringent levels would be lost. In the agencies’ judgment, even setting aside the somewhat higher estimated costs under Alternative 4, the very small additional benefit that could be achieved under Alternative 4 do not warrant the increased exposure to this risk.

Regarding Alternative 5, the Method A analysis shows somewhat greater benefits than under Alternatives 3 or 4, but Alternative 5 entails considerably greater costs and dependence on strong hybrid technology, as well as even greater exposure to the above-mentioned uncertainties and risks. Under the Method A analysis for Alternative 5, incremental costs averaged across all model years considered are estimated to be about \$400 higher (about 46 percent) than under Alternative 3, and that analysis shows an overall fleet application of approximately 7 percent strong hybrids, with General Motors applying approximately 13 percent and Ford approximately 7 percent.

We have also assumed that fuel-saving technologies will be no more or less reliable than technologies already in production. However, if there is insufficient lead-time to fully develop

new technologies, they could prove to be less reliable, perhaps leading to increased repair costs and out-of-service time. If the fuel-saving technologies considered here ultimately involve reliability problems, overall costs will be greater than we have estimated. Method A analysis shows in the short term, MYs 2017–2021 timeframe, there are significant differences in the rate at which technologies would need to be applied among the alternatives. Figures VI.15 and VI.16, above, shows the progression in average and total technology costs and the rate of increase in those costs among the alternatives using Method A. They highlight the increases in resources and capital that would be required to implement the technologies required to comply with each of the alternatives, as well as the reduction in lead time to implement the technologies which increases reliability risk. As discussed further above in the manufacturer-specific effects, Ford and FCA are estimated to redesign vehicles in MYs 2017 and 2018 respectively, and vehicle designs for those model years are complete or nearly complete. The next estimated redesign for Ford is in MY 2026, and for FCA in MY 2025, and substantial resources and very high costs would be required to add another vehicle redesign between the estimated redesign model years to implement the technologies that would be needed to comply with those alternatives.

(b) Consideration of Comments

NHTSA proposed that Alternative 3 represented the maximum feasible alternative under EISA, and EPA proposed that Alternative 3 reflected a reasonable consideration of the statutory factors of technology effectiveness, feasibility, cost, lead time, and safety for purposes of CAA sections 202(a)(1) and (2). Although the agencies and commenters also found that Alternative

4 merited serious consideration, the agencies noted that Alternative 3 was generally designed to achieve the levels of fuel consumption and GHG stringency that Alternative 4 would achieve, but with several years of additional lead time, meaning that manufacturers could, in theory, apply new technology at a more gradual pace, with greater reliability and flexibility.

Some comments on the proposal called for adoption of standards more stringent and/or more rapidly advancing in stringency than those defining Alternative 3. For example, CARB argued that Alternative 4 would, compared to Alternative 3, achieve greater benefits comparably attractive in terms of cost effectiveness and while remaining less stringent than CAFE standards for light-duty trucks.<sup>513</sup> UCS provided similar comments, indicating further that the standards should be technology forcing and therefore more aggressive than Alternative 4, they specifically suggested that gasoline vehicles could achieve up to a 23.6 percent improvement in MY 2027 while diesel vehicles can achieve an 18 percent improvement.<sup>514</sup> ACEEE similarly recommended increasing the stringency by 7 percent in MY 2027 and that standards should reflect increased use of cylinder deactivation, cooled EGR, and GDI and turbo downsizing in pickups. For diesels, ACEEE commented that additional reductions were possible, based on an estimate of 10 percent penetration of engine downsizing for pickups and 30 percent penetration for vans in 2027, and also assuming 6 percent penetration of hybrids in diesel vans.

Citing the potential for fuel-saving technology to migrate from light-duty

<sup>513</sup> CARB, Docket No. NHTSA–2014–0132–0125 at pages 52–53.

<sup>514</sup> UCS, Docket No. EPA–HQ–OAR–2014–0827–1329, at pages 23–25.

pickups and vans to heavy-duty pickups and vans, CBD also called for more stringent HD pickup and van standards that would “close the gap” with light-duty standards, as any gap allows manufacturers to essentially choose to classify a pickup as heavy-duty to avoid more stringent requirements if it was classified as a light-duty vehicle.<sup>515</sup> ICCT likewise commented that the proposed standards represent only a 2.2 and 1.6 percent year-over-year improvement for the gasoline and diesel fleets, respectively, from MYs 2014–2025 compared to an almost 3 percent per year improvement for light-duty trucks in the same time frame. ICCT recommended that the agencies’ analysis incorporate the full analysis and inputs from the light-duty rulemaking and that the result would be improvements in the range of 35 percent over the MYs 2014–2025 rather than the proposed 23 percent improvement over this time frame.

On the other hand, some other reviewers commented that the proposed standards could be unduly aggressive considering the products and technologies involved. GM commented that any attempt to force more stringent regulations than proposed, such as Alternative 4, would be extremely detrimental to manufacturers, consumers, the U.S. economy, and the millions of transportation-related jobs. Daimler similarly commented that the proposed standards would be a challenge for automotive manufacturers. Under certain conditions, such a standard may necessitate hybridization of the affected vehicle fleet, which would require substantial development and material costs. All technologies taken into account for the class 2b/3 stringencies should reflect cost effectiveness calculations, especially alternative powertrains such as hybrids, battery, and fuel cell driven electric vehicles. Daimler recommends that the agencies adopt the proposed standard over Alternative 4, as the additional two years of lead-time will be critical for automotive manufacturers in developing the necessary technologies to achieve compliance. Nissan commented that the Alternative 4 3.5 percent per stringency level is simply not feasible, as it does not provide the necessary lead-time to enable manufacturers to balance competitive market constraints with the cost of applying new technologies to a limited product offering. Nissan further commented that to the extent that the more stringent alternative is predicated on the adoption of hybrid and electric

powertrain technology, Nissan does not believe that such technology is feasible for this market segment.

The American Automotive Policy Council (AAPC, representing FCA, Ford, and General Motors) further commented that proposals for greater stringency than Alternative 3 are not supportable given the required early introduction of unproven technologies with their associated consumer acceptance risk, as well as the many implicit risks that impact stringency. AAPC commented that the proposed standards are aggressive and will challenge industry. AAPC noted that the baseline fleet includes a high percentage of advanced diesel technology such as SCR, making additional improvements considerably more challenging. In the light-duty fleet, diesel technology accounts for 3 percent of fleet whereas the heavy-duty fleet consists of over 50 percent diesel.

AAPC also noted that Phase 2 technologies are being used today. For example, FCA’s modern gasoline engine has robust combustion with multiple spark plugs, variable cam phasing, cylinder deactivation, and cooled EGR. AAPC commented that even with this level of gasoline engine technology, FCA is challenged by the early year Phase 1 standards and will need to look at adding even more technology for Phase 2. AAPC also provided data showing that while smaller displacement boosted gasoline engine technology may be applicable in some variants of commercial vans, this technology is not suited for the pickup truck variants in this segment because of customer demands for towing capability. AAPC commented that concurrent stringency increases in Tier 3/LEV III criteria emission requirements will negatively impact CO<sub>2</sub> and fuel consumption. As an alternative to the standards proposed in the NPRM, the American Automotive Policy Council (AAPC, representing FCA, Ford, and General Motors) proposed standards that would achieve the stringency by model year 2027, but that would do so at a more gradual pace.<sup>516</sup> As means of providing flexibility in complying with these standards, AAPC also commented that the agencies should allow credits to be banked for longer than 5 years, and should allow credits to be transferred between the light- and heavy-duty fleets.<sup>517</sup>

<sup>516</sup> AAPC, Docket No. NHTSA–2014–0132–0103 ], at pages 12–13.

<sup>517</sup> AAPC, Docket No. NHTSA–2014–0132–0103 at pages 13–16.

### (c) Determination

Having considered these comments as well as the updated analysis summarized above, NHTSA is adopting standards under which the stringency of fuel consumption standards for HD pickups and vans advance at an annual rate of 2.5 percent during model years 2021–2027 relative to the 2018 MY Phase 1 standard level. In NHTSA’s judgment, this pace of stringency increase will appropriately accommodate manufacturers’ redesign workload and product schedules, especially in light of this sector’s limited product offerings<sup>518</sup> and long product cycles. Given the provided flexibility to carry credits forward (and back) between model years, this approach strikes a balance between, on one hand, meaningful early fuel efficiency improvements and, on the other, providing manufacturers appropriate lead time.

Compared to Alternative 3, Alternative 2 would forego significant cost-efficient opportunities to apply conventional and moderately advanced technology in order to reduce fuel consumption and emissions. Also, although the updated analysis summarized above shows costs for Alternative 3 (as costs incremental to the No Action Alternative) somewhat higher than estimated in the NPRM analysis, the agencies find that under either the Method A or Method B analyses, AAPC’s proposed more gradual progression leading up to MY 2027 would also forego cost-effective improvements which are readily feasible in the lead time provided. Furthermore, the Method A analysis indicates that the standards defining Alternative 3 can likely be met with minimal reliance on hybrid technologies. Considering this, NHTSA also find it unnecessary to extend the lifespan of banked credits or adopt other credit related flexibilities to mitigate the stringency increases under Alternative 3.

### *E. Analysis of the Regulatory Alternatives for HD Pickups and Vans: Method B*

Section 202(a)(1) and (2) of the Clean Air Act require EPA to establish standards for emissions of pollutants from new motor vehicles and engines which emissions cause or contribute to air pollution which may reasonably be anticipated to endanger public health or welfare, which include GHGs. See Section I.E. above. Under section 202(a)(1) and (2), EPA considers such

<sup>518</sup> Manufacturers generally have only one pickup platform and one van platform in this segment.

<sup>515</sup> CBD, Docket No. NHTSA–2014–0132–0101, at pages 8–9.



issues as technology effectiveness, its cost (both per vehicle, per manufacturer, and per consumer), the lead time necessary to implement the technology, and based on this the feasibility and practicability of potential standards; the impacts of potential standards on emissions reductions of both GHGs and non-GHG emissions; the impacts of standards on oil conservation and energy security; the impacts of standards on fuel savings by customers; the impacts of standards on the truck industry; other energy impacts; as well as other relevant factors such as impacts on safety.

As part of the proposed feasibility analysis of potential standards for HD pickups and vans, the agencies applied NHTSA's CAFE Model. The agencies used this model to identify technology pathways that could be used to meet a range of stringencies, based on our projections of technology that will be available in the Phase 2 time frame. The agencies considered these technology pathways and identified the stringency level that will be technology-forcing (*i.e.* reflect levels of stringency based on performance of emerging as well as currently available control technologies) at reasonable cost, and leave manufacturers the flexibility to adopt varying technology paths for compliance and allow adequate lead time to develop, test, and deploy the range of technologies.

As noted in Section I and discussed further below, the analyses consider two versions of the CAFE model, one updated for the NPRM analysis represented here in Method B, and one further updated for the FRM represented in the Method A analysis described in D immediately preceding this section. The results of both versions are reported relative to two baselines, a flat baseline (designated Alternative 1a) where no improvements are modeled beyond those needed to meet Phase 1 standards and a dynamic baseline (designated Alternative 1b) where certain cost-effective technologies (*i.e.*, those that payback within a 6 month period) are assumed to be applied by manufacturers to improve fuel efficiency beyond the Phase 1 requirements in the absence of new Phase 2 standards. NHTSA considered its primary analysis to be based on the more dynamic baseline of Method A, whereas EPA considered the flat baseline of Method B. As shown below and in Sections VII through X, using the two different reference cases has little impact on the results of the analysis and leads to the same conclusion regarding the appropriateness of the Phase 2 standards. As such, the use of different

reference cases corroborates the results of the overall analysis.

For the NPRM, the agencies conducted coordinated and complementary analyses by employing both NHTSA's CAFE model and EPA's MOVES model and other analytical tools to project fuel consumption and GHG emissions impacts resulting from the Phase 2 standards for HD pickups and vans, against both the flat and dynamic baselines. EPA ran its MOVES model for all HD categories, namely tractors and trailers, vocational vehicles and HD pickups and vans, to develop a consistent set of fuel consumption and CO<sub>2</sub> reductions for all HD categories. The MOVES runs followed largely the procedures described above, with some differences. MOVES used the same technology application rates and costs that are part of the inputs, and used cost per vehicle outputs of the CAFE model to evaluate the Phase 2 standards for HD pickup trucks and vans. The agencies note that these two independent analyses of aggregate costs and benefits both support these standards. For the final rule, NHTSA has conducted an analysis using a revised version of the CAFE model, as discussed in Section D. This analysis has been designated Method A. The EPA analysis based on the NPRM version of the CAFE model along with EPA's MOVES model is designated Method B.

As noted earlier, the agencies are adopting as proposed a phase-in schedule of reduction of 2.5 percent per year in fuel consumption and CO<sub>2</sub> levels relative to the 2018 MY Phase 1 standard level, starting in MY 2021 and extending through MY 2027. We continue to believe this phased-in implementation will appropriately accommodate manufacturers' redesign workload and product schedules, especially in light of this sector's limited product offerings<sup>519</sup> and long product cycles. This approach was chosen to strike a balance between meaningful reductions in the early years and providing manufacturers with needed lead time via a gradually accelerating ramp-up of technology penetration. By expressing the phase-in in terms of increasing year to year stringency for each manufacturer, while also providing for credit generation and use (including averaging, carry-forward, and carry-back), we believe our program will afford manufacturers substantial flexibility to satisfy the phase-in through a variety of pathways: The gradual application of technologies across the fleet, greater application

levels on only a portion of the fleet, and a sufficiently broad set of available technologies to account for the variety of current technology deployment among manufacturers and the lowest-cost compliance paths available to each.

EPA did not estimate the cost of implementing these standards immediately in 2021 without a phase-in, but we qualitatively assessed it to be somewhat higher than the cost of the phase-in we are establishing, due to the workload and product cycle disruptions it could cause, and also due to manufacturers' resulting need to develop some of these technologies for heavy-duty applications sooner than or simultaneously with light-duty development efforts. See 75 FR 25451 (May 7, 2010) (documenting types of drastic cost increases associated with trying to accelerate redesign schedules and concluding that "[w]e believe that it would be an inefficient use of societal resources to incur such costs when they can be obtained much more cost effectively just one year later"). On the other hand, waiting until 2027 before applying any new standards could miss the opportunity to achieve meaningful and cost-effective early reductions not requiring a major product redesign. Comments on the phase-in are discussed in Section B.2. and in the Response to Comments document.

As noted above, at proposal, the agencies requested comment in particular on Alternative 4. EPA is not adopting Alternative 4 due to uncertainty regarding whether or not the potential technologies and market penetration rates included in Alternative 4 would be technologically feasible. Alternative 4 would ultimately reach the same levels of stringency as final Phase 2 standards, but would do so with less lead time. As discussed below, this could require application of both different technologies at higher application rates, neither of which may be feasible (or, at the least, reliable implementable) by MY 2025.

Moreover, the two years of additional lead time provided by the final standards compared to Alternative 4 eases compliance burden by having more vehicle redesigns and lower stringency during the phase-in period. As noted above, historically, the vehicles in this segment are typically only redesigned every 6–10 years, so many of the vehicles may not even be redesigned during the timeframe of the stringency increase. In this case, a manufacturer must either make up for any vehicle that falls short of its target through some combination of early compliance, over compliance, credit carry-forward and carry-back, and

<sup>519</sup> Manufacturers generally have only one pickup platform and one van platform in this segment.

redesigning vehicles more frequently. Each of these will increase technology costs to the manufacturers and vehicle purchasers, and early redesigns will significantly increase capital costs and product development costs. Also, the longer implementation time for the final standards means that any manufacturer will have a slightly lower target to meet from 2021–2026 than for the shorter phase-in of Alternative 4, though by 2027 the manufacturers will have the same target in either alternative.

Due to the projected higher technology adoption rates, Alternative 4 is also projected to result in higher costs, and risks of inadequate time to successfully test and integrate new technology, than the standards the agencies are adopting. Moreover, the additional emission reductions and fuel savings predominately occur only during the program phase-in period; from roughly 2030 on, the adopted standards and the pull-ahead alternative are projected to be equivalent from an environmental benefit standpoint. EPA's analysis and responses to comments are discussed in detail below.

In some cases, the Method B (NPRM) version of the model selects strong hybrids as a more cost effective technology over certain other technologies including stop-start and mild hybrid. In other words, strong hybrids are not a technology of last resort in the analysis. Alternative 4 is projected to be met using a significantly higher degree of hybridization including the use of more strong hybrids, compared to the standards the agencies are finalizing. In order to comply with a 3.5 percent per year increase in stringency over MYs 2021–2025, Method B modeling projects that manufacturers would need to adopt more technology compared to the 2.5 percent per year increase in stringency over MYs 2021–2027. The two years of additional lead time provided by the Phase 2 standards reduces the potential number of strong hybrids projected to be used by allowing for other more cost effective technologies to be more fully utilized across the fleet. EPA believes it is technologically feasible to apply this projected amount of hybridization to HD pickups and vans in the lead time provided (*i.e.*, by MY 2027). However, strong hybrids present challenges in this market segment compared to light-duty where there are several strong hybrids already available. EPA does not believe that at this stage there is enough

information about the viability of strong hybrid technology in this vehicle segment to assume that they can be a part of large-volume deployment strategies for regulated manufacturers. For example, EPA believes that hybrid electric technology could provide significant GHG and fuel consumption benefits, but recognize that there is uncertainty at this time over the real world effectiveness of these systems in HD pickups and vans, and over customer acceptance of the technology for vehicles with high GCWR towing large loads. Further, the development, design, and tooling effort needed to apply this technology to a vehicle model is quite large, and might not be cost-effective due to the small sales volumes relative to the light-duty sector.

Additionally, EPA recognizes that sufficient engine horsepower and torque needed to meet towing objectives which are important to pickup truck buyers and accordingly the analysis does not down-size engines in conjunction with hybridization. See Section VI.C.4.iv above. Therefore, with no change projected for engine size, the strong hybrid costs do not include costs for engine changes. In light-duty, the use of smaller engines has an associated cost saving which facilitates much of a hybrid's cost-effectiveness. Section E.2 discusses these issues further, and explains further that the results of the updated CAFE model used in Method A are consistent with these conclusions.

Due to these considerations in the NPRM and in the current Method B analysis, EPA has conducted a sensitivity analysis using the Method B version of the model that assumes the use of no strong hybrids. The results of the analysis are also discussed below. The analysis indicates that there will be a technology pathway that will allow manufacturers to meet the final standards without the use of strong hybrids. However, the analysis indicates that costs will be higher and the cost effectiveness will be lower under the no strong hybrid approach.

EPA also analyzed less stringent standards under which manufacturers could comply by deploying a more limited set of technologies than are needed to meet the Phase 2 standards being adopted. However, our assessment concluded with a high degree of confidence that the technologies on which the final Phase 2 standards are premised will be available at reasonable cost in the 2021–2027 timeframe, and

that the phase-in and other flexibility provisions allow for their application in a very cost-effective manner, as discussed in this section below. Accordingly, it would be inappropriate (within the meaning of CAA section 202(a)(1) and (2)) to adopt standards of lesser stringency.

More difficult to characterize is the degree to which more or less stringent standards might be appropriate because of under- or over-estimating the costs or effectiveness of the technologies whose performance is the basis of the Phase 2 standards. For the most part, these technologies have not yet been applied to HD pickups and vans, even on a limited basis. EPA is therefore relying to some degree on engineering judgment in predicting their effectiveness. Even so, we believe that we have applied this judgment using the best information available, primarily from a NHTSA contracted study at SwRI<sup>520</sup> and our recent rulemaking on light-duty vehicle GHGs and fuel economy, and have generated a robust set of effectiveness values. Chapter 10 of the RIA provides a detailed description of the CAFE Model and the analysis performed for the rule.

#### (1) Consistency of the Phase 2 Standards With the EPA's Legal Authority

Table VI–27 below shows projected technology adoption rates for both the final Phase 2 standards and for a two-year pull ahead of those standards (*i.e.* Alternative 4 from the NPRM). As at proposal, the table shows that the Method B (EPA's central estimate) analysis estimates that the most cost-effective way to meet the final Phase 2 standards will be to use strong hybrids in up to 9.9 percent of pickups and 5.5 percent of vans on an industry-wide basis. The analysis of Alternative 4 shows strong hybrids on up to 19 percent of pickups (and two years sooner). The analysis shows that the two years of additional lead time provided by the Phase 2 standards compared to Alternative 4 will provide manufacturers with a better opportunity to maximize the use of technologies which are more cost effective than strong hybrids over time thereby reducing the need for strong hybrids which may be particularly challenging for this market segment, as well as providing needed time for the more limited deployment of this technology projected under alternative 3 (*i.e.* the Phase 2 standard).

<sup>520</sup> Reinhart, T.E. (June 2015). *Commercial Medium- and Heavy-Duty Truck Fuel Efficiency*

*Technology Study—Report #1.* (Report No. DOT HS

812 146). Washington, DC: National Highway Traffic Safety Administration.

TABLE VI-27—METHOD B CAFE MODEL TECHNOLOGY ADOPTION RATES FOR THE FINAL PHASE 2 STANDARDS RULE AND ALTERNATIVE 4 SUMMARY—FLAT BASELINE

Technology	Phase 2 standards (2.5% per year) 2021 to 2027		Alternative 4 (3.5% per year) 2021 to 2025	
	Pickup trucks %	Vans %	Pickup trucks %	Vans %
Low friction lubricants .....	100	100	100	100
Engine friction reduction .....	100	100	100	100
Cylinder deactivation .....	22	19	22	19
Variable valve timing .....	22	82	22	82
Gasoline direct injection .....	0	63	0	80
Diesel engine improvements .....	60	3.6	60	3.6
Turbo downsized engine .....	0	63	0	63
8 speed transmission .....	98	92	98	92
Low rolling resistance tires .....	100	92	100	59
Aerodynamic drag reduction .....	100	100	100	100
Mass reduction and materials .....	100	100	100	100
Electric power steering .....	100	49	100	46
Improved accessories .....	100	87	100	36
Low drag brakes .....	100	45	100	45
Stop/start engine systems .....	0	0	15	1.5
Mild hybrid .....	0	0	29	15
Strong hybrid .....	9.9	5.5	19	0

As discussed earlier, EPA also conducted a sensitivity analysis using the Method B version of the model to determine a compliance pathway where no strong hybrids would be utilized. Although EPA in this Method B analysis, projects that strong hybrids may be the most cost effective approach, manufacturers may select another compliance path, mainly a 20 percent penetration rate of mild hybrids. This no strong hybrid analysis included the use of downsized turbocharged engines in vans currently equipped with large V-8 engines. Turbo-downsized engines were not allowed on 6+ liter gasoline vans in the primary analysis because EPA sought to preserve consumer choice with respect to vans that have

large V-8s for towing. However, given the recent introduction of vans with considerable towing capacity and turbo-downsized engines, EPA believes it will be feasible for vans in the time-frame of these final rules. The tables below reflect the difference in predicted penetration rates of technologies if strong hybridization is not chosen as a technology pathway. For simplicity, pickup trucks and vans are combined into a single industry wide penetration rate.

The table also shows that when strong hybrids are used as a pathway to compliance, penetration rates of all hybrid technologies would increase substantially between the Phase 2 standards and Alternative 4. The

analysis predicts an increase in strong hybrid penetration from 8 percent to 12 percent, a 23 percent penetration of mild hybrids and a 10 percent penetration stop/start engine systems for Alternative 4 compared with the Phase 2 standards (hence much of the increased projected cost between these options, as explained below). Also, by having the final standards apply in MY 2027 instead of MY 2025, the rule is not premised on use of any mild hybrids or stop/start engine systems. This analysis shows that the few years of additional lead time provided by the Phase 2 standards allows manufacturer's important flexibility in choosing a mix of technologies that is best suited for this market.

TABLE VI-28—CAFE METHOD B MODEL TECHNOLOGY ADOPTION RATES FOR FINAL PHASE 2 STANDARDS AND ALTERNATIVE 4 COMBINED FLEET AND FUELS SUMMARY—FLAT BASELINE

Technology	Phase 2 standards (2.5% per year) 2021 to 2027		Alternative 4 (3.5% per year) 2021 to 2025	
	With strong hybrids %	Without strong hybrids %	With strong hybrids %	Without strong hybrids %
Low friction lubricants .....	100	100	100	100
Engine friction reduction .....	100	100	100	100
Cylinder deactivation .....	21	22	21	14
Variable valve timing .....	46	46	46	46
Gasoline direct injection .....	25	45	31	45
Diesel engine improvements .....	38	38	38	38
Turbo downsized engine <sup>a</sup> .....	25	31	25	31
8 speed transmission .....	96	96	96	96
Low rolling resistance tires .....	97	97	84	84
Aerodynamic drag reduction .....	100	100	100	100
Mass reduction and materials .....	100	100	100	100
Electric power steering .....	80	92	79	79
Improved accessories .....	67	77	75	75

TABLE VI-28—CAFE METHOD B MODEL TECHNOLOGY ADOPTION RATES FOR FINAL PHASE 2 STANDARDS AND ALTERNATIVE 4 COMBINED FLEET AND FUELS SUMMARY—FLAT BASELINE—Continued

Technology	Phase 2 standards (2.5% per year) 2021 to 2027		Alternative 4 (3.5% per year) 2021 to 2025	
	With strong hybrids %	Without strong hybrids %	With strong hybrids %	Without strong hybrids %
Low drag brakes .....	78	93	78	78
Stop/start engine systems .....	0	1	10	4
Mild hybrid .....	0	20	23	66
Strong hybrid .....	8	0	12	0

**Note:**

<sup>a</sup>The 6+ liter V8 vans were allowed to convert to turbocharged and downsized engines in the “without strong hybrid” analysis for both the Rule and the Alternative 4 to provide a compliance path.

The tables Table VI-29 and Table VI-30 below provide a further breakdown of projected technology adoption rates specifically for gasoline-fueled pickups and vans which shows potential adoption rates of strong hybrids for each vehicle type. Strong hybrids are not projected to be used in diesel

applications. The Alternative 4 analysis shows the use of strong hybrids in up to 48 percent of gasoline pickups, depending on the mix of strong and mild hybrids, and stop/start engine systems in 20 percent of gasoline pickups (the largest gasoline HD segment). It is important to again note

that this analysis only shows one pathway to compliance, and the manufacturers may make other decisions, e.g., changing the mix of strong vs. mild hybrids, or applying electrification technologies to HD vans instead.

TABLE VI-29—CAFE METHOD B MODEL TECHNOLOGY ADOPTION RATES FOR FINAL PHASE 2 STANDARDS AND ALTERNATIVE 4 ON GASOLINE PICKUP TRUCKS—FLAT BASELINE

Technology	Phase 2 standards (2.5% per year) 2021 to 2027		Alternative 4 (3.5% per year) 2021 to 2025	
	With strong hybrids %	Without strong hybrids %	With strong hybrids %	Without strong hybrids %
Low friction lubricants .....	100	100	100	100
Engine friction reduction .....	100	100	100	100
Cylinder deactivation .....	56	56	56	56
Variable valve timing .....	56	56	56	56
Gasoline direct injection .....	0	56	0	56
8 speed transmission .....	100	100	100	100
Low rolling resistance tires .....	100	100	100	100
Aerodynamic drag reduction .....	100	100	100	100
Mass reduction and materials .....	100	100	100	100
Electric power steering .....	100	100	100	100
Improved accessories .....	100	100	100	100
Low drag brakes .....	100	100	100	100
Driveline friction reduction .....	44	68	68	68
Stop/start engine systems .....	0	0	20	0
Mild hybrid .....	<sup>a</sup> Up to 42	0	<sup>a</sup> 18–86	86
Strong hybrid .....	Up to 25	.....	Up to 48	

**Note:**

<sup>a</sup>Depending on extent of strong hybrid adoption as hybrid technologies can replace each other, however they will have different effectiveness and costs.

TABLE VI-30—CAFE METHOD B MODEL TECHNOLOGY ADOPTION RATES FOR FINAL PHASE 2 STANDARDS AND ALTERNATIVE 4 ON GASOLINE VANS—FLAT BASELINE

Technology	Phase 2 Standards (2.5% per year) 2021 to 2027		Alternative 4 (3.5% per year) 2021 to 2025	
	With strong hybrids %	Without strong hybrids %	With strong hybrids %	Without strong hybrids %
Low friction lubricants .....	100	100	100	100

TABLE VI-30—CAFE METHOD B MODEL TECHNOLOGY ADOPTION RATES FOR FINAL PHASE 2 STANDARDS AND ALTERNATIVE 4 ON GASOLINE VANS—FLAT BASELINE—Continued

Technology	Phase 2 Standards (2.5% per year) 2021 to 2027		Alternative 4 (3.5% per year) 2021 to 2025	
	With strong hybrids %	Without strong hybrids %	With strong hybrids %	Without strong hybrids %
Engine friction reduction .....	100	100	100	100
Cylinder deactivation .....	23	3	23	3
Variable valve timing .....	100	100	100	100
Gasoline direct injection .....	57	97	97	97
Turbo downsized engine <sup>a</sup> .....	77	97	77	97
8 speed transmission .....	97	97	97	97
Low rolling resistance tires .....	100	100	60	60
Aerodynamic drag reduction .....	100	100	100	100
Mass reduction and materials .....	100	100	100	100
Electric power steering .....	55	85	53	53
Improved accessories .....	23	38	43	43
Low drag brakes .....	53	89	53	100
Stop/start engine systems .....	0	0	2	0
Mild hybrid .....	<sup>b</sup> Up to 13	13	18	40
Strong hybrid .....	Up to 7	.....	0	.....

**Notes:**

<sup>a</sup> The 6+ liter V8 vans were allowed to convert to turbocharged and downsized engines in the “without strong hybrid” analysis for both the Rule and the Alternative 4 to provide a compliance path.

<sup>b</sup> Depending on extent of strong hybrid adoption as hybrid technologies can replace each other, however they will have different effectiveness and costs.

EPA projects a compliance path for these standards showing aggressive implementation of technologies that the agencies consider to be available in the time frame of these rules. See Section VI.C.4. Under this approach, manufacturers are expected to implement these technologies at aggressive adoption rates on essentially all vehicles across this sector by 2027 model year. In the case of several of these technologies, adoption rates are projected to approach 100 percent. This includes a combination of engine, transmission and vehicle technologies as described in this section across every vehicle. The standard also is premised on less aggressive penetration of particular advanced technologies, including strong hybrid electric vehicles.

EPA projects the Phase 2 standards to be achievable within known design cycles, and we believe these standards will allow different paths to compliance in addition to the one we outline and cost here. As discussed below and throughout this analysis, our rule places a high value on the assurance of in use reliability and market acceptance of new technology, particularly in initial model years of the program.

The NPRM analysis did not predict substantial amounts of technology being added before the start of the MY 2021 standards, and in particular, did not project that there would be substantial additions of more advanced

technologies in any redesign cycles occurring before MY 2021. This continues to appear to be a reasonable assumption, since substantial lead time is typically required to develop and implement these advanced technologies. Indeed, as the previous discussion shows (and as discussed again in responding to comments later in this section), it is important to provide two additional years of lead time between MY 2025 and 2027. More recent modeling used to update the NHTSA Method A analysis as described in Section C above allows for technology implementation in pre-2021 model years to both meet the final Phase 1 standards in MY 2018 and to also begin to introduce advanced technologies that will eventually be needed in order to meet the Phase 2 standards. EPA considered this more recent modeling approach with earlier redesign cycles and technology implementation and agrees with NHTSA that this modelling shows that there would be insufficient lead time to adopt the technologies to satisfy the compliance path modelled for Alternatives 4 and 5 in the Method A analysis. See Section VI.D.4 above.

As discussed above, the agencies sought comment on the feasibility and costs associated with the standards being finalized and also on alternative standards. In particular, the agencies sought comment on Alternative 4, which is based on a year-over-year increase in stringency of 3.5 percent in

MYs 2021–2025, essentially pulling ahead the alternative 3 standard stringency by two model years. The agencies received several comments in support of more stringent standards. Several NGOs commented that more stringent standards than proposed are feasible through the additional application of technology and that the standards should more closely align with standards established for light-duty trucks. UCS commented that gasoline vehicles could achieve up to a 23.6 percent improvement in MY 2027 while diesel vehicles can achieve an 18 percent improvement. ACEEE similarly recommended increasing the stringency by 7 percent in MY 2027 and that standards should reflect increased use of cylinder deactivation, cooled EGR, and GDI and turbo downsizing in pickups. For diesels, ACEEE commented that additional reductions were possible, based on an estimate of 10 percent penetration of engine downsizing for pickups and 30 percent penetration for vans in 2027, and also assuming 6 percent penetration of hybrids in diesel vans. ICCT commented that the proposed standards represent only a 2.2 and 1.6 percent year-over-year improvement for the gasoline and diesel fleets, respectively, from MYs 2014–2025 compared to an almost 3 percent per year improvement for light-duty trucks in the same time frame. ICCT recommended that the agencies’ analysis incorporate the full analysis

and inputs from the light-duty rulemaking and that the result would be improvements in the range of 35 percent over the MYs 2014–2025 rather than the proposed 23 percent improvement over this time frame.

The agencies also received comments that any gap between fuel economy requirements for LD and HD pickups for which there is no engineering rationale could produce distortions in the pickup market, shifting sales toward the heavier vehicles. The Center for Biological Diversity similarly commented that closing the gap between large light-duty and heavy-duty pickups and vans is crucial because the overlap in many characteristics allows manufacturers to essentially choose to classify a pickup as “heavy duty” to avoid the more stringent requirements for “light duty” pickups through minor adjustments to the vehicle.

CARB staff commented in support of Alternative 4, commenting that Alternative 4 is technologically feasible, cost-effective and superior to Alternative 3. CARB noted that the Alternative 4 adds only three to 8 months to the payback period. CARB also commented that Alternative 4 remains significantly less stringent than the light-duty truck standards. CARB further commented that Alternative 4 would result in greater emissions and societal benefits than Alternative 3.

The agencies also received several comments opposing setting standards more stringent than those proposed, although none of these commenters opposed the actual proposal. AAPC commented that proposals for greater stringency than Alternative 3 are not supportable given the required early introduction of unproven technologies with their (purportedly) associated consumer acceptance risk, as well as the many implicit risks that impact stringency. AAPC commented that, in their view, the proposed standards are aggressive and will challenge industry. AAPC noted that the baseline fleet (which is over 50 percent diesel) includes a high percentage of advanced diesel technology such as SCR, making additional improvements more challenging. AAPC also noted that Phase 2 technologies are being used today. For example, FCA’s modern gasoline engine has robust combustion with multiple spark plugs, variable cam phasing, cylinder deactivation, and cooled EGR. AAPC commented that even with this level of gasoline engine technology, FCA is challenged by the early year Phase 1 standards and will need to look at adding even more technology for Phase 2. AAPC also provided data showing that while

smaller displacement boosted gasoline engine technology may be applicable in some variants of commercial vans, this technology is not suited for the pickup truck variants in this segment because of customer demands for towing capability. AAPC commented that concurrent stringency increases in Tier 3/LEV III criteria emission requirements will negatively impact CO<sub>2</sub> and fuel consumption.

GM commented that any attempt to force more stringent regulations than proposed, such as Alternative 4, would be extremely detrimental to manufacturers, consumers, the U.S. economy, and the millions of transportation-related jobs. Daimler similarly commented that the proposed standards would be a challenge for automotive manufacturers. According to the commenter, under certain conditions, a more stringent standard than proposed may necessitate hybridization of the affected vehicle fleet, which would require substantial development and material costs. Daimler recommends that EPA adopt the proposed standard over Alternative 4, as the additional two years of lead-time will be critical for automotive manufacturers in developing the necessary technologies to achieve compliance. Nissan commented that Alternative 4 at 3.5 percent per year stringency level is simply not feasible, as it does not provide the necessary lead-time to enable manufacturers to balance competitive market constraints with the cost of applying new technologies to a limited product offering. Nissan further commented that to the extent that the more stringent alternative is predicated on the adoption of hybrid and electric powertrain technology, Nissan does not believe that such technology is feasible for this market segment.

After considering the comments, EPA believes that the Phase 2 final standards that the agencies are adopting represent the most stringent standards reasonably achievable within the MY 2021–2027 period. The standards are based largely on the same technologies projected to be used in the light-duty fleet with appropriate adjustments for the heavy-duty fleet because of their specific higher load duty cycles. As shown in the tables 28 and 29 above and repeated below, several technologies are projected to be used at very high adoption rates at or near 100 percent including mass reduction, 8-speed transmissions, engine friction reduction, low rolling resistant tires, improved accessories, and aerodynamic drag reductions. For gasoline engines, some commenters noted that downsize turbo

engines which are projected to be used extensively in light-duty vehicles should also be relied on in the heavy-duty analysis, including for HD pickups. As discussed in V.I.C.4.vii above, the agencies agree with the comments provided by AAPC that turbo downsizing is likely to be counter-productive in heavy-duty pickups. EPA (and NHTSA in the Method A analysis) thus is projecting the use of downsized turbo engines only for vans. Under heavy loads, turbo downsized engines may have higher CO<sub>2</sub> and fuel consumption than the engine it replaces. For this reason, EPA continues to believe that the technology can only be projected to be available for heavy-duty vans (and not pickups) and, for vans, is projecting its use at 77 to 97 percent. One commenter argued for a standard predicated on a more aggressive penetration rate for cylinder deactivation noting that in the NPRM the agencies only projected cylinder deactivation at an adoption rate of 22 percent of the overall fleet. The commenter believes that an adoption rate of 40 percent would be more appropriate. In response, cylinder deactivation is a gasoline engine technology and EPA is projecting an adoption rate of 56 percent for pickups and an adoption rate of essentially 100 percent for the gasoline engines in vans not projected to be downsized turbo engines (*i.e.* a more aggressive penetration rate than urged by the commenter).

EPA also remains concerned about projecting standards predicated on high levels of hybridization in the heavy-duty pickup and van fleet. Many heavy duty applications need maximum payload and cargo volume which may compete with weight increases and lost cargo volume from hybridization, directly reducing the capability and therefore work factor of the vehicle. Additionally, it is likely not feasible to size a hybridization system to be effective for any high or maximum payload or towing operation without changing the utility of the vehicle. A manufacturer choosing to hybridize a heavy duty vehicle would likely target vans that are primarily used for cargo volumetric capacity reasons where a reasonably sized hybrid system could be incorporated and be effective under typical operation. EPA believes that the final Phase 2 standards will drive the orderly use of technology while still providing enough lead time that manufacturers could meet the standards using technology paths other than high penetration rates of strong hybrids. Thus, the gap in stringency between

light-duty trucks and the Phase 2 standards for HD pickups and vans reflects constraints of the use of some technologies in the heavy-duty market resulting from the intended use of the vehicles to do more work than light-duty trucks.

The proposed rule discussed several considerations that EPA believes remain valid. The NPRM projected that the higher rate of increase in stringency associated with Alternative 4 and the shorter lead time would necessitate the use of a different technology mix under Alternative 4 compared to the Phase 2 standards that the agencies are adopting. The Phase 2 standards are projected to achieve the same final stringency increase as Alternative 4 at about 80 percent of the average per-vehicle cost increase, and without the expected deployment of more advanced technology at high penetration levels. In particular, under EPA's primary analysis, which does not constrain the use of strong hybrids, manufacturers are estimated to deploy strong hybrids in approximately 8 percent of new vehicles (in MY 2027) under the Phase 2 standards, compared to 12 percent under Alternative 4 (in MY 2025). Less aggressive electrification technologies also appear on 33 percent of new vehicles simulated to be produced in MY 2027 under Alternative 4, but are not projected to be necessary under the Phase 2 standards. Additionally, it is important to note that due to the shorter lead time of Alternative 4, there are fewer vehicle refreshes and redesigns during the phase-in period of MY 2021–2025. The longer, shallower phase-in of advanced technologies in the standards that the agencies are adopting allows for more compliance flexibility and closer matching with the vehicle redesign cycles, which (as noted above) can be up to ten years for HD vans. While the Method B CAFE model's algorithm accounts for manufacturers' consideration of upcoming stringency changes and credit carry-forward, the steeper ramp-up of the standard in Alternative 4, coupled with the five-year credit life, results in a prediction that manufacturers would need to take less cost-effective means to comply with the standards compared with the final phase-in period of MY 2021–2027. The public comments from industry commenters confirmed that this is a realistic prediction. For example, the Method B model predicts that some manufacturers will not implement any amount of strong hybrids on their vans during the 2021–2025 timeframe and instead will implement less effective technologies such as mild hybrids at

higher penetration rates. There is also a high degree of sensitivity to the estimated effectiveness levels of individual technologies. At high penetration rates of all technologies on a vehicle, the result of a reduced effectiveness of even a single technology could be non-compliance with the standards. If the standards do not account for this uncertainty, there will be a real possibility that a manufacturer who followed the exact technology path we project will not meet their target because a technology performed slightly differently in their application. In this Method B analysis, EPA considered all comments regarding Alternative 4 and concluded that the longer lead time provided by the Phase 2 standards that the agencies are adopting is necessary as it better matches the redesign cycles for vehicles in this market segment and provides the time necessary for manufacturers to more fully utilize a range of technologies best suited for this market segment. These technologies are projected to be available within the lead time provided under the Phase 2 standards—*i.e.*, by MY 2027, as discussed in RIA Chapter 2.6. These standards will require a relatively aggressive implementation schedule of most of these technologies during the program phase-in. Heavy-duty pickups and vans will need to have a combination of many individual technologies to achieve these standards. These standards are projected to yield significant emission and fuel consumption reductions without requiring a large segment transition to strong hybrids, a technology that while successful in light-duty passenger cars, cross-over vehicles and SUVs, may impact vehicle work capabilities<sup>521</sup> and have questionable customer acceptance in a large portion of this segment dedicated to towing.<sup>522</sup> See discussion above and in Section VI.D.9.

The tables above show that many technologies will be at or potentially approach 100 percent adoption rates according to the analysis. If certain technologies turn out to be not well suited for certain vehicle models or less effective than projected, other technology pathways will be needed.

<sup>521</sup> As noted earlier, hybrid batteries, motors and electronics generally add weight to a vehicle and require more space which can result in conflicts with payload weight and volume objectives.

<sup>522</sup> Hybrid electric systems are not sized for situations when vehicles are required to do trailer towing where the combined weight of vehicle and trailer is 2 to 4 times that of the vehicle alone. During these conditions, the hybrid system will have reduced effectiveness. Sizing the system for trailer towing is prohibitive with respect to hybrid component required sizes and the availability of locations to place larger components like batteries.

The additional lead time provided by the Phase 2 standards reduces these concerns because manufacturers will have more flexibility to implement their compliance strategy and are more likely to do so within a product redesign cycle necessary for many new technologies to be implemented.

The agencies also received comments that the standards should be based exclusively on the GHG capabilities of diesel vehicles. The commenters viewed the separate gasoline and diesel standards as preferential treatment of gasoline-powered vehicles which have inherently higher GHG and fuel consumption. As discussed in Section B.1, the agencies are maintaining the separate gasoline and diesel standards for heavy duty pickups and vans. As discussed earlier, diesel engines are fundamentally more efficient than gasoline engines providing the same power (even gasoline engines with the technologies discussed above) while using less fuel. However, dieselization is not a technology path the agencies included in the analysis for the Phase 1 rule or the Phase 2 rules. Gasoline-powered vehicles account for nearly half of the heavy-duty pickup and van market and are used in applications where a diesel may not make sense from a cost or consumer choice standpoint. Commenters did not address the costs of extensive dieselization.

More stringent standards, including Alternative 4, could result in manufacturers switching from gasoline engines to diesel engines in certain challenging segments. While technologically feasible, EPA remains concerned that this pathway could cause a distortion in consumer choices and significantly increase the cost of those vehicles, particularly considering that more stringent standards are projected to require penetration of some form of hybridization. Also, the agencies did not consider the impact dieselization would have on lead-time, as shifting nearly half the market from gasoline to diesel engines would require substantial retooling of production. Commenters also did not account for the costs or address the feasibility of such retooling in the lead time available under either Phase 2 or Alternative 4. In addition, if dieselization occurs by manufacturers equipping vehicles with larger diesel engines designed for broad coverage of applications typical of this sector rather than “right-sized” engines, the towing capability of the vehicles could increase, resulting in higher work factors for the vehicles, higher targets, and reduced program benefits. Bosch commented that holding gasoline vehicles to the same GHG standards as

diesels would bring the costs of compliance with all emissions standards, including criteria pollutant standards, for gasoline vehicles more in line with diesels, considering the costs of complying with criteria pollutant standards are much higher for diesels compared to gasoline vehicles. In response, EPA's Method B analysis shows that significantly more stringent gasoline vehicle GHG standards may require high levels of hybridization which, as discussed above, may not be acceptable for this market segment. This, in turn, could lead to dieselization, as manufacturers would opt to phase out gasoline-fueled vehicles rather than opt for widespread hybridization of their product offerings. EPA continues to believe that it is reasonable to adopt Phase 2 standards that continue to preserve the opportunity for manufacturers to produce and consumers to choose gasoline-powered vehicles in this market segment.

Based on the information presented here in this Method B analysis, EPA believes that the Phase 2 standards the agencies are finalizing are appropriate within the meaning of CAA section 202(a)(1), for this segment for the model years in question. EPA believes the standards reflect a reasonable consideration of the statutory factors of technology effectiveness, feasibility, cost, lead time, and safety for purposes of CAA sections 202(a)(1) and (2). The

standards are appropriately technology-forcing, predicated on performance of technologies not only currently deployed but those which reasonably can be developed during the phase in period. EPA has indicated how technologies not currently deployed in this sector can be reliably commercialized in the lead time provided by the standard. See above and RIA Chapter 2.5 "Technology Application" where the individual technologies available during the phase-in are described in detail. Note that advanced technologies like strong hybridization will require several years of development prior to commercialization to meet required reliability and durability goals in this sector. As noted, the Method B analysis projects that the additional lead-time provided by the Phase 2 standards allows for the implement CO<sub>2</sub>-reducing technologies without the need for significant hybridization and at a significantly lower cost compared to Alternative 4, as shown in the tables above.

EPA has also carefully considered the costs of the standards. The technologies associated with meeting the Phase 2 standards are estimated to add costs to heavy-duty pickups and vans as shown in Table VI-31 for the flat baseline. These costs are the average fleet-wide incremental vehicle costs relative to a vehicle meeting the MY 2018 standard in each of the model years shown.

Reductions associated with these costs and technologies are considerable, estimated at a 16 percent reduction of fuel consumption and CO<sub>2</sub>eq emissions from the MY 2018 baseline for gasoline and diesel engine equipped vehicles.<sup>523</sup> As shown by the analysis, the long-term cost effectiveness of the rule is similar to that of the Phase 1 HD pickup and van standards (found by the agencies to be highly cost effective, without consideration of payback), and also falls within the range of the cost effectiveness for Phase 2 standards for the other HD sectors.<sup>524</sup> The agencies have already found costs in this range to be cost effective (including for the heavy duty pickup and van sector), independent of the associated fuel savings. 76 FR 57228. EPA reiterates that finding here. Moreover, the cost of controls reflected in potential increased vehicle cost will be fully recovered by the operator due to the associated fuel savings, with a payback period somewhere in the third year of ownership, as shown in Section IX.M of this Preamble. The rules' projected benefits far exceed costs (see IX.K), and costs are actually projected to be negative when fuel savings are considered.

Consistent with EPA's authority under 42 U.S.C. 7521(a) and based on its Method B analysis, EPA is thus finalizing the Phase 2 standards as proposed.

TABLE VI-31—HD PICKUPS AND VANS INCREMENTAL TECHNOLOGY COSTS PER VEHICLE FINAL PHASE 2 STANDARDS VS. FLAT BASELINE

	2018	2019	2020	2021	2022	2023	2024	2025	2026	2027
NPRM (2012\$) .....	\$112	\$104	\$106	\$516	\$508	\$791	\$948	\$1,161	\$1,224	\$1,342
FRM (2013\$) .....	114	105	108	524	516	804	963	1,180	1,244	1,364

(2) HD Pickups and Vans Industry Impacts (Method B)

The analysis fleet provides a starting point for estimating the extent to which manufacturers might add fuel-saving (and, therefore, CO<sub>2</sub>-avoiding) technologies under various regulatory alternatives, including the no-action alternative that defines a baseline against which to measure estimated impacts of new standards. The analysis fleet is a forward-looking projection of production of new HD pickups and vans, holding vehicle characteristics (e.g., technology content and fuel consumption levels) constant at model year 2014 levels, and adjusting

production volumes based on recent DOE and commercially-available forecasts. This analysis fleet includes some significant changes relative to the market characterization that was used to develop the Phase 1 standards applicable starting in model year 2014; in particular, the analysis fleet includes some new HD vans (e.g., Ford's Transit and Fiat Chrysler's Promaster) that are considerably more fuel-efficient than HD vans these manufacturers have previously produced for the U.S. market.

While the Phase 2 standards are scheduled to begin in model year 2021, the requirements they define are likely

to influence manufacturers' planning decisions several years in advance. This is true in light-duty planning, and is accentuated by the comparatively long redesign cycles and small number of models and platforms offered for sale in the 2b/3 market segment. Additionally, manufacturers will respond to the cost and efficacy of available fuel consumption improvements, the price of fuel, and the requirements of the Phase 1 standards that specify maximum allowable average fuel consumption and GHG levels for MY 2014–MY 2018 HD pickups and vans (the final standard for MY 2018 is held constant for model years 2019 and

<sup>523</sup> See Table VI-27.

<sup>524</sup> Analysis using the MOVES model indicates that the cost effectiveness of these standards is \$95

per ton CO<sub>2</sub> eq removed in MY 2030 (RIA Table 7-31), almost identical to the \$90 per ton CO<sub>2</sub> eq removed (MY 2030) which the agencies found to be

highly cost effective for these same vehicles in Phase 1. See 76 FR 57228.



2020). The forward-looking nature of product plans that determine which vehicle models will be offered in the model years affected by these standards lead to additional technology application to vehicles in the analysis fleet that occurs in the years prior to the start of these standards. From the industry perspective, this means that manufacturers will incur costs to comply with these standards in the baseline and that the total cost of the regulations will include some costs that occur prior to their start, and represent incremental changes over a world in which manufacturers will have already modified their vehicle offerings compared to today.

**TABLE VI-32—MY 2021 METHOD B BASELINE COSTS FOR MANUFACTURERS IN 2b/3 MARKET SEGMENT IN THE DYNAMIC BASELINE, OR ALTERNATIVE 1b**

Manufacturer	Average technology cost (\$)	Total cost increase (\$m)
Fiat Chrysler .....	275	27
Daimler .....	18	0
Ford .....	258	78
General Motors	782	191
Nissan .....	282	3
Industry .....	442	300

As Table VI-32 shows, the industry as a whole is expected to add about \$440 of new technology to each new vehicle model by 2021 under the no-action alternative defined by the Phase 1 standards. Reflecting differences in projected product offerings in the analysis fleet, some manufacturers (notably Daimler) are significantly less constrained by the Phase 1 standards than others and face lower cost increases as a result. General Motors (GM) shows the largest increase in average vehicle cost, but results for GM's closest competitors (Ford and Fiat Chrysler) do not include the costs of their recent van redesigns, which are already present in the analysis fleet (discussed in greater detail below).

The above results reflect the assumption that manufacturers having achieved compliance with standards might act as if buyers are willing to pay for further fuel consumption improvements that “pay back” within 6 months (*i.e.*, those improvements whose incremental costs are exceeded by

savings on fuel within the first six months of ownership). It is also possible that manufacturers will choose not to migrate cost-effective technologies to the 2b/3 market segment from similar vehicles in the light-duty market. Resultant technology costs in model year 2021 results for the no-action alternative, summarized in Table VI-33 below, are quite similar to those shown above for the 6-month payback period. Due to the similarity between the two baseline characterizations, results in the following discussion represent differences relative to only the 6-month payback baseline.

**TABLE VI-33—MY 2021 METHOD B BASELINE COSTS FOR HD PICKUPS AND VANS IN THE FLAT BASELINE, OR ALTERNATIVE 1a**

Manufacturer	Average technology cost (\$)	Total cost increase (\$m)
Fiat Chrysler .....	268	27
Daimler .....	0	0
Ford .....	248	75
General Motors	767	188
Nissan .....	257	3
Industry .....	431	292

The results below represent the impacts of several regulatory alternatives, including those defined by the Phase 2 standards, as incremental changes over the baseline, where the baseline is defined as the state of the world in the absence of this regulatory action (but, of course, including the Phase 1 standards). Large-scale, macroeconomic conditions like fuel prices are constant across all alternatives, including the baseline, as are the fuel economy improvements under the no-action alternative defined by the Phase 1 rule that covers model years 2014–2018 and is constant from model year 2018 through 2020. In the baseline scenario, the Phase 1 standards are assumed to remain in place and at 2018 levels throughout the analysis (*i.e.* MY 2030). The only difference between the definitions of the alternatives is the stringency of these standards starting in MY 2021 and continuing through either MY 2025 or MY 2027, and all of the differences in outcomes across alternatives are attributable to differences in the standards.

The standards vary in stringency across regulatory alternatives (1–5), but

as discussed above, all of the standards are based on the curve developed in the Phase 1 standards that relate fuel economy and GHG emissions to a vehicle's work factor. The alternatives considered here represent different rates of annual increase in the curve defined for model year 2018, growing from a 0 percent annual increase (Alternative 1, the baseline or “no-action” alternative) up to a 4 percent annual increase (Alternative 5). Table VI-34 shows a summary<sup>525</sup> of outcomes by alternative incremental to the baseline (Alternative 1b) for Model Year 2030<sup>526</sup>, with the exception of technology penetration rates, which are absolute.

The technologies applied as inputs to the CAFE model (in either its Method B or A iterations) have been grouped (in most cases) to give readers a general sense of which types of technology are applied more frequently than others, and are more likely to be offered in new class 2b/3 vehicles once manufacturers are fully compliant with the standards in the alternative. Model year 2030 was chosen to account for technology application that occurs once the standards have stabilized, but manufacturers are still redesigning products to achieve compliance—generating technology costs and benefits in those model years. The summaries of technology penetration are also intended to reflect the relationship between technology application and cost increases across the alternatives. The table rows present the degree to which specific technologies are predicted to be present in new class 2b and class 3 vehicles in 2030, and correspond to: Variable valve timing (VVT) and/or variable valve lift (VVL), cylinder deactivation, direct injection, engine turbocharging, 8-speed automatic transmissions, electric power-steering and accessory improvements, micro-hybridization (which reduces engine idle, but does not assist propulsion), full hybridization (integrated starter generator or strong hybrid that assists propulsion and recaptures braking energy), and aerodynamic improvements to the vehicle shape. In addition to the technologies in the following tables, there are some lower-complexity technologies that have high market penetration across all the alternatives and manufacturers; low rolling-resistance tires, low friction lubricants, and reduced engine friction are examples.

<sup>525</sup> NHTSA generated hundreds of outputs related to economic and environmental impacts, each available technology, and the costs associated with the rule. A more comprehensive treatment of these outputs appears in Chapter 10 of the RIA.

<sup>526</sup> As noted above, the NHTSA CAFE model estimates that redesign schedules will “straddle” model year 2027, the latest year for which the agencies are increasing the stringency of fuel consumption and GHG standards. Considering also

that today's analysis estimates some earning and application of “carried forward” compliance credits, the model was run extending the analysis through model year 2030.

TABLE VI-34—SUMMARY OF HD PICKUPS AND VANS ALTERNATIVES' IMPACT ON INDUSTRY VERSUS THE DYNAMIC BASELINE, ALTERNATIVE 1b; METHOD B

Alternative	2	3	4	5
Annual Stringency Increase .....	2.0%/y	2.5%/y	3.5%/y	4.0%/y
Stringency Increase Through MY .....	2025	2027	2025	2025
Total Stringency Increase .....	9.6%	16.2%	16.3%	18.5%
<b>Average Fuel Economy (miles per gallon)</b>				
Required .....	19.04	20.57	20.57	21.14
Achieved .....	19.14	20.61	20.83	21.27
<b>Average Fuel Consumption (gallons/100 mi.)</b>				
Required .....	5.25	4.86	4.86	4.73
Achieved .....	5.22	4.85	4.80	4.70
<b>Average Greenhouse Gas Emissions (g/mi)</b>				
Required .....	495	458	458	446
Achieved .....	491	458	453	444
<b>Technology Penetration (%)</b>				
VVT and/or VVL .....	46	46	46	46
Cylinder Deac. ....	29	21	21	21
Direct Injection .....	17	25	31	32
Turbocharging .....	55	63	63	63
8-Speed AT .....	67	96	96	97
EPS, Accessories .....	54	80	79	79
Stop Start .....	0	0	10	13
Hybridization <sup>a</sup> .....	0	8	35	51
Aero. Improvements .....	36	78	78	78
<b>Mass Reduction (vs. No-Action)</b>				
CW (lb.) .....	239	243	325	313
CW (%) .....	3.7	3.7	5.0	4.8
<b>Technology Cost (vs. No-Action)</b>				
Average (\$) <sup>b</sup> .....	578	1,348	1,655	2,080
Total (\$) <sup>c</sup> .....	437	1,019	1,251	1,572
Payback period (m) <sup>c</sup> .....	25	31	34	38

**Notes:**<sup>a</sup> Includes mild hybrids (ISG) and strong HEVs.<sup>b</sup> Values used in Methods A & B<sup>c</sup> Values used in Method A, calculated using a 3% discount rate.

In general, as stated above, the Method B model projected that the standards will cause manufacturers to produce HD pickups and vans that are lighter, more aerodynamic, and more technologically complex across all the alternatives. As Table VI-34 shows, there is a difference between the relatively small increases in required fuel economy and average incremental technology cost between the alternatives, suggesting that the challenge of improving fuel consumption and CO<sub>2</sub> emissions accelerates as stringency increases (*i.e.*, that there may be a “knee” in the relationship between technology cost and reductions in fuel consumption/GHG emissions).

The contrast between alternatives 3 and 4 is even more prominent, with an

identical required fuel economy improvement projected to lead to price increases greater than 20 percent based on the more rapid rate of increase and shorter time span of Alternative 4, which achieves all of its increases by MY 2025 while Alternative 3 continues to increase at a slower rate until MY 2027. Despite these differences, the increase in average payback period when moving from Alternative 3 to Alternative 4 to Alternative 5 is fairly constant at around an additional three months for each jump in stringency.

Manufacturers offer few models, typically only a pickup truck and/or a cargo van, and while there are a large number of variants of each model, the degree of component sharing across the variants can make diversified technology application either

economically impractical or impossible. This forces manufacturers to apply some technologies more broadly in order to achieve compliance than they might do in other market segments (passenger cars, for example). This difference between broad and narrow application—where some technologies must be applied to entire platforms, while some can be applied to individual model variants—also explains why certain technology penetration rates decrease between alternatives of increasing stringency (cylinder deactivation or mass reductions in Table VI-34, for example). For those cases, narrowly applying a more advanced (and costly) technology can be a more cost effective path to compliance and lead to reductions in the amount of

lower-complexity technology that is applied.

As noted in Section E.1 above, one driver of the change in technology cost between Alternative 3 and Alternative 4 in the Method B analysis is the amount of hybridization projected to result from the implementation of the standards. While only about 5 percent full hybridization (defined as either integrated starter-generator or strong hybrid) is expected to be needed to comply with Alternative 3, the higher rate of increase and compressed schedule moving from Alternative 3 to

Alternative 4 is enough to increase the percentage of the fleet adopting full hybridization by a factor of two. To the extent that manufacturers are concerned about introducing hybrid vehicles in the 2b and 3 market, it is worth noting that new vehicles subject to Alternative 3 achieve the same fuel economy as new vehicle subject to Alternative 4 by 2030, with less full hybridization projected under this Method B analysis as being needed to achieve the improvement.

The alternatives also lead to important differences in outcomes at the manufacturer level, both from the

industry average and from each other. General Motors, Ford, and Fiat Chrysler, are expected to have approximately 95 percent of the 2b/3 new vehicle market during the years that these standards are being phased in. Due to their importance to this market and the similarities between their model offerings, these three manufacturers are discussed together and a summary of the way each is impacted by the standards appears below in Table VI–35, Table VI–36 and Table VI–37 for General Motors, Ford, and Fiat Chrysler, respectively.

TABLE VI–35—SUMMARY OF IMPACTS ON GENERAL MOTORS BY 2030 IN THE HD PICKUP AND VAN MARKET VERSUS THE DYNAMIC BASELINE, ALTERNATIVE 1b

Alternative	2	3	4	5
Annual Stringency Increase .....	2.0%/y	2.5%/y	3.5%/y	4.0%/y
Stringency Increase Through MY .....	2025	2027	2025	2025
<b>Average Fuel Economy (miles per gallon)</b>				
Required .....	18.38	19.96	20	20.53
Achieved .....	18.43	19.95	20.24	20.51
<b>Average Fuel Consumption (gallons/100 mi.)</b>				
Required .....	5.44	5.01	5	4.87
Achieved .....	5.42	5.01	4.94	4.87
<b>Average Greenhouse Gas Emissions (g/mi)</b>				
Required .....	507	467	467	455
Achieved .....	505	468	461	455
<b>Technology Penetration (%)</b>				
VVT and/or VVL .....	64	64	64	64
Cylinder Deac. ....	47	47	47	47
Direct Injection .....	18	18	36	36
Turbocharging .....	53	53	53	53
8-Speed AT .....	36	100	100	100
EPS, Accessories .....	100	100	100	100
Stop Start .....	0	0	2	0
Hybridization .....	0	19	79	100
Aero. Improvements .....	100	100	100	100
<b>Mass Reduction (vs. No-Action)</b>				
CW (lb.) .....	325	161	158	164
CW (%) .....	5.3	2.6	2.6	2.7
<b>Technology Cost (vs. No-Action)</b>				
Average (\$) <sup>a</sup> .....	785	1,706	2,244	2,736
Total (\$m, undiscounted) <sup>b</sup> .....	214	465	611	746

**Notes:**

<sup>a</sup> Values used in Methods A & B.

<sup>b</sup> Values used in Method A, calculated at a 3% discount rate.

TABLE VI–36—SUMMARY OF IMPACTS ON FORD BY 2030 IN THE HD PICKUP AND VAN MARKET VERSUS THE DYNAMIC BASELINE, ALTERNATIVE 1b

Alternative	2	3	4	5
Annual Stringency Increase .....	2.0%/y	2.5%/y	3.5%/y	4.0%/y
Stringency Increase Through MY .....	2025	2027	2025	2025

TABLE VI-36—SUMMARY OF IMPACTS ON FORD BY 2030 IN THE HD PICKUP AND VAN MARKET VERSUS THE DYNAMIC BASELINE, ALTERNATIVE 1b—Continued

Alternative	2	3	4	5
<b>Average Fuel Economy (miles per gallon)</b>				
Required .....	19.42	20.96	20.92	21.51
Achieved .....	19.5	21.04	21.28	21.8
<b>Average Fuel Consumption (gallons/100 mi.)</b>				
Required .....	5.15	4.77	4.78	4.65
Achieved .....	5.13	4.75	4.70	4.59
<b>Average Greenhouse Gas Emissions (g/mi)</b>				
Required .....	485	449	450	438
Achieved .....	482	447	443	433
<b>Technology Penetration (%)</b>				
VVT and/or VVL .....	34	34	34	34
Cylinder Deac. ....	18	0	0	0
Direct Injection .....	16	34	34	34
Turbocharging .....	51	69	69	69
8-Speed AT .....	100	100	100	100
EPS, Accessories .....	41	62	59	59
Stop Start .....	0	0	20	29
Hybridization .....	0	2	14	30
Aero. Improvements .....	0	59	59	59
<b>Mass Reduction (vs. No-Action)</b>				
CW (lb.) .....	210	202	379	356
CW (%) .....	3.2	3	5.7	5.3
<b>Technology Cost (vs. No-Action)</b>				
Average (\$) <sup>a</sup> .....	506	1,110	1,353	1,801
Total (\$m, undiscounted) <sup>b</sup> .....	170	372	454	604

**Notes:**<sup>a</sup> Values used in Methods A & B.<sup>b</sup> Values used in Method A, calculated at a 3% discount rate.

TABLE VI-37—SUMMARY OF IMPACTS ON FIAT CHRYSLER BY 2030 IN THE HD PICKUP AND VAN MARKET VERSUS THE DYNAMIC BASELINE, ALTERNATIVE 1b

Alternative	2	3	4	5
Annual Stringency Increase .....	2.0%/y	2.5%/y	3.5%/y	4.0%/y
Stringency Increase Through MY .....	2025	2027	2025	2025
<b>Average Fuel Economy (miles per gallon)</b>				
Required .....	18.73	20.08	20.12	20.70
Achieved .....	18.83	20.06	20.10	20.70
<b>Average Fuel Consumption (gallons/100 mi.)</b>				
Required .....	5.34	4.98	4.97	4.83
Achieved .....	5.31	4.99	4.97	4.83
<b>Average Greenhouse Gas Emissions (g/mi)</b>				
Required .....	515	480	479	466
Achieved .....	512	481	480	467
<b>Technology Penetration (%)</b>				
VVT and/or VVL .....	40	40	40	40
Cylinder Deac. ....	23	23	23	23
Direct Injection .....	17	17	17	17
Turbocharging .....	74	74	74	74
8-Speed AT .....	65	88	88	88
EPS, Accessories .....	0	100	100	100

TABLE VI-37—SUMMARY OF IMPACTS ON FIAT CHRYSLER BY 2030 IN THE HD PICKUP AND VAN MARKET VERSUS THE DYNAMIC BASELINE, ALTERNATIVE 1b—Continued

Alternative	2	3	4	5
Stop-Start .....	0	0	0	0
Hybridization .....	0	3	3	10
Aero. Improvements .....	0	100	100	100
<b>Mass Reduction (vs. No-Action)</b>				
CW (lb.) .....	196	649	648	617
CW (%) .....	2.8	9.1	9.1	8.7
<b>Technology Cost (vs. No-Action)</b>				
Average (\$) <sup>a</sup> .....	434	1,469	1,486	1,700
Total (\$m, undiscounted) <sup>b</sup> .....	48	163	164	188

**Notes:**

<sup>a</sup> Values used in Methods A & B.

<sup>b</sup> Values used in Method A, calculated at a 3% discount rate.

The fuel consumption and GHG standards require manufacturers to achieve an average level of compliance, represented by a sales-weighted average across the specific targets of all vehicles offered for sale in a given model year, such that each manufacturer will have a unique required consumption/emissions level determined by the composition of its fleet, as illustrated above. However, there are more interesting differences than the small differences in required fuel economy levels among manufacturers. In particular, the average incremental technology cost increases with the stringency of the alternative for each manufacturer, but the size of the cost increase from one alternative to the next varies among them, with General Motors showing considerably larger increases in cost moving from Alternative 3 to Alternative 4, than from either Alternative 2 to Alternative 3 or Alternative 4 to Alternative 5. Ford is estimated to have more uniform cost increases from each alternative to the next, in increasing stringency, though still benefits from the reduced pace and longer period of increase associated with Alternative 3 compared to Alternative 4.

The Method B simulation results show all three manufacturers facing cost increases when the stringency of the standards move from 2.5 percent annual increases over the period from MY 2021–2027 to 3.5 percent annual increases from MY 2021–2025, but General Motors has the largest at 75 percent more than the industry average price increase for Alternative 4. GM also faces higher cost increases in Alternative 2 about 50 percent more than either Ford or Fiat Chrysler. And for the most stringent alternative considered, EPA estimates that General

Motors will face average cost increases of more than \$2,700, in addition to the more than \$700 increase in the baseline—approaching nearly \$3,500 per vehicle over today’s prices.

Technology choices also differ by manufacturer, and some of those decisions are directly responsible for the largest cost discrepancies. For example, in this Method B analysis, GM is estimated to engage in the least amount of mass reduction among the Big 3 after Phase 1, and much less than Fiat Chrysler, but reduces average vehicle mass by over 300 lbs. in the baseline—suggesting that some of GM’s easiest Phase 1 compliance opportunities can be found in lightweighting technologies. Similarly, Fiat Chrysler is projected to apply less hybridization than the others, and much less than General Motors, which is simulated in Alternative 4 to have full hybrids (either integrated starter generator or complete hybrid system) on all of its fleet by 2030, nearly 20 percent of which will be strong hybrids, and the strong hybrid share decreases to about 18 percent in Alternative 5, as some lower level technologies are applied more broadly. Because the analysis applies the same technology inputs and the same logic for selecting among available opportunities to apply technology, the unique situation of each manufacturer determined which technology path is projected as the most cost-effective.

In order to understand the differences in incremental technology costs and fuel economy achievement across manufacturers in this market segment, it is important to understand the differences in their starting position relative to these standards. One important factor, made more obvious in the following figures, is the difference between the fuel economy and

performance of the recently redesigned vans offered by Fiat Chrysler and Ford (the Promaster and Transit, respectively), and the more traditionally-styled vans that continue to be offered by General Motors (the Express/Savannah). In MY 2014, Ford began the phase-out of the Econoline van platform, moving those volumes to the Euro-style Transit vans (discussed in more detail in Section VI.D.2). The Transit platform represents a significant improvement over the existing Econoline platform from the perspective of fuel economy, and for the purpose of complying with the standards, the relationship between the Transit’s work factor and fuel economy is a more favorable one than the Econoline vans it replaces. Since the redesign of van offerings from both Fiat Chrysler and Ford occur in (or prior to) the 2014 model year, the costs, fuel consumption improvements, and reductions of vehicle mass associated with those redesigns are included in the analysis fleet, meaning they are not carried forward as part of the compliance modeling exercise. By contrast, General Motors is simulated to redesign their van offerings after 2014, such that there is a greater potential for these vehicles to incur additional costs attributable to new standards, unlike the costs associated with the recent redesigns of their competitors. The inclusion of these new Ford and Fiat Chrysler products in the analysis fleet is the primary driver of the cost discrepancy between GM and its competitors in both the baseline and Alternative 2 in this Method B analysis, when Ford and Fiat Chrysler have to apply considerably less technology to achieve compliance.

The remaining 5 percent of the 2b/3 market is attributed to two manufacturers, Daimler and Nissan,

which, unlike the other manufacturers in this market segment, only produce vans. The vans offered by both manufacturers currently utilize two engines and two transmissions, although both Nissan engines are gasoline engines and both Daimler engines are diesels. Despite the logical grouping, these two manufacturers are

projected to be impacted much differently by these standards. For the least stringent alternative considered, Daimler is projected to add no technology and incurs no incremental cost in order to comply with the standards. At stringency increases greater than or equal to 3.5 percent per year, Daimler only really improves some

of their transmissions and improves the electrical accessories of its Sprinter vans. By contrast, Nissan's starting position is much weaker and their compliance costs closer to the industry average in Table VI-34. This difference could increase if the analysis fleet supporting the final rule includes forthcoming Nissan HD pickups.

TABLE VI-38—SUMMARY OF IMPACTS ON DAIMLER BY 2030 IN THE HD PICKUP AND VAN MARKET VERSUS THE DYNAMIC BASELINE, ALTERNATIVE 1b

Alternative	2	3	4	5
Annual Stringency Increase .....	2.0%/y	2.5%/y	3.5%/y	4.0%/y
Stringency Increase Through MY .....	2025	2027	2025	2025
<b>Average Fuel Economy (miles per gallon)</b>				
Required .....	23.36	25.19	25.25	25.91
Achieved .....	25.23	25.79	25.79	26.53
<b>Average Fuel Consumption (gallons/100 mi.)</b>				
Required .....	4.28	3.97	3.96	3.86
Achieved .....	3.96	3.88	3.88	3.77
<b>Average Greenhouse Gas Emissions (g/mi)</b>				
Required .....	436	404	404	393
Achieved .....	404	395	395	384
<b>Technology Penetration (%)</b>				
VVT and/or VVL .....	0	0	0	0
Cylinder Deac. ....	0	0	0	0
Direct Injection .....	0	0	0	0
Turbocharging .....	44	44	44	44
8-Speed AT .....	0	44	44	100
EPS, Accessories .....	0	0	0	0
Stop-Start .....	0	0	0	0
Hybridization .....	0	0	0	0
Aero. Improvements .....	0	0	0	0
<b>Mass Reduction (vs. No-Action)</b>				
CW (lb.) .....	0	0	0	0
CW (%) .....	0	0	0	0
<b>Technology Cost (vs. No-Action)</b>				
Average (\$) <sup>a</sup> .....	0	165	165	374
Total (\$m, undiscounted) <sup>b</sup> .....	0	4	4	9

**Notes:**

<sup>a</sup> Values used in Methods A & B.

<sup>b</sup> Values used in Method A, calculated at a 3% discount rate.

TABLE VI-39—SUMMARY OF IMPACTS ON NISSAN BY 2030 IN THE HD PICKUP AND VAN MARKET VERSUS THE DYNAMIC BASELINE, ALTERNATIVE 1b

Alternative	2	3	4	5
Annual Stringency Increase .....	2.0%/y	2.5%/y	3.5%/y	4.0%/y
Stringency Increase Through MY .....	2025	2027	2025	2025
<b>Average Fuel Economy (miles per gallon)</b>				
Required .....	19.64	21.19	20.92	21.46
Achieved .....	19.84	21.17	21.19	21.51
<b>Average Fuel Consumption (gallons/100 mi.)</b>				
Required .....	5.09	44.72	4.78	4.66

TABLE VI-39—SUMMARY OF IMPACTS ON NISSAN BY 2030 IN THE HD PICKUP AND VAN MARKET VERSUS THE DYNAMIC BASELINE, ALTERNATIVE 1b—Continued

Alternative	2	3	4	5
Achieved .....	5.04	4.72	4.72	4.65
<b>Average Greenhouse Gas Emissions (g/mi)</b>				
Required .....	452	419	425	414
Achieved .....	448	419	419	413
<b>Technology Penetration (%)</b>				
VVT and/or VVL .....	100	100	100	100
Cylinder Deac. ....	49	49	49	49
Direct Injection .....	51	51	51	100
Turbocharging .....	51	51	51	50
8-Speed AT .....	0	51	51	51
EPS, Accessories .....	0	100	100	100
Stop-Start .....	0	0	0	0
Hybridization .....	0	0	0	28
Aero. Improvements .....	0	100	100	100
<b>Mass Reduction (vs. No-Action)</b>				
CW (lb.) .....	0	0	307	303
CW (%) .....	0	0	5	4.9
<b>Technology Cost (vs. No-Action)</b>				
Average (\$) <sup>a</sup> .....	378	1,150	1,347	1,935
Total (\$m, undiscounted) <sup>b</sup> .....	5	15.1	17.7	25.4

**Notes:**

<sup>a</sup> Values used in Methods A & B.

<sup>b</sup> Values used in Method A, calculated at a 3% discount rate.

As Table VI-38 and Table VI-39 show, Nissan is projected to apply more technology than Daimler in the less stringent alternatives and significantly more technology with increasing stringency. The Euro-style Sprinter vans that comprise all of Daimler’s model offerings in this segment put Daimler in a favorable position. However, those vans are already advanced—containing downsized diesel engines and advanced aerodynamic profiles. Much like the Ford Transit vans, the recent improvements to the Sprinter vans occurred outside the scope of the compliance modeling so the costs of the improvements are not captured in the analysis.

Although Daimler’s required fuel economy level is much higher than Nissan’s (in miles per gallon), Nissan starts from a much weaker position than Daimler and must incorporate additional engine, transmission, platform-level technologies (e.g., mass reduction and aerodynamic improvements) in order to achieve compliance. In fact, more than 25 percent of Nissan’s van offerings are projected to contain integrated starter generators by 2030 in Alternative 5.

While the model does not allow sales volumes for any manufacturer (or model) to vary across regulatory

alternatives in the analysis, it is conceivable that under the most stringent alternatives individual manufacturers could lose market share to their competitors if the prices of their new vehicles rise more than the industry average without compensating fuel savings and/or changes to other features.

*F. Compliance and Flexibility for HD Pickup and Van Standards*

(1) Averaging, Banking, and Trading

The Phase 1 program established substantial flexibility in how manufacturers can choose to implement EPA and NHTSA standards while preserving the benefits for the environment and for energy consumption and security. Primary among these flexibilities are the gradual phase-in schedule, and the corporate fleet average approach which encompasses averaging, banking and trading described below. See Section IV.A. of the Phase 1 Preamble (76 FR 57238) for additional discussion of the Phase 1 averaging, banking, and trading and Section IV.A (3) of the Phase 1 Preamble (76 FR 57243) for a discussion of the credit calculation methodology.

Manufacturers in this category typically offer gasoline and diesel

versions of HD pickup and van vehicle models. The agencies established chassis-based Phase 1 standards that are equivalent in terms of stringency for gasoline and diesel vehicles and are continuing this same approach to stringency for Phase 2. In Phase 1, the agencies established that HD pickups and vans are treated as one large averaging set that includes both gasoline and diesel vehicles<sup>527</sup> and the agencies will maintain this averaging set approach for Phase 2, as discussed above in Section VI.B.

As explained in Section II.C.(3) of the Phase 1 Preamble (76 FR 57167), and in Section VI.B (3) above, the program is structured so that final compliance is determined at the end of each model year, when production for the model year is complete. At that point, each manufacturer calculates production-weighted fleet average CO<sub>2</sub> emission and fuel consumption rates along with its production-weighted fleet average standard. Under this approach, a manufacturer’s HD pickup and van fleet that achieves a fleet average CO<sub>2</sub> or fuel consumption level better than its

<sup>527</sup> See 40 CFR 1037.104(d) and the proposed 40 CFR 86.1819-14(d). Credits may not be transferred or traded between this vehicle averaging set and loose engines or other heavy-duty categories, as discussed in Section I.

standard will be allowed to generate credits. Conversely, if the fleet average CO<sub>2</sub> or fuel consumption level does not meet its standard, the fleet will incur debits (also referred to as a shortfall).

A manufacturer whose fleet generates credits in a given model year will have several options for using those credits to offset emissions from other HD pickups and vans. These options include credit carry-back, credit carry-forward, and credit trading within the HD pickup and van averaging set. These types of credit provisions also exist in the light-duty 2012–2016 and 2017–2025 MY vehicle rules, as well as many other mobile source standards issued by EPA under the CAA. The manufacturer will be able to carry back credits to offset a deficit that had accrued in a prior model year and was subsequently carried over to the current model year, with a limitation on the carry-back of credits to three model years. After satisfying any need to offset pre-existing deficits, a manufacturer may bank remaining credits for use in future years, with a limitation on the carry-forward of credits to five model years. Averaging vehicle credits with engine credits or between vehicle weight classes is not allowed, as discussed in Section I. The agencies did not propose and are not adopting any changes to any of these provisions for the Phase 2 program.

While the agencies proposed to retain 5 year carry-forward of credits for all HD sectors, the agencies requested comment on the merits of a temporary credit carry-forward period of longer than 5 years for HD pickups and vans, allowing Phase 1 credits generated in MYs 2014–2019 to be used through MY 2027. 80 FR 40388. The agencies received several comments regarding credit carry-forward. AAPC commented that manufacturers should be allowed to carry-forward credits indefinitely until they are used to offset a deficit. AAPC commented that longer credit life better aligns with the longer redesign cycles and the smaller production volumes for HD vehicles compared to light-duty vehicles. AAPC also commented that longer credit life would motivate earlier introduction of technology and lower compliance costs, while not changing the overall effectiveness of the program. Nissan and Daimler commented in support of a one-time credit carry-forward that would allow Phase 1 credits to be used through MY 2027. The UAW also generally supported extended credit carry-forward. The agencies also received comments from CARB that the agencies should not allow Phase 1 credits to be carried forward into Phase 2. CARB commented that Phase 1 credits should be limited to

a three year carry-forward or MY 2020 whichever is sooner. CARB is concerned that Phase 1 credits may reduce the efficacy of the Phase 2 program and delay technology development progress.

As noted above, the agencies are retaining the 5 year credit carry-forward provisions as proposed for HD pickups and vans. As discussed in Section VI.C., the agencies believe that the standards are feasible without extending the credit carry-forward provisions. The agencies continue to believe that credit carry-forward provides important flexibility to manufacturer especially in transitioning to more stringent standards and restricting the provision could be disruptive to manufacturer product plans. However, the agencies understand CARB's concerns regarding Phase 1 credits being used to postpone technology progress if some manufacturers were to accumulate large credit banks under Phase 1. Large banks of Phase 1 credits combined with unlimited credit-forward could have the unintended effect of allowing some manufacturers to delay the application of Phase 2 technologies. The 5 year credit carry-forward preserves needed flexibility for transitioning to more stringent Phase 2 standards while also helping to address concerns regarding delaying the introduction of technology in Phase 2 for HD pickups and vans. As discussed in Section I.C.(1)(b)(i), the agencies are extending credit life for certain vocational vehicle subcategories during the transition to the Phase 2 standards. We are doing this for two reasons. First, some manufacturers in these in categories do not have diversified production, which limits the extent to which they can use ABT. Second, the Phase 1 program offer little opportunity for manufacturers to build up their credit balances. Neither of these reasons apply for HD pickups and vans.

As discussed in Section VI.B.4., EPA and NHTSA are changing the HD pickup and van useful life for GHG emissions and fuel consumption from the current 11 years/120,000 miles to 15 years/150,000 miles to make the useful life for GHG emissions consistent with the useful life of criteria pollutants recently updated in the Tier 3 rule. As shown in the Equation VI.1 credits calculation formula below, established by the Phase 1 rule, useful life in miles is a multiplicative factor included in the calculation of CO<sub>2</sub> and fuel consumption credits. In order to ensure banked credits maintain their value in the transition from Phase 1 to Phase 2, NHTSA and EPA proposed and are finalizing an adjustment factor of 1.25 (i.e., 150,000 ÷ 120,000) for credits that are carried forward from Phase 1 to the

MY 2021 and later Phase 2 standards. Without this adjustment factor, the change in useful life would effectively result in a discount of banked credits that are carried forward from Phase 1 to Phase 2, which is not the intent of the change in the useful life. Consider, for example, a vehicle configuration with annual sales of 1,000 vehicles that was 10 g/mile below the standard. Under Phase 1, those vehicles would generate 1,200 Mg of credit (10 × 1,000 × 120,000 ÷ 1,000,000). Under Phase 2, the same vehicles would generate 1,500 Mg of credit (10 × 1,000 × 150,000 ÷ 1,000,000). The agencies do not believe that this adjustment results in a loss of program benefits because there is little or no deterioration anticipated for CO<sub>2</sub> emissions and fuel consumption over the life of the vehicles. Also, as described in the standards and feasibility sections above, the carry-forward of credits is an integral part of the program, helping to smoothing the transition to the new Phase 2 standards. The agencies believe that effectively discounting carry-forward credits from Phase 1 to Phase 2 is unnecessary and could negatively impact the feasibility of the Phase 2 standards.

Equation VI.1 Total Model Year Credit (Debit) Calculation

$$\text{CO}_2 \text{ Credits (Mg)} = [(\text{CO}_2 \text{ Std} - \text{CO}_2 \text{ Act}) \times \text{Volume} \times \text{UL}] \div 1,000,000$$

$$\text{Fuel Consumption Credits (gallons)} = (\text{FC Std} - \text{FC Act}) \times \text{Volume} \times \text{UL} \times 100$$

Where:

CO<sub>2</sub> Std = Fleet average CO<sub>2</sub> standard (g/mi)

FC Std = Fleet average fuel consumption standard (gal/100 mile)

CO<sub>2</sub> Act = Fleet average actual CO<sub>2</sub> value (g/mi)

FC Act = Fleet average actual fuel consumption value (gal/100 mile)

Volume = the total production of vehicles in the regulatory category

UL = the useful life for the regulatory category (miles)

Manufacturers provided comments in support of applying the adjustment factor discussed above. CARB recommended not including the adjustment factor. CARB commented that the adjustment would take benefits achieved under the Phase 1 program and allow them to be used to reduce the potential benefits of Phase 2 standards. The agencies do not view the 1.25 adjustment as reducing the benefits of the program because the adjustment to the Phase 1 credits is completely offset by the increase in the useful life used in the Phase 2 credits calculation shown above. In other words, when the Phase 1 credits are used in Phase 2, 1.25 times more credits will be needed to cover a deficit than would be needed under



Phase 1. The agencies continue to believe this is a reasonable and indeed, necessary, way to address the change in useful life as it applies to the credits calculations.

## (2) Advanced Technology Credits

The Phase 1 program included on an interim basis advanced technology credits for MYs 2014 and later in the form of a multiplier of 1.5 for the following technologies:

- Hybrid powertrain designs that include energy storage systems
- Waste heat recovery
- All-electric vehicles
- Fuel cell vehicles

The advanced technology credit program is intended to encourage early development of technologies that are not yet commercially available. This multiplier approach means that each advanced technology vehicle will count as 1.5 vehicles in a manufacturer's compliance calculation.<sup>528</sup> The advanced technology multipliers were included on an interim basis in the Phase 1 program and the incentive multipliers included for Phase 1 and the 1.5 multiplier incentive adopted for Phase 1 will end beginning in MY 2021, when the more stringent Phase 2 standards are to begin phase-in. However, the agencies are including new incentive multipliers for Phase 2 for PHEVs, EVs, and fuel cell vehicles.

As discussed in Section I, the agencies requested comment on whether or not the incentive multiplier credits should be extended to later model years for more advanced technologies such as EVs and fuel cell vehicles. These technologies are not projected to be part of the technology path used by manufacturers to meet the Phase 2 standards for HD pickups and vans. EV and fuel cell technologies will presumably need to overcome the highest hurdles to commercialization for HD pickups and vans in the time frame of the final rules, and also have the potential to provide the highest level of benefit. The agencies received several comments encouraging the agencies to continue advanced technology multipliers in Phase 2 for heavy-duty vehicles. After considering these comments, and considering that EV and

fuel technologies have the potential for more significant emission reductions and fuel consumption savings than any of the technologies projected to be used for Phase 2 compliance, the agencies are adopting new incentive multipliers for Phase 2 for these technologies for all heavy-duty vehicle sectors. A detailed discussion of these provisions is provided above in Section I.

NHTSA and EPA established that for Phase 1, EVs and other zero tailpipe emission vehicles be factored into the fleet average GHG and fuel consumption calculations based on the diesel standards targets for their model year and work factor. The agencies also established for electric and zero emission vehicles that in the credits equation the actual emissions and fuel consumption performance be set to zero (*i.e.*, that emissions be considered on a tailpipe basis exclusively) rather than including upstream emissions or energy consumption associated with electricity generation. As we look to the future, we are not projecting the adoption of electric HD pickups and vans into the heavy duty market; therefore, we believe that this provision is still appropriate. Unlike the MY 2012–2016 light-duty rule, which adopted a cap whereby upstream emissions will be counted after a certain volume of sales (see 75 FR 25434–25436), we believe there is no need to a cap for HD pickups and vans because of the infrequent projected use of EV technologies in the Phase 2 timeframe. In Phase 2, we thus continue to deem electric vehicles as having zero CO<sub>2</sub>, CH<sub>4</sub>, and N<sub>2</sub>O emissions as well as zero fuel consumption. See Section I for a discussion of the treatment of lifecycle emissions for alternative fuel vehicles, including comments regarding the treatment of upstream emissions, and Section XI for the treatment of lifecycle emissions for natural gas specifically.

## (3) Off-Cycle Technology Credits

The Phase 1 program established an opportunity for manufacturers to generate credits by applying innovative technologies whose CO<sub>2</sub> and fuel consumption benefits are not captured on the 2-cycle test procedure (*i.e.*, off-cycle).<sup>529</sup> For HD pickups and vans, the approach for off-cycle technologies established in Phase 1 is similar to that established for light-duty vehicles due to the use of the same basic chassis test procedures. The agencies are retaining

this approach for Phase 2 as proposed. See 80 FR 40389. To generate credits, manufacturers are required to submit data and a methodology for determining the level of credits for the off-cycle technology subject to EPA and NHTSA review and approval. The application for off-cycle technology credits is also subject to a public evaluation process and comment period. EPA and NHTSA would approve the methodology and credits only if certain criteria were met. Baseline emissions and fuel consumption<sup>530</sup> and control emissions and fuel consumption need to be clearly demonstrated over a wide range of real world driving conditions and over a sufficient number of vehicles to address issues of uncertainty with the data. Data must be on a vehicle model-specific basis unless a manufacturer demonstrated model-specific data were not necessary. Once a complete application is submitted by the manufacturer, the regulations require that the agencies publish a notice of availability in the **Federal Register** notifying the public of a manufacturer's off-cycle credit calculation methodology and provide opportunity for comment.

EPA and NHTSA requested comment on establishing a pre-defined technology menu list for HD pickups and vans similar to the approach adopted for light-duty vehicles in the MY 2017–2025 rule.<sup>531</sup> As with the light-duty vehicle program, the agencies noted that a pre-defined list could simplify the process for generating off-cycle credits and may further encourage the introduction of these technologies. However, the agencies also noted that appropriate default level of credits for the heavier vehicles would need to be established. The agencies requested comments with supporting HD pickup and van specific data and analysis that would provide a substantive basis for appropriate credits levels for the HD pickup and van category. The data and analysis would need to demonstrate that the pre-defined credit level represents real-world emissions reductions and fuel consumption improvements not captured by the 2-cycle test procedures.

The agencies received comments recommending off-cycle credits for over a dozen technologies. There are three primary reasons that the agencies are not adopting credits for the individual technologies recommended by commenters. In many cases, the analysis provided by commenters did not

<sup>528</sup> EPA and NHTSA similarly included temporary advanced technology multipliers in the light-duty 2017–2025 program, believing it was worthwhile to forego modest additional emissions reductions and fuel consumption improvements in the near-term in order to lay the foundation for the potential for much larger “game-changing” GHG and oil consumption reductions in the longer term. The incentives in the light-duty vehicle program are available through the 2021 model year. See 77 FR 62811, October 15, 2012.

<sup>529</sup> See 76 FR 57251, September 15, 2011, 40 CFR 1037.104(d)(13), and 40 CFR 86.1819–14(d)(13). Note that for the vocational vehicle and tractor standards, and off-cycle credit is to evaluate technologies whose benefit is not recognized by GEM (rather than the two-cycle test). See V.D.3 and III.F.3, respectively.

<sup>530</sup> Fuel consumption is derived from measured CO<sub>2</sub> emissions using conversion factors of 8.887 g CO<sub>2</sub>/gallon for gasoline and 10.180 g CO<sub>2</sub>/gallon for diesel fuel.

<sup>531</sup> 77 FR 62832–62839, October 15, 2012.

include sufficient real-world heavy-duty vehicle data on which to base the menu credit value recommended by the commenter. Thus, in several cases, the analysis provided by commenters was based on light-duty vehicle data or on simulations with little detail provided, which analysis is not directly applicable to heavy duty pickups and vans for purposes of technology performance quantification. Second, in several cases, the technologies recommended for off-cycle credits for pickups and vans provide significant on-cycle benefit. Such technologies are considered to be adequately captured by the test procedures (within the meaning of section 86.1819–14(d)(13))<sup>532</sup> and are not considered to be eligible for off-cycle credits. Examples of adequately captured technologies that commenters recommended for off-cycle credits include cylinder deactivation and cooled EGR. Moreover, these are technologies the agencies expect to be in the mix of technologies used to meet the standards (and are projected to be used in the respective analyses of compliance paths on which the stringency of the final standards are predicated). EPA has already indicated that off-cycle credits are not available for technologies that form part of the technology basis for the greenhouse gas standards because these technologies' benefits would already be reflected in the standard's stringencies (and costs). 77 FR 62835 (Oct. 12, 2012). Indeed, it is because of these technologies' robust performance in two-cycle space that the agencies have projected their use as part of the compliance path on which standard stringency is predicated. Likewise, many of these technologies are inherent to vehicle design and so are similarly ineligible. *Id.* at 62732, 62836. Finally, a few other recommended technologies are considered safety-related technologies not eligible for credits because they could reasonably be expected to fall under vehicle safety standards in the future and so would be adopted in any case. Granting off-cycle credits for these technologies consequently would amount to an unwarranted windfall. Adaptive cruise control and forward collision warning systems are examples of these technologies. Chapter 7 of the Response

<sup>532</sup> This provision states that an off-cycle credit must be for a technology that is "not adequately captured on the Federal Test procedure (FTP) and/or the highway Fuel Economy Test (HFET)." EPA has indicated that this requires manufacturers to demonstrate "an incremental off-cycle benefit that is significantly greater than the 2-cycle benefit." 77 FR 62836 (Oct. 12, 2012).

to Comments for this final rule provides a detailed response to these comments

#### (4) Demonstrating Compliance for Heavy-Duty Pickups and Vans

The Phase 1 rule established a comprehensive compliance program for HD pickups and vans that NHTSA and EPA are generally retaining for Phase 2. The compliance provisions cover details regarding the implementation of the fleet average standards including vehicle certification, demonstrating compliance at the end of the model year, in-use standards and testing, carryover of certification test data, and reporting requirements. Please see Section V.B.(1) of the Phase 1 rule Preamble (76 FR 57256–57263) for a detailed discussion of these provisions.

The Phase 1 rule contains special provisions regarding loose engines and optional chassis certification of certain vocational vehicles over 14,000 lbs. GVWR. As proposed, the agencies are extending the optional chassis certification provisions to Phase 2 and are providing a temporary loose engine provision for Phase 2 as described in Section V.D.3.e, under Compliance Flexibility Provisions. See the vocational vehicle Section V.D. and XIII.A.2 for a detailed discussion of the rule for optional chassis certification and Section II.D. for the discussion of loose engines.

#### VII. Aggregate GHG, Fuel Consumption, and Climate Impacts

Given that the purpose of setting these Phase 2 standards is to reduce fuel consumption and greenhouse gas (GHG) emissions from heavy-duty vehicles, it is necessary for the agencies to analyze the extent to which these standards will accomplish that purpose. This section describes the agencies' methodologies for projecting the reductions in greenhouse gas (GHG) emissions and fuel consumption and the methodologies the agencies used to quantify the impacts associated with these standards. In addition, EPA's analyses of the projected change in atmospheric carbon dioxide (CO<sub>2</sub>) concentration and consequent climate change impacts are discussed. Because of NHTSA's obligations under EPCA/EISA and NEPA, NHTSA further analyzes the projected environmental impacts related to fuel consumption, GHG emissions, and climate change, for each regulatory alternative. Detailed documentation of this analysis is provided in Chapters 3, 4 and 5 of NHTSA's FEIS accompanying today's notice.

#### A. What methodologies did the Agencies use to project GHG emissions and fuel consumption impacts?

Different tools exist for estimating potential fuel consumption and GHG emissions impacts associated with fuel efficiency and GHG emission standards. One such tool is EPA's official mobile source emissions inventory model named Motor Vehicle Emissions Simulator (MOVES).<sup>533</sup> The agencies used a revised version of MOVES2014a to quantify the impacts of these standards for vocational vehicles and combination tractor-trailers on GHG emissions and fuel consumption.

Since the notice of proposed rulemaking, EPA has made certain updates to MOVES in response to the public comments on the proposal: (1) The projections of vehicle sales, populations, and activity in the version used for the final rulemaking were updated to incorporate the latest projections from the U.S. Department of Energy's Annual Energy Outlook 2015 report;<sup>534</sup> (2) the extended idle and APU emission rates in MOVES were updated based on the analyses of latest test programs that reflect the current prevalence of clean idle certified engines; and (3) the baseline adoption rates of idle reduction technology were reassessed and projected to be lower than what was assumed in the proposal, as described in Section III.D.1.a of the Preamble. In addition, changes to APU emissions rates for PM<sub>2.5</sub> were implemented in MOVES reflecting the fact that EPA is adopting requirements to control PM<sub>2.5</sub> emissions from APUs installed in new tractors, as discussed in Section III.C.3 of the Preamble. Finally, methodological improvements were made in classifying vehicle types and in forecasting vehicle populations and activity. The aforementioned updates above, along with other changes, are documented in the memorandum to the docket.<sup>535</sup>

MOVES was run with user input databases, described in more detail below, that reflected the projected technological improvements resulting from the final rules, such as the improvements in engine and vehicle efficiency, aerodynamic drag, and tire rolling resistance. The changes made to

<sup>533</sup> MOVES homepage: <https://www3.epa.gov/otaq/models/moves/index.htm> (last accessed May 27, 2016).

<sup>534</sup> Annual Energy Outlook 2015. <http://www.eia.gov/forecasts/archive/aeo15/> (last accessed May 27, 2016).

<sup>535</sup> U.S. EPA. Updates to MOVES for Emissions Analysis of Greenhouse Gas Emissions and Fuel Efficiency Standards for Medium- and Heavy-Duty Engines and Vehicles—Phase 2 FRM. Docket No. EPA-HQ-OAR-2016. July 2016.

the default MOVES database are described below in Section VII.B.(3). All the input data, MOVES run spec files, and the scripts used for the analysis, as well as the version of MOVES used to generate the emissions inventories, can be found in the docket.<sup>536</sup>

Another such tool is DOT's CAFE model, which estimates how manufacturers could potentially apply technology improvements in response to new standards, and then calculates, among other things, resultant changes in national fuel consumption and GHG emissions. As described in Section VI, two versions of this model were used for analysis of potential new standards for HD pickups and vans. Both versions use the work-based attribute metric of "work factor" established in the Phase 1 rule for heavy-duty pickups and vans instead of the light-duty "footprint" attribute metric. The CAFE model takes user-specified inputs on, among other things, vehicles that are projected to be produced in a given model year, technologies available to improve fuel efficiency on those vehicles, potential regulatory standards that will drive improvements in fuel efficiency, and economic assumptions. The CAFE model takes every vehicle in each manufacturer's fleet and decides what technologies to add to those vehicles in order to allow each manufacturer to comply with the standards in the most cost-effective way. Based on those results, the CAFE model then calculates total fuel consumption and GHG emissions impacts based on those inputs, along with economic costs and benefits. The DOT's CAFE model is further described in detail in Section VI of the Preamble and Chapter 10 of the RIA.

For these rules, the agencies used two analytical methods for the heavy-duty pickup and van segment employing both DOT's CAFE model and EPA's MOVES model. The agencies used EPA's MOVES model to estimate fuel consumption and emissions impacts for tractor-trailers (including the engine that powers the tractor) and vocational vehicles (including the engine that powers the vehicle).

For heavy-duty pickups and vans, the agencies performed separate analyses, which we refer to as "Method A" and "Method B." In Method A, a modified version of the CAFE model was used to project a pathway the industry could use to comply with each regulatory alternative and the estimated effects on

fuel consumption, emissions, benefits and costs. In Method B, the MOVES model was used to estimate fuel consumption and emissions from these vehicles. NHTSA considered Method A as its central analysis. EPA considered the results of Method B as its central analysis. The agencies concluded that these methods led the agencies to the same conclusions and the same selection of the final standards. See Chapter 5 of the RIA for additional discussions of these two methods.

For both methods, the agencies analyzed the impact of the final rules, relative to two different reference cases—"flat" (Alternative 1a) and "dynamic" (Alternative 1b). The flat baseline projects very little improvement in new vehicles in the absence of new Phase 2 standards. In contrast, the dynamic baseline projects more improvements in vehicle fuel efficiency in the absence of new Phase 2 standards. The agencies considered both reference cases (for additional details, see Chapter 11 of the RIA). The results for all of the regulatory alternatives relative to both reference cases, derived via the same methodologies discussed in this section, are presented in Section X of the Preamble.

For brevity, a subset of these analyses are presented in this section, and the reader is referred to both Chapter 11 of the RIA and NHTSA's FEIS Chapters 3, 4 and 5 for complete sets of these analyses. In this section, Method A is presented for the final standards (*i.e.*, Alternative 3—the agencies' preferred alternative), relative to both the dynamic baseline (Alternative 1b) and the flat baseline (Alternative 1a). Method B is presented for the final standards, relative only to the flat baseline.

Because reducing fuel consumption also affects emissions that occur as a result of fuel production and distribution (including renewable fuels), the agencies also calculated those "upstream" changes using the "downstream" fuel consumption reductions predicted by the CAFE model (in "Method A") and the MOVES model (in "Method B"). As described in Section VI, Method A uses the CAFE model to estimate vehicular fuel consumption and emissions impacts only for HD pickups and vans and to calculate upstream impacts. For vocational vehicles and combination tractor-trailers, both Method A and Method B use the same upstream tools originally created for the Renewable Fuel Standard 2 (RFS2) rulemaking

analysis,<sup>537</sup> used in the LD GHG rulemakings,<sup>538</sup> HD GHG Phase 1,<sup>539</sup> and updated for the current analysis. The estimate of emissions associated with production and distribution of gasoline and diesel from crude oil is based on emission factors in the "Greenhouse Gases, Regulated Emissions, and Energy Use in Transportation" model (GREET) developed by DOE's Argonne National Lab. In some cases, the GREET values were modified or updated by the agencies to be consistent with the National Emission Inventory (NEI) and emission factors from MOVES. Method B uses the same tool described above to estimate the upstream impacts for HD pickups and vans. For additional details, see Chapter 5 of the RIA. The upstream tool used for the Method B can be found in the docket.<sup>540</sup> As noted in Section VI above, these analyses corroborate each other's results.

The agencies analyzed the anticipated emissions impacts of the final rules on carbon dioxide (CO<sub>2</sub>), methane (CH<sub>4</sub>), nitrous oxide (N<sub>2</sub>O), and hydrofluorocarbons (HFCs) for a number of calendar years (for purposes of the discussion in these final rules, only 2025, 2040 and 2050 will be shown) by comparing to both reference cases.<sup>541</sup> Additional runs were performed for just three of the greenhouse gases (CO<sub>2</sub>, CH<sub>4</sub>, and N<sub>2</sub>O) and for fuel consumption for every calendar year from 2016 to 2050, inclusive, which fed the economy-wide modeling, monetized greenhouse gas benefits estimation, and climate impacts analyses, discussed in sections below.<sup>542</sup>

<sup>537</sup> U.S. EPA. Draft Regulatory Impact Analysis: Changes to Renewable Fuel Standard Program. Chapters 2 and 3. May 26, 2009. Docket ID: EPA-HQ-OAR-2009-0472-0119.

<sup>538</sup> 2017 and Later Model Year Light-Duty Vehicle Greenhouse Gas Emissions and Corporate Average Fuel Economy Standards (77 FR 62623, October 15, 2012).

<sup>539</sup> Greenhouse Gas Emission Standards and Fuel Efficiency Standards for Medium- and Heavy-Duty Engines and Vehicles (76 FR 57106, September 15, 2011).

<sup>540</sup> Memorandum to the Docket "Upstream Emissions Modeling Files for HDGHG Phase 2 FRM" Docket No. EPA-HQ-OAR-2016. July 2016.

<sup>541</sup> The emissions impacts of the final rules on non-GHGs, including air toxics, were also estimated using MOVES. See Section VIII of the Preamble for more information.

<sup>542</sup> The CAFE model estimates, among other things, manufacturers' potential multiyear planning decisions within the context of an estimated year-by-year product cadence (*i.e.*, schedule for redesigning and freshening vehicles). The model was allowed to deploy technology in earlier model years in the analysis in order to account for the potential that manufacturers might take anticipatory actions in model years preceding those covered by today's rules.

<sup>536</sup> Memorandum to the Docket "Runspecs, Model Inputs, MOVES Code and Database for HD GHG Phase 2 FRM Emissions Modeling" Docket No. EPA-HQ-OAR-2016. July 2016.

*B. Analysis of Fuel Consumption and GHG Emissions Impacts Resulting From Final Standards*

The following sections describe the model inputs and assumptions for both the flat and dynamic reference cases and the control case representing the agencies' final fuel efficiency and GHG standards. The details of all the MOVES runs and input data tables, as well as the MOVES code and database, can be found in the docket.<sup>543</sup> See Section VI.C for the discussion of the model inputs and assumptions for the analysis of the HD pickups and vans using DOT's CAFE Model.

(1) Model Inputs and Assumptions for the Flat Reference Case

The flat reference case (identified as Alternative 1a in Section X), includes the impact of Phase 1, but assumes that fuel efficiency and GHG emission standards are not improved beyond the required 2018 model year levels. Alternative 1a functions as one of the baselines against which the impacts of the final standards can be evaluated. The MOVES2014a default road load parameters and energy rates were used for the vocational vehicles and HD pickups and vans for this alternative because we assumed no market-driven improvements in fuel efficiency. The tractor-trailer road load parameters were changed from the MOVES2014a default values to account for projected improvements in the efficiency of the box trailers pulled by combination tractors due to increased penetration of aerodynamic technologies and low rolling resistance tires attributed to both

EPA's SmartWay Transport Partnership and California Air Resources Board's Tractor-Trailer Greenhouse Gas regulation, as described in Section IV of the Preamble. We maintained the same road load inputs for tractor-trailers for 2018 and beyond. The flat reference case assumed the growth in vehicle populations and miles traveled based on the relative annual VMT growth from AEO2015 Final Release for model years 2014 and later.<sup>544</sup>

(2) Model Inputs and Assumptions for the Dynamic Reference Case

The dynamic reference case (identified as Alternative 1b in Section X) also includes the impact of Phase 1 and generally assumes that fuel efficiency and GHG emission standards are not improved beyond the required 2018 model year levels. However, for this case, the agencies assume market forces will lead to additional fuel efficiency improvements for HD pickups and vans and tractor-trailers. These additional assumed improvements are described in Section X of the Preamble. No additional fuel efficiency improvements due to market forces were assumed for vocational vehicles. For HD pickups and vans, the agencies applied the CAFE model using the input assumption that manufacturers having achieved compliance with Phase 1 standards will continue to apply technologies for which increased purchase costs will be "paid back" through corresponding fuel savings within the first six months of vehicle operation. The agencies conducted the

MOVES analysis of this case in the same manner as for the flat reference case.

(3) Model Inputs and Assumptions for "Control" Case

(a) Vocational Vehicles and Tractor-Trailers

The "control" case represents the agencies' final fuel efficiency and GHG standards. The agencies developed additional user input data for MOVES runs to estimate the control case inventories. The inputs to MOVES for the control case account for improvements of engine and vehicle efficiency in vocational vehicles and combination tractor-trailers. The agencies used the percent reduction in aerodynamic drag and tire rolling resistance coefficients and absolute changes in average total running weight (gross combined weight) expected from the final rules to develop the road load inputs for the control case, based on the GEM analysis. The agencies developed energy inputs for the control case runs using the percent reduction in CO<sub>2</sub> emissions expected from the powertrain and other vehicle technologies not accounted for in the aerodynamic drag and tire rolling resistance in the final rules.

Table VII-1 and Table VII-2 describe the improvements in engine and vehicle efficiency from the final rules for each affected model year for vocational vehicles and combination tractor-trailers that were input into MOVES for estimating the control case emissions inventories. Additional details regarding the MOVES inputs are included in Chapter 5 of the RIA.

TABLE VII-1—ESTIMATED REDUCTIONS IN ENERGY RATES FOR THE FINAL STANDARDS

Vehicle type	Fuel	Model years	Reduction from flat baseline (%)
Long-haul Tractor-Trailers and HHD Vocational .....	Diesel .....	2018–2020	1.0
		2021–2023	7.9
		2024–2026	12.4
		2027+	16.3
Short-haul Tractor-Trailers and HHD Vocational .....	Diesel .....	2018–2020	0.6
		2021–2023	7.4
		2024–2026	11.9
		2027+	15.0
Single-Frame Vocational <sup>545</sup> .....	Diesel .....	2021–2023	7.8
		2024–2026	12.3
		2027+	16.0

<sup>543</sup> Memorandum to the Docket "Runspects, Model Inputs, MOVES Code and Database for HD GHG Phase 2 FRM Emissions Modeling" Docket No. EPA-HQ-OAR-2016. July 2016.

<sup>544</sup> Annual Energy Outlook 2015. <http://www.eia.gov/forecasts/archive/aeo15/> (last accessed May 27, 2016).

<sup>545</sup> Vocational vehicles modeled in MOVES include heavy heavy-duty, medium heavy-duty, and light heavy-duty vehicles. However, for light heavy-duty vocational vehicles, class 2b and 3 vehicles are not included in the inventories for the vocational sector. Instead, all vocational vehicles with GVWR of less than 14,000 lbs. were modeled

using the energy rate reductions described below for HD pickup trucks and vans. In practice, many manufacturers of these vehicles choose to average the lightest vocational vehicles into chassis-certified families (*i.e.*, heavy-duty pickups and vans).

TABLE VII-1—ESTIMATED REDUCTIONS IN ENERGY RATES FOR THE FINAL STANDARDS—Continued

Vehicle type	Fuel	Model years	Reduction from flat baseline (%)
Urban Bus	Gasoline	2021–2023	6.9
		2024–2026	9.8
	2027+	13.3	
	Diesel and CNG	2021–2023	7.0
		2024–2026	11.8
2027+		14.4	

TABLE VII-2—ESTIMATED REDUCTIONS IN ROAD LOAD FACTORS FOR THE FINAL STANDARDS

Vehicle type	Model years	Reduction in tire rolling resistance coefficient (%)	Reduction in aerodynamic drag coefficient (%)	Weight reduction (lb) <sup>a</sup>
Combination Long-haul Tractor-Trailers	2018–2020	6.1	5.6	-140
	2021–2023	13.3	12.5	-199
	2024–2026	16.3	19.3	-294
	2027+	18.0	28.2	-360
	2018–2020	5.2	0.9	-23
Combination Short-haul Tractor-Trailers. <sup>546</sup>	2021–2023	11.9	4.0	-43
	2024–2026	14.1	6.2	-43
	2027+	15.9	8.8	-43
	2021–2023	18.2	0	0
Intercity Buses	2024–2026	20.8	0	0
	2027+	24.7	0	0
	2021–2023	0	0	0
Transit Buses	2024–2026	0	0	0
	2027+	12.1	0	0
	2021–2023	10.1	0	0
School Buses	2024–2026	14.9	0	0
	2027+	19.7	0	0
	2021–2023	0	0	0
Refuse Trucks	2024–2026	0	0	0
	2027+	12.1	0	0
	2021–2023	6.4	0	4.4
Single Unit Short-haul Trucks	2024–2026	6.4	0	10.4
	2027+	10.2	0	16.5
	2021–2023	8.4	0	7.9
Single Unit Long-haul Trucks	2024–2026	13.3	0	23.6
	2027+	13.3	0	39.4
	2021–2023	20.8	0	0
Motor Homes	2024–2026	20.8	0	0
	2027+	24.7	0	0

**Note:**

<sup>a</sup> Negative weight reductions reflect an expected weight increase as a byproduct of other vehicle and engine improvements as described in Chapter 5 of the RIA.

In addition, the CO<sub>2</sub> standard for tractors, reflecting the use of idle reduction technologies such as diesel-powered auxiliary power units (APUs) and battery-powered APUs, as discussed in Section III.D of the Preamble, was included in the modeling for the long-haul combination tractor-trailers, as shown below in Table VII-3.

TABLE VII-3—ASSUMED APU USE DURING EXTENDED IDLING FOR COMBINATION LONG-HAUL TRACTOR-TRAILERS<sup>a</sup>

Vehicle type	Model year	Diesel APU Penetration (%)	Battery APU Penetration (%)
Combination Long-Haul Trucks	2010–2020	9	0
	2021–2023	30	10
	2024–2026	40	10
	2027+	40	15

**Note:**

<sup>546</sup> Vocational tractors are included in the short-haul tractor segment.

<sup>a</sup>Other idle reduction technologies (such as automatic engine shutdown, fuel operated heaters, and stop-start systems) were modeled as part of the energy rates.

To account for the potential increase in vehicle use expected to result from improvements in fuel efficiency for vocational vehicles and combination tractor-trailers due to the final rules (also known as the “rebound effect” and described in more detail in Section IX.E of the Preamble), the control case assumed an increase in VMT from the reference levels by 0.30 percent for the vocational vehicles and 0.75 percent for the combination tractor-trailers.<sup>547</sup>

#### (b) Heavy-Duty Pickups and Vans

As explained above and as also discussed in the RIA, the agencies used both DOT’s CAFE model and EPA’s MOVES model, for Method A and B, respectively, to project fuel consumption and GHG emissions impacts resulting from these standards for HD pickups and vans, including downstream vehicular emissions as well as emissions from upstream processes related to fuel production, distribution, and delivery.

##### (i) Method A for HD Pickups and Vans

For Method A, the agencies used the CAFE model which applies fuel properties (density and carbon content) to estimated fuel consumption in order to calculate vehicular CO<sub>2</sub> emissions, applies per-mile emission factors from MOVES to estimated VMT (for each regulatory alternative, adjusted to account for the rebound effect) in order to calculate vehicular CH<sub>4</sub> and N<sub>2</sub>O emissions (as well, as discussed below, of non-GHG pollutants), and applies per-gallon upstream emission factors from GREET in order to calculate upstream GHG (and non-GHG) emissions.

As discussed above in Section VI, the standards for HD pickups and vans increase in stringency by 2.5 percent annually during model years 2021–2027. The standards define targets specific to each vehicle model, but no

individual vehicle is required to meet its target; instead, the production-weighted averages of the vehicle-specific targets define average fuel consumption and CO<sub>2</sub> emission rates that a given manufacturer’s overall fleet of produced vehicles is required to achieve as a whole. The standards are specified separately for gasoline and diesel vehicles, and vary with work factor. Both the NPRM and today’s analysis assume that some application of mass reduction could enable increased work factor in cases where manufacturers increase a vehicle’s rated payload and/or towing capacity without a change to GVWR and GCWR, but there are other ways manufacturers may change work factor which the analysis does not capture. Average required levels will depend on the future mix of vehicles and the work factors of the vehicles produced for sale in the U.S. Since these can only be estimated at this time, average required and achieved fuel consumption and CO<sub>2</sub> emission rates are subject to uncertainty. Between the NPRM and the issuance of today’s final rules, the agencies updated the market forecast (and other inputs) used to analyze HD pickup and van standards, and doing so leads to different estimates of required and achieved fuel consumption and CO<sub>2</sub> emission rates (as well as different estimates of impacts, costs, and benefits).

The following four tables present stringency increases and estimated required and achieved fuel consumption and CO<sub>2</sub> emission rates for the two No Action Alternatives (Alternative 1a and 1b) and the standards defining the final program. Stringency increases are shown relative to standards applicable in model year 2018 (and through model year 2020). As mathematical functions, the standards themselves are not subject to uncertainty. By 2027, they are 16.2 percent more stringent (*i.e.*, lower) than those applicable during 2018–2020.

NHTSA estimates that, by model 2027, these standards could reduce average required fuel consumption and CO<sub>2</sub> emission rates to about 4.88 gallons/100 miles and about 4 grams/mile, respectively. NHTSA further estimates that average achieved fuel consumption and CO<sub>2</sub> emission rates could correspondingly be reduced to about the same levels. If, as represented by Alternative 1b, manufacturers will, even absent today’s standards, voluntarily make improvements that pay back within six months, these model year 2027 levels are about 12 percent lower than the agencies estimate could be achieved under the Phase 1 standards defining the No Action Alternative. If, as represented by Alternative 1a, manufacturers will, absent today’s standards, only apply technology as required to achieve compliance, these model year 2027 levels are about 13 percent lower than the agencies estimate could be achieved under the Phase 1 standards. As indicated below, the agencies estimate that these improvements in fuel consumption and CO<sub>2</sub> emission rates will build from model year to model year, beginning as soon as model year 2017 (insofar as manufacturers may make anticipatory improvements if warranted given planned product cadence).

The NPRM analysis suggested that both the achieved and required fuel consumption and CO<sub>2</sub> reductions would be larger than the current analysis suggests. The NPRM suggested that achieved reductions would be 13.5 and 15 percent, for the dynamic and flat baselines, respectively. The erosion of the standards and fuel consumption reductions can be attributed to the increased work factor of the 2015 fleet relative to the 2014 fleet. Section 6 discusses in more detail the changes in the distribution of work factor for key market players from the MY 2014 to the MY 2015 fleet.

<sup>547</sup> Memorandum to the Docket “VMT Rebound Inputs to MOVES for HDGHG2 Phase 2 FRM” Docket No. EPA–HQ–OAR–2016. July 2016.

TABLE VII-4—STRINGENCY OF HD PICKUP AND VAN STANDARDS, ESTIMATED AVERAGE REQUIRED AND ACHIEVED FUEL CONSUMPTION RATES FOR METHOD A, RELATIVE TO ALTERNATIVE 1b<sup>a</sup>

Model year	Stringency (vs. 2018)	Ave. required fuel cons. (gal./100 mi.)			Ave. achieved fuel cons. (gal./100 mi.)		
		No action	Final	Reduction (%)	No action	Final	Reduction (%)
2016	MYs 2016–2020 Subject to Phase 1 Standards.	6.32	6.32	0.0	6.14	6.14	0.0
2017		6.16	6.16	0.0	6.02	5.89	2.2
2018		5.83	5.83	0.0	5.97	5.78	3.2
2019		5.81	5.81	0.0	5.77	5.47	5.3
2020		5.80	5.80	0.0	5.75	5.46	5.1
2021	2.5	5.79	5.65	2.4	5.68	5.28	7.2
2022	4.9	5.80	5.52	4.8	5.64	5.22	7.5
2023	7.3	5.80	5.38	7.2	5.64	5.21	7.6
2024	9.6	5.80	5.25	9.5	5.65	5.22	7.6
2025	11.9	5.81	5.12	11.8	5.65	5.14	9.1
2026	14.1	5.81	5.01	13.7	5.65	5.02	11.1
2027	16.2	5.80	4.88	15.8	5.57	4.92	11.7
2028*	16.2	5.81	4.91	15.5	5.57	4.89	12.2
2029*	16.2	5.81	4.91	15.6	5.57	4.88	12.4
2030*	16.2	5.81	4.91	15.6	5.57	4.88	12.4

**Notes:**

<sup>a</sup>For an explanation of analytical Methods A and B, please see Section I.D; for an explanation of the flat baseline, 1a, and dynamic baseline, 1b, please see Section X.A.1.

\* Absent further action, standards assumed to continue unchanged after model year 2027.

TABLE VII-5—STRINGENCY OF HD PICKUP AND VAN STANDARDS, ESTIMATED AVERAGE REQUIRED AND ACHIEVED CO<sub>2</sub> EMISSION RATES FOR METHOD A, RELATIVE TO ALTERNATIVE 1b<sup>a</sup>

Model year	Stringency (vs. 2018) (%)	Ave. required CO <sub>2</sub> Rate (g./mi.)			Ave. achieved CO <sub>2</sub> Rate (g./mi.)		
		No Action	Final	Reduction (%)	No Action	Final	Reduction (%)
2016	MYs 2016–2020 Subject to Phase 1 Standards.	597	597	0.0	578	578	0.0
2017		582	582	0.0	567	554	2.2
2018		550	550	0.0	562	544	3.2
2019		548	548	0.0	543	514	5.3
2020		547	547	0.0	541	513	5.1
2021	2.5	545	532	2.4	534	496	7.1
2022	4.9	546	519	4.9	530	491	7.4
2023	7.3	545	506	7.2	529	490	7.5
2024	9.6	547	494	9.5	531	491	7.5
2025	11.9	547	483	11.7	530	483	9.0
2026	14.1	547	472	13.7	530	472	11.0
2027	16.2	546	460	15.8	523	462	11.5
2028*	16.2	547	462	15.5	523	460	12.0
2029*	16.2	547	462	15.5	524	460	12.2
2030*	16.2	547	462	15.5	524	460	12.2

**Notes:**

<sup>a</sup>For an explanation of analytical Methods A and B, please see Section I.D; for an explanation of the flat baseline, 1a, and dynamic baseline, 1b, please see Section X.A.1.

\* Absent further action, standards assumed to continue unchanged after model year 2027.

TABLE VII-6—STRINGENCY OF HD PICKUP AND VAN STANDARDS, ESTIMATED AVERAGE REQUIRED AND ACHIEVED FUEL CONSUMPTION RATES FOR METHOD A, RELATIVE TO ALTERNATIVE 1a<sup>a</sup>

Model year	Stringency (vs. 2018) (%)	Ave. required fuel cons. (gal./100 mi.)			Ave. achieved fuel cons. (gal./100 mi.)		
		No Action	Final	Reduction (%)	No Action	Final	Reduction (%)
2016	MYs 2016–2020 Subject to Phase 1 Standards.	6.32	6.32	0.0	6.14	6.14	0.0
2017		6.16	6.16	0.0	6.00	5.85	2.4
2018		5.83	5.83	0.0	5.94	5.75	3.2
2019		5.81	5.81	0.0	5.74	5.43	5.4
2020		5.80	5.80	0.0	5.73	5.43	5.2
2021	2.5	5.79	5.65	2.4	5.70	5.27	7.5
2022	4.9	5.80	5.52	4.8	5.69	5.23	8.2
2023	7.3	5.80	5.38	7.2	5.69	5.22	8.3
2024	9.6	5.80	5.25	9.5	5.70	5.22	8.3

TABLE VII-6—STRINGENCY OF HD PICKUP AND VAN STANDARDS, ESTIMATED AVERAGE REQUIRED AND ACHIEVED FUEL CONSUMPTION RATES FOR METHOD A, RELATIVE TO ALTERNATIVE 1a<sup>a</sup>—Continued

Model year	Stringency (vs. 2018) (%)	Ave. required fuel cons. (gal./100 mi.)			Ave. achieved fuel cons. (gal./100 mi.)		
		No Action	Final	Reduction (%)	No Action	Final	Reduction (%)
2025 .....	11.9 .....	5.81	5.13	11.8	5.70	5.13	10.0
2026 .....	14.1 .....	5.81	5.02	13.6	5.70	5.03	11.9
2027 .....	16.2 .....	5.80	4.89	15.8	5.64	4.92	12.8
2028* .....	16.2 .....	5.81	4.91	15.4	5.64	4.89	13.3
2029* .....	16.2 .....	5.81	4.91	15.5	5.64	4.89	13.4
2030* .....	16.2 .....	5.81	4.91	15.5	5.64	4.89	13.4

**Notes:**

<sup>a</sup> For an explanation of analytical Methods A and B, please see Section I.D; for an explanation of the flat baseline, 1a, and dynamic baseline, 1b, please see Section X.A.1.

\* Absent further action, standards assumed to continue unchanged after model year 2027.

\*\* Increased work factor for some vehicles produces a slight increase in average required fuel consumption.

TABLE VII-7—STRINGENCY OF HD PICKUP AND VAN STANDARDS, ESTIMATED AVERAGE REQUIRED AND ACHIEVED CO<sub>2</sub> EMISSION RATES FOR METHOD A, RELATIVE TO ALTERNATIVE 1a<sup>a</sup>

Model year	Stringency (vs. 2018) (%)	Ave. required CO <sub>2</sub> Rate (g./mi.)			Ave. achieved CO <sub>2</sub> Rate (g./mi.)		
		No Action	Final	Reduction (%)	No Action	Final	Reduction (%)
2016 .....	MYs 2016–2020 Subject to Phase 1 Standards.	597	597	0.0	578	578	0.0
2017 .....		582	582	0.0	564	551	2.3
2018 .....		550	550	0.0	559	541	3.2
2019 .....		548	548	0.0	540	511	5.4
2020 .....		547	547	0.0	538	510	5.2
2021 .....	2.5 .....	545	532	2.4	535	495	7.4
2022 .....	4.9 .....	546	519	4.8	534	491	8.0
2023 .....	7.3 .....	545	506	7.2	533	490	8.2
2024 .....	9.6 .....	547	494	9.5	535	491	8.2
2025 .....	11.9 .....	547	483	11.7	535	483	9.8
2026 .....	14.1 .....	547	472	13.6	535	473	11.7
F 2027 .....	16.2 .....	546	460	15.8	529	462	12.6
2028* .....	16.2 .....	547	462	15.5	530	460	13.1
2029* .....	16.2 .....	547	462	15.5	530	460	13.2
2030* .....	16.2 .....	547	462	15.5	530	460	13.2

**Notes:**

<sup>a</sup> For an explanation of analytical Methods A and B, please see Section I.D; for an explanation of the flat baseline, 1a, and dynamic baseline, 1b, please see Section X.A.1.

\* Absent further action, standards assumed to continue unchanged after model year 2027.

\*\* Increased work factor for some vehicles produces a slight increase in the average required CO<sub>2</sub> emission rate.

While the above tables show the agencies' estimates of average fuel consumption and CO<sub>2</sub> emission rates manufacturers of pickups and vans might achieve under today's standards, total U.S. fuel consumption and GHG emissions from HD pickups and vans will also depend on how many of these vehicles are produced, and how they are operated over their useful lives. Relevant to estimating these outcomes, the CAFE model applies vintage-specific estimates of vehicle survival and

mileage accumulation, and adjusts the latter to account for the rebound effect. This impact of the rebound effect is specific to each model year (and, underlying, to each vehicle model in each model year), varying with changes in achieved fuel consumption rates.

## (ii) Method B for HD Pickups and Vans

For Method B, the MOVES model was used to estimate fuel consumption and GHG emissions for HD pickups and vans. MOVES evaluated these standards

for HD pickup trucks and vans in terms of grams of CO<sub>2</sub> per mile or gallons of fuel per 100 miles. Since nearly all HD pickup trucks and vans are certified on a chassis dynamometer, the CO<sub>2</sub> reductions for these vehicles were not represented as engine and road load reduction components, but rather as total vehicle CO<sub>2</sub> reductions. The control case for HD pickups and vans assumed an increase in VMT from the reference levels of 1.08 percent.<sup>548</sup>

<sup>548</sup> Memorandum to the Docket "VMT Rebound Inputs to MOVES for HDGHG2 Phase 2 FRM" Docket No. EPA-HQ-OAR-2016. July 2016.



TABLE VII-8—ESTIMATED TOTAL VEHICLE CO<sub>2</sub> REDUCTIONS FOR THE FINAL STANDARDS AND IN-USE EMISSIONS FOR HD PICKUP TRUCKS AND VANS IN METHOD B<sup>a</sup>

Vehicle type	Fuel	Model year	CO <sub>2</sub> reduction from flat baseline (%)
HD pickup trucks and vans .....	Gasoline and Diesel .....	2021	2.50
		2022	4.94
		2023	7.31
		2024	9.63
		2025	11.89
		2026	14.09
		2027+	16.24

**Note:**

<sup>a</sup>For an explanation of analytical Methods A and B, please see Section I.D; for an explanation of the flat baseline, 1a, and dynamic baseline, 1b, please see Section X.A.1.

*C. What are the projected reductions in fuel consumption and GHG emissions?*

NHTSA and EPA expect significant reductions in GHG emissions and fuel consumption from the final rules—fuel consumption reductions from more efficient vehicles, emission reductions from both downstream (tailpipe) and upstream (fuel production and distribution) sources, and reduction in HFC emissions from the air conditioning leakage standards (see Section V.B.(2)(c)). The following subsections summarize two different analyses of the annual GHG emissions and fuel consumption reductions expected from these final rules, as well as the reductions in GHG emissions and fuel consumption expected over the lifetime of each heavy-duty vehicle category. Section VII.C.(1) shows the impacts of the final rules on fuel consumption and GHG emissions, using the MOVES model for tractor-trailers and vocational vehicles and the DOT’s CAFE model for HD pickups and vans (Method A), relative to two different

reference cases—flat and dynamic. Section VII.C.2 shows the impacts of the final standards, relative to the flat reference case only, using the MOVES model for all heavy-duty vehicle categories. NHTSA also analyzes these impacts resulting from the final rules and reasonable alternatives in Chapters 3, 4 and 5 of its FEIS.

(1) Impacts of the Final Rules Using Analysis Method A

(a) Calendar Year Analysis

(i) Downstream (Tailpipe) Emissions Projections

As described in Section VII.A, for the analysis using Method A, the agencies used MOVES to estimate downstream GHG inventories from the final rules for vocational vehicles and tractor-trailers. For HD pickups and vans, DOT’s CAFE model was used.

The following two tables summarize the agencies’ estimates of HD pickup and van fuel consumption and GHG emissions under the current standards defining the No-Action and final

program, respectively, using Method A. Table VII-9 shows results assuming manufacturers will voluntarily make improvements that pay back within six months (*i.e.*, Alternative 1b). Table VII-10 shows results assuming manufacturers will only make improvements as needed to achieve compliance with standards (*i.e.*, Alternative 1a). While underlying calculations are all performed for each calendar year during each vehicle’s useful life, presentation of outcomes on a model year basis aligns more clearly with consideration of cost impacts in each model year, and with consideration of standards specified on a model year basis. In addition, Method A analyzes manufacturers’ potential responses to HD pickup and van standards on a model year basis through 2030, and any longer-term costs presented in today’s notice represent extrapolation of these results absent any underlying analysis of longer-term technology prospects and manufacturers’ longer-term product offerings.

TABLE VII-9—ESTIMATED FUEL CONSUMPTION AND GHG EMISSIONS OVER USEFUL LIFE OF HD PICKUPS AND VANS PRODUCED IN EACH MODEL YEAR FOR METHOD A, RELATIVE TO ALTERNATIVE 1b<sup>a</sup>

Model year	Fuel consumption (b. gal.) over fleet’s useful life			GHG emissions (MMT CO <sub>2</sub> eq) over fleet’s useful life		
	No action	Final	Reduction (%)	No action	Final	Reduction (%)
2016 .....	10.4	10.4	0.0	127	127	0.0
2017 .....	10.4	10.2	2.0	127	124	2.0
2018 .....	10.5	10.2	2.9	127	124	2.9
2019 .....	10.1	9.60	4.8	123	117	4.8
2020 .....	10.1	9.60	4.6	123	117	4.6
2021 .....	9.82	9.17	6.6	120	112	6.5
2022 .....	9.67	9.01	6.9	118	110	6.8
2023 .....	9.64	8.97	7.0	117	109	6.9
2024 .....	9.67	9.00	7.0	118	110	6.9
2025 .....	9.79	8.98	8.3	119	109	8.2
2026 .....	9.91	8.90	10.2	121	109	10.1
2027 .....	9.89	8.84	10.7	120	108	10.5
2028 .....	10.0	8.89	11.1	122	108	10.9

TABLE VII-9—ESTIMATED FUEL CONSUMPTION AND GHG EMISSIONS OVER USEFUL LIFE OF HD PICKUPS AND VANS PRODUCED IN EACH MODEL YEAR FOR METHOD A, RELATIVE TO ALTERNATIVE 1b<sup>a</sup>—Continued

Model year	Fuel consumption (b. gal.) over fleet's useful life			GHG emissions (MMT CO <sub>2</sub> eq) over fleet's useful life		
	No action	Final	Reduction (%)	No action	Final	Reduction (%)
2029 .....	10.1	8.97	11.2	123	109	11.1
2030 .....	10.1	8.94	11.2	123	109	11.1

**Note:**

<sup>a</sup>For an explanation of analytical Methods A and B, please see Section I.D; for an explanation of the flat baseline, 1a, and dynamic baseline, 1b, please see Section X.A.1.

TABLE VII-10—ESTIMATED FUEL CONSUMPTION AND GHG EMISSIONS OVER USEFUL LIFE OF HD PICKUPS AND VANS PRODUCED IN EACH MODEL YEAR FOR METHOD A, RELATIVE TO ALTERNATIVE 1a<sup>a</sup>

Model year	Fuel consumption (b. gal.) over fleet's useful life			GHG emissions (MMT CO <sub>2</sub> eq) over fleet's useful		
	No action	Final	Reduction (%)	No action	Final	Reduction (%)
2016 .....	10.43	10.43	0.0	122	122	0.0
2017 .....	10.37	10.15	2.2	122	119	2.2
2018 .....	10.41	10.10	3.0	122	118	3.1
2019 .....	10.04	9.55	4.9	118	112	5.1
2020 .....	10.03	9.56	4.7	118	112	4.9
2021 .....	9.84	9.16	6.9	115	107	7.1
2022 .....	9.74	9.01	7.5	114	105	7.7
2023 .....	9.71	8.97	7.6	114	105	7.8
2024 .....	9.75	9.00	7.6	114	105	7.8
2025 .....	9.88	8.97	9.1	116	105	9.3
2026 .....	10.00	8.92	10.8	117	104	11.1
2027 .....	10.01	8.84	11.7	117	103	11.9
2028 .....	10.12	8.89	12.1	119	104	12.4
2029 .....	10.22	8.98	12.1	120	105	12.4
2030 .....	10.18	8.95	12.2	119	105	12.4

**Note:**

<sup>a</sup>For an explanation of analytical Methods A and B, please see Section I.D; for an explanation of the flat baseline, 1a, and dynamic baseline, 1b, please see Section X.A.1.

To more clearly communicate these trends visually, the following two charts present the above results graphically for Method A, relative to Alternative 1b. As shown, fuel consumption and GHG

emissions follow parallel though not precisely identical paths. Though not presented, the charts for Alternative 1a will appear sufficiently similar that differences between Alternative 1a and

Alternative 1b remain best communicated by comparing values in the above tables.

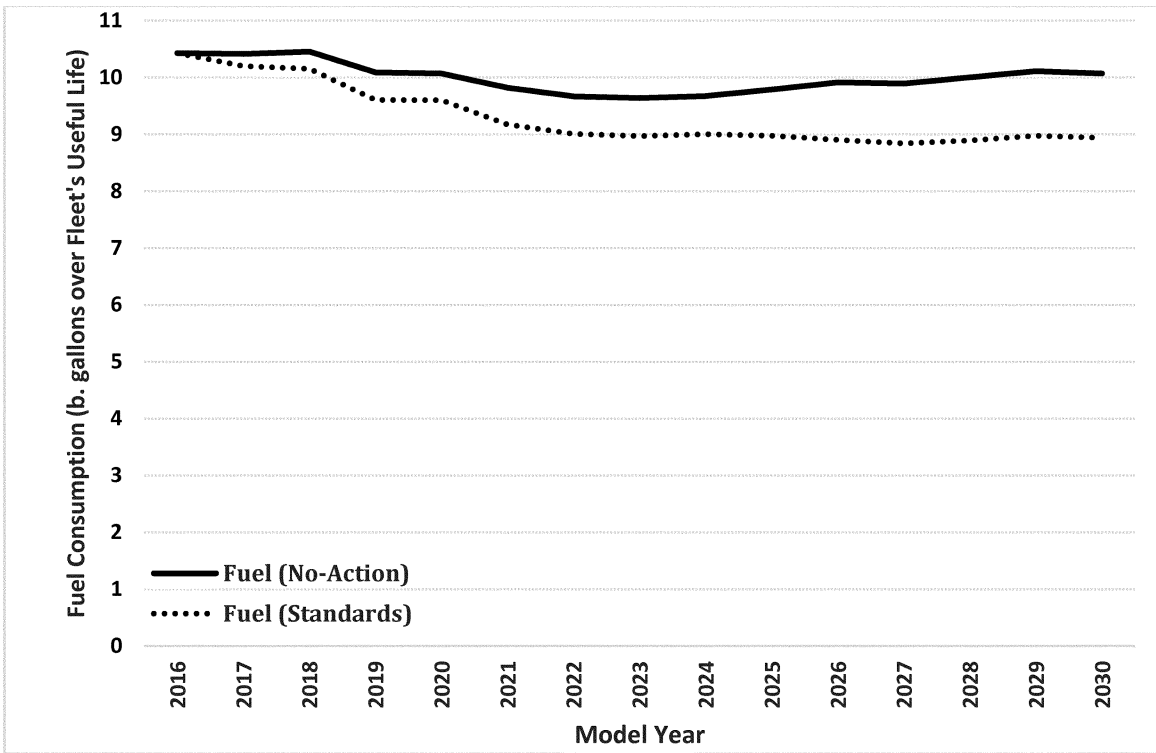

Figure VII-1 Fuel Consumption (b. gal.) over Useful Life of HD Pickups and Vans Produced in Each Model Year for Method A

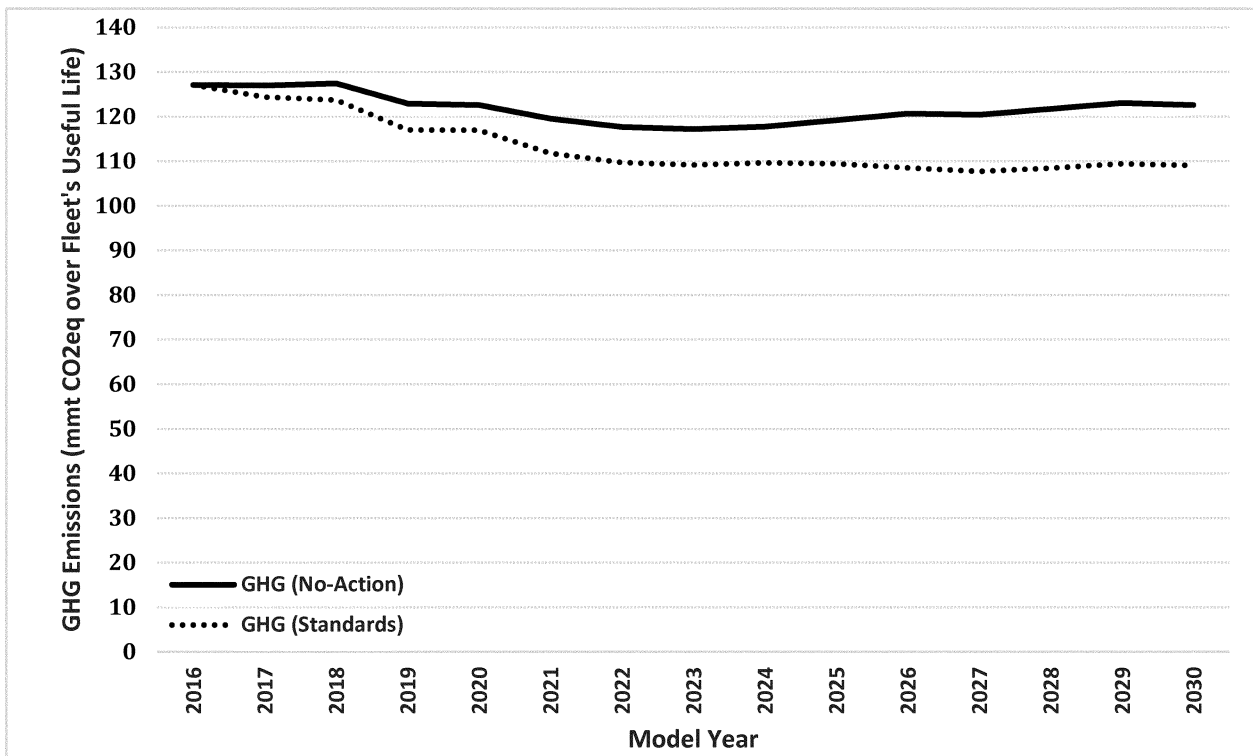

Figure VII-2 GHG Emissions (MMT CO<sub>2</sub>eq) over Useful Life of HD Pickups and Vans Produced in Each Model Year for Method A

TABLE VII-11—ANNUAL DOWNSTREAM GHG EMISSIONS IMPACTS IN CALENDAR YEARS 2025, 2040 AND 2050—FINAL PROGRAM VS. ALT 1b USING ANALYSIS METHOD A<sup>a</sup>

CY	CO <sub>2</sub> (MMT)	CH <sub>4</sub> (MMT CO <sub>2</sub> eq)	N <sub>2</sub> O (MMT CO <sub>2</sub> eq)	Total downstream	
				MMT CO <sub>2</sub> eq	% Change
2025 .....	-26.5	-0.004	0.002	-26.6	-4.9
2040 .....	-103.3	-0.02	0.006	-103.3	-17.0
2050 .....	-123.8	-0.03	0.007	-123.8	-18.0

**Note:**

<sup>a</sup>For an explanation of analytical Methods A and B, please see Section I.D; for an explanation of the flat baseline, 1a, and dynamic baseline, 1b, please see Section X.A.1.

TABLE VII-12—ANNUAL FUEL SAVINGS IN CALENDAR YEARS 2025, 2040 AND 2050—FINAL PROGRAM VS. ALT 1b USING ANALYSIS METHOD A<sup>a</sup>

CY	Diesel		Gasoline	
	Billion gallons	% Savings	Billion gallons	% Savings
2025 .....	2.3	4.9	0.4	5.0
2040 .....	9.2	17.8	1.0	12.2
2050 .....	11.1	19.3	1.2	12.8

**Note:**

<sup>a</sup>For an explanation of analytical Methods A and B, please see Section I.D; for an explanation of the flat baseline, 1a, and dynamic baseline, 1b, please see Section X.A.1.

TABLE VII-13—ANNUAL DOWNSTREAM GHG EMISSIONS IMPACTS IN CALENDAR YEARS 2025, 2040 AND 2050—FINAL PROGRAM VS. ALT 1a USING ANALYSIS METHOD A<sup>a</sup>

CY	CO <sub>2</sub> (MMT)	CH <sub>4</sub> (MMT CO <sub>2</sub> eq)	N <sub>2</sub> O (MMT CO <sub>2</sub> eq)	Total downstream	
				MMT CO <sub>2</sub> eq	% Change
2025 .....	-28.9	-0.005	0.003	-28.9	-5.3
2040 .....	-114.1	-0.02	0.006	-114.1	-18.0
2050 .....	-136.9	-0.03	0.007	-136.9	-20.0

**Note:**

<sup>a</sup>For an explanation of analytical Methods A and B, please see Section I.D; for an explanation of the flat baseline, 1a, and dynamic baseline, 1b, please see Section X.A.1.

TABLE VII-14—ANNUAL FUEL SAVINGS IN CALENDAR YEARS 2025, 2040 AND 2050—FINAL PROGRAM VS. ALT 1a USING ANALYSIS METHOD A<sup>a</sup>

CY	Diesel		Gasoline	
	Billion gallons	% Savings	Billion gallons	% Savings
2025 .....	2.4	5.2	0.5	5.6
2040 .....	10.2	19.0	1.2	13.0
2050 .....	12.3	21.0	1.3	14.0

**Note:**

<sup>a</sup>For an explanation of analytical Methods A and B, please see Section I.D; for an explanation of the flat baseline, 1a, and dynamic baseline, 1b, please see Section X.A.1.

## (ii) Upstream (Fuel Production and Distribution) Emissions Projections

TABLE VII-15—ANNUAL UPSTREAM GHG EMISSIONS IMPACTS IN CALENDAR YEARS 2025, 2040 AND 2050—FINAL PROGRAM VS. ALT 1b USING ANALYSIS METHOD A<sup>a</sup>

CY	CO <sub>2</sub> (MMT)	CH <sub>4</sub> (MMT CO <sub>2</sub> eq)	N <sub>2</sub> O (MMT CO <sub>2</sub> eq)	Total upstream	
				MMT CO <sub>2</sub> eq	% Change
2025 .....	-8.1	-0.9	-0.08	-9.0	-4.9
2040 .....	-31.8	-3.4	-0.2	-35.5	-17.0
2050 .....	-38.1	-4.2	-0.2	-42.5	-19.0

**Note:**

<sup>a</sup>For an explanation of analytical Methods A and B, please see Section I.D; for an explanation of the flat baseline, 1a, and dynamic baseline, 1b, please see Section X.A.1.

TABLE VII-16—ANNUAL UPSTREAM GHG EMISSIONS IMPACTS IN CALENDAR YEARS 2025, 2040 AND 2050—FINAL PROGRAM VS. ALT 1a USING ANALYSIS METHOD A <sup>a</sup>

CY	CO <sub>2</sub> (MMT)	CH <sub>4</sub> (MMT CO <sub>2</sub> eq)	N <sub>2</sub> O (MMT CO <sub>2</sub> eq)	Total upstream	
				MMT CO <sub>2</sub> eq	% Change
2025 .....	-8.7	-0.9	-0.09	-9.8	-5.3
2040 .....	-35.2	-3.9	-0.2	-39.3	-19.0
2050 .....	-42.2	-4.6	-0.3	-47.2	-20.0

**Note:**

<sup>a</sup>For an explanation of analytical Methods A and B, please see Section I.D; for an explanation of the flat baseline, 1a, and dynamic baseline, 1b, please see Section X.A.1.

(iii) HFC Emissions Projections

The projected HFC emission reductions due to the HD Phase 2 air conditioning leakage standards for

vocational vehicles are 86,735 metric tons of CO<sub>2</sub>eq in 2025, 256,061 metric tons of CO<sub>2</sub>eq in 2040, and 314,930 metric tons CO<sub>2</sub>eq in 2050. See Chapter

5 of the RIA for additional details on calculations of HFC emissions.

(iv) Total (Downstream + Upstream + HFC) Emissions Projections

TABLE VII-17—ANNUAL TOTAL GHG EMISSIONS IMPACTS IN CALENDAR YEARS 2025, 2040 AND 2050—FINAL PROGRAM VS. ALT 1b USING ANALYSIS METHOD A <sup>a</sup>

	CY2025		CY2040		CY2050	
	MMT CO <sub>2</sub> eq	% Change	MMT CO <sub>2</sub> eq	% Change	MMT CO <sub>2</sub> eq	% Change
Downstream .....	-26.6	-4.9	-103.3	-17.0	-123.8	-18.0
Upstream .....	-9.0	-4.9	-35.5	-17.0	-42.5	-19.0
HFC <sup>b</sup> .....	-0.1	-15.0	-0.3	-13.0	-0.3	-13.0
Total .....	-35.7	-4.9	-139.1	-17.0	-166.6	-19.0

**Note:**

<sup>a</sup>For an explanation of analytical Methods A and B, please see Section I.D; for an explanation of the flat baseline, 1a, and dynamic baseline, 1b, please see Section X.A.1.

<sup>b</sup>HFC represents HFC emission reductions and percent change from the vocational vehicle category only.

TABLE VII-18 ANNUAL TOTAL GHG EMISSIONS IMPACTS IN CALENDAR YEARS 2025, 2040 AND 2050—FINAL PROGRAM VS. ALT 1a USING ANALYSIS METHOD A <sup>a</sup>

	CY2025		CY2040		CY2050	
	MMT CO <sub>2</sub> eq	% Change	MMT CO <sub>2</sub> eq	% Change	MMT CO <sub>2</sub> eq	% Change
Downstream .....	-28.9	-5.3	-114.1	-18.0	-136.9	-20.0
Upstream .....	-9.8	-5.3	-39.3	-19.0	-47.2	-20.0
HFC .....	-0.1	-15.0	-0.3	-13.0	-0.3	-13.0
Total .....	-38.8	-5.3	-153.7	-19.0	-184.4	-20.0

**Note:**

<sup>a</sup>For an explanation of analytical Methods A and B, please see Section I.D; for an explanation of the flat baseline, 1a, and dynamic baseline, 1b, please see Section X.A.1.

(b) Model Year Lifetime Analysis

TABLE VII-19—LIFETIME GHG REDUCTIONS AND FUEL SAVINGS USING ANALYSIS METHOD A—SUMMARY FOR MODEL YEARS 2018-2029 <sup>a</sup>

No-action alternative (baseline)	Final program (alternative 3)	
	1b (dynamic)	1a (flat)
Fuel Savings (Billion Gallons) .....	71.1	77.7
Total GHG Reductions (MMT CO <sub>2</sub> eq) .....	958	1,049
Downstream (MMT CO <sub>2</sub> eq) .....	715	781
Upstream (MMT CO <sub>2</sub> eq) .....	243	268

**Note:**

<sup>a</sup>For an explanation of analytical Methods A and B, please see Section I.D; for an explanation of the flat baseline, 1a, and dynamic baseline, 1b, please see Section X.A.1.

(2) Impacts of the Final Rules Using Analysis Method B

(a) Calendar Year Analysis

(i) Downstream (Tailpipe) Emissions Projections

As described in Section VII.A., Method B used MOVES to estimate downstream GHG inventories from the final rules, relative to Alternative 1a, for all heavy-duty vehicle categories (including the engines associated with tractor-trailer combinations and vocational vehicles). The agencies expect reductions in CO<sub>2</sub> emissions from all heavy-duty vehicle categories due to engine and vehicle improvements. We expect N<sub>2</sub>O

emissions to increase very slightly because of a rebound in vehicle miles traveled (VMT). However, since N<sub>2</sub>O is produced as a byproduct of fuel combustion, the increase in N<sub>2</sub>O emissions is expected to be more than offset by the improvements in fuel efficiency from the final rules.<sup>549</sup> We expect methane emissions to decrease primarily due to reduced refueling from improved fuel efficiency and the differences in hydrocarbon emission characteristics between on-road diesel engines and APUs. The amount of methane emitted as a fraction of total hydrocarbons is expected to be less for APUs than for on-road diesel engines during extended idling. Overall, the downstream GHG emissions will be

reduced significantly and are described in the following subsections.

Fuel consumption is calculated from the MOVES output of total energy consumption converted using the fuel heating values assumed in the Renewable Fuels Standard rulemaking<sup>550</sup> and in MOVES.<sup>551</sup>

Table VII–20 shows the impacts on downstream GHG emissions and fuel savings in 2025, 2040 and 2050, relative to Alternative 1a, for the final program.

Table VII–21 shows the estimated fuel savings from the final program in 2025, 2040, and 2050, relative to Alternative 1a. The results from the comparable analyses relative to Alternative 1b are presented in Section VII.C.(1).

TABLE VII–20—ANNUAL DOWNSTREAM GHG EMISSIONS IMPACTS IN CALENDAR YEARS 2025, 2040 AND 2050—FINAL PROGRAM VS. ALT 1a USING ANALYSIS METHOD B<sup>a</sup>

CY	CO <sub>2</sub> (MMT)	CH <sub>4</sub> (MMT CO <sub>2</sub> eq)	N <sub>2</sub> O (MMT CO <sub>2</sub> eq)	Total downstream	
				MMT CO <sub>2</sub> eq	% Change
2025 .....	– 27.8	– 0.01	0.002	– 27.8	– 4.6
2040 .....	– 124.3	– 0.02	0.003	– 124.3	– 18.4
2050 .....	– 148.4	– 0.03	0.004	– 148.4	– 0.0

**Note:**

<sup>a</sup> For an explanation of analytical Methods A and B, please see Section I.D; for an explanation of the flat baseline, 1a, and dynamic baseline, 1b, please see Section X.A.1.

TABLE VII–21—ANNUAL FUEL SAVINGS IN CALENDAR YEARS 2025, 2040 AND 2050—FINAL PROGRAM VS. ALT 1a USING ANALYSIS METHOD B<sup>a</sup>

CY	Diesel		Gasoline	
	Billion gallons	% Savings	Billion gallons	% Savings
2025 .....	2.5	5.0	0.3	2.8
2040 .....	10.8	19.4	1.7	13.3
2050 .....	13.0	21.0	1.9	14.4

**Note:**

<sup>a</sup> For an explanation of analytical Methods A and B, please see Section I.D; for an explanation of the flat baseline, 1a, and dynamic baseline, 1b, please see Section X.A.1.

(ii) Upstream (Fuel Production and Distribution) Emissions Projections

The upstream GHG emission reductions associated with the production and distribution of gasoline and diesel from crude oil include the domestic emission reductions only. Additionally, since this rulemaking is not expected to impact biofuel volumes mandated by the annual Renewable Fuel Standards (RFS) regulations<sup>552</sup>, the impacts on upstream emissions from

changes in biofuel feedstock (*i.e.*, agricultural sources such as fertilizer, fugitive dust, and livestock) are not shown. In other words, we attribute decreased fuel consumption from this program to petroleum-based fuels only, while assuming no net effect on volumes of renewable fuels. We used this approach because annual renewable fuel volumes are mandated independently from this rulemaking under RFS. As a consequence, it is not possible to conclude whether the

decreasing petroleum consumption projected here would increase the fraction of the U.S. fuel supply that is made up by renewable fuels (if RFS volumes remained constant), or whether future renewable fuel volume mandates would decrease in proportion to the decreased petroleum consumption projected here.

As background, EPA sets annual renewable fuel volume mandates through a separate RFS notice-and-comment rulemaking process, and the

<sup>549</sup> MOVES is not capable of modeling the changes in exhaust N<sub>2</sub>O emissions from the improvements in fuel efficiency. Due to this limitation, a conservative approach was taken to only model the VMT rebound in estimating the emissions impact on N<sub>2</sub>O from the final rules, resulting in a slight increase in downstream N<sub>2</sub>O inventory.

<sup>550</sup> Renewable Fuels Standards assumptions of 115,000 BTU/gallon gasoline (E0) and 76,330 BTU/gallon ethanol (E100) were weighted 90 percent and 10 percent, respectively, for E10 and 85 percent and 15 percent, respectively, for E15 and converted to kJ at 1.055 kJ/BTU. The conversion factors are 117,245 kJ/gallon for gasoline blended with ten percent ethanol (E10) and 115,205 kJ/gallon for gasoline blended with fifteen percent ethanol (E15).

<sup>551</sup> The conversion factor for diesel is 138,451 kJ/gallon. See MOVES2004 Energy and Emission Inputs. EPA420–P–05–003, March 2005. <http://www3.epa.gov/otaq/models/ngm/420p05003.pdf> (last accessed Mar 15, 2016).

<sup>552</sup> U.S. EPA. 2014 Standards for the Renewable Fuel Standard Program. 40 CFR part 80. EPA–HQ–OAR–2013–0479; FRL–9900–90–OAR, RIN 2060–AR76.

final volumes are based on EIA projections, EPA's own market assessment, and information obtained from the RFS notice and comment process. Also, RFS standards are nested within each other, which means that a fuel with a higher GHG reduction

threshold can be used to meet the standards for a lower GHG reduction threshold. This creates additional uncertainty in projecting this rule's net effect on future annual RFS standards. In conclusion, the impacts of this rulemaking on annual renewable fuel volume mandates are difficult to project

at the present time. However, since it is not centrally relevant to the analysis for this rulemaking, we have not included any impacts on renewable fuel volumes in this analysis. The upstream GHG emission reductions of the final program can be found in Table VII-22.

TABLE VII-22—ANNUAL UPSTREAM GHG EMISSIONS IMPACTS IN CALENDAR YEARS 2025, 2040 AND 2050—FINAL PROGRAM VS. ALT 1a USING ANALYSIS METHOD B<sup>a</sup>

CY	CO <sub>2</sub> (MMT)	CH <sub>4</sub> (MMT CO <sub>2</sub> eq)	N <sub>2</sub> O (MMT CO <sub>2</sub> eq)	Total upstream	
				MMT CO <sub>2</sub> eq	% CHANGE
2025 .....	-8.6	-0.9	-0.04	-9.5	-4.7
2040 .....	-38.0	-4.0	-0.2	-42.2	-18.7
2050 .....	-45.5	-4.8	-0.2	-50.5	-20.3

**Note:**

<sup>a</sup>For an explanation of analytical Methods A and B, please see Section I.D; for an explanation of the flat baseline, 1a, and dynamic baseline, 1b, please see Section X.A.1.

(iii) HFC Emissions Projections

The projected HFC emission reductions due to the HD Phase 2 air conditioning leakage standards for vocational vehicles are 86,735 metric tons of CO<sub>2</sub>eq in 2025, 256,061 metric tons of CO<sub>2</sub>eq in 2040, and 314,930

metric tons CO<sub>2</sub>eq in 2050. See Chapter 5 of the RIA for additional details on calculations of HFC emissions.

(iv) Total (Downstream + Upstream + HFC) Emissions Projections

Table VII-23 combines the impacts of the final program from downstream

(Table VII-20), upstream (Table VII-22), and HFC to summarize the total GHG reductions in calendar years 2025, 2040 and 2050, relative to Alternative 1a.

TABLE VII-23—ANNUAL TOTAL GHG EMISSIONS IMPACTS IN CALENDAR YEARS 2025, 2040 AND 2050—FINAL PROGRAM VS. ALT 1a USING ANALYSIS METHOD B<sup>a</sup>

	CY2025		CY2040		CY2050	
	MMT CO <sub>2</sub> eq	% Change	MMT CO <sub>2</sub> eq	% Change	MMT CO <sub>2</sub> eq	% Change
Downstream .....	-27.8	-4.6	-124.3	-18.4	-148.4	-20.0
Upstream .....	-9.5	-4.7	-42.2	-18.7	-50.5	-20.3
HFC <sup>b</sup> .....	-0.1	-15.0	-0.3	-13.0	-0.3	-13.0
Total .....	-37.4	-4.7	-166.8	-18.5	-199.2	-20.1

**Note:**

<sup>a</sup>For an explanation of analytical Methods A and B, please see Section I.D; for an explanation of the flat baseline, 1a, and dynamic baseline, 1b, please see Section X.A.1.

<sup>b</sup>HFC represents HFC emission reductions and percent change from the vocational vehicle category only.

(b) Model Year Lifetime Analysis

In addition to the annual GHG emissions and fuel consumption reductions expected from the final rules, we estimated the combined

(downstream and upstream) GHG and fuel consumption impacts for the lifetime of the impacted vehicles sold in the regulatory timeframe. Table VII-24 shows the fleet-wide GHG reductions and fuel savings from the final program,

relative to Alternative 1a, through the lifetime of heavy-duty vehicles.<sup>553</sup> For the lifetime GHG reductions and fuel savings by vehicle categories, see Chapter 5 of the RIA.

TABLE VII-24—LIFETIME GHG REDUCTIONS AND FUEL SAVINGS USING ANALYSIS METHOD B—SUMMARY FOR MODEL YEARS 2018-2029<sup>a</sup>

Model years	Final program (Alternative 3)
	1a (Flat)
Fuel Savings (Billion Gallons) .....	82.2
Total GHG Reductions (MMT CO <sub>2</sub> eq) .....	1,097.6
Downstream (MMT CO <sub>2</sub> eq) .....	819.2
Upstream (MMT CO <sub>2</sub> eq) .....	278.4

**Note:**

<sup>553</sup> A lifetime of 30 years is assumed in MOVES.

<sup>a</sup>For an explanation of analytical Methods A and B, please see Section I.D; for an explanation of the flat baseline, 1a, and dynamic baseline, 1b, please see Section X.A.1.

#### D. Climate Impacts and Indicators

##### (1) Climate Change Impacts From GHG Emissions

The impact of GHG emissions on the climate has been reviewed in the 2009 Endangerment and Cause or Contribute Findings for Greenhouse Gases under Section 202(a) of the Clean Air Act, the 2012–2016 light-duty vehicle rulemaking, the 2014–2018 heavy-duty vehicle GHG and fuel efficiency rulemaking, the 2017–2025 light-duty vehicle rulemaking, and the standards for new electricity utility generating units. See 74 FR 66496; 75 FR 25491; 76 FR 57294; 77 FR 62894; 79 FR 1456–1459; 80 FR 64662. This section briefly discusses again some of the climate impact of EPA's actions in context of transportation emissions. NHTSA has analyzed the climate impacts of its specific actions (*i.e.*, excluding EPA's HFC regulatory provisions) as well as reasonable alternatives in its DEIS that accompanies this final rules. DOT has considered the potential climate impacts documented in the DEIS as part of the rulemaking process.

Once emitted, GHGs that are the subject of this regulation can remain in the atmosphere for decades to millennia, meaning that (1) their concentrations become well-mixed throughout the global atmosphere regardless of emission origin, and (2) their effects on climate are long lasting. GHG emissions come mainly from the combustion of fossil fuels (coal, oil, and gas), with additional contributions from the clearing of forests, agricultural activities, cement production, and some industrial activities. Transportation activities, in aggregate, were the second largest contributor to total U.S. GHG emissions in 2010 (27 percent of total emissions).<sup>554</sup>

The EPA Administrator relied on thorough and peer-reviewed assessments of climate change science prepared by the Intergovernmental Panel on Climate Change ("IPCC"), the United States Global Change Research Program ("USGCRP"), and the National Research Council of the National Academies ("NRC")<sup>555</sup> as the primary

<sup>554</sup> U.S. EPA (2012) Inventory of U.S. Greenhouse Gas Emissions and Sinks: 1990–2010. EPA 430-R-12-001. Available at <http://epa.gov/climatechange/emissions/downloads12/US-GHG-Inventory-2012-Main-Text.pdf>.

<sup>555</sup> For a complete list of core references from IPCC, USGCRP/CCSP, NRC and others relied upon for development of the TSD for EPA's Endangerment and Cause or Contribute Findings

scientific and technical basis for the Endangerment and Cause or Contribute Findings for Greenhouse Gases Under Section 202(a) of the Clean Air Act (74 FR 66496, December 15, 2009). These assessments comprehensively address the scientific issues the EPA Administrator had to examine, providing her data and information on a wide range of issues pertinent to the Endangerment Finding. These assessments have been rigorously reviewed by the expert community, and also by United States government agencies and scientists, including by EPA itself.

Based on these assessments, the EPA Administrator determined that the emissions from new motor vehicles and engines contribute to elevated concentrations of greenhouse gases; that these greenhouse gases cause warming; that the recent warming has been attributed to the increase in greenhouse gases; and that warming of the climate endangers the public health and welfare of current and future generations. See *Coalition for Responsible Regulation v. EPA*, 684 F. 3d 102, 121 (D.C. Cir. 2012) (upholding all of EPA's findings and stating "EPA had before it substantial record evidence that anthropogenic emissions of greenhouse gases 'very likely' caused warming of the climate over the last several decades. EPA further had evidence of current and future effects of this warming on public health and welfare. Relying again upon substantial scientific evidence, EPA determined that anthropogenically induced climate change threatens both public health and public welfare. It found that extreme weather events, changes in air quality, increases in food- and water-borne pathogens, and increases in temperatures are likely to have adverse health effects. The record also supports EPA's conclusion that climate change endangers human welfare by creating risk to food production and agriculture, forestry, energy, infrastructure, ecosystems, and wildlife. Substantial evidence further supported EPA's conclusion that the warming resulting from the greenhouse gas emissions could be expected to create risks to water resources and in general to coastal areas as a result of expected increase in sea level.")

A number of major peer-reviewed scientific assessments have been released since the administrative record

see Section 1(b), specifically, Table 1.1 of the TSD. (Docket EPA-HQ-OAR-2010-0799).

concerning the Endangerment Finding closed following EPA's 2010 Reconsideration Denial.<sup>556</sup> These assessments include the "Special Report on Managing the Risks of Extreme Events and Disasters to Advance Climate Change Adaptation"<sup>557</sup>, the 2013–14 Fifth Assessment Report (AR5),<sup>558</sup> the 2014 National Climate Assessment report,<sup>559</sup> the "Ocean Acidification: A National Strategy to Meet the Challenges of a Changing Ocean,"<sup>560</sup> "Report on Climate Stabilization Targets: Emissions, Concentrations, and Impacts over Decades to Millennia,"<sup>561</sup> "National Security Implications for U.S. Naval Forces" (National Security Implications),<sup>562</sup> "Understanding Earth's Deep Past: Lessons for Our Climate Future,"<sup>563</sup> "Sea Level Rise for

<sup>556</sup> "EPA's Denial of the Petitions to Reconsider the Endangerment and Cause or Contribute Findings for Greenhouse Gases under Section 202(a) of the Clean Air Act," 75 FR 49,556 (Aug. 13, 2010) ("Reconsideration Denial").

<sup>557</sup> Intergovernmental Panel on Climate Change (IPCC). 2012: Managing the Risks of Extreme Events and Disasters to Advance Climate Change Adaptation. A Special Report of Working Groups I and II of the Intergovernmental Panel on Climate Change. Cambridge University Press, Cambridge, UK, and New York, NY, USA.

<sup>558</sup> Intergovernmental Panel on Climate Change (IPCC). 2013. Climate Change 2013: The Physical Science Basis. Contribution of Working Group I to the Fifth Assessment Report of the Intergovernmental Panel on Climate Change. Cambridge University Press, Cambridge, United Kingdom and New York, NY, USA, Intergovernmental Panel on Climate Change (IPCC). 2014. Climate Change 2014: Impacts, Adaptation, and Vulnerability. Contribution of Working Group II to the Fifth Assessment Report of the Intergovernmental Panel on Climate Change. Cambridge University Press, Cambridge, United Kingdom and New York, NY, USA, Intergovernmental Panel on Climate Change (IPCC). 2014. Climate Change 2014: Mitigation of Climate Change. Contribution of Working Group III to the Fifth Assessment Report of the Intergovernmental Panel on Climate Change. Cambridge University Press, Cambridge, United Kingdom and New York, NY, USA.

<sup>559</sup> Melillo, Jerry M., Terese (T.C.) Richmond, and Gary W. Yohe, Eds. 2014. Climate Change Impacts in the United States: The Third National Climate Assessment. U.S. Global Change Research Program. Available at <http://nca2014.globalchange.gov>.

<sup>560</sup> National Research Council (NRC). 2010. Ocean Acidification: A National Strategy to Meet the Challenges of a Changing Ocean. National Academies Press. Washington, DC.

<sup>561</sup> National Research Council (NRC). 2011. Climate Stabilization Targets: Emissions, Concentrations, and Impacts over Decades to Millennia. National Academies Press, Washington, DC.

<sup>562</sup> National Research Council (NRC). 2011. National Security Implications of Climate Change for U.S. Naval Forces. National Academies Press. Washington, DC.

<sup>563</sup> National Research Council (NRC). 2012. Sea-Level Rise for the Coasts of California, Oregon, and



the Coasts of California, Oregon, and Washington: Past, Present, and Future,”<sup>564</sup> “Climate and Social Stress: Implications for Security Analysis,”<sup>565</sup> and “Abrupt Impacts of Climate Change” (Abrupt Impacts) assessments.<sup>566</sup>

EPA has reviewed these assessments and finds that, in general, the improved understanding of the climate system they present is consistent with the assessments underlying the 2009 Endangerment Finding.

The most recent assessments released were the IPCC AR5 assessments between September 2013 and April 2014, the NRC Abrupt Impacts assessment in December of 2013, and the U.S. National Climate Assessment in May of 2014. The NRC Abrupt Impacts report examines the potential for tipping points, thresholds beyond which major and rapid changes occur in the Earth's climate system or other systems impacted by the climate. The Abrupt Impacts report did find less cause for concern than some previous assessments regarding some abrupt events within the next century, such as disruption of the Atlantic Meridional Overturning Circulation (AMOC) and sudden releases of high-latitude methane from hydrates and permafrost, but found that the potential for abrupt changes in ecosystems, weather and climate extremes, and groundwater supplies critical for agriculture now seem more likely, severe, and imminent. The assessment found that some abrupt changes were already underway (Arctic sea ice retreat and increases in extinction risk due to the speed of climate change) but cautioned that even abrupt changes such as the AMOC disruption that are not expected in this century can have severe impacts when they happen.

The IPCC AR5 assessments are also generally consistent with the underlying science supporting the 2009 Endangerment Finding. For example, confidence in attributing recent warming to human causes has increased: The IPCC stated that it is extremely likely ( $\geq 95$  percent confidence) that human influences have

been the dominant cause of recent warming. Moreover, the IPCC found that the last 30 years were likely ( $\leq 66$  percent confidence) the warmest 30 year period in the Northern Hemisphere of the past 1400 years, that the rate of ice loss of worldwide glaciers and the Greenland and Antarctic ice sheets has likely increased, that there is medium confidence that the recent summer sea ice retreat in the Arctic is larger than it has been in 1450 years, and that concentrations of carbon dioxide and several other of the major greenhouse gases are higher than they have been in at least 800,000 years. Climate-change induced impacts have been observed in changing precipitation patterns, melting snow and ice, species migration, negative impacts on crops, increased heat and decreased cold mortality, and altered ranges for water-borne illnesses and disease vectors. Additional risks from future changes include death, injury, and disrupted livelihoods in coastal zones and regions vulnerable to inland flooding, food insecurity linked to warming, drought, and flooding, especially for poor populations, reduced access to drinking and irrigation water for those with minimal capital in semi-arid regions, and decreased biodiversity in marine ecosystems, especially in the Arctic and tropics, with implications for coastal livelihoods. The IPCC determined that “[c]ontinued emissions of greenhouse gases will cause further warming and changes in all components of the climate system. Limiting climate change will require substantial and sustained reductions of greenhouse gases emissions.”

Finally, the recently released National Climate Assessment stated, “Climate change is already affecting the American people in far reaching ways. Certain types of extreme weather events with links to climate change have become more frequent and/or intense, including prolonged periods of heat, heavy downpours, and, in some regions, floods and droughts. In addition, warming is causing sea level to rise and glaciers and Arctic sea ice to melt, and oceans are becoming more acidic as they absorb carbon dioxide. These and other aspects of climate change are disrupting people's lives and damaging some sectors of our economy.”

Assessments from these bodies represent the current state of knowledge, comprehensively cover and synthesize thousands of individual studies to obtain the majority conclusions from the body of scientific literature and undergo a rigorous and exacting standard of review by the peer expert community and U.S. government.

Based on modeling analysis performed by the agencies, reductions in CO<sub>2</sub> and other GHG emissions associated with these final rules will affect future climate change. Since GHGs are well-mixed in the atmosphere and have long atmospheric lifetimes, changes in GHG emissions will affect atmospheric concentrations of greenhouse gases and future climate for decades to millennia, depending on the gas. This section provides estimates of the projected change in atmospheric CO<sub>2</sub> concentrations based on the emission reductions estimated for these final rules, compared to the reference case. In addition, this section analyzes the response to the changes in GHG concentrations of the following climate-related variables: Global mean temperature, sea level rise, and ocean pH.

## (2) Projected Change in Atmospheric CO<sub>2</sub> Concentrations, Global Mean Surface Temperature and Sea Level Rise

To assess the impact of the emissions reductions from the final rules, EPA estimated changes in projected atmospheric CO<sub>2</sub> concentrations, global mean surface temperature and sea-level rise to 2100 using the GCAM (Global Change Assessment Model, formerly MiniCAM), integrated assessment model<sup>567</sup> coupled with the MAGICC (Model for the Assessment of Greenhouse-gas Induced Climate Change) simple climate model.<sup>568</sup> GCAM was used to create the globally and temporally consistent set of climate relevant emissions required for running MAGICC. MAGICC was then used to estimate the projected change in relevant climate variables over time. Given the magnitude of the estimated

<sup>567</sup> GCAM is a long-term, global integrated assessment model of energy, economy, agriculture and land use that considers the sources of emissions of a suite of greenhouse gases (GHG's), emitted in 14 globally disaggregated regions, the fate of emissions to the atmosphere, and the consequences of changing concentrations of greenhouse related gases for climate change. GCAM begins with a representation of demographic and economic developments in each region and combines these with assumptions about technology development to describe an internally consistent representation of energy, agriculture, land-use, and economic developments that in turn shape global emissions.

<sup>568</sup> MAGICC consists of a suite of coupled gas-cycle, climate and ice-melt models integrated into a single framework. The framework allows the user to determine changes in greenhouse-gas concentrations, global-mean surface air temperature and sea-level resulting from anthropogenic emissions of carbon dioxide (CO<sub>2</sub>), methane (CH<sub>4</sub>), nitrous oxide (N<sub>2</sub>O), reactive gases (CO, NO<sub>x</sub>, VOCs), the halocarbons (e.g. HCFCs, HFCs, PFCs) and sulfur dioxide (SO<sub>2</sub>). MAGICC emulates the global-mean temperature responses of more sophisticated coupled Atmosphere/Ocean General Circulation Models (AOGCMs) with high accuracy.

Washington: Past, Present, and Future. National Academies Press. Washington, DC.

<sup>564</sup> National Research Council (NRC). 2012. Sea-Level Rise for the Coasts of California, Oregon, and Washington: Past, Present, and Future. National Academies Press. Washington, DC.

<sup>565</sup> National Research Council (NRC). 2013. Climate and Social Stress: Implications for Security Analysis. National Academies Press. Washington, DC.

<sup>566</sup> National Research Council (NRC). 2013. Abrupt Impacts of Climate Change: Anticipating Surprises. National Academies Press. Washington, DC.

emissions reductions associated with these rules, a simple climate model such as MAGICC is appropriate for estimating the atmospheric and climate response.

The analysis projects that the final rules will reduce atmospheric concentrations of CO<sub>2</sub>, global climate warming, ocean acidification, and sea level rise relative to the reference case. Although the projected reductions and improvements are small in comparison to the total projected climate change, they are quantifiable, directionally consistent, and will contribute to reducing the risks associated with climate change. Climate change is a global phenomenon, and EPA

recognizes that this one national action alone will not prevent it; EPA notes this would be true for any given GHG mitigation action when taken alone or when considered in isolation. EPA also notes that a substantial portion of CO<sub>2</sub> emitted into the atmosphere is not removed by natural processes for millennia, and therefore each unit of CO<sub>2</sub> not emitted into the atmosphere due to this rules avoids essentially permanent climate change on centennial time scales.

EPA determines that the projected reductions in atmospheric CO<sub>2</sub>, global mean temperature, sea level rise, and ocean pH are meaningful in the context

of this action. The results of the analysis, summarized in Table VII–25, demonstrate that relative to the reference case, by 2100 projected atmospheric CO<sub>2</sub> concentrations are estimated to be reduced by 1.2 to 1.3 part per million by volume (ppmv), global mean temperature is estimated to be reduced by 0.0027 to 0.0065 °C, and sea-level rise is projected to be reduced by approximately 0.026 to 0.058 cm, based on a range of climate sensitivities (described below). Details about this modeling analysis can be found in the RIA Chapter 6.3.

TABLE VII–25—IMPACT OF GHG EMISSIONS REDUCTIONS ON PROJECTED CHANGES IN GLOBAL CLIMATE ASSOCIATED WITH PHASE 2 STANDARDS FOR MY 2018–2024

[Based on a range of climate sensitivities from 1.5–6 °C]

Variable	Units	Year	Projected change
Atmospheric CO <sub>2</sub> Concentration .....	ppmv	2100	– 1.2 to – 1.3
Global Mean Surface Temperature .....	°C	2100	– 0.0027 to – 0.0065
Sea Level Rise .....	cm	2100	– 0.026 to – 0.058
Ocean pH .....	pH units	2100	+0.0006 <sup>a</sup>

**Note:**

<sup>a</sup> The value for projected change in ocean pH is based on a climate sensitivity of 3.0.

The projected reductions are small relative to the change in temperature (1.8–4.8 °C), CO<sub>2</sub> concentration (404 to 470 ppm), sea level rise (23–56 cm), and ocean acidity (– 0.30 pH units) from 1990 to 2100 from the MAGICC simulations for the GCAM reference case. However, this is to be expected given the magnitude of emissions reductions expected from the program in the context of global emissions. Moreover, these effects are occurring everywhere around the globe, so benefits that appear to be marginal for any one location, such as a reduction in sea level rise of half a millimeter, can be sizable when the effects are summed along thousands of miles of coastline. This uncertainty range does not include the effects of uncertainty in future emissions. It should also be noted that the calculations in MAGICC do not include the possible effects of accelerated ice flow in Greenland and/or Antarctica: estimates of sea level rise from the recent NRC, IPCC, and NCA assessments range from 26 cm to 2 meters depending on the emissions scenario, the processes included, and the likelihood range assessed; inclusion of these effects would lead to correspondingly larger benefits of mitigation. Further discussion of EPA’s modeling analysis is found in the RIA, Chapter 6.3.

Based on the projected atmospheric CO<sub>2</sub> concentration reductions resulting

from these final rules, EPA calculates an increase in ocean pH of 0.0006 pH units in 2100 relative to the baseline case (this is a reduction in the expected acidification of the ocean of a decrease of 0.3 pH units from 1990 to 2100 in the baseline case). Thus, this analysis indicates the projected decrease in atmospheric CO<sub>2</sub> concentrations from the Phase 2 standards will result in an increase in ocean pH (*i.e.*, a reduction in the expected acidification of the ocean in the reference case). A more detailed discussion of the modeling analysis associated with ocean pH is provided in the RIA, Chapter 6.3.

The 2011 NRC assessment on “Climate Stabilization Targets: Emissions, Concentrations, and Impacts over Decades to Millennia” determined how a number of climate impacts—such as heaviest daily rainfalls, crop yields, and Arctic sea ice extent—would change with a temperature change of 1 degree Celsius (C) of warming. These relationships of impacts with temperature change could be combined with the calculated reductions in warming in Table VII–25 to estimate changes in these impacts associated with this final rulemaking.

As a substantial portion of CO<sub>2</sub> emitted into the atmosphere is not removed by natural processes for millennia, each unit of CO<sub>2</sub> not emitted into the atmosphere avoids some degree of effectively permanent climate change.

Therefore, reductions in emissions in the near term are important in determining climate impacts experienced not just over the next decades but over thousands of years.<sup>569</sup> Though the magnitude of the avoided climate change projected here in isolation is small in comparison to the total projected changes, these reductions represent a reduction in the adverse risks associated with climate change (though these risks were not formally estimated for this action) across a range of equilibrium climate sensitivities. In addition, these reductions are part of a larger suite of domestic and international mitigation actions, and should be considered in that context.

EPA’s analysis of this final rule’s impact on global climate conditions is intended to quantify these potential reductions using the best available science. EPA’s modeling results show consistent reductions relative to the baseline case in changes of CO<sub>2</sub> concentration, temperature, sea-level rise, and ocean pH over the next century.

<sup>569</sup> National Research Council (NRC) (2011). Climate Stabilization Targets: Emissions, Concentrations, and Impacts over Decades to Millennia. National Academy Press, Washington, DC. (Docket EPA–HQ–OAR–2010–0799).

## VIII. How will these rules impact non-GHG emissions and their associated effects?

The heavy-duty vehicle standards are expected to influence the emissions of criteria air pollutants and several hazardous air pollutants (air toxics). This section describes the projected impacts of the final rules on non-GHG emissions and air quality and the health and environmental effects associated with these pollutants. NHTSA further analyzes these projected health and environmental effects resulting from its final rules and reasonable alternatives in Chapter 4 of its FEIS.

### A. Health Effects of Non-GHG Pollutants

In this section, we discuss health effects associated with exposure to some of the criteria and air toxic pollutants impacted by the final heavy-duty vehicle standards.

#### (1) Particulate Matter

##### (a) Background

Particulate matter is a highly complex mixture of solid particles and liquid droplets distributed among numerous atmospheric gases which interact with solid and liquid phases. Particles range in size from those smaller than 1 nanometer ( $10^{-9}$  meter) to over 100 micrometers ( $\mu\text{m}$ , or  $10^{-6}$  meter) in diameter (for reference, a typical strand of human hair is 70  $\mu\text{m}$  in diameter and a grain of salt is about 100  $\mu\text{m}$ ). Atmospheric particles can be grouped into several classes according to their aerodynamic and physical sizes. Generally, the three broad classes of particles include ultrafine particles (UFPs, generally considered as particulates with a diameter less than or equal to 0.1  $\mu\text{m}$  [typically based on physical size, thermal diffusivity or electrical mobility]), “fine” particles ( $\text{PM}_{2.5}$ ; particles with a nominal mean aerodynamic diameter less than or equal to 2.5  $\mu\text{m}$ ), and “thoracic” particles ( $\text{PM}_{10}$ ; particles with a nominal mean aerodynamic diameter less than or equal to 10  $\mu\text{m}$ ).<sup>570</sup> Particles that fall within the size range between  $\text{PM}_{2.5}$  and  $\text{PM}_{10}$ , are referred to as “thoracic coarse particles” ( $\text{PM}_{10-2.5}$ , particles with a nominal mean aerodynamic diameter less than or equal to 10  $\mu\text{m}$  and greater than 2.5  $\mu\text{m}$ ). EPA currently has standards that regulate  $\text{PM}_{2.5}$  and  $\text{PM}_{10}$ .<sup>571</sup>

<sup>570</sup> U.S. EPA. (2009). Integrated Science Assessment for Particulate Matter (Final Report). U.S. Environmental Protection Agency, Washington, DC, EPA/600/R-08/139F. Figure 3-1.

<sup>571</sup> Regulatory definitions of PM size fractions, and information on reference and equivalent methods for measuring PM in ambient air, are

Particles span many sizes and shapes and may consist of hundreds of different chemicals. Particles are emitted directly from sources and are also formed through atmospheric chemical reactions; the former are often referred to as “primary” particles, and the latter as “secondary” particles. Particle concentration and composition varies by time of year and location, and, in addition to differences in source emissions, is affected by several weather-related factors, such as temperature, clouds, humidity, and wind. A further layer of complexity comes from particles’ ability to shift between solid/liquid and gaseous phases, which is influenced by concentration and meteorology, especially temperature.

Fine particles are produced primarily by combustion processes and by transformations of gaseous emissions (e.g., sulfur oxides ( $\text{SO}_x$ ), oxides of nitrogen, and volatile organic compounds (VOC)) in the atmosphere. The chemical and physical properties of  $\text{PM}_{2.5}$  may vary greatly with time, region, meteorology, and source category. Thus,  $\text{PM}_{2.5}$  may include a complex mixture of different components including sulfates, nitrates, organic compounds, elemental carbon and metal compounds. These particles can remain in the atmosphere for days to weeks and travel hundreds to thousands of kilometers.

##### (b) Health Effects of PM

Scientific studies show exposure to ambient PM is associated with a broad range of health effects. These health effects are discussed in detail in the Integrated Science Assessment for Particulate Matter (PM ISA), which was finalized in December 2009.<sup>572</sup> The PM ISA summarizes health effects evidence for short- and long-term exposures to  $\text{PM}_{2.5}$ ,  $\text{PM}_{10-2.5}$ , and ultrafine particles.<sup>573</sup> The PM ISA concludes that human exposures to ambient  $\text{PM}_{2.5}$  are associated with a number of adverse health effects and characterizes the weight of evidence for broad health categories (e.g., cardiovascular effects,

provided in 40 CFR parts 50, 53, and 58. With regard to national ambient air quality standards (NAAQS) which provide protection against health and welfare effects, the 24-hour  $\text{PM}_{10}$  standard provides protection against effects associated with short-term exposure to thoracic coarse particles (i.e.,  $\text{PM}_{10-2.5}$ ).

<sup>572</sup> U.S. EPA. (2009). Integrated Science Assessment for Particulate Matter (Final Report). U.S. Environmental Protection Agency, Washington, DC, EPA/600/R-08/139F.

<sup>573</sup> The ISA also evaluated evidence for PM components but did not reach causal determinations for components.

respiratory effects, etc.).<sup>574</sup> The discussion below highlights the PM ISA’s conclusions pertaining to health effects associated with both short- and long-term PM exposures. Further discussion of health effects associated with PM can also be found in the rulemaking documents for the most recent review of the PM NAAQS completed in 2012.<sup>575 576</sup>

EPA has concluded that “a causal relationship exists” between both long- and short-term exposures to  $\text{PM}_{2.5}$  and premature mortality and cardiovascular effects and that “a causal relationship is likely to exist” between long- and short-term  $\text{PM}_{2.5}$  exposures and respiratory effects. Further, there is evidence “suggestive of a causal relationship” between long-term  $\text{PM}_{2.5}$  exposures and other health effects, including developmental and reproductive effects (e.g., low birth weight, infant mortality) and carcinogenic, mutagenic, and genotoxic effects (e.g., lung cancer mortality).<sup>577</sup>

As summarized in the final rule resulting from the last review (2012) of the PM NAAQS, and discussed extensively in the 2009 p.m. ISA, the available scientific evidence significantly strengthens the link between long- and short-term exposure to  $\text{PM}_{2.5}$  and mortality, while providing indications that the magnitude of the  $\text{PM}_{2.5}$ -mortality association with long-term exposures may be larger than previously estimated.<sup>578 579</sup> The strongest evidence comes from recent

<sup>574</sup> The causal framework draws upon the assessment and integration of evidence from across epidemiological, controlled human exposure, and toxicological studies, and the related uncertainties that ultimately influence our understanding of the evidence. This framework employs a five-level hierarchy that classifies the overall weight of evidence and causality using the following categorizations: causal relationship, likely to be causal relationship, suggestive of a causal relationship, inadequate to infer a causal relationship, and not likely to be a causal relationship (U.S. EPA. (2009). Integrated Science Assessment for Particulate Matter (Final Report). U.S. Environmental Protection Agency, Washington, DC, EPA/600/R-08/139F, Table 1-3).

<sup>575</sup> 78 FR 3103-3104, January 15, 2013.

<sup>576</sup> 77 FR 38906-38911, June 29, 2012.

<sup>577</sup> These causal inferences are based not only on the more expansive epidemiological evidence available in this review but also reflect consideration of important progress that has been made to advance our understanding of a number of potential biologic modes of action or pathways for PM-related cardiovascular and respiratory effects (U.S. EPA. (2009). Integrated Science Assessment for Particulate Matter (Final Report). U.S. Environmental Protection Agency, Washington, DC, EPA/600/R-08/139F, Chapter 5).

<sup>578</sup> 78 FR 3103-3104, January 15, 2013.

<sup>579</sup> U.S. EPA. (2009). Integrated Science Assessment for Particulate Matter (Final Report). U.S. Environmental Protection Agency, Washington, DC, EPA/600/R-08/139F, Chapter 6 (Section 6.5) and Chapter 7 (Section 7.6).

studies investigating long-term exposure to PM<sub>2.5</sub> and cardiovascular-related mortality. The evidence supporting a causal relationship between long-term PM<sub>2.5</sub> exposure and mortality also includes consideration of studies that demonstrated an improvement in community health following reductions in ambient fine particles.

Several studies evaluated in the 2009 p.m. ISA have examined the association between cardiovascular effects and long-term PM<sub>2.5</sub> exposures in multi-city epidemiological studies conducted in the U.S. and Europe. These studies have provided new evidence linking long-term exposure to PM<sub>2.5</sub> with an array of cardiovascular effects such as heart attacks, congestive heart failure, stroke, and mortality. This evidence is coherent with studies of effects associated with short-term exposure to PM<sub>2.5</sub> that have observed associations with a continuum of effects ranging from subtle changes in indicators of cardiovascular health to serious clinical events, such as increased hospitalizations and emergency department visits due to cardiovascular disease and cardiovascular mortality.<sup>580</sup>

As detailed in the 2009 p.m. ISA, extended analyses of seminal epidemiological studies, as well as more recent epidemiological studies conducted in the U.S. and abroad, provide strong evidence of respiratory-related morbidity effects associated with long-term PM<sub>2.5</sub> exposure. The strongest evidence for respiratory-related effects is from studies that evaluated decrements in lung function growth (in children), increased respiratory symptoms, and asthma development. The strongest evidence from short-term PM<sub>2.5</sub> exposure studies has been observed for increased respiratory-related emergency department visits and hospital admissions for chronic obstructive pulmonary disease (COPD) and respiratory infections.<sup>581</sup>

The body of scientific evidence detailed in the 2009 PM ISA is still limited with respect to associations between long-term PM<sub>2.5</sub> exposures and developmental and reproductive effects as well as cancer, mutagenic, and genotoxic effects. The strongest evidence for an association between PM<sub>2.5</sub> and developmental and

reproductive effects comes from epidemiological studies of low birth weight and infant mortality, especially due to respiratory causes during the post-neonatal period (*i.e.*, 1 month to 12 months of age).<sup>582</sup> With regard to cancer effects, “[m]ultiple epidemiologic studies have shown a consistent positive association between PM<sub>2.5</sub> and lung cancer mortality, but studies have generally not reported associations between PM<sub>2.5</sub> and lung cancer incidence.”<sup>583</sup>

In addition to evaluating the health effects attributed to short- and long-term exposure to PM<sub>2.5</sub>, the 2009 PM ISA also evaluated whether specific components or sources of PM<sub>2.5</sub> are more strongly associated with specific health effects. An evaluation of those studies resulted in the 2009 PM ISA concluding that “many [components] of PM can be linked with differing health effects and the evidence is not yet sufficient to allow differentiation of those [components] or sources that are more closely related to specific health outcomes.”<sup>584</sup>

For PM<sub>10-2.5</sub>, the 2009 PM ISA concluded that available evidence was “suggestive of a causal relationship” between short-term exposures to PM<sub>10-2.5</sub> and cardiovascular effects (*e.g.*, hospital admissions and Emergency Department (ED) visits, changes in cardiovascular function), respiratory effects (*e.g.*, ED visits and hospital admissions, increase in markers of pulmonary inflammation), and premature mortality. The scientific evidence was “inadequate to infer a causal relationship” between long-term exposure to PM<sub>10-2.5</sub> and various health effects.<sup>585 586 587</sup>

For UFPs, the 2009 PM ISA concluded that the evidence was “suggestive of a causal relationship” between short-term exposures and cardiovascular effects, including changes in heart rhythm and vasomotor function (the ability of blood vessels to

expand and contract). It also concluded that there was evidence “suggestive of a causal relationship” between short-term exposure to UFPs and respiratory effects, including lung function and pulmonary inflammation, with limited and inconsistent evidence for increases in ED visits and hospital admissions. Scientific evidence was “inadequate to infer a causal relationship” between short-term exposure to UFPs and additional health effects including premature mortality as well as long-term exposure to UFPs and all health outcomes evaluated.<sup>588 589</sup>

The 2009 PM ISA conducted an evaluation of specific groups within the general population potentially at increased risk for experiencing adverse health effects related to PM exposures.<sup>590 591 592 593</sup> The evidence detailed in the 2009 PM ISA expands our understanding of previously identified at-risk populations and lifestages (*i.e.*, children, older adults, and individuals with pre-existing heart and lung disease) and supports the identification of additional at-risk populations (*e.g.*, persons with lower socioeconomic status, genetic differences). Additionally, there is emerging, though still limited, evidence for additional potentially at-risk populations and lifestages, such as those with diabetes, people who are obese, pregnant women, and the developing fetus.<sup>594</sup>

## (2) Ozone

### (a) Background

Ground-level ozone pollution is typically formed through reactions involving VOC and NO<sub>x</sub> in the lower atmosphere in the presence of sunlight. These pollutants, often referred to as ozone precursors, are emitted by many types of pollution sources, such as highway and nonroad motor vehicles and engines, power plants, chemical

<sup>588</sup> U.S. EPA. (2009). Integrated Science Assessment for Particulate Matter (Final Report). U.S. Environmental Protection Agency, Washington, DC, EPA/600/R-08/139F. Section 2.3.5 and Table 2-6.

<sup>589</sup> 78 FR 3121, January 15, 2013.

<sup>590</sup> U.S. EPA. (2009). Integrated Science Assessment for Particulate Matter (Final Report). U.S. Environmental Protection Agency, Washington, DC, EPA/600/R-08/139F. Chapter 8 and Chapter 2.

<sup>591</sup> 77 FR 38890, June 29, 2012.

<sup>592</sup> 78 FR 3104, January 15, 2013.

<sup>593</sup> U.S. EPA. (2011). Policy Assessment for the Review of the PM NAAQS. U.S. Environmental Protection Agency, Washington, DC, EPA/452/R-11-003. Section 2.2.1.

<sup>594</sup> U.S. EPA. (2009). Integrated Science Assessment for Particulate Matter (Final Report). U.S. Environmental Protection Agency, Washington, DC, EPA/600/R-08/139F. Chapter 8 and Chapter 2 (Section 2.4.1).

<sup>580</sup> U.S. EPA. (2009). Integrated Science Assessment for Particulate Matter (Final Report). U.S. Environmental Protection Agency, Washington, DC, EPA/600/R-08/139F. Chapter 2 (Section 2.3.1 and 2.3.2) and Chapter 6.

<sup>581</sup> U.S. EPA. (2009). Integrated Science Assessment for Particulate Matter (Final Report). U.S. Environmental Protection Agency, Washington, DC, EPA/600/R-08/139F. Chapter 2 (Section 2.3.1 and 2.3.2) and Chapter 6.

<sup>582</sup> U.S. EPA. (2009). Integrated Science Assessment for Particulate Matter (Final Report). U.S. Environmental Protection Agency, Washington, DC, EPA/600/R-08/139F. Chapter 2 (Section 2.3.1 and 2.3.2) and Chapter 7.

<sup>583</sup> U.S. EPA. (2009). Integrated Science Assessment for Particulate Matter (Final Report). U.S. Environmental Protection Agency, Washington, DC, EPA/600/R-08/139F. pg 2-13.

<sup>584</sup> U.S. EPA. (2009). Integrated Science Assessment for Particulate Matter (Final Report). U.S. Environmental Protection Agency, Washington, DC, EPA/600/R-08/139F. pg 2-26.

<sup>585</sup> U.S. EPA. (2009). Integrated Science Assessment for Particulate Matter (Final Report). U.S. Environmental Protection Agency, Washington, DC, EPA/600/R-08/139F. Section 2.3.4 and Table 2-6.

<sup>586</sup> 78 FR 3167-3168, January 15, 2013.

<sup>587</sup> 77 FR 38947-38951, June 29, 2012.

plants, refineries, makers of consumer and commercial products, industrial facilities, and smaller area sources.

The science of ozone formation, transport, and accumulation is complex. Ground-level ozone is produced and destroyed in a cyclical set of chemical reactions, many of which are sensitive to temperature and sunlight. When ambient temperatures and sunlight levels remain high for several days and the air is relatively stagnant, ozone and its precursors can build up and result in more ozone than typically occurs on a single high-temperature day. Ozone and its precursors can be transported hundreds of miles downwind from precursor emissions, resulting in elevated ozone levels even in areas with low local VOC or NO<sub>x</sub> emissions.

#### (b) Health Effects of Ozone

This section provides a summary of the health effects associated with exposure to ambient concentrations of ozone.<sup>595</sup> The information in this section is based on the information and conclusions in the February 2013 Integrated Science Assessment for Ozone (Ozone ISA), which formed the basis for EPA's revision to the primary and secondary standards in 2015.<sup>596</sup> The Ozone ISA concludes that human exposures to ambient concentrations of ozone are associated with a number of adverse health effects and characterizes the weight of evidence for these health effects.<sup>597</sup> The discussion below highlights the Ozone ISA's conclusions pertaining to health effects associated with both short-term and long-term periods of exposure to ozone.

For short-term exposure to ozone, the Ozone ISA concludes that respiratory effects, including lung function decrements, pulmonary inflammation, exacerbation of asthma, respiratory-related hospital admissions, and

mortality, are causally associated with ozone exposure. It also concludes that cardiovascular effects, including decreased cardiac function and increased vascular disease, and total mortality are likely to be causally associated with short-term exposure to ozone and that evidence is suggestive of a causal relationship between central nervous system effects and short-term exposure to ozone.

For long-term exposure to ozone, the Ozone ISA concludes that respiratory effects, including new onset asthma, pulmonary inflammation and injury, are likely to be causally related with ozone exposure. The Ozone ISA characterizes the evidence as suggestive of a causal relationship for associations between long-term ozone exposure and cardiovascular effects, reproductive and developmental effects, central nervous system effects and total mortality. The evidence is inadequate to infer a causal relationship between chronic ozone exposure and increased risk of lung cancer.

Finally, inter-individual variation in human responses to ozone exposure can result in some groups being at increased risk for detrimental effects in response to exposure. In addition, some groups are at increased risk of exposure due to their activities, such as outdoor workers or children. The Ozone ISA identified several groups that are at increased risk for ozone-related health effects. These groups are people with asthma, children and older adults, individuals with reduced intake of certain nutrients (*i.e.*, Vitamins C and E), outdoor workers, and individuals having certain genetic variants related to oxidative metabolism or inflammation. Ozone exposure during childhood can have lasting effects through adulthood. Such effects include altered function of the respiratory and immune systems. Children absorb higher doses (normalized to lung surface area) of ambient ozone, compared to adults, due to their increased time spent outdoors, higher ventilation rates relative to body size, and a tendency to breathe a greater fraction of air through the mouth. Children also have a higher asthma prevalence compared to adults. Additional children's vulnerability and susceptibility factors are listed in Section XIV.

### (3) Nitrogen Oxides

#### (a) Background

Oxides of nitrogen (NO<sub>x</sub>) refers to nitric oxide and nitrogen dioxide (NO<sub>2</sub>). For the NO<sub>x</sub> NAAQS, NO<sub>2</sub> is the indicator. Most NO<sub>2</sub> is formed in the air through the oxidation of nitric oxide

(NO) emitted when fuel is burned at a high temperature. NO<sub>x</sub> is also a major contributor to secondary PM<sub>2.5</sub> formation. The health effects of ambient PM are discussed in Section VIII.A.1.b of this Preamble. NO<sub>x</sub> and VOC are the two major precursors of ozone. The health effects of ozone are covered in Section VIII.A.2.b.

#### (b) Health Effects of Nitrogen Oxides

The most recent review of the health effects of oxides of nitrogen completed by EPA can be found in the 2016 Integrated Science Assessment for Oxides of Nitrogen—Health Criteria (Oxides of Nitrogen ISA).<sup>598</sup> The primary source of NO<sub>2</sub> is motor vehicle emissions, and ambient NO<sub>2</sub> concentrations tend to be highly correlated with other traffic-related pollutants. Thus, a key issue in characterizing the causality of NO<sub>2</sub>-health effect relationships was evaluating the extent to which studies supported an effect of NO<sub>2</sub> that is independent of other traffic-related pollutants. EPA concluded that the findings for asthma exacerbation integrated from epidemiologic and controlled human exposure studies provided evidence that is sufficient to infer a causal relationship between respiratory effects and short-term NO<sub>2</sub> exposure. The strongest evidence supporting an independent effect of NO<sub>2</sub> exposure comes from controlled human exposure studies demonstrating increased airway responsiveness in individuals with asthma following ambient-relevant NO<sub>2</sub> exposures. The coherence of this evidence with epidemiologic findings for asthma hospital admissions and ED visits as well as lung function decrements and increased pulmonary inflammation in children with asthma describe a plausible pathway by which NO<sub>2</sub> exposure can cause an asthma exacerbation. The 2016 ISA for Oxides of Nitrogen also concluded that there is likely to be a causal relationship between long-term NO<sub>2</sub> exposure and respiratory effects. This conclusion is based on new epidemiologic evidence for associations of NO<sub>2</sub> with asthma development in children combined with biological plausibility from experimental studies.

In evaluating a broader range of health effects, the 2016 ISA for Oxides of Nitrogen concluded evidence is “suggestive of, but not sufficient to infer, a causal relationship” between

<sup>595</sup> Human exposure to ozone varies over time due to changes in ambient ozone concentration and because people move between locations which have notable different ozone concentrations. Also, the amount of ozone delivered to the lung is not only influenced by the ambient concentrations but also by the individuals breathing route and rate.

<sup>596</sup> U.S. EPA. Integrated Science Assessment of Ozone and Related Photochemical Oxidants (Final Report). U.S. Environmental Protection Agency, Washington, DC, EPA/600/R-10/076F, 2013. The ISA is available at <http://cfpub.epa.gov/ncea/isa/recordisplay.cfm?deid=247492#Download>.

<sup>597</sup> The ISA evaluates evidence and draws conclusions on the causal nature of relationship between relevant pollutant exposures and health effects, assigning one of five “weight of evidence” determinations: causal relationship, likely to be a causal relationship, suggestive of, but not sufficient to infer, a causal relationship, inadequate to infer a causal relationship, and not likely to be a causal relationship. For more information on these levels of evidence, please refer to Table II in the Preamble of the ISA.

<sup>598</sup> U.S. EPA. Integrated Science Assessment for Oxides of Nitrogen—Health Criteria (2016 Final Report). U.S. Environmental Protection Agency, Washington, DC, EPA/600/R-15/068, 2016.

short-term NO<sub>2</sub> exposure and cardiovascular effects and mortality and between long-term NO<sub>2</sub> exposure and cardiovascular effects and diabetes, birth outcomes, and cancer. In addition, the scientific evidence is inadequate (insufficient consistency of epidemiologic and toxicological evidence) to infer a causal relationship for long-term NO<sub>2</sub> exposure with fertility, reproduction, and pregnancy, as well as with postnatal development. A key uncertainty in understanding the relationship between these non-respiratory health effects and short- or long-term exposure to NO<sub>2</sub> is copollutant confounding, particularly by other roadway pollutants. The available evidence for non-respiratory health effects does not adequately address whether NO<sub>2</sub> has an independent effect or whether it primarily represents effects related to other or a mixture of traffic-related pollutants.

The 2016 ISA for Oxides of Nitrogen concluded that people with asthma, children, and older adults are at increased risk for NO<sub>2</sub>-related health effects. In these groups and lifestages, NO<sub>2</sub> is consistently related to larger effects on outcomes related to asthma exacerbation, for which there is confidence in the relationship with NO<sub>2</sub> exposure.

#### (4) Sulfur Oxides

##### (a) Background

Sulfur dioxide (SO<sub>2</sub>), a member of the sulfur oxide (SO<sub>x</sub>) family of gases, is formed from burning fuels containing sulfur (*e.g.*, coal or oil derived), extracting gasoline from oil, or extracting metals from ore. SO<sub>2</sub> and its gas phase oxidation products can dissolve in water droplets and further oxidize to form sulfuric acid which reacts with ammonia to form sulfates, which are important components of ambient PM. The health effects of ambient PM are discussed in Section VIII.A.1.b of this Preamble.

##### (b) Health Effects of SO<sub>2</sub>

Information on the health effects of SO<sub>2</sub> can be found in the 2008 Integrated Science Assessment for Sulfur Oxides—Health Criteria (SO<sub>x</sub> ISA).<sup>599</sup> Short-term peaks (5–10 minutes) of SO<sub>2</sub> have long been known to cause adverse respiratory health effects, particularly among individuals with asthma. In addition to those with asthma (both children and

adults), potentially at-risk lifestages include all children and the elderly. During periods of elevated ventilation, asthmatics may experience symptomatic bronchoconstriction within minutes of exposure. Following an extensive evaluation of health evidence from epidemiologic and laboratory studies, EPA concluded that there is a causal relationship between respiratory health effects and short-term exposure to SO<sub>2</sub>. Separately, based on an evaluation of the epidemiologic evidence of associations between short-term exposure to SO<sub>2</sub> and mortality, EPA concluded that the overall evidence is suggestive of a causal relationship between short-term exposure to SO<sub>2</sub> and mortality. Additional information on the health effects of SO<sub>2</sub> is available in Chapter 6.1.1.4.2 of the RIA.

#### (5) Carbon Monoxide

##### (a) Background

Carbon monoxide (CO) is a colorless, odorless gas emitted from combustion processes. Nationally, particularly in urban areas, the majority of CO emissions to ambient air come from mobile sources.<sup>600</sup>

##### (b) Health Effects of Carbon Monoxide

Information on the health effects of CO can be found in the January 2010 Integrated Science Assessment for Carbon Monoxide (CO ISA).<sup>601</sup> The CO ISA presents conclusions regarding the presence of causal relationships between CO exposure and categories of adverse health effects.<sup>602</sup> This section provides a summary of the health effects associated with exposure to ambient concentrations of CO, along with the ISA conclusions.<sup>603</sup>

Controlled human exposure studies of subjects with coronary artery disease

show a decrease in the time to onset of exercise-induced angina (chest pain) and electrocardiogram changes following CO exposure. In addition, epidemiologic studies observed associations between short-term CO exposure and cardiovascular morbidity, particularly increased emergency room visits and hospital admissions for coronary heart disease (including ischemic heart disease, myocardial infarction, and angina). Some epidemiologic evidence is also available for increased hospital admissions and emergency room visits for congestive heart failure and cardiovascular disease as a whole. The CO ISA concludes that a causal relationship is likely to exist between short-term exposures to CO and cardiovascular morbidity. It also concludes that available data are inadequate to conclude that a causal relationship exists between long-term exposures to CO and cardiovascular morbidity.

Animal studies show various neurological effects with in-utero CO exposure. Controlled human exposure studies report central nervous system and behavioral effects following low-level CO exposures, although the findings have not been consistent across all studies. The CO ISA concludes the evidence is suggestive of a causal relationship with both short- and long-term exposure to CO and central nervous system effects.

A number of studies cited in the CO ISA have evaluated the role of CO exposure in birth outcomes such as preterm birth or cardiac birth defects. There is limited epidemiologic evidence of a CO-induced effect on preterm births and birth defects, with weak evidence for a decrease in birth weight. Animal toxicological studies have found perinatal CO exposure to affect birth weight, as well as other developmental outcomes. The CO ISA concludes the evidence is suggestive of a causal relationship between long-term exposures to CO and developmental effects and birth outcomes.

Epidemiologic studies provide evidence of associations between short-term CO concentrations and respiratory morbidity such as changes in pulmonary function, respiratory symptoms, and hospital admissions. A limited number of epidemiologic studies considered copollutants such as ozone, SO<sub>2</sub>, and PM in two-pollutant models and found that CO risk estimates were generally robust, although this limited evidence makes it difficult to disentangle effects attributed to CO itself from those of the larger complex air pollution mixture. Controlled human exposure studies have not extensively

<sup>600</sup> U.S. EPA, (2010). Integrated Science Assessment for Carbon Monoxide (Final Report). U.S. Environmental Protection Agency, Washington, DC, EPA/600/R-09/019F, 2010. Available at <http://cfpub.epa.gov/ncea/cfm/recordisplay.cfm?deid=218686>. See Section 2.1.

<sup>601</sup> U.S. EPA, (2010). Integrated Science Assessment for Carbon Monoxide (Final Report). U.S. Environmental Protection Agency, Washington, DC, EPA/600/R-09/019F, 2010. Available at <http://cfpub.epa.gov/ncea/cfm/recordisplay.cfm?deid=218686>.

<sup>602</sup> The ISA evaluates the health evidence associated with different health effects, assigning one of five “weight of evidence” determinations: causal relationship, likely to be a causal relationship, suggestive of a causal relationship, inadequate to infer a causal relationship, and not likely to be a causal relationship. For definitions of these levels of evidence, please refer to Section 1.6 of the ISA.

<sup>603</sup> Personal exposure includes contributions from many sources, and in many different environments. Total personal exposure to CO includes both ambient and nonambient components; and both components may contribute to adverse health effects.

<sup>599</sup> U.S. EPA. (2008). *Integrated Science Assessment (ISA) for Sulfur Oxides—Health Criteria (Final Report)*. EPA/600/R-08/047F. Washington, DC: U.S. Environmental Protection Agency.

evaluated the effect of CO on respiratory morbidity. Animal studies at levels of 50–100 ppm CO show preliminary evidence of altered pulmonary vascular remodeling and oxidative injury. The CO ISA concludes that the evidence is suggestive of a causal relationship between short-term CO exposure and respiratory morbidity, and inadequate to conclude that a causal relationship exists between long-term exposure and respiratory morbidity.

Finally, the CO ISA concludes that the epidemiologic evidence is suggestive of a causal relationship between short-term concentrations of CO and mortality. Epidemiologic evidence suggests an association exists between short-term exposure to CO and mortality, but limited evidence is available to evaluate cause-specific mortality outcomes associated with CO exposure. In addition, the attenuation of CO risk estimates which was often observed in copollutant models contributes to the uncertainty as to whether CO is acting alone or as an indicator for other combustion-related pollutants. The CO ISA also concludes that there is not likely to be a causal relationship between relevant long-term exposures to CO and mortality.

## (6) Diesel Exhaust

### (a) Background

Diesel exhaust consists of a complex mixture composed of particulate matter, carbon dioxide, oxygen, nitrogen, water vapor, carbon monoxide, nitrogen compounds, sulfur compounds and numerous low-molecular-weight hydrocarbons. A number of these gaseous hydrocarbon components are individually known to be toxic, including aldehydes, benzene and 1,3-butadiene. The diesel particulate matter present in diesel exhaust consists mostly of fine particles (<2.5  $\mu\text{m}$ ), of which a significant fraction is ultrafine particles (<0.1  $\mu\text{m}$ ). These particles have a large surface area which makes them an excellent medium for adsorbing organics, and their small size makes them highly respirable. Many of the organic compounds present in the gases and on the particles, such as polycyclic organic matter, are individually known to have mutagenic and carcinogenic properties.

Diesel exhaust varies significantly in chemical composition and particle sizes between different engine types (heavy-duty, light-duty), engine operating conditions (idle, acceleration, deceleration), and fuel formulations (high/low sulfur fuel). Also, there are emissions differences between on-road and nonroad engines because the

nonroad engines are generally of older technology. After being emitted in the engine exhaust, diesel exhaust undergoes dilution as well as chemical and physical changes in the atmosphere. The lifetime for some of the compounds present in diesel exhaust ranges from hours to days.

### (b) Health Effects of Diesel Exhaust

In EPA's 2002 Diesel Health Assessment Document (Diesel HAD), exposure to diesel exhaust was classified as likely to be carcinogenic to humans by inhalation from environmental exposures, in accordance with the revised draft 1996/1999 EPA cancer guidelines.<sup>604</sup> <sup>605</sup> A number of other agencies (National Institute for Occupational Safety and Health, the International Agency for Research on Cancer, the World Health Organization, California EPA, and the U.S. Department of Health and Human Services) had made similar hazard classifications prior to 2002. EPA also concluded in the 2002 Diesel HAD that it was not possible to calculate a cancer unit risk for diesel exhaust due to limitations in the exposure data for the occupational groups or the absence of a dose-response relationship.

In the absence of a cancer unit risk, the Diesel HAD sought to provide additional insight into the significance of the diesel exhaust cancer hazard by estimating possible ranges of risk that might be present in the population. An exploratory analysis was used to characterize a range of possible lung cancer risk. The outcome was that environmental risks of cancer from long-term diesel exhaust exposures could plausibly range from as low as  $10^{-5}$  to as high as  $10^{-3}$ . Because of uncertainties, the analysis acknowledged that the risks could be lower than  $10^{-5}$ , and a zero risk from diesel exhaust exposure could not be ruled out.

Non-cancer health effects of acute and chronic exposure to diesel exhaust emissions are also of concern to EPA. EPA derived a diesel exhaust reference concentration (RfC) from consideration of four well-conducted chronic rat inhalation studies showing adverse pulmonary effects. The RfC is 5  $\mu\text{g}/\text{m}^3$  for diesel exhaust measured as diesel

particulate matter. This RfC does not consider allergenic effects such as those associated with asthma or immunologic or the potential for cardiac effects. There was emerging evidence in 2002, discussed in the Diesel HAD, that exposure to diesel exhaust can exacerbate these effects, but the exposure-response data were lacking at that time to derive an RfC based on these then-emerging considerations. The EPA Diesel HAD states, "With [diesel particulate matter] being a ubiquitous component of ambient PM, there is an uncertainty about the adequacy of the existing [diesel exhaust] noncancer database to identify all of the pertinent [diesel exhaust]-caused noncancer health hazards." The Diesel HAD also notes "that acute exposure to [diesel exhaust] has been associated with irritation of the eye, nose, and throat, respiratory symptoms (cough and phlegm), and neurophysiological symptoms such as headache, lightheadedness, nausea, vomiting, and numbness or tingling of the extremities." The Diesel HAD noted that the cancer and noncancer hazard conclusions applied to the general use of diesel engines then on the market and as cleaner engines replace a substantial number of existing ones, the applicability of the conclusions would need to be reevaluated.

It is important to note that the Diesel HAD also briefly summarizes health effects associated with ambient PM and discusses EPA's then-annual  $\text{PM}_{2.5}$  NAAQS of 15  $\mu\text{g}/\text{m}^3$ . In 2012, EPA revised the annual  $\text{PM}_{2.5}$  NAAQS to 12  $\mu\text{g}/\text{m}^3$ . There is a large and extensive body of human data showing a wide spectrum of adverse health effects associated with exposure to ambient PM, of which diesel exhaust is an important component. The  $\text{PM}_{2.5}$  NAAQS is designed to provide protection from the noncancer health effects and premature mortality attributed to exposure to  $\text{PM}_{2.5}$ . The contribution of diesel PM to total ambient PM varies in different regions of the country and also, within a region, from one area to another. The contribution can be high in near-roadway environments, for example, or in other locations where diesel engine use is concentrated.

Since 2002, several new studies have been published which continue to report increased lung cancer risk with occupational exposure to diesel exhaust from older engines. Of particular note since 2011 are three new epidemiology studies which have examined lung cancer in occupational populations, for example, truck drivers, underground nonmetal miners and other diesel

<sup>604</sup> U.S. EPA. (1999). *Guidelines for Carcinogen Risk Assessment*. Review Draft. NCEA-F-0644, July. Washington, DC: U.S. EPA. Retrieved on March 19, 2009 from <http://cfpub.epa.gov/ncea/cfm/recordisplay.cfm?deid=54932>.

<sup>605</sup> U.S. EPA (2002). *Health Assessment Document for Diesel Engine Exhaust*. EPA/600/8-90/057F Office of Research and Development, Washington DC. Retrieved on March 17, 2009 from <http://cfpub.epa.gov/ncea/cfm/recordisplay.cfm?deid=29060>. pp. 1-1 1-2.



motor-related occupations. These studies reported increased risk of lung cancer with exposure to diesel exhaust with evidence of positive exposure-response relationships to varying degrees.<sup>606 607 608</sup> These newer studies (along with others that have appeared in the scientific literature) add to the evidence EPA evaluated in the 2002 Diesel HAD and further reinforces the concern that diesel exhaust exposure likely poses a lung cancer hazard. The findings from these newer studies do not necessarily apply to newer technology diesel engines since the newer engines have large reductions in the emission constituents compared to older technology diesel engines.

In light of the growing body of scientific literature evaluating the health effects of exposure to diesel exhaust, in June 2012 the World Health Organization's International Agency for Research on Cancer (IARC), a recognized international authority on the carcinogenic potential of chemicals and other agents, evaluated the full range of cancer-related health effects data for diesel engine exhaust. IARC concluded that diesel exhaust should be regarded as "carcinogenic to humans."<sup>609</sup> This designation was an update from its 1988 evaluation that considered the evidence to be indicative of a "probable human carcinogen."

## (7) Air Toxics

### (a) Background

Heavy-duty vehicle emissions contribute to ambient levels of air toxics that are known or suspected human or animal carcinogens, or that have noncancer health effects. The population experiences an elevated risk of cancer and other noncancer health effects from exposure to the class of pollutants known collectively as "air toxics."<sup>610</sup> These compounds include,

<sup>606</sup> Garshick, Eric, Francine Laden, Jaime E. Hart, Mary E. Davis, Ellen A. Eisen, and Thomas J. Smith. 2012. Lung cancer and elemental carbon exposure in trucking industry workers. *Environmental Health Perspectives* 120(9): 1301–1306.

<sup>607</sup> Silverman, D. T., Samanic, C. M., Lubin, J. H., Blair, A. E., Stewart, P. A., Vermeulen, R., & Attfield, M. D. (2012). The diesel exhaust in miners study: A nested case-control study of lung cancer and diesel exhaust. *Journal of the National Cancer Institute*.

<sup>608</sup> Olsson, Ann C., et al. "Exposure to diesel motor exhaust and lung cancer risk in a pooled analysis from case-control studies in Europe and Canada." *American journal of respiratory and critical care medicine* 183.7 (2011): 941–948.

<sup>609</sup> IARC [International Agency for Research on Cancer]. (2013). Diesel and gasoline engine exhausts and some nitroarenes. IARC Monographs Volume 105. [Online at <http://monographs.iarc.fr/ENG/Monographs/vol105/index.php>].

<sup>610</sup> U.S. EPA. (2015) Summary of Results for the 2011 National-Scale Assessment. <http://>

but are not limited to, benzene, 1,3-butadiene, formaldehyde, acetaldehyde, acrolein, polycyclic organic matter, and naphthalene. These compounds were identified as national or regional risk drivers or contributors in the 2011 National-scale Air Toxics Assessment and have significant inventory contributions from mobile sources.<sup>611</sup>

### (b) Benzene

EPA's Integrated Risk Information System (IRIS) database lists benzene as a known human carcinogen (causing leukemia) by all routes of exposure, and concludes that exposure is associated with additional health effects, including genetic changes in both humans and animals and increased proliferation of bone marrow cells in mice.<sup>612 613 614</sup> EPA states in its IRIS database that data indicate a causal relationship between benzene exposure and acute lymphocytic leukemia and suggest a relationship between benzene exposure and chronic non-lymphocytic leukemia and chronic lymphocytic leukemia. EPA's IRIS documentation for benzene also lists a range of  $2.2 \times 10^{-6}$  to  $7.8 \times 10^{-6}$  per  $\mu\text{g}/\text{m}^3$  as the unit risk estimate (URE) for benzene.<sup>615 616</sup> The International Agency for Research on Cancer (IARC) has determined that benzene is a human carcinogen and the U.S. Department of Health and Human Services (DHHS) has characterized benzene as a known human carcinogen.<sup>617 618</sup>

[www3.epa.gov/sites/production/files/2015-12/documents/2011-nata-summary-results.pdf](http://www3.epa.gov/sites/production/files/2015-12/documents/2011-nata-summary-results.pdf).

<sup>611</sup> U.S. EPA (2015) 2011 National Air Toxics Assessment. <http://www3.epa.gov/national-air-toxics-assessment/2011-national-air-toxics-assessment>.

<sup>612</sup> U.S. EPA. (2000). Integrated Risk Information System File for Benzene. This material is available electronically at: <http://www3.epa.gov/iris/subst/0276.htm>.

<sup>613</sup> International Agency for Research on Cancer, IARC monographs on the evaluation of carcinogenic risk of chemicals to humans, Volume 29, some industrial chemicals and dyestuffs, International Agency for Research on Cancer, World Health Organization, Lyon, France 1982.

<sup>614</sup> Irons, R.D.; Stillman, W.S.; Colagiovanni, D.B.; Henry, V.A. (1992). Synergistic action of the benzene metabolite hydroquinone on myelopoietic stimulating activity of granulocyte/macrophage colony-stimulating factor in vitro. *Proc. Natl. Acad. Sci.* 89:3691–3695.

<sup>615</sup> A unit risk estimate is defined as the increase in the lifetime risk of an individual who is exposed for a lifetime to  $1 \mu\text{g}/\text{m}^3$  benzene in air.

<sup>616</sup> U.S. EPA. (2000). Integrated Risk Information System File for Benzene. This material is available electronically at: <http://www3.epa.gov/iris/subst/0276.htm>.

<sup>617</sup> International Agency for Research on Cancer (IARC). (1987). Monographs on the evaluation of carcinogenic risk of chemicals to humans, Volume 29, Supplement 7, Some industrial chemicals and dyestuffs, World Health Organization, Lyon, France.

<sup>618</sup> NTP. (2014). 13th Report on Carcinogens. Research Triangle Park, NC: U.S. Department of

A number of adverse noncancer health effects including blood disorders, such as pre-leukemia and aplastic anemia, have also been associated with long-term exposure to benzene.<sup>619 620</sup> The most sensitive noncancer effect observed in humans, based on current data, is the depression of the absolute lymphocyte count in blood.<sup>621 622</sup> EPA's inhalation reference concentration (RfC) for benzene is  $30 \mu\text{g}/\text{m}^3$ . The RfC is based on suppressed absolute lymphocyte counts seen in humans under occupational exposure conditions. In addition, recent work, including studies sponsored by the Health Effects Institute, provides evidence that biochemical responses are occurring at lower levels of benzene exposure than previously known.<sup>623 624 625 626</sup> EPA's IRIS program has not yet evaluated these new data. EPA does not currently have an acute reference concentration for benzene. The Agency for Toxic Substances and Disease Registry (ATSDR) Minimal Risk Level (MRL) for acute exposure to benzene is  $29 \mu\text{g}/\text{m}^3$  for 1–14 days exposure.<sup>627 628</sup>

Health and Human Services, Public Health Service, National Toxicology Program.

<sup>619</sup> Aksoy, M. (1989). Hematotoxicity and carcinogenicity of benzene. *Environ. Health Perspect.* 82: 193–197.

<sup>620</sup> Goldstein, B.D. (1988). Benzene toxicity. *Occupational medicine. State of the Art Reviews.* 3: 541–554.

<sup>621</sup> Rothman, N., G.L. Li, M. Dosemeci, W.E. Bechtold, G.E. Marti, Y.Z. Wang, M. Linet, L.Q. Xi, W. Lu, M.T. Smith, N. Titenko-Holland, L.P. Zhang, W. Blot, S.N. Yin, and R.B. Hayes. (1996). Hematotoxicity among Chinese workers heavily exposed to benzene. *Am. J. Ind. Med.* 29: 236–246.

<sup>622</sup> U.S. EPA. (2002). Toxicological Review of Benzene (Noncancer Effects). Environmental Protection Agency, Integrated Risk Information System (IRIS), Research and Development, National Center for Environmental Assessment, Washington DC. This material is available electronically at <http://www3.epa.gov/iris/subst/0276.htm>.

<sup>623</sup> Qu, Q.; Shore, R.; Li, G.; Jin, X.; Chen, C.L.; Cohen, B.; Melikian, A.; Eastmond, D.; Rappaport, S.; Li, H.; Rupa, D.; Suramaya, R.; Songnian, W.; Huifant, Y.; Meng, M.; Winnik, M.; Kwok, E.; Li, Y.; Mu, R.; Xu, B.; Zhang, X.; Li, K. (2003). HEI Report 115, Validation & Evaluation of Biomarkers in Workers Exposed to Benzene in China.

<sup>624</sup> Qu, Q., R. Shore, G. Li, X. Jin, L.C. Chen, B. Cohen, et al. (2002). Hematological changes among Chinese workers with a broad range of benzene exposures. *Am. J. Industr. Med.* 42: 275–285.

<sup>625</sup> Lan, Qing, Zhang, L., Li, G., Vermeulen, R., et al. (2004). Hematotoxicity in Workers Exposed to Low Levels of Benzene. *Science* 306: 1774–1776.

<sup>626</sup> Turteltaub, K.W. and Mani, C. (2003). Benzene metabolism in rodents at doses relevant to human exposure from Urban Air. *Research Reports Health Effect Inst. Report No.113*.

<sup>627</sup> U.S. Agency for Toxic Substances and Disease Registry (ATSDR). (2007). Toxicological profile for benzene. Atlanta, GA: U.S. Department of Health and Human Services, Public Health Service. <http://www.atsdr.cdc.gov/ToxProfiles/tp3.pdf>.

<sup>628</sup> A minimal risk level (MRL) is defined as an estimate of the daily human exposure to a

Continued



## (c) 1,3-Butadiene

EPA has characterized 1,3-butadiene as carcinogenic to humans by inhalation.<sup>629 630</sup> The IARC has determined that 1,3-butadiene is a human carcinogen and the U.S. DHHS has characterized 1,3-butadiene as a known human carcinogen.<sup>631 632 633</sup> There are numerous studies consistently demonstrating that 1,3-butadiene is metabolized into genotoxic metabolites by experimental animals and humans. The specific mechanisms of 1,3-butadiene-induced carcinogenesis are unknown; however, the scientific evidence strongly suggests that the carcinogenic effects are mediated by genotoxic metabolites. Animal data suggest that females may be more sensitive than males for cancer effects associated with 1,3-butadiene exposure; there are insufficient data in humans from which to draw conclusions about sensitive subpopulations. The URE for 1,3-butadiene is  $3 \times 10^{-5}$  per  $\mu\text{g}/\text{m}^3$ .<sup>634</sup> 1,3-butadiene also causes a variety of reproductive and developmental effects in mice; no human data on these effects are available. The most sensitive effect was ovarian atrophy observed in a lifetime bioassay of female mice.<sup>635</sup>

hazardous substance that is likely to be without appreciable risk of adverse noncancer health effects over a specified duration of exposure.

<sup>629</sup> U.S. EPA. (2002). Health Assessment of 1,3-Butadiene. Office of Research and Development, National Center for Environmental Assessment, Washington Office, Washington, DC. Report No. EPA600-P-98-001F. This document is available electronically at <http://www3.epa.gov/iris/supdocs/buta-sup.pdf>.

<sup>630</sup> U.S. EPA. (2002). "Full IRIS Summary for 1,3-butadiene (CASRN 106-99-0)" Environmental Protection Agency, Integrated Risk Information System (IRIS), Research and Development, National Center for Environmental Assessment, Washington, DC <http://www3.epa.gov/iris/subst/0139.htm>.

<sup>631</sup> International Agency for Research on Cancer (IARC). (1999). Monographs on the evaluation of carcinogenic risk of chemicals to humans, Volume 71, Re-evaluation of some organic chemicals, hydrazine and hydrogen peroxide and Volume 97 (in preparation), World Health Organization, Lyon, France.

<sup>632</sup> International Agency for Research on Cancer (IARC). (2008). Monographs on the evaluation of carcinogenic risk of chemicals to humans, 1,3-Butadiene, Ethylene Oxide and Vinyl Halides (Vinyl Fluoride, Vinyl Chloride and Vinyl Bromide) Volume 97, World Health Organization, Lyon, France.

<sup>633</sup> NTP. (2014). 13th Report on Carcinogens. Research Triangle Park, NC: U.S. Department of Health and Human Services, Public Health Service, National Toxicology Program.

<sup>634</sup> U.S. EPA. (2002). "Full IRIS Summary for 1,3-butadiene (CASRN 106-99-0)" Environmental Protection Agency, Integrated Risk Information System (IRIS), Research and Development, National Center for Environmental Assessment, Washington, DC <http://www3.epa.gov/iris/subst/0139.htm>.

<sup>635</sup> Bevan, C.; Stadler, J.C.; Elliot, G.S.; et al. (1996). Subchronic toxicity of 4-vinylcyclohexene in rats and mice by inhalation. *Fundam. Appl. Toxicol.* 32:1-10.

Based on this critical effect and the benchmark concentration methodology, an RfC for chronic health effects was calculated at 0.9 ppb (approximately 2  $\mu\text{g}/\text{m}^3$ ).

## (d) Formaldehyde

In 1991, EPA concluded that formaldehyde is a carcinogen based on nasal tumors in animal bioassays.<sup>636</sup> An Inhalation URE for cancer and a Reference Dose for oral noncancer effects were developed by the agency and posted on the IRIS database. Since that time, the National Toxicology Program (NTP) and International Agency for Research on Cancer (IARC) have concluded that formaldehyde is a known human carcinogen.<sup>637 638</sup>

The conclusions by IARC and NTP reflect the results of epidemiologic research published since 1991 in combination with previous animal, human and mechanistic evidence. Research conducted by the National Cancer Institute reported an increased risk of nasopharyngeal cancer and specific lymph hematopoietic malignancies among workers exposed to formaldehyde.<sup>639 640 641</sup> A National Institute of Occupational Safety and Health study of garment workers also reported increased risk of death due to leukemia among workers exposed to formaldehyde.<sup>642</sup> Extended follow-up of a cohort of British chemical workers did not report evidence of an increase in nasopharyngeal or lymph hematopoietic cancers, but a continuing statistically significant excess in lung cancers was reported.<sup>643</sup> Finally, a study of

<sup>636</sup> EPA. Integrated Risk Information System. Formaldehyde (CASRN 50-00-0) <http://www3.epa.gov/iris/subst/0419.htm>.

<sup>637</sup> NTP. (2014). 13th Report on Carcinogens. Research Triangle Park, NC: U.S. Department of Health and Human Services, Public Health Service, National Toxicology Program.

<sup>638</sup> IARC Monographs on the Evaluation of Carcinogenic Risks to Humans Volume 100F (2012): Formaldehyde.

<sup>639</sup> Hauptmann, M.; Lubin, J. H.; Stewart, P. A.; Hayes, R. B.; Blair, A. 2003. Mortality from lymphohematopoietic malignancies among workers in formaldehyde industries. *Journal of the National Cancer Institute* 95: 1615-1623.

<sup>640</sup> Hauptmann, M.; Lubin, J. H.; Stewart, P. A.; Hayes, R. B.; Blair, A. 2004. Mortality from solid cancers among workers in formaldehyde industries. *American Journal of Epidemiology* 159: 1117-1130.

<sup>641</sup> Beane Freeman, L. E.; Blair, A.; Lubin, J. H.; Stewart, P. A.; Hayes, R. B.; Hoover, R. N.; Hauptmann, M. 2009. Mortality from lymph hematopoietic malignancies among workers in formaldehyde industries: The National Cancer Institute cohort. *J. National Cancer Inst.* 101: 751-761.

<sup>642</sup> Pinkerton, L. E. 2004. Mortality among a cohort of garment workers exposed to formaldehyde: an update. *Occup. Environ. Med.* 61: 193-200.

<sup>643</sup> Coggon, D, EC Harris, J Poole, KT Palmer. 2003. Extended follow-up of a cohort of British

embalmers reported formaldehyde exposures to be associated with an increased risk of myeloid leukemia but not brain cancer.<sup>644</sup>

Health effects of formaldehyde in addition to cancer were reviewed by the Agency for Toxic Substances and Disease Registry in 1999<sup>645</sup>, supplemented in 2010,<sup>646</sup> and by the World Health Organization.<sup>647</sup> These organizations reviewed the scientific literature concerning health effects linked to formaldehyde exposure to evaluate hazards and dose response relationships and defined exposure concentrations for minimal risk levels (MRLs). The health endpoints reviewed included sensory irritation of eyes and respiratory tract, reduced pulmonary function, nasal histopathology, and immune system effects. In addition, research on reproductive and developmental effects and neurological effects were discussed along with several studies that suggest that formaldehyde may increase the risk of asthma—particularly in the young.

EPA released a draft Toxicological Review of Formaldehyde—Inhalation Assessment through the IRIS program for peer review by the National Research Council (NRC) and public comment in June 2010.<sup>648</sup> The draft assessment reviewed more recent research from animal and human studies on cancer and other health effects. The NRC released their review report in April 2011.<sup>649</sup> EPA is currently developing a revised draft assessment in response to this review.

chemical workers exposed to formaldehyde. *J National Cancer Inst.* 95:1608-1615.

<sup>644</sup> Hauptmann, M.; Stewart P. A.; Lubin J. H.; Beane Freeman, L. E.; Hornung, R. W.; Herrick, R. F.; Hoover, R. N.; Fraumeni, J. F.; Hayes, R. B. 2009. Mortality from lymph hematopoietic malignancies and brain cancer among embalmers exposed to formaldehyde. *Journal of the National Cancer Institute* 101:1696-1708.

<sup>645</sup> ATSDR. 1999. Toxicological Profile for Formaldehyde, U.S. Department of Health and Human Services (HHS), July 1999.

<sup>646</sup> ATSDR. 2010. Addendum to the Toxicological Profile for Formaldehyde. U.S. Department of Health and Human Services (HHS), October 2010.

<sup>647</sup> IPCS. 2002. Concise International Chemical Assessment Document 40. Formaldehyde. World Health Organization.

<sup>648</sup> EPA (U.S. Environmental Protection Agency). 2010. Toxicological Review of Formaldehyde (CAS No. 50-00-0)—Inhalation Assessment: In Support of Summary Information on the Integrated Risk Information System (IRIS). External Review Draft. EPA/635/R-10/002A. U.S. Environmental Protection Agency, Washington DC [online]. Available: [http://cfpub.epa.gov/ncea/irs\\_drats/recordisplay.cfm?deid=223614](http://cfpub.epa.gov/ncea/irs_drats/recordisplay.cfm?deid=223614).

<sup>649</sup> NRC (National Research Council). 2011. Review of the Environmental Protection Agency's Draft IRIS Assessment of Formaldehyde. Washington DC: National Academies Press. [http://books.nap.edu/openbook.php?record\\_id=13142](http://books.nap.edu/openbook.php?record_id=13142).

## (e) Acetaldehyde

Acetaldehyde is classified in EPA's IRIS database as a probable human carcinogen, based on nasal tumors in rats, and is considered toxic by the inhalation, oral, and intravenous routes.<sup>650</sup> The URE in IRIS for acetaldehyde is  $2.2 \times 10^{-6}$  per  $\mu\text{g}/\text{m}^3$ .<sup>651</sup> Acetaldehyde is reasonably anticipated to be a human carcinogen by the U.S. DHHS in the 13th Report on Carcinogens and is classified as possibly carcinogenic to humans (Group 2B) by the IARC.<sup>652,653</sup> Acetaldehyde is currently listed on the IRIS Program Multi-Year Agenda for reassessment within the next few years.

The primary noncancer effects of exposure to acetaldehyde vapors include irritation of the eyes, skin, and respiratory tract.<sup>654</sup> In short-term (4 week) rat studies, degeneration of olfactory epithelium was observed at various concentration levels of acetaldehyde exposure.<sup>655,656</sup> Data from these studies were used by EPA to develop an inhalation reference concentration of  $9 \mu\text{g}/\text{m}^3$ . Some asthmatics have been shown to be a sensitive subpopulation to decrements in functional expiratory volume (FEV1 test) and bronchoconstriction upon acetaldehyde inhalation.<sup>657</sup>

## (f) Acrolein

EPA most recently evaluated the toxicological and health effects

<sup>650</sup> U.S. EPA (1991). Integrated Risk Information System File of Acetaldehyde. Research and Development, National Center for Environmental Assessment, Washington, DC. This material is available electronically at <http://www3.epa.gov/iris/subst/0290.htm>.

<sup>651</sup> U.S. EPA (1991). Integrated Risk Information System File of Acetaldehyde. This material is available electronically at <http://www3.epa.gov/iris/subst/0290.htm>.

<sup>652</sup> NTP. (2014). 13th Report on Carcinogens. Research Triangle Park, NC: U.S. Department of Health and Human Services, Public Health Service, National Toxicology Program.

<sup>653</sup> International Agency for Research on Cancer (IARC). (1999). Re-evaluation of some organic chemicals, hydrazine, and hydrogen peroxide. IARC Monographs on the Evaluation of Carcinogenic Risk of Chemical to Humans, Vol 71. Lyon, France.

<sup>654</sup> U.S. EPA (1991). Integrated Risk Information System File of Acetaldehyde. This material is available electronically at <http://www3.epa.gov/iris/subst/0290.htm>.

<sup>655</sup> U.S. EPA. (2003). Integrated Risk Information System File of Acrolein. Research and Development, National Center for Environmental Assessment, Washington, DC. This material is available electronically at <http://www3.epa.gov/iris/subst/0364.htm>.

<sup>656</sup> Appleman, L.M., R.A. Woutersen, and V.J. Feron. (1982). Inhalation toxicity of acetaldehyde in rats. I. Acute and subacute studies. *Toxicology*. 23: 293–297.

<sup>657</sup> Myou, S.; Fujimura, M.; Nishi K.; Ohka, T.; and Matsuda, T. (1993) Aerosolized acetaldehyde induces histamine-mediated bronchoconstriction in asthmatics. *Am. Rev. Respir. Dis.* 148(4 Pt 1): 940–943.

literature related to acrolein in 2003 and concluded that the human carcinogenic potential of acrolein could not be determined because the available data were inadequate. No information was available on the carcinogenic effects of acrolein in humans and the animal data provided inadequate evidence of carcinogenicity.<sup>658</sup> The IARC determined in 1995 that acrolein was not classifiable as to its carcinogenicity in humans.<sup>659</sup>

Lesions to the lungs and upper respiratory tract of rats, rabbits, and hamsters have been observed after subchronic exposure to acrolein.<sup>660</sup> The agency has developed an RfC for acrolein of  $0.02 \mu\text{g}/\text{m}^3$  and an RfD of  $0.5 \mu\text{g}/\text{kg}\text{-day}$ .<sup>661</sup>

Acrolein is extremely acrid and irritating to humans when inhaled, with acute exposure resulting in upper respiratory tract irritation, mucus hypersecretion and congestion. The intense irritancy of this carbonyl has been demonstrated during controlled tests in human subjects, who suffer intolerable eye and nasal mucosal sensory reactions within minutes of exposure.<sup>662</sup> These data and additional studies regarding acute effects of human exposure to acrolein are summarized in EPA's 2003 Toxicological Review of Acrolein.<sup>663</sup> Studies in humans indicate that levels as low as 0.09 ppm ( $0.21 \text{ mg}/\text{m}^3$ ) for five minutes may elicit subjective complaints of eye irritation

<sup>658</sup> U.S. EPA. (2003). Integrated Risk Information System File of Acrolein. Research and Development, National Center for Environmental Assessment, Washington, DC. This material is available at <http://www3.epa.gov/iris/subst/0364.htm>.

<sup>659</sup> International Agency for Research on Cancer (IARC). (1995). Monographs on the evaluation of carcinogenic risk of chemicals to humans, Volume 63. Dry cleaning, some chlorinated solvents and other industrial chemicals. World Health Organization, Lyon, France.

<sup>660</sup> U.S. EPA. (2003). Integrated Risk Information System File of Acrolein. Office of Research and Development, National Center for Environmental Assessment, Washington, DC. This material is available at <http://www3.epa.gov/iris/subst/0364.htm>.

<sup>661</sup> U.S. EPA. (2003). Integrated Risk Information System File of Acrolein. Office of Research and Development, National Center for Environmental Assessment, Washington, DC. This material is available at <http://www3.epa.gov/iris/subst/0364.htm>.

<sup>662</sup> U.S. EPA. (2003) Toxicological review of acrolein in support of summary information on Integrated Risk Information System (IRIS) National Center for Environmental Assessment, Washington, DC. EPA/635/R-03/003. p. 10. Available online at: <http://www3.epa.gov/ncea/iris/toxreviews/0364tr.pdf>.

<sup>663</sup> U.S. EPA. (2003) Toxicological review of acrolein in support of summary information on Integrated Risk Information System (IRIS) National Center for Environmental Assessment, Washington, DC. EPA/635/R-03/003. Available online at: <http://www3.epa.gov/ncea/iris/toxreviews/0364tr.pdf>.

with increasing concentrations leading to more extensive eye, nose and respiratory symptoms. Acute exposures in animal studies report bronchial hyper-responsiveness. Based on animal data (more pronounced respiratory irritancy in mice with allergic airway disease in comparison to non-diseased mice)<sup>664</sup> and demonstration of similar effects in humans (*e.g.*, reduction in respiratory rate), individuals with compromised respiratory function (*e.g.*, emphysema, asthma) are expected to be at increased risk of developing adverse responses to strong respiratory irritants such as acrolein. EPA does not currently have an acute reference concentration for acrolein. The available health effect reference values for acrolein have been summarized by EPA and include an ATSDR MRL for acute exposure to acrolein of  $7 \mu\text{g}/\text{m}^3$  for 1–14 days exposure; and Reference Exposure Level (REL) values from the California Office of Environmental Health Hazard Assessment (OEHHA) for one-hour and 8-hour exposures of  $2.5 \mu\text{g}/\text{m}^3$  and  $0.7 \mu\text{g}/\text{m}^3$ , respectively.<sup>665</sup>

## (g) Polycyclic Organic Matter

The term polycyclic organic matter (POM) defines a broad class of compounds that includes the polycyclic aromatic hydrocarbon compounds (PAHs). One of these compounds, naphthalene, is discussed separately below. POM compounds are formed primarily from combustion and are present in the atmosphere in gas and particulate form. Cancer is the major concern from exposure to POM. Epidemiologic studies have reported an increase in lung cancer in humans exposed to diesel exhaust, coke oven emissions, roofing tar emissions, and cigarette smoke; all of these mixtures contain POM compounds.<sup>666,667</sup> Animal studies have reported respiratory tract tumors from inhalation exposure to

<sup>664</sup> Morris JB, Symanowicz PT, Olsen JE, et al. (2003). Immediate sensory nerve-mediated respiratory responses to irritants in healthy and allergic airway-diseased mice. *J Appl Physiol* 94(4):1563–1571.

<sup>665</sup> U.S. EPA. (2009). Graphical Arrays of Chemical-Specific Health Effect Reference Values for Inhalation Exposures (Final Report). U.S. Environmental Protection Agency, Washington, DC, EPA/600/R-09/061, 2009. <http://cfpub.epa.gov/ncea/cfm/recordisplay.cfm?deid=211003>.

<sup>666</sup> Agency for Toxic Substances and Disease Registry (ATSDR). (1995). Toxicological profile for Polycyclic Aromatic Hydrocarbons (PAHs). Atlanta, GA: U.S. Department of Health and Human Services, Public Health Service. Available electronically at <http://www.atsdr.cdc.gov/ToxProfiles/TP.asp?id=122&tid=25>.

<sup>667</sup> U.S. EPA (2002). *Health Assessment Document for Diesel Engine Exhaust*. EPA/600/8-90/057F Office of Research and Development, Washington DC. <http://cfpub.epa.gov/ncea/cfm/recordisplay.cfm?deid=29060>.

benzo[a]pyrene and alimentary tract and liver tumors from oral exposure to benzo[a]pyrene.<sup>668</sup> In 1997 EPA classified seven PAHs (benzo[a]pyrene, benz[a]anthracene, chrysene, benzo[b]fluoranthene, benzo[k]fluoranthene, dibenz[a,h]anthracene, and indeno[1,2,3-cd]pyrene) as Group B2, probable human carcinogens.<sup>669</sup> Since that time, studies have found that maternal exposures to PAHs in a population of pregnant women were associated with several adverse birth outcomes, including low birth weight and reduced length at birth, as well as impaired cognitive development in preschool children (3 years of age).<sup>670 671</sup> These and similar studies are being evaluated as a part of the ongoing IRIS reassessment of health effects associated with exposure to benzo[a]pyrene.

#### (h) Naphthalene

Naphthalene is found in small quantities in gasoline and diesel fuels. Naphthalene emissions have been measured in larger quantities in both gasoline and diesel exhaust compared with evaporative emissions from mobile sources, indicating it is primarily a product of combustion. Acute (short-term) exposure of humans to naphthalene by inhalation, ingestion, or dermal contact is associated with hemolytic anemia and damage to the liver and the nervous system.<sup>672</sup> Chronic (long term) exposure of workers and rodents to naphthalene has been reported to cause cataracts and retinal damage.<sup>673</sup> EPA released an external

review draft of a reassessment of the inhalation carcinogenicity of naphthalene based on a number of recent animal carcinogenicity studies.<sup>674</sup> The draft reassessment completed external peer review.<sup>675</sup> Based on external peer review comments received, a revised draft assessment that considers all routes of exposure, as well as cancer and noncancer effects, is under development. The external review draft does not represent official agency opinion and was released solely for the purposes of external peer review and public comment. The National Toxicology Program listed naphthalene as “reasonably anticipated to be a human carcinogen” in 2004 on the basis of bioassays reporting clear evidence of carcinogenicity in rats and some evidence of carcinogenicity in mice.<sup>676</sup> California EPA has released a new risk assessment for naphthalene, and the IARC has reevaluated naphthalene and re-classified it as Group 2B: possibly carcinogenic to humans.<sup>677</sup>

Naphthalene also causes a number of chronic non-cancer effects in animals, including abnormal cell changes and growth in respiratory and nasal tissues.<sup>678</sup> The current EPA IRIS assessment includes noncancer data on hyperplasia and metaplasia in nasal tissue that form the basis of the inhalation RfC of 3 µg/m<sup>3</sup>.<sup>679</sup> The

Integrated Risk Information System, Research and Development, National Center for Environmental Assessment, Washington, DC. This material is available electronically at <http://www3.epa.gov/iris/subst/0436.htm>.

<sup>674</sup> U. S. EPA. (1998). Toxicological Review of Naphthalene (Reassessment of the Inhalation Cancer Risk), Environmental Protection Agency, Integrated Risk Information System, Research and Development, National Center for Environmental Assessment, Washington, DC. This material is available electronically at <http://www3.epa.gov/iris/subst/0436.htm>.

<sup>675</sup> Oak Ridge Institute for Science and Education. (2004). External Peer Review for the IRIS Reassessment of the Inhalation Carcinogenicity of Naphthalene. August 2004. <http://cfpub.epa.gov/ncea/cfm/recordisplay.cfm?deid=84403>.

<sup>676</sup> NTP. (2014). 13th Report on Carcinogens. U.S. Department of Health and Human Services, Public Health Service, National Toxicology Program.

<sup>677</sup> International Agency for Research on Cancer (IARC). (2002). Monographs on the Evaluation of the Carcinogenic Risk of Chemicals for Humans. Vol. 82. Lyon, France.

<sup>678</sup> U. S. EPA. (1998). Toxicological Review of Naphthalene, Environmental Protection Agency, Integrated Risk Information System, Research and Development, National Center for Environmental Assessment, Washington, DC. This material is available electronically at <http://www3.epa.gov/iris/subst/0436.htm>.

<sup>679</sup> U.S. EPA. (1998). Toxicological Review of Naphthalene, Environmental Protection Agency, Integrated Risk Information System (IRIS), Research and Development, National Center for Environmental Assessment, Washington, DC <http://www3.epa.gov/iris/subst/0436.htm>.

ATSDR MRL for acute exposure to naphthalene is 0.6 mg/kg/day.

#### (i) Other Air Toxics

In addition to the compounds described above, other compounds in gaseous hydrocarbon and PM emissions from motor vehicles will be affected by this action. Mobile source air toxic compounds that will potentially be impacted include ethylbenzene, propionaldehyde, toluene, and xylene. Information regarding the health effects of these compounds can be found in EPA's IRIS database.<sup>680</sup>

#### (8) Exposure and Health Effects Associated With Traffic

Locations in close proximity to major roadways generally have elevated concentrations of many air pollutants emitted from motor vehicles. Hundreds of such studies have been published in peer-reviewed journals, concluding that concentrations of CO, NO, NO<sub>2</sub>, benzene, aldehydes, particulate matter, black carbon, and many other compounds are elevated in ambient air within approximately 300–600 meters (about 1,000–2,000 feet) of major roadways. Highest concentrations of most pollutants emitted directly by motor vehicles are found at locations within 50 meters (about 165 feet) of the edge of a roadway's traffic lanes.

A large-scale review of air quality measurements in the vicinity of major roadways between 1978 and 2008 concluded that the pollutants with the steepest concentration gradients in vicinities of roadways were CO, ultrafine particles, metals, elemental carbon (EC), NO, NO<sub>x</sub>, and several VOCs.<sup>681</sup> These pollutants showed a large reduction in concentrations within 100 meters downwind of the roadway. Pollutants that showed more gradual reductions with distance from roadways included benzene, NO<sub>2</sub>, PM<sub>2.5</sub>, and PM<sub>10</sub>. In the review article, results varied based on the method of statistical analysis used to determine the trend.

For pollutants with relatively high background concentrations relative to near-road concentrations, detecting concentration gradients can be difficult. For example, many aldehydes have high background concentrations as a result of photochemical breakdown of precursors from many different organic compounds. This can make detection of gradients around roadways and other primary emission sources difficult.

<sup>680</sup> U.S. EPA Integrated Risk Information System (IRIS) database is available at: [www3.epa.gov/iris](http://www3.epa.gov/iris).

<sup>681</sup> Karner, A.A.; Eisinger, D.S.; Niemeier, D.A. (2010). Near-roadway air quality: synthesizing the findings from real-world data. *Environ Sci Technol* 44: 5334–5344.

<sup>668</sup> International Agency for Research on Cancer (IARC). (2012). Monographs on the Evaluation of the Carcinogenic Risk of Chemicals for Humans, Chemical Agents and Related Occupations. Vol. 100F. Lyon, France.

<sup>669</sup> U.S. EPA (1997). Integrated Risk Information System File of indeno (1,2,3-cd) pyrene. Research and Development, National Center for Environmental Assessment, Washington, DC. This material is available electronically at <http://www3.epa.gov/ncea/iris/subst/0457.htm>.

<sup>670</sup> Perera, F.P.; Rauh, V.; Tsai, W.-Y.; et al. (2002). Effect of transplacental exposure to environmental pollutants on birth outcomes in a multiethnic population. *Environ Health Perspect.* 111: 201–205.

<sup>671</sup> Perera, F.P.; Rauh, V.; Whyatt, R.M.; Tsai, W.Y.; Tang, D.; Diaz, D.; Hoepner, L.; Barr, D.; Tu, Y.H.; Camann, D.; Kinney, P. (2006). Effect of prenatal exposure to airborne polycyclic aromatic hydrocarbons on neurodevelopment in the first 3 years of life among inner-city children. *Environ Health Perspect* 114: 1287–1292.

<sup>672</sup> U. S. EPA. 1998. Toxicological Review of Naphthalene (Reassessment of the Inhalation Cancer Risk), Environmental Protection Agency, Integrated Risk Information System, Research and Development, National Center for Environmental Assessment, Washington, DC. This material is available electronically at <http://www3.epa.gov/iris/subst/0436.htm>.

<sup>673</sup> U. S. EPA. 1998. Toxicological Review of Naphthalene (Reassessment of the Inhalation Cancer Risk), Environmental Protection Agency,

However, several studies have measured aldehydes in multiple weather conditions and found higher concentrations of many carbonyls downwind of roadways.<sup>682 683</sup> These findings suggest a substantial roadway source of these carbonyls.

In the past 15 years, many studies have been published with results reporting that populations who live, work, or go to school near high-traffic roadways experience higher rates of numerous adverse health effects, compared to populations far away from major roads.<sup>684</sup> In addition, numerous studies have found adverse health effects associated with spending time in traffic, such as commuting or walking along high-traffic roadways.<sup>685 686 687 688</sup> The health outcomes with the strongest evidence linking them with traffic-associated air pollutants are respiratory effects, particularly in asthmatic children, and cardiovascular effects.

Numerous reviews of this body of health literature have been published as well. In 2010, an expert panel of the Health Effects Institute (HEI) published a review of hundreds of exposure, epidemiology, and toxicology studies.<sup>689</sup> The panel rated how the evidence for each type of health outcome supported a conclusion of a causal association with traffic-

associated air pollution as either “sufficient,” “suggestive but not sufficient,” or “inadequate and insufficient.” The panel categorized evidence of a causal association for exacerbation of childhood asthma as “sufficient.” The panel categorized evidence of a causal association for new onset asthma as between “sufficient” and “suggestive but not sufficient.” “Suggestive of a causal association” was how the panel categorized evidence linking traffic-associated air pollutants with exacerbation of adult respiratory symptoms and lung function decrement. It categorized as “inadequate and insufficient” evidence of a causal relationship between traffic-related air pollution and health care utilization for respiratory problems, new onset adult asthma, chronic obstructive pulmonary disease (COPD), nonasthmatic respiratory allergy, and cancer in adults and children. Other literature reviews have been published with conclusions generally similar to the HEI panel’s.<sup>690 691 692 693</sup> However, in 2014, researchers from the U.S. Centers for Disease Control and Prevention (CDC) published a systematic review and meta-analysis of studies evaluating the risk of childhood leukemia associated with traffic exposure and reported positive associations between “postnatal” proximity to traffic and leukemia risks, but no such association for “prenatal” exposures.<sup>694</sup>

Health outcomes with few publications suggest the possibility of other effects still lacking sufficient evidence to draw definitive conclusions. Among these outcomes with a small number of positive studies are neurological impacts (e.g., autism and reduced cognitive function) and reproductive outcomes (e.g., preterm birth, low birth weight).<sup>695 696 697 698</sup>

In addition to health outcomes, particularly cardiopulmonary effects, conclusions of numerous studies suggest mechanisms by which traffic-related air pollution affects health. Numerous studies indicate that near-roadway exposures may increase systemic inflammation, affecting organ systems, including blood vessels and lungs.<sup>699 700 701 702</sup> Long-term exposures in near-road environments have been associated with inflammation-associated conditions, such as atherosclerosis and asthma.<sup>703 704 705</sup>

Several studies suggest that some factors may increase susceptibility to the effects of traffic-associated air pollution. Several studies have found stronger respiratory associations in children experiencing chronic social stress, such as in violent neighborhoods or in homes with high family stress.<sup>706 707 708</sup>

<sup>696</sup> Franco-Suglia, S.; Gryparis, A.; Wright, R.O.; et al. (2007). Association of black carbon with cognition among children in a prospective birth cohort study. *Am J Epidemiol*. doi: 10.1093/aje/kwm308. [Online at <http://dx.doi.org>].

<sup>697</sup> Power, M.C.; Weisskopf, M.G.; Alexeev, S.E.; et al. (2011). Traffic-related air pollution and cognitive function in a cohort of older men. *Environ Health Perspect* 2011: 682–687.

<sup>698</sup> Wu, J.; Wilhelm, M.; Chung, J.; et al. (2011). Comparing exposure assessment methods for traffic-related air pollution in and adverse pregnancy outcome study. *Environ Res* 111: 685–6692.

<sup>699</sup> Riediker, M. (2007). Cardiovascular effects of fine particulate matter components in highway patrol officers. *Inhal Toxicol* 19: 99–105. doi: 10.1080/08958370701495238 Available at <http://dx.doi.org>.

<sup>700</sup> Alexeev, S.E.; Coull, B.A.; Gryparis, A.; et al. (2011). Medium-term exposure to traffic-related air pollution and markers of inflammation and endothelial function. *Environ Health Perspect* 119: 481–486. doi:10.1289/ehp.1002560 Available at <http://dx.doi.org>.

<sup>701</sup> Eckel, S.P.; Berhane, K.; Salam, M.T.; et al. (2011). Traffic-related pollution exposure and exhaled nitric oxide in the Children’s Health Study. *Environ Health Perspect* (IN PRESS). doi:10.1289/ehp.1103516. Available at <http://dx.doi.org>.

<sup>702</sup> Zhang, J.; McCreanor, J.E.; Cullinan, P.; et al. (2009). Health effects of real-world exposure diesel exhaust in persons with asthma. *Res Rep Health Effects Inst* 138. [Online at <http://www.healtheffects.org>].

<sup>703</sup> Adar, S.D.; Klein, R.; Klein, E.K.; et al. (2010). Air pollution and the microvasculature: a cross-sectional assessment of in vivo retinal images in the population-based Multi-Ethnic Study of Atherosclerosis. *PLoS Med* 7(11): E1000372. doi:10.1371/journal.pmed.1000372. Available at <http://dx.doi.org>.

<sup>704</sup> Kan, H.; Heiss, G.; Rose, K.M.; et al. (2008). Prospective analysis of traffic exposure as a risk factor for incident coronary heart disease: the Atherosclerosis Risk in Communities (ARIC) study. *Environ Health Perspect* 116: 1463–1468. doi:10.1289/ehp.11290. Available at <http://dx.doi.org>.

<sup>705</sup> McConnell, R.; Islam, T.; Shankardass, K.; et al. (2010). Childhood incident asthma and traffic-related air pollution at home and school. *Environ Health Perspect* 1021–1026.

<sup>706</sup> Islam, T.; Urban, R.; Gauderman, W.J.; et al. (2011). Parental stress increases the detrimental

<sup>682</sup> Liu, W.; Zhang, J.; Kwon, J.L.; et al. (2006). Concentrations and source characteristics of airborne carbonyl combls measured outside urban residences. *J Air Waste Manage Assoc* 56: 1196–1204.

<sup>683</sup> Cahill, T.M.; Charles, M.J.; Seaman, V.Y. (2010). Development and application of a sensitive method to determine concentrations of acrolein and other carbonyls in ambient air. *Health Effects Institute Research Report* 149. Available at <http://dx.doi.org>.

<sup>684</sup> In the widely-used PubMed database of health publications, between January 1, 1990 and August 18, 2011, 605 publications contained the keywords “traffic, pollution, epidemiology,” with approximately half the studies published after 2007.

<sup>685</sup> Laden, F.; Hart, J.E.; Smith, T.J.; Davis, M.E.; Garshick, E. (2007) Cause-specific mortality in the unionized U.S. trucking industry. *Environmental Health Perspect* 115:1192–1196.

<sup>686</sup> Peters, A.; von Klot, S.; Heier, M.; Trentinaglia, I.; Hörmann, A.; Wichmann, H.E.; Löwel, H. (2004) Exposure to traffic and the onset of myocardial infarction. *New England J Med* 351: 1721–1730.

<sup>687</sup> Zanobetti, A.; Stone, P.H.; Spelzer, F.E.; Schwartz, J.D.; Coull, B.A.; Suh, H.H.; Nearing, B.D.; Mittleman, M.A.; Verrier, R.L.; Gold, D.R. (2009) T-wave alternans, air pollution and traffic in high-risk subjects. *Am J Cardiol* 104: 665–670.

<sup>688</sup> Dubowsky Adar, S.; Adamkiewicz, G.; Gold, D.R.; Schwartz, J.; Coull, B.A.; Suh, H. (2007) Ambient and microenvironmental particles and exhaled nitric oxide before and after a group bus trip. *Environ Health Perspect* 115: 507–512.

<sup>689</sup> Health Effects Institute Panel on the Health Effects of Traffic-Related Air Pollution. (2010). *Traffic-related air pollution: a critical review of the literature on emissions, exposure, and health effects*. HEI Special Report 17. Available at <http://www.healtheffects.org>.

<sup>690</sup> Boothe, V.L.; Shendell, D.G. (2008). Potential health effects associated with residential proximity to freeways and primary roads: review of scientific literature, 1999–2006. *J Environ Health* 70: 33–41.

<sup>691</sup> Salam, M.T.; Islam, T.; Gilliland, F.D. (2008). Recent evidence for adverse effects of residential proximity to traffic sources on asthma. *Curr Opin Pulm Med* 14: 3–8.

<sup>692</sup> Sun, X.; Zhang, S.; Ma, X. (2014) No association between traffic density and risk of childhood leukemia: a meta-analysis. *Asia Pac J Cancer Prev* 15: 5229–5232.

<sup>693</sup> Raaschou-Nielsen, O.; Reynolds, P. (2006). Air pollution and childhood cancer: a review of the epidemiological literature. *Int J Cancer* 118: 2920–9.

<sup>694</sup> Boothe, V.L.; Boehmer, T.K.; Wendel, A.M.; Yip, F.Y. (2014) Residential traffic exposure and childhood leukemia: a systematic review and meta-analysis. *Am J Prev Med* 46: 413–422.

<sup>695</sup> Volk, H.E.; Hertz-Picciotto, I.; Delwiche, L.; et al. (2011). Residential proximity to freeways and autism in the CHARGE study. *Environ Health Perspect* 119: 873–877.

The risks associated with residence, workplace, or schools near major roads are of potentially high public health significance due to the large population in such locations. According to the 2009 American Housing Survey, over 22 million homes (17.0 percent of all U.S. housing units) were located within 300 feet of an airport, railroad, or highway with four or more lanes. This corresponds to a population of more than 50 million U.S. residents in close proximity to high-traffic roadways or other transportation sources. Based on 2010 Census data, a 2013 publication estimated that 19 percent of the U.S. population (over 59 million people) lived within 500 meters of roads with at least 25,000 annual average daily traffic (AADT), while about 3.2 percent of the population lived within 100 meters (about 300 feet) of such roads.<sup>709</sup> Another 2013 study estimated that 3.7 percent of the U.S. population (about 11.3 million people) lived within 150 meters (about 500 feet) of interstate highways or other freeways and expressways.<sup>710</sup> As discussed in Section VIII.A.(9), on average, populations near major roads have higher fractions of minority residents and lower socioeconomic status. Furthermore, on average, Americans spend more than an hour traveling each day, bringing nearly all residents into a high-exposure microenvironment for part of the day.

In light of these concerns, EPA has required through the NAAQS process that air quality monitors be placed near high-traffic roadways for determining concentrations of CO, NO<sub>2</sub>, and PM<sub>2.5</sub> (in addition to those existing monitors located in neighborhoods and other locations farther away from pollution sources). Near-roadway monitors for NO<sub>2</sub> begin operation between 2014 and 2017 in Core Based Statistical Areas (CBSAs) with population of at least 500,000. Monitors for CO and PM<sub>2.5</sub> begin operation between 2015 and 2017. These monitors will further our

effect of traffic exposure on children's lung function. *Am J Respir Crit Care Med* (In press).

<sup>707</sup> Clougherty, J.E.; Levy, J.I.; Kubzansky, L.D.; et al. (2007). Synergistic effects of traffic-related air pollution and exposure to violence on urban asthma etiology. *Environ Health Perspect* 115: 1140–1146.

<sup>708</sup> Chen, E.; Schrier, H.M.; Strunk, R.C.; et al. (2008). Chronic traffic-related air pollution and stress interact to predict biologic and clinical outcomes in asthma. *Environ Health Perspect* 116: 970–5.

<sup>709</sup> Rowangould, G.M. (2013) A census of the U.S. near-roadway population: public health and environmental justice considerations. *Transportation Research Part D* 25: 59–67.

<sup>710</sup> Boehmer, T.K.; Foster, S.L.; Henry, J.R.; Woghiren-Akinnifesi, E.L.; Yip, F.Y. (2013) Residential proximity to major highways—United States, 2010. *Morbidity and Mortality Weekly Report* 62(3): 46–50.

understanding of exposure in these locations.

EPA and DOT continue to research near-road air quality, including the types of pollutants found in high concentrations near major roads and health problems associated with the mixture of pollutants near roads.

#### (9) Environmental Justice

Environmental justice (EJ) is a principle asserting that all people deserve fair treatment and meaningful involvement with respect to environmental laws, regulations, and policies. EPA seeks to provide the same degree of protection from environmental health hazards for all people. DOT shares this goal and is informed about the potential environmental impacts of its rulemakings through its NEPA process (see NHTSA's DEIS). As referenced below, numerous studies have found that some environmental hazards are more prevalent in areas where racial/ethnic minorities and people with low socioeconomic status (SES) represent a higher fraction of the population compared with the general population. In addition, compared to non-Hispanic whites, some types of minorities may have greater levels of health problems during some life stages. For example, in 2014, about 13 percent of Black, non-Hispanic and 24 percent of Puerto Rican children were estimated to currently have asthma, compared with 8 percent of white, non-Hispanic children.<sup>711</sup>

As discussed in Section VIII.A.(8) of this document and NHTSA's FEIS, concentrations of many air pollutants are elevated near high-traffic roadways. If minority populations and low-income populations disproportionately live near such roads, then an issue of EJ may be present. We reviewed existing scholarly literature examining the potential for disproportionate exposure among minorities and people with low SES, and we conducted our own evaluation of two national datasets: The U.S. Census Bureau's American Housing Survey for calendar year 2009 and the U.S. Department of Education's database of school locations.

Publications that address EJ issues generally report that populations living near major roadways (and other types of transportation infrastructure) tend to be composed of larger fractions of nonwhite residents. People living in neighborhoods near such sources of air pollution also tend to be lower in income than people living elsewhere. Numerous studies evaluating the

<sup>711</sup> [http://www.cdc.gov/asthma/most\\_recent\\_data.htm](http://www.cdc.gov/asthma/most_recent_data.htm).

demographics and socioeconomic status of populations or schools near roadways have found that they include a greater percentage of minority residents, as well as lower SES (indicated by variables such as median household income). Locations in these studies include Los Angeles, CA; Seattle, WA; Wayne County, MI; Orange County, FL; and the State of California.<sup>712 713 714 715 716 717</sup> Such disparities may be due to multiple factors.<sup>718</sup>

People with low SES often live in neighborhoods with multiple stressors and health risk factors, including reduced health insurance coverage rates, higher smoking and drug use rates, limited access to fresh food, visible neighborhood violence, and elevated rates of obesity and some diseases such as asthma, diabetes, and ischemic heart disease. Although questions remain, several studies find stronger associations between air pollution and health in locations with such chronic neighborhood stress, suggesting that populations in these areas may be more susceptible to the effects of air pollution.<sup>719 720 721 722</sup> Household-level

<sup>712</sup> Marshall, J.D. (2008) Environmental inequality: air pollution exposures in California's South Coast Air Basin.

<sup>713</sup> Su, J.G.; Larson, T.; Gould, T.; Cohen, M.; Buzzelli, M. (2010) Transboundary air pollution and environmental justice: Vancouver and Seattle compared. *GeoJournal* 57: 595–608. doi:10.1007/s10708-009-9269-6 [Online at <http://dx.doi.org>].

<sup>714</sup> Chakraborty, J.; Zandbergen, P.A. (2007) Children at risk: measuring racial/ethnic disparities in potential exposure to air pollution at school and home. *J Epidemiol Community Health* 61: 1074–1079. doi: 10.1136/jech.2006.054130 [Online at <http://dx.doi.org>].

<sup>715</sup> Green, R.S.; Smorodinsky, S.; Kim, J.J.; McLaughlin, R.; Ostro, B. (2003) Proximity of California public schools to busy roads. *Environ Health Perspect* 112: 61–66. doi:10.1289/ehp.6566 [http://dx.doi.org].

<sup>716</sup> Wu, Y.; Batterman, S.A. (2006) Proximity of schools in Detroit, Michigan to automobile and truck traffic. *J Exposure Sci & Environ Epidemiol*. doi:10.1038/sj.jes.7500484 [Online at <http://dx.doi.org>].

<sup>717</sup> Su, J.G.; Jerrett, M.; de Nazelle, A.; Wolch, J. (2011) Does exposure to air pollution in urban parks have socioeconomic, racial, or ethnic gradients? *Environ Res* 111: 319–328.

<sup>718</sup> Depro, B.; Timmins, C. (2008) Mobility and environmental equity: do housing choices determine exposure to air pollution? North Carolina State University Center for Environmental and Resource Economic Policy.

<sup>719</sup> Clougherty, J.E.; Kubzansky, L.D. (2009) A framework for examining social stress and susceptibility to air pollution in respiratory health. *Environ Health Perspect* 117: 1351–1358. Doi:10.1289/ehp.0900612 [Online at <http://dx.doi.org>].

<sup>720</sup> Clougherty, J.E.; Levy, J.I.; Kubzansky, L.D.; Ryan, P.B.; Franco Suglia, S.; Jacobson Canner, M.; Wright, R.J. (2007) Synergistic effects of traffic-related air pollution and exposure to violence on urban asthma etiology. *Environ Health Perspect* 115: 1140–1146. doi:10.1289/ehp.9863 [Online at <http://dx.doi.org>].

<sup>721</sup> Finkelstein, M.M.; Jerrett, M.; DeLuca, P.; Finkelstein, N.; Verma, D.K.; Chapman, K.; Sears,

stressors such as parental smoking and relationship stress also may increase susceptibility to the adverse effects of air pollution.<sup>723 724</sup>

More recently, three publications report nationwide analyses that compare the demographic patterns of people who do or do not live near major roadways.<sup>725 726 727</sup> All three of these studies found that people living near major roadways are more likely to be minorities or low in SES. They also found that the outcomes of their analyses varied between regions within the U.S. However, only one such study looked at whether such conclusions were confounded by living in a location with higher population density and how demographics differ between locations nationwide. In general, it found that higher density areas have higher proportions of low income and minority residents.

We analyzed two national databases that allowed us to evaluate whether homes and schools were located near a major road and whether disparities in exposure may be occurring in these environments. The American Housing Survey (AHS) includes descriptive statistics of over 70,000 housing units across the nation. The study survey is conducted every two years by the U.S. Census Bureau. The second database we analyzed was the U.S. Department of Education's Common Core of Data,

which includes enrollment and location information for schools across the U.S.

In analyzing the 2009 AHS, we focused on whether or not a housing unit was located within 300 feet of "4-or-more lane highway, railroad, or airport."<sup>728</sup> We analyzed whether there were differences between households in such locations compared with those in locations farther from these transportation facilities.<sup>729</sup> We included other variables, such as land use category, region of country, and housing type. We found that homes with a nonwhite householder were 22–34 percent more likely to be located within 300 feet of these large transportation facilities than homes with white householders. Homes with a Hispanic householder were 17–33 percent more likely to be located within 300 feet of these large transportation facilities than homes with non-Hispanic householders. Households near large transportation facilities were, on average, lower in income and educational attainment, more likely to be a rental property and located in an urban area compared with households more distant from transportation facilities.

In examining schools near major roadways, we examined the Common Core of Data (CCD) from the U.S. Department of Education, which includes information on all public elementary and secondary schools and school districts nationwide.<sup>730</sup> To determine school proximities to major roadways, we used a geographic information system (GIS) to map each school and roadways based on the U.S. Census's TIGER roadway file.<sup>731</sup> We found that minority students were overrepresented at schools within 200 meters of the largest roadways, and that schools within 200 meters of the largest roadways also had higher than expected numbers of students eligible for free or reduced-price lunches. For example, Black students represent 22 percent of students at schools located within 200 meters of a primary road, whereas Black students represent 17 percent of students in all U.S. schools. Hispanic

students represent 30 percent of students at schools located within 200 meters of a primary road, whereas Hispanic students represent 22 percent of students in all U.S. schools.

Overall, there is substantial evidence that people who live or attend school near major roadways are more likely to be of a minority race, Hispanic ethnicity, and/or low SES. The emission reductions from these final rules will likely result in widespread air quality improvements, but the impact on pollution levels in close proximity to roadways will be most direct. Thus, these final rules will likely help in mitigating the disparity in racial, ethnic, and economically based exposures.

### *B. Environmental Effects of Non-GHG Pollutants*

#### (1) Visibility

Visibility can be defined as the degree to which the atmosphere is transparent to visible light.<sup>732</sup> Visibility impairment is caused by light scattering and absorption by suspended particles and gases. Visibility is important because it has direct significance to people's enjoyment of daily activities in all parts of the country. Individuals value good visibility for the well-being it provides them directly, where they live and work, and in places where they enjoy recreational opportunities. Visibility is also highly valued in significant natural areas, such as national parks and wilderness areas, and special emphasis is given to protecting visibility in these areas. For more information on visibility see the final 2009 p.m. ISA.<sup>733</sup>

EPA is working to address visibility impairment. Reductions in air pollution from implementation of various programs associated with the Clean Air Act Amendments of 1990 (CAAA) provisions have resulted in substantial improvements in visibility and will continue to do so in the future. Because trends in haze are closely associated with trends in particulate sulfate and nitrate due to the relationship between their concentration and light extinction, visibility trends have improved as emissions of SO<sub>2</sub> and NO<sub>x</sub> have decreased over time due to air pollution

M.R. (2003) Relation between income, air pollution and mortality: a cohort study. *Canadian Med Assn J* 169: 397–402.

<sup>722</sup> Shankardass, K.; McConnell, R.; Jerrett, M.; Milam, J.; Richardson, J.; Berhane, K. (2009) Parental stress increases the effect of traffic-related air pollution on childhood asthma incidence. *Proc Natl Acad Sci* 106: 12406–12411. doi:10.1073/pnas.0812910106 [Online at <http://dx.doi.org/>].

<sup>723</sup> Lewis, A.S.; Sax, S.N.; Wason, S.C.; Campleman, S.L. (2011) Non-chemical stressors and cumulative risk assessment: an overview of current initiatives and potential air pollutant interactions. *Int J Environ Res Public Health* 8: 2020–2073. Doi:10.3390/ijerph8062020 [Online at <http://dx.doi.org/>].

<sup>724</sup> Rosa, M.J.; Jung, K.H.; Perzanowski, M.S.; Kelvin, E.A.; Darling, K.W.; Camann, D.E.; Chillrud, S.N.; Whyatt, R.M.; Kinney, P.L.; Perera, F.P.; Miller, R.L. (2010) Prenatal exposure to polycyclic aromatic hydrocarbons, environmental tobacco smoke and asthma. *Respir Med* (In press). doi:10.1016/j.rmed.2010.11.022 [Online at <http://dx.doi.org/>].

<sup>725</sup> Rowangould, G.M. (2013) A census of the U.S. near-roadway population: public health and environmental justice considerations. *Transportation Research Part D*; 59–67.

<sup>726</sup> Tian, N.; Xue, J.; Barzyk, T.M. (2013) Evaluating socioeconomic and racial differences in traffic-related metrics in the United States using a GIS approach. *J Exposure Sci Environ Epidemiol* 23: 215–222.

<sup>727</sup> Boehmer, T.K.; Foster, S.L.; Henry, J.R.; Woghiren-Akinnifesi, E.L.; Yip, F.Y. (2013) Residential proximity to major highways—United States, 2010. *Morbidity and Mortality Weekly Report* 62(3): 46–50.

<sup>728</sup> This variable primarily represents roadway proximity. According to the Central Intelligence Agency's World Factbook, in 2010, the United States had 6,506,204 km of roadways, 224,792 km of railways, and 15,079 airports. Highways thus represent the overwhelming majority of transportation facilities described by this factor in the AHS.

<sup>729</sup> Bailey, C. (2011) Demographic and Social Patterns in Housing Units Near Large Highways and other Transportation Sources. Memorandum to docket.

<sup>730</sup> <http://nces.ed.gov/ccd/>.

<sup>731</sup> Pedde, M.; Bailey, C. (2011) Identification of Schools within 200 Meters of U.S. Primary and Secondary Roads. Memorandum to the docket.

<sup>732</sup> National Research Council, (1993). *Protecting Visibility in National Parks and Wilderness Areas*. National Academy of Sciences Committee on Haze in National Parks and Wilderness Areas. National Academy Press, Washington, DC. This book can be viewed on the National Academy Press Web site at <http://www.nap.edu/books/0309048443/html/>.

<sup>733</sup> U.S. EPA. (2009). *Integrated Science Assessment for Particulate Matter* (Final Report). U.S. Environmental Protection Agency, Washington, DC, EPA/600/R-08/139F.

regulations such as the Acid Rain Program.<sup>734</sup>

In the Clean Air Act Amendments of 1977, Congress recognized visibility's value to society by establishing a national goal to protect national parks and wilderness areas from visibility impairment caused by manmade pollution.<sup>735</sup> In 1999, EPA finalized the regional haze program to protect the visibility in Mandatory Class I Federal areas.<sup>736</sup> There are 156 national parks, forests and wilderness areas categorized as Mandatory Class I Federal areas.<sup>737</sup> These areas are defined in CAA Section 162 as those national parks exceeding 6,000 acres, wilderness areas and memorial parks exceeding 5,000 acres, and all international parks which were in existence on August 7, 1977.

EPA has also concluded that PM<sub>2.5</sub> causes adverse effects on visibility in other areas that are not targeted by the Regional Haze Rule, such as urban areas, depending on PM<sub>2.5</sub> concentrations and other factors such as dry chemical composition and relative humidity (*i.e.*, an indicator of the water composition of the particles). EPA revised the PM<sub>2.5</sub> standards in December 2012 and established a target level of protection that is expected to be met through attainment of the existing secondary standards for PM<sub>2.5</sub>.

## (2) Plant and Ecosystem Effects of Ozone

The welfare effects of ozone can be observed across a variety of scales, *i.e.* subcellular, cellular, leaf, whole plant, population and ecosystem. Ozone effects that begin at small spatial scales, such as the leaf of an individual plant, when they occur at sufficient magnitudes (or to a sufficient degree) can result in effects being propagated along a continuum to larger and larger spatial scales. For example, effects at the individual plant level, such as altered rates of leaf gas exchange, growth and reproduction, can, when widespread, result in broad changes in ecosystems, such as productivity, carbon storage, water cycling, nutrient cycling, and community composition.

Ozone can produce both acute and chronic injury in sensitive species depending on the concentration level and the duration of the exposure.<sup>738</sup> In

those sensitive species,<sup>739</sup> effects from repeated exposure to ozone throughout the growing season of the plant tend to accumulate, so that even low concentrations experienced for a longer duration have the potential to create chronic stress on vegetation.<sup>740</sup> Ozone damage to sensitive species includes impaired photosynthesis and visible injury to leaves. The impairment of photosynthesis, the process by which the plant makes carbohydrates (its source of energy and food), can lead to reduced crop yields, timber production, and plant productivity and growth. Impaired photosynthesis can also lead to a reduction in root growth and carbohydrate storage below ground, resulting in other, more subtle plant and ecosystem impacts.<sup>741</sup> These latter impacts include increased susceptibility of plants to insect attack, disease, harsh weather, interspecies competition and overall decreased plant vigor. The adverse effects of ozone on areas with sensitive species could potentially lead to species shifts and loss from the affected ecosystems,<sup>742</sup> resulting in a loss or reduction in associated ecosystem goods and services. Additionally, visible ozone injury to leaves can result in a loss of aesthetic value in areas of special scenic significance like national parks and wilderness areas and reduced use of sensitive ornamentals in landscaping.<sup>743</sup>

The most recent Integrated Science Assessment (ISA) for Ozone presents more detailed information on how ozone affects vegetation and ecosystems.<sup>744</sup> The ISA concludes that ambient concentrations of ozone are associated with a number of adverse welfare effects and characterizes the weight of evidence for different effects

associated with ozone.<sup>745</sup> The ISA concludes that visible foliar injury effects on vegetation, reduced vegetation growth, reduced productivity in terrestrial ecosystems, reduced yield and quality of agricultural crops, and alteration of below-ground biogeochemical cycles are causally associated with exposure to ozone. It also concludes that reduced carbon sequestration in terrestrial ecosystems, alteration of terrestrial ecosystem water cycling, and alteration of terrestrial community composition are likely to be causally associated with exposure to ozone.

## (3) Atmospheric Deposition

Wet and dry deposition of ambient particulate matter delivers a complex mixture of metals (*e.g.*, mercury, zinc, lead, nickel, aluminum, and cadmium), organic compounds (*e.g.*, polycyclic organic matter, dioxins, and furans) and inorganic compounds (*e.g.*, nitrate, sulfate) to terrestrial and aquatic ecosystems. The chemical form of the compounds deposited depends on a variety of factors including ambient conditions (*e.g.*, temperature, humidity, oxidant levels) and the sources of the material. Chemical and physical transformations of the compounds occur in the atmosphere as well as the media onto which they deposit. These transformations in turn influence the fate, bioavailability and potential toxicity of these compounds.

Adverse impacts to human health and the environment can occur when particulate matter is deposited to soils, water, and biota.<sup>746</sup> Deposition of heavy metals or other toxics may lead to the human ingestion of contaminated fish, impairment of drinking water, damage to terrestrial, freshwater and marine ecosystem components, and limits to recreational uses. Atmospheric deposition has been identified as a key component of the environmental and human health hazard posed by several pollutants including mercury, dioxin and PCBs.<sup>747</sup>

<sup>745</sup> The Ozone ISA evaluates the evidence associated with different ozone related health and welfare effects, assigning one of five "weight of evidence" determinations: causal relationship, likely to be a causal relationship, suggestive of a causal relationship, inadequate to infer a causal relationship, and not likely to be a causal relationship. For more information on these levels of evidence, please refer to Table II of the ISA.

<sup>746</sup> U.S. EPA. Integrated Science Assessment for Particulate Matter (Final Report). U.S. Environmental Protection Agency, Washington, DC, EPA/600/R-08/139F, 2009.

<sup>747</sup> U.S. EPA. (2000). Deposition of Air Pollutants to the Great Waters: Third Report to Congress. Office of Air Quality Planning and Standards. EPA-453/R-00-0005.

<sup>734</sup> U.S. EPA. 2009 Final Report: Integrated Science Assessment for Particulate Matter. U.S. Environmental Protection Agency, Washington, DC, EPA/600/R-08/139F, 2009.

<sup>735</sup> See Section 169(a) of the Clean Air Act.

<sup>736</sup> 64 FR 35714, July 1, 1999.

<sup>737</sup> 62 FR 38680-38681, July 18, 1997.

<sup>738</sup> 73 FR 16486, March 27, 2008.

<sup>739</sup> 73 FR 16491, March 27, 2008. Only a small percentage of all the plant species growing within the U.S. (over 43,000 species have been catalogued in the USDA PLANTS database) have been studied with respect to ozone sensitivity.

<sup>740</sup> The concentration at which ozone levels overwhelm a plant's ability to detoxify or compensate for oxidant exposure varies. Thus, whether a plant is classified as sensitive or tolerant depends in part on the exposure levels being considered. Chapter 9, Section 9.3.4 of U.S. EPA, 2013 Integrated Science Assessment for Ozone and Related Photochemical Oxidants. Office of Research and Development/National Center for Environmental Assessment. U.S. Environmental Protection Agency. EPA 600/R-10/076F.

<sup>741</sup> 73 FR 16492, March 27, 2008.

<sup>742</sup> 73 FR 16493-16494, March 27, 2008, Ozone impacts could be occurring in areas where plant species sensitive to ozone have not yet been studied or identified.

<sup>743</sup> 73 FR 16490-16497, March 27, 2008.

<sup>744</sup> U.S. EPA. Integrated Science Assessment of Ozone and Related Photochemical Oxidants (Final Report). U.S. Environmental Protection Agency, Washington, DC, EPA/600/R-10/076F, 2013. The ISA is available at <http://cfpub.epa.gov/ncea/isa/recordisplay.cfm?deid=247492#Download>.



The ecological effects of acidifying deposition and nutrient enrichment are detailed in the Integrated Science Assessment for Oxides of Nitrogen and Sulfur-Ecological Criteria.<sup>748</sup> Atmospheric deposition of nitrogen and sulfur contributes to acidification, altering biogeochemistry and affecting animal and plant life in terrestrial and aquatic ecosystems across the United States. The sensitivity of terrestrial and aquatic ecosystems to acidification from nitrogen and sulfur deposition is predominantly governed by geology. Prolonged exposure to excess nitrogen and sulfur deposition in sensitive areas acidifies lakes, rivers and soils. Increased acidity in surface waters creates inhospitable conditions for biota and affects the abundance and biodiversity of fishes, zooplankton and macroinvertebrates and ecosystem function. Over time, acidifying deposition also removes essential nutrients from forest soils, depleting the capacity of soils to neutralize future acid loadings and negatively affecting forest sustainability. Major effects in forests include a decline in sensitive tree species, such as red spruce (*Picea rubens*) and sugar maple (*Acer saccharum*). In addition to the role nitrogen deposition plays in acidification, nitrogen deposition also leads to nutrient enrichment and altered biogeochemical cycling. In aquatic systems increased nitrogen can alter species assemblages and cause eutrophication. In terrestrial systems nitrogen loading can lead to loss of nitrogen-sensitive lichen species, decreased biodiversity of grasslands, meadows and other sensitive habitats, and increased potential for invasive species. For a broader explanation of the topics treated here, refer to the description in Chapter 8.1.2.3 of the RIA.

Building materials including metals, stones, cements, and paints undergo natural weathering processes from exposure to environmental elements (e.g., wind, moisture, temperature fluctuations, sunlight, etc.). Pollution can worsen and accelerate these effects. Deposition of PM is associated with both physical damage (materials damage effects) and impaired aesthetic qualities (soiling effects). Wet and dry deposition of PM can physically affect materials, adding to the effects of natural weathering processes, by potentially promoting or accelerating the corrosion

<sup>748</sup> NO<sub>x</sub> and SO<sub>x</sub> secondary ISA<sup>1</sup> U.S. EPA. Integrated Science Assessment (ISA) for Oxides of Nitrogen and Sulfur Ecological Criteria (Final Report). U.S. Environmental Protection Agency, Washington, DC, EPA/600/R-08/082F, 2008.

of metals, by degrading paints and by deteriorating building materials such as stone, concrete and marble.<sup>749</sup> The effects of PM are exacerbated by the presence of acidic gases and can be additive or synergistic due to the complex mixture of pollutants in the air and surface characteristics of the material. Acidic deposition has been shown to have an effect on materials including zinc/galvanized steel and other metal, carbonate stone (as monuments and building facings), and surface coatings (paints).<sup>750</sup> The effects on historic buildings and outdoor works of art are of particular concern because of the uniqueness and irreplaceability of many of these objects.

#### (4) Environmental Effects of Air Toxics

Emissions from producing, transporting and combusting fuel contribute to ambient levels of pollutants that contribute to adverse effects on vegetation. Volatile organic compounds, some of which are considered air toxics, have long been suspected to play a role in vegetation damage.<sup>751</sup> In laboratory experiments, a wide range of tolerance to VOCs has been observed.<sup>752</sup> Decreases in harvested seed pod weight have been reported for the more sensitive plants, and some studies have reported effects on seed germination, flowering and fruit ripening. Effects of individual VOCs or their role in conjunction with other stressors (e.g., acidification, drought, temperature extremes) have not been well studied. In a recent study of a mixture of VOCs including ethanol and toluene on herbaceous plants, significant effects on seed production, leaf water content and photosynthetic efficiency were reported for some plant species.<sup>753</sup>

<sup>749</sup> U.S. Environmental Protection Agency (U.S. EPA). 2009. Integrated Science Assessment for Particulate Matter (Final Report). EPA-600-R-08-139F. National Center for Environmental Assessment—RTP Division. December. Available on the Internet at <<http://cfpub.epa.gov/ncea/cfm/recorddisplay.cfm?deid=216546>>.

<sup>750</sup> Irving, P.M., e.d. 1991. Acid Deposition: State of Science and Technology, Volume III, Terrestrial, Materials, Health, and Visibility Effects, The U.S. National Acid Precipitation Assessment Program, Chapter 24, page 24–76.

<sup>751</sup> U.S. EPA. (1991). Effects of organic chemicals in the atmosphere on terrestrial plants. EPA/600/3-91/001.

<sup>752</sup> Cape JN, ID Leith, J Binnie, J Content, M Donkin, M Skewes, DN Price AR Brown, AD Sharpe. (2003). Effects of VOCs on herbaceous plants in an open-top chamber experiment. Environ. Pollut. 124:341–343.

<sup>753</sup> Cape JN, ID Leith, J Binnie, J Content, M Donkin, M Skewes, DN Price AR Brown, AD Sharpe. (2003). Effects of VOCs on herbaceous plants in an open-top chamber experiment. Environ. Pollut. 124:341–343.

Research suggests an adverse impact of vehicle exhaust on plants, which has in some cases been attributed to aromatic compounds and in other cases to nitrogen oxides.<sup>754 755 756</sup>

#### C. Emissions Inventory Impacts

As described in Section VII, the agencies conducted two analyses for these rules using DOT's CAFE model and EPA's MOVES model, relative to different reference cases (i.e., different baselines). The agencies used EPA's MOVES model to estimate the non-GHG impacts for tractor-trailers (including the engine that powers the vehicle) and vocational vehicles (including the engine that powers the vehicle). For heavy-duty pickups and vans, the agencies performed separate analyses using the CAFE model (included in NHTSA's "Method A;" See Section VI) and the MOVES model (included in EPA's "Method B;" See Section VI) to estimate non-GHG emissions from these vehicles. For these methods, the agencies analyzed the impact of the rules relative to two different reference cases—flat and dynamic. The flat baseline projects very little improvement in new vehicles in the absence of new Phase 2 standards. In contrast, the dynamic baseline projects more significant improvements in vehicle fuel efficiency. The agencies considered both reference cases. The results for all of the regulatory alternatives relative to both reference cases, derived via the same methodologies discussed in Section VII of the Preamble, are presented in Section X of the Preamble.

For brevity, a subset of these analyses are presented in this section and the reader is referred to both Chapter 11 of the RIA and NHTSA's FEIS Chapters 3, 4 and 5 for complete sets of these analyses. In this section, Method A is presented for the final standards, relative to both the dynamic baseline (Alternative 1b) and the flat baseline (Alternative 1a). Method B is presented for the final standards, relative only to the flat baseline.

The following subsections summarize two slightly different analyses of the annual non-GHG emissions reductions expected from these standards. Section VIII.A.(1) presents the impacts of the

<sup>754</sup> Viskari E-L. (2000). Epicuticular wax of Norway spruce needles as indicator of traffic pollutant deposition. Water, Air, and Soil Pollut. 121:327–337.

<sup>755</sup> Ugrekheilidze D, F Korte, G Kvesitadze. (1997). Uptake and transformation of benzene and toluene by plant leaves. Ecotox. Environ. Safety 37:24–29.

<sup>756</sup> Kammerbauer H, H Selinger, R Rommelt, A Ziegler-Jons, D Knoppik, B Hock. (1987). Toxic components of motor vehicle emissions for the spruce *Picea abies*. Environ. Pollut. 48:235–243.



final rules on non-GHG emissions using the analytical Method A, relative to two different reference cases—flat and dynamic. Section VIII.A.(2) presents the impacts of these standards, relative to the flat reference case only, using the MOVES model for all heavy-duty vehicle categories.

(1) Impacts of the Final Rules Using Analysis Method A

(a) Calendar Year Analysis

(i) Upstream Impacts of the Final Program

Increasing efficiency in heavy-duty vehicles will result in reduced fuel demand and, therefore, reductions in the emissions associated with all

processes involved in getting petroleum to the pump. Both Method A and Method B project these impacts for fuel consumed by vocational vehicles and combination tractor-trailers, using EPA’s MOVES model. See Section VII.A. for the description of this methodology. To project these impacts for fuel consumed by HD pickups and vans, Method A used similar calculations and inputs applicable to the CAFE model, as discussed above in Section VI. More information on the development of the emission factors used in this analysis can be found in Chapter 5 of the RIA.

The following two tables summarize the projected upstream emission impacts of the final program on both criteria pollutants and air toxics from

the heavy-duty sector, relative to Alternative 1b (dynamic baseline conditions under the No-Action Alternative) and Alternative 1a (flat baseline conditions under the No-Action Alternative), using analysis method A. Using either No-Action Alternative shows decreases in upstream emissions of all criteria pollutants, precursors, and air toxics; using Alternative 1a as the reference point attributes more of the emission reduction to the standards. Note that the rule is projected, in all analyses, of reducing emissions of NO<sub>x</sub>, contrary to implications in some of the public comments that fuel efficiency/GHG controls come at the expense of increased NO<sub>x</sub> emissions.

TABLE VIII–1—ANNUAL UPSTREAM IMPACTS ON CRITERIA POLLUTANTS AND AIR TOXICS FROM HEAVY-DUTY SECTOR IN CALENDAR YEARS 2025, 2040 AND 2050—FINAL PROGRAM VS. ALT 1b USING ANALYSIS METHOD A<sup>a</sup>

Pollutant	CY2025		CY2040		CY2050	
	US short tons	% Change	US short tons	% Change	US short tons	% Change
1,3-Butadiene .....	-1	-4.9	-4	-18	-5	-19
Acetaldehyde .....	-3	-4.4	-14	-15	-16	-16
Acrolein .....	-0.4	-4.6	-2	-16	-2	-17
Benzene .....	-23	-4.8	-88	-16	-105	-18
CO .....	-3,785	-4.9	-14,714	-17	-17,629	-19
Formaldehyde .....	-18	-4.9	-71	-17	-86	-19
NO <sub>x</sub> .....	-9,255	-4.9	-35,964	-17	-43,089	-19
PM <sub>2.5</sub> .....	-975	-4.9	-3,850	-18	-4,618	-19
SO <sub>x</sub> .....	-5,804	-4.9	-22,550	-17	-27,019	-19
VOC .....	-4,419	-4.8	-14,857	-15	-17,385	-16

**Note:**

<sup>a</sup>For an explanation of analytical Methods A and B, please see Section I.D; for an explanation of the flat baseline, 1a, and dynamic baseline, 1b, please see Section X.A.1.

TABLE VIII–2—ANNUAL UPSTREAM IMPACTS ON CRITERIA POLLUTANTS AND AIR TOXICS FROM HEAVY-DUTY SECTOR IN CALENDAR YEARS 2025, 2040 AND 2050—FINAL PROGRAM VS. ALT 1a USING ANALYSIS METHOD A<sup>a</sup>

Pollutant	CY2025		CY2040		CY2050	
	US short tons	% Change	US short tons	% Change	US short tons	% Change
1,3-Butadiene .....	-1	-5.3	-4	-20	-5	-21
Acetaldehyde .....	-4	-4.6	-15	-16	-17	-17
Acrolein .....	-0.4	-4.9	-2	-17	-2	-18
Benzene .....	-25	-5.1	-96	-18	-115	-19
CO .....	-4,142	-5.4	-16,298	-19	-19,558	-20
Formaldehyde .....	-20	-5.3	-79	-19	-95	-20
NO <sub>x</sub> .....	-10,124	-5.4	-39,813	-19	-47,779	-20
PM <sub>2.5</sub> .....	-1,065	-5.3	-4,258	-19	-5,117	-21
SO <sub>x</sub> .....	-6,349	-5.4	-24,961	-19	-29,958	-20
VOC .....	-4,810	-5.2	-16,218	-16	-19,004	-17

**Note:**

<sup>a</sup>For an explanation of analytical Methods A and B, please see Section I.D; for an explanation of the flat baseline, 1a, and dynamic baseline, 1b, please see Section X.A.1.

(ii) Downstream Impacts of the Final Program

For vocational vehicles and tractor-trailers, the agencies used the MOVES model to determine non-GHG emissions inventories. The improvements in engine efficiency and road load, the increased use of APUs, and VMT

rebound were included in the MOVES analysis. For NHTSA’s Method A analysis, presented in this section, the DOT CAFE model was used for HD pickups and vans. Further information about DOT’s CAFE model is available in Section VI.C and Chapter 10 of the RIA. The following two tables summarize the

projected downstream emission impacts of the final program on both criteria pollutants and air toxics from the heavy-duty sector, relative to Alternative 1b and Alternative 1a, using analysis Method A. Using either baseline shows a reduction in all criteria pollutants and air toxics—except for 1,3-Butadiene,

and CY2025 levels of acrolein, which show small increases in downstream emissions.

TABLE VIII-3—ANNUAL DOWNSTREAM IMPACTS ON CRITERIA POLLUTANTS AND AIR TOXICS FROM HEAVY-DUTY SECTOR IN CALENDAR YEARS 2025, 2040 AND 2050—FINAL PROGRAM VS. ALT 1b USING ANALYSIS METHOD A<sup>a</sup>

Pollutant	CY2025		CY2040		CY2050	
	US short tons	% Change	US short tons	% Change	US short tons	% Change
1,3-Butadiene	1	0.5	4	3.6	4	3.4
Acetaldehyde	-1	0.0	-16	-0.7	-19	-0.8
Acrolein	0.2	0.0	-0.3	-0.1	-1	-0.4
Benzene	-2	-0.1	-13	-1.2	-13	-1.1
CO	-9,045	-0.6	-34,702	-2.8	-42,095	-3.0
Formaldehyde	-21	-0.3	-96	-1.6	-119	-1.8
NO <sub>x</sub>	-12,082	-1.3	-53,254	-9.1	-65,068	-9.9
PM <sub>2.5</sub> <sup>b</sup>	-58	-0.2	-363	-2.0	-453	-2.2
SO <sub>x</sub>	-201	-4.1	-851	-16	-1,028	-17
VOC	-769	-0.8	-3,436	-5.3	-4,128	-5.8

**Notes:**

<sup>a</sup>For an explanation of analytical Methods A and B, please see Section I.D; for an explanation of the flat baseline, 1a, and dynamic baseline, 1b, please see Section X.A.1.

<sup>b</sup>PM<sub>2.5</sub> from tire wear and brake wear are included.

TABLE VIII-4—ANNUAL DOWNSTREAM IMPACTS ON CRITERIA POLLUTANTS AND AIR TOXICS FROM HEAVY-DUTY SECTOR IN CALENDAR YEARS 2025, 2040 AND 2050—FINAL PROGRAM VS. ALT 1a USING ANALYSIS METHOD A<sup>a</sup>

Pollutant	CY2025		CY2040		CY2050	
	US short tons	% Change	US short tons	% Change	US short tons	% Change
1,3-Butadiene	1	0.5	4	3.7	4	3.5
Acetaldehyde	-1	0.0	-14	-0.7	-18	-0.8
Acrolein	0.2	0.0	-0.3	-0.1	-1	-0.4
Benzene	-2	-0.2	-13	-1.2	-14	-1.2
CO	-8,944	-0.6	-34,502	-2.8	-41,880	-3.0
Formaldehyde	-20	-0.3	-91	-1.6	-113	-1.7
NO <sub>x</sub>	-13,368	-1.5	-60,594	-10.2	-74,206	-11
PM <sub>2.5</sub> <sup>b</sup>	-78	-0.2	-473	-2.6	-591	-2.9
SO <sub>x</sub>	-219	-4.5	-941	-17	-1,138	-19
VOC	-831	-0.8	-3,736	-5.8	-4,499	-6.3

**Notes:**

<sup>a</sup>For an explanation of analytical Methods A and B, please see Section I.D; for an explanation of the flat baseline, 1a, and dynamic baseline, 1b, please see Section X.A.1.

<sup>b</sup>PM<sub>2.5</sub> from tire wear and brake wear are included.

(iii) Total Impacts of the Final Program criteria pollutants and air toxics from the heavy-duty sector, relative to Alternative 1b and Alternative 1a, using analysis Method A. Under both baselines, Method A predicts a decrease in total emissions by calendar year 2050, but the amount attributable to the standards is larger using the flat baseline than the dynamic baseline.

The following two tables summarize the projected upstream emission impacts of the final program on both

TABLE VIII-5—ANNUAL TOTAL IMPACTS (UPSTREAM AND DOWNSTREAM) OF CRITERIA POLLUTANTS AND AIR TOXICS FROM HEAVY-DUTY SECTOR IN CALENDAR YEARS 2025, 2040 AND 2050—FINAL PROGRAM VS. ALT 1b USING ANALYSIS METHOD A<sup>a</sup>

Pollutant	CY2025		CY2040		CY2050	
	US short tons	% Change	US short tons	% Change	US short tons	% Change
1,3-Butadiene	0.3	0.1	0.1	0.1	-0.4	-0.3
Acetaldehyde	-4	-0.1	-30	-1.3	-35	-1.4
Acrolein	-0.2	0.0	-2	-0.7	-3	-0.9
Benzene	-25	-1.2	-101	-6.3	-118	-6.7
CO	-12,830	-0.9	-49,416	-3.7	-59,724	-4.0
Formaldehyde	-39	-0.5	-167	-2.7	-205	-2.9
NO <sub>x</sub>	-21,337	-2.0	-89,218	-11	-108,157	-12
PM <sub>2.5</sub>	-1,033	-2.0	-4,213	-10	-5,071	-11
SO <sub>x</sub>	-6,005	-4.9	-23,401	-17	-28,047	-19
VOC	-5,188	-2.7	-18,293	-11	-21,513	-12

**Notes:**

<sup>a</sup>For an explanation of analytical Methods A and B, please see Section I.D; for an explanation of the flat baseline, 1a, and dynamic baseline, 1b, please see Section X.A.1.

TABLE VIII–6—ANNUAL TOTAL IMPACTS (UPSTREAM AND DOWNSTREAM) OF CRITERIA POLLUTANTS AND AIR TOXICS FROM HEAVY-DUTY SECTOR IN CALENDAR YEARS 2025, 2040 AND 2050—FINAL PROGRAM VS. ALT 1a USING ANALYSIS METHOD A <sup>a</sup>

Pollutant	CY2025		CY2040		CY2050	
	US short tons	% Change	US short tons	% Change	US short tons	% Change
1,3-Butadiene .....	0.2	0.1	-0.2	-0.1	-1.0	-0.5
Acetaldehyde .....	-5	-0.2	-29	-1.3	-35	-1.4
Acrolein .....	-0.2	0.0	-2	-0.7	-3	-1.0
Benzene .....	-27	-1.4	-109	-6.8	-129	-7.2
CO .....	-13,086	-0.9	-50,800	-3.8	-61,438	-4.1
Formaldehyde .....	-40	-0.5	-170	-2.7	-208	-2.9
NO <sub>x</sub> .....	-23,492	-2.2	-100,407	-12	-121,985	-14
PM <sub>2.5</sub> .....	-1,143	-2.2	-4,731	-12	-5,708	-13
SO <sub>x</sub> .....	-6,568	-5.3	-25,902	-19	-31,096	-20
VOC .....	-5,641	-3.0	-19,954	-12	-23,503	-13

**Note:**

<sup>a</sup>For an explanation of analytical Methods A and B, please see Section I.D; for an explanation of the flat baseline, 1a, and dynamic baseline, 1b, please see Section X.A.1.

(b) Model Year Lifetime Analysis

Table VIII–7 shows the lifetime Non-GHG reductions for model years 2018–2029 attributable to the standards using Method A relative to both No-Action Alternatives. For NO<sub>x</sub>, approximately

half of the emission reductions are downstream and half are upstream. However, for PM<sub>2.5</sub> and SO<sub>x</sub> proportionally more of the emission reductions are attributable to upstream emission reductions than to downstream emission reductions. A

similar pattern emerges as with single calendar year snapshots; more emission reductions are attributable to the standards using the 1a baseline as the reference point than by using the 1b baseline as the reference point.

TABLE VIII–7—LIFETIME NON-GHG REDUCTIONS USING ANALYSIS METHOD A—SUMMARY FOR MODEL YEARS 2018–2029

[U.S. Short Tons]<sup>a</sup>

NO–action alternative (baseline)	Final program	
	1b (Dynamic)	1a (Flat)
NO <sub>x</sub> .....	494,495	548,630
Downstream .....	246,509	276,413
Upstream .....	247,986	272,217
PM <sub>2.5</sub> .....	27,827	30,838
Downstream <sup>b</sup> .....	1,437	1,891
Upstream .....	26,390	28,947
SO <sub>x</sub> .....	159,367	174,918
Downstream .....	3,849	4,214
Upstream .....	155,518	170,704

**Notes:**

<sup>a</sup>For an explanation of analytical Methods A and B, please see Section I.D; for an explanation of the flat baseline, 1a, and dynamic baseline, 1b, please see Section X.A.1.

<sup>b</sup>PM<sub>2.5</sub> from tire wear and brake wear are included.

(2) Impacts of the Final Rules Using Analysis Method B

(a) Calendar Year Analysis

(i) Upstream Impacts of the Final Program

Increasing efficiency in heavy-duty vehicles will result in reduced fuel demand and, therefore, reductions in the emissions associated with all processes involved in getting petroleum to the pump. To project these impacts, Method B estimated the impact of reduced petroleum volumes on the extraction and transportation of crude

oil as well as the production and distribution of finished gasoline and diesel. For the purpose of assessing domestic-only emission reductions, it was necessary to estimate the fraction of fuel savings attributable to domestic finished gasoline and diesel and, of this fuel, what fraction is produced from domestic crude. Method B estimated the emissions associated with production and distribution of gasoline and diesel from crude oil based on emission factors in the “Greenhouse Gases, Regulated Emissions, and Energy used in Transportation” model (GREET)

developed by DOE’s Argonne National Laboratory. In some cases, the GREET values were modified or updated by the agencies to be consistent with the National Emission Inventory (NEI) and emission factors from MOVES. Method B estimated the projected corresponding changes in upstream emissions using the same tools originally created for the Renewable Fuel Standard 2 (RFS2) rulemaking analysis,<sup>757</sup> used in the LD

<sup>757</sup>U.S. EPA. Draft Regulatory Impact Analysis: Changes to Renewable Fuel Standard Program.

GHG rulemakings,<sup>758</sup> HD GHG Phase 1,<sup>759</sup> and updated for the current analysis. More information on the development of the emission factors

used in this analysis can be found in Chapter 5 of the RIA. Table VIII–8 summarizes the projected upstream emission impacts of the final program on both criteria pollutants and air toxics from the heavy-

duty sector, relative to Alternative 1a, using analysis Method B. The comparable estimates relative to Alternative 1b are presented in Section VIII.C.(1).

TABLE VIII–8—ANNUAL UPSTREAM IMPACTS ON CRITERIA POLLUTANTS AND AIR TOXICS FROM HEAVY-DUTY SECTOR IN CALENDAR YEARS 2025, 2040 AND 2050—FINAL PROGRAM VS. ALT 1a USING ANALYSIS METHOD B<sup>a</sup>

Pollutant	CY2025		CY2040		CY2050	
	US short tons	% Change	US short tons	% Change	US short tons	% Change
1,3-Butadiene .....	-1	-4.8	-5	-19.0	-6	-20.6
Acetaldehyde .....	-7	-3.2	-35	-14.5	-38	-15.9
Acrolein .....	-1	-3.5	-3	-15.2	-4	-16.7
Benzene .....	-30	-3.8	-143	-16.1	-166	-17.6
CO .....	-3,809	-4.8	-16,884	-18.9	-20,227	-20.5
Formaldehyde .....	-20	-4.6	-90	-18.3	-107	-19.9
NO <sub>x</sub> .....	-9,314	-4.8	-41,280	-18.9	-49,462	-20.5
PM <sub>2.5</sub> .....	-1,037	-4.7	-4,619	-18.7	-5,520	-20.3
SO <sub>x</sub> .....	-5,828	-4.8	-25,811	-18.9	-30,941	-20.5
VOC .....	-4,234	-3.7	-20,010	-15.9	-23,240	-17.4

**Note:**

<sup>a</sup>For an explanation of analytical Methods A and B, please see Section I.D; for an explanation of the flat baseline, 1a, and dynamic baseline, 1b, please see Section X.A.1.

(ii) Downstream Impacts of the Final Program

The final program will impact the downstream emissions of non-GHG pollutants. These pollutants include oxides of nitrogen (NO<sub>x</sub>), oxides of sulfur (SO<sub>x</sub>), volatile organic compounds (VOC), carbon monoxide (CO), fine particulate matter (PM<sub>2.5</sub>), and air toxics. The agencies expect reductions in downstream emissions of NO<sub>x</sub>, PM<sub>2.5</sub>, VOC, SO<sub>x</sub>, CO, and air toxics. Much of these estimated net reductions are a result of the agencies' anticipation of increased use of auxiliary power units (APUs) in combination tractors during extended idling; APUs emit these pollutants at a lower rate than on-road engines during extended idle operation, with the exception of PM<sub>2.5</sub>. As discussed in

Section III.C.3, EPA is adopting Phase 1 and Phase 2 requirements to control PM<sub>2.5</sub> emissions from APUs installed in new tractors and therefore, eliminate the unintended consequence of increased PM<sub>2.5</sub> emissions from increased APU use.

Additional reductions in tailpipe emissions of NO<sub>x</sub> and CO and refueling emissions of VOC will be achieved through improvements in engine efficiency and reduced road load (improved aerodynamics and tire rolling resistance), which reduces the amount of work required to travel a given distance and increases fuel economy. For vehicle types not affected by road load improvements, such as HD pickups and vans <sup>760</sup>, non-GHG emissions will increase very slightly due to VMT rebound. In addition, brake wear and tire wear emissions of PM<sub>2.5</sub> will also

increase very slightly due to VMT rebound. The agencies estimate that downstream emissions of SO<sub>x</sub> will be reduced, because they are roughly proportional to fuel consumption.

For vocational vehicles and tractor-trailers, the agencies used MOVES to determine non-GHG emissions impacts of the final rules, relative to the flat baseline (Alternative 1a) and the dynamic baseline (Alternative 1b). The improvements in engine efficiency and road load, the increased use of APUs, and VMT rebound were included in the MOVES analysis. For this analysis, Method B also used the MOVES model for HD pickups and vans.

The downstream criteria pollutant and air toxics impacts of the final program, relative to Alternative 1a, using analysis Method B, are presented in Table VIII–9.

TABLE VIII–9—ANNUAL DOWNSTREAM IMPACTS ON CRITERIA POLLUTANTS AND AIR TOXICS FROM HEAVY-DUTY SECTOR IN CALENDAR YEARS 2025, 2040 AND 2050—FINAL PROGRAM VS. ALT 1a USING ANALYSIS METHOD B<sup>a</sup>

Pollutant	CY2025		CY2040		CY2050	
	US short tons	% Change	US short tons	% Change	US short tons	% Change
1,3-Butadiene .....	-1	-0.2	-3	-1.5	-3	-1.8
Acetaldehyde .....	-3	-0.1	-18	-0.8	-23	-0.9
Acrolein .....	-0.1	0	-1	-0.3	-1	-0.4
Benzene .....	-5	-0.2	-22	-1.4	-26	-1.6
CO .....	-9,445	-0.4	-35,710	-2.4	-43,642	-2.7

Chapters 2 and 3, May 26, 2009. Docket ID: EPA–HQ–OAR–2009–0472–0119.

<sup>758</sup> 2017 and Later Model Year Light-Duty Vehicle Greenhouse Gas Emissions and Corporate Average Fuel Economy Standards (77 FR 62623, October 15, 2012).

<sup>759</sup> Greenhouse Gas Emission Standards and Fuel Efficiency Standards for Medium- and Heavy-Duty Engines and Vehicles (76 FR 57106, September 15, 2011).

<sup>760</sup> HD pickups and vans are subject to gram per mile (distance) emission standards, as opposed to

larger heavy-duty vehicles which are certified to a gram per brake horsepower (work) standard.

TABLE VIII-9—ANNUAL DOWNSTREAM IMPACTS ON CRITERIA POLLUTANTS AND AIR TOXICS FROM HEAVY-DUTY SECTOR IN CALENDAR YEARS 2025, 2040 AND 2050—FINAL PROGRAM VS. ALT 1a USING ANALYSIS METHOD B<sup>a</sup>—Continued

Pollutant	CY2025		CY2040		CY2050	
	US short tons	% Change	US short tons	% Change	US short tons	% Change
Formaldehyde .....	-20	-0.2	-97	-1.5	-120	-1.7
NO <sub>x</sub> .....	-13,396	-1.4	-60,681	-9.7	-74,362	-10.8
PM <sub>2.5</sub> <sup>b</sup> .....	-73	-0.2	-462	-2.2	-580	-2.5
SO <sub>x</sub> .....	-252	-4.7	-1,122	-18.5	-1,341	-20.1
VOC .....	-1,071	-0.8	-5,060	-5.9	-6,013	-6.6

**Notes:**

<sup>a</sup>For an explanation of analytical Methods A and B, please see Section I.D; for an explanation of the flat baseline, 1a, and dynamic baseline, 1b, please see Section X.A.1.

<sup>b</sup>PM<sub>2.5</sub> from tire wear and brake wear are included.

As noted above, EPA is adopting Phase 1 and Phase 2 requirements to control PM<sub>2.5</sub> emissions from APUs installed in new tractors. In the NPRM, EPA projected an unintended increase in downstream PM<sub>2.5</sub> emissions because engines powering APUs are currently required to meet less stringent PM standards (40 CFR 1039.101) than on-road engines (40 CFR 86.007-11) and

because the increase in emissions from APUs more than offset the reduced tailpipe emissions from improved engine efficiency and road load. However, with the new requirements for APUs, the final program is projected to lead to reduced downstream PM<sub>2.5</sub> emissions of 462 tons in 2040 and 580 tons in 2050 (Table VIII-9). The net reductions in national PM<sub>2.5</sub> emissions

from the requirements for APUs are 927 tons and 1,114 tons in 2040 and 2050, respectively (Table VIII-10). See Section III.C.3 of the Preamble for additional details on EPA's PM emission standards for APUs. The development of APU emission rates with PM control is documented in a memorandum to the docket.<sup>761</sup>

TABLE VIII-10—IMPACT ON PM<sub>2.5</sub> EMISSIONS OF FURTHER PM<sub>2.5</sub> CONTROL ON APUS—FINAL PROGRAM VS. ALT 1a USING ANALYSIS METHOD B  
[US Short Tons]<sup>a</sup>

CY	Baseline national heavy-duty vehicle PM <sub>2.5</sub> emissions (tons)	Final HD phase 2 program national PM <sub>2.5</sub> emissions without further PM control (tons)	Final HD phase 2 program national PM <sub>2.5</sub> emissions with further PM control (tons)	Net impact on national PM <sub>2.5</sub> emission with further PM control on APUs (tons)
2040 .....	20,939	21,403	20,476	- 927
2050 .....	22,995	23,529	22,416	- 1,114

**Note:**

<sup>a</sup>For an explanation of analytical Methods A and B, please see Section I.D; for an explanation of the flat baseline, 1a, and dynamic baseline, 1b, please see Section X.A.1.

It is worth noting that the emission reductions shown in Table VIII-9 are not incremental to the emissions reductions projected in the Phase 1 rulemaking. This is because, as described in Sections III.D.(1).a of the Preamble, the agencies have revised their assumptions about the adoption rate of APUs. This final rule assumes that without the Phase 2 program (*i.e.*,

in the Phase 2 baselines), the APU adoption rate will be 9 percent for model years 2010 and later. EPA conducted an analysis to estimate the combined emissions impacts of the Phase 1 and the Phase 2 programs for NO<sub>x</sub>, VOC, SO<sub>x</sub> and PM<sub>2.5</sub> in calendar year 2050 using MOVES2014a. The results are shown in Table VIII-11. For NO<sub>x</sub> and PM<sub>2.5</sub> only, we also estimated

the combined Phase 1 and Phase 2 downstream and upstream emissions impacts for calendar year 2025, and project that the two rules combined will reduce NO<sub>x</sub> by up to 55,000 tons and PM<sub>2.5</sub> by up to 33,000 tons in that year. For additional details, see Chapter 5 of the RIA.

TABLE VIII-11—COMBINED PHASE 1 AND PHASE 2 ANNUAL DOWNSTREAM IMPACTS ON CRITERIA POLLUTANTS FROM HEAVY-DUTY SECTOR IN CALENDAR YEAR 2050—FINAL PROGRAM VS. ALT 1a USING ANALYSIS METHOD B  
[US Short Tons]<sup>a</sup>

CY	NO <sub>x</sub>	VOC	SO <sub>x</sub>	PM <sub>2.5</sub> <sup>b</sup>
2050 .....	- 100,878	- 10,067	- 2,249	- 1,001

**Notes:**

<sup>761</sup> U.S. EPA. Updates to MOVES for Emissions Analysis of Greenhouse Gas Emissions and Fuel

Efficiency Standards for Medium- and Heavy-Duty

Engines and Vehicles—Phase 2 FRM. Docket No. EPA-HQ-OAR-2016, July 2016.

<sup>a</sup>For an explanation of analytical Methods A and B, please see Section I.D; for an explanation of the flat baseline, 1a, and more dynamic baseline, 1b, please see Section X.A.1.

(iii) Total Impacts of the Final Program result in overall net reductions of NO<sub>x</sub>, VOC, SO<sub>x</sub>, CO, PM<sub>2.5</sub>, and air toxics emissions. The results are shown both in changes in absolute tons and in percent reductions from the flat reference to the final program for the heavy-duty sector.

As shown in Table VIII–12, EPA estimates that the final program will

TABLE VIII–12—ANNUAL TOTAL IMPACTS (UPSTREAM AND DOWNSTREAM) OF CRITERIA POLLUTANTS AND AIR TOXICS FROM HEAVY-DUTY SECTOR IN CALENDAR YEARS 2025, 2040 AND 2050—FINAL PROGRAM VS. ALT 1a USING ANALYSIS METHOD B <sup>a</sup>

Pollutant	CY2025		CY2040		CY2050	
	US short tons	% Change	US short tons	% Change	US short tons	% Change
1,3-Butadiene .....	-2	-0.5	-8	-3.7	-9	-4.1
Acetaldehyde .....	-10	-0.3	-53	-2.0	-61	-2.1
Acrolein .....	-1	-0.1	-4	-1.3	-5	-1.3
Benzene .....	-35	-1.1	-165	-6.8	-192	-7.5
CO .....	-13,254	-0.6	-52,594	-3.3	-63,869	-3.8
Formaldehyde .....	-40	-0.5	-187	-2.7	-227	-2.9
NO <sub>x</sub> .....	-22,710	-1.9	-101,961	-12.1	-123,824	-13.3
PM <sub>2.5</sub> .....	-1,110	-1.9	-5,081	-11.1	-6,100	-12.1
SO <sub>x</sub> .....	-6,080	-4.8	-26,933	-18.9	-32,282	-20.5
VOC .....	-5,305	-2.2	-25,070	-11.9	-29,253	-13.0

**Note:**

<sup>a</sup>For an explanation of analytical Methods A and B, please see Section I.D; for an explanation of the flat baseline, 1a, and dynamic baseline, 1b, please see Section X.A.1.

(b) Model Year Lifetime Analysis

In addition to the annual non-GHG emissions reductions expected from the final rules, EPA estimated the combined (downstream and upstream) non-GHG impacts for the lifetime of the impacted vehicles. Table VIII–13 shows the fleet-wide reductions of NO<sub>x</sub>, PM<sub>2.5</sub> and SO<sub>x</sub> from the final program, relative to Alternative 1a, through the lifetime <sup>762</sup> of heavy-duty vehicles. For the lifetime non-GHG reductions by vehicle categories, see Chapter 5 of the RIA.

TABLE VIII–13—LIFETIME NON-GHG REDUCTIONS USING ANALYSIS METHOD B—SUMMARY FOR MODEL YEARS 2018–2029

[U.S. Short Tons] <sup>a</sup>

No-action alternative (baseline)	Final program
	1a (Flat)
NO <sub>x</sub> .....	549,881
Downstream .....	277,644
Upstream .....	272,237
PM <sub>2.5</sub> .....	32,251
Downstream <sup>b</sup> .....	1,824
Upstream .....	30,427
SO <sub>x</sub> .....	175,202
Downstream .....	4,931
Upstream .....	170,272

**Note:**

<sup>762</sup> A lifetime of 30 years is assumed in MOVES.

<sup>a</sup>For an explanation of analytical Methods A and B, please see Section I.D; for an explanation of the flat baseline, 1a, and dynamic baseline, 1b, please see Section X.A.1.

<sup>b</sup>PM<sub>2.5</sub> from tire wear and brake wear are included.

*D. Air Quality Impacts of Non-GHG Pollutants*

Changes in emissions of non-GHG pollutants due to these rules will impact air quality. Information on current air quality and the results of our air quality modeling of the projected impacts of these rules are summarized in the following section. Additional information is available in Chapter 6 of the RIA.

(1) Current Concentrations of Non-GHG Pollutants

Nationally, levels of PM<sub>2.5</sub>, ozone, NO<sub>x</sub>, SO<sub>x</sub>, CO and air toxics are declining. <sup>763</sup> However, as of April 22, 2016, more than 125 million people lived in counties designated nonattainment for one or more of the NAAQS, and this figure does not include the people living in areas with a risk of exceeding a NAAQS in the future. <sup>764</sup> Many Americans continue to

<sup>763</sup> U.S. EPA, 2011. Our Nation's Air: Status and Trends through 2010. EPA-454/R-12-001. February 2012. Available at: <http://www3.epa.gov/airtrends/2011/>.

<sup>764</sup> Data come from Summary Nonattainment Area Population Exposure Report, current as of April 22, 2016 at: <https://www3.epa.gov/airquality/greenbk/popexp.html> and contained in Docket EPA-HQ-OAR-2014-0827.

be exposed to ambient concentrations of air toxics at levels which have the potential to cause adverse health effects. <sup>765</sup> In addition, populations who live, work, or attend school near major roads experience elevated exposure concentrations to a wide range of air pollutants. <sup>766</sup>

(a) Particulate Matter

There are two primary NAAQS for PM<sub>2.5</sub>: An annual standard (12.0 micrograms per cubic meter (µg/m<sup>3</sup>)) set in 2012 and a 24-hour standard (35 µg/m<sup>3</sup>) set in 2006, and two secondary NAAQS for PM<sub>2.5</sub>: An annual standard (15.0 µg/m<sup>3</sup>) set in 1997 and a 24-hour standard (35 µg/m<sup>3</sup>) set in 2006.

There are many areas of the country that are currently in nonattainment for the annual and 24-hour primary PM<sub>2.5</sub> NAAQS. In 2005 the EPA designated 39 nonattainment areas for the 1997 PM<sub>2.5</sub> NAAQS. <sup>767</sup> As of April 22, 2016, more than 23 million people lived in the 7 areas that are still designated as nonattainment for the 1997 annual PM<sub>2.5</sub> NAAQS. These PM<sub>2.5</sub>

<sup>765</sup> U.S. EPA. (2015) Summary of Results for the 2011 National-Scale Assessment. <https://www3.epa.gov/sites/production/files/2015-12/documents/2011-nata-summary-results.pdf>.

<sup>766</sup> Health Effects Institute Panel on the Health Effects of Traffic-Related Air Pollution. (2010) Traffic-related air pollution: A critical review of the literature on emissions, exposure, and health effects. HEI Special Report 17. Available at <http://www.healtheffects.org/>.

<sup>767</sup> 70 FR 19844 (April 14, 2005).

nonattainment areas are comprised of 33 full or partial counties. In December 2014 EPA designated 14 nonattainment areas for the 2012 annual PM<sub>2.5</sub> NAAQS.<sup>768</sup> In March 2015, EPA changed the initial designation from nonattainment to unclassifiable/attainment for four areas based on the availability of complete, certified 2014 air quality data showing these areas met the 2012 annual PM<sub>2.5</sub> NAAQS. The EPA also changed the initial 2012 annual PM<sub>2.5</sub> NAAQS designation from nonattainment to unclassifiable for the Louisville, Indiana-Kentucky area.<sup>769</sup> As of April 22, 2016, 9 of these areas remain designated as nonattainment, and they are composed of 20 full or partial counties with a population of over 23 million. On November 13, 2009 and February 3, 2011, the EPA designated 32 nonattainment areas for the 2006 24-hour PM<sub>2.5</sub> NAAQS.<sup>770</sup> As of April 22, 2016, 16 of these areas remain designated as nonattainment for the 2006 24-hour PM<sub>2.5</sub> NAAQS, and they are composed of 46 full or partial counties with a population of over 32 million. In total, there are currently 24 PM<sub>2.5</sub> nonattainment areas with a population of more than 39 million people.<sup>771</sup>

The EPA has already adopted many mobile source emission control programs that are expected to reduce ambient PM concentrations. As a result of these and other federal, state and local programs, the number of areas that fail to meet the PM<sub>2.5</sub> NAAQS in the future is expected to decrease. However, even with the implementation of all current state and federal regulations, there are projected to be counties violating the PM<sub>2.5</sub> NAAQS well into the future. States will need to meet the 2006 24-hour standards in the 2015–2019 timeframe and the 2012 primary annual standard in the 2021–2025 timeframe. The emission reductions and improvements in ambient PM<sub>2.5</sub> concentrations from this action, which will take effect as early as model year 2018, will be helpful to states as they

<sup>768</sup> EPA 2014. Fact Sheet: Final Area Designations for the Annual Fine Particle Standard. <https://www3.epa.gov/pmdesignations/2012standards/final/20141218fs.pdf>.

<sup>769</sup> <https://www3.epa.gov/pmdesignations/2012standards/final/20150331fs.pdf>.

<sup>770</sup> 74 FR 58688 (November 13, 2009) and 76 FR 6056 (February 3, 2011).

<sup>771</sup> The 39 million total is calculated by summing, without double counting, the 1997, 2006 and 2012 PM<sub>2.5</sub> nonattainment populations contained in the Summary Nonattainment Area Population Exposure report (<https://www3.epa.gov/airquality/greenbk/popexp.html>). If there is a population associated with more than one of the 1997, 2006 and 2012 nonattainment areas, and they are not the same, then the larger of the populations is included in the sum.

work to attain and maintain the PM<sub>2.5</sub> NAAQS.<sup>772</sup> The standards can assist areas with attainment dates in 2018 and beyond in attaining the NAAQS as expeditiously as practicable and may relieve areas with already stringent local regulations from some of the burden associated with adopting additional local controls.

#### (b) Ozone

The primary and secondary NAAQS for ozone are 8-hour standards with a level of 0.07 ppm. The most recent revision to the ozone standards was in 2015; the previous 8-hour ozone primary standard, set in 2008, had a level of 0.075 ppm. Final nonattainment designations for the 2008 ozone standard were issued on April 30, 2012, and May 31, 2012.<sup>773</sup> As of April 22, 2016, there were 44 ozone nonattainment areas for the 2008 ozone NAAQS, composed of 216 full or partial counties, with a population of more than 120 million. In addition, EPA plans to finalize nonattainment areas for the 2015 ozone NAAQS in October 2017.

States with ozone nonattainment areas are required to take action to bring those areas into attainment. The attainment date assigned to an ozone nonattainment area is based on the area's classification. The attainment dates for areas designated nonattainment for the 2008 8-hour ozone NAAQS are in the 2015 to 2032 timeframe, depending on the severity of the problem in each area. Nonattainment area attainment dates associated with areas designated for the 2015 NAAQS will be in the 2020–2037 timeframe, depending on the severity of the problem in each area.<sup>774</sup>

EPA has already adopted many emission control programs that are expected to reduce ambient ozone levels. As a result of these and other federal, state and local programs, 8-hour ozone levels are expected to improve in the future. However, even with the implementation of all current state and federal regulations, there are projected to be counties violating the ozone NAAQS well into the future. The emission reductions from this action, which will take effect as early as model year 2018, will be helpful to states as they work to attain and maintain the ozone NAAQS.<sup>775</sup> The standards can assist areas with attainment dates in

<sup>772</sup> The final Phase 2 trailer standards and PM controls for APUs begin with model year 2018.

<sup>773</sup> 77 FR 30088 (May 21, 2012) and 77 FR 34221 (June 11, 2012).

<sup>774</sup> <https://www3.epa.gov/ozone-pollution/2015-ozone-naaqs-timelines>.

<sup>775</sup> The final Phase 2 trailer standards begin with model year 2018.

2018 and beyond in attaining the NAAQS as expeditiously as practicable and may relieve areas with already stringent local regulations from some of the burden associated with adopting additional local controls.

#### (c) Nitrogen Dioxide

The EPA most recently completed a review of the primary NAAQS for NO<sub>2</sub> in January 2010. There are two primary NAAQS for NO<sub>2</sub>: An annual standard (53 ppb) and a 1-hour standard (100 ppb). The EPA promulgated area designations in the **Federal Register** on February 17, 2012. In this initial round of designations, all areas of the country were designated as “unclassifiable/attainment” for the 2010 NO<sub>2</sub> NAAQS based on data from the existing air quality monitoring network. The EPA and state agencies are working to establish an expanded network of NO<sub>2</sub> monitors, expected to be deployed in the 2014–2017 time frame. Once three years of air quality data have been collected from the expanded network, the EPA will be able to evaluate NO<sub>2</sub> air quality in additional locations.<sup>776 777</sup>

#### (d) Sulfur Dioxide

The EPA most recently completed a review of the primary SO<sub>2</sub> NAAQS in June 2010. The current primary NAAQS for SO<sub>2</sub> is a 1-hour standard of 75 ppb. The EPA finalized the initial area designations for 29 nonattainment areas in 16 states in a notice published in the **Federal Register** on August 5, 2013. In this first round of designations, EPA only designated nonattainment areas that were violating the standard based on existing air quality monitoring data provided by the states. The agency did not have sufficient information to designate any area as “attainment” or make final decisions about areas for which additional modeling or monitoring is needed (78 FR 47191, August 5, 2013). On March 2, 2015, the U.S. District Court for the Northern District of California accepted, as an enforceable order, an agreement between the EPA and Sierra Club and Natural Resources Defense Council to resolve litigation concerning the deadline for completing designations.<sup>778</sup> The court's order directs the EPA to complete designations for all remaining

<sup>776</sup> U.S. EPA. (2012). Fact Sheet—Air Quality Designations for the 2010 Primary Nitrogen Dioxide (NO<sub>2</sub>) National Ambient Air Quality Standards. <http://www3.epa.gov/airquality/nitrogenoxides/designations/pdfs/20120120FS.pdf>.

<sup>777</sup> U.S. Environmental Protection Agency (2013). Revision to Ambient Nitrogen Dioxide Monitoring Requirements. March 7, 2013. <http://www3.epa.gov/airquality/nitrogenoxides/pdfs/20130307fr.pdf>.

<sup>778</sup> *Sierra Club v. McCarthy*, No. 3–13–cv–3953 (SI) (N.D. Cal. Mar. 2, 2015).

areas in the country in up to three additional rounds: The first round by July 2, 2016, the second round by December 31, 2017, and the final round by December 31, 2020.

(e) Carbon Monoxide

There are two primary NAAQS for CO: An 8-hour standard (9 ppm) and a 1-hour standard (35 ppm). The primary NAAQS for CO were retained in August 2011. There are currently no CO nonattainment areas; as of September 27, 2010, all CO nonattainment areas have been redesignated to attainment.

The past designations were based on the existing community-wide monitoring network. EPA is making changes to the ambient air monitoring requirements for CO. The new requirements are expected to result in approximately 52 CO monitors operating near roads within 52 urban areas by January 2015 (76 FR 54294, August 31, 2011).

(f) Diesel Exhaust PM

Because DPM is part of overall ambient PM and cannot be easily distinguished from overall PM, we do not have direct measurements of DPM in the ambient air. DPM concentrations are estimated using ambient air quality modeling based on DPM emission inventories. DPM emission inventories are computed as the exhaust PM emissions from mobile sources combusting diesel or residual oil fuel. DPM concentrations were recently estimated as part of the 2011 NATA.<sup>779</sup> Areas with high concentrations are clustered in the Northeast, Great Lake States, California, and the Gulf Coast States and are also distributed throughout the rest of the U.S. The median DPM concentration calculated nationwide is 0.76 µg/m<sup>3</sup>. Half of the DPM can be attributed to heavy-duty diesel vehicles.

(g) Air Toxics

The most recent available data indicate that the majority of Americans continue to be exposed to ambient concentrations of air toxics at levels which have the potential to cause adverse health effects. The levels of air toxics to which people are exposed vary depending on where people live and work and the kinds of activities in which they engage, as discussed in detail in EPA's most recent Mobile

Source Air Toxics Rule.<sup>780</sup> According to the National Air Toxic Assessment (NATA) for 2011, mobile sources were responsible for 50 percent of outdoor anthropogenic toxic emissions and were the largest contributor to cancer and noncancer risk from directly emitted pollutants.<sup>781 782</sup> Mobile sources are also large contributors to precursor emissions which react to form air toxics. Formaldehyde is the largest contributor to cancer risk of all 71 pollutants quantitatively assessed in the 2011 NATA. Mobile sources were responsible for more than 25 percent of primary anthropogenic emissions of this pollutant in 2011 and are major contributors to formaldehyde precursor emissions. Benzene is also a large contributor to cancer risk, and mobile sources account for almost 80 percent of ambient exposure. Over the years, EPA has implemented a number of mobile source and fuel controls which have resulted in VOC reductions, which also reduced formaldehyde, benzene and other air toxic emissions.

(2) Impacts of the Rule on Projected Air Quality

Along with reducing GHGs, the Phase 2 standards also have an impact on non-GHG, criteria and air toxic pollutant, emissions. As shown above in Section VIII.C, the standards will impact exhaust emissions of these pollutants from vehicles and will also impact emissions that occur during the refining and distribution of fuel (upstream sources). Reductions in emissions of NO<sub>x</sub>, VOC, PM<sub>2.5</sub> and air toxics expected as a result of the Phase 2 standards will lead to improvements in air quality, specifically decreases in ambient concentrations of PM<sub>2.5</sub>, ozone, NO<sub>2</sub> and air toxics, as well as better visibility and reduced deposition.

Emissions and air quality modeling decisions are made early in the analytical process because of the time and resources associated with full-scale photochemical air quality modeling. As a result, the inventories used in the air quality modeling and the benefits modeling are different from the final emissions inventories presented in

<sup>780</sup> U.S. Environmental Protection Agency (2007). Control of Hazardous Air Pollutants from Mobile Sources; Final Rule. 72 FR 8434, February 26, 2007.

<sup>781</sup> U.S. EPA. (2015) 2011 NATA: Assessment Results. <https://www3.epa.gov/national-air-toxics-assessment/2011-nata-assessment-results>.

<sup>782</sup> NATA also includes estimates of risk attributable to background concentrations, which includes contributions from long-range transport, persistent air toxics, and natural sources; as well as secondary concentrations, where toxics are formed via secondary formation. Mobile sources substantially contribute to long-range transport and secondarily formed air toxics.

Section VIII.C. The air quality inventories and the final inventories are consistent in many ways, but there are some important differences. For example, in this final rulemaking, EPA is adopting Phase 1 and Phase 2 requirements to control PM<sub>2.5</sub> emissions from APUs installed in new tractors, so we do not expect increases in downstream PM<sub>2.5</sub> emissions from the Phase 2 program; however, the air quality inventories do not reflect these requirements and therefore show increases in downstream PM<sub>2.5</sub> emissions. Chapter 5 of the RIA has more detail on the differences between the air quality and final inventories. The results of our air quality modeling of the criteria pollutant and air toxics impacts of the Phase 2 standards are summarized in the RIA and presented in more detail in Appendix 6A to the RIA.

**IX. Economic and Other Impacts**

This section presents the costs, benefits and other economic impacts of the Phase 2 standards. It is important to note that NHTSA's fuel consumption standards and EPA's GHG standards will both be in effect, and each will lead to average fuel efficiency increases and GHG emission reductions.

The net benefits of the Phase 2 standards consist of the effects of the program on:

- vehicle program costs (costs of complying with the vehicle CO<sub>2</sub> and fuel consumption standards)
- changes in fuel expenditures associated with reduced fuel use resulting from more efficient vehicles and increased fuel use associated with the "rebound" effect, both of which result from the program
- economic value of reductions in GHGs
- economic value of reductions in non-GHG pollutants
- costs associated with increases in noise, congestion, and crashes resulting from increased vehicle use
- savings in drivers' time from less frequent refueling
- benefits of increased vehicle use associated with the "rebound" effect
- economic value of improvements in U.S. energy security

The benefits and costs of these rules are analyzed using 3 percent and 7 percent discount rates, consistent with current OMB guidance.<sup>783</sup> These rates

<sup>783</sup> The range of Social Cost of Carbon (SC-CO<sub>2</sub>) values uses several discount rates because the literature shows that the SC-CO<sub>2</sub> is quite sensitive to assumptions about the discount rate, and because no consensus exists on the appropriate rate to use in an intergenerational context (where costs and benefits are incurred by different generations). Refer to Section IX.F.1 for more information.

<sup>779</sup> U.S. EPA (2015) 2011 National-Scale Air Toxics Assessment. <https://www3.epa.gov/national-air-toxics-assessment/2011-nata-assessment-results#emissions>.



are intended to represent consumers' preference for current over future consumption (3 percent), and the real rate of return on private investment (7 percent) which indicates the opportunity cost of capital. However, neither of these rates necessarily represents the discount rate that individual decision-makers use.

The program may also have other economic effects that are not included here. As discussed in Sections III through VI of this Preamble and in Chapter 2 of the RIA, the technology cost estimates developed here take into account the costs to hold other vehicle attributes, such as size and performance, constant. With these assumptions, and because welfare losses represent monetary estimates of how much buyers would have to be compensated to be made as well off as they would have been in the absence of this regulation,<sup>784</sup> price increases for new vehicles measure the welfare losses to the vehicle buyers.<sup>785</sup> If the full technology cost gets passed along to the buyer as an increase in price, the technology cost thus measures the primary welfare loss of the standards, including impacts on buyers. Increasing fuel efficiency would have to lead to other changes in the vehicles that buyers find undesirable for there to be additional welfare losses that are not included in the technology costs.

As the 2012–2016 and 2017–2025 light-duty GHG/CAFE rules discussed, if other vehicle attributes are not held constant, then the technology cost estimates do not capture the losses to vehicle buyers associated with these changes.<sup>786</sup> The light-duty rules also

discussed other potential issues that could affect the calculation of the welfare impacts of these types of changes, such as aspects of buyers' behavior that might affect the demand for technology investments, uncertainty in buyers' investment horizons, and the rate at which truck owner's trade off higher vehicle purchase price against future fuel savings.

Where possible, we identify the uncertain aspects of these economic impacts and attempt to quantify them (e.g., sensitivity ranges associated with quantified and monetized GHG impacts; range of dollar-per-ton values to monetize non-GHG health benefits; uncertainty with respect to learning and markups). The agencies have examined the sensitivity of oil prices on fuel expenditures; results of this sensitivity analysis can be found in Chapter 8 of the RIA. NHTSA's EIS also characterizes the uncertainty in economic impacts associated with the HD national program. For other impacts, however, there is inadequate information to inform a thorough, quantitative assessment of uncertainty. EPA and NHTSA continue to work toward developing a comprehensive strategy for characterizing the aggregate impact of uncertainty in key elements of its analyses and we will continue to work to refine these uncertainty analyses in the future as time and resources permit.

This and other sections of the Preamble address Section 317 of the Clean Air Act on economic analysis. Section IX.L addresses Section 321 of the Clean Air Act on employment analysis. The total monetized benefits and costs of the program are summarized in Section IX.K for the final program and in Section X for all alternatives.

The agencies sought comment on numerous aspects of the analyses presented in this section, such as the potential omissions of costs or benefits, additional impacts of the standards on vehicle attributes and performance, and the quantification of uncertainty. Responses to comments on specific aspects of the analysis are addressed as appropriate in the relevant sections below, and in Sections III through VI of this Preamble as they relate to certain technologies. Further detail can be found in Section 11 of the RTC.

#### A. Conceptual Framework

The HD Phase 2 standards will implement both the 2007 Energy

Independence and Security Act requirement that NHTSA establish fuel efficiency standards for medium- and heavy-duty vehicles and the Clean Air Act requirement that EPA adopt technology-based standards to control pollutant emissions from motor vehicles and engines contributing to air pollution that endangers public health and welfare. NHTSA's statutory mandate is intended to further the agency's long-standing goals of reducing U.S. consumption and imports of petroleum energy to improve the nation's energy security.

From an economics perspective, government actions to improve our nation's energy security and to protect our nation from the potential threats of climate change address "externalities," or economic consequences of decisions by individuals and businesses that extend beyond those who make these decisions. For example, users of transportation fuels increase the entire U.S. economy's risk of having to make costly adjustments due to rapid increases in oil prices, but these users generally do not consider such costs when they decide to consume more fuel.

Similarly, consuming transportation fuel also increases emissions of greenhouse gases and other more localized air pollutants that occur when fuel is refined, distributed, and consumed. Some of these emissions increase the likelihood and severity of potential climate-related economic damages, and others cause economic damages by adversely affecting human health. The need to address these external costs and other adverse effects provides a well-established economic rationale that supports the statutory direction given to government agencies to establish regulatory programs that reduce the magnitude of these adverse effects at reasonable costs.

The Phase 2 standards will require manufacturers of new heavy-duty vehicles, including trailers (HDVs), to improve the fuel efficiency of the products that they produce. As HDV users purchase and operate these new vehicles, they will consume significantly less fuel, in turn reducing U.S. petroleum consumption and imports as well as emissions of GHGs and other air pollutants. Thus, as a consequence of the agencies' efforts to meet our statutory obligations to improve U.S. energy security and EPA's obligation to issue standards "to regulate emissions of the deleterious pollutant . . . from motor vehicles" that endangers public health and welfare,<sup>787</sup>

<sup>784</sup> This approach describes the economic concept of compensating variation, a payment of money after a change that would make a consumer as well off after the change as before it. A related concept, equivalent variation, estimates the income change that would be an alternative to the change taking place. The difference between them is whether the consumer's point of reference is her welfare before the change (compensating variation) or after the change (equivalent variation). In practice, these two measures are typically very close together.

<sup>785</sup> Indeed, it is likely to be an overestimate of the loss to the consumer, because the buyer has choices other than buying the same vehicle with a higher price; she could choose a different vehicle, or decide not to buy a new vehicle. The buyer would choose one of those options only if the alternative involves less loss than paying the higher price. Thus, the increase in price that the buyer faces would be the upper bound of loss of consumer welfare, unless there are other changes to the vehicle due to the fuel efficiency improvements that make the vehicle less desirable to consumers.

<sup>786</sup> Environmental Protection Agency and Department of Transportation, "Light-Duty Vehicle Greenhouse Gas Emission Standards and Corporate Average Fuel Economy Standards; Final Rule," 75 FR 25324, May 7, 2010, especially Sections III.H.1 (25510–25513) and IV.G.6 (25651–25657); Environmental Protection Agency and Department of Transportation, "2017 and Later Model Year Light-Duty Vehicle Greenhouse Gas Emissions and

Corporate Average Fuel Economy Standards; Final Rule," 77 FR 62624, October 15, 2012, especially Sections III.H.1 (62913–62919) and IV.G.5.a (63102–63104).

<sup>787</sup> *State of Massachusetts v. EPA*, 549 U.S. at 533.

the fuel efficiency and GHG emission standards will also reduce HDV operators' outlays for fuel purchases. These fuel savings are one measure of the final rule's effectiveness in promoting NHTSA's statutory goal of conserving energy, as well as EPA's obligation under section 202(a)(1) and (2) of the Clean Air Act to assess the cost of standards. Although these savings are not the agencies' primary motivation for adopting higher fuel efficiency standards, these substantial fuel savings represent significant additional economic benefits of these rules.

Potential savings in fuel costs appear to offer HDV buyer's strong incentives to pay higher prices for vehicles that feature technology or equipment that reduces fuel consumption. These potential savings also appear to offer HDV manufacturers similarly strong incentives to produce more fuel-efficient vehicles. Economic theory suggests that interactions between vehicle buyers and sellers in a normally-functioning competitive market would lead HDV manufacturers to incorporate all technologies that contribute to lower net costs into the vehicles they offer, and buyers to purchase them willingly. Nevertheless, many readily available technologies that appear to offer cost-effective increases in HDV fuel efficiency (when evaluated over their expected lifetimes using conventional discount rates) have not been widely adopted, despite their potential to repay buyers' initial investments rapidly.

This economic situation is commonly known as the "energy efficiency gap" or "energy paradox." This situation is perhaps more challenging to understand with respect to the heavy-duty sector versus the light-duty vehicle sector. Unlike light-duty vehicles—which are purchased and used mainly by individuals and households—the vast majority of HDVs are purchased and operated by profit-seeking businesses for which fuel costs represent a substantial operating expense. We asked for comments on our hypotheses about causes of the gap, as well as data or other information that can inform our understanding of why this situation seems to persist. The California Air Resources Board, CALSTART, Consumer Federation of America, Institute for Policy Integrity at NYU School of Law, and International Council on Clean Transportation supported, either in whole or in part, the agencies' arguments for potential barriers to market adoption. Caterpillar Inc. et al., Competitive Enterprise Institute (CEI), Randall Lutter, Brian Mannix, NAFA Fleet Management Association (NAFA), Owner-Operator

Independent Drivers Association (OIDA), Truck Renting and Leasing Association (TRALA), and Utility Trailer Manufacturing Company express skepticism or raise concerns about the agencies' discussion. The skeptical comments, discussed in more depth in context below, generally find it implausible that regulations can save money for profit-seeking businesses. If the savings were real, they argue, then private markets would have adopted these technologies without regulations; the agencies must therefore have exaggerated the benefits or underestimated the costs of the standards. Problems exist not in private market operations, they claim, but rather in the economic analysis of those operations.

The economic analysis of these standards is based on the engineering analysis of the costs and effectiveness of the technologies. The agencies have detailed their findings on costs and effectiveness in Preamble Sections III, IV, V, and VI, and RIA Chapter 2. If these cost and effectiveness estimates are correct, and if the agencies have not omitted key costs or benefits, then the efficiency gap exists, even if it seems implausible to some. As will be discussed further below, comments that raise issues with that technical analysis, such as concerns about maintenance and reliability costs of the technologies, present possible reasons that the gap is not as large as the agencies have found, and are discussed in the cost and effectiveness sections mentioned above. Comments that question the explanations provided for the gap without addressing the cost and effectiveness analyses do not provide evidence of an absence of the gap. Explaining why the gap exists is a separate and difficult challenge from observing the existence of the gap, because of the difficulties involved in developing tests of the different possible explanations. As discussed below, there is very little empirical evidence on behaviors that might lead to the gap, even while there continues to be substantial evidence, via the cost and effectiveness analysis, of the gap's existence. On the basis of that evidence, the agencies believe that a significant number of fuel efficiency improving technologies would remain far less widely adopted in the absence of these standards.

Economic research offers several possible explanations for why the prospect of these apparent savings might not lead HDV manufacturers and buyers to adopt technologies that would be expected to reduce HDV operating costs. Some of these explanations

involve failures of the HDV market for reasons other than the externalities caused by producing and consuming fuel. Examples include situations where information about the performance of fuel economy technologies is incomplete, costly to obtain, or available only to one party to a transaction (or "asymmetrical"), as well as behavioral rigidities in either the HDV manufacturing or HDV-operating industries, such as standardized or inflexibly administered operating procedures, or requirements of other regulations on HDVs. Examples that do not involve market failures include possible effects on the performance, reliability, carrying capacity, maintenance requirements of new technology under the demands of everyday use, or transaction or adjustment costs. We note again that these and other hypotheses are presented as potential explanations of the finding of an efficiency gap based on an engineering analysis. They are not themselves the basis for regulation.

In the HD Phase 1 rulemaking (which, in contrast to these standards, did not apply to trailers), and in the Phase 2 NPRM, the agencies raised various hypotheses that might explain this energy efficiency gap or paradox.

- Imperfect information in the new vehicle market: Information available to prospective buyers about the effectiveness of some fuel-saving technologies for new vehicles may be inadequate or unreliable. If reliable information on their effectiveness in reducing fuel consumption is unavailable or difficult to obtain, HDV buyers will understandably be reluctant to pay higher prices to purchase vehicles equipped with unproven technologies.

Some commenters argue that this explanation implies implausibly that the agencies have information that those with profit motives do not, and that EPA's SmartWay Program has already served the function of sharing public information with the private sector. Other commenters agree with the agencies that imperfect information is a potential market barrier.

As discussed in the NPRM, one common theme from recent research<sup>788</sup>

<sup>788</sup> Klemick, Heather, Elizabeth Kopits, Keith Sargent, and Ann Wolverton (2015). "Heavy-Duty Trucking and the Energy Efficiency Paradox: Evidence from Focus Groups and Interviews." *Transportation Research Part A* 77: 154–166, Docket EPA–HQ–OAR–2014–0827; Roeth, Mike, Dave Kircher, Joel Smith, and Rob Swim (2013). "Barriers to the Increased Adoption of Fuel Efficiency Technologies in the North American On-Road Freight Sector." NACFE report for the International Council on Clean Transportation,

is the inability of HDV buyers to obtain reliable information about the fuel savings, reliability, and maintenance costs of technologies that improve fuel efficiency. See 80 FR 40436. In the trucking industry, the performance of fuel-saving technology is likely to depend on many firm-specific attributes, including the intensity of HDV use, the typical distance and routing of HDV trips, driver characteristics, road conditions, regional geography and traffic patterns. As a result, businesses that operate HDVs have strong preferences for testing fuel-saving technologies “in-house” because they are concerned that their patterns of vehicle use may lead to different results from those reported in published information. Businesses with less capability to do in-house testing often seek information from peers, yet often remain skeptical of its applicability due to differences in the nature of their operations.

- Imperfect information in the resale market: Buyers in the used vehicle market may not be willing to pay adequate premiums for more fuel efficient vehicles when they are offered for resale to ensure that buyers of new vehicles can recover the remaining value of their original investment in higher fuel efficiency. The prospect of an inadequate return on their original owners’ investments in higher fuel efficiency may contribute to the short payback periods that buyers of new vehicles appear to demand.<sup>789</sup>

CEI rejects this hypothesis, asserting that buyers in this market do consider the value of technologies on used vehicles; other commenters support this possibility.

The recent research cited above (Klemick et al. 2015, Roeth et al. 2013, Aarnink et al. 2012) found mixed evidence for imperfect information in the market for used HDVs. On the one hand, some studies noted that fuel-saving technology is often not appreciated in the used vehicle market,

because of imperfect information about its benefits, or greater mistrust of its performance among buyers in the used vehicle market than among buyers of new vehicles. When buyers of new vehicles considered features that would affect value in the secondary market, those features were rarely related to fuel economy. In addition, some used-vehicle buyers might have a larger “knowledge gap” than new-vehicle buyers. In other cases, the lack of interest might be due to the intended use of the used HDVs, which may not reward the presence of certain fuel-saving technologies. In other cases, however, fuel-saving technology can lead to a premium in the used market, as for instance to meet the more stringent requirements for HDVs operating in California.

- Principal-agent problems causing split incentives: An HDV buyer may not be directly responsible for its future fuel costs, or the individual who will be responsible for fuel costs may not participate in the HDV purchase decision. In these cases, the signal to invest in higher fuel efficiency normally provided by savings in fuel costs may not be transmitted effectively to HDV buyers, and the incentives of HDV buyers and fuel buyers will diverge, or be “split.” The trailers towed by heavy-duty tractors, which are typically not supplied by the tractor manufacturer or seller, present an obvious potential situation of split incentives that was not addressed in the HD Phase 1 rulemaking, but which may apply in this rulemaking. If there is inadequate pass-through of price signals from trailer users to their buyers, then low adoption of fuel-saving technologies may result.

CEI argues that, even if these split incentives existed, vehicle purchasers still might not invest in fuel-saving technologies due to capital constraints. As discussed below, capital constraints may be an issue for smaller companies, but they do not appear to be a significant concern for larger companies. Mr. Lutter provides a working paper<sup>790</sup> in which the authors do not find a statistically significant or negative relationship when the box trailer has different ownership than the tractor, a result that does not support evidence of the split-incentives problem between tractors and trailers. As the papers below discuss, the split-incentives problem can take more forms than the difference in ownership

between tractors and box trailers examined in this comment.

Other recent research identifies split incentives, or principal-agent problems, as a potential barrier to technology adoption. For instance, Vernon and Meier (2012) estimate that 23 percent of trailers may be exposed to split incentives due to businesses that own and lease trailers to HDV operators not having an incentive to invest in trailer-specific fuel-saving technology.<sup>791</sup> They also estimate that 5 percent of HDV fuel use is subject to split incentives that arise when the firm paying fuel costs does not make the tractor investment decision (e.g., because a carrier subcontracts to an owner-operator but still pays for fuel). As CEI points out, in the case of a split incentive when the driver is not responsible for paying fuel costs, the owner is the principal who seeks fuel savings, and the driver is the agent with potentially low incentive to provide those savings; there are a number of potential sources of inefficiency in fuel use, though not all of them are expected to result in underinvestment in fuel-saving technologies. Vernon and Meier (2012) do not quantify the financial significance of these problems.

Klemick et al. (2015), Aarnink et al. (2012), and Roeth et al. (2013) provide mixed evidence on the severity of the split-incentive problem. Focus groups often identify diverging incentives between drivers and the decision-makers responsible for purchasing vehicles. Aarnink et al. (2012) and Roeth et al. (2013) cite examples of split incentives involving trailers and fuel surcharges, although the latter also cites other examples where these same issues do not lead to split incentives. In an effort to minimize problems that can arise from split incentives, many businesses that operate HDVs also train drivers in the use of specific technologies or to modify their driving behavior in order to improve fuel efficiency, while some also offer financial incentives to their drivers to conserve fuel. All of these options can help to reduce the split incentive problem.

- Uncertainty about future fuel cost savings: HDV buyers may be uncertain about future fuel prices, or about maintenance costs and reliability of some fuel efficiency technologies. In contrast, the costs of fuel-saving technologies are immediate. If buyers

Docket EPA-HQ-OAR-2014-0827-0084; Aarnink, Sanne, Jasper Faber, and Eelco den Boer (2012). “Market Barriers to Increased Efficiency in the European On-road Freight Sector.” CE Delft report for the International Council on Clean Transportation, Docket EPA-HQ-OAR-2014-0827-0076.

<sup>789</sup> Committee to Assess Fuel Economy Technologies for Medium- and Heavy-Duty Vehicles; National Research Council; Transportation Research Board (2010). “Technologies and Approaches to Reducing the Fuel Consumption of Medium- and Heavy-Duty Vehicles,” (hereafter, “NAS 2010”). Washington, DC The National Academies Press. Available electronically from the National Academies Press Web site at [http://www.nap.edu/catalog.php?record\\_id=12845](http://www.nap.edu/catalog.php?record_id=12845) (accessed September 10, 2010), Docket EPA-HQ-OAR-2014-0827-0122.

<sup>790</sup> Fraas, Art, Randall Lutter, Zachary Porter, and Alexander Wallace (2016). “The Energy Paradox and the Adoption of Energy-Saving Technologies in the Trucking Industry.” Working Paper, Mercatus Center, George Mason University, Docket EPA-HQ-OAR-2014-0827-1879.

<sup>791</sup> Vernon, David and Alan Meier (2012). “Identification and quantification of principal-agent problems affecting energy efficiency investments and use decisions in the trucking industry.” Energy Policy, 49(C), pp. 266-273, Docket EPA-HQ-OAR-2014-0827-0090.

are loss-averse, they may react to this uncertainty by underinvesting in technologies to improve fuel economy. In this situation, potential variability about buyers' expected returns on capital investments to achieve higher fuel efficiency may shorten the payback period—the time required to repay those investments—they demand in order to make them.

Various commenters support this hypothesis. The CEI draws on the experience of nitrogen oxides (NO<sub>x</sub>) regulations from 2004 and 2007 to support its arguments. As discussed more below, the NO<sub>x</sub> standards are unlikely to provide much, if any, precedential value for the GHG/fuel economy standards. Other commenters raise questions related to uncertainty about future costs for fuel and maintenance, as well as about the reliability of new technology that could result in costly downtime. Section IX.D. below discusses maintenance expenditures under these standards. These examples illustrate the problem of uncertain or unreliable information about the actual performance of fuel efficiency technology discussed above. Roeth et al. (2013) and Klemick et al. (2015) both document the short payback periods that HDV buyers require on their investments—usually about 2 years—which may be partly attributable to these uncertainties.

- Adjustment and transactions costs: Potential resistance to new technologies—stemming, for example, from drivers' reluctance or slowness to adjust to changes in the way vehicles operate—may slow or inhibit new technology adoption. If a conservative approach to new technologies leads HDV buyers to adopt them slowly, then successful new technologies will be adopted over time without market intervention, but only with potentially significant delays in achieving the fuel saving, environmental, and energy security benefits they offer. There also may be costs associated with training drivers to realize potential fuel savings enabled by new technologies, or with accelerating fleet operators' scheduled fleet turnover and replacement to hasten their acquisition of vehicles equipped with these technologies. These factors might present real resource costs to firms that are not reflected in a typical engineering analysis.

CEI argues that these costs are normal aspects of the innovation process, and competition continually drives firms to innovate in most industries. As discussed below, innovation is not always a continual and smooth response to competition as CEI suggests.

Klemick et al. (2015), Roeth et al. (2013), and Aarnink et al. (2012) provide some support for the view that adjustment and transactions costs may impede HDV buyers from investing in higher fuel efficiency. These studies note that HDV buyers are less likely to select new technology when it is not available from their preferred manufacturers. Some technologies are only available as after-market additions, which can add other costs to adopting them.

- Driver acceptance of new equipment or technologies as a barrier to their adoption. HDV driver turnover is high in the U.S., and businesses that operate HDVs are concerned about retaining their best drivers. Therefore, they may avoid technologies that require significant new training or adjustments in driver behavior.

NAFA Fleet Management Association states that the standards will increase pressure on already strained driver and technician resources. The agencies understand that the industry experiences a great deal of driver turnover; we do not know how the standards will affect that turnover. Changes to vehicles that require some changes in driver behavior may increase driver turnover. For instance, drivers who prefer manual transmissions may respond poorly to vehicles with automatic transmissions. On the other hand, the switch to automatic transmissions may facilitate entry of new drivers who no longer need to learn as much about shifting.

For some technologies that can be used to meet these standards, such as automatic tire inflation systems, training costs are likely to be minimal. Other technologies, such as stop-start systems, may require drivers to adjust their expectations about vehicle operation, and it is difficult for the agencies to anticipate how drivers will respond to such changes.<sup>792</sup>

- Constraints on access to capital for investment. If buyers of new vehicles have limited funds available, then they must choose between investing in fuel-saving technology and other vehicle technologies or attributes.

CEI states that investments require tradeoffs: Investment in fuel economy crowds out other investments. There would be tradeoffs in purchasing choices if capital markets are constrained, and fuel-saving

technologies do not provide returns sufficient to achieve the hurdle rates that the buyers require. Klemick et al. (2015) did not find capital constraints to be a problem for the medium- and large-sized businesses participating in their study. On the other hand, Roeth et al. (2013) noted that access to capital can be a significant challenge to smaller or independent businesses, and that price is always a concern to buyers. Section XIV.D. discusses the agencies' outreach to small businesses to learn about their special circumstances. These are reflected in various flexibilities for small businesses in the regulations.

- “Network externalities,” where the benefits to new users of a technology depend on how many others have already adopted it. If the value of a technology increases with increasing adoption, then it can be difficult for the adoption process to begin: Each potential adopter has an incentive to wait for others to adopt before making the investment. If all adopters wait for others, then adoption may not happen.

One example where network externalities seem likely to arise is the market for natural gas-fueled HDVs: The limited availability of refueling stations may reduce potential buyers' willingness to purchase natural gas-fueled HDVs, while the small number of such HDVs in use does not provide sufficient economic incentive to construct more natural gas refueling stations. Some businesses that operate HDVs may also be concerned about the difficulty in locating repair facilities or replacement parts, such as single-wide tires, wherever their vehicles operate. When a technology has been widely adopted, then it is likely to be serviceable even in remote or rural places, but until it becomes widely available, its early adopters may face difficulties with repairs or replacements. By accelerating the widespread adoption of these technologies, these standards may assist in overcoming these difficulties.

Consumer Federation of America states that network externalities are a potentially important barrier to adoption of fuel-saving technologies.

- First-mover disadvantage. Many manufacturers prefer to observe the market and follow other manufacturers rather than be the first to market with a specific technology. The “first-mover disadvantage” has been recognized in other research where the “first-mover” pays a higher proportion of the costs of developing technology, but loses the long-term advantage when other

<sup>792</sup> The distinction between simply requiring drivers (or mechanics) to adjust their expectations and compromises in vehicle performance or utility is subtle. While the former may not impose significant compliance costs in the long run, the latter would represent additional economic costs of complying with the standard.

businesses follow quickly.<sup>793</sup> In this way, there may be barriers to innovation on the supply side that result in lower adoption rates of fuel-efficiency technology than would be optimal.

Several commenters support the existence of the first-mover disadvantage. Roeth et al. (2013) noted that HDV buyers often prefer to have technology or equipment installed by their favored original equipment manufacturers. However, some technologies may not be available through these preferred sources, or may be available only as after-market installations from third parties (Aarnink et al. 2012, Roeth et al. 2013). Manufacturers may be hesitant to offer technologies for which there is not strong demand, especially if the technologies require significant research and development expenses and other costs of bringing the technology to a market of uncertain demand. Roeth et al. (2013) noted that it can take years, and sometimes as much as a decade, for a specific technology to become available from all manufacturers.

As mentioned above, the Competitive Enterprise Institute argues that EPA regulations on nitrogen oxides (NO<sub>x</sub>) and other pollutants from heavy duty engines in the 2000s hindered development of fuel-saving technologies, in part because the technologies increased fuel consumption, and in part because, if manufacturers invested in NO<sub>x</sub> controls, they could not invest in reducing fuel consumption. The agencies do not find these potential explanations compelling. Most obviously, the NO<sub>x</sub> and other standards do not provide a useful analogy for industry response to the GHG/fuel efficiency standards, because those standards imposed costs without returning fuel savings to operators. In addition, as the discussion of technology cost and effectiveness indicates, technologies that are not in widespread use seem to be available to reduce fuel consumption with reasonable payback periods. Finally, the agencies consider it possible to reduce NO<sub>x</sub> in the presence of GHG controls, and to reduce GHG emissions in the presence of NO<sub>x</sub> controls; the cost analysis for this rulemaking accounts for

achieving NO<sub>x</sub> emissions standards. See also RTC Sections 11.2.2.3 and 11.7.2.

In summary, the agencies recognize that businesses that operate HDVs are under competitive pressure to reduce operating costs, which should compel HDV buyers to identify and rapidly adopt cost-effective fuel-saving technologies. Outlays for labor and fuel generally constitute the two largest shares of HDV operating costs, depending on the price of fuel, distance traveled, type of HDV, and commodity transported (if any), so businesses that operate HDVs face strong incentives to reduce these costs.<sup>794 795</sup>

However, the relatively short payback periods that buyers of new HDVs appear to require suggest that some combination of the factors cited above impedes this process. Markets for both new and used HDVs may face these problems, although it is difficult to assess empirically the degree to which they actually do. Even if the benefits from widespread adoption of fuel-saving technologies exceed their costs, their use may remain limited or spread slowly because their early adopters bear a disproportionate share of those costs. In this case, as CFA says in its comments, these standards may help to overcome such barriers by ensuring that these measures will be widely adopted.

Providing information about fuel-saving technologies, offering incentives for their adoption, and sharing HDV operators' real-world experiences with their performance through voluntary programs such as EPA's SmartWay Transport Partnership should assist in the adoption of new cost-saving technologies. Nevertheless, other barriers that impede the diffusion of new technologies are likely to remain. Buyers who are willing to experiment with new technologies expect to find cost savings, but those savings may be difficult to verify or replicate. As noted previously, because benefits from employing these technologies are likely to vary with the characteristics of individual routes and traffic patterns, buyers of new HDVs may find it difficult to identify or verify the effects of fuel-saving technologies in their operations. Risk-averse buyers may also avoid new technologies out of concerns over the possibility of inadequate

returns on their investments, or with other possible adverse impacts.

As various commenters note, competitive pressures in the HDV freight transport industry can provide a strong incentive to reduce fuel consumption and improve environmental performance. Nevertheless, HDV manufacturers may delay in investing in the development and production of new technologies, instead waiting for other manufacturers to bear the initial risks of those investments. In addition, not every HDV operator has the requisite ability or interest to access and utilize the technical information, or the resources necessary to evaluate this information within the context of his or her own operations.

As discussed previously, whether the technologies available to improve HDVs' fuel efficiency would be adopted widely in the absence of the program is challenging to assess. To the extent that these technologies would be adopted in its absence, neither their costs nor their benefits should be attributed to the program.

The agencies will continue to explore reasons for the slow adoption of readily available and apparently cost-effective technologies for improving fuel efficiency.

#### *B. Vehicle-Related Costs Associated With the Program*

##### (1) Technology Cost Methodology

###### (a) Direct Manufacturing Costs

The direct manufacturing costs (DMCs) used throughout this analysis are derived from several sources. Many of the tractor, vocational and trailer DMCs can be sourced to the Phase 1 rule which, in turn, were sourced largely from a contracted study by ICF International for EPA.<sup>796</sup> We have updated those costs by converting them to 2013 dollars, as described in Section IX.B.1.e below, and by continuing the learning effects described in the Phase 1 rule and in Section IX.B.1.c below. The new tractor, vocational and trailer costs can be sourced to a more recent study conducted by Tetra Tech under contract to NHTSA.<sup>797</sup> The cost methodology used by Tetra Tech was to estimate retail costs and work backward from there to derive a DMC for each technology. The agencies did not agree with the approach used by Tetra Tech

<sup>793</sup> Blumstein, Carl and Margaret Taylor (2013). "Rethinking the Energy-Efficiency Gap: Producers, Intermediaries, and Innovation." Energy Institute at Haas Working Paper 243, University of California at Berkeley, Docket EPA-HQ-OAR-2014-0827-0075; Tirole, Jean (1998). *The Theory of Industrial Organization*. Cambridge, MA: MIT Press, pp.400, 402, Docket EPA-HQ-OAR-2014-0827-0089. This first-mover disadvantage must be large enough to overcome the potential incentive for first movers to earn unusually high but temporary profit levels.

<sup>794</sup> American Transportation Research Institute, *An Analysis of the Operational Costs of Trucking*, September 2013 (Docket ID: EPA-HQ-OAR-2014-0827-0512).

<sup>795</sup> Transport Canada, *Operating Cost of Trucks*, 2005. See <http://www.tc.gc.ca/eng/policy/report-acg-operatingcost2005-2005-e-2-1727.htm>, accessed on July 16, 2010 (Docket ID: EPA-HQ-OAR-2014-0827-0070).

<sup>796</sup> ICF International. *Investigation of Costs for Strategies to Reduce Greenhouse Gas Emissions for Heavy-Duty On-Road Vehicles*. July 2010.

<sup>797</sup> Schubert, R., Chan, M., Law, K. (2015). *Commercial Medium- and Heavy-Duty (MD/HD) Truck Fuel Efficiency Cost Study*. Washington, DC: National Highway Traffic Safety Administration.

to move from retail cost to DMC as the approach was to simply divide retail costs by 2 and use the result as a DMC. Our research, discussed below, suggests that a divisor of 2 is too high. Therefore, where we have used a Tetra Tech derived retail estimate, we have divided by our researched markups to arrive at many of the DMCs used in this analysis. In this way, the agencies have used an approach consistent with past GHG/CAFE/fuel consumption rules by dividing estimated retail prices by our estimated retail price equivalent (RPE) markups to derive an appropriate DMC for each technology. We describe our RPEs in Section IX.B.1.b, below. Importantly, nearly all of the technology costs used in the final analysis are identical to those used in the proposal, except for updating those costs from 2012 dollars to 2013 dollars. Notable changes are the costs for waste heat recovery and the use of new technologies (e.g., APU with DPF, battery powered APU and a different stop-start technology on vocational vehicles) that were not considered in the proposal. We describe these changes in Chapter 2.11 of the RIA.

Importantly, technology costs differ from package costs which include adoption rates. Package costs have changed more significantly due to changes to the adoption rates as described throughout the earlier sections of this Preamble and briefly below in Section IX.B.1.(d).

For HD pickups and vans, we have similarly used costs from the proposal except for the updating to 2013 dollars. As explained in the proposal, we relied primarily on the Phase 1 rule and the recent light-duty 2017–2025 model year rule since most technologies expected on these vehicles are, in effect, the same as those used on light-duty pickups. Many of those technology DMCs are based on cost teardown studies which the agencies consider to be the most robust method of cost estimation. However, because most of the HD versions of those technologies are expected to be more costly than their light-duty counterparts, we have scaled upward most of the light-duty DMCs for this analysis. We have also used some costs developed under contract to NHTSA by Tetra Tech.<sup>798</sup>

Importantly, in our methodology, all technologies are treated as being sourced from a supplier rather than being developed and produced in-house. As a result, some portion of the

total indirect costs of making a technology or system—those costs incurred by the supplier for research, development, transportation, marketing etc.—are contained in the sales price to the engine and/or vehicle/trailer manufacturer (i.e., the original equipment manufacturer (OEM)). That sale price paid by the OEM to the supplier is the DMC we estimate.

We present the details—sources, DMC values, scaling from light-duty values, markups, learning effects, adoption rates—behind all our costs in Chapter 2 of the RIA.

#### (b) Indirect Costs

To produce a unit of output, engine and truck manufacturers incur direct and indirect costs. Direct costs include cost of materials and labor costs. Indirect costs are all the costs associated with producing the unit of output that are not direct costs—for example, they may be related to production (such as research and development [R&D]), corporate operations (such as salaries, pensions, and health care costs for corporate staff), or selling (such as transportation, dealer support, and marketing). Indirect costs are generally recovered by allocating a share of the costs to each unit of good sold. Although it is possible to account for direct costs allocated to each unit of good sold, it is more challenging to account for indirect costs allocated to a unit of goods sold. To make a cost analysis process more feasible, markup factors, which relate total indirect costs to total direct costs, have been developed. These factors are often referred to as retail price equivalent (RPE) multipliers.

While the agencies have traditionally used RPE multipliers to estimate indirect costs, in recent GHG/CAFE/fuel consumption rules RPEs have been replaced in the primary analysis with indirect cost multipliers (ICMs). ICMs differ from RPEs in that they attempt to estimate not all indirect costs incurred to bring a product to point of sale, but only those indirect costs that change as a result of a government action or regulatory requirement. As such, some indirect costs, notably health and retirement benefits of retired employees, among other indirect costs, will not be expected to change due to a government action and, therefore, the portion of the RPE that covered those costs does not change.

Further, the ICM is not a “one-size-fits-all” markup as is the traditional RPE. With ICMs, higher complexity technologies like hybridization or moving from a manual to automatic transmission may require higher

indirect costs—more research and development, more integration work, etc.—suggesting a higher markup. Conversely, lower complexity technologies like reducing friction or adding passive aero features may require fewer indirect costs thereby suggesting a lower markup.

Notably, ICMs are also not a simple multiplier as are traditional RPEs. The ICM is broken into two parts—warranty related and non-warranty related costs. The warranty related portion of the ICM is relatively small while the non-warranty portion represents typically over 95 percent of indirect costs. These two portions are applied to different DMC values to arrive at total costs (TC). The warranty portion of the markup is applied to a DMC that decreases year-over-year due to learning effects (described below in Section IX.B.1.c).<sup>799</sup> As learning effects decrease the DMC with production volumes, it makes sense that warranty costs will decrease since those parts replaced under warranty should be less costly. In contrast, the non-warranty portion of the markup is applied to a static DMC year-over-year resulting in static indirect costs. This is logical since the production plants and transportation networks and general overhead required to build parts, market them, deliver them and integrate them into vehicles do not necessarily decrease in cost year-over-year. Because the warranty and non-warranty portions of the ICM are applied differently, one cannot compare the markup itself to the RPE to determine which markup will result in higher indirect cost estimates, at least in the time periods typically considered in our rules (four to ten years).

In the NPRM, the agencies expressed concern that some potential costs associated with this rulemaking may not be adequately captured by our ICMs. ICMs are estimated based on a few specific technologies and these technologies may not be representative of the changes actually made to meet the requirements. We requested and received comment on this issue. Specifically, some commenters argued that we had underestimated costs associated with R&D and costs associated with our compliance programs, both of which are indirect costs. However, we address those indirect costs separately because GHG-related R&D and GHG-related

<sup>799</sup> We note that the labor portion of warranty repairs does not decrease due to learning. However, we do not have data to separate this portion and so we apply learning to the entire warranty cost. Because warranty costs are a small portion of overall indirect costs, this has only a minor impact on the analysis.

<sup>798</sup> Schubert, R., Chan, M., Law, K. (2015). Commercial Medium- and Heavy-Duty (MD/HD) Truck Fuel Efficiency Cost Study. Washington, DC: National Highway Traffic Safety Administration.

compliance were not part of the retail price equivalent markups upon which our indirect cost multipliers are based. We discuss these R&D and compliance costs more below and in Chapter 7 of the RIA.

We provide more details on our ICM approach and the markups used for each technology in Chapter 2.12 of the RIA.

#### (c) Learning Effects on Direct and Indirect Costs

For some of the technologies considered in this analysis, manufacturer learning effects will be expected to play a role in the actual end costs. The “learning curve” or “experience curve” describes the reduction in unit production costs as a function of accumulated production volume. In theory, the cost behavior it describes applies to cumulative production volume measured at the level of an individual manufacturer, although it is often assumed—as both agencies have done in past regulatory analyses—to apply at the industry-wide level, particularly in industries that utilize many common technologies and component supply sources. Both agencies believe there are indeed many factors that cause costs to decrease over time. Research in the costs of manufacturing has consistently shown that, as manufacturers gain experience in production, they are able to apply innovations to simplify machining and assembly operations, use lower cost materials, and reduce the number or complexity of component parts. All of these factors allow manufacturers to lower the per-unit cost of production (*i.e.*, the manufacturing learning curve).<sup>800</sup>

In this analysis, the agencies are using the same approach to learning as done in the proposal and in past GHG/CAFE/fuel consumption rules. In short, learning effects result in rapid cost reductions in the early years following introduction of a new technology. The agencies have estimated those cost reductions as resulting in 20 percent lower costs for every doubling of production volume. As production volumes increase, learning rates continue at the same pace but flatten asymptotically due to the nature of the persistent doubling of production

required to realize that cost reduction. As such, the cost reductions flatten out as production volumes continue to increase. Consistent with the Phase 1 rule, we refer to these two distinct portions of the “learning cost reduction curve” or “learning curve” as the steeper and flatter portions of the curve. On that steep portion of the curve, costs are estimated to decrease by 20 percent for each double of production or, by proxy, in the third and then fifth year of production following introduction. On the flat portion of the curve, costs are estimated to decrease by 3 percent per year for 5 years, then 2 percent per year for 5 years, then 1 percent per year for 5 years. Also consistent with the Phase 1 rule, the majority of the technologies we expect will be adopted are considered to be on the flat portion of the learning curve meaning that the 20 percent cost reductions are rarely applied. The agencies requested and received comments on our approach to estimating learning effects, specifically with respect to cost reductions applied to waste heat recovery and APUs. Commenters suggested that, since waste heat recovery is not in production, the agencies should not have applied learning effect to that technology. They also argued that, since APUs have been around for years, applying any cost reduction effects to their costs is “questionable.” The agencies disagree with both of these comments. Whether production-related learning-by-doing cost reductions or from other factors, we are aware of dramatic changes to waste heat recovery systems that clearly make that technology less costly. We describe these changes in more detail in Chapter 2 of the RIA. Also, to suggest that APUs cannot undergo any cost reductions from learning does not seem reasonable. The agencies have placed that technology on the flat portion of the learning curve since it is well established. As a result, the estimated learning effects are not large in scale, but to suggest that an APU will cost the same in the 2020s as it does today, in constant dollar terms, is not reasonable. Further, the commenter provided no supporting data or information to support this claim.

We provide more details on the concept of learning-by-doing and the learning effects applied in this analysis in Chapter 2.11 of the RIA.

#### (d) Technology Adoption Rates and Developing Package Costs

Determining the stringency of these standards involves a balancing of relevant factors—chiefly technology feasibility and effectiveness, costs, and lead time. For vocational vehicles,

tractors and trailers, the agencies have projected a technology path to achieve these standards reflecting an application rate of those technologies the agencies consider to be available at reasonable cost in the lead times provided. The agencies do not expect (and do not require) each of the technologies for which costs have been developed to be employed by all trucks and trailers across the board.<sup>801</sup> Further, many of today’s vehicles are already equipped with some of the technologies and/or are expected to adopt them by MY 2018 to comply with the HD Phase 1 standards. Estimated adoption rates in both the reference and control cases are necessary for each vehicle/trailer category. The adoption rates for most technologies are zero in the reference case; however, for some technologies—notably aero and tire technologies—the adoption rate is not zero in the reference case. These reference and control case adoption rates are then applied to the technology costs with the result being a package cost for each vehicle/trailer category. Technology adoption rates were presented in Sections II through V for engines, tractors, vocational vehicles and trailers. Individual technology costs are presented in Chapter 2.11 of the final RIA.

For HD pickups and vans, the CAFE model determines the technology adoption rates that are estimated to most cost effectively meet the standards. Similar to vocational vehicles, tractors and trailers, package costs are rarely if ever a simple sum of all the technology costs since each technology will be expected to be adopted at different rates. The methods for estimating technology adoption rates and resultant costs per vehicle (and other impacts) for HD pickups and vans are discussed above in Section VI. Individual technology costs are presented in Chapter 2.11 of the final RIA.

We provide details of expected technology adoption rates for each of the regulatory subcategories in Chapter 2 of the RIA. We present package costs both in Sections III through VI of this Preamble and in more detail in Chapter 2 of the RIA.

#### (e) Conversion of Technology Costs to 2013 U.S. Dollars

As noted above in Section IX.B.1, the agencies are using technology costs from many different sources. These sources, having been published in different years, present costs in different year dollars (*i.e.*, 2009 dollars or 2010

<sup>800</sup> See “Learning Curves in Manufacturing,” L. Argote and D. Epple, *Science*, Volume 247; “Toward Cost Buy down Via Learning-by-Doing for Environmental Energy Technologies,” R. Williams, Princeton University, Workshop on Learning-by-Doing in Energy Technologies, June 2003; “Industry Learning Environmental and the Heterogeneity of Firm Performance,” N. Balasubramanian and M. Lieberman, UCLA Anderson School of Management, December 2006, Discussion Papers, Center for Economic Studies, Washington DC.

<sup>801</sup> The one exception are the design standards for non-aero box vans and non-box trailers, which do mandate use of certain tire-related technologies.



dollars). For this analysis, the agencies sought to have all costs in terms of 2013 dollars to be consistent with the dollars

used by AEO in its 2015 Annual Energy Outlook.<sup>802</sup> The agencies have used the GDP Implicit Price Deflator for Gross

Domestic Product as the converter, with the actual factors used as shown in Table IX-1.<sup>803</sup>

TABLE IX-1—IMPLICIT PRICE DEFLATORS AND CONVERSION FACTORS FOR CONVERSION TO 2013\$

	2006	2007	2008	2009	2010	2011	2012	2013
Price index for GDP .....	94.814	97.337	99.246	100	101.221	103.311	105.214	106.929
Factor applied for 2012\$ .....	1.128	1.099	1.077	1.069	1.056	1.035	1.016	1.000

(2) Compliance Program Costs

The agencies have also estimated additional and/or new compliance costs associated with these standards. Normally, compliance program costs will be considered part of the indirect costs and, therefore, will be accounted for via the markup applied to direct manufacturing costs. However, since the agencies are proposing new compliance elements that were not present during development of the indirect cost markups used in this analysis, additional compliance program costs are being accounted for via a separate “line-item.” New research and development costs (see below) are being handled in the same way.

The new compliance program elements included in this rule are new powertrain testing within the vocational vehicle program, and an all-new compliance program (since none has existed to date) for the trailer program. The remaining compliance provisions are identical to those in Phase 1, and the estimated costs therefore are derived using the same methodology used to estimate compliance costs in the Phase 1 rule. Compliance program costs cover costs associated with any necessary compliance testing and reporting to the agencies. The details behind the estimated compliance program costs are provided in Chapter 7 of the RIA.

The agencies requested and received comments on our compliance cost estimates. Some commenters were concerned that we had significantly underestimated costs. In response, we have adjusted our compliance costs

estimates, including those for testing and reporting, and have increased our annual compliance costs from roughly \$6 million per year to nearly \$11 million per year. This excludes the estimated \$16 million in 2020 to build and/or upgrade facilities to conduct testing. We discuss our updated estimates in more detail in Chapter 7 of the RIA.

(3) Research and Development Costs

Much like the compliance program costs described above, we have estimated additional HDD engine, vocational vehicle and tractor R&D associated with these standards that is not accounted for via the indirect cost markups used for these segments. Much like the Phase 1 rule, EPA is estimating these additional R&D costs will occur over a 4-year timeframe as these standards come into force and industry works on means to comply. After that period, the additional R&D costs go to \$0 as R&D expenditures return to their normal levels and R&D costs are accounted for via the ICMs—and the RPEs behind them—used for these segments. The details behind the estimated R&D costs are provided in Chapter 7 of the RIA

The agencies requested and received comments on our R&D estimates. One commenter suggested that our estimate of \$960 million over four years, for hundreds of types of disparate vehicles was unrealistic given the \$80 million of R&D spent on the Super Truck program over 5 years. Unfortunately, no better estimate was provided by commenters. We have increased our estimated R&D,

relative to that estimated in the proposal, by roughly \$14 million per year for 4 years resulting in a total additional R&D estimate of over \$1 billion. Importantly, as noted, this R&D spending is an additional expenditure above and beyond that estimated as part of the indirect cost markups which include in them an estimate of roughly 4 percent of revenues spent on R&D. Another way of stating this is that roughly 4 percent of our technology costs are actually estimated as R&D-related costs. Given our annual technology costs of \$2 billion to \$5 billion per year from 2021 through 2027, or over \$24 billion over those 7 years, we are estimating another \$1 billion in R&D via our indirect cost markups (4 percent of \$24 billion). In other words, we are really estimating roughly \$2 billion in R&D spending during the calendar years 2021 through 2027.

(4) Summary of Costs of the Vehicle Programs

The agencies have estimated the costs of the vehicle standards on an annual basis for the years 2018 through 2050, and have also estimated costs for the full model year lifetimes of MY 2018 through MY 2029 vehicles. Table IX-2 shows the annual costs of these standards along with net present values using both 3 percent and 7 percent discount rates. Table IX-3 shows the discounted model year lifetime costs of these standards at both 3 percent and 7 percent discount rates along with sums across applicable model years.

TABLE IX-2—ANNUAL COSTS OF THE FINAL PROGRAM AND NET PRESENT VALUES AT 3% AND 7% DISCOUNT RATES USING METHOD B AND RELATIVE TO THE FLAT BASELINE  
[Millions of 2013\$]<sup>a</sup>

Calendar year	New technology	Compliance	R&D	Sum
2018 .....	\$227	\$0	\$0	\$227
2019 .....	215	0	0	215
2020 .....	220	17	0	237
2021 .....	2,270	11	259	2,540

<sup>802</sup> U.S. Energy Information Administration, Annual Energy Outlook 2015, Early Release; Report Number DOE/EIA-0383(2015), April 2015.

<sup>803</sup> Bureau of Economic Analysis, Table 1.1.9 Implicit Price Deflators for Gross Domestic Product; as revised on August 27, 2015.



TABLE IX-2—ANNUAL COSTS OF THE FINAL PROGRAM AND NET PRESENT VALUES AT 3% AND 7% DISCOUNT RATES USING METHOD B AND RELATIVE TO THE FLAT BASELINE—Continued

[\$Millions of 2013\$]<sup>a</sup>

Calendar year	New technology	Compliance	R&D	Sum
2022	2,243	11	259	2,512
2023	2,485	11	259	2,755
2024	3,890	11	259	4,160
2025	4,146	11	0	4,157
2026	4,203	11	0	4,213
2027	5,219	11	0	5,230
2028	5,176	11	0	5,186
2029	5,195	11	0	5,206
2030	5,219	11	0	5,229
2035	5,642	11	0	5,653
2040	6,245	11	0	6,255
2050	7,270	11	0	7,280
NPV, 3%	86,780	191	818	87,788
NPV, 7%	41,148	102	604	41,854

**Note:**

<sup>a</sup>For an explanation of analytical Methods A and B, please see Section I.D; for an explanation of the flat baseline, 1a, and dynamic baseline, 1b, please see Section X.A.1.

TABLE IX-3—DISCOUNTED MY LIFETIME COSTS OF THE FINAL PROGRAM USING METHOD B AND RELATIVE TO THE FLAT BASELINE

[\$Millions of 2013\$]<sup>a</sup>

Model year	Discounted at 3%				Discounted at 7%			
	New technology	Compliance	R&D	Sum	New technology	Compliance	R&D	Sum
2018	\$205	\$0	\$0	\$205	\$179	\$0	\$0	\$179
2019	188	0	0	188	159	0	0	159
2020	187	14	0	201	152	12	0	163
2021	1,873	9	214	2,096	1,462	7	167	1,636
2022	1,797	8	207	2,013	1,350	6	156	1,513
2023	1,933	8	201	2,143	1,398	6	146	1,550
2024	2,938	8	195	3,141	2,046	6	136	2,187
2025	3,040	8	0	3,048	2,038	5	0	2,043
2026	2,992	8	0	2,999	1,930	5	0	1,935
2027	3,607	7	0	3,614	2,240	5	0	2,245
2028	3,473	7	0	3,480	2,076	4	0	2,080
2029	3,384	7	0	3,391	1,948	4	0	1,952
Sum	25,617	84	818	26,519	16,978	59	604	17,642

**Note:**

<sup>a</sup>For an explanation of analytical Methods A and B, please see Section I.D; for an explanation of the flat baseline, 1a, and dynamic baseline, 1b, please see Section X.A.1.

New technology costs begin in MY 2018 as trailers begin to add new technology. Compliance costs begin with the new standards with capital cost expenditure in that year for building and upgrading test facilities to conduct the powertrain testing in the vocational program. Research and development costs begin in 2021 and last for 4 years as engine, tractor and vocational vehicle manufacturers conduct research and development testing to integrate new technologies into their engines and vehicles.

*C. Changes in Fuel Consumption and Expenditures*

(1) Changes in Fuel Consumption

The new GHG and fuel consumption standards will result in significant improvements in the fuel efficiency of affected vehicles, and drivers of those vehicles will see corresponding savings associated with reduced fuel expenditures. The agencies have estimated the impacts on fuel consumption for these standards. Details behind how these changes in fuel consumption were calculated are presented in Section VII of this Preamble and in Chapter 5 of the RIA. The total number of miles that vehicles are driven each year is different under

the regulatory alternatives than in the reference case due to the “rebound effect” (discussed below in Section IX.E), so the changes in fuel consumption associated with each alternative are not strictly proportional to differences in the fuel economy levels they require.

The expected annual impacts on fuel consumption are shown in Table IX-4. Table IX-5 shows the MY lifetime changes in fuel consumption. The gallons shown in these tables as reductions in fuel consumption reflect reductions due to these standards and include any increased consumption resulting from the rebound effect (discussed below in Section IX.E).

TABLE IX-4—ANNUAL FUEL CONSUMPTION REDUCTIONS DUE TO THE FINAL PROGRAM USING METHOD B AND RELATIVE TO THE FLAT BASELINE

[Millions of gallons]<sup>a</sup>

Calendar year	Retail gasoline			Diesel		
	Reference case	Fuel consumption reduction	% Reduction	Reference case	Fuel consumption reduction	% Reduction
2018	10,958	0	0	46,636	37	0
2019	11,118	0	0	47,056	76	0
2020	11,265	0	0	47,397	117	0
2021	11,391	28	0	47,548	428	1
2022	11,515	74	1	47,813	812	2
2023	11,633	138	1	48,146	1,211	3
2024	11,745	226	2	48,572	1,835	4
2025	11,843	330	3	48,941	2,457	5
2026	11,936	448	4	49,194	3,063	6
2027	12,039	588	5	49,483	3,853	8
2028	12,138	723	6	49,753	4,610	9
2029	12,234	852	7	50,036	5,335	11
2030	12,324	974	8	50,393	6,031	12
2035	12,680	1,454	11	52,492	8,883	17
2040	12,920	1,724	13	55,399	10,778	19
2050	13,185	1,904	14	61,663	12,986	21

**Note:**

<sup>a</sup>For an explanation of analytical Methods A and B, please see Section I.D; for an explanation of the flat baseline, 1a, and dynamic baseline, 1b, please see Section X.A.1.

TABLE IX-5—MODEL YEAR LIFETIME FUEL CONSUMPTION REDUCTIONS DUE TO THE FINAL PROGRAM USING METHOD B AND RELATIVE TO THE FLAT BASELINE

[Millions of gallons]<sup>a</sup>

Model year	Retail gasoline			Diesel		
	Reference	Fuel consumption reduction	% Reduction	Reference	Fuel consumption reduction	% Reduction
2018	12,541	0	0	46,628	302	1
2019	12,409	0	0	47,583	293	1
2020	12,455	0	0	49,084	286	1
2021	12,328	322	3	48,950	4,643	9
2022	12,252	550	4	48,994	4,807	10
2023	12,233	772	6	48,884	4,947	10
2024	12,342	1,075	9	49,924	7,742	16
2025	12,452	1,301	10	50,364	7,954	16
2026	12,555	1,525	12	50,477	8,111	16
2027	12,591	1,836	15	50,664	10,646	21
2028	12,619	1,840	15	50,916	10,698	21
2029	12,631	1,841	15	51,381	10,800	21
Sum	149,408	11,062	7	593,848	71,229	12

**Note:**

<sup>a</sup>For an explanation of analytical Methods A and B, please see Section I.D; for an explanation of the flat baseline, 1a, and dynamic baseline, 1b, please see Section X.A.1.

## (2) Fuel Savings

We have also estimated the changes in fuel expenditures, or the fuel savings, using fuel prices estimated in the Energy and Information Administration's 2015 Annual Energy Outlook.<sup>804</sup> As the AEO fuel price projections go through 2040 and not beyond, fuel prices beyond 2040 were set equal to the 2040 values. These

estimates do not account for the significant uncertainty in future fuel prices; the monetized fuel savings will be understated if actual fuel prices are higher (or overstated if fuel prices are lower) than estimated. The Annual Energy Outlook (AEO) is a standard reference used by NHTSA and EPA and many other government agencies to estimate the projected price of fuel. This has been done using both the pre-tax and post-tax fuel prices. Since the post-tax fuel prices are the prices paid at fuel pumps, the fuel savings calculated using

these prices represent the changes fuel purchasers will see. The pre-tax fuel savings measure the value to society of the resources saved when less fuel is refined and consumed. Assuming no change in fuel tax rates, the difference between these two columns represents the reduction in fuel tax revenues that will be received by state and federal governments, or about \$204 million in 2021 and \$5.8 billion by 2050 as shown in Table IX-6 where annual changes in monetized fuel savings are shown along with net present values using 3 percent

<sup>804</sup>U.S. Energy Information Administration, Annual Energy Outlook 2015; Report Number DOE/EIA-0383(2015), April 2015.

and 7 percent discount rates. Table IX–7 and Table IX–8 show the discounted model year lifetime fuel savings using 3 percent and 7 percent discount rates, respectively.

TABLE IX–6—ANNUAL FUEL SAVINGS AND NET PRESENT VALUES AT 3% AND 7% DISCOUNT RATES USING METHOD B FOR THE FINAL PROGRAM AND RELATIVE TO THE FLAT BASELINE  
[\$Millions of 2013\$]<sup>a</sup>

Model year	Fuel savings—retail			Fuel savings—untaxed			Change in transfer
	Gasoline	Diesel	Sum	Gasoline	Diesel	Sum	
2018	\$0	\$114	\$114	\$0	\$97	\$97	\$17
2019	0	237	237	0	202	202	35
2020	0	371	371	0	319	319	53
2021	78	1,384	1,462	67	1,191	1,258	204
2022	210	2,689	2,899	181	2,323	2,504	395
2023	396	4,081	4,476	342	3,548	3,889	587
2024	657	6,296	6,952	571	5,488	6,059	894
2025	973	8,576	9,550	848	7,495	8,343	1,207
2026	1,343	10,903	12,246	1,173	9,586	10,759	1,487
2027	1,787	13,985	15,772	1,564	12,328	13,892	1,880
2028	2,234	17,057	19,290	1,959	15,074	17,033	2,257
2029	2,675	20,114	22,789	2,351	17,873	20,224	2,565
2030	3,116	23,160	26,276	2,746	20,627	23,373	2,903
2035	5,131	37,840	42,971	4,593	34,287	38,880	4,091
2040	6,722	51,194	57,916	6,102	46,991	53,093	4,824
2050	7,426	61,684	69,109	6,740	56,619	63,359	5,750
NPV, 3%	65,703	511,060	576,763	59,061	464,240	523,301	53,462
NPR, 7%	26,936	209,666	236,602	24,131	189,702	213,833	22,769

**Note:**  
<sup>a</sup> For an explanation of analytical Methods A and B, please see Section I.D; for an explanation of the flat baseline, 1a, and dynamic baseline, 1b, please see Section X.A.1.

TABLE IX–7—DISCOUNTED MODEL YEAR LIFETIME FUEL SAVINGS, 3% DISCOUNT RATE USING METHOD B FOR THE FINAL PROGRAM AND RELATIVE TO THE FLAT BASELINE  
[\$Millions of 2013\$]<sup>a</sup>

Model year	Fuel savings—retail			Fuel savings—untaxed			Change in transfer
	Gasoline	Diesel	Sum	Gasoline	Diesel	Sum	
2018	\$0	\$781	\$781	\$0	\$680	\$680	\$101
2019	0	747	747	0	653	653	94
2020	0	719	719	0	631	631	87
2021	674	11,497	12,171	590	10,155	10,746	1,426
2022	1,132	11,781	12,912	994	10,440	11,435	1,478
2023	1,567	11,990	13,557	1,381	10,660	12,041	1,516
2024	2,154	18,556	20,709	1,903	16,548	18,451	2,259
2025	2,571	18,849	21,420	2,278	16,859	19,137	2,283
2026	2,973	19,003	21,976	2,640	17,048	19,688	2,288
2027	3,532	24,648	28,180	3,144	22,171	25,315	2,865
2028	3,493	24,459	27,953	3,116	22,060	25,176	2,776
2029	3,449	24,378	27,828	3,084	22,044	25,128	2,700
Sum	21,545	167,408	188,954	19,131	149,950	169,081	19,873

**Note:**  
<sup>a</sup> For an explanation of analytical Methods A and B, please see Section I.D; for an explanation of the flat baseline, 1a, and dynamic baseline, 1b, please see Section X.A.1.

TABLE IX–8—DISCOUNTED MODEL YEAR LIFETIME FUEL SAVINGS, 7% DISCOUNT RATE USING METHOD B FOR THE FINAL PROGRAM AND RELATIVE TO THE FLAT BASELINE  
[\$Millions of 2013\$]<sup>a</sup>

Model year	Fuel savings—retail			Fuel savings—untaxed			Change in transfer
	Gasoline	Diesel	Sum	Gasoline	Diesel	Sum	
2018	\$0	\$558	\$558	\$0	\$483	\$483	\$74
2019	0	510	510	0	444	444	66
2020	0	466	466	0	408	408	58
2021	420	7,031	7,451	367	6,188	6,554	897
2022	674	6,946	7,620	591	6,134	6,725	895
2023	896	6,814	7,710	788	6,038	6,826	884

TABLE IX-8—DISCOUNTED MODEL YEAR LIFETIME FUEL SAVINGS, 7% DISCOUNT RATE USING METHOD B FOR THE FINAL PROGRAM AND RELATIVE TO THE FLAT BASELINE—Continued

[\$Millions of 2013\$]<sup>a</sup>

Model year	Fuel savings—retail			Fuel savings—untaxed			Change in transfer
	Gasoline	Diesel	Sum	Gasoline	Diesel	Sum	
2024 .....	1,186	10,161	11,347	1,045	9,033	10,078	1,269
2025 .....	1,362	9,947	11,309	1,204	8,870	10,074	1,235
2026 .....	1,516	9,666	11,182	1,343	8,648	9,991	1,191
2027 .....	1,737	12,081	13,818	1,542	10,839	12,381	1,436
2028 .....	1,655	11,551	13,206	1,474	10,393	11,866	1,340
2029 .....	1,576	11,097	12,672	1,406	10,013	11,419	1,254
Sum .....	11,022	86,827	97,849	9,759	77,491	87,249	10,600

**Note:**

<sup>a</sup>For an explanation of analytical Methods A and B, please see Section I.D; for an explanation of the flat baseline, 1a, and dynamic baseline, 1b, please see Section X.A.1.

*D. Maintenance Expenditures*

The agencies expect increases in maintenance costs under these standards. In the NPRM, we estimated maintenance costs associated with lower rolling resistance tires. In the final rule, we have included maintenance costs for many more systems, including waste heat recovery, APUs, transmission fluids, etc. We have estimated that these maintenance costs will be incurred throughout the vehicle lifetime at intervals consistent with typical replacement intervals. Those intervals are difficult to quantify given the variety of vehicles and operating modes within the HD industry. We detail the inputs used to estimate maintenance impacts in Chapter 7.3.3 of the RIA.

We have heard from at least one source<sup>805</sup> that strong hybrid maintenance can be higher in some ways, including possible battery replacement, but may also be much lower for some vehicle systems like brakes and general engine wear. New for the FRM, relative to the proposal, are maintenance costs on hybrid battery systems in vocational vehicles and some reduction in oil change costs on vocational vehicles with stop-start systems since less idling should result in fewer oil changes. See RIA 2.11.7. We have also included new costs for axle fluid replacements for vocational vehicles adding high efficiency axles, and transmission fluid replacements for vehicles projected to move from manual to automated transmissions. For tractors, we have added these same axle and transmission fluid costs and for the same reasons. For tractors, we have also added maintenance costs associated with auxiliary power units and for fuel operated heaters. All of the new cost estimates and the maintenance intervals

are presented in more detail in Chapter 7.2.3 of the RIA.

Table IX-9 shows the annual increased maintenance costs of the final program along with net present values using both 3 percent and 7 percent discount rates. Table IX-10 shows the discounted model year lifetime increased maintenance costs of the final program at both 3 percent and 7 percent discount rates along with sums across applicable model years.

TABLE IX-9—ANNUAL MAINTENANCE EXPENDITURE INCREASE DUE TO THE RULE AND NET PRESENT VALUES AT 3% AND 7% DISCOUNT RATES USING METHOD B AND RELATIVE TO THE FLAT BASELINE

[\$Millions of 2013\$]<sup>a</sup>

Calendar year	Maintenance expenditure increase
2018 .....	\$1
2019 .....	1
2020 .....	2
2021 .....	20
2022 .....	39
2023 .....	60
2024 .....	83
2025 .....	106
2026 .....	127
2027 .....	167
2028 .....	206
2029 .....	244
2030 .....	244
2035 .....	244
2040 .....	244
2050 .....	244
NPV, 3% .....	3,188
NPV, 7% .....	1,463

**Note:**

<sup>a</sup>For an explanation of analytical Methods A and B, please see Section I.D; for an explanation of the flat baseline, 1a, and dynamic baseline, 1b, please see Section X.A.1.

TABLE IX-10—DISCOUNTED MY LIFE-TIME MAINTENANCE EXPENDITURE INCREASE DUE TO THE RULE USING METHOD B AND RELATIVE TO THE FLAT BASELINE

[\$Millions of 2013\$]<sup>a</sup>

Model year	3% Discount rate	7% Discount rate
2018 .....	\$7	\$5
2019 .....	6	4
2020 .....	6	4
2021 .....	155	96
2022 .....	156	94
2023 .....	160	93
2024 .....	175	98
2025 .....	177	96
2026 .....	165	86
2027 .....	303	152
2028 .....	293	141
2029 .....	285	132
Sum .....	1,889	1,000

**Note:**

<sup>a</sup>For an explanation of analytical Methods A and B, please see Section I.D; for an explanation of the flat baseline, 1a, and dynamic baseline, 1b, please see Section X.A.1.

*E. Analysis of the Rebound Effect*

The “rebound effect” has been defined in a variety of different ways in the energy policy and economics literature. One common definition states that the rebound effect is the increase in demand for an energy service when the cost of the energy service is reduced due to efficiency improvements.<sup>806 807 808</sup> In

<sup>806</sup> Winebrake, J.J., Green, E.H., Comer, B., Corbett, J.J., Froman, S., 2012. *Estimating the direct rebound effect for on-road freight transportation*. Energy Policy 48, 252–259.

<sup>807</sup> Greene, D.L., Kahn, J.R., Gibson, R.C., 1999. “Fuel economy rebound effect for U.S. household vehicles.” *The Energy Journal*, 20.

<sup>808</sup> For a discussion of the wide range of definitions found in the literature, see Appendix D: Discrepancy in Rebound Effect Definitions, in EERA (2014), “Research to Inform Analysis of the Heavy-Duty vehicle Rebound Effect,” Excerpts of Draft Final Report of Phase 1 under EPA contract EP-C-

Continued

<sup>805</sup> Allison Transmission’s Responses to EPA’s Hybrid Questions, November 6, 2014.

the context of heavy-duty vehicles (HDVs), this can be interpreted as an increase in HDV fuel consumption resulting from more intensive vehicle use in response to increased vehicle fuel efficiency.<sup>809</sup> Although much of this vehicle use increase is likely to take the form of increases in the number of miles vehicles are driven, it can also take the form of increases in the loaded weight at which vehicles operate or changes in traffic and road conditions vehicles encounter as operators alter their routes and schedules in response to improved fuel efficiency. Because this more intensive use consumes fuel and generates emissions, it reduces the fuel savings and avoided emissions that would otherwise be expected to result from the increases in fuel efficiency in this rulemaking.

In our analysis and discussion below, we focus on one widely-used metric to estimate the rebound effect associated with all types of more intensive vehicle use, the increase in vehicle miles traveled (VMT) that results from improved fuel efficiency. VMT can often provide a reasonable approximation for all types of more intensive vehicle use. For simplicity, we refer to this as “the VMT rebound effect” or “the direct VMT rebound” throughout this section, although we acknowledge that it is an approximation to the rebound effect associated with all types of more intensive vehicle use. The agencies use our VMT rebound estimates to generate VMT inputs that are then entered into the EPA MOVES national emissions inventory model and the Volpe Center’s HD CAFE model. Both of these models use these inputs along with many others to generate projected emissions and fuel consumption changes resulting from each of the regulatory alternatives analyzed.

The following sections describe the factors affecting the magnitude of HDV VMT rebound; review the econometric and other evidence related to HDV VMT rebound; and summarize how we estimated the HDV rebound effect for this rulemaking.

13–025. (Docket ID: EPA–HQ–OAR–2014–0827). See also Greening, L.A., Greene, D.L., Difiglio, C., 2000, “Energy efficiency and consumption—the rebound effect—a survey,” *Energy Policy*, 28, 389–401.

<sup>809</sup> We discuss other potential rebound effects in Section E.3.b., such as the indirect and economy-wide rebound effects. Note also that there is more than one way to measure HDV energy services and vehicle use. The agencies’ analyses use VMT as a measure (as discussed below); other potential measures include ton-miles, cube-miles, and fuel consumption.

#### (1) Factors Affecting the Magnitude of HDV VMT Rebound

The magnitude and timing of HDV VMT rebound are driven by the interaction of many different factors.<sup>810</sup> Fuel savings resulting from fuel efficiency standards may cause HDV operators and their customers to change their patterns of HDV use and fuel consumption in a variety of ways. As discussed in the RIA (Chapter 8), HDV VMT rebound estimates determined via other proxy elasticities vary, but in no case has there been an estimate that fully offsets the fuel saved due to efficiency improvements (*i.e.*, no rebound effect greater than or equal to 100 percent).<sup>811</sup>

If fuel cost savings are passed on to the HDV operators’ customers (*e.g.*, logistics businesses, manufacturers, retailers, municipalities, utilities consumers, etc.), those customers might reorganize their logistics and distribution networks over time to take advantage of lower operating costs. For example, customers might order more frequent shipments or choose products that entail longer shipping distances, while freight carriers might divert some shipments to trucks from other shipping modes such as rail, barge or air. In addition, customers might choose to reduce their number of warehouses, reduce shipment rates or make smaller but more frequent shipments, all of which could lead to an increase in HDV VMT. Ultimately, fuel cost savings could ripple through the entire economy, thus increasing demand for goods and services shipped by trucks, and therefore increase HDV VMT due to increased gross domestic product (GDP).

Conversely, if fuel efficiency standards lead to net increases in the total costs of HDV operation because fuel cost savings do not fully offset the increase in HDV purchase prices and associated depreciation costs, then the price of HDV services could rise. This is likely to spur a decrease in HDV VMT, and perhaps a shift to alternative

<sup>810</sup> These factors are discussed more fully in a report to EPA from EERA, which illustrates in a series of diagrams the complex system of decisions and decision-makers that could influence the magnitude and timing of the rebound effect. See Sections 2.2.2, 2.2.3, 2.2.4, and 2.3 in EERA (2014), “Research to Inform Analysis of the Heavy-Duty Vehicle Rebound Effect,” Excerpts of Draft Final Report of Phase 1 under EPA contract EP–C–13–025 (EPA–HQ–OAR–2014–0827–0514).

<sup>811</sup> Elasticity is the measurement of how responsive an economic variable is to a change in another. For example: *Price elasticity of demand* is a measure used in economics to show the responsiveness, or elasticity, of the quantity demanded of a good or service to a change in its price. More precisely, it gives the percentage change in quantity demanded in response to a one percent change in price.

shipping modes. These effects could also ripple through the economy and affect GDP. Note, however, that we project fuel cost savings will offset technology costs in our analysis supporting the final standards.

It is also important to note that any increase in HDV VMT resulting from the final standards may be offset, to some extent, by a decrease in VMT by older HDVs. This may occur if lower fuel costs resulting from our standards cause multi-vehicle fleet operators to shift VMT to newer, more efficient HDVs in their fleet or cause operators with newer, more efficient HDVs to be more successful at winning contracts than operators with older HDVs.

Also, as discussed in Chapter 8.2 of the RIA, the magnitude of the rebound effect is likely to be influenced by the extent of any market failures that affect the demand for more fuel efficient HDVs, as well as by HDV operators’ responses to their perception of the tradeoff between higher upfront HDV purchase costs versus lower but uncertain future expenditures on fuel.

#### (2) Recent Econometric and Other Evidence Related to HDV VMT Rebound

As discussed above, HDV VMT rebound is defined as the change in HDV VMT that occurs in response to an increase in HDV fuel efficiency. We are not aware of any studies that directly estimate this elasticity for the U.S. In the proposal, we discussed a number of econometric analyses of other related elasticities that could potentially be used as a proxy for measuring HDV VMT rebound, as well as several other analyses that may provide insight into the magnitude of HDV VMT rebound.<sup>812</sup> These studies produced a wide range of estimates for HDV VMT rebound, however, and we were unable to draw any strong conclusions about the magnitude of rebound based on this available literature.

We also discussed several challenges that researchers face in attempting to quantify the VMT rebound effect for HDVs,<sup>813</sup> including limited data on the HD sector and the difficulty of specifying mathematical models that reflect the complex set of factors that influence HD VMT. Given these limitations, the agencies requested comment on a number of aspects of the proposed VMT rebound analysis, including procedures for measuring the rebound effect and the studies discussed in the proposal. The agencies also committed to reviewing and considering revisions to VMT rebound estimates for

<sup>812</sup> See 80 FR 40448–40452.

<sup>813</sup> See 80 FR 40448–40452.

the final rule based on submissions from public commenters and new research on the rebound effect.

This section reviews new econometric analyses that have been produced since the release of the proposal. All of these analyses study the change in HDV use (measured in VMT, ton-mile, or fuel consumption) in response to changes in fuel price (\$/gallon) or fuel cost (\$/mile or \$/ton-mile). The studies presented below attempt to estimate these elasticities in the HDV sector using varying approaches and data sources.

Concurrent with the development of the proposal for this rule, EPA contracted with Energy and Environmental Research Associates (EERA) to analyze the HDV rebound effect for regulatory assessment purposes. Excerpts of EERA's initial report to EPA are included in the NPRM docket and contain detailed qualitative discussions of the rebound effect as well as data sources that could be used in quantitative analysis.<sup>814</sup> EERA also conducted follow-on quantitative analyses focused on estimating the impact of fuel prices on VMT and fuel consumption. We included a Working Paper in the NPRM docket that described much of this work.<sup>815</sup> Note that EERA's Working Paper was not available at the time the agencies conducted the analysis of the rebound effect for the proposal, but that the agencies agreed to consider this work and any other work in the analysis supporting the final rule.

At the time of publication of the NPRM, Winebrake et al. (2015) published two papers in Transportation Research Part D: Transport and Environment based on the EERA work mentioned above.<sup>816</sup> These two papers have been filed in each agency's docket and received public review and comment. In the first paper, the fuel price elasticities of VMT and fuel consumption for combination trucks are estimated with regression models. The combination trucks paper uses annual data for the period 1970–2012. VMT and fuel consumption are used as the

dependent variables. The control variables include: A macroeconomic variable (e.g., gross domestic product (GDP)), imports/exports, and fuel price, among other variables. In the second paper, the fuel price elasticity of VMT for single unit vehicles is estimated by using annual data for the period 1980–2012. The single unit vehicle paper uses similar control variables but includes additional variables related to lane miles and housing construction. VMT is the only dependent variable modeled in the single unit vehicle paper (i.e., fuel consumption is not modeled).

The results in Winebrake et al. are that the null hypothesis—which states that the fuel price elasticity of VMT and the fuel price elasticity of fuel consumption are zero—cannot be rejected with statistical confidence. The papers hypothesize that low elasticities may be due to a range of possibilities including: (1) The common use of fuel surcharges; (2) adjustments in other operational costs such as labor; (3) possible principal-agent problems affecting driver behavior; and (4) the nature of freight transportation as an input to a larger supply chain system that is driven by other factors. These two papers suggest that previous regulatory analysis that uses a five percent rebound effect for combination trucks and a 15 percent rebound effect for single unit trucks may be overestimating the direct VMT rebound effect.

To the best of our knowledge, the Winebrake et al. paper represents the first peer-reviewed work in the last two decades, after Gately (1990),<sup>817</sup> that attempts to estimate quantitatively the impact of a change in fuel costs on HDV VMT in the U.S. context. A subsequent paper by Wadud, discussed in more detail below, states that there is “only one creditable study” on “the responses of different [heavy duty] vehicle sectors to fuel price or income changes,” specifically the Winebrake et al. combination truck work.

However, there is also other recent work that has not been peer reviewed, or that studies HD VMT rebound in other countries, that bears mention. Resources for the Future (RFF) filed a comment on the proposal with a Working Paper by Leard et al. (2015) to address HDV rebound effects.<sup>818 819</sup>

<sup>817</sup> Gately, D., 1990. *The U.S. demand for highway travel and motor fuel*. Energy J. 11, 59–74.

<sup>818</sup> Resources for the Future (RFF) comment, EPA-HQ-OAR-2014-0827-1200.

<sup>819</sup> Leard, B., et al., *Fuel Costs, Economic Activity, and the Rebound Effect for Heavy-Duty Trucks*. September 2015, Resources for the Future: RF DP 15-43, Washington, DC. EPA-HQ-OAR-2014-0827-1200-A1.

Leard et al.'s paper uses detailed truck-level micro-data from the Vehicle Inventory and Use Survey (VIUS) for six survey years (specifically, 1977, 1982, 1987, 1992, 1997, and 2002). The “rebound effect” in this paper is defined to be a combination of a “VMT elasticity with respect to fuel costs per mile” (\$/mile); and a “truck count elasticity with respect to fuel costs per mile.” Fuel costs per mile are defined as fuel price (\$/gal) divided by efficiency (mpg). Because the agencies do not estimate the directional impact of this rulemaking on vehicle sales, the portion of Leard et al.'s estimates associated with VMT rebound with respect to fuel costs per mile are the most useful point of comparison to the estimates in the proposal for this rulemaking.

Leard et al. report a VMT rebound effect result of 18.5 percent with respect to fuel costs per mile for combination trucks.<sup>820</sup> This finding suggests that previous estimates of combination truck rebound effects used in the proposed rule, a five percent rebound effect, may be underestimating the true rebound effect. Leard et al. also report a VMT rebound effect with respect to fuel costs per mile of 12.2 percent for single unit trucks.<sup>821</sup> This finding (like the findings of the Winebrake paper) suggests that the previous use of a 15 percent rebound effect for single unit vehicles in the proposed rule may be overestimating the true rebound effect. As noted, VIUS was discontinued in 2002, so the most recent data in this study is 2002, which is fourteen years old. The Leard et al. Working Paper has not yet been peer reviewed or published.

Recently, Wadud (2016) has estimated price elasticities of diesel demand in the U.K.<sup>822</sup> The paper aims to model diesel demand elasticities for different freight duty vehicle types in the U.K. Wadud uses a similar model specification as Winebrake et al. in the regression analysis. Wadud finds that diesel consumption in freight vehicles overall is quite inelastic. Diesel demand from articulated trucks and large goods vehicles (similar to combination trucks in the U.S.) does not respond to changes

<sup>820</sup> Leard et al. report a total VMT rebound effect result of 29.7 percent for combination trucks, which is a sum of separate estimates associated with both VMT elasticity and truck count elasticity with respect to fuel costs per mile.

<sup>821</sup> For vocational trucks, Leard et al. report an overall 9.3 percent rebound value, which is a sum of separate estimates associated with both VMT elasticity and truck count elasticity with respect to fuel costs per mile.

<sup>822</sup> Wadud, Zia, *Diesel Demand in the Road Freight Sector in the UK: Estimates for Different Vehicle Types*. Applied Energy 165 (2016), p. 849–857.

<sup>814</sup> EERA (2014), “Research to Inform Analysis of the Heavy-Duty Vehicle Rebound Effect,” Excerpts of Draft Final Report of Phase 1 under EPA contract EP-C-13-025, EPA-HQ-OAR-2014-0827-0514.

<sup>815</sup> EERA (2015), “Working Paper on Fuel Price Elasticities for Heavy Duty Vehicles,” Draft Final Report of Phase 2 under EPA contract EP-C-11-046, EPA-HQ-OAR-2014-0827-0515.

<sup>816</sup> Winebrake, J.J., et al., *Fuel price elasticities in the U.S. combination trucking sector*. Transportation Research Part D: Transport and Environment, 2015. 38: p. 166–177.

Winebrake, J.J., et al., *Fuel price elasticities for single unit truck operations in the United States*. Transportation Research Part D: Transport and Environment, 2015. 38: p. 178–187.

in diesel prices. Demand in rigid trucks (similar to single unit trucks in the U.S.) responds to fuel price changes with a 15 percent elasticity. Wadud's work presents empirical results in the U.K., which might not be necessarily be appropriate to apply to the U.S.

(3) How the Agencies Estimated the HDV Rebound Effect for the Final Rule

(a) Values Used in the Phase 2 NPRM Analysis

At the time the agencies conducted their analysis of the proposed Phase 2 HD fuel efficiency and GHG emissions standards, the agencies determined that the evidence did not lend itself to any changes in the values used to estimate the VMT rebound effect in the HD Phase 1 rulemaking. The agencies used the rebound effects estimate of 15 percent for vocational vehicles five percent for combination tractors, and 10 percent for HD pickup trucks and vans from the HD Phase 1 rulemaking.

(b) How the Agencies Analyzed VMT Rebound in This Final Rulemaking

The emergence of new information as well as public comment are cause for updating the quantitative values used to estimate the VMT rebound effect from those estimated by the analysis conducted for the HD Phase 1 rulemaking. For vocational trucks, the Winebrake et al. study found no responsiveness of truck travel to diesel fuel prices, suggesting a VMT rebound of essentially zero. Leard et al. suggested a VMT rebound effect for vocational trucks of roughly 12 percent. For combination trucks, the Winebrake et al. study found a rebound effect of essentially zero percent. The Leard et al. study found a VMT elasticity rebound effect of roughly 18 percent for combination trucks. In addition to the RFF comments to which Leard et al. was included, EPA and NHTSA received ten other comments on HDV rebound during the comment period for the proposal, six of which were substantive. One of these commenters suggested that the agencies' rebound numbers "appear reasonable." The five others commented that the rebound estimates for both combination and vocational vehicles used in the proposal were overestimated, and suggested using the Winebrake et al. estimates.

In revising the HD VMT rebound estimates, we give somewhat greater consideration to the findings of Winebrake et al. because it is peer-reviewed and published, whereas Leard et al. is a Working Paper. Based on this consideration and on the comments that we received in response to the proposal,

the agencies have chosen to revise the VMT rebound estimate for vocational trucks down to five percent, and have elected to maintain the use of the five percent rebound effect for tractors. We note that while the Winebrake et al. work supports rebound estimates of zero percent for vocational vehicles and tractors, using a five percent value is conservative and leaves some consideration of uncertainty, as well as some consideration of the (un-peer reviewed and unpublished) findings of the Leard et al. study. The five percent value is in range of the two U.S. studies and generally addresses the issues raised by the commenters. We did not receive new data or comments on our estimated VMT rebound effect for heavy-duty pick-up trucks and vans. Therefore, we have elected to use the 10 percent value used for the proposal.

It should be noted that the rebound estimates we have selected for our analysis represent the VMT impact from the final standards with respect to changes in the fuel cost per mile driven. As described in the RIA (Chapter 8), the HDV rebound effect should ideally be a measure of the change in fuel consumed with respect to the change in *overall* operating costs due to a change in HDV fuel efficiency. Such a measure would incorporate all impacts from our rules, including those from incremental increases in vehicle prices that reflect costs for improving their fuel efficiency. Therefore, VMT rebound estimates with respect to fuel costs per mile must be "scaled" to apply to total operating costs, by dividing them by the fraction of total operating costs accounted for by fuel use.

In the NPRM, due to timing constraints, we used the same "overall" VMT rebound value for each of the alternatives. For the final rulemaking, we determined VMT rebound separately for each HDV category and for each alternative. The agencies made simplifying assumptions in the VMT rebound analysis for this final rulemaking, similar to the approach taken during HD Phase 1 final rules. For example, due to timing constraints, the agencies did not have the final technology package costs for each of the alternatives prior to the need to conduct the emission inventory analysis. Therefore, the agencies used the technology package costs developed for each of the NPRM alternatives. Chapter 8.3.3 in the RIA provides more details on our assessment of HDV VMT rebound. In addition, Chapter 7 of the RIA presents VMT rebound for each HDV sector that we estimated for the final program. These VMT impacts are reflected in the estimates of total fuel

savings and reductions in emissions of GHG and other air pollutants presented in Section VII and VIII of this Preamble for all categories.

For the purposes of this final rulemaking, we have not taken into account any potential fuel savings or GHG emission reductions from the rail sector due to mode shift because estimates of this effect seem too speculative at this time. Similarly, we have not taken into account any fuel savings or GHG emissions reductions from the potential shift in VMT from older HDVs to newer, more efficient HDVs because we have found no evidence of this potential effect from fuel efficiency standards. The agencies requested comment on these assumptions in the NPRM, but did not receive any.

Note that while we focus on the VMT rebound effect in our analysis of these final rules, there are at least two other types of rebound effects discussed in the energy policy and economics literature. In addition to VMT rebound effects, there are "indirect" rebound effects, which refers to the purchase of other goods or services (that consume energy) with the costs savings from energy efficiency improvements; and "economy-wide" rebound effects, which refers to the increased demand for energy throughout the economy in response to the reduced market price of energy that happens as a result of energy efficiency improvements. One commenter pointed out that consumers may use their savings from lower fuel costs as a result of the direct rebound effect to buy more goods and services, which indirectly increases the use of energy (*i.e.*, the indirect rebound effect).<sup>823</sup> The commenter states that the indirect rebound effect represents a positive economic result for consumers, since consumer welfare increases, although it could result in increased energy use and GHG emissions. We agree with the commenter's observation that, to the extent that indirect rebound does occur, it could have both positive and negative impacts.

Another commenter suggested that the indirect or economy-wide rebound effect could be large enough so as to fully offset the fuel savings and GHG emissions benefits of the rule.<sup>824</sup> The commenter provides multiple estimates of the potential size of the indirect rebound effect. However, the unpublished methodology used to perform these estimates has not undergone peer review and, as explained in the response to comment

<sup>823</sup> EPA-HQ-OAR-2014-0827-1336.

<sup>824</sup> EPA-HQ-OAR-2014-0827-1467.

document, the agencies find it to be dubious. Further, as discussed in detail in the proposal rule and our response to comment document, there are a number of other important questions not addressed by the commenter that must be examined before we can have enough confidence in these kinds of estimates to include them in our economic analysis.

As discussed in this rule, all of the fuel costs savings will not necessarily be passed through to the consumer in terms of cheaper goods and services. First, there may be market barriers that impede trucking companies from passing along the fuel cost savings from the rule in the form of lower rates. Second, there are upfront vehicle costs (and potentially transaction or transition costs associated with the adoption of new technologies) that would partially offset some of the fuel cost savings from our rule, thereby limiting the magnitude of the impact on prices of final goods and services. Also, it is not clear how the fuel savings from the rule would be utilized by trucking firms. For example, trucking firms may reinvest fuel savings in their own company; retain fuel savings as profits; pass fuel savings onto customers or others; or increase driver pay. Finally, it is not clear how the different pathways that fuel savings would be utilized would affect greenhouse gas emissions.

Research on indirect and economy-wide rebound effects is scant, and we have not identified any peer-reviewed research that attempts to quantify indirect or economy-wide rebound effects for HDVs. In particular, the agencies are not aware of any peer-reviewed approach which indicates that the magnitude of indirect or economy-wide rebound effects, if any, would be significant for this final rule.<sup>825</sup> Therefore, we rely on the analysis of vehicle miles traveled to estimate the rebound effect in this rule, as we did for the HD Phase 1 rule, where we attempted to quantify only rebound

effects from our rule that impact HDV VMT.

In order to test the effect of alternative assumptions about the rebound effect, NHTSA examined the sensitivity of its estimates of benefits and costs of the proposed Phase 2 program for HD pickups and vans to alternative assumptions about the rebound effect. While the main analysis for pickups and vans assumes a 10 percent rebound effect, the sensitivity analysis estimates the benefits and costs of these standards under the assumptions of 5, 15, and 20 percent rebound effects. This sensitivity analysis can be found in Section IX.E.3 of the NPRM Preamble<sup>826</sup> and shows that (a) using a 5 percent value for the rebound effect reduced benefits and costs of the proposed standards by identical amounts, leaving net benefits unaffected; and (b) rebound effects of 15 percent and 20 percent increased costs and reduced benefits compared to their values in the main analysis, thus reducing net benefits of the proposed standards. Nevertheless, the proposed and now the final program have significant net benefits and these alternative values of the rebound effect would not have affected the agencies' selection of the final program stringency, as that selection is based on NHTSA's assessment of the maximum feasible fuel efficiency standards and EPA's selection of appropriate GHG standards to address energy security and the environment.

#### *F. Impact on Class Shifting, Fleet Turnover, and Sales*

The agencies considered two additional potential indirect effects which may lead to unintended consequences of the program to improve the fuel efficiency and reduce GHG emissions from HD trucks. The next sections cover the agencies' qualitative discussions on potential class shifting and fleet turnover effects.

##### (1) Class Shifting

Heavy-duty vehicles are typically configured and purchased to perform a function. For example, a concrete mixer truck is purchased to transport concrete, a combination tractor is purchased to move freight with the use of a trailer, and a Class 3 pickup truck could be purchased by a landscape company to pull a trailer carrying lawnmowers. The purchaser makes decisions based on many attributes of the vehicle, including the gross vehicle weight rating of the vehicle, which in part determines the amount of freight or equipment that can be carried. If the Phase 2 standards

impact either the performance of the vehicle or the marginal cost of the vehicle relative to the other vehicle classes, then consumers may choose to purchase a different vehicle, resulting in the unintended consequence of increased fuel consumption and GHG emissions in-use.

The agencies, along with the NAS panel, found that there is little or no literature which evaluates class shifting between trucks.<sup>827</sup> In addition, the agencies did not receive comments specifically raising concerns about class shifting. NHTSA and EPA qualitatively evaluated the final rules in light of potential class shifting. The agencies looked at four potential cases of shifting: From light-duty pickup trucks to heavy-duty pickup trucks; from sleeper cabs to day cabs; from combination tractors to vocational vehicles; and within vocational vehicles.

Light-duty pickup trucks, those with a GVWR of less than 8,500 lbs, are currently regulated under the existing GHG/CAFE standards for light duty vehicles. The increased stringency of the light-duty 2017–2025 MY vehicle rule has led some to speculate that vehicle consumers may choose to purchase heavy-duty pickup trucks that are currently regulated under the HD Phase 1 program if the cost of the light-duty regulation is high relative to the cost to buy the larger heavy-duty pickup trucks. Since fuel consumption and GHG emissions rise significantly with vehicle mass, a shift from light-duty trucks to heavy-duty trucks would likely lead to higher fuel consumption and GHG emissions, an unintended consequence of the regulations. Given the significant price premium of a heavy-duty truck (often five to ten thousand dollars more than a light-duty pickup), we believe that such a class shift would be unlikely whether or not this program existed. These final rules would continue to diminish any incentive for such a class shift because they would narrow the GHG and fuel efficiency performance gap between light-duty and heavy-duty pickup trucks. The regulations for the HD pickup trucks, and similarly for vans, are based on similar technologies and therefore reflect a similar expected increase in cost when compared to the light-duty GHG regulation. Hence, the combination of the two regulations provides little incentive for a shift from light-duty trucks to HD trucks. To the extent that this regulation of heavy-duty pickups and vans could conceivably encourage a class shift towards lighter pickups, this unintended consequence

<sup>825</sup> The same entity responsible for these comments also sought reconsideration of the Phase 1 rule on the grounds that indirect rebound effects had not been considered by the agencies and could negate all of the benefits of the standards. This assertion rested on an unsupported affidavit lacking any peer review or other indicia of objectivity. This affidavit cited only one published study. The study cited did not deal with vehicle efficiency, has methodological limitations (many of them acknowledged), and otherwise was not pertinent. EPA and NHTSA thus declined to reconsider the Phase 1 rule based on these speculative assertions. See generally 77 FR 51703–51704, August 27, 2012 and 77 FR 51502–51503, August 24, 2012. The analysis in this entity's comments on this rulemaking rests largely on that same unsupported affidavit.

<sup>826</sup> 80 FR 40137.

<sup>827</sup> See 2010 NAS Report, page 152.



would in fact be expected to lead to lower fuel consumption and GHG emissions as the smaller light-duty pickups have significantly better fuel economy ratings than heavy-duty pickup trucks.

The projected cost increases for this action differ between Class 8 day cabs and Class 8 sleeper cabs, reflecting our conservative assumption for purposes of this analysis on shifting that compliance with these standards would lead truck consumers to specify sleeper cabs equipped with APUs or alternatives to APU while day cab consumers would not. Since Class 8 day cab and sleeper cab trucks perform essentially the same function when hauling a trailer, this raises the possibility that the additional cost for an APU or alternatives to APU equipped sleeper cab could lead to a shift from sleeper cab to day cab trucks. We do not believe that such an intended consequence would occur for the following reasons. The addition of a sleeper berth to a tractor cab is not a consumer-selectable attribute in quite the same way as other vehicle features. The sleeper cab provides a utility that long-distance trucking fleets need to conduct their operations—an on-board sleeping berth that lets a driver comply with federally-mandated rest periods, as required by the Department of Transportation Federal Motor Carrier Safety Administration's hours-of-service regulations. The cost of sleeper trucks is already higher than the cost of day cabs, yet the fleets that need this utility purchase them.<sup>828</sup> A day cab simply cannot provide this utility with a single driver. The need for this utility would not be changed even if the additional costs to reduce greenhouse gas emissions from sleeper cabs exceed those for reducing greenhouse gas emissions from day cabs.<sup>829</sup>

A trucking fleet could instead decide to put its drivers in hotels in lieu of using sleeper berths, and switch to day cabs. However, this is unlikely to occur in any great number, since the added cost for the hotel stays would far overwhelm differences in the marginal cost between day and sleeper cabs. Even if some fleets do opt to buy hotel rooms and switch to day cabs, they would be highly unlikely to purchase a day cab that was aerodynamically worse than

the sleeper cab they replaced, since the need for features optimized for long-distance hauling would not have changed. So in practice, there would likely be little difference to the environment for any switching that might occur. Further, while our projected costs in the NPRM assumed the purchase of an APU for compliance for nearly all sleeper cabs, the updated analysis reflects additional flexibility in the final rules that would allow manufacturers to use several other alternatives to APUs that would be much less expensive. Thus, even though we are now projecting that APU costs will be somewhat higher than what we projected for the NPRM, manufacturers and consumers will not be required to use them. In fact, this regulatory structure would allow compliance using a near zero cost software utility that eliminates tractor idling after five minutes. Using this compliance approach, the cost difference between a Class 8 sleeper cab and day cab due to these regulations is small. We are proposing this alternative compliance approach reflecting that some sleeper cabs are used in team driving situations where one driver sleeps while the other drives. In that situation, an APU is unnecessary since the tractor is continually being driven when occupied. When it is parked, it would automatically eliminate any additional idling through the shutdown software. If trucking businesses choose this option, then costs based on purchase of APUs may overestimate the costs of this program to this sector.

Class shifting from combination tractors to vocational vehicles may occur if a customer deems the additional marginal cost of tractors due to the regulation to be greater than the utility provided by the tractor. The agencies initially considered this issue when deciding whether to include Class 7 tractors with the Class 8 tractors or regulate them as vocational vehicles. The agencies' evaluation of the combined vehicle weight rating of the Class 7 shows that if these vehicles were treated significantly differently from the Class 8 tractors, then they could be easily substituted for Class 8 tractors. Therefore, the agencies will continue to include both classes in the tractor category. The agencies believe that a shift from tractors to vocational vehicles would be limited because of the ability of tractors to pick up and drop off trailers at locations which cannot be done by vocational vehicles.

The agencies do not envision that the regulatory program would cause class shifting within the vocational vehicle class. As vocational vehicles include a

wide variety of vehicle types, and serve a wide range of functions, the diversity in the vocational vehicle segment can be primarily attributed to the variety of customer needs for specialized vehicle bodies and added equipment, rather than to the chassis. The new standards are projected to lead to a small increase in the incremental cost per vehicle. However, these cost increases are consistent across the board for both vocational vehicles and the engines used in the vehicle (Table V-30 at Preamble Section V.C.(2)(e)). The agencies believe that the utility gained from the additional technology package would outweigh the additional cost for vocational vehicles.<sup>830</sup>

In conclusion, NHTSA and EPA believe that the regulatory structure for HD vehicles and engines would not significantly change the current competitive and market factors that determine purchaser preferences. Furthermore, even if a small amount of shifting would occur, any resulting GHG impacts would likely be negligible because any vehicle class that sees an uptick in sales is also being regulated for GHG emission control and fuel efficiency. Therefore, the agencies did not include an impact of class shifting on the vehicle populations used to assess the benefits of the program.

## (2) Fleet Turnover and Sales Effects

A regulation that affects the cost to purchase and/or operate trucks could affect whether a consumer decides to purchase a new truck and the timing of that purchase. The term pre-buy refers to the idea that truck purchases may occur earlier than otherwise planned to avoid the additional costs associated with a new regulatory requirement. Slower fleet turnover, or low-buys, may occur when owners opt to keep their existing truck rather than purchase a new truck due to the incremental cost of the regulation.

Several commenters raised the possibility of pre-buy for these standards. Allison Transmission, the National Automobile Dealers Association, the Owner-Operator Independent Drivers Association, and the Truck Renting and Leasing Association point toward pre-buy associated with standards from the 2000s for nitrogen oxides (NO<sub>x</sub>) regulations as evidence of the likelihood

<sup>828</sup> A baseline tractor price of a new day cab is \$89,500 versus \$113,000 for a new sleeper cab based on information gathered by ICF in the "Investigation of Costs for Strategies to Reduce Greenhouse Gas Emissions for Heavy-Duty On-Road Vehicles," July 2010. Page 3. Docket Identification Number EPA-HQ-OAR-2014-0827.

<sup>829</sup> The average marginal cost difference between sleeper cabs and day cabs in the rule is roughly \$2,500.

<sup>830</sup> The final rule projects the average per-vehicle costs associated with the 2027 MY standards to be generally less than five percent of the overall price of a new vehicle. The cost-effectiveness of these vocational vehicle standards in dollars per ton is similar to the cost effectiveness estimated for light-duty trucks in the 2017-2025 light duty greenhouse gas standards (Preamble section V.C.3).

of pre-buy for vehicle GHG and fuel efficiency standards. Daimler Trucks North America, the International Union, United Automobile, Aerospace, and Agricultural Implement Workers of America, and the Truck and Engine Manufacturers Association express concern about pre-buy specifically in the context of NPRM Alternative 4, due to concerns that the time frame for technology development and adoption was too short. Daimler Trucks and the Environmental Defense Fund note that Phase 1 did not appear to result in pre-buy. Volvo Group notes that the phase-in approach of Phase 1 plus the flexibilities available eased the transition to new technologies, and that gradual market acceptance of new technologies will lead to less disruption than an accelerated program. The Recreational Vehicle Industry Association expressed concern that the standards will have a negative effect on recreational vehicle sales.

The 2010 NAS HD Report discussed the topics associated with medium- and heavy-duty vehicle fleet turnover. NAS noted that there is some empirical evidence of pre-buy behavior in response to the 2004 and 2007 heavy-duty engine emission standards, with larger impacts occurring in response to higher costs.<sup>831</sup> However, those regulations increased upfront costs to firms without any offsetting future cost savings from reduced fuel purchases. In summary, NAS stated that:

. . . during periods of stable or growing demand in the freight sector, pre-buy behavior may have significant impact on purchase patterns, especially for larger fleets with better access to capital and financing. Under these same conditions, smaller operators may simply elect to keep their current equipment on the road longer, all the more likely given continued improvements in diesel engine durability over time. On the other hand, to the extent that fuel economy improvements can offset incremental purchase costs, these impacts will be lessened. Nevertheless, when it comes to efficiency investments, most heavy-duty fleet operators require relatively

quick payback periods, on the order of two to three years.<sup>832</sup>

The regulations are projected to return fuel savings to the vehicle owners that offset the cost of the regulation within a few years. The effects of the regulation on purchasing behavior and sales will depend on the nature of the market failures and the extent to which firms consider the projected future fuel savings in their purchasing decisions.

If trucking firms or other buyers account for the rapid payback, they are unlikely to strategically accelerate or delay their purchase plans at additional cost in capital to avoid a regulation that will lower their overall operating costs. As discussed in Section IX.A., this scenario may occur if this program reduces uncertainty about fuel-saving technologies. More reliable information about ways to reduce fuel consumption allows truck purchasers to evaluate better the benefits and costs of additional fuel savings, primarily in the original vehicle market, but possibly in the resale market as well. In addition, these standards are expected to lead manufacturers to install more fuel-saving technologies and promote their purchase; the increased availability and promotion may encourage sales.

Other market failures may leave open the possibility of some pre-buy or delayed purchasing behavior. Firms may not consider the full value of the future fuel savings for several reasons. For instance, truck purchasers may not want to invest in fuel efficiency because of uncertainty about fuel prices. Another explanation is that the resale market may not fully recognize the value of fuel savings, due to lack of trust of new technologies or changes in the uses of the vehicles. Lack of coordination (also called split incentives—see Section IX.A) between truck purchasers (who may emphasize the up-front costs of the trucks) and truck operators, who like the fuel savings, can also lead to pre-buy or delayed purchasing behavior. If these market failures prevent firms from fully internalizing fuel savings when deciding on vehicle purchases, then pre-buy and delayed purchase could occur and could result in a slight decrease in the GHG benefits of the regulation.

Thus, whether pre-buy or delayed purchase is likely to play a significant role in the truck market depends on the specific behaviors of purchasers in that market. Without additional information about which scenario is more likely to be prevalent, the agencies are not

projecting a change in fleet turnover characteristics due to this regulation.

Industry purchasing in relation to the advent of the Phase 1 standards offers at least some insight into the impacts of these standards. The Environmental Defense Fund observes that MY 2014 heavy-duty trucks had the highest sales since 2005. Any trends in sales are likely to be affected by macroeconomic conditions, which have been recovering since 2009–2010. The standards may have affected sales, but the size of that effect is likely to be swamped by the effects of the economic recovery. It is unlikely to be possible to separate the effects of the existing standards from other confounding factors.

### G. Monetized GHG Impacts

#### (1) Monetized CO<sub>2</sub> Impacts—The Social Cost of Carbon (SC-CO<sub>2</sub>)

We estimate the global social benefits of CO<sub>2</sub> emission reductions expected from the heavy-duty GHG and fuel efficiency standards using the social cost of carbon (SC-CO<sub>2</sub>) estimates presented in the *Technical Support Document: Technical Update of the Social Cost of Carbon for Regulatory Impact Analysis Under Executive Order 12866* (May 2013, Revised July 2015) (“current SC-CO<sub>2</sub> TSD”).<sup>833</sup> (The SC-CO<sub>2</sub> estimates are presented in Table IX–11). We refer to these estimates, which were developed by the U.S. government, as “SC-CO<sub>2</sub> estimates.” The SC-CO<sub>2</sub> is a metric that estimates the monetary value of impacts associated with marginal changes in CO<sub>2</sub> emissions in a given year. It includes a wide range of anticipated climate impacts, such as net changes in agricultural productivity and human health, property damage from increased flood risk, and changes in energy system costs, such as reduced costs for heating and increased costs for air conditioning. It is typically used to assess the avoided damages as a result of regulatory actions (*i.e.*, benefits of rulemakings that lead to an incremental reduction in cumulative global CO<sub>2</sub> emissions).

The SC-CO<sub>2</sub> estimates used in this analysis were developed over many

<sup>833</sup> *Technical Support Document: Technical Update of the Social Cost of Carbon for Regulatory Impact Analysis Under Executive Order 12866* (May 2013, Revised July 2015), Interagency Working Group on Social Cost of Carbon, with participation by Council of Economic Advisers, Council on Environmental Quality, Department of Agriculture, Department of Commerce, Department of Energy, Department of Transportation, Environmental Protection Agency, National Economic Council, Office of Energy and Climate Change, Office of Management and Budget, Office of Science and Technology Policy, and Department of Treasury. Available at: <https://www.whitehouse.gov/sites/default/files/omb/inforeg/scc-td-final-july-2015.pdf>.

<sup>831</sup> Committee to Assess Fuel Economy Technologies for Medium- and Heavy-Duty Vehicles; National Research Council; Transportation Research Board (2010). “Technologies and Approaches to Reducing the Fuel Consumption of Medium- and Heavy-Duty Vehicles,” (hereafter, “NAS Report”). Washington, DC, the National Academies Press. Available electronically from the National Academies Press Web site at [http://www.nap.edu/catalog.php?record\\_id=12845](http://www.nap.edu/catalog.php?record_id=12845), pp. 150–151, Docket EPA–HQ–OAR–2014–0827–0276.

<sup>832</sup> See NAS Report, Note 831, page 151, Docket EPA–HQ–OAR–2014–0827–0276.

years, using the best science available, and with input from the public. Specifically, an interagency working group (IWG) that included EPA, DOT, and other executive branch agencies and offices used three integrated assessment models (IAMs) to develop the SC-CO<sub>2</sub> estimates and recommended four global values for use in regulatory analyses. The SC-CO<sub>2</sub> estimates were first released in February 2010 and updated in 2013 using new versions of each IAM. The 2013 update did not revisit the 2010 modeling decisions (e.g., with regard to the discount rate, reference case socioeconomic and emission scenarios or equilibrium climate sensitivity). Rather, improvements in the way damages are modeled are confined to those that have been incorporated into the latest versions of the models by the developers themselves and used for analyses in peer-reviewed publications. The 2010 SC-CO<sub>2</sub> Technical Support Document (2010 SC-CO<sub>2</sub> TSD) provides a complete discussion of the methods used to develop these estimates and the current SC-CO<sub>2</sub> TSD presents and discusses the update (including recent minor technical corrections to the estimates).<sup>834</sup>

The 2010 SC-CO<sub>2</sub> TSD noted a number of limitations to the SC-CO<sub>2</sub> analysis, including the incomplete way in which the IAMs capture catastrophic and non-catastrophic impacts, their incomplete treatment of adaptation and technological change, uncertainty in the extrapolation of damages to high temperatures, and assumptions regarding risk aversion. Currently IAMs do not assign value to all of the important physical, ecological, and economic impacts of climate change recognized in the climate change literature due to a lack of precise information on the nature of damages and because the science incorporated into these models understandably lags behind the most recent research. Nonetheless, these estimates and the

discussion of their limitations represent the best available information about the social benefits of CO<sub>2</sub> reductions to inform benefit-cost analysis; see RIA of this rule and the SC-CO<sub>2</sub> TSDs for additional details. The new versions of the models used to estimate the values presented below offer some improvements in these areas, although further work is warranted.

Accordingly, EPA and other agencies continue to engage in research on modeling and valuation of climate impacts with the goal to improve these estimates. The EPA and other federal agencies also continue to consider feedback on the SC-CO<sub>2</sub> estimates from stakeholders through a range of channels, including public comments on Agency rulemakings that use the SC-CO<sub>2</sub> in supporting analyses and through regular interactions with stakeholders and research analysts implementing the SC-CO<sub>2</sub> methodology used by the IWG. The SC-CO<sub>2</sub> comments received on this rulemaking covered the technical details of the modeling conducted to develop the SC-CO<sub>2</sub> estimates and some also provided constructive recommendations for potential opportunities to improve the SC-CO<sub>2</sub> estimates in future updates. EPA has carefully considered all of these comments and continues to conclude that the current estimates represent the best scientific information on the impacts of climate change available in a form appropriate for incorporating the damages from incremental CO<sub>2</sub> emissions changes into regulatory analysis. Therefore, EPA has presented the current SC-CO<sub>2</sub> estimates in this rulemaking. See Section 11.8 of the RTC document for a summary of and response to the SC-CO<sub>2</sub> comments submitted to this rulemaking. In addition, OMB sought public comment on the approach used to develop the SC-CO<sub>2</sub> estimates through a separate comment period and published a response to those comments in 2015.<sup>835</sup>

After careful evaluation of the full range of comments submitted to OMB, the IWG continues to recommend the use of the SC-CO<sub>2</sub> estimates in regulatory impact analysis. With the July 2015 release of the response to comments, the IWG announced plans to obtain expert independent advice from the National Academies of Sciences, Engineering and Medicine to ensure that the SC-CO<sub>2</sub> estimates continue to reflect the best available scientific and economic information on climate change. The Academies then convened a committee, "Assessing Approaches to

Updating the Social Cost of Carbon," (Committee) which is reviewing the state of the science on estimating the SC-CO<sub>2</sub>, and will provide expert, independent advice on the merits of different technical approaches for modeling and highlight research priorities going forward. EPA will evaluate its approach based upon any feedback received from the Academies' panel.

To date, the Committee has released an interim report, which recommended against doing a near term update of the SC-CO<sub>2</sub> estimates. For future revisions, the Committee recommended the IWG move efforts towards a broader update of the climate system module consistent with the most recent, best available science, and also offered recommendations for how to enhance the discussion and presentation of uncertainty in the SC-CO<sub>2</sub> estimates. Specifically, the Committee recommended that "the IWG provide guidance in their technical support documents about how [SC-CO<sub>2</sub>] uncertainty should be represented and discussed in individual regulatory impact analyses that use the [SC-CO<sub>2</sub>]" and that the technical support document for each update of the estimates present a section discussing the uncertainty in the overall approach, in the models used, and uncertainty that may not be included in the estimates. At the time of this writing, the IWG is reviewing the interim report and considering the recommendations. EPA looks forward to working with the IWG to respond to the recommendations and will continue to follow IWG guidance on SC-CO<sub>2</sub>.

The four global SC-CO<sub>2</sub> estimates are as follows: \$13, \$46, \$68, and \$140 per metric ton of CO<sub>2</sub> emissions in the year 2020 (2013\$).<sup>836</sup> The first three values are based on the average SC-CO<sub>2</sub> from the three IAMs, at discount rates of 5, 3, and 2.5 percent, respectively. SC-CO<sub>2</sub> estimates for several discount rates are included because the literature shows that the SC-CO<sub>2</sub> is quite sensitive to assumptions about the discount rate, and because no consensus exists on the appropriate rate to use in an intergenerational context (where costs and benefits are incurred by different generations). The fourth value is the 95th percentile of the SC-CO<sub>2</sub> from all three models at a 3 percent discount rate. It is included to represent lower probability but higher outcomes from

<sup>834</sup> Both the 2010 SC-CO<sub>2</sub> TSD and the current TSD are available at: <https://www.whitehouse.gov/omb/oira/social-cost-of-carbon>. The 2010 SC-CO<sub>2</sub> TSD also available in the docket: Docket ID EPA-HQ-OAR-2009-0472-114577, *Technical Support Document: Social Cost of Carbon for Regulatory Impact Analysis Under Executive Order 12866*, Interagency Working Group on Social Cost of Carbon, with participation by the Council of Economic Advisers, Council on Environmental Quality, Department of Agriculture, Department of Commerce, Department of Energy, Department of Transportation, Environmental Protection Agency, National Economic Council, Office of Energy and Climate Change, Office of Management and Budget, Office of Science and Technology Policy, and Department of Treasury (February 2010). Also available at: <http://www.whitehouse.gov/sites/default/files/omb/inforeg/for-agencies/Social-Cost-of-Carbon-for-RIA.pdf>.

<sup>835</sup> See <https://www.whitehouse.gov/sites/default/files/omb/inforeg/scc-response-to-comments-final-july-2015.pdf>.

<sup>836</sup> The current SC-CO<sub>2</sub> TSD presents the SC-CO<sub>2</sub> estimates in \$2007. These estimates were adjusted to 2013\$ using the GDP Implicit Price Deflator. Bureau of Economic Analysis, Table 1.1.9 Implicit Price Deflators for Gross Domestic Product; last revised on September 25, 2015.

climate change, which are captured further out in the tail of the SC-CO<sub>2</sub> distribution, and while less likely than those reflected by the average SC-CO<sub>2</sub> estimates, would be much more harmful to society and therefore, are relevant to policy makers. The SC-CO<sub>2</sub> increases over time because future emissions are expected to produce larger incremental damages as economies grow and physical and economic systems become more stressed in response to greater

climate change. The SC-CO<sub>2</sub> values are presented in Table IX–11. Applying the global SC-CO<sub>2</sub> estimates, shown in Table, to the estimated reductions in domestic CO<sub>2</sub> emissions for the program, yields estimates of the dollar value of the climate related benefits for each analysis year. These estimates are then discounted back to the analysis year using the same discount rate used to estimate the SC-CO<sub>2</sub>. For internal consistency, the annual benefits are discounted back to

net present value terms using the same discount rate as each SC-CO<sub>2</sub> estimate (*i.e.*, 5 percent, 3 percent, and 2.5 percent) rather than the discount rates of 3 percent and 7 percent used to derive the net present value of other streams of costs and benefits of the final rule.<sup>837</sup> The SC-CO<sub>2</sub> benefit estimates for each calendar year are shown in Table. The SC-CO<sub>2</sub> benefit estimates for each model year are shown in Table IX–13.

TABLE IX–11—SOCIAL COST OF CO<sub>2</sub>, 2012–2050<sup>a</sup>  
[in 2013\$ per Metric Ton]

Calendar year	5% Average	3% Average	2.5% Average	3%, 95th Percentile
2012 .....	\$12	\$36	\$58	\$100
2015 .....	12	40	62	120
2020 .....	13	46	68	140
2025 .....	15	51	75	150
2030 .....	18	55	80	170
2035 .....	20	60	86	180
2040 .....	23	66	92	200
2045 .....	25	70	98	220
2050 .....	29	76	100	230

**Note:**

<sup>a</sup> The SC-CO<sub>2</sub> values are dollar-year and emissions-year specific and have been rounded to two significant digits. Unrounded numbers from the current SC-CO<sub>2</sub> TSD were used to calculate the CO<sub>2</sub> benefits.

TABLE IX–12—UPSTREAM AND DOWNSTREAM ANNUAL CO<sub>2</sub> BENEFITS FOR THE GIVEN SC-CO<sub>2</sub> VALUE<sup>a</sup> USING METHOD B AND RELATIVE TO THE FLAT BASELINE  
[Millions of 2013\$]<sup>b</sup>

Calendar year	5% average	3% average	2.5% average	3% 95th percentile
2018 .....	\$7	\$22	\$33	\$63
2019 .....	13	46	68	130
2020 .....	21	73	110	210
2021 .....	80	280	420	840
2022 .....	170	550	820	1,700
2023 .....	250	850	1,300	2,600
2024 .....	390	1,300	2,000	4,000
2025 .....	560	1,800	2,700	5,500
2026 .....	700	2,400	3,500	7,100
2027 .....	950	3,000	4,400	9,100
2028 .....	1,100	3,700	5,400	11,000
2029 .....	1,300	4,300	6,400	13,000
2030 .....	1,600	5,000	7,300	15,000
2035 .....	2,700	8,100	11,000	25,000
2040 .....	3,700	11,000	15,000	33,000
2050 .....	5,500	15,000	20,000	45,000
NPV .....	24,000	110,000	180,000	340,000

**Notes:**

<sup>a</sup> The SC-CO<sub>2</sub> values are dollar-year and emissions-year specific.

<sup>b</sup> For an explanation of analytical Methods A and B, please see Section I.D; for an explanation of the flat baseline, 1a, and dynamic baseline, 1b, please see Section X.A.1.

<sup>837</sup> See more discussion on the appropriate discounting of climate benefits using SC-CO<sub>2</sub> in the

2010 SCC TSD. Other benefits and costs of proposed regulations unrelated to CO<sub>2</sub> emissions

are discounted at the 3% and 7% rates specified in OMB guidance for regulatory analysis.

TABLE IX-13—UPSTREAM AND DOWNSTREAM DISCOUNTED MODEL YEAR LIFETIME CO<sub>2</sub> BENEFITS FOR THE GIVEN SC-CO<sub>2</sub> VALUE USING METHOD B AND RELATIVE TO THE FLAT BASELINE

[Millions of 2013\$]<sup>a,b</sup>

Model year	5% average	3% average	2.5% average	3% 95th percentile
2018	\$38	\$150	\$230	\$450
2019	36	140	220	430
2020	34	140	220	420
2021	560	2,300	3,600	7,000
2022	590	2,500	3,900	7,500
2023	610	2,600	4,000	7,800
2024	920	4,000	6,200	12,000
2025	940	4,100	6,400	12,000
2026	950	4,200	6,600	13,000
2027	1,200	5,400	8,500	16,000
2028	1,200	5,300	8,400	16,000
2029	1,200	5,300	8,400	16,000
Sum	8,200	36,000	57,000	110,000

**Notes:**

<sup>a</sup> The SC-CO<sub>2</sub> values are dollar-year and emissions-year specific.

<sup>b</sup> For an explanation of analytical Methods A and B, please see Section I.D; for an explanation of the flat baseline, 1a, and dynamic baseline, 1b, please see Section X.A.1.

(2) Monetized Non-CO<sub>2</sub> GHG Impacts

EPA calculated the global social benefits of CH<sub>4</sub> and N<sub>2</sub>O emissions reductions expected from the final rulemaking using estimates of the social cost of methane (SC-CH<sub>4</sub>) and the social cost of nitrous oxide (SC-N<sub>2</sub>O). Similar to the SC-CO<sub>2</sub>, the SC-CH<sub>4</sub> and SC-N<sub>2</sub>O estimate the monetary value of impacts associated with marginal changes in CH<sub>4</sub> and N<sub>2</sub>O emissions, respectively, in a given year. Each metric includes a wide range of anticipated climate impacts, such as net changes in agricultural productivity and human health, property damage from increased flood risk, and changes in energy system costs, such as reduced costs for heating and increased costs for air conditioning. The SC-CH<sub>4</sub> and SC-N<sub>2</sub>O estimates applied in this analysis were developed by Marten et al. (2014) and are discussed in greater detail below. EPA is unaware of analogous estimates of HFC-134a and has therefore presented a sensitivity analysis, separate from the

main benefit cost analysis, that approximates the benefits of HFC-134a reductions based on global warming potential (GWP) gas comparison metrics (“GWP approach”). Other unquantified non-CO<sub>2</sub> benefits are discussed in this section as well. Additional details are provided in the RIA of these rules.

(a) Monetized CH<sub>4</sub> and N<sub>2</sub>O Impacts

As discussed in the proposed rulemaking, a challenge particularly relevant to the monetization of non-CO<sub>2</sub> GHG impacts is that the IWG did not estimate the social costs of non-CO<sub>2</sub> GHG emissions at the time the SC-CO<sub>2</sub> estimates were developed. While there are other estimates of the social cost of non-CO<sub>2</sub> GHGs in the peer review literature, none of those estimates are consistent with the SC-CO<sub>2</sub> estimates developed by the IWG and most are likely underestimates due to changes in the underlying science subsequent to their publication.<sup>838</sup>

However, in the time leading up to the proposal for this rulemaking, a

paper by Marten et al. (2014) provided the first set of published SC-CH<sub>4</sub> and SC-N<sub>2</sub>O estimates in the peer-reviewed literature that are consistent with the modeling assumptions the IWG used to develop the SC-CO<sub>2</sub> estimates.<sup>839</sup> Specifically, the estimation approach of Marten et al. (2014) used the same set of three IAMs, five socioeconomic-emissions scenarios, equilibrium climate sensitivity distribution, three constant discount rates, and aggregation approach used to develop the SC-CO<sub>2</sub> estimates. Marten et al. also used the same rationale as the IWG to develop global estimates of the SC-CH<sub>4</sub> and the SC-N<sub>2</sub>O, given that CH<sub>4</sub> and N<sub>2</sub>O are global pollutants.

The resulting SC-CH<sub>4</sub> and SC-N<sub>2</sub>O estimates are presented in Table IX-14. More detailed discussion of their methodology, results and a comparison to other published estimates can be found in the RIA and in Marten et al. (2014).

TABLE IX-14—SOCIAL COST OF CH<sub>4</sub> AND N<sub>2</sub>O, 2012–2050<sup>a</sup>

[In 2013\$ per metric ton] [Source: Marten et al., 2014<sup>b</sup>]

Year	SC-CH <sub>4</sub>				SC-N <sub>2</sub> O			
	5% average	3% average	2.5% average	3% 95th percentile	5% average	3% average	2.5% average	3% 95th percentile
2012	\$440	\$1,000	\$1,400	\$2,800	\$4,000	\$14,000	\$21,000	\$36,000
2015	490	1,100	1,500	3,100	4,400	14,000	22,000	38,000
2020	590	1,300	1,800	3,500	5,200	16,000	24,000	43,000
2025	710	1,500	2,000	4,100	6,000	19,000	26,000	48,000
2030	830	1,800	2,200	4,600	6,900	21,000	30,000	54,000
2035	990	2,000	2,500	5,400	8,100	23,000	32,000	60,000

<sup>838</sup> As discussed in the RIA, there is considerable variation among these published estimates in the models and input assumptions they employ. These studies differ in the emission perturbation year, employ a wide range of constant and variable

discount rate specifications, and consider a range of baseline socioeconomic and emissions scenarios that have been developed over the last 20 years. See also Reilly and Richards, 1993; Schmalensee, 1993; Fankhauser, 1994; Marten and Newbold, 2012.

<sup>839</sup> Marten, A.L., E.A. Kopits, C.W. Griffiths, S.C. Newbold & A. Wolverton (2014). Incremental CH<sub>4</sub> and N<sub>2</sub>O mitigation benefits consistent with the U.S. Government’s SC-CO<sub>2</sub> estimates, *Climate Policy*, DOI: 10.1080/14693062.2014.912981.

TABLE IX-14—SOCIAL COST OF CH<sub>4</sub> AND N<sub>2</sub>O, 2012–2050<sup>a</sup>—Continued  
[In 2013\$ per metric ton] [Source: Marten et al., 2014<sup>b</sup>]

Year	SC-CH <sub>4</sub>				SC-N <sub>2</sub> O			
	5% average	3% average	2.5% average	3% 95th percentile	5% average	3% average	2.5% average	3% 95th percentile
2040 .....	1,100	2,200	2,900	6,000	9,200	25,000	35,000	66,000
2045 .....	1,300	2,500	3,100	6,700	10,000	27,000	37,000	73,000
2050 .....	1,400	2,700	3,400	7,400	12,000	30,000	41,000	79,000

**Notes:**

<sup>a</sup> The values are emissions-year specific and have been rounded to two significant digits. Unrounded numbers were used to calculate the GHG benefits.

<sup>b</sup> The estimates in this table have been adjusted to reflect the minor technical corrections to the SC-CO<sub>2</sub> estimates described above. See the Corrigendum to Marten et al. (2014), <http://www.tandfonline.com/doi/abs/10.1080/14693062.2015.1070550>.

In addition to requesting comment on these estimates in the proposed rulemaking, EPA noted that it had initiated a peer review of the application of the Marten et al (2014) non-CO<sub>2</sub> social cost estimates in regulatory analysis.<sup>840</sup> EPA also stated that, pending a favorable peer review, it planned to use the Marten et al (2014) estimates to monetize benefits of CH<sub>4</sub> and N<sub>2</sub>O emission reduction in the main benefit-cost analysis of the final rule.

Since then, EPA received responses that supported use of the Marten et al. estimates. Three reviewers considered seven charge questions that covered issues such as the EPA's interpretation of the Marten et al. estimates, the consistency of the estimates with the SC-CO<sub>2</sub> estimates, the EPA's characterization of the limits of the GWP-approach to value non-CO<sub>2</sub> GHG impacts, and the appropriateness of using the Marten et al. estimates in regulatory impact analyses. The reviewers agreed with the EPA's interpretation of Marten et al.'s estimates, generally found the estimates to be consistent with the SC-CO<sub>2</sub> estimates, and concurred with the limitations of the GWP approach, finding directly modeled estimates to be more appropriate. While outside of the scope of the review, the reviewers briefly considered the limitations in the SC-CO<sub>2</sub> methodology (e.g., those discussed earlier in this section) and noted that because the SC-CO<sub>2</sub> and SC-CH<sub>4</sub> and SC-N<sub>2</sub>O methodologies are similar, the limitations also apply to the resulting SC-CH<sub>4</sub> and SC-N<sub>2</sub>O estimates.

Two of the reviewers concluded that use of the SC-CH<sub>4</sub> and SC-N<sub>2</sub>O estimates developed by Marten et al. and published in the peer-reviewed literature is appropriate in RIAs, provided that the Agency discuss the limitations, similar to the discussion provided for SC-CO<sub>2</sub> and other economic analyses. All three reviewers encouraged continued improvements in the SC-CO<sub>2</sub> estimates and suggested that as those improvements are realized they should also be reflected in the SC-CH<sub>4</sub> and SC-N<sub>2</sub>O estimates, with one reviewer suggesting the SC-CH<sub>4</sub> and SC-N<sub>2</sub>O estimates lag this process. The EPA supports continued improvement in the SC-CO<sub>2</sub> estimates developed by the U.S. government and agrees that improvements in the SC-CO<sub>2</sub> estimates should also be reflected in the SC-CH<sub>4</sub> and SC-N<sub>2</sub>O estimates. The fact that the reviewers agree that the SC-CH<sub>4</sub> and SC-N<sub>2</sub>O estimates are generally consistent with the SC-CO<sub>2</sub> estimates that are recommended by OMB's guidance on valuing CO<sub>2</sub> emissions reductions, leads the EPA to conclude that use of the SC-CH<sub>4</sub> and SC-N<sub>2</sub>O estimates is an analytical improvement over excluding CH<sub>4</sub> and N<sub>2</sub>O emissions from the monetized portion of the benefit cost analysis.

The EPA also carefully considered the full range of public comments and associated technical issues on the Marten et al. estimates received in this rulemaking and determined that it would continue to use the estimates in the final rulemaking analysis. Based on the evaluation of the public comments

on this rulemaking, the favorable peer review of the application of Marten et al. estimates, and past comments urging EPA to value non-CO<sub>2</sub> GHG impacts in its rulemakings, EPA concluded that the estimates represent the best scientific information on the impacts of climate change available in a form appropriate for incorporating the damages from incremental CH<sub>4</sub> and N<sub>2</sub>O emissions changes into regulatory analysis and has included those benefits in the main benefits analysis. Please see RTC Section 11.8 for detailed responses to the comments on non-CO<sub>2</sub> GHG valuation.

The application of directly modeled estimates from Marten et al. (2014) to benefit-cost analysis of a regulatory action is analogous to the use of the SC-CO<sub>2</sub> estimates. Specifically, the SC-CH<sub>4</sub> and SC-N<sub>2</sub>O estimates in Table IX-15 are used to monetize the benefits of changes in CH<sub>4</sub> and N<sub>2</sub>O emissions expected as a result of the final rulemaking. Forecast changes in CH<sub>4</sub> and N<sub>2</sub>O emissions in a given year resulting from the regulatory action are multiplied by the SC-CH<sub>4</sub> and SC-N<sub>2</sub>O estimate for that year, respectively. To obtain a present value estimate, the monetized stream of future non-CO<sub>2</sub> benefits are discounted back to the analysis year using the same discount rate used to estimate the social cost of the non-CO<sub>2</sub> GHG emission changes.

The CH<sub>4</sub> and N<sub>2</sub>O benefits based on Marten et al. (2014) are presented for each calendar year in Table IX-15.

<sup>840</sup> For a copy of the peer review and the responses, see [https://cfpub.epa.gov/si/si\\_public\\_](https://cfpub.epa.gov/si/si_public_)

[pra\\_view.cfm?dirEntryID=291976](#) (see "SCCH<sub>4</sub> EPA PEER REVIEW FILES.PDF").

TABLE IX-15—ANNUAL UPSTREAM AND DOWNSTREAM NON-CO<sub>2</sub> GHG BENEFITS FOR THE GIVEN SC-NON-CO<sub>2</sub> VALUE USING METHOD B AND RELATIVE TO THE FLAT BASELINE, USING THE DIRECTLY MODELED APPROACH<sup>a,b</sup>[Millions of 2012\$]<sup>c</sup>

Calendar year	CH <sub>4</sub>				N <sub>2</sub> O			
	5% Average	3% Average	2.5% Average	3% 95th percentile	5% Average	3% Average	2.5% Average	3% 95th percentile
2018 .....	\$0	\$1	\$1	\$2	\$0	\$0	\$0	\$0
2019 .....	1	1	2	3	0	0	0	0
2020 .....	1	2	3	5	0	0	0	0
2021 .....	4	8	11	22	0	0	1	1
2022 .....	7	16	21	43	0	1	1	2
2023 .....	12	26	33	68	0	1	2	3
2024 .....	19	40	52	110	1	2	3	5
2025 .....	26	56	72	150	1	3	4	7
2026 .....	34	72	92	190	1	3	5	9
2027 .....	44	94	120	250	1	4	6	11
2028 .....	54	120	150	300	2	5	7	13
2029 .....	65	140	170	360	2	6	9	16
2030 .....	76	160	200	420	2	7	10	19
2035 .....	130	260	340	720	4	12	16	31
2040 .....	180	360	460	980	6	16	22	41
2050 .....	280	530	660	1,400	9	22	30	58
NPV .....	1,200	3,800	5,400	10,000	37	160	250	430

**Notes:**<sup>a</sup> The SC-CH<sub>4</sub> and SC-N<sub>2</sub>O values are dollar-year and emissions-year specific.<sup>b</sup> Note that net present discounted values of reduced GHG emissions is are calculated differently than other benefits. The same discount rate used to discount the value of damages from future emissions (SC-CH<sub>4</sub> and SC-N<sub>2</sub>O at 5, 3, and 2.5 percent) is used to calculate net present value discounted values of SC-CH<sub>4</sub> and SC-N<sub>2</sub>O for internal consistency. Refer to the 2010 SC-CO<sub>2</sub> TSD for more detail.<sup>c</sup> For an explanation of analytical Methods A and B, please see Section I.D; for an explanation of the flat baseline, 1a, and dynamic baseline, 1b, please see Section X.A.1.**(b) Sensitivity Analysis—HFC-134a Benefits Based on the GWP Approximation Approach**

While the rulemaking will result in reductions of HFC-134a, EPA is unaware of analogous estimates of the social cost of HFC-134a and has therefore used an alternative valuation approach and presented the results in this sensitivity analysis, separate from the main benefit cost analysis. Specifically, EPA has used the global warming potential (GWP) for HFC-134a to convert the emissions of this gas to CO<sub>2</sub> equivalents, which are then valued using the SC-CO<sub>2</sub> estimates. This approach, henceforth referred to as the “GWP approach,” has been used in sensitivity analyses to estimate the non-CO<sub>2</sub> benefits in previous EPA rulemakings (see U.S. EPA 2012, 2013).<sup>841</sup> EPA has not presented these

<sup>841</sup> U.S. EPA. (2012). “Regulatory impact analysis supporting the 2012 U.S. Environmental Protection Agency final new source performance standards and amendments to the national emission standards for hazardous air pollutants for the oil and natural gas industry.” Retrieved from [http://www3.epa.gov/ttn/ecas/regdata/RIAs/oil\\_natural\\_gas\\_final\\_neshap\\_nsp\\_ria.pdf](http://www3.epa.gov/ttn/ecas/regdata/RIAs/oil_natural_gas_final_neshap_nsp_ria.pdf). U.S. EPA. (2013). “Regulatory

estimates in a main benefit-cost analysis due to the limitations associated with using the GWP approach to value changes in non-CO<sub>2</sub> GHG emissions, and considered the GWP approach as an interim method of analysis until social cost estimates for non-CO<sub>2</sub> GHGs, consistent with the SC-CO<sub>2</sub> estimates, were developed.

The GWP is a simple, transparent, and well-established metric for assessing the relative impacts of non-CO<sub>2</sub> emissions compared to CO<sub>2</sub> on a purely physical basis. However, as discussed both in the 2010 SC-CO<sub>2</sub> TSD and previous rulemakings (e.g., U.S. EPA 2012, 2013), the GWP approximation approach to measuring non-CO<sub>2</sub> GHG benefits has several well-documented limitations. These metrics are not ideally suited for use in benefit-cost analyses to approximate the social cost of non-CO<sub>2</sub> GHGs because the approach would assume all subsequent linkages leading to damages are linear in radiative

impact analysis: Final rulemaking for 2017–2025 light-duty vehicle greenhouse gas emission standards and corporate average fuel economy standards.” Retrieved from <http://www3.epa.gov/otaq/climate/documents/420r12016.pdf>.

forcing, which would be inconsistent with the most recent scientific literature. Detailed discussion of limitations of the GWP approach can be found in the RIA.

EPA applies the GWP approach to estimate the benefits associated with reductions of HFCs in each calendar year. Under the GWP Approach, EPA converted HFC-134a to CO<sub>2</sub> equivalents using the AR4 100-year GWP for HFC-134a (1,430).<sup>842</sup> These CO<sub>2</sub>-equivalent emission reductions are multiplied by the SC-CO<sub>2</sub> estimate corresponding to each year of emission reductions. As with the calculation of annual benefits of CO<sub>2</sub> emission reductions, the annual benefits of non-CO<sub>2</sub> emission reductions based on the GWP approach are discounted back to net present value terms using the same discount rate as each SC-CO<sub>2</sub> estimate. The estimated HFC-134a benefits using the GWP approach are presented in Table IX-16.

<sup>842</sup> Source: Table 2.14 (Errata). Lifetimes, radiative efficiencies and direct (except for CH<sub>4</sub>) GWPs relative to CO<sub>2</sub>. IPCC Fourth Assessment Report “Climate Change 2007: Working Group I: The Physical Science Basis.”



# FEDERAL REGISTER

---

Vol. 81                      Tuesday,  
No. 206                     October 25, 2016

Book 2 of 2 Books

Pages 73881–74278

---

Part II—Continued

## Environmental Protection Agency

---

40 CFR Parts 9, 22, 85, et al.

## Department of Transportation

---

National Highway Traffic Safety Administration

49 CFR Parts 523, 534, 535, et al.

Greenhouse Gas Emissions and Fuel Efficiency Standards for Medium- and Heavy-Duty Engines and Vehicles—Phase 2; Final Rule



TABLE IX-16—ANNUAL UPSTREAM AND DOWNSTREAM HFC-134a BENEFITS FOR THE GIVEN SC-CO<sub>2</sub> VALUE USING METHOD B AND RELATIVE TO THE FLAT BASELINE, USING THE GWP APPROACH<sup>a,b</sup>[Millions of 2013\$]<sup>b</sup>

Calendar year	HFC-134a			
	5% Average	3% Average	2.5% Average	3%, 95th Percentile
2018	\$0	\$0	\$0	\$0
2019	\$0	\$0	\$0	\$0
2020	\$0	\$0	\$0	\$0
2021	\$0	\$1	\$1	\$3
2022	\$1	\$2	\$3	\$5
2023	\$1	\$3	\$4	\$8
2024	\$1	\$4	\$5	\$11
2025	\$1	\$5	\$7	\$14
2026	\$2	\$6	\$9	\$18
2027	\$2	\$7	\$10	\$21
2028	\$3	\$8	\$12	\$25
2029	\$3	\$10	\$14	\$29
2030	\$4	\$11	\$16	\$33
2035	\$5	\$15	\$22	\$47
2040	\$6	\$18	\$25	\$54
2050	\$9	\$23	\$31	\$70
NPV	\$44	\$200	\$320	\$620

**Notes:**<sup>a</sup>The SC-CO<sub>2</sub> values are dollar-year and emissions-year specific.<sup>b</sup>For an explanation of analytical Methods A and B, please see Section I.D; for an explanation of the flat baseline, 1a, and dynamic baseline, 1b, please see Section X.A.1.(c) Additional Non-CO<sub>2</sub> GHGs Co-Benefits

In determining the relative social costs of the different gases, the Marten et al. (2014) analysis accounts for differences in lifetime and radiative efficiency between the non-CO<sub>2</sub> GHGs and CO<sub>2</sub>. The analysis also accounts for radiative forcing resulting from methane's effects on tropospheric ozone and stratospheric water vapor, and for at least some of the fertilization effects of elevated carbon dioxide concentrations. However, there exist several other differences between these gases that have not yet been captured in this analysis, for example the non-radiative effects of methane-driven elevated tropospheric ozone levels on human health, agriculture, and ecosystems, and the effects of carbon dioxide on ocean acidification. Inclusion of these additional non-radiative effects would potentially change both the absolute and relative value of the various gases.

Of these effects, the human health effect of elevated tropospheric ozone levels resulting from methane emissions is the closest to being monetized in a way that would be comparable to the SCC. Premature ozone-related cardiopulmonary deaths resulting from global increases in tropospheric ozone concentrations produced by the methane oxidation process have been the focus of a number of studies over the

past decade (e.g., West et al. 2006;<sup>843</sup> Anenberg et al. 2012;<sup>844</sup> Shindell et al. 2012<sup>845</sup>). Recently, a paper was published in the peer-reviewed scientific literature that presented a range of estimates of the monetized ozone-related mortality benefits of reducing methane emissions (Sarofim et al. 2015). For example, under their base case assumptions using a 3 percent discount rate, Sarofim et al. find global ozone-related mortality benefits of methane emissions reductions to be \$790 per ton of methane in 2020, with 10.6 percent, or \$80, of this amount resulting from mortality reductions in the United States. The methodology used in this study is consistent in some (but not all) aspects with the modeling underlying the SC-CO<sub>2</sub> and SC-CH<sub>4</sub> estimates discussed above, and required a number of additional assumptions such as baseline mortality rates and

<sup>843</sup> West JJ, Fiore AM, Horowitz LW, Mauzerall DL (2006) Global health benefits of mitigating ozone pollution with methane emission controls. *Proc Natl Acad Sci USA* 103 (11):3988–3993. doi:10.1073/pnas.0600201103

<sup>844</sup> Anenberg SC, Schwartz J, Shindell D, Amann M, Faluvegi G, Klimont Z, . . . , Vignati E (2012) Global air quality and health co-benefits of mitigating near-term climate change through methane and black carbon emission controls. *Environ Health Perspect* 120 (6):831. doi:10.1289/ehp.1104301.

<sup>845</sup> Shindell D, Kuylenstierna JCI, Vignati E, van Dingenen R, Amann M, Klimont Z, . . . , Fowler D (2012) Simultaneously Mitigating Near-Term Climate Change and Improving Human Health and Food Security. *Science* 335 (6065):183–189. doi:10.1126/science.1210026.

mortality response to ozone concentrations. While the EPA does consider the methane impacts on ozone to be important, there remain unresolved questions regarding several methodological choices involved in applying the Sarofim et al. (2015) approach in the context of an EPA benefits analysis, and therefore the EPA is not including a quantitative analysis of this effect in this rule at this time.

*H. Monetized Non-GHG Health Impacts*

This section discusses the economic benefits from reductions in health and environmental impacts resulting from non-GHG emission reductions that can be expected to occur as a result of the Phase 2 standards. CO<sub>2</sub> emissions are predominantly the byproduct of fossil fuel combustion processes that also produce criteria and hazardous air pollutant emissions. The vehicles that are subject to the Phase 2 standards are also significant sources of mobile source air pollution such as direct PM, NO<sub>x</sub>, VOCs and air toxics. The standards will affect exhaust emissions of these pollutants from vehicles and will also affect emissions from upstream sources that occur during the refining and distribution of fuel. Changes in ambient concentrations of ozone, PM<sub>2.5</sub>, and air toxics that will result from the Phase 2 standards are expected to affect human health by reducing premature deaths and other serious human health effects, as well as other important improvements in public health and

welfare. Children especially benefit from reduced exposures to criteria and toxic pollutants, because they tend to be more sensitive to the effects of these respiratory pollutants. Ozone and particulate matter have been associated with increased incidence of asthma and other respiratory effects in children, and particulate matter has been associated with a decrease in lung maturation. Some minority groups and children living under the poverty line are even more vulnerable with higher prevalence of asthma.

It is important to quantify the health and environmental impacts associated with the standards because a failure to adequately consider ancillary impacts could lead to an incorrect assessment of their costs and benefits. Moreover, the health and other impacts of exposure to criteria air pollutants and airborne toxics tend to occur in the near term, while most effects from reduced climate change are likely to occur only over a time frame of several decades or longer.

Impacts such as emissions reductions, costs and benefits are presented in this analysis from two perspectives:

- A “model year lifetime analysis” (MY), which shows impacts of the program that occur over the lifetime of the vehicles produced during the model years subject to the Phase 2 standards (MYs 2018 through 2029).
- A “calendar year analysis” (CY), which shows annual costs and benefits of the Phase 2 standards for each year from 2018 through 2050. We assume the standard in the last model year subject to the standards applies to all subsequent MY fleets developed in the future.

In previous light-duty and heavy-duty GHG rulemakings, EPA has quantified and monetized non-GHG health impacts using two different methods. For the MY analysis, EPA applies PM-related “benefits per-ton” values to the stream of lifetime estimated emission reductions as a reduced-form approach to estimating the PM<sub>2.5</sub>-related benefits of the rule.<sup>846</sup> For the CY analysis, EPA typically conducts full-scale photochemical air quality modeling to quantify and monetize the PM<sub>2.5</sub>- and

ozone-related health impacts of a single representative future year. EPA then assumes these benefits are repeated in subsequent future years when criteria pollutant emission reductions are equal to or greater than those modeled in the representative future year.

This two-pronged approach to estimating non-GHG impacts is precipitated by the length of time needed to prepare the necessary emissions inventories and the processing time associated with full-scale photochemical air quality modeling for a *single* representative future year. The timing requirements (along with other resource limitations) preclude EPA from being able to do the more detailed photochemical modeling for every year that we include in our benefit and cost estimates, and require EPA to make air quality modeling input decisions early in the analytical process. As a result, it was necessary to use emissions from the proposed program to conduct the air quality modeling.

The chief limitation when using air quality inventories based on emissions from the proposal in the CY modeling analysis is that they can diverge from the estimated emissions of the final rulemaking. How much the emissions might diverge and how that difference would impact the air quality modeling and health benefit results is difficult to anticipate. For the FRM, EPA concluded that when comparing the proposal and final rule inventories, the differences were enough to justify the move of the typical CY benefits analysis (based on air quality modeling) from the primary estimate of costs and benefits to a supplemental analysis in an appendix to the RIA (See RIA Appendix 8.A).<sup>848</sup> While we believe this supplemental analysis is still illustrative of the standard’s potential benefits, EPA has instead chosen to characterize the CY benefits in a manner consistent with the MY lifetime analysis. That is, we apply the PM-related “benefits per-ton” values to the CY final rule emission reductions to estimate the PM-related benefits of the final rule.

This section presents the benefits-per-ton values used to monetize the benefits from reducing population exposure to PM associated with the standards. EPA bases its analyses on peer-reviewed studies of air quality and health and welfare effects and peer-reviewed studies of the monetary values of public health and welfare improvements, and is generally consistent with benefits analyses performed for the analysis of

the final Tier 3 Vehicle Rule,<sup>849</sup> the final 2012 p.m. NAAQS Revision,<sup>850</sup> and the final 2017–2025 Light Duty Vehicle GHG Rule.<sup>851</sup>

EPA is also requiring that rebuilt engines installed in new incomplete vehicles (*i.e.*, “glider kit” vehicles) meet the emission standards applicable in the year of assembly of the new vehicle, including all applicable standards for criteria pollutants (Section XIII.B). For the final rule, EPA has updated its analysis of the environmental impacts of these glider kit vehicles (see Section XIII.B.1). These standards will decrease PM and NO<sub>x</sub> emissions dramatically, leading to substantial public health-related benefits. Although we only present these benefits as a sensitivity analysis in Section XIII.B, it is clear that removing even a fraction of glider kit vehicles from the road will yield substantial health-related benefits that are not captured by the primary estimate of monetized non-GHG health impacts described in this section.

#### (1) Economic Value of Reductions in Particulate Matter

As described in Section VIII, the standards will reduce emissions of several criteria and toxic pollutants and their precursors. In this analysis, EPA only estimates the economic value of the human health benefits associated with the resulting reductions in PM<sub>2.5</sub> exposure. Due to analytical limitations with the benefit per ton method, this analysis does not estimate benefits resulting from reductions in population exposure to other criteria pollutants such as ozone.<sup>852</sup> Furthermore, the

<sup>849</sup> U.S. Environmental Protection Agency. (2014). *Control of Air Pollution from Motor Vehicles: Tier 3 Motor Vehicle Emission and Fuel Standards Final Rule: Regulatory Impact Analysis*, Assessment and Standards Division, Office of Transportation and Air Quality, EPA-420-R-14-005, March 2014. Available on the internet: <http://www3.epa.gov/otaq/documents/tier3/420r14005.pdf>.

<sup>850</sup> U.S. Environmental Protection Agency. (2012). *Regulatory Impact Analysis for the Final Revisions to the National Ambient Air Quality Standards for Particulate Matter*, Health and Environmental Impacts Division, Office of Air Quality Planning and Standards, EPA-452-R-12-005, December 2012. Available on the internet: <http://www3.epa.gov/ttnecas1/regdata/RIAs/finalria.pdf>.

<sup>851</sup> U.S. Environmental Protection Agency (U.S. EPA). (2012). *Regulatory Impact Analysis: Final Rulemaking for 2017–2025 Light-Duty Vehicle Greenhouse Gas Emission Standards and Corporate Average Fuel Economy Standards*, Assessment and Standards Division, Office of Transportation and Air Quality, EPA-420-R-12-016, August 2012. Available on the Internet at: <http://www3.epa.gov/otaq/climate/documents/420r12016.pdf>.

<sup>852</sup> The air quality modeling that underlies the PM-related benefit per ton values also produced estimates of ozone levels attributable to each sector. However, the complex non-linear chemistry governing ozone formation prevented EPA from developing a complementary array of ozone benefit

<sup>846</sup> Fann, N., Baker, K.R., and Fulcher, C.M. (2012). *Characterizing the PM<sub>2.5</sub>-related health benefits of emission reductions for 17 industrial, area and mobile emission sectors across the U.S.*, Environment International, 49, 241–151, published online September 28, 2012.

<sup>847</sup> See also: <http://www3.epa.gov/airquality/benmap/sabpt.html>. The current values available on the Web page have been updated since the publication of the Fann et al., 2012 paper. For more information regarding the updated values, see: [http://www3.epa.gov/airquality/benmap/models/Source\\_Apportment\\_BPT\\_TSD\\_1\\_31\\_13.pdf](http://www3.epa.gov/airquality/benmap/models/Source_Apportment_BPT_TSD_1_31_13.pdf) (accessed September 9, 2014).

<sup>848</sup> Chapter 5 of the RIA has more detail on the differences between the air quality and final inventories.

benefits per-ton method, like all air quality impact analyses, does not monetize all of the potential health and welfare effects associated with reduced concentrations of PM<sub>2.5</sub>.

This analysis uses estimates of the benefits from reducing the incidence of the specific PM<sub>2.5</sub>-related health impacts described below. These estimates, which are expressed per ton of PM<sub>2.5</sub>-related emissions eliminated by the final program, represent the monetized value of human health benefits (including reductions in both premature mortality and premature morbidity) from reducing each ton of directly emitted PM<sub>2.5</sub> or its precursors (SO<sub>2</sub> and NO<sub>x</sub>), from a specified source. Ideally, the human health benefits would be estimated based on changes in ambient

PM<sub>2.5</sub> as determined by full-scale air quality modeling. However, the length of time needed to prepare the necessary emissions inventories, in addition to the processing time associated with the modeling itself, has precluded us from performing air quality modeling that reflects the emissions and air quality impacts associated with the final program.

EPA received comment regarding the omission of ozone-related benefits from the non-GHG benefits analysis included in the proposal. EPA agrees that total benefits are underestimated when ozone-related benefits are not included in the primary analysis. However, for reasons described in the introduction to this section, PM- and ozone-related health benefits based on air quality

modeling for the CY analysis are not included in the primary estimate of costs and benefits. Instead, they can be found as a supplemental analysis to the RIA in Appendix 8A.

The PM-related dollar-per-ton benefit estimates used in this analysis are provided in Table IX–17. As the table indicates, these values differ among pollutants, and also depend on their original source, because emissions from different sources can result in different degrees of population exposure and resulting health impacts. In the summary of costs and benefits, Section IX.K of this Preamble, EPA presents the monetized value of PM-related improvements associated with the final program.

TABLE IX–17—PM-RELATED BENEFITS-PER-TON VALUES  
[Thousands, 2013\$]<sup>a</sup>

Year <sup>c</sup>	On-road mobile sources			Upstream sources <sup>d</sup>		
	Direct PM <sub>2.5</sub>	SO <sub>2</sub>	NO <sub>x</sub>	Direct PM <sub>2.5</sub>	SO <sub>2</sub>	NO <sub>x</sub>
<b>Estimated Using a 3 Percent Discount Rate<sup>b</sup></b>						
2016 .....	\$380–\$870	\$20–\$46	\$7.8–\$18	\$330–\$760	\$71–\$160	\$6.9–\$16
2020 .....	410–920	22–50	8.2–18	350–800	76–170	7.5–17
2025 .....	450–1,000	25–56	9.0–20	400–890	84–190	8.2–18
2030 .....	490–1,100	28–62	9.7–22	430–960	92–200	8.9–20
<b>Estimated Using a 7 Percent Discount Rate<sup>b</sup></b>						
2016 .....	\$340–\$780	\$18–\$42	\$7.1–\$16	\$300–\$680	\$64–\$140	\$6.3–\$14
2020 .....	370–830	20–45	7.5–17	320–730	68–150	6.7–15
2025 .....	410–920	22–50	8.1–18	350–800	76–170	7.4–17
2030 .....	440–990	25–56	8.8–20	380–870	82–180	8.0–18

**Notes:**

<sup>a</sup> The benefit-per-ton estimates presented in this table are based on a range of premature mortality estimates derived from the ACS study (Krewski et al., 2009) and the Six-Cities study (Lepeule et al., 2012). See Chapter VIII of the RIA for a description of these studies.

<sup>b</sup> The benefit-per-ton estimates presented in this table assume either a 3 percent or 7 percent discount rate in the valuation of premature mortality to account for a twenty-year segmented premature mortality cessation lag.

<sup>c</sup> Benefit-per-ton values were estimated for the years 2016, 2020, 2025 and 2030. We hold values constant for intervening years (e.g., the 2016 values are assumed to apply to years 2017–2019; 2020 values for years 2021–2024; 2030 values for years 2031 and beyond).

<sup>d</sup> We assume for the purpose of this analysis that total “upstream emissions” are most appropriately monetized using the refinery sector benefit per-ton values. The majority of upstream emission reductions associated with the final rule are related to domestic onsite refinery emissions and domestic crude production. While total upstream emissions also include storage and transport sources, as well as sources upstream from the refinery, we have chosen to simply apply the refinery values.

The benefit-per-ton technique has been used in previous analyses, including EPA’s 2017–2025 Light-Duty Vehicle Greenhouse Gas Rule,<sup>853</sup> the

Reciprocating Internal Combustion Engine rules,<sup>854</sup> 855 and the Residential Wood Heaters NSPS,<sup>856</sup> Table IX–18 shows the quantified PM<sub>2.5</sub>-related co-

benefits captured in those benefit per-ton estimates, as well as unquantified effects the benefit per-ton estimates are unable to capture.

per ton values. This limitation notwithstanding, we anticipate that the ozone-related benefits associated with reducing emissions of NO<sub>x</sub> and VOC are substantial. Refer to RIA Appendix 8.A for the ozone benefits results from the supplemental CY benefits analysis.

<sup>853</sup> U.S. Environmental Protection Agency (U.S. EPA). (2012). *Regulatory Impact Analysis: Final Rulemaking for 2017–2025 Light-Duty Vehicle Greenhouse Gas Emission Standards and Corporate Average Fuel Economy Standards*, Assessment and Standards Division, Office of Transportation and Air Quality, EPA–420–R–12–016, August 2012.

Available on the Internet at: <http://www3.epa.gov/otaq/climate/documents/420r12016.pdf>.

<sup>854</sup> U.S. Environmental Protection Agency (U.S. EPA). (2013). *Regulatory Impact Analysis for the Reconsideration of the Existing Stationary Compression Ignition (CI) Engines NESHAP*, Office of Air Quality Planning and Standards, Research Triangle Park, NC. January. EPA–452/R–13–001. Available at [http://www3.epa.gov/ttnecas1/regdata/RIAs/RICE\\_NESHAPReconsideration\\_Compression\\_Ignition\\_Engines\\_RIA\\_final2013\\_EPA.pdf](http://www3.epa.gov/ttnecas1/regdata/RIAs/RICE_NESHAPReconsideration_Compression_Ignition_Engines_RIA_final2013_EPA.pdf).

<sup>855</sup> U.S. Environmental Protection Agency (U.S. EPA). (2013). *Regulatory Impact Analysis for Reconsideration of Existing Stationary Spark*

*Ignition (SI) RICE NESHAP*, Office of Air Quality Planning and Standards, Research Triangle Park, NC. January. EPA–452/R–13–002. Available at [http://www3.epa.gov/ttnecas1/regdata/RIAs/NESHAP\\_RICE\\_Spark\\_Ignition\\_RIA\\_finalreconsideration2013\\_EPA.pdf](http://www3.epa.gov/ttnecas1/regdata/RIAs/NESHAP_RICE_Spark_Ignition_RIA_finalreconsideration2013_EPA.pdf).

<sup>856</sup> U.S. Environmental Protection Agency (U.S. EPA). (2015). *Regulatory Impact Analysis for Residential Wood Heaters NSPS Revision*. Office of Air Quality Planning and Standards, Research Triangle Park, NC. February. EPA–452/R–15–001. Available at <http://www2.epa.gov/sites/production/files/2015-02/documents/20150204-residential-wood-heaters-ria.pdf>.

TABLE IX-18—HUMAN HEALTH AND WELFARE EFFECTS OF PM<sub>2.5</sub>

Pollutant/ effect	Quantified and monetized in primary estimates	Unquantified effects changes in:
PM <sub>2.5</sub> .....	Adult premature mortality ..... Acute bronchitis ..... Hospital Admissions: Respiratory and cardiovascular ..... Emergency room visits for asthma ..... Nonfatal heart attacks (myocardial infarction) ..... Lower and upper respiratory illness ..... Minor restricted-activity days ..... Work loss days ..... Asthma exacerbations (asthmatic population). Infant mortality.	Chronic and subchronic bronchitis cases. Strokes and cerebrovascular disease. Low birth weight. Pulmonary function. Chronic respiratory diseases other than chronic bronchitis. Non-asthma respiratory emergency room visits. Visibility. Household soiling.

A more detailed description of the benefit-per-ton estimates is provided in Chapter 8 of the RIA that accompanies this rulemaking. Readers interested in reviewing the complete methodology for creating the benefit-per-ton estimates used in this analysis can consult EPA’s “Technical Support Document: Estimating the Benefit per Ton of Reducing PM<sub>2.5</sub> Precursors from 17 Sectors.”<sup>857</sup> Readers can also refer to Fann et al. (2012)<sup>858</sup> for a detailed description of the benefit-per-ton methodology.

As Table IX-17 indicates, EPA projects that the per-ton values for reducing emissions of non-GHG pollutants from both vehicle use and upstream sources such as fuel refineries will increase over time.<sup>859</sup> These projected increases reflect rising income levels, which increase affected individuals’ willingness to pay for reduced exposure to health threats from air pollution.<sup>860</sup> They also reflect future population growth and increased life expectancy, which expands the size of the population exposed to air pollution in both urban and rural areas, especially

<sup>857</sup> For more information regarding the updated values, see: [http://www3.epa.gov/airquality/benmap/models/Source\\_Apportionment\\_BPT\\_TSD\\_1\\_31\\_13.pdf](http://www3.epa.gov/airquality/benmap/models/Source_Apportionment_BPT_TSD_1_31_13.pdf) (accessed September 9, 2014).

<sup>858</sup> Fann, N., Baker, K.R., and Fulcher, C.M. (2012). *Characterizing the PM<sub>2.5</sub>-related health benefits of emission reductions for 17 industrial, area and mobile emission sectors across the U.S.*, Environment International, 49, 241–151, published online September 28, 2012.

<sup>859</sup> As we discuss in the emissions chapter of the RIA (Chapter V), the rule will yield emission reductions from upstream refining and fuel distribution due to decreased petroleum consumption.

<sup>860</sup> The issue is discussed in more detail in the 2012 p.m. NAAQS RIA. See U.S. Environmental Protection Agency. (2012). *Regulatory Impact Analysis for the Final Revisions to the National Ambient Air Quality Standards for Particulate Matter*, Health and Environmental Impacts Division, Office of Air Quality Planning and Standards, EPA-452-R-12-005, December 2012. Available on the internet: <http://www3.epa.gov/ttnecas1/regdata/RIAs/finalria.pdf>.

among older age groups with the highest mortality risk.<sup>861</sup>

(2) Unquantified Health and Environmental Impacts

One commenter supported the inclusion of all quantifiable impacts of reductions in non-GHG pollutants. Specifically, they suggested the inclusion of ecosystem benefits from reduced non-GHG pollutants including those to crops as well as consideration of the impacts on toxic air contaminants such as diesel PM.

In addition to the PM-related co-pollutant health impacts EPA quantifies in this analysis, EPA acknowledges that there are a number of other health and human welfare endpoints that we are not able to quantify or monetize because of current limitations in the methods or available data. These impacts are associated with emissions of air toxics (including benzene, 1,3-butadiene, formaldehyde, acetaldehyde, acrolein, naphthalene and ethanol), ambient ozone, and ambient PM<sub>2.5</sub> exposures. Chapter 8 of the RIA lists these unquantified health and environmental impacts. While there will be impacts associated with air toxic pollutant emission changes that result from the final standard, EPA will not attempt to monetize those impacts. This is primarily because currently available tools and methods to assess air toxics risk from mobile sources at the national scale are not adequate for extrapolation to incidence estimations or benefits assessment. The best suite of tools and methods currently available for assessment at the national scale are those used in the National-Scale Air Toxics Assessment (NATA). EPA’s Science Advisory Board specifically commented in their review of the 1996 NATA that these tools were not yet ready for use in a national-scale benefits

<sup>861</sup> For more information about EPA’s population projections, please refer to the following: <http://www3.epa.gov/air/benmap/models/BenMAPManualAppendicesAugust2010.pdf> (See Appendix K).

analysis, because they did not consider the full distribution of exposure and risk, or address sub-chronic health effects.<sup>862</sup> While EPA has since improved the tools, there remain critical limitations for estimating incidence and assessing benefits of reducing mobile source air toxics.<sup>863</sup> EPA continues to work to address these limitations; however, EPA does not have the methods and tools available for national-scale application in time for the analysis of the final rules.<sup>864</sup>

I. Energy Security Impacts

The Phase 2 standards are designed to require improvements in the fuel efficiency of medium- and heavy-duty vehicles and, thereby, reduce fuel consumption and GHG emissions. In turn, the Phase 2 standards help to reduce U.S. petroleum imports. A reduction of U.S. petroleum imports reduces both financial and strategic risks caused by potential sudden disruptions in the supply of imported petroleum to the U.S., thus increasing

<sup>862</sup> Science Advisory Board. 2001. NATA—Evaluating the National-Scale Air Toxics Assessment for 1996—an SAB Advisory. <http://www3.epa.gov/ttn/atw/sab/sabrev.html>.

<sup>863</sup> Examples include gaps in toxicological data, uncertainties in extrapolating results from high-dose animal experiments to estimate human effects at lower doses, limited ambient and personal exposure monitoring data, and insufficient economic research to support valuation of the health impacts often associated with exposure to individual air toxics. See Gwinn et al., 2011. Meeting Report: Estimating the Benefits of Reducing Hazardous Air Pollutants—Summary of 2009 Workshop and Future Considerations. *Environ Health Perspectives*, Jan 2011; 119(1): 125–130.

<sup>864</sup> In April, 2009, EPA hosted a workshop on estimating the benefits of reducing hazardous air pollutants. This workshop built upon the work accomplished in the June 2000 in an earlier (2000) Science Advisory Board/EPA Workshop on the Benefits of Reductions in Exposure to Hazardous Air Pollutants, which generated thoughtful discussion on approaches to estimating human health benefits from reductions in air toxics exposure, but no consensus was reached on methods that could be implemented in the near term for a broad selection of air toxics. Please visit <http://epa.gov/air/toxicair/2009workshop.html> for more information about the workshop and its associated materials.

U.S. energy security. This section summarizes the agency's estimates of U.S. oil import reductions and energy security benefits of the Phase 2 final standards. Additional discussion of this issue can be found in Chapter 8.8 of the RIA.

(1) Implications of Reduced Petroleum Use on U.S. Imports

U.S. energy security is generally considered as the continued availability of energy sources at an acceptable price. Most discussion of U.S. energy security revolves around the topic of the economic costs of U.S. dependence on oil imports. While the U.S. has reduced its consumption and increased its production of oil in recent years, it still relies on oil from potentially unstable sources. In addition, oil exporters with a large share of global production have the ability to raise the price of oil by exerting the monopoly power associated with a cartel, the Organization of Petroleum Exporting Countries (OPEC), to restrict oil supply relative to demand. These factors contribute to the vulnerability of the U.S. economy to episodic oil supply shocks and price spikes.

In 2014, U.S. expenditures for imports of crude oil and petroleum products, net of revenues for exports, were \$178 billion and expenditures on both imported oil and domestic petroleum and refined products totaled \$469 billion (in 2013\$) (see Figure IX-1).<sup>865</sup> Recently, as a result of strong growth in domestic oil production mainly from tight shale formations, U.S. production of oil has increased while U.S. oil imports have decreased. For example, from 2012 to 2015, domestic oil production increased by 44 percent while net oil imports and products decreased by 38 percent. While U.S. oil

<sup>865</sup> See EIA Annual Energy Review, various editions. For data 2011–2013, and projected data: EIA Annual Energy Outlook (AEO) 2014 (Reference Case). See Table 11, file “aetotab\_11.xls.”

import costs have declined since 2011, total oil expenditures (domestic and imported) remained near historical highs through 2014. Post-2015 oil expenditures are projected (AEO 2015) to remain between double and triple the inflation-adjusted levels experienced by the U.S. from 1986 to 2002.C

Focusing on changes in oil import levels as a source of vulnerability has been standard practice in assessing energy security in the past, but given current market trends both from domestic and international levels, adding changes in consumption of petroleum to this assessment may provide better information about U.S. energy security. The major mechanism through which the economy sustains harm due to fluctuations in the (world) energy market is through price, which itself is leveraged through both imports and consumption. However, the United States, may be increasingly insulated from the physical effects of overseas oil disruptions, though the price impacts of an oil disruption anywhere will continue to be transmitted to U.S. markets. As of 2015, Canada accounted for 63 percent of U.S. net oil imports of crude oil and petroleum products. The implications of the U.S. becoming a significant petroleum producer have yet to be discerned in the literature, but it can be anticipated that this will have some impact on energy security.

In 2010, just over 40 percent of world oil supply came from OPEC nations. The AEO 2015 projects that this share will stay high; dipping slightly from 37 percent by 2020 and then rising gradually to over 40 percent by 2035 and thereafter. Approximately 30 percent of global supply is from Middle East and North African countries alone, a share that is also expected to grow. Measured in terms of the share of world oil resources or the share of global oil export supply, rather than oil production, the concentration of global petroleum resources in OPEC nations is

even larger. As another measure of concentration, of the 137 countries/principalities that export either crude or refined products, the top 12 have recently accounted for over 55 percent of exports.<sup>866</sup> Eight of these countries are members of OPEC, and a ninth is Russia.<sup>867</sup> In a market where even a 1–2 percent supply loss can raise prices noticeably, and where a 10 percent supply loss could lead to an unprecedented price shock, this regional concentration is of concern.<sup>868</sup> Historically, the countries of the Middle East have been the source of eight of the ten major world oil disruptions,<sup>869</sup> with the ninth originating in Venezuela, an OPEC country, and the tenth being Hurricanes Katrina and Rita.

<sup>866</sup> Based on data from the CIA, combining various recent years, <https://www.cia.gov/library/publications/the-world-factbook/rankorder/2242rank.html>.

<sup>867</sup> The other three are Norway, Canada, and the EU, an exporter of product.

<sup>868</sup> For example, the 2005 Hurricanes Katrina/Rita and the 2011 Libyan conflict both led to a 1.8 percent reduction in global crude supply. While the price impact of the latter is not easily distinguished given the rapidly rising post-recession prices, the former event was associated with a 10–15 percent world oil price increase. There are a range of smaller events with smaller but noticeable impacts. Somewhat larger events, such as the 2002/3 Venezuelan Strike and the War in Iraq, corresponded to about a 2.9 percent sustained loss of supply, and were associated with a 28 percent world oil price increase.

Compiled from EIA oil price data, IEA2012 [IEA Response System for Oil Supply Emergencies ([http://www.iea.org/publications/freepublications/publication/EPPD\\_Brochure\\_English\\_2012\\_02.pdf](http://www.iea.org/publications/freepublications/publication/EPPD_Brochure_English_2012_02.pdf))

See table on P. 11 and Hamilton 2011 “Historical Oil Shocks,” ([http://econweb.ucsd.edu/~jhamilton/oil\\_history.pdf](http://econweb.ucsd.edu/~jhamilton/oil_history.pdf)) in \*Routledge Handbook of Major Events in Economic History\*, pp. 239–265, edited by Randall E. Parker and Robert Whaples, New York: Routledge Taylor and Francis Group, 2013). Available in bookstores.

<sup>869</sup> IEA 2011 “IEA Response System for Oil Supply Emergencies.”

<sup>870</sup> For historical data: EIA Annual Energy Review, various editions. For data 2011–2013, and projected data: EIA Annual Energy Outlook (AEO) 2014 (Reference Case). See Table 11, file “aetotab\_11.xls.”

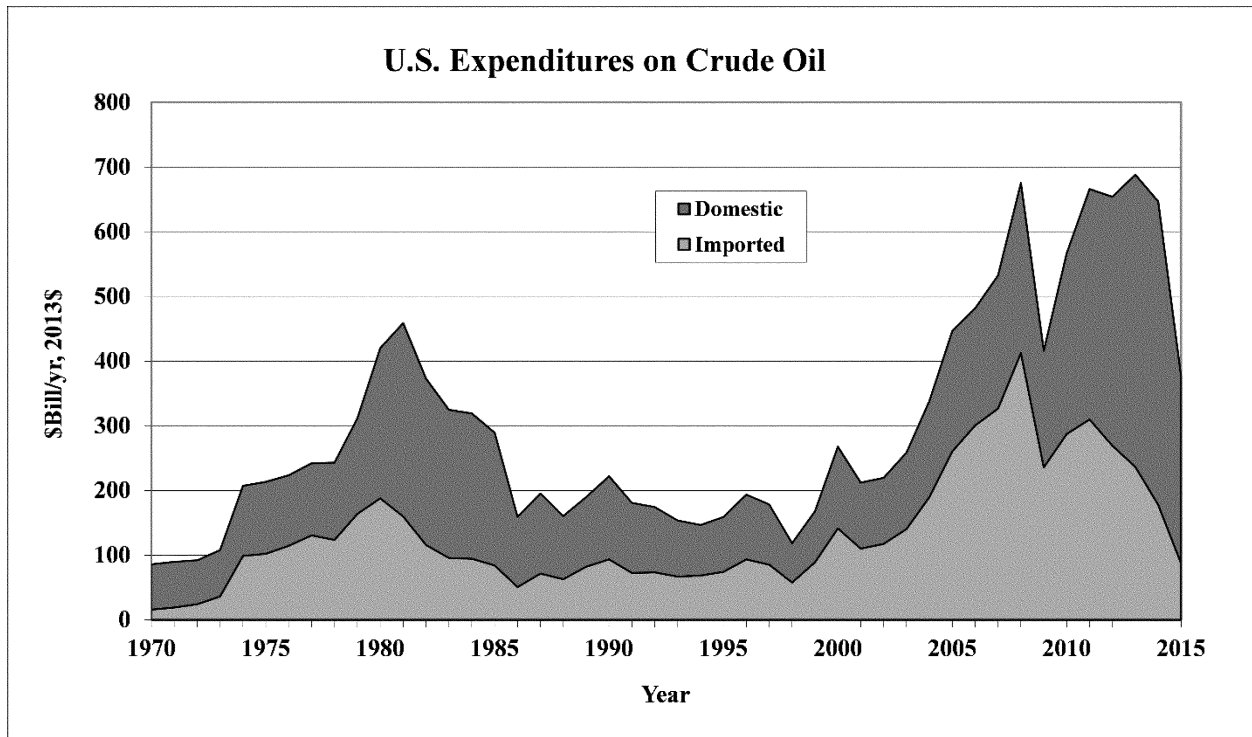

Figure IX-1 U.S. Expenditures on Crude Oil from 1970 through 2015<sup>870</sup>

The agencies used EPA’s MOVES model to estimate the reductions in U.S. fuel consumption due to these final rules for vocational vehicles and tractors. For HD pickups and vans, the agencies used both DOT’s CAFE model and EPA’s MOVES model to estimate the fuel consumption impacts. (Detailed explanations of the MOVES and CAFE models can be found in Chapter 5 of the RIA. See IX.C of the Preamble for estimates of reduced fuel consumption from these final rules). Based on a detailed analysis of differences in U.S. fuel consumption, petroleum imports, and imports of petroleum products, the

agencies estimate that approximately 90 percent of the reduction in fuel consumption resulting from adopting improved GHG emission and fuel efficiency standards is likely to be reflected in reduced U.S. imports of crude oil and net imported petroleum products.<sup>871</sup> Thus, on balance, each gallon of fuel saved as a consequence of the HD GHG and fuel efficiency standards is anticipated to reduce total U.S. imports of petroleum by 0.90 gallons. Based upon the fuel savings estimated by the MOVES/CAFE models and the 90 percent oil import factor, the reduction in U.S. oil imports and

exports from these final rules are estimated for the years 2020, 2025, 2030, 2040, and 2050 (in millions of barrels per day (MMBD)) in Table IX–19 below. For comparison purposes, Table IX–19 also shows U.S. imports of crude oil in 2020, 2025, 2030 and 2040 as projected by DOE in the Annual Energy Outlook 2015 Reference Case. U.S. Gross Domestic Product (GDP) is projected to grow by roughly 48 percent over the same time frame (e.g., from 2020 to 2040) in the AEO 2015 projections.

TABLE IX–19—PROJECTED U.S. IMPORTS AND EXPORTS OF OIL AND U.S. OIL IMPORT REDUCTIONS RESULTING FROM THE FINAL PHASE 2 PROGRAM IN 2020, 2025, 2030, 2040 AND 2050 USING METHOD B AND RELATIVE TO A FLAT BASELINE

[Millions of barrels per day (MMBD)]<sup>a</sup>

Year	U.S. oil exports	U.S. oil imports	U.S. net product imports*	U.S. net crude & product imports	U.S. oil import reductions from final HD Rules
2020 .....	0.63	6.14	–2.80	2.71	0.007
2025 .....	0.63	6.72	–3.24	2.85	0.162
2030 .....	0.63	7.07	–3.56	2.88	0.405
2040 .....	0.63	8.21	–4.26	3.32	0.721

<sup>871</sup> We looked at changes in U.S. crude oil imports and net petroleum products in the AEO 2015 Reference Case in comparison to the Low (i.e., Economic Growth) Demand Case to undertake this analysis. See the spreadsheet “Impact of Fuel

Demand on Imports AEO2015.xlsx.” We also considered a paper entitled “Effect of a U.S. Demand Reduction on Imports and Domestic Supply Levels” by Leiby, P., 4/16/2013. This paper suggests that “Given a particular reduction in oil

demand stemming from a policy or significant technology change, the fraction of oil use savings that shows up as reduced U.S. imports, rather than reduced U.S. supply, is actually quite close to 90 percent, and probably close to 95 percent.”

TABLE IX-19—PROJECTED U.S. IMPORTS AND EXPORTS OF OIL AND U.S. OIL IMPORT REDUCTIONS RESULTING FROM THE FINAL PHASE 2 PROGRAM IN 2020, 2025, 2030, 2040 AND 2050 USING METHOD B AND RELATIVE TO A FLAT BASELINE—Continued

[Millions of barrels per day (MMBD)]<sup>a</sup>

Year	U.S. oil exports	U.S. oil imports	U.S. net product imports*	U.S. net crude & product imports	U.S. oil import reductions from final HD Rules
2050 .....	(**)	(**)	(**)	(**)	0.861

**Notes:**

\* Negative U.S. Net Product Imports imply positive exports.

\*\* The AEO 2015 only projects energy market and economic trends through 2040.

(2) Energy Security Implications

In order to understand the energy security implications of reducing U.S. oil imports, EPA has worked with Oak Ridge National Laboratory (ORNL), which has developed approaches for evaluating the social costs and energy security implications of oil use. The energy security estimates provided below are based upon a methodology developed in a peer-reviewed study entitled, “*The Energy Security Benefits of Reduced Oil Use, 2006–2015*”, completed in March 2008. This ORNL study is an updated version of the approach used for estimating the energy security benefits of U.S. oil import reductions developed in a 1997 ORNL Report.<sup>872</sup> For EPA and NHTSA rulemakings, the ORNL methodology is updated periodically to account for forecasts of future energy market and economic trends reported in the U.S. Energy Information Administration’s Annual Energy Outlook.

When conducting this analysis, ORNL considered the full cost of importing petroleum into the U.S. The full economic cost is defined to include two components in addition to the purchase price of petroleum itself. These are: (1) The higher costs for oil imports resulting from the effect of U.S. demand on the world oil price (*i.e.*, the

“demand” or “monopsony” costs); and (2) the risk of reductions in U.S. economic output and disruption to the U.S. economy caused by sudden disruptions in the supply of imported oil to the U.S. (*i.e.*, macroeconomic disruption/adjustment costs).

The literature on energy security for the last two decades has routinely combined the monopsony and the macroeconomic disruption components when calculating the total value of the energy security premium. However, in the context of using a global value for the Social Cost of Carbon (SCC) the question arises: how should the energy security premium be used when some benefits from these rules, such as the benefits of reducing greenhouse gas emissions, are calculated from a global perspective? Monopsony benefits represent avoided payments by U.S. consumers to oil producers that result from a decrease in the world oil price as the U.S. decreases its demand for oil. Although there is clearly an overall benefit to the U.S. when considered from a domestic perspective, the decrease in price due to decreased demand in the U.S. also represents a loss to oil producing countries, one of which is the U.S. Given the redistributive nature of this monopsony effect from a global perspective, it is

excluded in the energy security benefits calculations for these final rules.

In contrast, the other portion of the energy security premium, the avoided U.S. macroeconomic disruption and adjustment cost that arises from reductions in U.S. petroleum imports, does not have offsetting impacts outside of the U.S., and, thus, is included in the energy security benefits estimated for these final rules. To summarize, the agencies have included only the avoided macroeconomic disruption portion of the energy security benefits to estimate the monetary value of the total energy security benefits of these final rules.

For this rulemaking, ORNL updated the energy security premiums by incorporating the most recent oil price forecast and energy market trends, particularly regional oil supplies and demands, from the AEO 2015 into its model.<sup>873</sup> ORNL developed energy security premium estimates for a number of different years. Table IX-20 provides estimates for energy security premiums for the years 2020, 2025, 2030 and 2040,<sup>874</sup> as well as a breakdown of the components of the energy security premiums for each year. The components of the energy security premiums and their values are discussed below.

TABLE IX-20—ENERGY SECURITY PREMIUMS IN 2020, 2025, 2030 AND 2040

[2013\$/Barrel]\*

Year (range)	Monopsony (range)	Avoided macroeconomic disruption/adjustment costs (range)	Total mid-point (range)
2020 .....	\$2.21 (\$0.65–\$3.59) .....	\$5.48 (\$2.51–\$8.92) .....	\$7.69 (\$4.54–\$11.14)
2025 .....	\$2.59 (\$0.76–\$4.14) .....	\$6.30 (\$2.92–\$10.22) .....	\$8.89 (\$5.22–\$12.83)
2030 .....	\$2.83 (0.83–\$4.56) .....	\$7.26 (\$3.40–\$11.73) .....	\$10.09 (\$5.90–\$14.59)

<sup>872</sup> Leiby, Paul N., Donald W. Jones, T. Randall Curlee, and Russell Lee, *Oil Imports: An Assessment of Benefits and Costs*, ORNL-6851, Oak Ridge National Laboratory, November, 1997.

<sup>873</sup> Leiby, P., Factors Influencing Estimate of Energy Security Premium for Heavy-Duty Phase 2 Final Rule, 11/1/2014, Oak Ridge National Laboratory.

<sup>874</sup> AEO 2015 forecasts energy market trends and values only to 2040. The post-2040 energy security premium values are assumed to be equal to the 2040 estimate.

TABLE IX-20—ENERGY SECURITY PREMIUMS IN 2020, 2025, 2030 AND 2040—Continued  
[2013\$/Barrel]\*

Year (range)	Monopsony (range)	Avoided macroeconomic disruption/adjustment costs (range)	Total mid-point (range)
2040 .....	\$4.09 (\$1.19–\$6.67) .....	\$9.61 (\$4.54–\$15.39) .....	\$13.69 (\$8.12–\$19.64)

**Note:**

\* Top values in each cell are the midpoints, the values in parentheses are the 90 percent confidence intervals.

(a) Effect of Oil Use on the Long-Run Oil Price

The first component of the full economic costs of importing petroleum into the U.S. follows from the effect of U.S. import demand on the world oil price over the long-run. Because the U.S. is a sufficiently large purchaser of global oil supplies, its purchases can affect the world oil price. This monopsony power means that increases in U.S. petroleum demand can cause the world price of crude oil to rise, and conversely, that reduced U.S. petroleum demand can reduce the world price of crude oil. Thus, one benefit of decreasing U.S. oil purchases, due to improvements in the fuel efficiency of medium- and heavy-duty vehicles, is the potential decrease in the crude oil price paid for all crude oil purchased.

There is disagreement in the literature about the magnitude of the monopsony component, and its relevance for policy analysis. Brown and Huntington (2013)<sup>875</sup> for example, argue that the United States' refusal to exercise its market power to reduce the world oil price does not represent a proper externality, and that the monopsony component should not be considered in calculations of the energy security externality. However, they also note in their earlier discussion paper (Brown and Huntington 2010)<sup>876</sup> that this is a departure from the traditional energy security literature, which includes sustained wealth transfers associated with stable but higher-price oil markets. On the other hand, Greene (2010)<sup>877</sup> and others in prior literature (e.g., Toman 1993)<sup>878</sup> have emphasized that

the monopsony cost component is policy-relevant because the world oil market is non-competitive and strongly influenced by cartelized and government-controlled supply decisions. Thus, while sometimes couched as an externality, Greene notes that the monopsony component is best viewed as stemming from a completely different market failure than an externality (Ledyard 2008),<sup>879</sup> yet still implying marginal social costs to importers.

Recently, the Council on Foreign Relations (i.e., "the Council") (2015) released a discussion paper that assesses NHTSA's analysis of the benefits and costs of CAFE in a lower-oil-price world.<sup>880</sup> In this paper, the Council notes that while NHTSA cites the monopsony effect of the CAFE standards for 2017–2025, NHTSA does not include it when calculating the cost-benefit calculation for the rule. The Council argues that the monopsony benefit should be included in the CAFE cost-benefit analysis and that including the monopsony benefit is more consistent with the legislators' intent in mandating CAFE standards in the first place.

The recent National Academy of Science (NAS 2015) Report, "Cost, Effectiveness and the Deployment of Fuel Economy Technologies for Light-Duty Vehicles,"<sup>881</sup> suggests that the agencies' logic about not accounting for monopsony benefits is inaccurate. According to the NAS, the fallacy lies in treating the two problems, oil dependence and climate change, similarly. According to the NAS, "Like national defense, it [oil dependence] is inherently adversarial (i.e., oil consumers against producers using

monopoly power to raise prices). The problem of climate change is inherently global and requires global action. If each nation considered only the benefits to itself in determining what actions to take to mitigate climate change, an adequate solution could not be achieved. Likewise, if the U.S. considers the economic harm its reduced petroleum use will do to monopolistic oil producers it will not adequately address its oil dependence problem. Thus, if the United States is to solve both of these problems it must take full account of the costs and benefits of each, using the appropriate scope for each problem." At this point in time, we are continuing to exclude monopsony premiums for the cost benefit analysis of these final rules, but we will be taking comment on this issue in a near term future rulemaking.

There is also a question about the ability of gradual, long-term reductions, such as those resulting from these final rules, to reduce the world oil price in the presence of OPEC's monopoly power. OPEC is currently the world's marginal petroleum supplier, and could conceivably respond to gradual reductions in U.S. demand with gradual reductions in supply over the course of several years as the fuel savings resulting from these rules grow. However, if OPEC opts for a long-term strategy to preserve its market share, rather than maintain a particular price level (as they have done recently in response to increasing U.S. petroleum production), reduced demand will create downward pressure on the global price. The Oak Ridge analysis assumes that OPEC does respond to demand reductions over the long run, but there is still a price effect in the model. Under the mid-case behavioral assumption used in the premium calculations, OPEC responds by gradually reducing supply to maintain *market share* (consistent with the long-term self-interested strategy suggested by Gately (2004, 2007)).<sup>882</sup>

<sup>882</sup>Gately, Dermot, 2004. "OPEC's Incentives for Faster Output Growth," The Energy Journal, 25

<sup>875</sup>Brown, Stephen P.A. and Hillard G. Huntington. 2013. *Assessing the U.S. Oil Security Premium*. Energy Economics, vol. 38, pp 118–127.

<sup>876</sup>Reassessing the Oil Security Premium. RFF Discussion Paper Series, (RFF DP 10–05). doi: RFF DP 10–05

<sup>877</sup>Greene, D. L. 2010. *Measuring energy security: Can the United States achieve oil independence?*, Energy Policy, 38(4), 1614–1621. doi:10.1016/j.enpol.2009.01.041.

<sup>878</sup>Toman, M., 1993, The economics of energy security: theory, evidence and policy, Chapter 25, Handbook of Natural Resources and Energy Economics, Volume 3, pp. 1167–1218.

<sup>879</sup>Ledyard, John O. "Market Failure." The New Palgrave Dictionary of Economics. Second Edition. Eds. Steven N. Durlauf and Lawrence E. Blume. Palgrave Macmillan, 2008.

<sup>880</sup>Council on Foreign Relations, "Automobile Fuel Economy Standards in a Lower-Oil-Price World," Sivarm & Levi, November 2015.

<sup>881</sup>Transitions to Alternative Vehicles and Fuels," Committee on Transitions to Alternative Vehicles and Fuels, National Research Council, 2013.



## (b) Macroeconomic Disruption Adjustment Costs

The second component of the oil import premium, “avoided macroeconomic disruption/adjustment costs,” arises from the effect of oil imports on the expected cost of supply disruptions and accompanying price increases. A sudden increase in oil prices triggered by a disruption in world oil supplies has two main effects: (1) It increases the costs of oil imports in the short-run and (2) it can lead to macroeconomic contraction, dislocation and Gross Domestic Product (GDP) losses. For example, ORNL estimates the combined value of these two factors to be \$6.30/barrel (2013\$) when U.S. oil imports are reduced in 2025, with a range from \$2.92/barrel to \$10.22/barrel of imported oil reduced.

Since future disruptions in foreign oil supplies are an uncertain prospect, each of the disruption cost components must be weighted by the probability that the supply of petroleum to the U.S. will actually be disrupted. Thus, the “expected value” of these costs—the product of the probability that a supply disruption will occur and the sum of costs from reduced economic output and the economy’s abrupt adjustment to sharply higher petroleum prices—is the relevant measure of their magnitude. Further, when assessing the energy security value of a policy to reduce oil use, it is only the change in the expected costs of disruption that results from the policy that is relevant. The expected costs of disruption may change from lowering the normal (*i.e.*, pre-disruption) level of domestic petroleum use and imports, from any induced alteration in the likelihood or size of disruption, or from altering the short-run flexibility (*e.g.*, elasticity) of petroleum use.

By late 2015/early 2016, world oil prices were sharply lower than in 2014. Future prices remain uncertain, but sustained markedly lower oil prices can have mixed implications for U.S. energy security. Under lower prices U.S. expenditures on oil consumption are lower, and they are a less prominent component of the U.S. economy. This would lessen the issue of imported oil as an energy security problem for the U.S. On the other hand, sustained lower oil prices encourage greater oil consumption, and reduce the competitiveness of new U.S. oil supplies and alternative fuels. The AEO 2015 low oil price outlook, for example, projects that by 2030 total U.S.

petroleum supply would be 10 percent lower and imports would be 78 percent higher than the AEO Reference Case. Under the low-price case, 2030 prices are 35 percent lower, so that import expenditures are 16 percent higher.

A second potential proposed energy security effect of lower oil prices is increased instability of supply, due to greater global reliance on fewer supplying nations,<sup>883</sup> and because lower prices may increase economic and geopolitical instability in some supplier nations.<sup>884 885 886</sup> The International Monetary Fund reported that low oil prices are creating substantial economic tension in the Middle East oil producers on top of the economic costs of ongoing conflicts, and noted the risk that Middle East countries including Saudi Arabia could run out of financial assets without substantial change in policy.<sup>887</sup> The concern raised is that oil revenues are essential for some exporting nations to fund domestic programs and avoid domestic unrest.

The Competitive Enterprise Institute (CEI) and others argue that there are little, if any, energy security benefits associated with these rules. In large part CEI argues that oil supplies are plentiful and that current oil prices are low so that reduced consumption of petroleum

products due to these rules would have no effect on energy security. However, the discussion of current low oil prices (“lowest Labor Day gasoline prices in a decade”) does not assure the absence of future oil supply shocks or price shocks, or even speak to their reduced likelihood. CEI points out that the current low oil prices have been observed before as recently as a decade ago, as they have in more than one instance before that. For example, oil prices were even lower in 1999. But in the intervening periods, oil supply and price shocks have continued to recur, and the recent price record only amplifies oil’s high historical price volatility.

Also, sharply lower world oil prices do not clearly imply greater energy security for the U.S. Current low world oil prices may reduce the U.S.’s fracking industry’s tight oil production (as CEI points out), or other sources of oil supplies around the world. Some have hypothesized that reduction in oil production outside of OPEC may be the objective of some OPEC producers. With low oil prices, U.S.’ oil import share over time might be larger, increasing the U.S.’ dependence on imported oil.

Securing America’s Future Energy (SAFE), Operation Free and the Investor Network on Climate Risk agree that these rules do improve America’s energy security. SAFE goes on to state that several policy options should be included in these rules to further enhance energy security. The agencies agree that these rules enhances America’s energy security, but do not have information to evaluate the policy options that SAFE proposes.

The recent economics literature on whether oil shocks are the threat to economic stability that they once were is mixed. Some of the current literature asserts that the macroeconomic component of the energy security externality is small. For example, the National Research Council (2009) argued that the non-environmental externalities associated with dependence on foreign oil are small, and potentially trivial.<sup>888</sup> Analyses by Nordhaus (2007) and Blanchard and Gali (2010) question the impact of more recent oil price shocks on the economy.<sup>889</sup> They were motivated by

<sup>883</sup> Fatih Birol, Executive Director of the International Energy Agency, warns that prolonged lower oil prices would trigger energy security concerns by increasing reliance on a small number of low-cost producers “or risk a sharp rebound in price if investment falls short.” “It would be a grave mistake to index our attention to energy security to changes in the oil price,” Birol said. “Now is not the time to relax. Quite the opposite: a period of low oil prices is the moment to reinforce our capacity to deal with future energy security threats.” Hussain, Y. (2015). “Grave mistake” to be complacent on energy security, International Energy Agency warns. *Financial Post*, (November 10). Retrieved from <http://business.financialpost.com/news/energy/grave-mistake-to-be-complacent-on-energy-security-international-energy-agency-warns>.

<sup>884</sup> Batovic, A. (2015). *Low oil prices fuel political and economic instability*. *Global Risk Insights*, 18–19. Retrieved from <http://globalriskinsights.com/2015/09/low-oil-prices-fuel-political-and-economic-instability/>.

<sup>885</sup> Monaldi, F. (2015). The Impact of the Decline in Oil Prices on the Economics, Politics and Oil Industry of Venezuela. *Columbia Center on Global Energy Policy Discussion Papers*, (September). Retrieved from [http://energypolicy.columbia.edu/sites/default/files/energy/Impact of the Decline in Oil Prices on Venezuela](http://energypolicy.columbia.edu/sites/default/files/energy/Impact%20of%20the%20Decline%20in%20Oil%20Prices%20on%20Venezuela.pdf), September 2015.pdf.

<sup>886</sup> Even, S., & Guzansky, Y. (2015). *Falling oil prices and Saudi stability—Opinion*. *Jerusalem Post*, (September 30). Retrieved from <http://www.jpost.com/Opinion/Falling-oil-prices-and-Saudi-stability-419534>.

<sup>887</sup> International Monetary Fund (IMF). (2015). *IMF Regional Economic Outlook—Middle East and Central Asia. Regional Economic Outlook* (Vol. 33). Tomkiw, L. (2015). Oil Rich Saudi Arabia Running Out Of Assets? IMF Report Says It’s Possible In Next 5 Years. *International Business Times*, October 21, 19–22. Retrieved from <http://www.ibtimes.com/oil-rich-saudi-arabia-running-out-assets-imf-report-says-its-possible-next-5-years-215017>.

<sup>888</sup> National Research Council, 2009. *Hidden Costs of Energy: Unpriced Consequences of Energy Production and Use*. National Academy of Science, Washington, DC.

<sup>889</sup> See, William Nordhaus, “Who’s Afraid of a Big Bad Oil Shock?”, available at [http://aida.econ.yale.edu/~nordhaus/homepage/Big\\_Bad\\_Oil\\_Shock\\_Meeting.pdf](http://aida.econ.yale.edu/~nordhaus/homepage/Big_Bad_Oil_Shock_Meeting.pdf), and Olivier Blanchard and Jordi Gali, “The macroeconomic Effects of Oil price Shocks: Why are the 2000s so different from the

(2):75–96; Gately, Dermot, 2007. “What Oil Export Levels Should We Expect From OPEC?”, *The Energy Journal*, 28(2):151–173.

attempts to explain why the economy actually expanded immediately after the last shocks, and why there was no evidence of higher energy prices being passed on through higher wage inflation. Using different methodologies, they conclude that the economy has largely gotten over its concern with dramatic swings in oil prices.

One reason, according to Nordhaus, is that monetary policy has become more accommodating to the price impacts of oil shocks. Another is that consumers have simply decided that such movements are temporary, and have noted that price impacts are not passed on as inflation in other parts of the economy. He also notes that real changes to productivity due to oil price increases are incredibly modest,<sup>890</sup> and that the general direction of the economy matters a great deal regarding how the economy responds to a shock. Estimates of the impact of a price shock on aggregate demand are insignificantly different from zero.

Blanchard and Gali (2010) contend that improvements in monetary policy (as noted above), more flexible labor markets, and lessening of energy intensity in the economy, combined with an absence of concurrent shocks, all contributed to lessen the impact of oil shocks after 1980. They find “. . . the effects of oil price shocks have changed over time, with steadily smaller effects on prices and wages, as well as on output and employment.”<sup>891</sup> In a comment at the chapter's end, this work is summarized as follows: “The message of this chapter is thus optimistic in that it suggests a transformation in U.S. institutions has inoculated the economy against the responses that we saw in the past.”

At the same time, the implications of the “Shale Oil Revolution” are now being felt in the international markets, with current prices at four year lows. Analysts generally attribute this result in part to the significant increase in supply resulting from U.S. production, which has put liquid petroleum production roughly on par with Saudi Arabia. The price decline is also

1970s?”, pp. 373–421, in *The International Dimensions of Monetary Policy*, Jordi Gali and Mark Gertler, editors, University of Chicago Press, February 2010, available at <http://www.nber.org/chapters/c0517.pdf>.

<sup>890</sup> In fact, “. . . energy-price changes have no effect on multifactor productivity and very little effect on labor productivity.” Page 19. He calculates the productivity effect of a doubling of oil prices as a decrease of 0.11 percent for one year and 0.04 percent a year for ten years. Page 5. (The doubling reflects the historical experience of the post-war shocks, as described in Table 7.1 in Blanchard and Gali, p. 380).

<sup>891</sup> Blanchard and Gali, p. 414.

attributed to the sustained reductions in U.S. consumption and global demand growth from fuel efficiency policies and previously high oil prices. The resulting decrease in foreign imports, down to about one-third of domestic consumption (from 60 percent in 2005, for example<sup>892</sup>), effectively permits U.S. supply to act as a buffer against artificial or other supply restrictions (the latter due to conflict or a natural disaster, for example).

However, other papers suggest that oil shocks, particularly sudden supply shocks, remain a concern. Both Blanchard and Gali's and Nordhaus work were based on data and analysis through 2006, ending with a period of strong global economic growth and growing global oil demand. The Nordhaus work particularly stressed the effects of the price increase from 2002–2006 that were comparatively gradual (about half the growth rate of the 1973 event and one-third that of the 1990 event). The Nordhaus study emphasizes the robustness of the U.S. economy during a time period through 2006. This time period was just before rapid further increases in the price of oil and other commodities with oil prices more-than-doubling to over \$130/barrel by mid-2008, only to drop after the onset of the largest recession since the Great Depression.

Hamilton (2012) reviewed the empirical literature on oil shocks and suggested that the results are mixed, noting that some work (e.g. Rasmussen and Roitman (2011) finds less evidence for economic effects of oil shocks, or declining effects of shocks (Blanchard and Gali 2010), while other work continues to find evidence regarding the economic importance of oil shocks. For example, Baumeister and Peersman (2011) found that an oil price increase had a decreasing effect over time. But they note that with a declining price-elasticity of demand that a given physical oil disruption would have a bigger effect on price and a similar effect on output as in the earlier data.<sup>893</sup> Hamilton observes that “a negative effect of oil prices on real output has also been reported for a number of other countries, particularly when nonlinear functional forms have been employed”. Alternatively, rather than a declining

<sup>892</sup> See, Oil price Drops on Oversupply, <http://www.oil-price.net/en/articles/oil-price-drops-on-oversupply.php>, 10/6/2014.

<sup>893</sup> Hamilton, J. D. (2012). *Oil Prices, Exhaustible Resources, and Economic Growth*. In *Handbook of Energy and Climate Change*. Retrieved from [http://econweb.ucsd.edu/~jhamilton/handbook\\_climate.pdf](http://econweb.ucsd.edu/~jhamilton/handbook_climate.pdf).

effect, Ramey and Vine (2010)<sup>894</sup> found “remarkable stability in the response of aggregate real variables to oil shocks once we account for the extra costs imposed on the economy in the 1970s by price controls and a complex system of entitlements that led to some rationing and shortages.”

Some of the recent literature on oil price shocks has emphasized that economic impacts depend on the nature of the oil shock, with differences between price increases caused by sudden supply loss and those caused by rapidly growing demand. Most recent analyses of oil price shocks have confirmed that “demand-driven” oil price shocks have greater effects on oil prices and tend to have positive effects on the economy while “supply-driven” oil shocks still have negative economic impacts (Baumeister, Peersman and Van Robays (2010)).<sup>895</sup> A recent paper by Kilian and Vigfusson (2014),<sup>896</sup> for example, assigned a more prominent role to the effects of price increases that are unusual, in the sense of being beyond range of recent experience. Kilian and Vigfusson also conclude that the difference in response to oil shocks may well stem from the different effects of demand- and supply-based price increases: “One explanation is that oil price shocks are associated with a range of oil demand and oil supply shocks, some of which stimulate the U.S. economy in the short run and some of which slow down U.S. growth (see Kilian (2009)). How recessionary the response to an oil price shock is thus depends on the average composition of oil demand and oil supply shocks over the sample period.”

The general conclusion that oil supply-driven shocks reduce economic output is also reached in a recently published paper by Cashin et al. (2014)<sup>897</sup> for 38 countries from 1979–2011. “The results indicate that the economic consequences of a supply-driven oil-price shock are very different from those of an oil-demand shock

<sup>894</sup> Ramey, V. and Vine, D., 2010, “Oil, Automobiles, and the U.S. Economy: How Much have Things Really Changed?” National Bureau of Economic Research Working Papers, WP 16067. Retrieved from <http://www.nber.org/papers/w16067.pdf> [EPA-HQ-OAR-2014-0827-0601].

<sup>895</sup> Baumeister, C., Peersman, G., Van Robays, I., 2010, “The Economic Consequences of Oil Shocks: Differences across Countries and Time”, Workshop and Conference on Inflation Challenges in the Era of Relative Price Shocks.

<sup>896</sup> Kilian, L., Vigfusson, R.J., 2014, “The Role of Oil Price Shocks in Causing U.S. Recessions”, Board of Governors of the Federal Reserve System. International Finance Discussion Papers.

<sup>897</sup> Cashin, P., Mohaddes, K., Raissi, Maziar, and Raissi, M., 2014, “The differential effects of oil demand and supply shocks on the global economy”. *Energy Economics*.

driven by global economic activity, and vary for oil-importing countries compared to energy exporters,” and “oil importers [including the U.S.] typically face a long-lived fall in economic activity in response to a supply-driven surge in oil prices” but almost all countries see an increase in real output for an oil-demand disturbance. Note that the energy security premium calculation in this analysis is based on price shocks from potential future supply events only.

Finally, despite continuing uncertainty about oil market behavior and outcomes and the sensitivity of the U.S. economy to oil shocks, it is generally agreed that it is beneficial to reduce petroleum fuel consumption from an energy security standpoint. It is not just imports alone, but both imports and consumption of petroleum from all sources and their role in economic activity, that may expose the U.S. to risk from price shocks in the world oil price. Reducing fuel consumption reduces the amount of domestic economic activity associated with a commodity whose price depends on volatile international markets.

(c) Cost of Existing U.S. Energy Security Policies

The last often-identified component of the full economic costs of U.S. oil imports are the costs to the U.S. taxpayers of existing U.S. energy security policies. The two primary examples are maintaining the Strategic Petroleum Reserve (SPR) and maintaining a military presence to help secure a stable oil supply from potentially vulnerable regions of the world. The SPR is the largest stockpile of government-owned emergency crude oil in the world. Established in the aftermath of the 1973/1974 oil embargo, the SPR provides the U.S. with a response option should a disruption in commercial oil supplies threaten the U.S. economy. It also allows the U.S. to meet part of its International Energy Agency obligation to maintain emergency oil stocks, and it provides a national defense fuel reserve. While the costs for building and maintaining the SPR are more clearly related to U.S. oil use and imports, historically these costs have not varied in response to changes in U.S. oil import levels. Thus, while the effect of the SPR in moderating price shocks is factored into the ORNL analysis, the cost of maintaining the SPR is excluded.

U.S. military costs are excluded from the analysis performed by ORNL because their attribution to particular missions or activities is difficult, and because it is not clear that these outlays

would decline in response to incremental reductions in U.S. oil imports. Most military forces serve a broad range of security and foreign policy objectives. The agencies also recognize that attempts to attribute some share of U.S. military costs to oil imports are further challenged by the need to estimate how those costs might vary with incremental variations in U.S. oil imports.

In the proposal to these rules, the agencies solicited comments on quantifying the military benefits from reduced U.S. imports of oil. The California Air Resources Board (CARB) notes that the National Research Council (NRC)<sup>898</sup> attempted to estimate the military costs associated with U.S. imports and consumption of petroleum. The NRC cited estimates of the national defense costs of oil dependence from the literature that range from less than \$5 to \$50 billion per year or more. Assuming a range of approximate range of \$10 to \$50 billion per year, the NRC divided national defense costs by a projected U.S. consumption rate of approximately 6.4 billion barrels per year (EIA, 2012). This procedure yielded a range of average national defense cost of \$1.50–\$8.00 per barrel (rounded to the nearest \$0.50), with a mid-point of \$5/barrel (in 2009\$). The agencies acknowledge this NRC study, but have not included the estimates as part of the cost-benefit analysis for these rules.

(3) Energy Security Benefits of This Program

Using the ORNL “oil premium” methodology, updating world oil price values and energy trends using AEO 2015 and using the estimated fuel savings from these final rules estimated from the MOVES/CAFE models, the agencies have calculated the annual energy security benefits of these final rules through 2050.<sup>899</sup> Since the agencies are taking a global perspective with respect to valuing greenhouse gas benefits from the rules, only the avoided macroeconomic adjustment/disruption portion of the energy security premium is used in the energy security benefits estimates present below. These results are shown below in Table IX–21. The agencies have also calculated the net present value at 3 percent and 7 percent discount rates of model year lifetime benefits associated with energy security;

<sup>898</sup> National Research Council, “Transitions to alternative vehicles and fuels,” 2013.

<sup>899</sup> In order to determine the energy security benefits beyond 2040, we use the 2040 energy security premium multiplied by the estimate fuel savings from the final rule. Since the AEO 2015 only goes to 2040, we only calculate energy security premiums to 2040.

these values are presented in Table IX–22.

TABLE IX–21—ANNUAL U.S. ENERGY SECURITY BENEFITS OF THE FINAL PROGRAM AND NET PRESENT VALUES AT 3% AND 7% DISCOUNT RATES USING METHOD B AND RELATIVE TO A FLAT BASELINE FOR FINAL HDV RULES

[In Millions of 2013\$]<sup>a</sup>

Year	Benefits (2013\$)
2018	\$4
2019	9
2020	14
2021	55
2022	109
2023	171
2024	268
2025	372
2026	482
2027	627
2028	775
2029	923
2030	1,074
2035	1,847
2040	2,533
2050	3,025
NPV, 3%	24,716
NPV, 7%	10,050

TABLE IX–22—DISCOUNTED MODEL YEAR LIFETIME ENERGY SECURITY BENEFITS DUE TO THE FINAL PROGRAM AT 3% AND 7% DISCOUNT RATES USING METHOD B AND RELATIVE TO A FLAT BASELINE FOR FINAL HDV RULES

[Millions of 2013\$]<sup>a</sup>

Calendar year	3% Discount rate	7% Discount rate
2018	\$30	\$21
2019	29	20
2020	28	18
2021	485	294
2022	520	304
2023	552	311
2024	849	461
2025	886	464
2026	917	463
2027	1,183	577
2028	1,182	555
2029	1,184	536
Sum	7,844	4,026

J. Other Impacts

(1) Costs of Noise, Congestion and Crashes Associated With Additional (Rebound) Driving

Although it provides benefits to drivers as described above, increased vehicle use associated with the rebound effect also contributes to increased

traffic congestion, motor vehicle crashes, and highway noise. Depending on how the additional travel is distributed over the day and where it takes place, additional vehicle use can contribute to traffic congestion and delays by increasing the number of vehicles using facilities that are already heavily traveled. These added delays impose higher costs on drivers and other vehicle occupants in the form of increased travel time and operating expenses. At the same time, this additional travel also increases costs associated with traffic crashes and vehicle noise.

The agencies estimate these costs using the same methodology as used in the two light-duty and the HD Phase 1 rule analyses, which relies on estimates of congestion, crash, and noise costs imposed by automobiles and light trucks developed by the Federal Highway Administration to estimate these increased external costs caused by added driving.<sup>900</sup> We provide the details behind the estimates in Chapter 8.7 of the RIA. Table IX–23 presents the estimated annual impacts associated with crash, congestion and noise along with net present values at both 3 percent and 7 percent discount rates. Table IX–24 presents the estimated discounted model year lifetime impacts associated with crashes, congestion and noise. The methodology used in this final rule is the same as that used in the proposal, except that costs were updated to 2013 dollars.

**TABLE IX–23—ANNUAL COSTS ASSOCIATED WITH CRASHES, CONGESTION AND NOISE AND NET PRESENT VALUES AT 3% AND 7% DISCOUNT RATES USING METHOD B AND RELATIVE TO THE FLAT BASELINE**

[Millions of 2013\$]<sup>a</sup>

Calendar year	Costs of crashes, congestion, and noise
2018 .....	\$0
2019 .....	0
2020 .....	0
2021 .....	99
2022 .....	139
2023 .....	178
2024 .....	216
2025 .....	252
2026 .....	285
2027 .....	317
2028 .....	345
2029 .....	372
2030 .....	396

<sup>900</sup> These estimates were developed by FHWA for use in its 1997 Federal Highway Cost Allocation Study; <http://www.fhwa.dot.gov/policy/hcas/final/index.htm> (last accessed July 8, 2012).

**TABLE IX–23—ANNUAL COSTS ASSOCIATED WITH CRASHES, CONGESTION AND NOISE AND NET PRESENT VALUES AT 3% AND 7% DISCOUNT RATES USING METHOD B AND RELATIVE TO THE FLAT BASELINE—Continued**

[Millions of 2013\$]<sup>a</sup>

Calendar year	Costs of crashes, congestion, and noise
2035 .....	487
2040 .....	541
2050 .....	604
NPV, 3% .....	6,755
NPV, 7% .....	3,070

**Note:**

<sup>a</sup> For an explanation of analytical Methods A and B, please see Section I.D; for an explanation of the flat baseline, 1a, and dynamic baseline, 1b, please see Section X.A.1.

**TABLE IX–24—DISCOUNTED MODEL YEAR LIFETIME COSTS OF CRASHES, CONGESTION AND NOISE AT 3% AND 7% DISCOUNT RATES USING METHOD B AND RELATIVE TO THE FLAT BASELINE**

[Millions of 2013\$]<sup>a</sup>

Calendar year	3% discount rate	7% Discount rate
2018 .....	\$124	\$80
2019 .....	140	89
2020 .....	158	100
2021 .....	343	215
2022 .....	333	201
2023 .....	323	187
2024 .....	319	178
2025 .....	313	168
2026 .....	305	158
2027 .....	297	148
2028 .....	289	139
2029 .....	283	131
Sum .....	3,227	1,793

**Note:**

<sup>a</sup> For an explanation of analytical Methods A and B, please see Section I.D; for an explanation of the flat baseline, 1a, and dynamic baseline, 1b, please see Section X.A.1.

(2) Benefits Associated With Reduced Refueling Time

By reducing the frequency with which drivers typically refuel their vehicles and by extending the upper limit of the range that can be traveled before requiring refueling (*i.e.*, future fuel tank sizes remain constant), savings will be realized associated with less time spent refueling vehicles. Alternatively, refill intervals may remain the same (*i.e.*, future fuel tank sizes get smaller), resulting in the same number of refills as today but less time spent per refill

because there will be less fuel to refill. The agencies have estimated this impact using the former approach—by assuming that future tank sizes remain constant.

The savings in refueling time are calculated as the total amount of time the driver of a typical truck in each class will save each year as a consequence of pumping less fuel into the vehicle's tank. The calculation does not include any reduction in time spent searching for a fueling station or other time spent at the station; it is assumed that time savings occur only when truck operators are actually refueling their vehicles.

The calculation uses the reduced number of gallons consumed by truck type and divides that value by the tank volume and refill amount to get the number of refills, then multiplies that by the time per refill to determine the number of hours saved in a given year. The calculation then applies DOT-recommended values of travel time savings to convert the resulting time savings to their economic value, including a 1.2 percent growth rate in those time savings going forward.<sup>901</sup> The input metrics used in the analysis are presented in greater detail in RIA Chapter 9.7. The annual benefits associated with reduced refueling time are shown in Table IX–25 along with net present values at both 3 percent and 7 percent discount rates. The discounted model year lifetime benefits are shown in Table IX–26. The methodology used in this final rule is the same as that used in the proposal, except that costs have been updated to 2013 dollars.

**TABLE IX–25—ANNUAL REFUELING BENEFITS AND NET PRESENT VALUES AT 3% AND 7% DISCOUNT RATES USING METHOD B AND RELATIVE TO THE FLAT BASELINE**

[Millions of 2013\$]<sup>a</sup>

Calendar year	Refueling benefits
2018 .....	\$1
2019 .....	3
2020 .....	5
2021 .....	27
2022 .....	56
2023 .....	91
2024 .....	144
2025 .....	202
2026 .....	264
2027 .....	342
2028 .....	420
2029 .....	495
2030 .....	570
2035 .....	895
2040 .....	1,141

<sup>901</sup> U.S. Department of Transportation, Valuation of Travel Guidance, July 9, 2014, at page 14.

TABLE IX-25—ANNUAL REFUELING BENEFITS AND NET PRESENT VALUES AT 3% AND 7% DISCOUNT RATES USING METHOD B AND RELATIVE TO THE FLAT BASELINE—Continued

[Millions of 2013\$]<sup>a</sup>

Calendar year	Refueling benefits
2050 .....	1,497
NPV, 3% .....	11,985
NPV, 7% .....	4,925

**Note:**

<sup>a</sup>For an explanation of analytical Methods A and B, please see Section I.D; for an explanation of the flat baseline, 1a, and dynamic baseline, 1b, please see Section X.A.1.

TABLE IX-26—DISCOUNTED MODEL YEAR LIFETIME REFUELING BENEFITS USING METHOD B AND RELATIVE TO THE FLAT BASELINE

[Millions of 2013\$]<sup>a</sup>

Model year	3% discount rate	7% discount rate
2018 .....	\$9	\$7
2019 .....	9	6
2020 .....	8	6
2021 .....	218	135
2022 .....	255	152
2023 .....	290	166
2024 .....	428	236
2025 .....	461	245
2026 .....	491	251
2027 .....	609	300
2028 .....	601	285
2029 .....	594	272
Sum .....	3,976	2,061

**Note:**

<sup>a</sup>For an explanation of analytical Methods A and B, please see Section I.D; for an explanation of the flat baseline, 1a, and dynamic baseline, 1b, please see Section X.A.1.

(3) Benefits of Increased Travel Associated With Rebound Driving

The increase in travel associated with the rebound effect produces additional benefits to vehicle owners and operators, which reflect the value of the added (or more desirable) social and economic opportunities that become accessible with additional travel. The analysis estimates the economic benefits from increased rebound-effect driving as the sum of fuel expenditures incurred plus the consumer surplus from the additional accessibility it provides. As evidenced by the fact that vehicles make more frequent or longer trips when the cost of driving declines, the benefits from this added travel exceed added expenditures for the fuel consumed. The amount by which the benefits from this increased driving exceed its increased

fuel costs measures the net benefits from the additional travel, usually referred to as increased consumer surplus.

The agencies' analysis estimates the economic value of the increased consumer surplus provided by added driving using the conventional approximation, which is one half of the product of the decline in vehicle operating costs per vehicle-mile and the resulting increase in the annual number of miles driven. Because it depends on the extent of improvement in fuel economy, the value of benefits from increased vehicle use changes by model year and varies among alternative standards. Under even those alternatives that will impose the highest standards, however, the magnitude of the consumer surplus from additional vehicle use represents a small fraction of this benefit.

The annual benefits associated with increased travel are shown in Table IX-27 along with net present values at both 3 percent and 7 percent discount rates. The discounted model year lifetime benefits are shown in Table IX-28. The methodology used in this final rule is the same as that used in the proposal, except that costs have been updated to 2013 dollars.

TABLE IX-27—ANNUAL VALUE OF INCREASED TRAVEL AND NET PRESENT VALUES AT 3% AND 7% DISCOUNT RATES USING METHOD B AND RELATIVE TO THE FLAT BASELINE

[Millions of 2013\$]<sup>a</sup>

Calendar year	Benefits of increased travel
2018 .....	\$0
2019 .....	0
2020 .....	0
2021 .....	298
2022 .....	417
2023 .....	534
2024 .....	648
2025 .....	759
2026 .....	866
2027 .....	967
2028 .....	1,064
2029 .....	1,157
2030 .....	1,247
2035 .....	1,660
2040 .....	2,043
2050 .....	2,284
NPV, 3% .....	23,357
NPV, 7% .....	10,343

**Note:**

<sup>a</sup>For an explanation of analytical Methods A and B, please see Section I.D; for an explanation of the flat baseline, 1a, and dynamic baseline, 1b, please see Section X.A.1.

TABLE IX-28—DISCOUNTED MODEL YEAR LIFETIME VALUE OF INCREASED TRAVEL AT 3% AND 7% DISCOUNT RATES USING METHOD B AND RELATIVE TO THE FLAT BASELINE

[Millions of 2013\$]<sup>a</sup>

Calendar year	3% discount rate	7% discount rate
2018 .....	\$452	\$285
2019 .....	511	319
2020 .....	580	358
2021 .....	1,054	647
2022 .....	1,038	613
2023 .....	1,020	580
2024 .....	1,001	549
2025 .....	994	525
2026 .....	982	500
2027 .....	951	466
2028 .....	942	445
2029 .....	937	427
Sum .....	10,462	5,715

**Note:**

<sup>a</sup>For an explanation of analytical Methods A and B, please see Section I.D; for an explanation of the flat baseline, 1a, and dynamic baseline, 1b, please see Section X.A.1.

K. Summary of Benefits and Costs

This section presents the costs, benefits, and other economic impacts of the Phase 2 standards. It is important to note that NHTSA's fuel consumption standards and EPA's GHG standards will both be in effect, and will jointly lead to increased fuel efficiency and reductions in GHG and non-GHG emissions. The individual categories of benefits and costs presented in the tables below are defined more fully and presented in more detail in Chapter 8 of the RIA. These include:

- The vehicle program costs (costs of complying with the vehicle CO<sub>2</sub> and fuel consumption standards),
- changes in fuel expenditures associated with reduced fuel use by more efficient vehicles and increased fuel use associated with the "rebound" effect, both of which result from the program,
  - the global economic value of reductions in GHGs,
  - the economic value of reductions in non-GHG pollutants,
  - costs associated with increases in noise, congestion, and crashes resulting from increased vehicle use,
  - savings in drivers' time from less frequent refueling,
  - benefits of increased vehicle use associated with the "rebound" effect, and
  - the economic value of improvements in U.S. energy security impacts.

For a discussion of the cost of ownership and the agencies' payback analysis of vehicles covered by this rule, please see Section IX.M.

The agencies conducted two analyses using two analytical methods referred to as Method A and Method B. For an explanation of these methods, please see Section I.D. And as discussed in Section X.A.1, the agencies present estimates of benefits and costs that are measured against two different assumptions about improvements in fuel efficiency that

might occur in the absence of the Phase 2 standards. The first case (Alternative 1a) uses a baseline that projects very little improvement in new vehicles in the absence of new Phase 2 standards, and the second (Alternative 1b) uses a more dynamic baseline that projects more significant improvements in vehicle fuel efficiency.

Table IX–29 shows benefits and costs for these standards from the perspective of a program designed to improve the nation's energy security and conserve

energy by improving fuel efficiency. From this viewpoint, technology costs occur when the vehicle is purchased. Fuel savings are counted as benefits that occur over the lifetimes of the vehicles produced during the model years subject to the Phase 2 standards as they consume less fuel. The table shows that benefits far outweigh the costs, and the final program is anticipated to result in large net benefits to the U.S economy.

**TABLE IX–29—LIFETIME BENEFITS & COSTS OF THE FINAL PROGRAM FOR MODEL YEARS 2018–2029 VEHICLES USING ANALYSIS METHOD A**

[Billions of 2013\$ discounted at 3% and 7%]

Category	Baseline 1a		Baseline 1b	
	3%	7%	3%	7%
Vehicle Program: Technology and Indirect Costs, Normal Profit on Additional Investments .....	24.4	16.6	23.7	16.1
Additional Routine Maintenance .....	1.7	0.9	1.7	0.9
Congestion, Crashes, Fatalities and Noise from Increased Vehicle Use <sup>a</sup> .....	3.2	1.9	3.1	1.8
<b>Total Costs</b> .....	<b>29.3</b>	<b>19.4</b>	<b>28.5</b>	<b>18.8</b>
Fuel Savings (valued at pre-tax prices) .....	163.0	87.0	149.1	79.7
Savings from Less Frequent Refueling .....	3.2	1.7	3.0	1.6
Economic Benefits from Additional Vehicle Use .....	5.5	3.5	5.4	3.4
Reduced Climate Damages from GHG Emissions <sup>b</sup> .....	36.0		33.0	
Reduced Health Damages from Non-GHG Emissions .....	30.0	16.1	27.1	14.6
Increased U.S. Energy Security .....	7.9	4.2	7.3	3.9
<b>Total Benefits</b> .....	<b>246</b>	<b>149</b>	<b>225</b>	<b>136</b>
<b>Net Benefits</b> .....	<b>216</b>	<b>129</b>	<b>197</b>	<b>117</b>

**Notes:**

<sup>a</sup>“Congestion, Crashes, Fatalities and Noise from Increased Vehicle Use” includes NHTSA’s monetized value of estimated reductions in the incidence of highway fatalities associated with mass reduction in HD pickup and vans, but this does not include these reductions from tractor-trailers or vocational vehicles. This likely results in a conservative overestimate of these costs.

<sup>b</sup>Benefits and net benefits use the 3 percent average global SC-CO<sub>2</sub>, SC-CH<sub>4</sub>, and SC-N<sub>2</sub>O value applied to CO<sub>2</sub>, CH<sub>4</sub>, and N<sub>2</sub>O emissions, respectively; GHG reductions also include HFC reductions, and include benefits to other nations as well as the U.S. See RIA Chapter 8.5 and Preamble Section IX.G for further discussion.

Table IX–30 through Table IX–32 report benefits and cost from the perspective of reducing GHG. Table IX–30 shows the annual impacts and net benefits of the final program for selected

future years, together with the net present values of cumulative annual impacts from 2018 through 2050, discounted at 3 percent and 7 percent rates.

Table IX–31 and Table IX–32 show the discounted lifetime costs and benefits for each model year affected by the Phase 2 standards at 3 percent and 7 percent discount rates, respectively.

**TABLE IX–30—ANNUAL BENEFITS & COSTS OF THE FINAL PROGRAM AND NET PRESENT VALUES AT 3% AND 7% DISCOUNT RATES USING METHOD B AND RELATIVE TO THE FLAT BASELINE**

[Billions of 2013\$]<sup>a</sup>

	2018	2021	2024	2030	2035	2040	2050	NPV, 3%	NPV, 7%
Vehicle program .....	–\$0.2	–\$2.5	–\$4.2	–\$5.2	–\$5.7	–\$6.3	–\$7.3	–\$87.8	–\$41.9
Maintenance .....	0.0	0.0	–0.1	–0.2	–0.2	–0.2	–0.2	–3.2	–1.5
Pre-tax fuel .....	0.1	1.3	6.1	23.4	38.9	53.1	63.4	523.3	213.8
Energy security .....	0.0	0.1	0.3	1.1	1.8	2.5	3.0	24.7	10.1
Crashes/Congestion/Noise .....	0.0	–0.1	–0.2	–0.4	–0.5	–0.5	–0.6	–6.8	–3.1
Refueling impacts .....	0.0	0.0	0.1	0.6	0.9	1.1	1.5	12.0	4.9
Travel value .....	0.0	0.3	0.6	1.2	1.7	2.0	2.3	23.4	10.3
Non-GHG impacts .....	0.0 to	0.2 to	0.7 to	2.7 to	4.1 to	5.0 to	6.0 to	58.8 to	22.1 to 49.7
	0.0	0.5	1.8	6.8	10.1	12.5	15.0	132.0	
GHG: <sup>b c</sup>									
SC-GHG; 5% Avg .....	0.0	0.1	0.4	1.7	2.8	3.9	5.8	25.1	25.1
SC-GHG; 3% Avg .....	0.0	0.3	1.4	5.2	8.4	11.1	15.2	115.4	115.4
SC-GHG; 2.5% Avg .....	0.0	0.4	2.0	7.5	11.9	15.5	20.9	183.1	183.1
SC-GHG; 3% 95th .....	0.1	0.9	4.1	15.6	25.5	33.6	46.6	351.0	351.0

TABLE IX–30—ANNUAL BENEFITS & COSTS OF THE FINAL PROGRAM AND NET PRESENT VALUES AT 3% AND 7% DISCOUNT RATES USING METHOD B AND RELATIVE TO THE FLAT BASELINE—Continued  
[Billions of 2013\$]<sup>a</sup>

	2018	2021	2024	2030	2035	2040	2050	NPV, 3%	NPV, 7%
Net benefits:									
SC-GHG; 5% Avg .....	-0.1	-0.6	4.3	26.7	46.6	64.3	78.2	606.2	253.8
SC-GHG; 3% Avg .....	-0.1	-0.4	5.2	30.2	52.2	71.4	87.6	696.4	344.0
SC-GHG; 2.5% Avg .....	-0.1	-0.3	5.9	32.6	55.7	75.8	93.3	764.2	411.8
SC-GHG; 3% 95th .....	0.0	0.2	8.0	40.7	69.4	94.0	119.0	932.1	579.7

**Notes:**

<sup>a</sup> Positive values denote decreased social costs (benefits); negative values denote increased social costs. For an explanation of analytical Methods A and B, please see Section I.D; for an explanation of the flat baseline, 1a, and dynamic baseline, 1b, please see Section X.A.1.

<sup>b</sup> GHG benefit estimates include reductions in CO<sub>2</sub>, CH<sub>4</sub>, and N<sub>2</sub>O but do not include the HFC reductions, as discussed in Section IX.G. Net present value of reduced GHG emissions is calculated differently than other benefits. The same discount rate used to discount the value of damages from future emissions (SC-CO<sub>2</sub>, SC-CH<sub>4</sub>, and SC-N<sub>2</sub>O, each discounted at rates of 5, 3, 2.5 percent) is used to calculate net present value of SC-CO<sub>2</sub>, SC-CH<sub>4</sub>, and SC-N<sub>2</sub>O, respectively, for internal consistency. Refer to the SC-CO<sub>2</sub> TSD for more detail.

<sup>c</sup> Section IX.G notes that SC-GHG increases over time. For the years 2012–2050, the SC-CO<sub>2</sub> estimates range as follows: For Average SC-CO<sub>2</sub> at 5%: \$12–\$28; for Average SC-CO<sub>2</sub> at 3%: \$37–\$77; for Average SC-CO<sub>2</sub> at 2.5%: \$58–\$105; and for 95th percentile SC-CO<sub>2</sub> at 3%: \$105–\$237. For the years 2012–2050, the SC-CH<sub>4</sub> estimates range as follows: For Average SC-CH<sub>4</sub> at 5%: \$440–\$1,400; for Average SC-CH<sub>4</sub> at 3%: \$1,000–\$2,700; for Average SC-CH<sub>4</sub> at 2.5%: \$1,400–\$3,400; and for 95th percentile SC-CH<sub>4</sub> at 3%: \$2,800–\$7,400. For the years 2012–2050, the SC-N<sub>2</sub>O estimates range as follows: For Average SC-N<sub>2</sub>O at 5%: \$4,000–\$12,000; for Average SC-N<sub>2</sub>O at 3%: \$14,000–\$30,000; for Average SC-N<sub>2</sub>O at 2.5%: \$21,000–\$41,000; and for 95th percentile SC-N<sub>2</sub>O at 3%: \$36,000–\$79,000. Section IX.G also presents these SC-GHG estimates.

TABLE IX–31—DISCOUNTED MODEL YEAR LIFETIME BENEFITS & COSTS OF THE FINAL PROGRAM USING METHOD B AND RELATIVE TO THE FLAT BASELINE  
[Billions of 2013\$ discounted at 3%]<sup>a</sup>

	2018	2019	2020	2021	2022	2023	2024	2025	2026	2027	2028	2029	Sum
Vehicle program .....	-\$0.2	-\$0.2	-\$0.2	-\$2.1	-\$2.0	-\$2.1	-\$3.1	-\$3.0	-\$3.0	-\$3.6	-\$3.5	-\$3.4	-\$26.5
Maintenance .....	-0.01	-0.01	-0.01	-0.15	-0.16	-0.16	-0.18	-0.18	-0.17	-0.30	-0.29	-0.29	-1.9
Pre-tax fuel .....	0.7	0.7	0.6	10.7	11.4	12.0	18.5	19.1	19.7	25.3	25.2	25.1	169.1
Energy security .....	0.0	0.0	0.0	0.5	0.5	0.6	0.8	0.9	0.9	1.2	1.2	1.2	7.8
Crashes/Congestion/Noise .....	-0.1	-0.1	-0.2	-0.3	-0.3	-0.3	-0.3	-0.3	-0.3	-0.3	-0.3	-0.3	-3.2
Refueling .....	0.0	0.0	0.0	0.2	0.3	0.3	0.4	0.5	0.5	0.6	0.6	0.6	4.0
Travel value .....	0.5	0.5	0.6	1.1	1.0	1.0	1.0	1.0	1.0	1.0	0.9	0.9	10.5
Non-GHG .....	0.1 to 0.3	0.1 to 0.2	0.1 to 0.2	1.4 to 3.2	1.4 to 3.2	1.5 to 3.3	2.3 to 5.2	2.3 to 5.3	2.2 to 4.8	2.8 to 6.2	2.7 to 6.1	2.7 to 6.0	19.6 to 44.1
GHG: <sup>b,c</sup>													
SC-GHG; 5% Avg .....	0.0	0.0	0.0	0.6	0.6	0.6	1.0	1.0	1.0	1.3	1.2	1.2	8.6
SC-GHG; 3% Avg .....	0.2	0.1	0.1	2.4	2.6	2.7	4.1	4.2	4.3	5.5	5.5	5.5	37.2
SC-GHG; 2.5% Avg .....	0.2	0.2	0.2	3.7	4.0	4.2	6.4	6.6	6.8	8.7	8.6	8.6	58.3
SC-GHG; 3% 95th .....	0.5	0.4	0.4	7.2	7.7	8.0	12.3	12.7	13.1	16.8	16.7	16.6	112.5
Net benefits:													
SC-GHG; 5% Avg .....	1.1	1.1	1.1	12.8	13.7	14.3	21.8	22.7	23.1	29.6	29.5	29.5	200.2
SC-GHG; 3% Avg .....	1.2	1.2	1.2	14.6	15.6	16.3	24.9	26.0	26.4	33.9	33.8	33.7	228.8
SC-GHG; 2.5% Avg .....	1.3	1.3	1.3	16.0	17.1	17.8	27.2	28.4	28.9	37.0	36.9	36.9	249.9
SC-GHG; 3% 95th .....	1.5	1.5	1.5	19.5	20.8	21.7	33.2	34.5	35.2	45.1	44.9	44.9	304.1

**Notes:**

<sup>a</sup> Positive values denote decreased social costs (benefits); negative values denote increased social costs. For an explanation of analytical Methods A and B, please see Section I.D; for an explanation of the flat baseline, 1a, and dynamic baseline, 1b, please see Section X.A.1.c

<sup>b</sup> GHG benefit estimates include reductions in CO<sub>2</sub>, CH<sub>4</sub>, and N<sub>2</sub>O but do not include the HFC reductions, as discussed in Section IX.G. Net present value of reduced GHG emissions is calculated differently than other benefits. The same discount rate used to discount the value of damages from future emissions (SC-CO<sub>2</sub>, SC-CH<sub>4</sub>, and SC-N<sub>2</sub>O, each discounted at rates of 5, 3, 2.5 percent) is used to calculate net present value of SC-CO<sub>2</sub>, SC-CH<sub>4</sub>, and SC-N<sub>2</sub>O, respectively, for internal consistency. Refer to the SC-CO<sub>2</sub> TSD for more detail.

<sup>c</sup> Section IX.G notes that SC-GHG increases over time. For the years 2012–2050, the SC-CO<sub>2</sub> estimates range as follows: For Average SC-CO<sub>2</sub> at 5%: \$12–\$28; for Average SC-CO<sub>2</sub> at 3%: \$37–\$77; for Average SC-CO<sub>2</sub> at 2.5%: \$58–\$105; and for 95th percentile SC-CO<sub>2</sub> at 3%: \$105–\$237. For the years 2012–2050, the SC-CH<sub>4</sub> estimates range as follows: For Average SC-CH<sub>4</sub> at 5%: \$440–\$1,400; for Average SC-CH<sub>4</sub> at 3%: \$1,000–\$2,700; for Average SC-CH<sub>4</sub> at 2.5%: \$1,400–\$3,400; and for 95th percentile SC-CH<sub>4</sub> at 3%: \$2,800–\$7,400. For the years 2012–2050, the SC-N<sub>2</sub>O estimates range as follows: For Average SC-N<sub>2</sub>O at 5%: \$4,000–\$12,000; for Average SC-N<sub>2</sub>O at 3%: \$14,000–\$30,000; for Average SC-N<sub>2</sub>O at 2.5%: \$21,000–\$41,000; and for 95th percentile SC-N<sub>2</sub>O at 3%: \$36,000–\$79,000. Section IX.G also presents these SC-GHG estimates.

TABLE IX–32—DISCOUNTED MODEL YEAR LIFETIME BENEFITS & COSTS OF THE FINAL PROGRAM USING METHOD B AND RELATIVE TO THE FLAT BASELINE  
[Billions of 2013\$ discounted at 7%]<sup>a,b</sup>

	2018	2019	2020	2021	2022	2023	2024	2025	2026	2027	2028	2029	Sum
Vehicle program .....	-\$0.2	-\$0.2	-\$0.2	-\$1.6	-\$1.5	-\$1.5	-\$2.2	-\$2.0	-\$1.9	-\$2.2	-\$2.1	-\$2.0	-\$17.6
Maintenance .....	0.00	0.00	0.00	-0.10	-0.09	-0.09	-0.10	-0.10	-0.09	-0.15	-0.14	-0.13	-1.0
Pre-tax fuel .....	0.5	0.4	0.4	6.6	6.7	6.8	10.1	10.1	10.0	12.4	11.9	11.4	87.2
Energy security .....	0.0	0.0	0.0	0.3	0.3	0.3	0.5	0.5	0.5	0.6	0.6	0.5	4.0
Crashes/Congestion/Noise .....	-0.1	-0.1	-0.1	-0.2	-0.2	-0.2	-0.2	-0.2	-0.2	-0.1	-0.1	-0.1	-1.8
Refueling .....	0.0	0.0	0.0	0.1	0.2	0.2	0.2	0.2	0.3	0.3	0.3	0.3	2.1
Travel value .....	0.3	0.3	0.4	0.6	0.6	0.6	0.5	0.5	0.5	0.5	0.4	0.4	5.7
Non-GHG .....	0.1 to 0.2	0.1 to 0.1	0.1 to 0.1	0.8 to 1.8	0.8 to 1.7	0.8 to 1.7	1.1 to 2.6	1.1 to 2.5	1.0 to 2.2	1.2 to 2.7	1.2 to 2.6	1.1 to 2.5	9.2 to 20.8
GHG: <sup>b,c</sup>													
SC-GHG; 5% Avg .....	0.0	0.0	0.0	0.6	0.6	0.6	1.0	1.0	1.0	1.3	1.2	1.2	8.6
SC-GHG; 3% Avg .....	0.2	0.1	0.1	2.4	2.6	2.7	4.1	4.2	4.3	5.5	5.5	5.5	37.2
SC-GHG; 2.5% Avg .....	0.2	0.2	0.2	3.7	4.0	4.2	6.4	6.6	6.8	8.7	8.6	8.6	58.3
SC-GHG; 3% 95th .....	0.5	0.4	0.4	7.2	7.7	8.0	12.3	12.7	13.1	16.8	16.7	16.6	112.5
Net benefits:													
SC-GHG; 5% Avg .....	0.7	0.7	0.6	7.6	7.9	7.9	11.7	11.8	11.6	14.4	13.9	13.5	102.3
SC-GHG; 3% Avg .....	0.8	0.8	0.8	9.4	9.8	10.0	14.8	15.1	15.0	18.7	18.2	17.7	130.9
SC-GHG; 2.5% Avg .....	0.9	0.9	0.8	10.7	11.2	11.4	17.1	17.4	17.4	21.9	21.3	20.9	151.9
SC-GHG; 3% 95th .....	1.1	1.1	1.0	14.2	14.9	15.3	23.0	23.6	23.7	29.9	29.3	28.9	206.1

**Notes:**

<sup>a</sup> Positive values denote decreased social costs (benefits); negative values denote increased social costs. For an explanation of analytical Methods A and B, please see Section I.D; for an explanation of the flat baseline, 1a, and dynamic baseline, 1b, please see Section X.A.1.

<sup>b</sup> GHG benefit estimates include reductions in CO<sub>2</sub>, CH<sub>4</sub>, and N<sub>2</sub>O but do not include the HFC reductions, as discussed in Section IX.G. Net present value of reduced GHG emissions is calculated differently than other benefits. The same discount rate used to discount the value of damages from future emissions (SC-CO<sub>2</sub>, SC-CH<sub>4</sub>, and SC-N<sub>2</sub>O, each discounted at rates of 5, 3, 2.5 percent) is used to calculate net present value of SC-CO<sub>2</sub>, SC-CH<sub>4</sub>, and SC-N<sub>2</sub>O, respectively, for internal consistency. Refer to the SC-CO<sub>2</sub> TSD for more detail.

<sup>c</sup> Section IX.G notes that SC-GHG increases over time. For the years 2012–2050, the SC-CO<sub>2</sub> estimates range as follows: For Average SC-CO<sub>2</sub> at 5%: \$12–\$28; for Average SC-CO<sub>2</sub> at 3%: \$37–\$77; for Average SC-CO<sub>2</sub> at 2.5%: \$58–\$105; and for 95th percentile SC-CO<sub>2</sub> at 3%: \$105–\$237. For the years 2012–2050, the SC-CH<sub>4</sub> estimates range as follows: For Average SC-CH<sub>4</sub> at 5%: \$440–\$1,400; for Average SC-CH<sub>4</sub> at 3%: \$1,000–\$2,700; for Average SC-CH<sub>4</sub> at 2.5%: \$1,400–\$3,400; and for 95th percentile SC-CH<sub>4</sub> at 3%: \$2,800–\$7,400. For the years 2012–2050, the SC-N<sub>2</sub>O estimates range as follows: For Average SC-N<sub>2</sub>O at 5%: \$4,000–\$12,000; for Average SC-N<sub>2</sub>O at 3%: \$14,000–\$30,000; for Average SC-N<sub>2</sub>O at 2.5%: \$21,000–\$41,000; and for 95th percentile SC-N<sub>2</sub>O at 3%: \$36,000–\$79,000. Section IX.G also presents these SC-GHG estimates.

#### L. Employment Impacts

Executive Order 13563 (January 18, 2011) directs federal agencies to consider regulatory impacts on, among other criteria, job creation.<sup>902</sup> According to the Executive Order “Our regulatory system must protect public health, welfare, safety, and our environment while promoting economic growth, innovation, competitiveness, and job creation. It must be based on the best available science.” Analysis of employment impacts of a regulation is not part of a standard benefit-cost analysis (except to the extent that labor costs contribute to costs). Employment impacts of federal rules are of general interest, however, and have been particularly so, historically, in the auto sector during periods of challenging labor market conditions. For this reason, we are describing the connections of these standards to employment in the regulated sector, the motor vehicle manufacturing sector, as well as the motor vehicle body and trailer and motor vehicle parts manufacturing sectors.<sup>903</sup>

The overall effect of the final rules on motor vehicle sector employment depends on the relative magnitude of output and substitution effects, described below. Because we do not have quantitative estimates of the output effect, and only a partial estimate of the substitution effect, we cannot reach a quantitative estimate of the overall employment effects of the final rules on motor vehicle sector employment or even whether the total effect will be positive or negative.

According to the U.S. Bureau of Labor Statistics, in 2015, about 910,000 people in the U.S. were employed in the Motor Vehicle and Parts Manufacturing Sector (NAICS 3361, 3362, and 3363),<sup>904</sup> the

<sup>902</sup> Available at [http://www.whitehouse.gov/sites/default/files/omb/inforeg/eo12866/eo13563\\_01182011.pdf](http://www.whitehouse.gov/sites/default/files/omb/inforeg/eo12866/eo13563_01182011.pdf).

<sup>903</sup> The employment analysis in this RIA is part of EPA’s ongoing effort to “conduct continuing evaluations of potential loss or shifts of employment which may result from the administration or enforcement of [the Act]” pursuant to CAA section 321(a).

<sup>904</sup> U.S. Department of Labor, Bureau of Labor Statistics. “Automotive Industry; Employment, Earnings, and Hours.” <http://www.bls.gov/iag/tgs/iagauto.htm>, accessed 4/20/16.

directly regulated sector. The employment effects of these final rules are expected to expand beyond the regulated sector. Though some of the parts used to achieve these standards are likely to be built by motor vehicle manufacturers (including trailer manufacturers) themselves, the motor vehicle parts manufacturing sector also plays a significant role in providing those parts, and will also be affected by changes in vehicle sales. Changes in truck sales, discussed in Section IX.F.(2), could also affect employment for truck and trailer vendors. As discussed in Section IX.C., this final rule is expected to reduce the amount of fuel these vehicles use, and thus affect the petroleum refinery and supply industries as well. Finally, since the net reduction in cost associated with these final rules is expected to lead to lower transportation and shipping costs, in a competitive market a substantial portion of those cost savings will be passed along to consumers, who then will have additional discretionary income (how much of the cost is passed along to consumers depends on market structure and the relative price elasticities). The final rules are not expected to have any notable inflationary or recessionary effect.

The employment effects of environmental regulation are difficult to disentangle from other economic changes and business decisions that affect employment, over time and across regions and industries. In light of these difficulties, we lean on economic theory to provide a constructive framework for approaching these assessments and for better understanding the inherent complexities in such assessments. Neoclassical microeconomic theory describes how profit-maximizing firms adjust their use of productive inputs in response to changes in their economic conditions.<sup>905</sup> Berman and Bui (2001, pp. 274–75) model two components that drive changes in firm-level labor demand: Output effects and substitution

<sup>905</sup> See Layard, P.R.G., and A. A. Walters (1978), *Microeconomic Theory* (McGraw-Hill, Inc.), Chapter 9 (Docket ID EPA–HQ–OAR–2014–0827–0070), a standard microeconomic theory textbook treatment, for a discussion.

effects.<sup>906</sup> Regulation can affect the profit-maximizing quantity of output by changing the marginal cost of production. If regulation causes marginal cost to increase, it will place upward pressure on output prices, leading to a decrease in the quantity demanded, and resulting in a decrease in production. The output effect describes how, holding labor intensity constant, a decrease in production causes a decrease in labor demand. As noted by Berman and Bui, although many assume that regulation increases marginal cost, it need not be the case. A regulation could induce a firm to upgrade to less polluting and more efficient equipment that lowers marginal production costs, or it may induce use of technologies that may prove popular with buyers or provide positive network externalities (see Section IX.A. for discussion of this effect). In such a case, output could increase.

The substitution effect describes how, holding output constant, regulation affects labor intensity of production. Although increased environmental regulation may increase use of pollution control equipment and energy to operate that equipment, the impact on labor demand is ambiguous. For example, equipment inspection requirements, specialized waste handling, or pollution technologies that alter the production process may affect the number of workers necessary to produce a unit of output. Berman and Bui (2001) model the substitution effect as the effect of regulation on pollution control equipment and expenditures required

<sup>906</sup> Berman, E. and L. T. M. Bui (2001). “Environmental Regulation and Labor Demand: Evidence from the South Coast Air Basin.” *Journal of Public Economics* 79(2): 265–295 (Docket EPA–HQ–OAR–2014–0827–0074). The authors also discuss a third component, the impact of regulation on factor prices, but conclude that this effect is unlikely to be important for large competitive factor markets, such as labor and capital. Morgenstern, Pizer and Shih (Morgenstern, Richard D., William A. Pizer, and Jih-Shyang Shih (2002). “Jobs versus the Environment: An Industry-Level Perspective.” *Journal of Environmental Economics and Management* 43: 412–436, Docket EPA–HQ–OAR–2014–0827–0088) use a similar model, but they break the employment effect into three parts: (1) A demand effect; (2) a cost effect; and (3) a factor-shift effect.



by the regulation and the corresponding change in labor intensity of production.

In summary, as output and substitution effects may be positive or negative, theory alone cannot predict the direction of the net effect of regulation on labor demand at the level of the regulated firm. Operating within the bounds of standard economic theory, empirical estimation of net employment effects on regulated firms is possible when data and methods of sufficient detail and quality are available. The literature, however, illustrates difficulties with empirical estimation. For example, studies sometimes rely on confidential plant-level employment data from the U.S. Census Bureau, possibly combined with pollution abatement expenditure data that are too dated to be reliably informative. In addition, the most commonly used empirical methods do not permit estimation of net effects.

The conceptual framework described thus far focused on regulatory effects on plant-level decisions within a regulated industry. Employment impacts at an individual plant do not necessarily represent impacts for the sector as a whole. The approach must be modified when applied at the industry level. At the industry level, labor demand is more responsive if: (1) The price elasticity of demand for the product is high, (2) other factors of production can be easily substituted for labor, (3) the supply of other factors is highly elastic, or (4) labor costs are a large share of total production costs.<sup>907</sup> For example, if all firms in an industry are faced with the same regulatory compliance costs and product demand is inelastic, then industry output may not change much, and output of individual firms may change slightly.<sup>908</sup> In this case, the output effect may be small, while the substitution effect depends on input substitutability. Suppose, for example, that new equipment for fuel efficiency improvements requires labor to install and operate. In this case, the substitution effect may be positive, and with a small output effect, the total effect may be positive. As with potential effects for an individual firm, theory cannot determine the sign or magnitude of industry-level regulatory effects on labor demand. Determining these signs

<sup>907</sup> See Ehrenberg, Ronald G., and Robert S. Smith (2000), *Modern Labor Economics: Theory and Public Policy* (Addison Wesley Longman, Inc.), p. 108, Docket EPA-HQ-OAR-2014-0827-0077.

<sup>908</sup> This discussion draws from Berman, E. and L. T. M. Bui (2001). "Environmental Regulation and Labor Demand: Evidence from the South Coast Air Basin." *Journal of Public Economics* 79(2): 265-295 (Docket EPA-HQ-OAR-2014-0827), p. 293, Docket EPA-HQ-OAR-2014-0827-0074.

and magnitudes requires additional sector-specific empirical study. For environmental rules, much of the data needed for these empirical studies is not publicly available, would require significant time and resources in order to access confidential U.S. Census data for research, and also would not be necessary for other components of a typical RIA.

In addition to changes to labor demand in the regulated industry, net employment impacts encompass changes in other related sectors. For example, these standards are expected to increase demand for fuel-saving technologies. This increased demand may increase revenue and employment in the firms providing these technologies. At the same time, the regulated industry is purchasing the equipment, and these costs may impact labor demand at regulated firms. Therefore, it is important to consider the net effect of compliance actions on employment across multiple sectors or industries.

If the U.S. economy is at full employment, even a large-scale environmental regulation is unlikely to have a noticeable impact on aggregate net employment.<sup>909</sup> Instead, labor would primarily be reallocated from one productive use to another, and net national employment effects from environmental regulation would be small and transitory (e.g., as workers move from one job to another).<sup>910</sup> The International Union, United Automobile, Aerospace and Agricultural Implement Workers of America (UAW) commented that, when the 900,000 workers in the auto sector are combined with "jobs from other sectors that are dependent on the industry," the industry "is responsible for 7.25 million jobs nationwide, or about 3.8 percent of private-sector employment." The agencies consider the 900,000 motor-vehicle-sector jobs to be in the industry directly affected by these standards; for the reasons discussed here, the overall state of the U.S. economy is likely to have a much more significant effect on the people employed in other sectors than these standards.

<sup>909</sup> Full employment is a conceptual target for the economy where everyone who wants to work and is available to do so at prevailing wages is actively employed. The unemployment rate at full employment is not zero.

<sup>910</sup> Arrow et al. (1996). "Benefit-Cost Analysis in Environmental, Health, and Safety Regulation: A Statement of Principles." American Enterprise Institute, the Annapolis Center, and Resources for the Future, Docket EPA-HQ-OAR-2014-0827-0073. See discussion on bottom of p. 6. In practice, distributional impacts on individual workers can be important, as discussed later in this section.

Affected sectors may experience transitory effects as workers change jobs. Some workers may retrain or relocate in anticipation of new requirements or require time to search for new jobs, while shortages in some sectors or regions could bid up wages to attract workers. These adjustment costs can lead to local labor disruptions. Although the net change in the national workforce is expected to be small, localized reductions in employment may adversely impact individuals and communities just as localized increases may have positive impacts.

If the economy is operating at less than full employment, economic theory does not clearly indicate the direction or magnitude of the net impact of environmental regulation on employment; it could cause either a short-run net increase or short-run net decrease.<sup>911</sup> An important research question is how to accommodate unemployment as a structural feature in economic models. This feature may be important in assessing large-scale regulatory impacts on employment.<sup>912</sup>

Environmental regulation may also affect labor supply. In particular, pollution and other environmental risks may impact labor productivity or employees' ability to work.<sup>913</sup> While the theoretical framework for analyzing labor supply effects is analogous to that for labor demand, it is more difficult to study empirically. There is a small emerging literature described in the next section that uses detailed labor and environmental data to assess these impacts.

To summarize, economic theory provides a framework for analyzing the impacts of environmental regulation on employment. The net employment effect incorporates expected employment changes (both positive and negative) in the regulated sector and elsewhere. Labor demand impacts for regulated firms, and also for the regulated industry, can be decomposed into output and substitution effects which may be either negative or positive. Estimation of net employment effects for regulated sectors is possible when data of sufficient detail and quality are

<sup>911</sup> Schmalensee, Richard, and Robert N. Stavins. "A Guide to Economic and Policy Analysis of EPA's Transport Rule." White paper commissioned by Excelon Corporation, March 2011, Docket EPA-HQ-OAR-2014-0827-0071.

<sup>912</sup> Klaiber, H. Allen, and V. Kerry Smith (2012). "Developing General Equilibrium Benefit Analyses for Social Programs: An Introduction and Example." *Journal of Benefit-Cost Analysis* 3(2), Docket EPA-HQ-OAR-2014-0827-0086.

<sup>913</sup> E.g. Graff Zivin, J., and M. Neidell (2012). "The Impact of Pollution on Worker Productivity." *American Economic Review* 102: 3652-3673, Docket EPA-HQ-OAR-2014-0827-0092.

available. Finally, economic theory suggests that labor supply effects are also possible. In the next section, we discuss the empirical literature.

Achates Power, the American Council for an Energy-Efficient Economy, BlueGreen Alliance, Ceres, Environmental Defense Fund (EDF), Natural Resources Defense Council, and JD Gilroy expressed support for the standards' potential to increase employment in the vehicle manufacturing industry. They argued that the standards will drive new jobs, reward organizations that innovate with respect to fuel efficiency, and help maintain the U.S. position as a leader in industries related to truck manufacturing and fuel efficiency technology. Brian Mannix points out the difficulty associated with generating complete employment forecasts that include all direct and indirect effects. He concludes that the agencies are correct to be careful about estimating a definitive forecast.

Comments from the International Union, United Automobile, Aerospace and Agricultural Implement Workers of America (UAW) urge EPA and NHTSA to ensure that the standards avoid market disruptions or "pre-buy/no-buy" boom and bust cycles. UAW suggests that in the past, market disruptions caused by pre-buy in anticipation of the 2007 and 2010 NO<sub>x</sub> and PM standards contributed to the layoff of 10,000 UAW workers in 2009, though these layoffs were also partly driven by the Great Recession. As pointed out in the comments from EDF, fuel economy standards are fundamentally different from the past standards, because increases in costs for new technology are offset by fuel savings that accrue to the buyer. As a result these standards are less likely to cause disruptions to vehicle purchasing trends. Moreover, as discussed in Section IX.F.(2) above, there is no evidence to date that the HD GHG/fuel consumption rules have resulted in pre-buy/no-buys.

NAFA Fleet Management Association expressed concern that the standards would make it more difficult to hire qualified drivers and technicians, and would require additional employee training. As discussed in Section IX.A., the effects of the standards on hiring and retention of drivers and technicians are not well understood. The agencies expect that normal market forces should help to alleviate any labor shortages, whether or not they are associated with the standards. The Recreational Vehicle (RV) Industry Association expresses concern that buyers RVs do not consider fuel expenditures when purchasing vehicles; as a result, increased up-front

costs of the vehicle might reduce their sales. The RV industry was disproportionately hurt during the Great Recession and has only recently experienced a recovery.<sup>914</sup><sup>915</sup> However, one of the main drivers of the turnaround appears to be low gas prices,<sup>916</sup> which suggests that RV buyers may put some weight on fuel savings in their buying decisions; if so, the reduction in expected fuel costs may mitigate at least some of the effect of higher up-front prices.

#### (1) Current State of Knowledge Based on the Peer-Reviewed Literature

In the labor economics literature there is an extensive body of peer-reviewed empirical work analyzing various aspects of labor demand, relying on the above theoretical framework.<sup>917</sup> This work focuses primarily on the effects of employment policies, e.g. labor taxes, minimum wage, etc.<sup>918</sup> In contrast, the peer-reviewed empirical literature specifically estimating employment effects of environmental regulations is very limited. Several empirical studies<sup>919</sup> suggest that net employment

<sup>914</sup> Quiggle, Ben. "RV sales projected to be stronger in 2016 thanks to low gas prices, steady economy." *The Elkhart Truth*, March 6, 2016. <http://www.elkharttruth.com/news/business/2016/03/03/RV-sales-projected-to-be-stronger-in-2016-thanks-to-low-gas-prices-steady-economy.html>, accessed 3/28/2016, Docket EPA-HQ-OAR-2014-0827.

<sup>915</sup> Morris, Frank. "Ready For A Road Trip? RVs Are Rolling Back Into Fashion." *Morning Edition on NPR*, March 28, 2016. <http://www.npr.org/2016/03/28/468172578/ready-for-a-road-trip-rvs-are-rolling-back-into-fashion>, accessed 3/28/2016, Docket EPA-HQ-OAR-2014-0827.

<sup>916</sup> Quiggle, Ben. "RV sales projected to be stronger in 2016 thanks to low gas prices, steady economy." *The Elkhart Truth*, March 6, 2016. <http://www.elkharttruth.com/news/business/2016/03/03/RV-sales-projected-to-be-stronger-in-2016-thanks-to-low-gas-prices-steady-economy.html>, accessed 3/28/2016, Docket EPA-HQ-OAR-2014-0827.

<sup>917</sup> See Hamermesh (1993), *Labor Demand* (Princeton, NJ: Princeton University Press), Chapter 2 (Docket EPA-HQ-OAR-2014-0827-0082) for a detailed treatment.

<sup>918</sup> See Ehrenberg, Ronald G., and Robert S. Smith (2000), *Modern Labor Economics: Theory and Public Policy* (Addison Wesley Longman, Inc.), Chapter 4 (Docket EPA-HQ-OAR-2014-0827-0077), for a concise overview.

<sup>919</sup> Berman, E. and L. T. M. Bui (2001). "Environmental Regulation and Labor Demand: Evidence from the South Coast Air Basin." *Journal of Public Economics* 79(2): 265-295 (Docket EPA-HQ-OAR2014-0827-0074). Morgenstern, Richard D., William A. Pizer, and Jih-Shyang Shih. "Jobs Versus the Environment: An Industry-Level Perspective." *Journal of Environmental Economics and Management* 43 (2002): 412-436, Docket EPA-HQ-OAR-2014-0827-0088; Gray et al. (2014), "Do EPA Regulations Affect Labor Demand? Evidence from the Pulp and Paper Industry." *Journal of Environmental Economics and Management* 68: 188-202, Docket EPA-HQ-OAR-2014-0827-0080; and Ferris, Shadbegian and Wolverton (2014), "The Effect of Environmental Regulation on Power Sector Employment: Phase I of the Title IV SO<sub>2</sub> Trading

impacts may be zero or slightly positive but small even in the regulated sector. Other research suggests that more highly regulated counties may generate fewer jobs than less regulated ones.<sup>920</sup> However, since these latter studies compare more regulated to less regulated counties, they overstate the net national impact of regulation to the extent that regulation causes plants to locate in one area of the country rather than another. List et al. (2003)<sup>921</sup> find some evidence that this type of geographic relocation may be occurring. Overall, the peer-reviewed literature does not contain evidence that environmental regulation has a large impact on net employment (either negative or positive) in the long run across the whole economy.

Analytic challenges make it very difficult to accurately produce net employment estimates for the whole economy that would appropriately capture the way in which costs, compliance spending, and environmental benefits propagate through the macro-economy. Quantitative estimates are further complicated by the fact that macroeconomic models often have very little sectoral detail and usually assume that the economy is at full employment. EPA is currently in the process of seeking input from an independent expert panel on modeling economy-wide impacts, including employment effects. For more information, see: <https://federalregister.gov/a/2014-02471>.

#### (2) Employment Impacts in the Motor Vehicle and Parts Manufacturing Sector

This section describes changes in employment in the motor vehicle, trailer, and parts (hence, motor vehicle) manufacturing sectors due to these final rules. We focus on the motor vehicle manufacturing sector because it is directly regulated, and because it is likely to bear a substantial share of

Program." *Journal of the Association of Environmental and Resource Economists* 1: 521-553, Docket EPA-HQ-OAR-2014-0827-0078.

<sup>920</sup> Greenstone, M. (2002). "The Impacts of Environmental Regulations on Industrial Activity: Evidence from the 1970 and 1977 Clean Air Act Amendments and the Census of Manufactures." *Journal of Political Economy* 110(6): 1175-1219 (Docket EPA-HQ-OAR-2014-0827-0081); Walker, Reed. (2011). "Environmental Regulation and Labor Reallocation." *American Economic Review: Papers and Proceedings* 101(3): 442-447 (Docket EPA-HQ-OAR-2014-0827-0091).

<sup>921</sup> List, J. A., D. L. Millimet, P. G. Fredriksson, and W. W. McHone (2003). "Effects of Environmental Regulations on Manufacturing Plant Births: Evidence from a Propensity Score Matching Estimator." *The Review of Economics and Statistics* 85(4): 944-952 (Docket EPA-HQ-OAR2014-0827-0087).

changes in employment due to these final rules. We include discussion of effects on the parts manufacturing sector, because the motor vehicle manufacturing sector can either produce parts internally or buy them from an external supplier, and we do not have estimates of the likely breakdown of effort between the two sectors.

We follow the theoretical structure of Berman and Bui<sup>922</sup> of the impacts of regulation in employment in the regulated sectors. In Berman and Bui's (2001, p. 274–75) theoretical model, as described above, the change in a firm's labor demand arising from a change in regulation is decomposed into two main components: Output and substitution effects.<sup>923</sup> As the output and substitution effects may be both positive, both negative, or some combination, standard neoclassical theory alone does not point to a definitive net effect of regulation on labor demand at regulated firms.

Following the Berman and Bui framework for the impacts of regulation on employment in the regulated sector, we consider two effects for the motor vehicle sector: The output effect and the substitution effect.

#### (a) The Output Effect

If truck or trailer sales increase, then more people will be required to assemble trucks, trailers, and their components. If truck or trailer sales decrease, employment associated with these activities will decrease. The effects of this final rulemaking on HD vehicle sales thus depend on the perceived desirability of the new vehicles. On one hand, this final rulemaking will increase truck and trailer costs; by itself, this effect would reduce truck and trailer sales. In addition, while decreases in truck performance would also decrease sales, this program is not expected to have any negative effect on truck performance. On the other hand, this final rulemaking will reduce the fuel costs of operating

the trucks; by itself, this effect would increase truck sales, especially if potential buyers have an expectation of higher fuel prices. The agencies have not made an estimate of the potential change in truck or trailer sales. However, as discussed in IX.E., the agencies have estimated an increase in vehicle miles traveled (*i.e.*, VMT rebound) due to the reduced operating costs of trucks meeting these standards. Since increased VMT is most likely to be met with more drivers and more trucks, our projection of VMT rebound is suggestive of an increase in vehicle sales and truck driver employment (recognizing that these increases may be partially offset by a decrease in manufacturing and sales for equipment of other modes of transportation such as rail cars or barges).

#### (b) The Substitution Effect

The output effect, above, measures the effect due to new truck and trailer sales only. The substitution effect includes the impacts due to the changes in technologies needed for vehicles to meet these standards, separate from the effect on output (that is, as though holding output constant). This effect includes both changes in employment due to incorporation of abatement technologies and overall changes in the labor intensity of manufacturing. We present estimates for this effect to provide a sense of the order of magnitude of expected impacts on employment, which we expect to be small in the automotive sector, and to repeat that regulations may have positive as well as negative effects on employment.

One way to estimate this effect, given the cost estimates for complying with the final rule, is to use the ratio of workers to each \$1 million of expenditures in that sector. The use of these ratios has both advantages and limitations. It is often possible to estimate these ratios for quite specific sectors of the economy: For instance, it is possible to estimate the average number of workers in the motor vehicle body and trailer manufacturing sector per \$1 million spent in the sector, rather than use the ratio from another, more aggregated sector, such as motor vehicle manufacturing. As a result, it is not necessary to extrapolate employment ratios from possibly unrelated sectors. On the other hand, these estimates are averages for the sectors, covering all the activities in those sectors; they may not be representative of the labor required when expenditures are required on specific activities, or when manufacturing processes change sufficiently that labor intensity changes. For instance, the ratio for the motor

vehicle manufacturing sector represents the ratio for all vehicle manufacturing, not just for emissions reductions associated with compliance activities. In addition, these estimates do not include changes in sectors that supply these sectors, such as steel or electronics producers. They thus may best be viewed as the effects on employment in the motor vehicle sector due to the changes in expenditures in that sector, rather than as an assessment of all employment changes due to these changes in expenditures. In addition, this approach estimates the effects of increased expenditures while holding constant the labor intensity of manufacturing; it does not take into account changes in labor intensity due to changes in the nature of production. This latter effect could either increase or decrease the employment impacts estimated here.<sup>924</sup>

Some of the costs of these final rules will be spent directly in the motor vehicle manufacturing sector, but it is also likely that some of the costs will be spent in the motor vehicle body and trailer and motor vehicle parts manufacturing sectors. The analysis here draws on estimates of workers per \$1 million of expenditures for each of these sectors.

There are several public sources for estimates of employment per \$1 million expenditures. The U.S. Bureau of Labor Statistics (BLS) provides its Employment Requirements Matrix (ERM),<sup>925</sup> which provides direct estimates of the employment per \$1 million in sales of goods in 202 sectors. The values considered here are for Motor Vehicle Manufacturing (NAICS 3361), Motor Vehicle Body and Trailer Manufacturing (NAICS 3362), and Motor Vehicle Parts Manufacturing (NAICS 3363) for 2014.

The Census Bureau provides the Annual Survey of Manufacturers<sup>926</sup> (ASM), a subset of the Economic Census (EC), based on a sample of establishments; though the EC itself is more complete, it is conducted only every 5 years, while the ASM is annual. Both include more sectoral detail than the BLS ERM: For instance, while the ERM includes the Motor Vehicle

<sup>924</sup> As noted above, Morgenstern et al. (2002) separate the effect of holding output constant into two effects: The cost effect, which holds labor intensity constant, and the factor shift effect, which estimates those changes in labor intensity.

<sup>925</sup> [http://www.bls.gov/emp/ep\\_data\\_emp\\_requirements.htm](http://www.bls.gov/emp/ep_data_emp_requirements.htm); see "HD Substitution Effect Employment Impacts," Docket EPA-HQ-OAR-2014-0827.

<sup>926</sup> <http://www.census.gov/manufacturing/asm/index.html>; see "HD Substitution Effect Employment Impacts," Docket EPA-HQ-OAR-2014-0827.

<sup>922</sup> Berman, E. and L. T. M. Bui (2001). "Environmental Regulation and Labor Demand: Evidence from the South Coast Air Basin." *Journal of Public Economics* 79(2): 265–295 (Docket EPA-HQ-OAR2014-0827-0074).

<sup>923</sup> The authors also discuss a third component, the impact of regulation on factor prices, but conclude that this effect is unlikely to be important for large competitive factor markets, such as labor and capital. Morgenstern, Pizer and Shih (2002) use a similar model, but they break the employment effect into three parts: (1) The demand effect; (2) the cost effect; and (3) the factor-shift effect. See Morgenstern, Richard D., William A. Pizer, and Jih-Shyang Shih. "Jobs Versus the Environment: An Industry-Level Perspective." *Journal of Environmental Economics and Management* 43 (2002): 412–436 (Docket EPA-HQ-OAR-2014-0827-0088).

Manufacturing sector, the ASM and EC have detail at the 6-digit NAICS code level (e.g., light truck and utility vehicle manufacturing). While the ERM provides direct estimates of employees/\$1 million in expenditures, the ASM and EC separately provide number of employees and value of shipments; the direct employment estimates here are the ratio of those values. The values reported are for Motor Vehicle Manufacturing (NAICS 3361), Light Truck and Utility Vehicle Manufacturing (NAICS 336112), Heavy Duty Truck Manufacturing (NAICS 33612), Motor Vehicle Body and Trailer manufacturing (NAICS 3362), and Motor Vehicle Parts Manufacturing (NAICS 3363).

RIA Chapter 8.11.2.2 provides the details on the values of workers per \$1 million in expenditures in 2014 (2012 for EC) for the sectors mentioned above. In 2013\$, these range from 0.4 workers per \$1 million for Motor Vehicle Manufacturing in the ERM as well as for Light Truck & Utility Vehicle Manufacturing in the ASM, to 3.5 workers per \$1 million in expenditures for Motor Vehicle Body and Trailer Manufacturing in the EC. These values are then adjusted to remove the employment effects of imports through

use of a ratio of domestic production to domestic sales of 0.78.<sup>927</sup>

Over time, the amount of labor needed in the motor vehicle industry has changed: Automation and improved methods have led to significant productivity increases. The BLS ERM, for instance, provided estimates that, in 1997, 1.09 workers in the Motor Vehicle Manufacturing sector were needed per \$1 million, but only 0.39 workers by 2014 (in 2013\$).<sup>928</sup> Because the ERM is available annually for 1997–2014, we used these data to estimate productivity improvements over time. We then used these productivity estimates to project the ERM through 2027, and to adjust the ASM values for 2014 and the EC values for 2012. RIA Chapter 8.11.2 provides detail on these calculations.

Finally, to simplify the presentation and give a range of estimates, we compared the projected employment among the 3 sectors for the ERM, EC, and ASM, and we provide only the maximum and minimum employment effects estimated across the ERM, EC, and ASM. We provide the range rather than a point estimate because of the inherent difficulties in estimating employment impacts; the range gives an estimate of the expected magnitude. The ERM estimates in the Motor Vehicle Manufacturing Sector are consistently

the minimum values. The ASM estimates in the Motor Vehicle Body and Trailer Manufacturing Sector are the maximum values for all years but 2027, when the ASM values for Motor Vehicle Parts Manufacturing provide the maximum values.

Section IX.B. of the Preamble discusses the vehicle cost estimates developed for these final rules. The final step in estimating employment impacts is to multiply costs (in \$ millions) by workers per \$1 million in costs, to estimate employment impacts in the regulated and parts manufacturing sectors. Increased costs of vehicles and parts will, by itself, and holding labor intensity constant, be expected to increase employment between 2018 and 2027 between zero and 4.5 thousand jobs each year.

While we estimate employment impacts, measured in job-years, beginning with program implementation, some of these employment gains may occur earlier as motor vehicle manufacturers and parts suppliers hire staff in anticipation of compliance with the standards. A job-year is a way to calculate the amount of work needed to complete a specific task. For example, a job-year is one year of work for one person.

TABLE IX–33—EMPLOYMENT EFFECTS DUE TO INCREASED COSTS OF VEHICLES AND PARTS (SUBSTITUTION EFFECT), IN JOB-YEARS

Year	Costs (millions of 2013\$)	Minimum employment due to substitution effect (ERM estimates, expenditures in the Motor Vehicles Mfg sector)	Maximum employment due to substitution effect (ASM estimates, expenditures in the Body and Trailer Mfg sector <sup>a</sup> )
2018	227	0	400
2019	215	0	400
2020	220	0	300
2021	2,270	300	3,100
2022	2,243	300	2,900
2023	2,485	300	2,900
2024	3,890	400	4,200
2025	4,146	400	4,100
2026	4,203	400	3,800
2027	5,219	500	4,500

**Note:**

<sup>a</sup>For 2027, the maximum employment effects are associated with the ASM’s Motor Vehicle Parts Manufacturing sector.

(c) Summary of Employment Effects in the Motor Vehicle Sector

The overall effect of these final rules on motor vehicle sector employment depends on the relative magnitude of the output effect and the substitution

effect. Because we do not have quantitative estimates of the output effect, and only a partial estimate of the substitution effect, we cannot reach a quantitative estimate of the overall employment effects of these final rules

on motor vehicle sector employment or even whether the total effect will be positive or negative.

These standards are not expected to provide incentives for manufacturers to shift employment between domestic and

<sup>927</sup> To estimate the proportion of domestic production affected by the change in sales, we use data from Ward’s Automotive Group for total truck production in the U.S. compared to total truck sales in the U.S. For the period 2006–2015, the proportion is 78 percent (HD Substitution Effect

Employment Impacts, Docket EPA–HQ–OAR–2014–0827), ranging from 68 percent (2009) to 83 percent (2012) over that time.

<sup>928</sup> [http://www.bls.gov/emp/ep\\_data\\_emp\\_requirements.htm](http://www.bls.gov/emp/ep_data_emp_requirements.htm); see “HD Substitution Effect Employment Impacts,” Docket EPA–HQ–OAR–

2014–0827. This analysis used data for sectors 80 (Motor Vehicle Manufacturing), 81 (Motor Vehicle Body and Trailer Manufacturing), and 82 (Motor Vehicle Parts Manufacturing) from “Chain-weighted (2009 dollars) real domestic employment requirements tables.”

foreign production. This is because these standards will apply to vehicles sold in the U.S. regardless of where they are produced. If foreign manufacturers already have increased expertise in satisfying the requirements of the standards, there may be some initial incentive for foreign production, but the opportunity for domestic manufacturers to sell in other markets might increase. To the extent that the requirements of these final rules might lead to installation and use of technologies that other countries may seek now or in the future, developing this capacity for domestic production now may provide some additional ability to serve those markets.

### (3) Employment Impacts in Other Affected Sectors

#### (a) Transport and Shipping Sectors

Although not directly regulated by these final rules, employment effects in the transport and shipping sector are likely to result from these regulations. If the overall cost of shipping a ton of freight decreases because of increased fuel efficiency (taking into account the increase in upfront purchasing costs), in a perfectly competitive industry some of these costs savings, depending on the relative elasticities of supply and demand, will be passed along to customers. Consumer Federation of America expects reduced shipping costs to be passed along to customers. With lower prices, demand for shipping would lead to an increase in demand for truck shipping services (consistent with the VMT rebound effect analysis) and therefore an increase in employment in the truck shipping sector. In addition, if the relative cost of shipping freight via trucks becomes cheaper than shipping by other modes (e.g., rail or barge), then employment in the truck transport industry is likely to increase. If the trucking industry is more labor intensive than other modes, we would expect this effect to lead to an overall increase in employment in the transport and shipping sectors.<sup>929 930</sup> Such a shift would, however, be at the expense of employment in the sectors that are losing business to trucking. The first effect—a gain due to lower shipping costs—is likely to lead to a net increase

<sup>929</sup> American Transportation Research Institute, “An Analysis of the Operational Costs of Trucking: 2011 Update.” See [http://www.atrri-online.org/research/results/Op\\_Costs\\_2011\\_Update\\_one\\_page\\_summary.pdf](http://www.atrri-online.org/research/results/Op_Costs_2011_Update_one_page_summary.pdf), Docket EPA-HQ-OAR-2014-0827-512.

<sup>930</sup> Association of American Railroads, “All Inclusive Index and Rail Adjustment Factor.” June 3, 2011. See [http://www.aar.org/-/media/aar/Rail\\_CostIndexes/AAR-RCAF-2011-Q3.ashx](http://www.aar.org/-/media/aar/Rail_CostIndexes/AAR-RCAF-2011-Q3.ashx), Docket EPA-HQ-OAR-2014-0827-0065.

in employment. The second effect, due to mode-shifting, may increase employment in trucking, but decrease employment in other shipping sectors (e.g., rail or barge), with the net effects dependent on the labor-intensity of the sectors and the volumes.

#### (b) Fuel Suppliers

In addition to the effects on the trucking industry and related truck parts sector, these final rules will result in reductions in fuel use that lower GHG emissions. Fuel saving, principally reductions in liquid fuels such as diesel and gasoline, will affect employment in the fuel suppliers industry sectors, principally the Petroleum Refinery sector.

Section IX.C. of this Preamble provides estimates of the effects of these standards on expected fuel consumption. While reduced fuel consumption represents savings for purchasers of fuel, it also represents a loss in value of output for the petroleum refinery industry, which will result in reduced sectoral employment. Because this sector is material-intensive, the employment effect is not expected to be large.<sup>931</sup>

#### (c) Fuel Savings

As a result of this final rulemaking, it is anticipated that trucking firms will experience fuel savings. Fuel savings lower the costs of transportation goods and services. In a competitive market, some of the fuel savings that initially accrue to trucking firms are likely to be passed along as lower transportation costs that, in turn, could result in lower prices for final goods and services. Some commenters provide estimates of per-household fuel savings ranging from \$150 per year by 2030 (Clean Fuels Ohio, Edison Solar, a mass comment campaign sponsored by Pew Charitable Trusts, Quasar Energy Group), to \$400 in 2035 (Environmental Defense Fund); they view these savings as providing benefits to the wider economy. The National Ready Mixed Concrete Association emphasizes concerns about the costs that the standards will impose. Although the agencies do not endorse the particular values provided in the comments, we agree that the standards will provide net benefits to the U.S.; as shown in Section IX.K., the benefits exceed the costs by a wide margin. As noted above, the Consumer Federation of America expects consumers to recover these fuel savings via the costs

<sup>931</sup> In the 2014 BLS ERM cited above, the Petroleum and Coal Products Manufacturing sector has a ratio of workers per \$1 million of 0.215, lower than all but two of the 181 sectors with non-zero employment per \$1 million.

of goods and services relying on HD vehicles. The agencies note that some of the savings might also be retained by firms for investments or for distributions to firm owners. Again, how much accrues to customers versus firm owners will depend on the relative elasticities of supply and demand. Regardless, the savings will accrue to some segment of consumers: Either owners of trucking firms or the general public, and the effect will be increased spending by consumers in other sectors of the economy, creating jobs in a diverse set of sectors, including retail and service industries.

As described in Section IX.C.(2), the retail value of fuel savings from this final rulemaking is projected to be \$15.8 billion (2013\$) in 2027, according to Table IX-6. If all those savings are spent, the fuel savings will stimulate increased employment in the economy through those expenditures. If the fuel savings accrue primarily to firm owners, they may either reinvest the money or take it as profit. Reinvesting the money in firm operations could increase employment directly. If they take the money as profit, to the extent that these owners are wealthier than the general public, they may spend less of the savings, and the resulting employment impacts would be smaller than if the savings went to the public. Thus, while fuel savings are expected to decrease employment in the refinery sector, they are expected to increase employment through increased consumer expenditures.

#### (4) Summary of Employment Impacts

The primary employment effects of these rules are expected to be found throughout several key sectors: Truck and engine manufacturers, the trucking industry, truck parts manufacturing, fuel production, and consumers. These rules initially takes effect in model year 2018; the unemployment rate at that time is unknowable. In an economy with full employment, the primary employment effect of a rulemaking is likely to be to move employment from one sector to another, rather than to increase or decrease employment. For that reason, we focus our partial quantitative analysis on employment in the regulated sector, to examine the impacts on that sector directly. We discuss the likely direction of other impacts in the regulated sector as well as in other directly related sectors, but we do not quantify those impacts, because they are more difficult to quantify with reasonable accuracy, particularly so far into the future.

For the regulated sector, we have not quantified the output effect. The

substitution effect is associated with potential increased employment between zero and 4.5 thousand jobs per year between 2018 and 2027, depending on the share of employment impacts in the affected sectors (Motor Vehicle Manufacturing, Motor Vehicle Body and Trailer Manufacturing, and Motor Vehicle Parts Manufacturing). These estimates do not include potential changes, either greater or less, in labor intensity of production. As mentioned above, some of these job gains may occur earlier as auto manufacturers and parts suppliers hire staff to prepare to comply with the standard.

Lower prices for shipping are expected to lead to an increase in demand for truck shipping services and, therefore, an increase in employment in that sector, though this effect may be offset somewhat by changes in employment in other shipping sectors. Reduced fuel production implies less employment in the fuel provision sectors. Finally, any net cost savings are expected to be passed along to some segment of consumers: Either the general public or the owners of trucking firms, who are expected then to increase employment through their expenditures. Under conditions of full employment, any changes in employment levels in

the regulated sector due to this program are mostly expected to be offset by changes in employment in other sectors.

*M. Cost of Ownership and Payback Analysis*

This section examines the economic impacts of the Phase 2 standards from the perspective of buyers, operators, and subsequent owners of new HD vehicles at the level of individual purchasers of different types of vehicles. In each case, the analysis assumes that HD vehicle manufacturers are able to recover their costs for improving fuel efficiency—including direct technology outlays, indirect costs, and normal profits on any additional capital investments—by charging higher prices to HD vehicle buyers.

Table IX–34 reports aggregate benefits and costs to buyers and operators of new HD vehicles for the final program using Method A. The table reports economic impacts on buyers using only the 7 percent discount rate, since that rate is intended to represent the opportunity cost of capital that HD vehicle buyers and users must divert from other investment opportunities to purchase more costly vehicles. As it shows, fuel savings and the other benefits from increased fuel efficiency—savings from less frequent refueling and

benefits from additional truck use—far outweigh the higher costs to buyers of new HD vehicles. As a consequence, buyers, operators, and subsequent owners of HD vehicles subject to the Phase 2 standards are together projected to experience large economic gains under the final program. It should be noted that, because the original buyers may not hold the vehicles for their lifetimes, and because those who own or operate the vehicles may not pay for the fuel, these benefits and costs do not necessarily represent benefits and costs to identifiable individuals.

As Table IX–34 shows, the agencies have estimated the increased costs for maintenance of the new technologies that HD vehicle manufacturers will employ to decrease fuel consumption, and these costs are included together with those for purchasing more fuel-efficient vehicles. Manufacturers' efforts to comply with the Phase 2 standards could also result in changes to vehicle performance and capacity for certain vehicles. For example, reducing the mass of HD vehicles in order to improve fuel efficiency could be used to improve their load-carrying capabilities, while some engine technologies and aerodynamic modifications could reduce payload capacity.

**TABLE IX–34—MY 2018–2029 LIFETIME AGGREGATE IMPACTS OF THE FINAL PROGRAM ON ALL HD VEHICLE BUYERS AND OPERATORS USING METHOD A**  
[Billions of 2013\$, Discounted at 7%]<sup>a</sup>

	Baseline 1a	Baseline 1b
Vehicle costs .....	16.6	16.1
Maintenance costs .....	0.9	0.9
<b>Total costs to HD vehicle buyers .....</b>	<b>17.5</b>	<b>17.0</b>
Fuel savings <sup>b</sup> (valued at retail prices) .....	97.7	89.5
Refueling benefits .....	1.7	1.6
Increased travel benefits .....	3.5	3.4
<b>Total benefits to HD vehicle buyers/operators .....</b>	<b>103</b>	<b>94.5</b>
<b>Net benefits to HD vehicle buyers/operators<sup>c</sup> .....</b>	<b>85.4</b>	<b>77.5</b>

**Notes:**

<sup>a</sup>For an explanation of analytical Methods A and B, please see Section I.D; for an explanation of the less dynamic baseline, 1a, and more dynamic baseline, 1b, please see Section X.A.1.

<sup>b</sup>Fuel savings includes fuel consumed during additional rebound driving.

<sup>c</sup>Net benefits shown do not include benefits associated with carbon or other co-pollutant emission reductions, crash/congestion/noise impacts, energy security, etc.

It is also useful to examine the cost of purchasing and owning a new vehicle that complies with the Phase 2 standards and its payback period—the point at which cumulative savings from lower fuel expenditures outpace increased vehicle costs. For example, a new MY 2027 tractor is estimated to cost roughly \$13,550 more (on average, or roughly 13 to 14 percent of a typical \$100,000 reference case tractor) due to

the addition of new GHG reducing/fuel consumption improving technology. This new technology will result in lower fuel consumption and, therefore, reduced fuel expenditures. But how many months or years will pass before the reduced fuel expenditures will surpass the increased upfront costs?

Table IX–35 presents the discounted annual increased vehicle costs and fuel savings associated with owning a new MY 2027 HD pickup or van using both

3 percent and 7 percent discount rates. Table IX–36 and Table IX–37 show the same information for a MY 2027 vocational vehicle and a tractor/trailer, respectively. These comparisons include sales taxes, excise taxes (for vocational and tractor/trailer) and increased insurance expenditures on the higher value vehicles, as well as maintenance costs throughout the lifetimes of affected vehicles.

The fuel expenditure column uses retail fuel prices specific to gasoline and diesel fuel as projected in AEO2015.<sup>932</sup> This payback analysis does not include other impacts, such as reduced refueling events, the value of driving potential rebound miles, or noise, congestion and crashes. We use retail fuel prices and

exclude these other private and social impacts because the analysis is intended to focus on those factors that are most important to buyers when considering a new vehicle purchase, and to include only those factors that have clear dollar impacts on HD vehicle buyers.

As shown, payback will occur in the 3rd year of ownership for HD pickups

and vans (the first year where cumulative net costs turn negative), in the 4th year for vocational vehicles and early in the 2nd year for tractor/trailers. Note that each table reflects the average vehicle and reflects proper weighting of fuel consumption/costs (gasoline vs. diesel).

TABLE IX-35—DISCOUNTED ANNUAL INCREMENTAL EXPENDITURES FOR A MY 2027 HD PICKUP OR VAN USING METHOD B AND RELATIVE TO THE FLAT BASELINE [2013\$]<sup>a</sup>

Age in years	3% Discount rate				7% Discount rate			
	Vehicle <sup>b</sup>	Maint <sup>c</sup>	Fuel <sup>d</sup>	Cumulative net	Vehicle <sup>b</sup>	Maint <sup>c</sup>	Fuel <sup>d</sup>	Cumulative net
1 .....	-\$1,451	-\$4	\$550	-\$905	-\$1,424	-\$4	\$540	-\$888
2 .....	-25	-4	539	-395	-24	-3	509	-406
3 .....	-24	-3	527	105	-21	-3	479	49
4 .....	-22	-3	515	595	-19	-3	451	477
5 .....	-21	-3	492	1,064	-17	-3	415	872
6 .....	-19	-3	469	1,511	-16	-2	381	1,235
7 .....	-18	-3	446	1,936	-14	-2	348	1,567
8 .....	-17	-2	423	2,340	-13	-2	318	1,870

**Notes:**

<sup>a</sup>For an explanation of analytical Methods A and B, please see Section I.D; for an explanation of the flat baseline, 1a, and dynamic baseline, 1b, please see Section X.A.1.

<sup>b</sup>Includes new technology costs, insurance costs and sales taxes.

<sup>c</sup>Maintenance costs.

<sup>d</sup>Uses AEO2015 retail fuel prices.

TABLE IX-36—DISCOUNTED ANNUAL INCREMENTAL EXPENDITURES FOR A MY 2027 VOCATIONAL VEHICLE USING METHOD B AND RELATIVE TO THE FLAT BASELINE [2013\$]<sup>a</sup>

Age in years	3% Discount rate				7% Discount rate			
	Vehicle <sup>b</sup>	Maint <sup>c</sup>	Fuel <sup>d</sup>	Cumulative net	Vehicle <sup>b</sup>	Maint <sup>c</sup>	Fuel <sup>d</sup>	Cumulative net
1 .....	-\$3,147	-\$25	\$1,022	-\$2,151	-\$3,088	-\$25	\$1,003	-\$2,110
2 .....	-49	-24	1,004	-1,220	-46	-23	948	-1,231
3 .....	-46	-24	987	-303	-42	-21	898	-397
4 .....	-43	-23	970	602	-38	-20	849	394
5 .....	-40	-21	909	1,450	-34	-18	766	1,109
6 .....	-38	-19	850	2,243	-31	-15	689	1,752
7 .....	-35	-17	796	2,987	-27	-14	622	2,333
8 .....	-33	-16	743	3,681	-25	-12	558	2,854

**Notes:**

<sup>a</sup>For an explanation of analytical Methods A and B, please see Section I.D; for an explanation of the flat baseline, 1a, and dynamic baseline, 1b, please see Section X.A.1.

<sup>b</sup>Includes new technology costs, insurance costs, excise and sales taxes.

<sup>c</sup>Maintenance costs.

<sup>d</sup>Uses AEO2015 retail fuel prices.

TABLE IX-37—DISCOUNTED ANNUAL INCREMENTAL EXPENDITURES FOR A MY 2027 TRACTOR/TRAILER USING METHOD B AND RELATIVE TO THE FLAT BASELINE [2013\$]<sup>a</sup>

Age in years	3% Discount rate				7% Discount rate			
	Vehicle <sup>b</sup>	Maint <sup>c</sup>	Fuel <sup>d</sup>	Cumulative net	Vehicle <sup>b</sup>	Maint <sup>c</sup>	Fuel <sup>d</sup>	Cumulative net
1 .....	-\$16,022	-\$169	\$15,310	-\$880	-\$15,719	-\$166	\$15,021	-\$864
2 .....	-251	-163	15,095	13,801	-237	-154	14,256	13,002
3 .....	-235	-158	14,872	28,280	-214	-144	13,521	26,166

<sup>932</sup> U.S. Energy Information Administration, Annual Energy Outlook 2015; Report Number DOE/EIA-0383(2015), April 2015.

TABLE IX-37—DISCOUNTED ANNUAL INCREMENTAL EXPENDITURES FOR A MY 2027 TRACTOR/TRAILER USING METHOD B AND RELATIVE TO THE FLAT BASELINE—Continued  
[2013\$]<sup>a</sup>

Age in years	3% Discount rate				7% Discount rate			
	Vehicle <sup>b</sup>	Maint <sup>c</sup>	Fuel <sup>d</sup>	Cumulative net	Vehicle <sup>b</sup>	Maint <sup>c</sup>	Fuel <sup>d</sup>	Cumulative net
4 .....	-220	-153	14,637	42,545	-192	-134	12,809	38,649
5 .....	-206	-140	13,683	55,882	-173	-118	11,527	49,885
6 .....	-192	-127	12,730	68,292	-156	-103	10,323	59,950
7 .....	-179	-116	11,880	79,878	-140	-90	9,274	68,993
8 .....	-166	-105	11,025	90,630	-125	-79	8,285	77,074

**Notes:**

<sup>a</sup>For an explanation of analytical Methods A and B, please see Section I.D; for an explanation of the flat baseline, 1a, and dynamic baseline, 1b, please see Section X.A.1.

<sup>b</sup>Includes new technology costs, insurance costs, excise and sales taxes.

<sup>c</sup>Maintenance costs.

<sup>d</sup>Uses AEO2015 retail fuel prices.

*N. Safety Impacts*

(1) Summary of Supporting HD Vehicle Safety Research

As discussed in the Notice of Proposed Rulemaking, NHTSA and EPA considered the potential safety impact of technologies that improve Medium- and Heavy-Duty vehicle fuel efficiency and GHG emissions when determining potential regulatory alternatives. The safety assessment of the technologies in this rule was informed by two comprehensive NAS reports, an extensive analysis of safety effects of HD pickups and vans using estimates from the DOT report on the effect of mass reduction and vehicle size on safety, and focused agency-sponsored safety testing and research. The following section provides a concise summary of the literature and work considered by the agencies in development of this final rule.

(a) National Academy of Sciences Medium and Heavy Duty Phase 1 and Phase 2 Reports

As required by EISA, the National Research Council has been conducting continuing studies of the technologies and approaches for reducing the fuel consumption of medium- and heavy-duty vehicles. The first was a report issued in 2010, “Technologies and Approaches to Reducing the Fuel Consumption of Medium- and Heavy-Duty Vehicles” (“NAS Report”). The second was a report issued in 2014, “Reducing the Fuel Consumption and Greenhouse Gas Emissions of Medium- and Heavy-Duty Vehicles, Phase Two-First Report” (“NAS HD Phase 2 First Report”). While the reports primarily focused on reducing vehicle fuel consumption and emissions through technology application, and examined potential regulatory frameworks, both

reports contain findings and recommendations related to safety. In developing this rule, the agencies carefully considered the reports’ findings related to safety.

In particular, NAS indicated that idle reduction strategies can also accommodate for the safety of the driver in both hot and cold weather conditions. The agencies considered this potential approach for application of idle reduction technologies by allowing for override provisions, as defined in 40 CFR 1037.660(b), where operator safety is a primary consideration. Override is allowed if the external ambient temperature reaches a level below which or above which the cabin temperature cannot be maintained within reasonable heat or cold exposure threshold limit values for the health and safety of the operator (not merely comfort).

NAS also reported extensively on the emergence of natural gas (NG) as a viable fuel option for commercial vehicles, but alluded to the existence of uncertainties regarding its safety. The committee found that while the public crash databases do not contain information on vehicle fuel type, the information, at the time of the report, indicates that the crash-related safety risk for NG storage on vehicles does not appear to be appreciably different from diesel fuel risks. The committee also found that while there are two existing SAE-recommended practice standards for NG-powered HD vehicles, the industry could benefit from best practice directives to minimize crash risks for NG fuel tanks, such as on shielding to prevent punctures during crashes. As a final point, NAS stated that manufacturers and operators have a great incentive to prevent possible NG leakage from a vehicle fuel system because it will be a significant safety

concern and reduce vehicle range. No recommendations were made for additional Federal safety regulations for these vehicles. In response, the agencies reviewed and discussed the existing NG vehicle standards and best practices cited by NAS in Section XI of the NPRM.

In the NAS Committee’s Phase 1 report, the Committee indicated that aerodynamic fairings detaching from trucks on the road could be a potential safety issue. However, the Phase 2 interim report stated that “Anecdotal information gained during the observations of on-road trailers indicates a few skirts badly damaged or missing from one side. The skirt manufacturers report no safety concerns (such as side skirts falling off) and little maintenance needed.”

The NAS report also identified the link between tire inflation and condition and vehicle stopping distance and handling, which impacts overall safety. The committee found that tire pressure monitoring systems and automatic tire inflation systems are being adopted by fleets at an increasing rate. However, the committee noted that there are no standards for performance, display, and system validation. The committee recommended that NHTSA issue a white paper on the minimum performance of tire pressure systems from a safety perspective.

The agencies considered the safety findings in both NAS reports in developing this rule and conducted additional research on safety to further examine information and findings of the reports.

(b) DOT CAFE Model Heavy-Duty Pickup and Van Safety Analysis

This analysis considered the potential crash safety effects on the technologies manufacturers may apply to HD pickups



and vans to meet each of the regulatory alternatives evaluated in the NPRM. NHTSA research has shown that vehicle mass reduction affects overall societal fatalities associated with crashes and, most relevant to this rule, that mass reduction in heavier light- and medium-duty vehicles has an overall beneficial effect on societal fatalities. Reducing the mass of a heavier vehicle involved in a multiple vehicle crash reduces the likelihood of fatalities among the occupants of the other vehicle(s). In addition to the effects of mass reduction, the analysis anticipates that these standards, by reducing the cost of driving HD pickups and vans, will lead to increased travel by these vehicles and, therefore, more crashes involving these vehicles. Both the Method A and B analyses, both of which are included in the NPRM and are part of this final rulemaking, consider overall impacts from both of these factors, using a methodology similar to NHTSA's analyses for the MYs 2017–2025 CAFE and GHG emission standards.

The Method A analysis included estimates of the extent to which HD pickups and vans produced during MYs 2014–2030 may be involved in fatal crashes, considering the mass, survival, and mileage accumulation of these vehicles, taking into account changes in mass and mileage accumulation under each regulatory alternative. These calculations make use of the same coefficients applied to light trucks in the MYs 2017–2025 CAFE rulemaking analysis. As discussed above, vehicle miles traveled may increase due to the fuel economy rebound effect, resulting from improvements in vehicle fuel efficiency and cost of fuel, as well as the assumed future growth in average vehicle use. Increases in total lifetime mileage increase exposure to vehicle crashes, including those that result in fatalities. Consequently, the modeling system computes total fatalities attributed to vehicle use for vehicles of a given model year based on safety class and weight threshold. These calculations also include a term that accounts for the fact that some of the vehicles involved in future crashes will comply with more stringent safety standards than those involved in past crashes upon which the base rates of involvement in fatal crashes were estimated. Since the use of mass reducing technology is present within the model, safety impacts may also be observed whenever a vehicle's base weight decreases. Thus, in addition to computing total fatalities related to vehicle use, the modeling system also

estimates changes in fatalities due to reduction in a vehicle's curb weight.

The total fatalities attributed to vehicle use and vehicle weight change for vehicles of a given model year are then summed. Lastly, total fatalities occurring within the industry in a given model year are accumulated across all vehicles. In addition to using inputs to estimate the future involvement of modeled vehicles in crashes involving fatalities, the model also applies inputs defining other crash-related externalities estimated on a dollar per mile basis. For vehicles above 4,594 lbs—*i.e.*, the majority of the HD pickup and van fleet—mass reduction is estimated to reduce the net incidence of highway fatalities by 0.34 percent per 100 lbs of removed curb weight. For the few HD pickups and vans below 4,594 lbs, mass reduction is estimated to increase the net incidence of highway fatalities by 0.52 percent per 100 lbs. The overall effect of mass reduction in the segment is estimated to reduce the incidence of highway fatalities as there are more HD pickups and vans above 4,594 lbs than below. The projected increase in vehicle miles traveled, due to the fuel economy rebound effect, also potentially increases exposure to vehicle crashes and offsets these reductions.

#### (c) Volpe Research on MD/HD Fuel Efficiency Technologies

The 2010 National Research Council report “Technologies and Approaches to Reducing the Fuel Consumption of Medium- and Heavy-Duty Vehicles” recommended that NHTSA perform a thorough safety analysis to identify and evaluate potential safety issues with fuel efficiency-improving technologies. The Department of Transportation Volpe Center's 2015 report titled “Review and Analysis of Potential Safety Impacts and Regulatory Barriers to Fuel Efficiency Technologies and Alternative Fuels in Medium- and Heavy-Duty Vehicles” summarizes research and analysis findings on potential safety issues associated with both the diverse alternative fuels (natural gas-CNG and LNG, propane, biodiesel, and power train electrification), and the specific FE technologies recently adopted by the MD/HDV fleets.<sup>933</sup> These include Intelligent Transportation Systems (ITS) and telematics, speed limiters, idle reduction devices, tire technologies (single-wide tires, and tire pressure

monitoring systems-TPMS and Automated Tire Inflation Systems-ATIS), aerodynamic components, vehicle light-weighting materials, and Long Combination Vehicles (LCVs).

Chapter 1 provides an overview of the study's rationale, background, and key objective, namely, to identify the technical and operational/behavioral safety benefits and disbenefits of MD/HDVs equipped with FE technologies and using emerging alternative fuels (AFs). Recent MD/HDV national fleet crash safety statistical averages are also provided for context, although no information exists in crash reports relating to specific vehicle FE technologies and fuels. (NHTSA/FARS and FMCSA/CSA databases do not include detailed information on vehicle fuel economy technologies, since the state crash report forms are not coded down to an individual fuel economy technology level).

Chapters 2 and 3 are organized by clusters of functionally-related FE technologies for vehicles and trailers (*e.g.*, tire systems, ITS, light-weighting materials, and aerodynamic systems) and alternative fuels, which are described and their respective associated potential safety issues are discussed. Chapter 2 summarizes the findings from a comprehensive review of available technical and trade literature and Internet sources regarding the benefits, potential safety hazards, and the applicable safety regulations and standards for deployed FE technologies and alternative fuels. Chapter 2 safety-relevant fuel-specific findings include:

- Both CNG- and LNG-powered vehicles present potential hazards, and call for well-known engineering and process controls to assure safe operability and crashworthiness. However, based on the reported incident rates of NGVs and the experiences of adopting fleets, it appears that NGVs can be operated at least as safely as diesel MD/HDVs.

- There are no safety contraindications to the large scale fleet adoption of CNG or LNG fueled heavy duty trucks and buses, and there is ample experience with the safe operation of large public transit fleets. Voluntary industry standards and best practices suffice for safety assurance, though improved training of CMV operators and maintenance staff in natural gas safety of equipment and operating procedures is needed.

- Observing CNG and LNG fuel system and maintenance facility standards, coupled with sound design, manufacture, and inspection of natural gas storage tanks will further reduce the

<sup>933</sup> Brecher, A., Epstein, A. K., & Breck, A. (2015, June). *Review and analysis of potential safety impacts of and regulatory barriers to fuel efficiency technologies and alternative fuels in medium- and heavy-duty vehicles*. (Report No. DOT HS 812 159). Washington, DC: National Highway Traffic Safety Administration.

potential for leaks, tank ruptures, fires, and explosions.

- Biodiesel blends used as drop-in fuels have presented some operational safety concerns dependent on blending fraction, such as material compatibility, bio-fouling sludge accumulation, or cold-weather gelling. However, best practices for biodiesel storage, and improved gaskets and seals that are biodiesel resistant, combined with regular maintenance and leak inspection schedules for the fuel lines and components enable the safe use of biodiesel in newer MD/HDVs.

- Propane (LPG, or autogas) presents well-known hazards including ignition (due to leaks or crash) that are preventable by using Overfill Prevention Devices (OPDs), which supplement the automatic stop-fill system on the fueling station side, and pressure release devices (PRDs). Established best practices and safety codes (e.g., NFPA) have proven that propane fueled MD/HDVs can be as operationally safe as the conventionally-fueled counterparts.

- As the market penetration of hybrid and electric drivetrain accelerates, and as the capacity and reliability of lithium ion batteries used in Rechargeable Energy Storage Systems (RESS) improve, associated potential safety hazards (e.g., electrocution from stranded energy, thermal runaway leading to battery fire) have become well understood, preventable, and manageable. Existing and emerging industry technical and safety voluntary standards, applicable NHTSA regulations and guidance, and the growing experience with the operation of hybrid and electric MD/HDVs will enable the safe operation and large-scale adoption of safer and more efficient power-train electrification technologies.

The safety findings from literature review pertaining to the specific FE technologies implemented to date in the MD/HDV fleet include:

- Telematics—integrating on-board sensors, video, and audio alerts for MD/HDV drivers—offer potential improvements in both driver safety performance and fuel efficiency. Both camera and non-camera based telematics setups are currently integrated with available crash avoidance systems (such as ESC, RSC, LDWS, etc.) and appear to be well accepted by MD/HDV fleet drivers.

- Both experience abroad and the cited US studies of trucks equipped with active speed limiters indicated a safety benefit, as measured by up to 50 percent reduced crash rates, in addition to fuel savings and other benefits, with good CMV driver acceptance. Any negative aspects were small and

avoidable if all the speed limitation devices were set to the same speed, so there will be less need for overtaking at highway speeds.

- No literature reports of adverse safety impacts were found regarding implementation of on-board idle-reduction technologies in MD/HDVs (such as automatic start-stop, direct-fired heaters, and APUs).

- There was no clear consensus from the literature regarding the relative crash rates and highway safety impacts of LCVs, due to lack of sufficient data and controls and inconsistent study methodologies. Recent safety evaluations of LCVs and ongoing MAP-21 mandated studies will clarify and quantify this issue.

- Tire technologies for FE (including ATIS, TPMS, LRR and single-wide tires) literature raised potential safety concerns regarding lower stability or loss of control, e.g., when tire pressure is uneven or a single wide tire blows out on the highway. However, systems such as automated tire monitoring systems and stability enhancing electronic systems (ABS, ESC, and RSC) may compensate and mitigate any adverse safety impacts.

- Aerodynamic technologies that offer significant fuel savings have raised potential concerns about vehicle damage or injury in case of detached fairings or skirts, although there were no documented incidents of this type in the literature.

- Some light weighting materials may pose some fire safety and crashworthiness hazards, depending on their performance in structural or other vehicle subsystem applications (chassis, powertrain, and crash box or safety cage). Some composites (fiberglass, plastics, CFRP, foams) may become brittle on impact or due to weathering from UV exposure or extreme cold. Industry has developed advanced, high performance lightweight material options tailored to their automotive applications, e.g., thermoplastics resistant to UV and weathering. No examples of such lightweight material failures on MD/HDVs were identified in the literature.

Chapter 3 provides complementary inputs on the potential safety issues associated with FE technologies and alternative fuels obtained from Subject Matter Experts (SMEs). The broad cross-section of SMEs consulted had experience with the operation of “green” truck and bus fleets, were Federal program managers, or were industry developers of FE systems for MD/HDVs. Safety concerns raised by the SMEs can be prevented or mitigated by complying with applicable regulations

and safety standards and best practices, and are being addressed by evolving technologies, such as electronic collision prevention devices. Although SMEs raised some safety concerns, their experience indicates that system- or fuel-specific hazards can be prevented or mitigated by observing applicable industry standards, and by training managers, operators and maintenance staff in safety best practices. Specific safety concerns raised by SMEs based on their experience included:

- Alternative fuels did not raise major safety concerns, but generally required better education and training of staff and operators. There was a concern expressed regarding high pressure (4000 psi) CNG cylinders that could potentially explode in a crash scenario or if otherwise ruptured. However, aging CNG fuel tank safety can be assured by enforcing regulations such as FMVSS No. 304, and by periodic inspection and end-of-life disposal and replacement. A propane truck fleet manager stated that the fuel was as safe as or safer than gasoline, and reported no safety issues with the company’s propane, nor with hybrid gasoline-electric trucks. OEMs of drivetrain hybridization and electrification systems, including advanced Lithium Ion batteries for RESS, indicated that they undergo multiple safety tests and are designed with fail-safes for various misuse and abuse scenarios. Integration of hybrid components downstream by bodybuilders in retrofits, as opposed to new vehicles, was deemed a potential safety risk. Another potential safety concern raised was the uncertain battery lifetime due to variability of climate, duty-cycles, and aging. Without state-of-charge indicators, this could conceivably leave vehicles underpowered or stranded if the battery degrades and is not serviced or replaced in a timely manner.

- ITS and telematics raised no safety concerns; on the contrary, fleet managers stated that “efficient drivers are safer drivers.” Monitoring and recording of driver behavior, combined with coaching, appeared to reduce distracted and aggressive driving and provided significant FE and safety benefits.

- A wide-base single tire safety concern was the decrease in tire redundancy in case of a tire blowout at highway speeds. For LRRs, a concern was that they could negatively affect truck stopping distance and stability control.

- A speed-limiter safety concern was related to scenarios when such trucks pass other vehicles on the highway instead of staying in the right-hand lane

behind other vehicles. By combining speed limiters with driver training programs, overall truck safety could actually improve, as shown by international practice.

- Aerodynamic systems' safety performance to date was satisfactory, with no instances of on-road detaching. However, covering underside or other components with aerodynamic fairings can make them harder to inspect, such as worn lugs, CNG relief valve shrouds, wheel covers, and certain fairings.

Drivers and inspectors need to be able to see through wheel covers and to be able to access lug nuts through them. These covers must also be durable to withstand frequent road abuse.

- For lightweighting materials, the safety concern raised was lower crashworthiness (debonding or brittle fracture on impact) and the potential for decreased survivability in vehicle fires depending on the specific material choice and its application.

The key finding from the literature review and SME interviews is that there appear to be no major safety hazards preventing the adoption of FE technologies, or the increased use of alternative fuels and vehicle electrification. In view of the scarcity of hard data currently available on actual highway crashes that can be directly or causally attributed to adoption of FE technologies and/or alternative fuels by MD/HDVs, and the limited experience with commercial truck and transit bus fleets operations equipped with these technologies, it was not possible to perform a quantitative, probabilistic risk assessment, or even a semi-quantitative preliminary hazard analysis (PHA). Chapter 4 employs a deterministic scenario-based hazard analysis of potential crash or other safety concerns identified from the literature review or raised by subject matter experts (SMEs) interviewed (e.g., interfaces with charging or refueling infrastructure). For each specific hazard scenario discussed, the recommended prevention or mitigation options, including compliance with applicable NHTSA or FMCSA regulations, and voluntary industry standards and best practices are identified, along with FE technology or fuel-specific operator training. SMEs safety concerns identified in Sec 3.3 were complemented with actual incidents, and developed into the hazard scenarios analyzed in Chapter 4.

The scenario-based deterministic hazard analysis reflected not only the literature findings and SMEs' safety concerns, but also real truck or bus mishaps that have occurred in the past. Key hazard analysis scenarios included: CNG-fueled truck and bus vehicle fires

or explosions due to tank rupture, when pressurized fuel tanks were degraded due to aging or when PRDs failed; LNG truck crashes leading to fires, or LNG refueling-related mishaps; the flammability or brittle fracture issues related to light weighting materials in crashes; reduced safety performance for either LRR or wide-base tires; highway pile-ups when LCVs attempt to pass at highway speeds; aerodynamic components detaching while the vehicle traveled on a busy highway or urban roadway; and fires resulting in overheated lithium ion batteries in electric or hybrid buses. These hypothetical worst case scenarios appear to be preventable or able to be mitigated by observing safety regulations and voluntary standards, or with engineering and operational best practices.

Chapter 5 reviews and discusses the existing federal and state regulatory framework for safely operating MD/HDVs equipped with FE technologies or powered by alternative fuels. The review identifies potential regulatory barriers to their large-scale deployment in the national fleet that could delay achievement of desired fuel consumption and environmental benefits, while ensuring equal or better safety performance.

Chapter 6 summarizes the major findings and recommendations of this preliminary safety analysis of fuel efficiency technologies and alternative fuels adopted by MD/HDVs. The scenario-based hazard analysis, based on the literature review and experts' inputs, indicates that MD/HDVs equipped with advanced FE technologies and/or using alternative fuels have manageable potentially adverse safety impacts. The findings suggest that the potential safety hazards identified during operation, maintenance, and crash scenarios can be prevented or mitigated by complying with safety regulations and voluntary standards and industry best practices. The study also did not identify any major regulatory barriers to rapid adoption of FE technologies and alternative fuels by the MD/HDV fleet.

#### (d) Oak Ridge National Laboratory (ORNL) Research on Low Rolling Resistance Truck Tires

DOT's Federal Motor Carrier Safety Administration and NHTSA sponsored a test program conducted by Oak Ridge National Laboratory to explore the effects of tire rolling resistance levels on Class 8 tractor-trailer stopping distance performance over a range of loading and surface conditions. The objective was to determine whether a relationship exists

between tire rolling resistance and stopping distance for vehicles of this type. The overall results of this research suggest that tire rolling resistance is not a reliable indicator of Class 8 tractor-trailer stopping distance.

The correlation coefficients (R2 values) for linear regressions of wet and dry stopping distance versus overall vehicle rolling resistance values did not meet the minimum threshold for statistical significance for any of the test conditions. Correlation between CRR and stopping distance was found to be negligible for the dry tests for both loading conditions. While correlation was higher for the wet testing (showing a slight trend in which lower CRRs correspond to longer stopping distances), it still did not meet the minimum threshold for statistical significance. In terms of compliance with Federal safety standards, it was found that the stopping distance performance of the vehicle with the four tire sets studied in this research (with estimated tractor CRRs which varied by 33 percent), were well under the FMVSS No. 121 stopping distance requirements.

#### (e) Additional Safety Considerations

The agencies considered the Organic Rankine Cycle waste heat recovery (WHR) as a fuel saving technology in the rulemaking timeframe. The basic approach of these systems is to use engine waste heat from multiple sources to evaporate a working fluid through a heat exchanger, which is then passed through a turbine or equivalent expander to create mechanical or electrical power. The working fluid is then condensed as it passes through a heat exchanger and returns to back to the fluid tank, and pulled back to the flow circuit through a pump to continue the cycle.

Despite the promising performance of pre-prototype WHR systems, manufacturers have not yet arrived at a consensus on which working fluid(s) to be used in WHR systems to balance concerns regarding performance, global warming potential (GWP), and safety. Working fluids have a high GWP (conventional refrigerant), are expensive (low GWP refrigerant), are hazardous (such as ammonia, etc.), are flammable (ethanol/methanol), or can freeze (water). One challenge is determining how to seal the working fluid properly under the vacuum condition and high temperatures to avoid safety issues for flammable/hazardous working fluids. Because of these challenges, choosing a working fluid will be an important factor for system safety, efficiency, and overall production viability.

The agencies believe manufacturers will require additional time and development effort to assure that a working fluid that is both appropriate, given the noted challenges, and has a low GWP for use in waste heat recovery systems. Based on this and other factors, the analysis used for both the proposed Preferred Alternative and for this final rule assumes that WHR will not achieve a significant market penetration for diesel tractor engines (*i.e.*, greater than 5 percent) until 2027, which will provide time for these considerations to be addressed. The agencies assume no use of this technology in the HD pickups and vans and vocational vehicle segments.

#### (2) Safety Related Comments to the NPRM

The agencies received safety related comments to the NPRM focused on the vehicle and operator safety benefits of central tire inflation systems, potential safety and traction impacts of low rolling resistance tires, and recommendations that NHTSA continue evaluations of potential safety impacts of fuel saving technologies.

AIR CTI, Inc., a supplier of central tire inflation systems, highlighted the safety benefits to both vehicle operation and the operators themselves through proper tire pressure management. More specifically, the proper tire inflation levels for the load being carried contributes to both proper handling for road conditions and reducing irregular road surface vibration from being transmitted to vehicle component and, ultimately, the vehicle operator, where there may be potential health implications over prolonged exposure.

The agencies appreciate the additional points provided by AIR CTI in terms of not only the potential fuel efficiency benefits of central tire inflation systems but the potential equipment longevity benefits, vehicle dynamic impacts, and the potential to reduce driver fatigue and injury through proper tire inflation for the load being carried.

The American Trucking Associations (ATA) commented on the potential impact of Low Rolling Resistance Tires by indicating that, "The safety effects of LRRTs are not totally understood. While the . . . agencies analysis indicate that this proposal should have no adverse impact on vehicle or engine safety," ATA remains leery of potential unintended consequences resulting from new generation tires that have yet to be developed. This especially holds true in terms of overall truck braking distances." The Owner-Operator Independent Drivers Association

(OOIDA) similarly commented on LRRTs and their ability to meet the tractions needs in mountainous regions.

The agencies continue to stand behind the low rolling resistance tire research conducted to date, which includes the study mentioned in the previous section, along with any research supporting the development, and maintenance, of FMVSS No. 121. The agencies agree, though, that continuing research will be important as new tire technologies enter the marketplace, and like the extensive rolling resistance testing conducting to support the Phase 1 regulation and, in part, this final rule, the agencies will continue to monitor developments in the tire supply marketplace through the EPA Smartway program and other, potential, research. NHTSA notes that FMVSS No. 121 will continue to play a role in ensuring the safety of both current and future tire technologies.

The ATA also expressed support for the NHTSA study mentioned in the previous section, *Review and Analysis of Potential Safety Impacts of and Regulatory Barriers to Fuel Efficiency Technologies and Alternative Fuels in Medium- and Heavy-Duty Vehicles*. More specifically, ATA requested that DOT/NHTSA and the DOT Volpe Center continue "to assess and evaluate potential safety impacts that may be attributed to the use of fuel efficiency devices." The agencies appreciate ATA's support and acknowledge of this comprehensive, peer-reviewed assessment and we look forward to continuing this work to as the need arises.

#### (3) The Agencies' Assessment of Potential Safety Impacts

NHTSA and EPA considered the potential safety impact of technologies that improve MDHD vehicle fuel efficiency and GHG emissions as part of the assessment of regulatory alternatives and selection of the final regulatory approach. The safety assessment of the technologies in this final rule was informed by two NAS reports, an analysis of safety effects of HD pickups and vans using estimates from the DOT report on the effect of mass reduction and vehicle size on safety, and agency-sponsored safety testing and research. The agencies considered safety from the perspective of both direct effects and indirect effects.

In terms of direct effects on vehicle safety, research from NAS and Volpe, and direct testing of technologies like the ORNL tire work, indicate that there are no major safety hazards associated with the adoption of technologies that improve MDHD vehicle fuel efficiency

and GHG emissions or the increased use of alternative fuels and vehicle electrification. The findings suggest that the potential safety hazards identified during operation, maintenance, and crash scenarios can be prevented or mitigated by complying with safety regulations, voluntary standards, and industry best practices. Tire testing showed tire rolling resistance did not impact of Class 8 tractor-trailer stopping distance for the tires tested. For HD pickup and vans, mass reduction is anticipated to reduce the net incidence of highway fatalities, because of the beneficial effects of mass reduction in the majority of HD pickup and vans which weigh more than 4,594 lbs. Taken together, these studies suggest that the fuel efficiency improving technologies assessed in the studies can be implemented with no degradation in overall safety.

However, analysis anticipates that the indirect effect of these standards, by reducing the operating costs, will lead to increased travel by tractor-trailers and HD pickups and vans and, therefore, more crashes involving these vehicles.

#### X. Analysis of the Alternatives

As discussed in the NPRM and throughout this Preamble, in developing this program, the agencies considered a number of regulatory alternatives that could result in potentially fewer or greater GHG emission and fuel consumption reductions than the Phase 2 program we are adopting. This section summarizes the alternatives we considered and presents estimates of the CO<sub>2</sub> reductions and fuel savings associated with them. Although some of the alternatives considered for the FRM are identical to alternatives considered for the NPRM, the preferred alternative (*i.e.* the final rule) is actually more stringent than the preferred alternative that was proposed, and includes some elements of the NPRM's Alternative 4.

In developing alternatives, both agencies must consider a range of stringency. NHTSA must consider EISA's requirement for the MD/HD fuel efficiency program. In particular, 49 U.S.C. 32902(k)(2) and (3) contain the following three requirements specific to the MD/HD vehicle fuel efficiency improvement program: (1) The program must be "designed to achieve the maximum feasible improvement;" (2) the various required aspects of the program must be appropriate, cost-effective, and technologically feasible for MD/HD vehicles; and (3) the standards adopted under the program must provide not less than four model years of lead time and three model years of regulatory stability. In considering

these various requirements, NHTSA will also account for relevant environmental and safety considerations.

As explained in the Phase 1 rule, NHTSA has broad discretion in balancing the above factors in determining the improvement that the manufacturers can achieve. The fact that the factors may often be conflicting gives NHTSA significant discretion to decide what weight to give each of the competing policies and concerns and then determine how to balance them—as long as NHTSA's balancing does not undermine the fundamental purpose of the EISA: Energy conservation, and as long as that balancing reasonably accommodates “conflicting policies that were committed to the agency's care by the statute.”<sup>934</sup>

EPA also has significant discretion in considering a range of stringency. Section 202(a)(2) of the Clean Air Act requires only that the standards “take effect after such period as the Administrator finds necessary to permit the development and application of the requisite technology, giving appropriate consideration to the cost of compliance within such period.” This language affords EPA considerable discretion in how to weight the critical statutory factors of emission reductions, cost, and lead time. See 76 FR 57129–57130.

The alternatives presented here follow the format of the alternatives addressed in the NPRM. Among the alternatives are a preferred alternative (in this action, the “final program”), more stringent alternatives, and less stringent alternatives (including “no action” alternatives). As discussed in this Preamble's Sections II (Engines), III (Tractors), IV (Trailers), V (Vocational Vehicles), and VI (Pickups and Vans), NHTSA and EPA determined Alternative 3 to be the preferred alternative, or the final program, for each vehicle category. This Section X describes all of the alternatives considered, and provides context for the relative stringency associated with the final program.

#### A. What are the alternatives that the agencies considered?

The five alternatives below represent a broad range of potential stringency levels, and thus a broad range of associated technologies, costs and benefits for a HD vehicle fuel efficiency and GHG emissions program. All of the alternatives were modeled using the same methodologies described in Chapter 5 of the RIA.

The alternatives considered for the final rule were conceptually similar to (and for some elements, identical to) the alternatives considered for the proposal. The alternatives in order of increasing fuel efficiency and GHG emissions reductions are as follows:

1. No action, baseline
2. Less stringent than the proposal
3. Preferred alternative
4. Proposed (not FRM) standards with less lead time
5. More stringent standards than the proposal with less lead time

Comments on the alternatives overlapped with comments on the overall stringency of the proposed Phase 2 program. These comments were mixed. Some operators and manufacturers supported the least stringent alternatives. Many other commenters, however, including most non-governmental organizations, supported more stringent standards with less lead time. They generally supported Alternative 4. Many technology and component suppliers supported more stringent standards but with the proposed lead time, and thus generally supported the Alternative 3 timeframe. Vehicle manufacturers strongly opposed the more stringent standards and reduced lead time of Alternative 4. To the extent any of these commenters provided technical information to support their comments on stringency and lead time, it is discussed in Sections II through VI.

Many of the comments supporting more stringent standards stated that they would be “cost-effective.” In general, however, we did not find costs or cost-effectiveness to be a significantly limiting factor in determining the stringency of the standards. Rather, we found that actual technological feasibility and lead time to be the more limiting factors. Manufacturers and suppliers have limited research and development capacities, and although they have some ability to expand, that ability is constrained by the lead time required. Lead time includes time not only to design and develop a technology, but to bring it to market in reliable form. During the prototype stage, all prototype components must be available and extensive engine and vehicle tests must be conducted. The production start-up phase would follow. After that, significant efforts must be made to advance the system from a prototype to a commercial product, which typically takes about five years for complex systems. During this approximate five-year period, multiple vehicles will go through weather condition tests, long lead-time parts and

tools will be identified, and market launch and initial results on operating stability will be completed. Production designs will be released, all product components should be made available, production parts on customer fleets and weather road testing will be verified before finally launching production, and distribution of parts to the vehicle service network for maintenance and repair will be readied. See Section I.C above; see also RIA Chapter 2.3.9. New technologies then are ordinarily phased into the commercial market, so that fleet operators are assured of technology reliability and utility before making extensive purchases. Commenters supporting the more stringent alternatives based on cost-effectiveness generally did not address these very real lead time constraints.

#### (1) Alternative 1: No Action (The Baseline for Phase 2)

OMB guidance regarding regulatory analysis indicates that proper evaluation of the benefits and costs of regulations and their alternatives requires agencies to identify a baseline:

“You need to measure the benefits and costs of a rule against a baseline. This baseline should be the best assessment of the way the world would look absent the proposed action. The choice of an appropriate baseline may require consideration of a wide range of potential factors, including:

- Evolution of the market
- changes in external factors affecting expected benefits and costs
- changes in regulations promulgated by the agency or other government entities
- degree of compliance by regulated entities with other regulations

It may be reasonable to forecast that the world absent the regulation will resemble the present. If this is the case, however, your baseline should reflect the future effect of current government programs and policies. For review of an existing regulation, a baseline assuming no change in the regulatory program generally provides an appropriate basis for evaluating regulatory alternatives. When more than one baseline is reasonable and the choice of baseline will significantly affect estimated benefits and costs, you should consider measuring benefits and costs against alternative baselines. In doing so you can analyze the effects on benefits and costs of making different assumptions about other agencies' regulations, or the degree of compliance with your own existing rules. In all cases, you must evaluate benefits and costs against the same baseline. You should also discuss

<sup>934</sup> Cf. *Center for Biological Diversity v. National Highway Traffic Safety Admin.*, 538 F.3d 1172, 1194 (9th Cir. 2008). For further discussion see 76 FR 57198.

the reasonableness of the baselines used in the sensitivity analyses. For each baseline you use, you should identify the key uncertainties in your forecast.”<sup>935</sup>

A no-action alternative is also required as a baseline against which to measure environmental impacts of these standards and alternatives. NHTSA, as required by the National Environmental Policy Act, is documenting these estimated impacts in the EIS published with this final rule.<sup>936</sup>

The No Action Alternative for today's analysis, alternatively referred to as the “baseline” or “reference case,” assumes that the agencies would not issue new rules regarding MD/HD fuel efficiency and GHG emissions. That is, this alternative assumes that the Phase 1 MD/HD fuel efficiency and GHG emissions program's model year 2018 standards would be extended indefinitely and without change.

The agencies recognize that there are a number of factors that create uncertainty in projecting a baseline against which to compare the future effects of the alternatives. The composition of the future fleet—such as the relative position of individual manufacturers and the mix of products they each offer—cannot be predicted with certainty at this time. As reflected, in part, by the market forecast underlying the agencies' analysis, we anticipate that the baseline market for medium- and heavy-duty vehicles will continue to evolve within a competitive market that responds to a range of factors. Additionally, the heavy-duty vehicle market is diverse, as is the range of vehicle purchasers.

Heavy-duty vehicle manufacturers have reported that their customers' purchasing decisions are influenced by their customers' own determinations of minimum total cost of ownership, which can be unique to a particular

customer's circumstances. For example, some customers (e.g., less-than-truckload or package delivery operators) operate their vehicles within a limited geographic region and typically own their own vehicle maintenance and repair centers within that region. These operators tend to own their vehicles for long time periods, and sometimes for the entire service life of the vehicle. Their total cost of ownership is influenced by their ability to better control their own maintenance costs, and thus they can afford to consider fuel efficiency technologies that have longer payback periods, outside of the vehicle manufacturer's warranty period. Other customers (e.g. truckload or long-haul operators) tend to operate cross-country, and thus must depend upon truck dealer service centers for repair and maintenance. Some of these customers tend to own their vehicles for about four to seven years, so that they typically do not have to pay for repair and maintenance costs outside of either the manufacturer's warranty period or some other extended warranty period. Many of these customers tend to require seeing evidence of fuel efficiency technology payback periods on the order of 18 to 24 months before seriously *considering* evaluating a new technology for potential adoption within their fleet.<sup>937</sup> Purchasing decisions, however, are not based exclusively on payback period, but also include the considerations discussed in this section. For the baseline analysis, the agencies use payback period as a proxy for all of these considerations, and therefore the payback period used for the baseline analysis may be shorter than the payback periods industry typically identifies as thresholds for the further consideration of a technology. Some owners accrue relatively few vehicle miles traveled per year, such that they may be less likely to adopt new fuel efficiency technologies, while other owners who use their vehicle(s) with greater intensity may be even more willing to pay for fuel efficiency improvements. Regardless of the type of customer, their determination of minimum total cost of ownership involves the customer balancing their own unique circumstances with a heavy-duty vehicle's initial purchase price, availability of credit and lease options, expectations of vehicle reliability, resale value and fuel efficiency technology payback periods. The degree of the incentive to adopt additional fuel efficiency technologies also depends on customer expectations

of future fuel prices, which directly impacts customer expectations of the payback period.

Another factor the agencies considered is that other federal and state-level policies and programs are specifically aimed at stimulating fuel efficiency technology development and deployment. Particularly relevant to this sector are DOE's 21st Century Truck Partnership, EPA's voluntary SmartWay Transport program, and California's AB32 fleet requirements.<sup>938 939 940</sup> The future availability of more cost-effective technologies to reduce fuel consumption could provide manufacturers an incentive to produce more fuel-efficient medium- and heavy-duty vehicles, which in turn could provide customers an incentive to purchase these vehicles. The availability of more cost-effective technologies to reduce fuel consumption could also lead to a substitution of less cost-effective technologies, where overall fuel efficiency could remain fairly flat if buyers are less interested in fuel consumption improvements than in reduced vehicle purchase prices and/or improved vehicle performance and/or utility.

We have also applied the EIA's AEO estimates of future fuel prices; however, heavy-duty vehicle customers could have different expectations about future fuel prices, and could therefore be more or less inclined to apply new technology to reduce fuel consumption than might be expected based on EIA's forecast. We expect that vehicle customers will be uncertain about future fuel prices, and that this uncertainty will be reflected in the degree of enthusiasm to apply new technology to reduce fuel consumption.

Considering all of these factors, the agencies have approached the definition of the No Action Alternative separately for each vehicle and engine category covered by today's rules. Except as noted below, these baselines are largely the same as the proposed Alternatives 1a and 1b, which reflected different assumptions about the extent to which the market would pay for additional fuel-saving technology without new Phase 2 standards. The agencies received limited comments on these reference cases. Some commenters expressed support for the 1a baseline in the context of the need for the regulations, arguing that little improvement would occur without the regulations. Others supported the 1a

<sup>935</sup> OMB Circular A-4, September 17, 2003. Available at [http://www.whitehouse.gov/omb/circulars\\_a004\\_a-4](http://www.whitehouse.gov/omb/circulars_a004_a-4).

<sup>936</sup> NEPA requires agencies to consider a “no action” alternative in their NEPA analyses and to compare the effects of not taking action with the effects of the reasonable action alternatives to demonstrate the different environmental effects of the action alternatives. See 40 CFR 1502.2(e), and 1502.14(d). CEQ has explained that “[T]he regulations require the analysis of the no action alternative even if the agency is under a court order or legislative command to act. This analysis provides a benchmark, enabling decision makers to compare the magnitude of environmental effects of the action alternatives. [See 40 CFR 1502.14(c).]” \* \* \* Inclusion of such an analysis in the EIS is necessary to inform Congress, the public, and the President as intended by NEPA. [See 40 CFR 1500.1(a).]” Forty Most Asked Questions Concerning CEQ's National Environmental Policy Act Regulations, 46 FR 18026 (1981) (emphasis added).

<sup>937</sup> NAS 2010, Roeth et al. 2013, and Klemick et al. 2014.

<sup>938</sup> <http://energy.gov/eere/vehicles/vehicle-technologies-office-21st-century-truck>.

<sup>939</sup> <http://www3.epa.gov/smartway/>.

<sup>940</sup> State of California Global Warming Solutions Act of 2006 (Assembly Bill 32, or AB32).

baseline because they believe it more fully captures the costs. Some commenters thought it reasonable that the agencies consider both baselines, given the uncertainty in this area. No commenters opposed the consideration of both baselines. The agencies thus continued to analyze two different baselines for the final rules as we recognize that there are a number of factors that create uncertainty in projecting a baseline against which to compare the future effects of this action and the remaining alternatives. As was shown in the previous sections, the standards are supported by the analysis using either baseline.

For trailers, the agencies considered two No Action alternatives to cover a nominal range of uncertainty. The trailer category is unique in the context of this rulemaking because it is the only heavy-duty category not regulated under Phase 1. The agencies project that in 2018, about half of new 53' dry van and reefer trailers will have technologies qualifying for the SmartWay label for aerodynamic improvements and about 90 percent would have the lower rolling resistance tires. About half also have automatic tire inflation systems to maintain optimal tire pressure. For Alternative 1a as presented in this action (referred to as the "flat" baseline), this technology adoption remains constant after 2018. In the second case, Alternative 1b, the agencies projected that the combination of EPA's voluntary SmartWay program, DOE's 21st Century Truck Partnership, California's AB32 trailer requirements for fleets, and the potential for significantly reduced operating costs should result in continuing improvement to new trailers. The agencies projected that the fraction of the in-use fleet qualifying for SmartWay will continue to increase beyond 2027 as older trailers are replaced by newer trailers. We projected that these improvements will continue until 2040 when 75 percent of new trailers will be assumed to include skirts.

For vocational vehicles, the agencies considered one No Action alternative. For the vocational vehicle category the agencies recognized that these vehicles tend to operate over fewer vehicle miles travelled per year. Therefore, the projected payback periods for fuel efficiency technologies available for vocational vehicles are generally longer than the payback periods the agencies consider likely to lead to their adoption based solely on market forces. This is especially true for vehicles used in applications in which the vehicle operation is secondary to the primary business of the company using the

vehicle. For example, since the fuel consumption of vehicles used by utility companies to repair power lines would generally be a smaller cost relative to the other costs of repairing lines, fuel saving technologies would generally not be as strongly demanded for such vehicles. Thus, the agencies project that fuel-saving technologies will either not be applied or will only be applied as a substitute for more expensive fuel efficiency technologies, except as necessitated by the Phase 1 fuel consumption and GHG standards.

For tractors, the agencies considered two No Action alternatives to cover a nominal range of uncertainty. For Alternative 1a the agencies project that fuel-saving technologies will either not be applied or will only be applied as a substitute for more expensive fuel efficiency technologies to tractors (thereby enabling manufacturers to offer tractors that are less expensive to purchase), except as necessitated by the Phase 1 fuel consumption and GHG standards. In Alternative 1b the agencies estimated that some available technologies will save enough fuel to pay back fairly quickly—within the first six months of ownership. The agencies considered a range of information to formulate these two baselines for tractors.

Both public<sup>941</sup> and confidential historical information shows that tractor trailer fuel efficiency improved steadily through improvements in engine efficiency and vehicle aerodynamics over the past 40 years, except for engine efficiency which decreased or was flat between 2000 and approximately 2007 as a consequence of incorporating technologies to meet engine emission regulations. Today vehicle manufacturers, the Federal Government, academia and others continue to invest in research to develop fuel efficiency improving technologies for the future.

In public meetings and in meetings with the agencies, the trucking industry stated that fuel cost for tractors is the number one or number two expense for many operators, and therefore is a very important factor for their business. However, the pre-Phase 1 market suggests that tractor manufacturers and operators could be slow to adopt some

new technologies, even where the agencies have estimated that the technology would have paid for itself within a few months of operation. This phenomenon, which is discussed in Section IX.A, is often called the energy paradox. Consistent with the discussion above of reasons for needed lead time, tractor operators have told the agencies they generally require technologies to be demonstrated in their fleet before widespread adoption so they can assess the actual fuel savings for their fleet and any increase in cost associated with effects on vehicle operation, maintenance, reliability, mechanic training, maintenance and repair equipment, stocking unique parts and driver acceptance, as well as effects on vehicle resale value. Tractor operators often state that they would *consider* conducting an assessment of technologies when provided with data that show the technologies may payback costs through fuel savings within 18 to 24 months, based on their assumptions about future fuel costs. In other words they would treat this as a necessary condition, but generally would not consider it to be sufficient. In these cases, an operator may first conduct a detailed paper study of anticipated costs and benefits. If that study shows likely payback in 18 to 24 months for their business, the fleet may acquire one or several tractors with the technology to directly measure fuel savings, costs and driver acceptance for their fleet. Small fleets may not have resources to conduct assessments to this degree and may rely on information from larger fleets or observations of widespread acceptance of the technology within the industry before adopting a technology. This uncertainty over the actual fuel savings and costs and the lengthy process to assess technologies significantly slows the pace at which fuel efficiency technologies are adopted.

The agencies believe that using the two baselines addresses the uncertainties we have identified for tractors. The six-month payback period of Alternative 1b reflects the agencies' consideration of factors, discussed above, that could limit—yet not eliminate—manufacturers' tendencies to voluntarily improve fuel consumption. In contrast, Alternative 1a reflects a baseline for vehicles other than trailers wherein manufacturers either do not apply fuel efficiency technologies or only apply them as a substitute for more expensive fuel efficiency technologies, except as necessitated by the Phase 1 fuel consumption and GHG standards.

For HD pickups and vans, the agencies considered two No Action alternatives to cover a nominal range of

<sup>941</sup> Committee to Assess Fuel Economy Technologies for Medium- and Heavy-Duty Vehicles; National Research Council; Transportation Research Board (2010). "Technologies and Approaches to Reducing the Fuel Consumption of Medium- and Heavy-Duty Vehicles," (hereafter, "NAS 2010"). Washington, DC. The National Academies Press. Available electronically from the National Academies Press Web site at [http://www.nap.edu/catalog.php?record\\_id=12845](http://www.nap.edu/catalog.php?record_id=12845) (last accessed September 10, 2010).



uncertainty. In Alternative 1b the agencies considered additional technology application, which involved the explicit estimation of the potential to add specific fuel-saving technologies to each specific vehicle model included in the agencies' HD pickup and van fleet analysis, as discussed in Section VI. Estimated technology application and corresponding impacts depend on the modeled inputs. Also, under this approach a manufacturer that has improved fuel consumption and GHG emissions enough to achieve compliance with the standards is assumed to apply further improvements, provided those improvements reduce fuel outlays by enough (within a specified amount of time, the payback period) to offset the additional costs to purchase the new vehicle. These calculations explicitly account for and respond to fuel prices, vehicle survival and mileage accumulation, and the cost and efficacy of available fuel-saving technologies. Therefore, all else being equal, more technology is applied when fuel prices are higher and/or technology is more cost-effective. However, considering factors discussed above that could limit manufacturers' tendency to voluntarily improve HD pickup and van fuel consumption, Alternative 1b applies a 6-month payback period. In contrast, for Alternative 1a, the agencies project that fuel-saving technologies will either not be applied or only be applied as a substitute for more expensive fuel efficiency technologies, except as necessitated by the Phase 1 fuel consumption and GHG standards. The Method A sensitivity analysis presented in Section VI of the NPRM also examined other payback periods. In terms of impacts under reference case fuel prices, the payback period input plays a more significant role under the No-Action Alternatives (defined by a continuation of model year 2018 standards) than under the more stringent regulatory alternatives for HD pickups and vans described next.

#### (2) Alternative 2: Less Stringent Than the Preferred Alternative

For vocational vehicles and combination tractor-trailers, Alternative 2 represents a stringency level which is approximately half as stringent overall as the final standards. The agencies developed Alternative 2 to consider a continuation of the Phase 1 approach of applying off-the-shelf technologies rather than requiring the development of new technologies or fundamental improvements to existing technologies. For tractors and vocational vehicles, this also involved less integrated optimization of the vehicles and

engines. Put another way, Alternative 2 is not technology-forcing.<sup>942</sup> See, e.g., *Sierra Club v. EPA*, 325 F. 3d 374, 378 (D.C. Cir. 2003) (under a technology-forcing provision, EPA "must consider future advances in pollution control capability"); see also similar discussion in *Husqvarna AB v. EPA*, 254 F. 3d 195, 201 (D.C. Cir. 2001).

The agencies' decisions regarding which technologies could be applied to comply with Alternative 2 considered not only the use of off-the shelf technologies, but also considered other factors, such as how broadly certain technologies fit in-use applications and regulatory structure. The resulting Alternative 2 could be met with fewer technologies and lower penetration rates than those the agencies project will be used to meet the final Phase 2 standards. Alternative 2 is estimated to be achievable without the application of some technologies, at any level. These and other differences are described below by category. Overall, Alternative 2 for the final rules is conceptually similar to Alternative 2 in the NPRM. However, some changes have been made to reflect new information provided in public comments.

The agencies project that Alternative 2 combination tractor standards could be met by applying lower adoption rates of the projected technologies for Alternative 3. This includes a projection of slightly lower per-technology effectiveness for Alternative 2 versus 3. Alternative 2 also assumes that there would be little optimization of combination tractor powertrains.

The Alternative 2 for vocational vehicles assessed for these final rules does differ somewhat from the proposal because it reflects new duty cycles that weight idle emissions more heavily. The agencies project that the Alternative 2 vocational vehicle standard could be met without any use of strong hybrids or any other type of transmission technology. Rather, it could be met with off-the-shelf idle reduction technologies, low rolling resistance tires, and axle efficiency improvements.

The Alternative 2 trailer standards would apply to only 53-foot dry and refrigerated box trailers and could be met through the use of less effective aerodynamic technologies and higher rolling resistance tires versus what the

agencies projected could be used to meet Alternative 3 (i.e., the final standards).

As discussed above in Section VI, the HD pickup truck and van alternatives are characterized by an annual required percentage change (decrease) in the functions defining attribute-based targets for per-mile fuel consumption and GHG emissions. Under the standards in each alternative, a manufacturer's fleet would, setting aside any changes in production mix, be required to achieve average fuel consumption/GHG levels that increase in stringency every year relative to the standard defined for MY 2018 (and held constant through 2020) that establishes fuel consumption/GHG targets for individual vehicles. A manufacturer's specific fuel consumption/GHG requirement is the sales-weighted average of the targets defined by the work-factor curve in each year. Therefore, although the alternatives involve steady increases in the functions defining the targets, stringency increases faced by any individual manufacturer may not be steady if changes in the manufacturer's product mix cause fluctuations in the average fuel consumption and GHG levels required of the manufacturer. See Section VI for additional discussion of this topic. Alternative 2 represents a 2.0 percent annual improvement through 2025 in fuel consumption/GHG emissions relative to the work-factor curve in 2020. This would be 0.5 percent less stringent per year compared to the standards of Alternative 3.

For HD pickups and vans in the Method A analysis, NHTSA projects that most manufacturers could comply with the standards defining Alternative 2 by applying technologies similar to those that could be applied in order to comply with the Alternative 3 standards, but at lower application rates. In EPA's Method B analysis, the biggest technology difference EPA projects between Alternative 2 and the Alternative 3 final standards is that most manufacturers could meet the Alternative 2 standards without any use of stop-start or other mild or strong hybrid technologies.

The agencies are not adopting standards reflecting Alternative 2 for reasons of both policy and law. Technically feasible alternate standards are available that provide for greater emission reductions and reduced fuel consumption than provided under Alternative 2. These more stringent standards, which are being adopted, are feasible at reasonable cost, considering both per-vehicle and per-engine cost, cost-effectiveness, direct benefits to

<sup>942</sup> As noted in Section I.C, in this context, the term "technology-forcing" has a specific legal meaning and is used to distinguish standards that will effectively require manufacturers to develop new technologies (or to significantly improve technologies) from standards that can be met using off-the-shelf technology alone. Technology-forcing standards do not require manufacturers to use any specific technologies.



consumers in the form of fuel savings, and lead time. Consequently, the agencies do not believe that the modest improvements in Alternative 2 would be appropriate or otherwise reasonable under section 202(a)(1) and (2) of the Clean Air Act, or represent the “maximum feasible improvement” within the meaning of 49 U.S.C. 32902(k)(2).

### (3) Alternative 3: Preferred Alternative and Final Standards

The agencies are adopting Alternative 3 for HD engines, HD pickup trucks and vans, Class 2b through Class 8 vocational vehicles, Class 7 and 8 combination tractors, and trailers. Details regarding modeling of this final program are included in Chapter 5 of the RIA. Note that Alternative 3 for the final rules differs from the Alternative 3 in the NPRM. The differences are largely in response to significant comments on the proposed rule. Although some aspects of the final Alternative 3 are more aggressive than proposed (including adopting some aspects of the proposed Alternative 4), others are less aggressive. As a result of these changes, the preferred alternative in this final rule is projected to achieve more GHG emission reductions and more reductions of fuel consumption than the proposed alternative 4. See Section X.B below and RIA Chapter 5.

Unlike the Phase 1 standards where the agencies projected that manufacturers could meet the Phase 1 standards with off-the-shelf technologies only, the agencies project that meeting the Alternative 3 standards will require a combination of off-the-shelf technologies applied at higher market penetration rates and new technologies that are still in various stages of development and not yet in production. Although this alternative is technology-forcing, it must be kept in mind that the standards themselves are performance-based and thus do not mandate that any particular technology be used to meet the standards.<sup>943</sup> The agencies recognize that there is some uncertainty in projecting costs and effectiveness for those technologies not yet available in the market, but we do not believe, as discussed comprehensively in Sections II, III, IV, V, and VI, that such uncertainty is sufficient to render Alternative 3 beyond the reasonable or maximum feasible level of stringency for each of the engine and vehicle categories covered by this program. Moreover, we have explained what steps will be

needed to bring these technologies to the commercial market, and the lead time needed to do so. Given that nearly all of the final standards are performance-based rather than mandates of specific technologies, and given that the lead time for the most stringent standards in Alternative 3 is approximately 10 years, the agencies believe that the performance that is required by these stringency levels of Alternative 3 allows each manufacturer to choose to develop technology and apply it to their vehicles (and engines, where applicable) in a way that balances their unique business constraints and reflects their specific market position and customers’ needs.<sup>944</sup>

We have described in detail above, and also in Chapter 2 of the RIA, the precise bases for each of these standards (that is, for each segment covered under the program). Sections II through VI of this Preamble provide comprehensive explanations of the agencies’ assessment of the extent to which such standards could be met through the accelerated application of technologies and our reasons for concluding that the identified technologies for each of the vehicle and engine standards that constitute the updated Alternative 3 represent the maximum feasible (within the meaning of 49 U.S.C. 32902 (k)) and reasonable (for purposes of CAA section 202(a)(1) and (2)) based on all of the information available to the agencies at the time of this rulemaking. In particular, the agencies determined that many engine improvements could be achieved sooner than we projected in our NPRM analysis, some even sooner than projected as part of the Alternative 4 analysis.

### (4) Alternative 4: More Accelerated Than the Preferred Alternative in the NPRM

As indicated by its description in the title above, Alternative 4 represents standards that are effective on a more accelerated timeline in comparison to the timeline of in the proposed Alternative 3 standards. This alternative is unchanged from Alternative 4 in the proposal. The agencies believe that reanalyzing the same Alternative 4 provides a useful context for commenters who supported the proposed Alternative 4.

In the NPRM, Alternatives 3 and 4 were both designed to achieve similar fuel efficiency and GHG emission levels in the long term but with Alternative 4

being accelerated in its implementation timeline. Specifically, Alternative 4 reflects the same or similar standard stringency levels as the proposed Alternative 3, but 3 years sooner (2 years for heavy-duty pickups and vans), so that the final phase of the standards would occur in MY 2024, or (for heavy duty pickups and vans) 2025.

The agencies projected in the NPRM that meeting Alternative 4 combination tractor standards would require applying initially higher adoption rates of the projected technologies for Alternative 3. This included a projection of slightly higher per-technology effectiveness for Alternative 4 versus 3. Alternative 4 also assumes that there would be more optimization of combination tractor powertrains and earlier market penetration of engine waste heat recovery systems.

The agencies also projected that meeting the Alternative 4 vocational vehicle standard would require earlier adoption rates of the same technology packages projected for Alternative 3.

Meeting the Alternative 4 trailer standards would require earlier implementation of more effective aerodynamic technologies, including the use of aerodynamic skirts and boat tails. This would be in addition to implementing lower rolling resistance tires for nearly all trailers.

HD pickup truck and van standards defining Alternative 4 represent a 3.5 percent annual improvement in fuel consumption and GHG emissions through 2025 relative to the work-factor curves in 2020. This would require earlier adoption of all the Alternative 3 technologies.

As discussed above and in the feasibility discussions in Sections II–VI, we are adopting those elements of the proposed Alternative 4 where we have determined them to be feasible in the lead time provided. However, the agencies have determined that it is unlikely that all elements of Alternative 4 could be achieved by 2024. In fact, the agencies can only project that the engine improvements and some tire improvements will be achievable on the Alternative 4 timeline. Thus, we do not believe these alternative standards to be feasible overall, and we are consequently unable to accurately estimate costs for them. The agencies received many comments supporting the Alternative 4 standards where the commenter noted they supported them because they would be “cost-effective” based on the proposed analysis of costs. However, we do not consider this conclusion to be accurate. We do not believe the proposed analysis fully represents the costs for this alternative

<sup>943</sup> The one exception being design standards for certain non-aero trailers.

<sup>944</sup> Those few standards that are design-based rather than performance based reflect comments indicating that performance-based flexibility would not be necessary or helpful for certain markets.

because it included little additional costs related to pulling ahead the development of so many additional technologies. It also does not reflect any costs associated with a decrease in the in-use reliability and durability during the initial years of implementation. It does not reflect costs of design and deployment outside of normal design cycles, an example being the necessity of developing new engine platforms if WHR were to be applied at higher penetration rates by MY 2024. See RIA Chapter 2.7.5. As we have already noted, we did not find costs or cost-effectiveness to be a significantly limiting factor in determining the stringency of the standards. Rather, we found that actual technological feasibility and lead time to be the more limiting factors. In this respect, we found Alternative 4 to provide insufficient lead time for any of the standards—engine, pickups and vans, vocational vehicles, tractors, and trailers.

(5) Alternative 5: Even More Stringent Standards With Less Lead-Time

Alternative 5 represents even more stringent standards compared to Alternatives 3 and 4, as well as the same implementation timeline as Alternative 4. As discussed in the NPRM, and as repeated above and in the feasibility discussions in Sections II–VI, we are not adopting Alternative 5 because we cannot project that manufacturers can develop and introduce in sufficient quantities the technologies that could be used to meet Alternative 5 standards. No commenters provided any new information to refute this finding. We believe that for some or all of the categories, the Alternative 5 standards are simply technically infeasible within the lead time allowed. We have not fully

estimated costs for this alternative for tractors and vocational vehicles because we believe that there would be such substantial additional costs related to pulling ahead the development of so many additional technologies that we cannot accurately predict these costs. (Indeed, how can cost estimates for an alternative which essentially cannot be done at all be realistic?) We also believe this alternative, if it could somehow be effectuated, would result in a decrease in the in-use reliability and durability of new heavy-duty vehicles and that we do not have the ability to accurately quantify the costs that would be associated with such problems. Instead, we merely note that costs would be significantly greater than the estimated costs for Alternative 3, assuming (against our view) that such standards would be feasible at all.

*B. How do these alternatives compare in overall fuel consumption and GHG emissions reductions?*

The following tables compare the overall fuel consumption and GHG emissions reductions of each of the regulatory alternatives the agencies considered.

Note that for tractors, trailers, pickups and vans the agencies compared overall fuel consumption and GHG emissions reductions relative to two different baselines, described above in the section on the No Action alternative. Therefore, for tractors, trailers, pickups and vans two results are listed; one relative to each baseline, namely Alternative 1a and Alternative 1b.

Also note that the agencies analyzed pickup and van overall fuel consumption and emissions reductions and benefits and costs using the NHTSA’s CAFE model (Method A). In addition, the agencies used EPA’s

MOVES model to estimate pickup and van fuel consumption and emissions and a cost methodology that applied vehicle costs in different model years (Method B). In both cases, the agencies used a version of the CAFE model to estimate average per vehicle cost, and this analysis extended through model year 2030.<sup>945</sup> The agencies concluded that in these instances the choice of baseline and the choice of modeling approach (Method A versus Method B) did not impact the agencies’ decision to finalize Alternative 3.

The agencies are finalizing a more stringent program than proposed, so that the preferred alternative for the FRM (Alternative 3) achieves greater reductions and net benefits than the proposed program would have. Moreover, because the agencies analyzed the same Alternative 4 for the FRM as for the NPRM, the FRM preferred alternative also achieves greater reductions than Alternative 4 would have.

The regulatory impact analysis (RIA) accompanying today’s notice presents more detailed results of the agencies’ analysis.

(1) Impacts Using Analysis Method A

Table X–1 through Table X–4 summarize the key NHTSA estimates of the costs and benefit of the program using Method A. The first two tables show the costs and benefits using a 3 percent discount rate under both the flat and dynamic baselines. The third and fourth tables show the costs and benefits using a 7 percent discount rate for both baselines. Under all possible combinations of discount rate and baseline the net benefits from highest to lowest are as follows: Alternative 5; Alternative 3; Alternative 4; Alternative 2.

TABLE X–1—MY 2018–2029 LIFETIME SUMMARY OF PROGRAM BENEFITS AND COSTS, DISCOUNTED AT 3% (RELATIVE TO BASELINE 1a), METHOD A<sup>a</sup>

Vehicle segment	Alt 2	Alt 3	Alt 4	Alt 5
<b>Discounted pre-tax fuel savings (\$billion)</b>				
HD pickups and Vans .....	12.1	18.7	20.3	22.3
Vocational Vehicles .....	13.5	25.5	23.6	34.6
Tractors/Trailers .....	50.2	118.8	115.7	169.1
Total .....	75.7	163.0	159.6	225.9
<b>Discounted Total technology costs (\$billion)</b>				
HD pickups and Vans .....	3.1	6.8	8.2	9.9
Vocational Vehicles .....	1.6	6.6	7.1	9.5
Tractors/Trailers .....	9.0	11.0	11.6	26.8

<sup>945</sup> Although the agencies have considered regulatory alternatives involving standards increasing in stringency through, at the latest, 2027,

the agencies extended the CAFE modeling analysis through model year 2030 rather than model year 2027 in order to obtain more fully stabilized results

given projected product cadence, multiyear planning, and application of earned credits.

TABLE X-1—MY 2018–2029 LIFETIME SUMMARY OF PROGRAM BENEFITS AND COSTS, DISCOUNTED AT 3% (RELATIVE TO BASELINE 1a), METHOD A<sup>a</sup>—Continued

Vehicle segment	Alt 2	Alt 3	Alt 4	Alt 5
Total .....	13.7	24.4	26.9	46.2
<b>Discounted value of emissions reductions (\$billion)</b>				
HD pickups and Vans .....	3.4	5.3	5.7	6.3
Vocational Vehicles .....	5.2	9.8	9.1	13.3
Tractors/Trailers .....	21.9	50.9	50.9	73.4
Total .....	30.5	66.0	65.7	93.0
<b>Total costs (\$billion)</b>				
HD pickups and Vans .....	4.4	7.9	8.6	10.3
Vocational Vehicles .....	2.4	7.3	8.8	11.3
Tractors/Trailers .....	13.2	14.0	15.7	30.8
Total .....	20.0	29.2	33.1	52.4
<b>Total benefits (\$billion)</b>				
HD pickups and Vans .....	18.1	28.1	30.4	33.3
Vocational Vehicles .....	20.2	37.8	35.1	51.2
Tractors/Trailers .....	78.1	179.8	176.5	255.5
Total .....	114.1	245.7	242.0	340.0
<b>Net benefits (\$billion)</b>				
HD pickups and Vans .....	13.7	20.2	21.8	23.0
Vocational Vehicles .....	17.8	30.5	26.3	39.9
Tractors/Trailers .....	64.9	165.8	160.9	224.7
Total .....	94.1	216.5	208.9	287.6

**Note:**

<sup>a</sup>For an explanation of analytical Methods A and B, please see Section I.D; for an explanation of the less dynamic baseline, 1a, and more dynamic baseline, 1b, please see Section X.A.1.

TABLE X-2—MY 2018–2029 LIFETIME SUMMARY OF PROGRAM BENEFITS AND COSTS, DISCOUNTED AT 3% (RELATIVE TO BASELINE 1 b), METHOD A<sup>a</sup>

Vehicle segment	Alt 2	Alt 3	Alt 4	Alt 5
<b>Discounted pre-tax fuel savings (\$billion)</b>				
HD pickups and Vans .....	10.7	17.4	19.5	21.9
Vocational Vehicles .....	13.5	25.5	23.6	34.6
Tractors/Trailers .....	37.6	106.2	103.1	156.5
Total .....	61.8	149.1	146.2	213.0
<b>Discounted Total technology costs (\$billion)</b>				
HD pickups and Vans .....	2.8	6.4	7.5	9.8
Vocational Vehicles .....	1.6	6.6	7.1	9.5
Tractors/Trailers .....	8.8	10.7	11.3	26.6
Total .....	13.2	23.7	25.9	45.9
<b>Discounted value of emissions reductions (\$billion)</b>				
HD pickups and Vans .....	3.0	4.9	5.5	6.2
Vocational Vehicles .....	5.2	9.8	9.1	13.3
Tractors/Trailers .....	16.4	45.4	45.4	67.9
Total .....	24.6	60.1	60.0	87.4
<b>Total costs (\$billion)</b>				
HD pickups and Vans .....	4.0	7.4	8.6	10.0
Vocational Vehicles .....	2.4	7.3	8.8	11.3

TABLE X-2—MY 2018–2029 LIFETIME SUMMARY OF PROGRAM BENEFITS AND COSTS, DISCOUNTED AT 3% (RELATIVE TO BASELINE 1 b), METHOD A<sup>a</sup>—Continued

Vehicle segment	Alt 2	Alt 3	Alt 4	Alt 5
Tractors/Trailers .....	12.9	13.8	15.5	30.6
Total .....	19.3	28.5	32.9	51.9
<b>Total benefits (\$billion)</b>				
HD pickups and Vans .....	16.0	26.0	29.2	32.7
Vocational Vehicles .....	20.2	37.8	35.1	51.2
Tractors/Trailers .....	59.2	161.0	157.7	236.7
Total .....	95.4	224.8	222.0	320.6
<b>Net benefits (\$billion)</b>				
HD pickups and Vans .....	12.0	18.6	20.6	22.7
Vocational Vehicles .....	17.8	30.5	26.3	39.9
Tractors/Trailers .....	46.3	147.2	142.2	206.1
Total .....	76.1	196.3	189.1	268.7

**Note:**

<sup>a</sup>For an explanation of analytical Methods A and B, please see Section I.D; for an explanation of the less dynamic baseline, 1a, and more dynamic baseline, 1b, please see Section X.A.1.

TABLE X-3—MY 2018–2029 LIFETIME SUMMARY OF PROGRAM BENEFITS AND COSTS, DISCOUNTED AT 7% (RELATIVE TO BASELINE 1a) METHOD A<sup>a</sup>

Vehicle segment	Alt 2	Alt 3	Alt 4	Alt 5
<b>Discounted pre-tax fuel savings (\$billion)</b>				
HD pickups and Vans .....	7.1	10.9	11.9	13.0
Vocational Vehicles .....	7.1	13.4	12.5	18.5
Tractors/Trailers .....	26.6	62.7	61.8	90.7
Total .....	40.8	87.0	86.2	122.2
<b>Discounted Total technology costs (\$billion)</b>				
HD pickups and Vans .....	2.2	4.8	5.9	7.0
Vocational Vehicles .....	1.1	4.4	4.8	6.5
Tractors/Trailers .....	6.2	7.4	8.0	18.5
Total .....	9.5	16.6	18.7	32.0
<b>Discounted value of emissions reductions (\$billion)</b>				
HD pickups and Vans .....	3.1	4.8	5.2	5.7
Vocational Vehicles .....	4.2	7.8	7.3	10.7
Tractors/Trailers .....	16.9	39.5	39.3	57.1
Total .....	24.2	52.1	51.8	73.5
<b>Total costs (\$billion)</b>				
HD pickups and Vans .....	3.0	5.5	6.1	7.3
Vocational Vehicles .....	1.5	4.8	5.8	7.5
Tractors/Trailers .....	8.5	9.2	10.2	20.7
Total .....	13.0	19.5	22.1	35.5
<b>Total benefits (\$billion)</b>				
HD pickups and Vans .....	11.7	18.0	19.6	21.5
Vocational Vehicles .....	12.1	22.6	21.1	31.0
Tractors/Trailers .....	47.1	108.0	106.8	155.1
Total .....	70.9	148.6	147.5	207.6
<b>Net benefits (\$billion)</b>				
HD pickups and Vans .....	8.7	12.5	13.5	14.2

TABLE X-3—MY 2018–2029 LIFETIME SUMMARY OF PROGRAM BENEFITS AND COSTS, DISCOUNTED AT 7% (RELATIVE TO BASELINE 1a) METHOD A<sup>a</sup>—Continued

Vehicle segment	Alt 2	Alt 3	Alt 4	Alt 5
Vocational Vehicles .....	10.6	17.8	15.3	23.5
Tractors/Trailers .....	38.6	98.8	96.6	134.4
Total .....	58.0	129.1	125.4	172.1

**Note:**

<sup>a</sup>For an explanation of analytical Methods A and B, please see Section I.D; for an explanation of the less dynamic baseline, 1a, and more dynamic baseline, 1b, please see Section X.A.1.

TABLE X-4—MY 2018–2029 LIFETIME SUMMARY OF PROGRAM BENEFITS AND COSTS, DISCOUNTED AT 7% (RELATIVE TO BASELINE 1b), METHOD A<sup>a</sup>

Vehicle segment	Alt 2	Alt 3	Alt 4	Alt 5
<b>Discounted pre-tax fuel savings (\$billion)</b>				
HD pickups and Vans .....	6.3	10.1	11.5	12.9
Vocational Vehicles .....	7.1	13.4	12.5	18.5
Tractors/Trailers .....	19.9	56.1	55.2	84.1
Total .....	33.3	79.6	79.2	115.5
<b>Discounted Total technology costs (\$billion)</b>				
HD pickups and Vans .....	2.0	4.4	5.3	7.0
Vocational Vehicles .....	1.1	4.4	4.8	6.5
Tractors/Trailers .....	6.1	7.3	7.8	18.4
Total .....	9.2	16.1	17.9	31.9
<b>Discounted value of emissions reductions (\$billion)</b>				
HD pickups and Vans .....	2.7	4.4	5.0	5.6
Vocational Vehicles .....	4.2	7.8	7.3	10.7
Tractors/Trailers .....	12.7	35.3	35.1	52.8
Total .....	19.6	47.5	47.4	68.2
<b>Total costs (\$billion)</b>				
HD pickups and Vans .....	2.7	5.1	6.0	7.1
Vocational Vehicles .....	1.6	4.8	5.8	7.5
Tractors/Trailers .....	8.4	9.0	10.1	20.6
Total .....	12.7	18.9	21.9	35.2
<b>Total benefits (\$billion)</b>				
HD pickups and Vans .....	10.4	16.7	19.0	21.3
Vocational Vehicles .....	12.1	22.7	21.1	31.0
Tractors/Trailers .....	35.9	96.8	95.6	143.9
Total .....	58.4	136.2	135.7	195.2
<b>Net benefits (\$billion)</b>				
HD pickups and Vans .....	7.7	11.6	13.0	14.2
Vocational Vehicles .....	10.5	17.9	15.3	23.5
Tractors/Trailers .....	27.5	87.8	85.5	123.3
Total .....	45.7	117.3	113.8	161.0

**Note:**

<sup>a</sup>For an explanation of analytical Methods A and B, please see Section I.D; for an explanation of the less dynamic baseline, 1a, and more dynamic baseline, 1b, please see Section X.A.1.

Table X-5 and Table X-6 show the estimated fuel savings and GHG reductions considering alternatives

under both baselines. Under both baselines, the reductions in both fuel and GHG's are highest under Alternative

5, higher under Alternative 3 than Alternative 4, and lowest under Alternative 2.

TABLE X-5—MY 2018–2029 LIFETIME FUEL SAVINGS AND GHG EMISSIONS REDUCTIONS BY VEHICLE SEGMENT, RELATIVE TO BASELINE 1a, METHOD A<sup>a</sup>

MY 2018–2029 Total	Fuel reductions (billion gallons)	Upstream & downstream GHG reductions (MMT)
<b>Alternative 2</b>		
HD Pickup Trucks/Vans .....	6.2	77
Vocational Vehicles .....	6.5	86
Tractors and Trailers .....	23.4	323
Total .....	36.1	486
<b>Alt. 3—Preferred Alternative</b>		
HD Pickup Trucks/Vans .....	9.8	120
Vocational Vehicles .....	12.3	162
Tractors and Trailers .....	55.6	767
Total .....	77.7	1049
<b>Alt. 4</b>		
HD Pickup Trucks/Vans .....	10.6	130
Vocational Vehicles .....	11.4	150
Tractors and Trailers .....	54.0	744
Total .....	76.0	1024
<b>Alt. 5</b>		
HD Pickup Trucks/Vans .....	11.6	143
Vocational Vehicles .....	16.7	219
Tractors and Trailers .....	78.8	1087
Total .....	107.1	1449

**Note:**

<sup>a</sup>For an explanation of analytical Methods A and B, please see Preamble Section I.D; for an explanation of the flat baseline, 1a, and dynamic baseline, 1b, please see Preamble Section X.A.1.

TABLE X-6—MY 2018–2029 LIFETIME FUEL SAVINGS AND GHG EMISSIONS REDUCTIONS BY VEHICLE SEGMENT, RELATIVE TO BASELINE 1b METHOD A<sup>a</sup>

MY 2018–2029 Total	Fuel reductions (billion gallons)	Upstream & downstream GHG reductions (MMT)
<b>Alternative 2</b>		
HD Pickup Trucks/Vans .....	5.5	68
Vocational Vehicles .....	6.5	86
Tractors and Trailers .....	17.5	242
Total .....	29.5	396
<b>Alt. 3—Preferred Alternative</b>		
HD Pickup Trucks/Vans .....	9.0	111
Vocational Vehicles .....	12.4	162
Tractors and Trailers .....	49.7	685
Total .....	71.1	958
<b>Alt. 4</b>		
HD Pickup Trucks/Vans .....	10.1	125
Vocational Vehicles .....	11.4	150
Tractors and Trailers .....	48.1	663
Total .....	69.6	938

TABLE X-6—MY 2018–2029 LIFETIME FUEL SAVINGS AND GHG EMISSIONS REDUCTIONS BY VEHICLE SEGMENT, RELATIVE TO BASELINE 1b METHOD A<sup>a</sup>—Continued

MY 2018–2029 Total	Fuel reductions (billion gallons)	Upstream & downstream GHG reductions (MMT)
<b>Alt. 5</b>		
HD Pickup Trucks/Vans .....	11.3	140
Vocational Vehicles .....	16.7	219
Tractors and Trailers .....	72.9	1006
Total .....	100.9	1365

**Note:**  
<sup>a</sup>For an explanation of analytical Methods A and B, please see Preamble Section I.D; for an explanation of the flat baseline, 1a, and dynamic baseline, 1b, please see Preamble Section X.A.1.

TABLE X-7—ANNUAL GHG AND FUEL REDUCTIONS RELATIVE TO THE DYNAMIC BASELINE IN 2040 AND 2050 USING METHOD A<sup>a</sup>

	Upstream & downstream GHG Reductions (MMT CO <sub>2</sub> EQ)		Fuel reductions (billion gallons)	
	2040	2050	2040	2050
Alt. 2 Less Stringent—Total .....	49.1	57.3	3.6	4.2
Tractors and Trailers .....	30.9	36.6	2.2	2.7
HD Pickups & Vans .....	6.7	7.3	0.6	0.6
Vocational Vehicles .....	11.5	13.4	0.8	0.9
Alt. 3 Preferred—Total .....	139	166	10.2	12.3
Tractors and Trailers .....	102	124	7.4	9.0
HD Pickups & Vans .....	12.6	13.8	1.0	1.2
Vocational Vehicles .....	24.1	28.2	1.8	2.1
Alt. 4 Less Lead Time—Total .....	116	136	8.6	10.1
Tractors and Trailers .....	83.1	98.7	6.0	7.2
HD Pickups & Vans .....	12.6	13.8	1.1	1.2
Vocational Vehicles .....	20.0	23.1	1.5	1.7
Alt. 5 More Stringent—Total .....	167	194	12.4	14.2
Tractors and Trailers .....	124	146	9.0	10.6
HD Pickups & Vans .....	14.8	16.2	1.3	1.3
Vocational Vehicles .....	27.8	32.0	2.1	2.3

**Note:**  
<sup>a</sup>For an explanation of analytical Methods A and B, please see Section I.D; for an explanation of the flat baseline, 1a, and dynamic baseline, 1b, please see Section X.A.1.

TABLE X-8—ANNUAL GHG AND FUEL REDUCTIONS RELATIVE TO THE FLAT BASELINE IN 2040 AND 2050 USING METHOD A<sup>a</sup>

	Upstream & downstream GHG Reductions (MMT CO <sub>2</sub> EQ)		Fuel reductions (billion gallons)	
	2040	2050	2040	2050
Alt. 2 Less Stringent—Total .....	63.7	75.2	4.7	5.5
Tractors and Trailers .....	44.2	53.0	3.2	3.8
HD Pickups & Vans .....	8.0	8.8	0.6	0.7
Vocational Vehicles .....	11.5	13.4	0.9	1.0
Alt. 3 Preferred—Total .....	153	184	11.3	13.7
Tractors and Trailers .....	115	141	8.4	10.2
HD Pickups & Vans .....	13.8	15.1	1.1	1.3
Vocational Vehicles .....	24.1	28.2	1.8	2.2
Alt. 4 Less Lead Time—Total .....	131	153	9.6	11.4
Tractors and Trailers .....	96.5	115	7.0	8.3
HD Pickups & Vans .....	14.0	15.3	1.1	1.3
Vocational Vehicles .....	20.0	23.1	1.5	1.8
Alt. 5 More Stringent—Total .....	181	213	13.4	15.6
Tractors and Trailers .....	137	163	9.9	11.8
HD Pickups & Vans .....	16.0	17.6	1.4	1.5
Vocational Vehicles .....	27.8	32.0	2.1	2.3

**Note:**  
<sup>a</sup>For an explanation of analytical Methods A and B, please see Section I.D; for an explanation of the flat baseline, 1a, and dynamic baseline, 1b, please see Section X.A.1.

(2) Impacts Using Analysis Method B the program using Method B for calendar years 2040 and 2050. Table X–9 summarizes EPA’s estimates of GHG and fuel reductions of

TABLE X–9—ANNUAL GHG AND FUEL REDUCTIONS RELATIVE TO THE FLAT BASELINE IN 2040 AND 2050 USING METHOD B<sup>a</sup>

	Upstream & downstream GHG Reductions (MMT CO <sub>2</sub> EQ)		Fuel reductions (billion gallons)	
	2040	2050	2040	2050
Alt. 2 Less Stringent—Total .....	71.8	84.0	5.4	6.3
Tractors and Trailers .....	44.2	53.0	3.2	3.8
HD Pickups & Vans .....	16.1	17.6	1.4	1.5
Vocational Vehicles .....	11.5	13.4	0.9	1.0
Alt. 3 Preferred—Total .....	166.5	198.9	12.5	14.9
Tractors and Trailers .....	115.5	140.7	8.4	10.2
HD Pickups & Vans .....	26.9	30.0	2.2	2.6
Vocational Vehicles .....	24.1	28.2	1.9	2.1
Alt. 4 More Stringent—Total .....	144.1	168.5	10.9	12.7
Tractors and Trailers .....	96.5	115.1	7.0	8.3
HD Pickups & Vans .....	27.7	30.3	2.3	2.6
Vocational Vehicles .....	20.0	23.1	1.5	1.8
Alt. 5 More Stringent—Total .....	196.8	230.0	14.8	17.2
Tractors and Trailers .....	136.9	162.9	9.9	11.8
HD Pickups & Vans .....	32.2	35.2	2.7	3.0
Vocational Vehicles .....	27.8	32.0	2.1	2.4

**Note:**

<sup>a</sup>For an explanation of analytical Methods A and B, please see Section I.D; for an explanation of the flat baseline, 1a, and dynamic baseline, 1b, please see Section X.A.1.

## XI. Natural Gas Vehicles and Engines

NGV America estimates that approximately 65,200 natural gas trucks were operating in the U.S. in 2014. This represents 0.3 percent of the heavy-duty vehicle fleet in the U.S. based on EPA’s estimated 17.5 million heavy-duty trucks operating in the U.S.<sup>946 947</sup> While medium and heavy-duty natural gas vehicles continue to be produced and sold, the collapse of crude oil prices starting in 2014 has reduced the economic incentive to expand the use of natural gas fueled trucks. Although these natural gas versions are similar in many ways to their petroleum counterparts, there are significant differences. There are also both similarities and differences in the production and distribution of natural gas relative to gasoline and diesel fuel.

This combined rulemaking by EPA and NHTSA is designed to regulate two separate characteristics of heavy-duty vehicles: Emissions of GHGs and fuel consumption (especially petroleum fuels). The use of natural gas as a heavy-duty fuel can impact both of these. In the case of diesel or gasoline powered vehicles, there is a close relationship between GHG emissions and petroleum consumption. The situation is different

for non-petroleum fuels like natural gas. Natural gas also has a lower carbon content than petroleum fuels. Thus, a natural gas vehicle that could achieve the same fuel efficiency as a diesel-powered vehicle would emit about 20 percent less CO<sub>2</sub> when operating on natural gas and consume no petroleum. A natural gas vehicle with the same fuel efficiency as a gasoline vehicle would emit about 30 percent less CO<sub>2</sub>.<sup>948</sup> However, current natural gas engines are 5 to 15 percent less energy efficient than diesel engines. This means that, although natural gas engines are typically less fuel efficient, they can have lower CO<sub>2</sub> emissions and consume much less petroleum. In Phase 1, the agencies balanced these factors by applying the gasoline and diesel CO<sub>2</sub> standards to natural gas engines based on the engine type of the natural gas engine. Fuel consumption for these vehicles is then calculated according to their tailpipe CO<sub>2</sub> emissions. In essence, this applies a one-to-one relationship between fuel efficiency and tailpipe CO<sub>2</sub> emissions for all vehicles, including natural gas vehicles. The agencies determined that this approach would likely create a small balanced incentive for natural gas use. See 76 FR 57123; see

also 77 FR 51705 (August 24, 2012) and 77 FR 51500 (August 27, 2012) (EPA and NHTSA, respectively, further elaborating on basis for having Phase 1 apply at the tailpipe only, including for alternative fueled vehicles); see also *Delta Construction Co. v. EPA*, 783 F. 3d 1291 (D.C. Cir. 2015) (dismissing challenge to Phase 1 GHG standards as being arbitrary for applying only on a tailpipe basis).

For Phase 2, the agencies have reevaluated the potential use of natural gas in the heavy-duty sector and the impacts of such use. As discussed below, based on our review of the literature and external projections we believe that the use of natural gas is unlikely to become a major fuel source for medium and heavy-duty vehicles during the Phase 2 time frame. Thus, since we project natural gas vehicles to have little impact on both overall GHG emissions and fuel consumption during the Phase 2 time frame, the agencies see no need to make fundamental changes to the Phase 1 approach for natural gas engines and vehicles.

As part of this rulemaking, the agencies developed a lifecycle analysis of natural gas used by the heavy-duty truck sector, which is presented in Section XI.B. We also present the results of analyses projecting the future use of natural gas by heavy-duty trucks, identify a number of potential emission control technologies, and discuss the

<sup>946</sup> Yborra, Stephe; NGV Market Briefing to EPA and NHTSA, August 12, 2014.

<sup>947</sup> MOVES2014; <http://www3.epa.gov/otaq/models/moves/index.htm>.

<sup>948</sup> Methane emissions above the heavy-duty 0.1 g/bhp-hr methane tailpipe standard must be accounted for and offsets the lower CO<sub>2</sub> tailpipe emissions.



approaches that could help to reduce the methane emissions from natural gas trucks in the future. A more detailed discussion of these analyses and issues can be found in RIA Chapter 13.

#### *A. Natural Gas Engine and Vehicle Technology*

Both gasoline and diesel vehicles can be designed or modified to use natural gas. Several engine parameters and characteristics come into play in comparing engines powered by natural gas with engines powered by conventional fuels.

Gasoline-fueled engines are typically spark-ignition engines that rely on stoichiometric combustion, which means that essentially all the oxygen from the engine's intake air is consumed in the combustion process. Converting a gasoline-fueled engine to run on natural gas involves changing the hardware used to store and deliver fuel to the engine, but the combustion strategy remains largely unchanged. The engine must be recalibrated for the different fuel properties, but combustion typically remains stoichiometric. In addition, the catalysts may require significant changes to enable the heavy-duty engine to comply with the emission standards.

Diesel-fueled engines are compression-ignition engines that rely on lean-burn combustion, which means that the engine takes in a substantial quantity of excess air (oxygen) that is not consumed in the combustion process. Engines usually have turbochargers to compress the intake air, which allows for greater power output and thermodynamic efficiency. Converting a diesel-fueled engine to run on natural gas may involve a minimal set of changes to engine calibrations to maintain lean-burn operation and the overall operating characteristics of a compression-ignition engine, although there are substantial changes to the fuel storage and delivery systems. Compressed ignition natural gas engines either require the use of a pilot injection of a small amount of diesel fuel to initiate the combustion event when the natural gas is directly injected, or more commonly, a mixture (never more than 50 percent natural gas) of natural gas and diesel fuel is combusted for fumigated natural gas engines. It is also possible to convert a diesel-fueled engine to run on natural gas by adding a spark plug. The option of changing the calibration strategy to rely on stoichiometric combustion would allow for simpler engine design and operation, but it would come at a cost of higher fuel consumption and CO<sub>2</sub> emissions.

Engines running on natural gas are capable of meeting the same criteria and GHG emission standards that apply for gasoline and diesel engines, although complying with the methane tailpipe emission standard has posed a challenge for engine manufacturers up to this point. In the case of reducing PM and CO<sub>2</sub> emissions, there is an inherent advantage for natural gas. In contrast, engines must be properly calibrated and maintained to avoid high emission rates for NO<sub>x</sub>, HC, and CO.

On-vehicle fuel storage for natural gas is also an important design parameter. The most common method today is compressed natural gas (CNG), which involves storing the fuel as a gas at very high pressure (up to ~3600 psi) to increase the density of the fuel, although the fuel remains less dense than diesel fuel. Compared to diesel fuel, CNG increases vehicle weight (because of heavier high pressure fuel tanks) and generally reduces the range relative to gasoline or diesel vehicles. Nevertheless, CNG technology is readily available and does not involve big changes for operators. The alternative is to extensively cool the fuel so that it can be stored as liquefied natural gas (LNG) at a lower pressure, which involves more extensive hardware changes for managing the fuel as a cryogenic liquid. LNG fuel storage also involves a substantial weight increase, but LNG has a higher density than CNG so LNG vehicles can store much more fuel than CNG vehicles in the same volume. LNG technology is available for a limited number of truck models, mostly for line-haul service where range is a paramount consideration. The cryogenic fuel requires substantial changes in hardware and procedures for refueling stations and operators. An additional difference from CNG is that because LNG must be kept cool to prevent evaporation, significant losses will occur if a vehicle is not used frequently enough. For example, an LNG vehicle left parked over a period of multiple days will eventually vent the fuel to prevent tank failure, as the system takes on heat from the surrounding environment and the pressure increases.

#### *B. GHG Lifecycle Analysis for Natural Gas Vehicles*

This section is organized into three sections. The first section summarizes the upstream emissions associated with natural production and distribution. The second section summarizes the downstream emissions associated with the actual use of the fuel. The last section summarizes the results of the lifecycle emissions analysis and provides a comparison between natural

gas lifecycle and diesel fuel lifecycle emissions. Only the overall results of the lifecycle emissions analysis between natural gas and diesel fuel are presented here, with more detail provided in Chapter 13 of the RIA.

##### (1) Upstream Emissions

Upstream methane emissions (occurring in natural gas production, processing, transmission, storage and distribution) have been estimated and summarized in the annual EPA report Inventory of U.S. Greenhouse Gas Emissions and Sinks (GHG Inventory) for the United Nations Framework Convention on Climate Change (UNFCCC). As a basis for estimating the lifecycle impact of natural gas use by heavy-duty trucks, we used the year 2014 methane emission estimates in the most recent GHG Inventory, published in 2016. Substantial amounts of new information on methane emissions from oil and gas systems have become available recently from a number of channels, including EPA's GHG Reporting program, industry organizations, and various research studies. EPA reviewed this information and revised its estimates of methane emissions from natural gas and petroleum facilities for the 2016 GHG Inventory. Comparing the most recent GHG Inventory estimate for 2013 to the previous GHG Inventory for 2013, methane emissions are about one third higher for the aggregated natural gas system than the previous estimate. The GHG Inventory also includes the quantity of carbon dioxide which is coproduced with methane throughout the natural gas system and emitted to the atmosphere through venting, flaring, and as fugitive emissions. Since the GHG Inventory only represents U.S.-based methane and carbon dioxide emissions, it does not estimate the GHG emissions caused by the production of natural gas in Canada which is imported to the U.S. The imported Canadian natural gas comprises about 10 percent of U.S. natural gas consumption. To estimate the GHG emissions from this Canadian natural gas, we assume that it has the same GHG emissions profile as U.S.-produced natural gas.

The GHG Inventory is updated annually to account for new emission sources (e.g., new natural gas wells), updated data, emission factors and/or methodologies, and to account for changes in emissions due to policy changes, regulatory changes and changes in industry practices. The GHG Inventory reflects emission reductions due to existing state regulations, National Emission Standards for Hazardous Air Pollutants (NESHAP)

promulgated by EPA in 1999,<sup>949</sup> the New Source Performance Standards (NSPS) promulgated by EPA in 2012,<sup>950</sup> and Natural Gas Star (a flexible, voluntary partnership that encourages oil and natural gas companies to adopt proven, cost-effective technologies and practices that improve operational efficiency and reduce methane emissions).<sup>951</sup>

Emission estimates in the GHG Inventory are generally bottom-up estimates which are per-unit (compressor, pneumatic valve, etc.) emission estimates based on measured or calculated emission rates from such emission sources.

In addition to the national-level data available through the GHG Inventory, facility-level petroleum and natural gas systems data are also available through EPA's Greenhouse Gas Reporting Program (GHGRP).<sup>952</sup> These data represent a significant step forward in understanding GHG emissions from this sector and EPA expects that it will be an important tool for the agency and the public to analyze emissions, and to understand emission trends. EPA is using GHGRP data to update emission estimates in the GHG inventory, and we plan to continue to leverage GHGRP data to update future GHG Inventories.

The EPA-promulgated 2012 New Source Performance Standards (NSPS OOOO) will reduce emissions of ozone precursors from natural gas facilities and have methane and hazardous air pollutant reduction co-benefits. The NSPS standards require that emissions from natural gas wells that are hydraulically fractured be controlled using flaring or reduced emission completion (REC) technology from completions and workovers starting in 2012. RECs used by natural gas well drillers capture the natural gas emissions that occur during well completion, instead of venting or flaring the emissions. Starting in January 2015, RECs are required for natural gas well completions and workovers. The NSPS also regulates the emissions from certain new natural gas production equipment, including dehydrator vents and condensate tanks.

The Energy Information Administration (EIA) projects natural

gas production to increase by about 19 percent by 2025. However, as noted in the 2016 Second Biennial Report of the United States of America, EPA projects emissions of methane to increase, by only 5 percent during this timeframe; thus, methane emissions in 2025 are expected to be 12 percent lower than in 2014 per equivalent volume of natural gas being produced.

EPA is taking additional steps to reduce the emissions of methane from natural gas and oil production facilities. On May 12, 2016, EPA finalized regulations (2016 NSPS OOOOa) which, among other things, include methane standards for oil and gas equipment used across the oil and gas sources currently only regulated for VOCs, and require the use of reduced emissions completions at hydraulically fractured oil wells.<sup>953</sup> In March of 2016, the U.S. EPA and Canadian Environment and Climate Change Canada (ECCC) announced plans to regulate emissions from existing oil and gas sources.<sup>954 955 956</sup> The goal of these various actions is to achieve an aggregated 40 to 45 percent reduction in methane emissions relative to methane emissions in 2012. The lifecycle analysis presented here and in RIA Chapter 13 attempts to represent GHG emissions in the year 2025, but probably overestimates those emissions because the analysis does not take into account the 2016 NSPS, or any future action that would address existing sources.

In the GHG Inventory, emissions associated with powering the units or equipment (*i.e.*, compressors, pumps) used in natural gas production, processing, transmission and distribution are aggregated with all the other fossil fuel combustion activities. Rather than attempt to disaggregate those specific GHG emissions from the rest of the process emissions in the GHG Inventory, we instead used the estimated emissions for these sources provided by GREET.

## (2) Downstream Emissions

Downstream emissions associated with natural gas differ between CNG

and LNG. We discuss the emissions of both types below.

### (a) Compressed Natural Gas (CNG)

Natural gas used as CNG is compressed at the retail stations that sell the CNG and the fleet facilities which fuel the CNG fleet vehicles. Thus, it is typically off-loaded from the broader natural gas system where the vehicles using CNG are refueled. To get the natural gas to the CNG retail facilities, which are mostly located in or near urban areas, the natural gas is normally shipped through the distribution system downstream of the natural gas transmission system. CNG trucks are then refueled at the retail stations providing CNG. Each time a CNG refueling event occurs, a small amount of natural gas is released to the environment. We estimated the volume of CNG emitted by this equipment during refueling based on past data collected on these types of fueling fittings (described in RIA Chapter 13.1.2.1). Since CNG storage systems are designed handle very high pressures, they must be designed to have no leaks, so the CNG could remain stored in the CNG tanks indefinitely. However, should a leak occur, the very high pressure at which CNG is stored dramatically increases fugitive emissions. We do not have any data to suggest that fugitive emissions from CNG trucks and assume for this analysis that CNG fugitive emissions from CNG storage at retail/fleet facilities and by trucks is zero. However, we recognize that this clearly underestimates the methane emissions from these storage facilities since they are unlikely to be leak-free in every instance.

Stored at 3600 psi the energy density of CNG is only about 25 percent of the energy density of diesel fuel. This lower energy density is a disincentive for using CNG in long haul trucks because it limits the vehicle's range. However, as described in the Chapter 13.1.3.1 of the RIA, using an adsorbent for natural gas (ANG) could improve the energy density of CNG, which would make it a better candidate for natural gas storage for long range combination trucks.<sup>957</sup> Or, if used to store CNG at the same density, could reduce the compression energy required to compress the CNG since it could be stored at a lower pressure.

<sup>949</sup> Oil and Natural Gas Sector: Emission Standards for New and Modified Sources; 40CFR 60, May 12, 2016.

<sup>954</sup> <https://www.whitehouse.gov/the-press-office/2016/03/10/us-canada-joint-statement-climate-energy-and-arctic-leadership>.

<sup>955</sup> <https://blog.epa.gov/blog/2016/03/epa-taking-steps-to-cut-methane-emissions-from-existing-oil-and-gas-sources>.

<sup>956</sup> Canada achieving methane emissions reductions from its natural gas sector is important to the US GHG footprint because about 10 percent of the natural gas consumed in the US is imported from Canada.

<sup>957</sup> Menon, V.C., Komarneni, S. 1998 "Porous Adsorbents for Vehicular Natural Gas Storage: A Review," *Journal of Porous Materials* 5, 43-58 (1998); Burchell, T "Carbon Fiber Composite Adsorbent Media for Low Pressure Natural Gas Storage" Oak Ridge National Laboratory.

<sup>949</sup> National Emission Standards for Hazardous Air Pollutants (NESHAP): For the Oil and Natural Gas Production and Natural Gas Transmission and Storage, Final Rule, 40 CFR part 63, subpart HH; June 17, 1999.

<sup>950</sup> Oil and Natural Gas Sector: New Source Performance Standards and National Emission Standards for Hazardous Air Pollutants Reviews; Final Rule, 40 CFR parts 60 and 63, Environmental Protection Agency, August 16, 2012.

<sup>951</sup> [www3.epa.gov/gasstar/](http://www3.epa.gov/gasstar/).

<sup>952</sup> See 40 CFR part 98, subparts PP and RR.

## (b) Liquefied Natural Gas (LNG)

A primary reason for liquefying natural gas is that it allows storing the natural gas at about 60 percent of the density of diesel fuel, which is more than twice as dense as CNG. For this reason, LNG is a primary fuel being considered by long haul trucks.

Liquefaction is the first step downstream of the natural gas production, processing and distribution system for making LNG available to trucks. This step involves cooling the natural gas until it undergoes a phase change from a gas to a liquid at a low pressure. LNG plants are configured differently depending on their ultimate capacity. Large LNG export facilities produce 5 million metric tons, or more, per year of LNG and the economy of scale of these large plants supports the significant addition of capital to reduce their operating costs and energy use. An LNG plant solely producing LNG for truck fuel would likely be significantly smaller (*i.e.*, 0.1 million metric tons per year) and have a poorer economy of scale than the LNG export facilities. Their energy efficiency would be expected to be much lower on a percentage basis. The California Air Resources Board estimated that the liquefaction plants used for producing truck LNG fuel are 80 percent efficient, compared to 90 percent efficient for LNG export facilities.<sup>958</sup> In other words, the amount of energy used to liquefy the natural gas would be equivalent to the energy content 10 to 20 percent of the natural gas coming into the facility. CARB recently conducted its lifecycle assessments for LNG assuming both 90 percent efficiency value as well as 80 percent efficiency due to the uncertainty of where the LNG would be sourced from (this assessment by CARB is solely for illustrative purposes—to qualify for credit under the Low Carbon Fuel Standard (LCFS), the actual LNG plant performance would need to be the basis for any submission for requesting credit under the LCFS). For this lifecycle analysis of LNG as a truck fuel, we assume that LNG plants are 80 percent efficient, which is consistent with the types of LNG plants that would be dedicated producers of LNG for transportation purposes. We also estimated the fugitive methane emissions at the plant, as well as carbon dioxide emissions emitted by the processes which liquefy the natural gas. Because LNG plants are located separate from the retail facilities, they can be

located to access the lowest cost feedstock. This means the natural gas for LNG can be sourced from the larger natural gas transmission pipelines which are upstream of the distribution pipelines. Once the natural gas is liquefied at the liquefaction plant, it is stored in an insulated storage tank to keep the LNG liquefied.

LNG is typically transported to the retail station using insulated trailers designed specifically for transporting LNG. Boil-off emissions can occur during transport, but only if the temperature of the LNG increases to the point the pressure relief valve opens. However, since the LNG is super cooled, boil off events are likely to be rare. LNG is also stored in an insulated storage tank at the retail facility. Heat gain in the storage tank could eventually lead to boil-off emissions. Service stations with little LNG demand are at a higher risk of boil-off emissions compared to service stations which have a significant throughput volume. LNG stations could be configured to avoid boil-off events to the atmosphere, such as venting to a co-located CNG facility, venting to a nearby natural gas pipeline, or oxidizing the methane to carbon dioxide. In the absence of other information, we used CARB's estimate of boil-off emissions for LNG transportation by the tanker truck between the LNG plant and retail outlets and from LNG retail facilities.<sup>959</sup>

LNG vehicles generally refuel LNG retail outlets or fleet refueling facilities much the same as other vehicles. However, because the fuel is under pressure, when the refueling nozzle is disconnected from the LNG tank nozzle, a small amount of methane is released to the environment. We estimated the volume of LNG emitted by this equipment during refueling based on past data collected on these types of fueling fittings (described in RIA Chapter 13). In addition, operators sometimes reduce the pressure in the truck's LNG tank to speed up the refueling process, which can emit methane as well. In some cases the retail station is equipped with another hose and associated piping to vent the excess gas to the retail stations' storage tank where it would usually condense back to a liquid due to the lower temperature of that tank, or perhaps be vented to a natural gas pipeline. However, for those retail outlets without such vent lines to the storage tank, the operator may simply vent the truck's storage tank to the atmosphere. We estimated the emissions for a boil-off event or venting an LNG tank prior to refueling as part

of a sensitivity analysis for our lifecycle analysis.

## (c) Comparing CNG to LNG

The differences between CNG and LNG refueling patterns are important. Only a single facility, the retail outlet, is required for distributing CNG, while LNG requires both a liquefaction plant and a retail outlet and a means for transporting the LNG from the liquefaction plant to retail. Relying on a single facility simplifies the logistics of providing CNG and reduces the opportunity for methane leakage to the environment. However, this emissions disadvantage of LNG compared to CNG is offset somewhat because LNG is expected to access natural gas from the upstream transmission system (due to lower prices), which avoids methane emissions associated with the downstream natural gas distribution system.

## (d) Vehicle Emissions

There are several different ways that diesel heavy-duty engines can be configured to use natural gas as a fuel. The first is a spark ignition (Otto cycle) natural gas (SING) engine. The SING heavy duty engine burns the fuel stoichiometrically and uses a three-way catalyst, and some also add an oxidation catalyst to provide the greatest emissions reduction. In this case the engine compression ratio is reduced similar to that of a gasoline engine and thus its thermal efficiency is lower than a diesel-like engine by about 10–15 percent.

The second is a direct injection natural gas (DING), diesel cycle. The DING engine uses a small quantity of diesel fuel (pilot injection) or a glow plug as ignition sources. As the injection system for the diesel fuel does not have the capability of greater injection quantities, this option has no dual-fuel properties. On the other hand, an optimization of the pilot injection can be made to achieve lower emissions. An advanced high pressure direct injection (HPDI) fuel system combining the injection of both diesel fuel and natural gas can be used for lean burn combustion. This enables the engine to maintain the efficiency advantage of a compression ignition engine while running mainly CNG/LNG.

The third is a mixed-fuel natural gas (MFNG), diesel cycle. In a mixed-fuel engine, natural gas is mixed with intake air before induction to the cylinder and diesel fuel is used as ignition source. Mixed-fuel vehicle/engine means any vehicle/engine engineered and designed to be operated on the original fuel(s), or a mixture of two or more fuels that are

<sup>958</sup> Detailed California-Modified GREET Pathway for Liquefied Natural Gas (LNG) from North American and Remote Natural Gas Sources, Version 1.0, California Air Resources Board, July 20, 2009.

<sup>959</sup> *Ibid.*

combusted together. Engine results have shown that the efficiency of the engine could decrease by about 2–5 percent in mixed-fuel mode compared to diesel mode and that the diesel replacement was approximately 40–60 percent.

Each of these natural gas engine types has its merits. The SING engine is less costly, but is less fuel efficient and because of the lower compression ratio it has less torque than the DING and MFNG diesel cycle engines. Furthermore, the SING engine usually is designed for a shorter lifespan. The DING engine is likely the most expensive because of the special natural gas/diesel fuel injection system and large required amount of natural gas (LNG or CNG) storage since the truck must run on natural gas. However, because the truck can run almost completely on natural gas, the DING engine has the potential to more quickly pay down the higher investment cost of the natural gas truck. The MFNG engine provides the truck owner the flexibility to operate either on both natural gas and diesel fuel, or solely on diesel fuel, but at the expense of a slower natural gas investment pay down rate because at most 60 percent of the fuel it consumes can be natural gas.

Phase 1 set methane emission standards for both CNG and LNG trucks, so it is important to separate those trucks built before 2014 from those built in 2014 and later. The trucks built before 2014 only needed to meet standards for nonmethane hydrocarbon (NMHC) and other criteria pollutants, which means that the methane emissions from these trucks are unregulated. Our certification data show that the methane tailpipe emissions from these trucks/buses ranges from 2–5 g/bhp-hr for both spark ignition (gasoline type) and compression ignition (diesel type) engines.

For 2014 and later, DING and MFNG natural gas trucks or natural gas conversions of 2014 and later diesel trucks, the trucks must meet a 0.1 g/bhp-hr methane emission standard in the case of a larger truck engine tested with an engine dynamometer, and a 0.05 g/mile methane emission standard in the case of smaller trucks tested on a chassis dynamometer.<sup>960</sup> For SING engines, the methane standards take effect in 2016.<sup>961</sup> Natural gas truck manufacturers are allowed to offset methane emissions exceeding the methane emission standard by

converting the methane emission exceedances into CO<sub>2</sub> equivalent emissions and using CO<sub>2</sub> credits. For the natural gas engine certifications that EPA received for 2014, 2015 and 2016, the truck manufacturers chose to continue to emit high levels of methane (up to 2 g/bhp-hr) and use carbon dioxide credits to offset those emissions. We do not know whether this practice will continue in the future; however, for evaluating the lifecycle impacts of natural gas heavy-duty trucks, we assume that natural gas trucks emit higher amounts of methane than the standard. It is worth noting that, because manufacturers have less experience controlling methane emissions, the potential exists for deterioration or malfunction of the engines, fuel supplies, or associated emission control devices on these trucks to occur in such a manner to result in higher methane emissions in actual use. We have not specifically accounted for the potential for increased methane emissions from high-emitter natural gas trucks.

Some amount of combustion gases typically leaks into the crankcase across the piston rings (blow-by). These crankcase emissions generally include some unburned fuel along with other combustion products, and for natural gas engines, this includes methane. The crankcase of the spark ignition engines is vented into the intake of the engines; thus, any methane that ends up in the crankcase is rerouted back to the engine where it would be combusted. For compression ignition engines, however, the crankcase emissions are allowed to be vented into the exhaust pipe downstream of the aftertreatment devices, and therefore can be released to the atmosphere, provided the manufacturer measures them and includes them in the total emissions. This means that crankcase emissions of methane count against the Phase 1 methane standard. Another potential source of methane emissions from CNG and LNG trucks is fugitive emissions from the engine and from the piping which routes the fuel to the engine. Thus, either while parked or operated, this part of the vehicle fuel and engine systems could leak methane to the environment (which is different from boil-off emissions from LNG trucks discussed below). We do not have data nor did we develop an estimate for these potential fugitive emissions from these types of in-use leaks. If the natural gas vehicles are well maintained, these emissions are likely to be very low.

The thermal efficiency (the ratio of energy converted to work versus energy consumed) of the natural gas engine also

plays a role in the lifecycle emissions of the truck. Natural gas engines are generally less efficient than their gasoline and diesel counterparts. Furthermore, manufacturers often choose to produce spark-ignition stoichiometric natural gas engines for use in diesel applications. Spark-ignition natural gas engines can be as much as 15 percent less efficient than compressed ignition engines which operate on diesel fuel. In our lifecycle analysis, we provide two different sensitivities for natural gas vehicles assuming that they are 5 percent and 15 percent less efficient.

An important difference between CNG and LNG is the way in which the fuels are stored on the vehicle. The CNG is contained in a permanently sealed system while the LNG system is potentially open to the environment (depending on operating patterns). Provided that there are no leaks in the storage system, the CNG truck is inherently low (zero) emitting with respect to evaporative emission and a parked truck would contain the CNG indefinitely. However, this is not so for LNG trucks, which would have very high emissions if the truck were to be parked so long that its entire contents would boil off and be emitted to the environment. Methane venting emissions mean loss of fuel for the operator, which creates a disincentive to allow the fuel to warm to the point of venting. Nevertheless, even occasional venting events can have significant impacts. Thus, EPA remains concerned about boil-off emissions from LNG truck fuel storage systems. When the liquefied natural gas is pumped into the truck LNG tanks, it is “supercooled,” meaning that the pressure of the LNG is well below the pressure at which the natural gas vent valve would relieve the LNG pressure. If the truck is driven extensively, the drawdown of liquid level will reduce the pressure in the storage tank which will cause some of the fuel to boil off and the heat of vaporization would thus cool the rest of the liquid in the LNG storage tank. It is possible that the fuel would maintain its supercooled temperature, or possibly even cool further below its supercooled temperature, the entire time until the LNG is completely consumed.

Unless the truck is driven enough to consume the LNG fuel while it is still at the very low-temperature and low-pressure, it will warm due to the ambient temperature gradient through the tank wall, and vaporize, causing the temperature and pressure of the LNG to rise. When the pressure reaches a maximum of 230 psi a safety release valve releases the methane gas to vent

<sup>960</sup> An exception is that small volume, heavy-duty natural gas truck manufacturers are exempt from EPA's GHG regulations.

<sup>961</sup> See 76 FR 57192, 40 CFR 1036.108(a)(2) and 1037.104(c) (which is proposed to be redesignated as 40 CFR 86.189–14(k)(5)).

excess pressure. There are two industry standards used to design tanks to reduce the temperature increase, one for a 3-day hold time<sup>962</sup> and one for a 5-day hold time.<sup>963</sup> Hold time is the time elapsed between the LNG refueling and venting.

A large amount of methane can be released with each boil-off event. If aware of the impending boil-off, such as when the truck is being maintained, the truck driver could hook up the LNG tank to a hose which would vent the natural gas emissions to a CNG system which could reuse the boil-off natural gas as CNG, or vent the natural gas emission to a natural gas pipeline. Otherwise the boil-off emission would simply vent to the atmosphere. If the truck had 200 gallons of LNG storage capacity, the estimated quantity of boil-off emissions would range from 3 to 9 gallons of LNG for each boil-off event depending on the fill level of the LNG tank, assuming that the boil-off event results in a drop of pressure in the LNG tank from 230 psi to 170 psi. Each boil-off event has the potential to release on the order of 5,300–15,800 grams of CH<sub>4</sub> which equates to 132–400 kilograms of CO<sub>2</sub>-equivalent emissions, using a methane global warming potential (GWP) of 25 (assessed over 100 years).<sup>964</sup> If the vehicle continues to sit for five more days and boil-off events occur each day to several times per day as the tank vents and rebuilds in pressure, the sum total of the boil-off events can result in over a million grams of CO<sub>2</sub>-equivalent emissions.

### (3) Results of Lifecycle Analysis

To estimate the lifecycle impact of natural gas used by heavy-duty trucks, we totaled the estimated CO<sub>2</sub>, CH<sub>4</sub>, N<sub>2</sub>O emissions for the upstream and downstream portions of the natural gas system. The methane and nitrous oxide emissions are converted to carbon dioxide-equivalent emissions using the appropriate GWP conversion factors. The GWP conversion factors EPA currently uses in this analysis are for a 100-year timeframe, are 25 and 298 for methane and nitrous oxide, respectively.<sup>965</sup>

To establish the impacts of natural gas use in the heavy-duty fleet, it was

necessary to compare the lifecycle impacts of natural gas against the base fuel it is replacing, which generally is diesel fuel. The lifecycle impact of diesel fuel was estimated by the 2015 GREET model for the current production and use of diesel fuel. In 2015, the National Energy Technology Laboratory (NETL) updated its diesel fuel lifecycle analysis to assess diesel fuel use by trucks in the year 2014.<sup>966</sup> The revised analysis shows much higher upstream emissions compared to GREET, but much lower truck GHG emission compared to GREET, and on balance is slightly lower than GREET. Thus, if we used the NETL lifecycle analysis, on a relative basis, natural gas trucks would appear slightly higher emitting than diesel engines.

To illustrate the relative full lifecycle impact of natural gas-fueled heavy-duty vehicles compared to diesel fueled heavy-duty vehicles, we assessed two different scenarios. The first is a conversion of a 2014 or later diesel engine to use CNG. Of the tens of thousands of heavy-duty natural gas trucks currently in use, most are of this type. It is likely that nearly all CNG conversions being done in 2021 and later will be for vehicles subject to the 2014 and 2016 methane emissions standards. Thus, for this analysis we assume that all converted natural gas trucks will need to comply with the methane standards. The methane standard requires heavy-duty trucks to comply with a 0.1 g/bhp-hr or a 0.05 g/mile methane tailpipe standard. Based on certification data for post-2014 CNG trucks, the trucks emit from 0.7 to 2 g/bhp-hr methane and thus require the use of CO<sub>2</sub> emission credits to show compliance with the methane standard. For the purposes of this review, we assume that these trucks emit 1 gram of methane per brake horsepower hour. We provide two sensitivities to capture the lower thermal efficiencies of natural gas trucks: 5 percent less thermally efficient (thermal high) which is representative of a diesel cycle engine and 15 percent less energy efficient (thermal low, which is 10 percent worse thermal efficiency than the 5 percent less thermally efficient case) which is

representative of a gasoline cycle engine.

The second scenario we assessed is a combination LNG tractor trailer (LNG is most common with tractors because it provides a greater range of operation). While the fuel storage in this case is LNG (as opposed to CNG in the case above), the engine options are similar to the above case (diesel and gasoline cycle as represented by the thermal efficiency sensitivities). Also similar to the CNG case, we assume that these engines continue to emit 1 gram per brake-horsepower-hour of methane despite being subjected to either the 0.1 gram per brake horsepower-hour or the 0.05 gram per mile methane emission standard. We make two different assumptions with respect to refueling and boil off emissions. In the LNG average case, we assume a modest quantity of refueling and boil-off methane emissions as estimated by GREET. The second boil-off emission estimate is a sensitivity analysis which assumes that the LNG storage tank is either vented to the atmosphere each time the driver refills his tank, or that there is a boil-off event for each LNG tank filling. As discussed above, we do not expect such high refueling and boil-off emissions to be common practices for newer trucks that are operated regularly. However, as the use of these trucks decreases as they age and are sold into the secondary market, the risk for refueling and boil-off emission events increases—this estimate provides a simple sensitivity emission estimate. The relative lifecycle analysis is shown in Figure XI–1.

A third comparison made in Figure XI–1 is the relative tailpipe-only emissions for diesel and natural gas trucks. The quantity of carbon dioxide, methane and nitrous oxide emissions from a diesel truck is from GREET. The carbon dioxide emissions from a natural gas-fueled truck is calculated and is based on the carbon-hydrogen content of methane. The methane emissions from a natural gas-fueled truck is based on natural gas truck certification data (and so does not include any methane emissions from the natural gas storage tanks onboard the truck nor other fugitive emissions).

<sup>962</sup> National Fire Protection Association 52, Compressed Natural Gas (CNG) Vehicular Fuel System Code, 2002 Edition.

<sup>963</sup> SAE International (2008) SAE J2343: Recommended Practice for LNG Medium and Heavy-Duty Powered Vehicles. Warrendale, Pennsylvania.

<sup>964</sup> See Section XI.D.(2)(a) for a discussion of different values for the GWP of methane.

<sup>965</sup> These global warming potential values are based on the Fourth Assessment Report authored by the Intergovernmental Panel on Climate Change.

<sup>966</sup> Cooney, Greg of Booze Allen Hamilton; Approaches to Developing a Cradle-to-Grave Lifecycle Analysis of Conventional Petroleum Fuels Produced in the U.S. with an Outlook to 2040; for the National Energy Technology Laboratory (NETL), October 6, 2015.

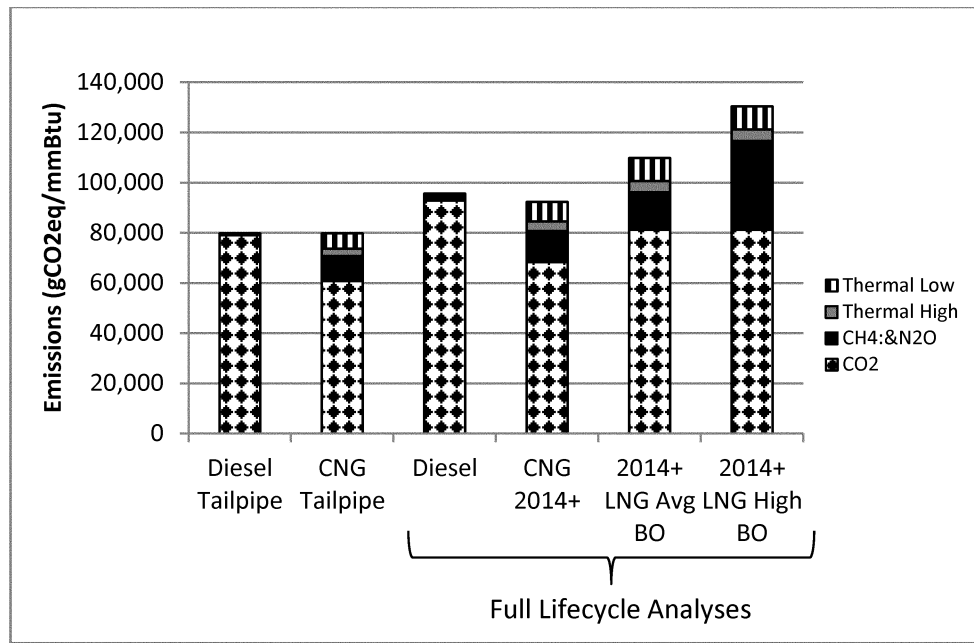

**Figure XI-1 Full Lifecycle Analyses (except tailpipe only emissions) of Diesel, CNG and LNG Trucks (Projected Upstream Methane Emissions in 2025, methane GWP of 25)**

The first two bars of Figure XI–1 show that based solely on tailpipe emissions (with thermal efficiency adjustments and assuming 1 g/bhp-hr methane emissions at the truck), CNG trucks are estimated to emit about 10 percent less GHG emissions than diesel engines if the engine is only 5 percent less efficient than a diesel engine, and about the same GHG emissions if the engine is 15 percent less efficient than a diesel engine. The four full lifecycle analyses represented by the right four bars in the figure show that CNG trucks are estimated to emit less GHG emissions than diesel trucks, although if their thermal efficiency is much lower (15 percent less than the diesel fueled engine) their GHG emissions would decrease to 5 percent lower than diesel trucks.

Figure XI–1 also shows that LNG trucks with an average extent of boil-off emissions can have about the same greenhouse gas footprint as diesel trucks, provided the engines' energy efficiency is only 5 percent lower than diesels. However, if the LNG engine is 15 percent less energy efficient than the diesel fuel engine, the GHG emissions of the LNG truck would be higher. In addition, an LNG truck with refueling or high boil-off emissions, would emit about one third more GHG emissions than diesel fuel trucks. From a lifecycle perspective, LNG trucks appear higher emitting than CNG trucks largely because of the low thermal efficiency of

the small liquefaction facilities. If a fleet of LNG trucks were to access LNG from a large, LNG export facility, which are much more energy efficient than the smaller liquefaction facilities, the relative lifecycle impacts of the LNG trucks would be much better.

It is important to point out the uncertainties associated with the lifecycle estimates provided in the above figures. As discussed above, there is uncertainty in both the upstream and downstream methane emission estimates for natural gas facilities and equipment, and the trucks that consume natural gas. There is also uncertainty in the diesel fuel lifecycle analysis conducted by GREET and NETL. Finally, the lifecycle analysis is sensitive to the GWP factor used to assess methane and nitrous oxide, and if a different GWP value were to be used, it would affect the relative lifecycle impact of natural gas relative to diesel in heavy-duty trucks (see Chapter 13.1.4 of the RIA for sensitivity analyses regarding upstream methane emissions and the use of different GWP factors).

We compared our lifecycle emission estimates for natural gas, relative to diesel fuel, with the estimates provided by the California Air Resources Board (CARB) for its Low Carbon Fuel Standard (LCFS). For our emissions estimate used in the comparison we used the carbon dioxide-equivalent (CO<sub>2</sub>eq) emissions estimated for 2014 and later engines, which must comply with a methane tailpipe emissions

standard, and assumed that the engine was 5 percent less thermally efficient than a comparable diesel engine. Both analyses used GWPs based on 100 year timescale (*i.e.*, a GWP of 25 for methane and 298 for nitrous oxide).<sup>967</sup> For the CARB emissions estimates, we used the estimates made for what CARB terms “illustrative purposes” using the values printed in the April 3, 2015 workshop handouts.<sup>968</sup> CARB estimates that CNG engines emit 86 percent of the CO<sub>2</sub>eq emissions as a diesel truck using the EER-adjusted values which reflects 11 percent lower energy efficiency than a diesel truck. When we adjust our analysis to reflect a truck which is 11 percent less efficient than a diesel truck, our analysis estimates that CNG engines emit 89 percent of the CO<sub>2</sub>eq emissions as a diesel truck. An important reason why CARB estimates lower CNG truck GHG emissions than our analysis is that a much larger portion of the electricity used to compress natural gas is renewable in California than the rest of the country. Also, our analysis accounts for the recent improvements in the GHG Inventory which shows higher natural gas upstream emissions. Using the same assumption that natural gas trucks are 11 percent less efficiently, CARB estimates LNG engines emit about 94

<sup>967</sup> See Section XI.D.(2)(a) for a discussion of different values for the GWP of methane.

<sup>968</sup> CA–GREET 1.8b versus 2.0 CI Comparison Table, LCFS Workshop Handout, California Air Resources Board, April 3, 2015.

percent of the CO<sub>2</sub>eq emissions. After adjusting our analysis to also assume that trucks are 11 percent less efficient, our natural gas lifecycle analysis estimates LNG trucks emit 106 percent of the CO<sub>2</sub>eq emissions as a diesel truck. The reasons why are LNG truck emission are so much higher than CARB's is because we assume that LNG liquefaction plants are only 80 percent efficient as opposed to CARB's assumption that LNG liquefaction plants are 90 percent efficient. Also CARB assumes no boil-off or venting emissions from LNG trucks and for this comparison, we used our more modest boil-off and venting assumption, as described above. Overall, our estimates seem to be consistent to those estimated by CARB when we account for the different assumptions used in the respective analyses.

The lifecycle analysis at proposal comparing the GHG impacts of natural gas versus diesel fuel use by heavy-duty trucks did receive some comments. Probably the most prevalent comment is that EPA was underestimating methane emissions from the upstream natural gas sector. As noted above, the analysis for this final rule increased the estimate of methane emissions from the upstream natural gas sector by about one third. Other comments suggested that the Agencies should find emissions data or estimate methane emissions from the potential methane emission points for which there was no data to make such an estimate in our lifecycle analysis. The final rule natural gas lifecycle analysis does make methane emission estimates at some of those likely methane emission points for which we did not have data, nor make any estimates. Some commenters stated that the natural gas lifecycle analysis should be dropped because a similar lifecycle analysis was not conducted for other alternative fuels. The agencies chose to do a natural gas lifecycle analysis because of some of the projections for a rapid transition of heavy-duty trucks to natural gas, and because of methane's potency as a greenhouse gas. Other comments are presented and discussed in Section 12.3 of the RTC.

### C. Projected Use of LNG and CNG

We reviewed several sources to estimate how much natural gas is currently being used and is projected to be used by heavy-duty trucks. Projections for this emerging technology range from 7 percent of new heavy-duty vehicle sales to over 40 percent by 2040. Large uncertainties exist even since the

2014 NAS First Report was written.<sup>969</sup> We believe the EIA projections are the most credible for capturing recent trends, and for projecting future natural gas use by heavy-duty trucks. There are several factors that support this assessment.

First, in its 2014 Annual Energy Outlook (AEO), EIA estimates that natural gas fueled 0.4 percent of the energy use of heavy-duty trucks in 2014. This estimate is consistent with the fraction of the heavy-duty fleet which is fueled by natural gas as estimated by the industry.<sup>970</sup>

Second, the EIA projection is based on an economic analysis which considers the increased cost of manufacturing a natural gas truck over a diesel truck, the fuel savings for using natural gas instead of diesel fuel, and whether the payback time of the fuel savings against the increased truck cost would result in purchases of natural gas trucks. As part of this analysis, EIA assumes that lighter heavy-duty trucks would use CNG, which is a lower cost technology suited for the shorter driving distances for these trucks. The long haul trucks, however, require larger on-board stores of fuel to extend the driving range which is satisfied by storing the natural gas as a liquid. As noted earlier, LNG has about 60 percent of the energy density of diesel fuel, compared to CNG which has only 25 percent of the energy density of diesel fuel. To satisfy the long driving range of the long haul trucks, EIA assumed that they would use LNG rather than CNG. The assumptions used by EIA for conducting its economic analysis are reasonable.

Third, EIA is one of the several organizations in the world which collects fuel pricing data and projects future fuel prices using a sophisticated modeling platform. One of the most important assumptions in projecting the future use of natural gas in the transportation sector is the relative price of natural gas to the price of diesel fuel. Thus, we started with the EIA methodology and updated the diesel and natural gas prices in our analysis using the most recent AEO projections.

In 2015, the price of natural gas purchased by industrial users was less than \$5 per million BTU. The price of crude oil has been volatile during 2015 as the Brent crude oil price started at about \$50 per barrel, but decreased to under \$30 per barrel, but now (Spring

2016) seems to be selling in the range of \$30 to \$40 dollars per barrel. EIA reported the average retail diesel fuel price in 2015 was about \$2.70 cents per gallon.<sup>971</sup> When comparing the natural gas spot market price on a diesel equivalent basis to the diesel fuel price, it appears that natural gas is priced about one quarter of the diesel fuel price. However, if used as compressed natural gas, the natural gas must be distributed through smaller distribution pipeline system that exists in cities, which increases the price of the natural gas. Then the natural gas must be compressed and stored at a retail outlet, and then dispensed to CNG trucks. The estimated retail price of CNG is \$2.29 on a diesel gallon equivalent (DGE) basis, or about \$0.41 DGE less than diesel fuel. LNG plants are assumed to be located close to large transmission pipelines away from cities, thus, it is sourced from lower cost natural gas. However, for producing LNG, the natural gas must be liquefied, shipped to retail outlets, stored and then dispensed to LNG trucks. These steps add substantially to the price of the LNG and the estimated retail price of LNG is \$2.71 DGE, or about the same as diesel fuel.

In its 2015 AEO projections, EIA estimates that crude oil prices in the upcoming years will increase slightly and are projected to reach \$140/bbl in 2040. Natural gas prices are also expected to increase only slightly over this period.

Fifth, the assumptions regarding payback used by EIA seemed reasonable. EIA projects that natural gas trucks begin to be purchased when the payback times are 4 years or less based on a survey conducted by the American Trucking Association. The 2014 NAS Phase 2 First Report cites the payback for the extra cost of natural gas trucks as 2 years, but other sources report a longer return closer to 4 years.<sup>972</sup>

For many fleets, the perceived payback times are too long to be interested in purchasing natural gas trucks without subsidies to compensate for the higher purchase price. According to EIA data, half the natural gas consumption by cars and trucks is in California, a state that subsidizes the purchase price of natural gas vehicles, and also subsidizes the cost of natural gas dispensing stations. The Low Carbon Fuel Standard in place in California also incentivizes natural gas use because natural gas is considered to

<sup>969</sup> B. Tita, *Slow Going for Natural-Gas Powered Trucks*, Wall Street Journal, 8/26/2014.

<sup>970</sup> NGV America estimates that there are 62,000 natural gas fueled heavy-duty trucks and buses operating in the U.S. out of a total of 17.5 million heavy-duty trucks and buses operating in the U.S., which equates to 0.4%.

<sup>971</sup> Weekly Retail Gasoline and Diesel Prices (Including Taxes), EIA, [www.eia.gov/dnav/pet/pet\\_pri\\_gnd\\_dcus\\_nus\\_a.htm](http://www.eia.gov/dnav/pet/pet_pri_gnd_dcus_nus_a.htm).

<sup>972</sup> Early LNG Adopters Experience Mixed Results; Truck News, October 1, 2013.



cause less of an impact on the climate than petroleum-based gasoline and diesel fuel.<sup>973</sup> The majority of the other half of the NG fleet resides in states which also subsidize the cost of motor vehicles using natural gas.

Based on the EIA projections for crude oil and natural gas prices, the payback time of LNG trucks is expected to remain relatively long until sometime after 2030 when crude oil prices are projected to begin increasing and the diesel fuel price increases above \$4 per gallon. Thus, natural gas use by heavy-duty trucks is not projected by EIA to increase above 1 percent of the heavy-duty fuel demand until after 2030.

Even when the apparent payback time for CNG and LNG trucks use is favorable to fleet owners, low fuel availability could still slow the transition to CNG and LNG. This is because CNG and LNG availability at service stations is currently 1 percent or less of the availability of gasoline and diesel fuel and therefore not available for most fleets. LNG availability is particularly challenging because in addition to an LNG service station, an LNG liquefaction plant would be needed as well.

If the number of natural gas truck sales remains a small portion of the heavy-duty truck fleet, even if natural gas trucks emit either higher or lower greenhouse gas emissions than diesel fuel trucks, there would be little impact on overall greenhouse gas emissions. The low natural gas use by the heavy-duty sector during the Phase 2 timeframe will give us time to learn more about both upstream and downstream methane emissions to gain a better understanding of the lifecycle impacts of natural gas use by heavy-duty trucks. It will allow EPA more time to consider and put into place the best additional steps to further reduce upstream and downstream methane emissions which will improve the lifecycle impacts of natural gas use by heavy-duty trucks should the heavy-duty truck fleet begin consuming natural gas in much larger quantities.

#### *D. Natural Gas Emission Control Measures*

Although natural gas vehicles are already subject to evaporative emission standards, the increasing interest in using natural gas as a heavy-duty fuel has led industry to further investigate

how to improve the overall emission performance of natural gas vehicles, especially with respect to reducing methane leaks.

##### (1) Control Measures

As described in Section XII.A.3, EPA is adopting a 5 day hold time requirement for LNG fuel tanks to reduce venting emissions.

As described in Section II., EPA is not adopting the proposed changes related to crankcase emission control from natural gas engines.

##### (2) Additional Natural Gas Requirements and Discussion

The discussion below includes new and revised natural gas program requirements being finalized. It also address other topics for with the agencies are not taking any action at this time. We will continue to monitor the market growth of these vehicles and we plan to review the greenhouse gas emissions impacts at a future date when natural gas vehicles comprise a larger percentage of the overall heavy duty fleet.

##### (a) Changing Global Warming Potential Values in the Credit Program for CH<sub>4</sub> (see also Preamble Section II.(D)(5)(b))

The Phase 1 GHG rule included a compliance alternative allowing heavy-duty manufacturers and conversion companies to comply with the respective methane or nitrous oxide standards by means of over-complying with CO<sub>2</sub> standards (40 CFR 85.525). More specially, EPA allows manufacturers to use CO<sub>2</sub> credits (generated from the same averaging set) to comply with the methane and nitrous oxide requirements after adjusting the CO<sub>2</sub> emission credits based on the relative GHG equivalents. To establish the GHG equivalents used by the CO<sub>2</sub> credits program, the Phase 1 heavy-duty vehicle rulemaking incorporated the IPCC Fourth Assessment Report GWP values of 25 for CH<sub>4</sub> and 298 for N<sub>2</sub>O, which are assessed over a 100 year lifetime. EPA is largely continuing this allowance for Phase 2.

Since the Phase 1 rule was finalized, a new IPCC report has been released with new GWP estimates. EPA asked for comment on whether the methane GWP used to establish the GHG equivalency value for the CO<sub>2</sub> Credit program should be updated to those established by IPCC in its Fifth Assessment Report (AR5). The IPCC AR5 presents four different potential values for the GWP of methane over a 100 year lifetime, ranging from 28 to 36. These values are the result of slightly different calculation methods. Therefore, we not only requested

comment on whether to update the GWP for methane to that of the AR5, but also on which value to use from this report. The GWPs of 28 and 30 are both a result of using a carbon cycle approach consistent with that used in the Fourth Assessment Report. This carbon cycle approach included a climate-carbon feedback when calculating the lifetime of a pulse of carbon dioxide emissions, but did not include any climate-carbon feedback when calculating the impacts of a pulse of non-CO<sub>2</sub> greenhouse gas emissions. As the GWP is the ratio of the impact of a pulse of non-CO<sub>2</sub> GHG emissions relative to a pulse of carbon dioxide emissions, a second approach was presented where the non-CO<sub>2</sub> GHG pulse also included climate-carbon feedbacks. This second approach yields GWP values of 34 or 36. For the purposes of this rule, EPA is choosing the approach that includes climate-carbon feedbacks for both non-CO<sub>2</sub> and CO<sub>2</sub> pulses, as the agency considers this the approach most likely to be adopted by the international scientific community in future assessments on the timescale of this rule. The IPCC presents the value of 34 as the default value for the methane GWP, but also reports a value of 36 for "fossil" methane to take into account the atmospheric CO<sub>2</sub> that would result from the oxidation of methane in the atmosphere.

We received a number of comments on this issue. For the most part, the environmental community favored using the more recent GWP value and even some commented that EPA should use a methane GWP based on a 20 year timeframe. On the other hand, the natural gas industry and natural gas truck manufacturers commented that EPA should not update to the newer GWP values but continue to use the methane GWP value from the AR4 IPCC report because EPA is still using the methane GWP from the AR4 today in other contexts. Although EPA is currently using AR4 values in other contexts, it is unlikely that EPA will still be using AR4 values in 2021 when the Phase 2 requirements begin. Thus, comments opposing the use the methane GWP from the later IPCC report are not persuasive. EPA will continue to base the credit adjustment on a 100 year timescale because it seems to best balance short-term versus long-term effects of climate change.

Of the possible 100 year methane GWP values presented in the IPCC AR5 report, EPA is choosing to use the value of 34 because it is the primary value presented by the IPCC and because the approach of not accounting for the CO<sub>2</sub> oxidation product within the GWP for

<sup>973</sup> CARB currently estimates for the LCFS that CNG and LNG trucks reduce GHG-equivalent emissions by 32% and 17%, respectively, compared to gasoline and diesel fuel. In August 2014, CARB proposed reducing the GHG-equivalent benefit of CNG and LNG trucks to 22% and 3%, respectively, compared to gasoline and diesel fuel.



methane is consistent with prior IPCC practice.<sup>974</sup> The use of this GWP for credit adjustments will not begin until 2021, when the Phase 2 engine standards go into effect. The choice of this GWP value for future rules on this timescale does not prejudice the choice of other GWP values for use in regulations and other purposes in the near term.

To be consistent with other lifecycle analyses, the agencies are continuing to use AR4 value of 25 for the methane GWP in our lifecycle analyses. However, as discussed in Chapter 13.1 of the RIA, we have also conducted sensitivity analyses using methane GWP values ranging from 7.6 to 72.

(b) Appropriate Deterioration Factors for NG Tailpipe Emissions

EPA requested comment on the current assigned deterioration factors for CO<sub>2</sub>, N<sub>2</sub>O, and CH<sub>4</sub> based on diesel technology. We received one comment on this topic indicating the commenter knew of no data to support a deterioration analysis and that our approach for deterioration should remain as is. EPA has decided not to take action on this topic at this time and will continue the Phase 1 approach.

(c) LNG Vehicle Boil-Off Warning System

EPA requested comment on the feasibility and appropriateness of a regulatory requirement that LNG fueled vehicles include a warning system that would notify the driver of a pending boil-off event as one means reduce the frequency of such events and thus limit the release of methane. We received several comments expressing safety concern related to this approach. While such a system could be beneficial to the owner of a vehicle, EPA is not taking action at this time. We encourage innovation for safe technologies to evolve for warning of potential boil-off events which would also save the vehicle owner the cost of the fuel in the tank while protecting the atmosphere from large amounts of methane gas.

(d) Extending the 5-Day Hold Time for LNG Vehicles

EPA proposed to require manufacturers to comply with the existing evaporative emission standards by showing compliance with a 5-day hold time. 80 FR 40510. We also solicited comment on the ability of emerging technologies to address an extension of 5-day requirement to a

longer period of time such as 10 days. After considering the comments, EPA is not extending the hold time beyond 5 days in this rule.

The specifications of the 5-Day Hold Time SAE J2343 safety related standard will only affect LNG vehicles starting in the year 2021 to help prevent boil-off events. After speaking to LNG truck manufacturers and LNG fuel providers, our understanding is that most LNG is dispensed at about 100 to 120 pounds per square inch gauge (psig), which corresponds to –200 degrees Fahrenheit) and at that temperature, new LNG trucks with new LNG storage tanks are achieving more than a 5-day hold time today. However, over time, the vacuum insulation of the LNG storage tank can fail, resulting in degraded LNG hold-time as the truck ages. The requirement that the LNG truck must meet the 5-day hold-time over its entire useful life will likely improve the truck's hold time after the first several years in service. While LNG tank manufacturers are further developing their technologies for improvement of hold times and reducing boil-off from LNG storage tanks on trucks, the 5-day hold time requirement over the truck's useful life will ensure that they make the improvements to the period of the truck's life which is most at risk for boil-off events, which is when the truck is sold off into the secondary market and its use diminishes.

EPA considered requiring new trucks to have the capability to use cold fuel. Most of the LNG trucks on the road at this time use the warmer fuel; therefore, most refueling stations are dispensing the warmer fuel only. A cold fuel requirement could force refueling stations to make a large potentially burdensome investment to provide the colder fuel in addition to the warmer fuel, because only a few cold fuel LNG trucks might be sold in that area. We would need to study the implications of this scenario further and gain a better understanding of the emissions from boil-off events before we would feel confident in how a cold LNG fuel requirement would affect the refueling industry and reduce methane emissions. A cold LNG fuel requirement would likely be more feasible for new fleets since they could design their truck fleet and their own fueling equipment from the ground up to use the cold LNG fuel.

Another possible approach would be to increase the R- value of the tank to keep the warm fuel colder for longer. This likely would further reduce boil-off events, although, again, we are uncertain of the benefits versus the costs. We believe that ensuring that the

5-day hold time can be met over the truck's useful life is the best, lowest cost strategy to reduce the number of boil-off events.

(e) Capturing and/or Converting Methane Refueling or Boil-Off Emissions

Although we are not requiring it, EPA is interested in watching the progression of innovative technologies that can capture methane emissions during a boil-off event to prevent large amounts of greenhouse gas emissions into the atmosphere. We encourage design and development of ideas such as a methane canister using adsorbents such as ANG<sup>975</sup> (adsorbed natural gas) which could be added to capture the methane which otherwise will be released to the environment during a refueling or boil-off event. Once captured, steps could be taken to route the methane to the engine intake once the vehicle is operating again, or to take steps to converting the methane to less GHG-potent CO<sub>2</sub>.

Instead of discharging methane to the environment, the methane potentially could be burned to CO<sub>2</sub> using a burner. Another potential option would be to convert the methane capture in a canister to CO<sub>2</sub> over a catalyst.

(f) Reducing Refueling Emissions

When refueling a natural gas vehicle, some amount of methane is vented to the atmosphere. Requirements adopted as part of the Tier 3 rules require use of the ANSI-NGV1-2006 standard practice to meet the evaporative emissions refueling requirement.<sup>976</sup> Small emissions of up to 200 cc/hr (which equates to 72 grams of methane per hour) of leakage are allowed with these tests. Often there is a vent line which carries these emissions away from the nozzle interface for safety reasons, which emissions are then vented to the atmosphere. EPA requested comment on ways to eliminate or reduce these losses. There was a mixed response on whether methane gas can be captured during refueling using systems that route methane emissions back to the fuel storage tank, whether it is a CNG tank, a CNG pipeline or re-liquefying system for LNG. Some refueling stations are already doing this as common practice.

For LNG, in addition to the boil-off issue, there is the issue of the recurrence of manual venting at refueling by truck operators. Under high pressure

<sup>975</sup> Menon, V.C., Komarneni, S. "Porous Adsorbents from Vehicular natural Gas Storage: A Review," *Journal of Porous Materials* 5, 43-58 (1998).

<sup>976</sup> Control of Air Pollution from Motor Vehicles Tier 3 Motor Vehicle Emission and Fuel Standards, Final Rule April 28, 2014, CFR 86.1(c) (1).

<sup>974</sup> The corresponding N<sub>2</sub>O value from the AR5 report is 298, which is the same as the value used in Phase 1.

circumstances, such as when the vehicle has been sitting for some time period in warmer temperatures, it is necessary to decrease the pressure in the fuel tank before new fuel can enter the tank. The recommended practice is to transfer the extra vaporized fuel to the gas station or natural gas pipeline, but this can take extra time. In some areas it has turned into common practice to just vent to the atmosphere to keep the down time at the refueling station to a minimum. In other areas there is an incentive to reroute the gas into the station storage tank or natural gas pipeline with credit towards the fuel purchase. Since this is a stationary source issue, EPA is not taking action at this time on these issues in this engine/vehicle rulemaking. We also do not have enough information on the extent of emissions and rate of occurrence for this problem.

(g) On-Board Monitoring Requirements for Boil-Off Events and Venting at Refueling

Onboard diagnostics for engines used in vehicle applications greater than 14,000 lbs GVWR are already required to detect and warn the operator when methane leaks occur due to wear of connections and components of the CNG or LNG fuel system (74 FR 8310, February 24, 2009). We requested comments on requiring on-board monitoring to track boil-off events, as well as comment on whether the excess vapors were properly vented to the station storage tanks or NG pipeline or whether the gaseous methane emissions were vented to atmosphere during refueling events. 80 FR 40512. Each boil off event has the potential to release on the order of 5,300–15,800 grams of CH<sub>4</sub> which translates to 132K–400K grams CO<sub>2</sub> equivalent with a GWP of 25 for 100 years (see RIA Chapter 13 for more information on LNG boil-off emissions calculations). EPA is not able to take further action on OBD requirements at this time since we do not have enough information on the emissions from leaks and their rate of occurrence. Designing an OBD system is complicated and expensive if we are to expect any degree of accuracy for more than just very large leaks. In CNG there is an odorant and a truck operator could potentially detect a leak if it is large enough. Even if the leak could be detected from the odor, it would be difficult to know how much is actually being released if you can smell it. Different operators will have different degrees of sensitivity with their olfactory awareness. LNG does not have an odorant and could benefit from an OBD system even more. We do, therefore, encourage the development of systems for indicating these events to

vehicle owners to both save on fuel and protect the environment.

(h) Separate Standards for Natural Gas Vehicles

As described above, the climate impact of leaks and other methane emissions that occur upstream of the vehicle can potentially be large enough to more than offset the CO<sub>2</sub> benefit of natural gas vehicles as measured at the vehicle tailpipe. As described earlier, EPA has taken some actions, and is considering further separate actions to control these upstream emissions. We also have some concern that the impact of upstream and downstream emissions for natural gas could be much higher than for gasoline or diesel fuel because of the high Global Warming Potential (GWP) for methane that makes even small leaks of natural gas a concern. In this way, natural gas is very different than other alternative fuels. While we are not adopting any provisions to address this here, we may consider adopting such provisions in a future rule. As discussed in Section XI.B, EPA is putting in place a series of regulations in the natural gas sector for upstream leaks. With the currently available data the uncertainties are very high in calculating upstream emissions for both natural gas and diesel vehicles. These uncertainties, the desirability of a unified national program for HD GHG and fuel consumption standards, combined with the low sales volumes projected for natural gas vehicles for the foreseeable future make it inadvisable for us to pursue more than a vehicle based standard at this time. See also Section I.F.(3) for additional discussion of why EPA is setting tailpipe standards in this rulemaking.

*E. Dimethyl Ether*

Although NAS (2014) focused its recommendations on natural gas, it also discussed dimethyl ether (DME), which is a potential heavy-duty truck fuel sourced from natural gas. Dimethyl ether has a high cetane number (more than 55), although its energy density is about 60 percent of that of diesel fuel. Dimethyl ether is a volatile fuel, like liquefied petroleum gas that can be stored as a liquid at normal ambient temperatures under moderate pressure. Typical DME fuel tanks would be designed to prevent any significant evaporative emissions.

A DME fueled truck is only modestly more expensive than a diesel fuel truck. The fuel tank is more expensive than a diesel fuel tank, but much less expensive than an LNG tank since it does not need to be heavily insulated. The engine modifications to enable

using DME are also modest. Because DME does not have carbon-carbon bonds that form particulate matter particles during combustion, the particulate filter, which is standard equipment on new diesel trucks, can be eliminated. This offsets some of the engine and fuel tank costs.

Although DME is sourced from cheap natural gas, the conversion of natural gas to DME and moving the fuel to retail outlets greatly increases the cost of the fuel. Based on the crude oil and natural gas prices in early 2014 (about \$100 per barrel), DME is more expensive than LNG, but still lower in cost than diesel fuel (DME is estimated to cost \$3.50/DGE, or \$0.30 DGE less than diesel fuel.) After the decline in crude oil prices, DME is estimated to be priced higher than diesel fuel.

Because there is very little DME use in the U.S. (there is only a very small fleet of trucks in California), we did not conduct a lifecycle assessment of DME, but note here a few aspects of a lifecycle analysis for DME. First, since DME is sourced from natural gas, the upstream methane emissions from the natural gas industry would still be allocated to DME. Second, there are no venting issues associated with DME as there are with LNG refueling or boil-off. Third, because DME has a lifetime of less than a week in the atmosphere, it has little direct climate impacts. Thus, it is likely that DME would have a lower GHG impact than LNG trucks, and perhaps lower than CNG trucks, although we would have to study DME use in trucks further to be more certain.

**XII. Amendments to Phase 1 Standards**

The agencies are revising the regulatory text specifying test procedures and compliance provisions used for Phase 1. For the most part, these amendments apply exclusively to the Phase 2 rules. In a few limited instances, the agencies are adopting changes to the Phase 1 program. These limited changes to the Phase 1 program are largely conforming amendments, and are described below, along with other minor changes to the Phase 1 compliance program. These changes generally continue to apply under the Phase 2 program.

For the convenience of the reader, we are republishing 40 CFR parts 1036 and 1037 in their entirety, including text that is not being amended. We are also republishing Phase 1 text in 40 CFR part 86. We note, however, that we have not reconsidered, rethought, or reopened the Phase 1 rules in a general sense. We have also not reconsidered, rethought, or reopened the stringency of the Phase 1 standards or other fundamental

aspects of the Phase 1 program that remain unchanged substantively.

The agencies received very few comments of these changes. Daimler commented that the agencies should not make any changes to Phase 1 because manufacturers have already developed systems to comply with the existing requirements. We do not necessarily agree that would be a sufficient reason to keep us from amending Phase 1 requirements through notice and comment rulemaking. Nevertheless, we note that we are not finalizing changes that would have any significant impact on the manufacturers' Phase 1 compliance structures.

#### A. EPA Amendments

##### (1) Pickups and Vans

EPA is relocating the GHG standards and other regulatory provisions for chassis-certified HD pickups and vans in the Code of Federal Regulations from 40 CFR 1037.104 to 40 CFR 86.1819–14. Accordingly, NHTSA is modifying any of EPA's references in 49 CFR parts 523 and 535 to accommodate the migration. EPA is making this change largely to address ambiguities regarding the application of additional provisions from 40 CFR part 86, subpart S, for these vehicles. The approach in 40 CFR 1037.104 was to state that all of 40 CFR part 86, subpart S, applies except as specified in 40 CFR 1037.104; however, the recent standards adopted for light-duty vehicles and light-duty trucks included several changes to 40 CFR part 86, subpart S, that should not apply for chassis-certified HD pickups and vans. Based on our experience implementing the Phase 1 program, we believe it is appropriate to include the GHG standards for chassis-certified HD pickups and vans in the same part as light-duty vehicles (40 CFR part 86, subpart S). All other certification requirements for these heavy-duty vehicles—criteria exhaust standards, evaporative and refueling standards, provisions for onboard diagnostics, and the range of certification and compliance provisions—are in that subpart. We note that we have not experienced the same challenges for other heavy-duty vehicles, and are therefore not relocating the other provisions of 40 CFR part 1037.

This migration has highlighted a few areas where we need to clarify how the regulations apply for chassis-certified HD pickups and vans. In particular, EPA is adopting the following changes:

- Clarify that the GHG standards apply at high-altitude conditions.
- State that fleet-average calculation of carbon-related exhaust emissions

(CREE) is not required for chassis-certified HD pickups and vans. Instead, heavy-duty vehicles are subject to CO<sub>2</sub> standards.

- Clarify that requirements related to model types and production-weighted average calculation apply only for passenger automobiles and light trucks.
- State that the credit and debit provisions of 40 CFR 86.1865–12(k)(5) do not apply for chassis-certified HD pickups and vans.
- Clarify that the Temporary Lead Time Allowance Alternative Standards in 40 CFR 86.1865–12(k)(7) do not apply for chassis-certified HD pickups and vans.
- State that the early credit provisions of 40 CFR 86.1866–12, 86.1867–12, 86.1868–12, 86.1869–12, 86.1870–12, and 86.1871–12 do not apply for chassis-certified HD pickups and vans.

##### (2) Heavy-Duty Engines

EPA is revising the approach to classifying gaseous-fuel engines with respect to both GHG and criteria emission standards. The general approach is to continue to divide these engines into spark-ignition and compression-ignition categories, but we will apply the compression-ignition standards to all engines that qualify as heavy heavy-duty engines based on the primary intended service class.<sup>977</sup> Previously, any gaseous-fuel engine derived from a gasoline engine was subject to the spark-ignition standards no matter the weight class of the vehicle. As described in Section II, EPA now believes this approach does not reflect the reality that engines used in Class 8 vehicles compete directly with diesel engines. We believe they should therefore be required to meet the same emission standards. Because all current gaseous-fuel engines for these large vehicles are already being certified to the compression-ignition engine standards, we can apply this approach to engines subject to the HD GHG Phase 1 standards without adverse impacts on any manufacturers. We proposed this same approach for medium heavy-duty engines, but have revised the rule in response to comments objecting to the change; the final rule instead applies standards to these engines as spark-ignition or compression-ignition based only on each engine's characteristics. We believe this is appropriate because

<sup>977</sup> Engine classification is set forth in 40 CFR 1036.801. Spark-ignition means relating to a gasoline-fueled engine or any other type of engine with a spark plug (or other sparking device) and with operating characteristics similar to the Otto combustion cycle. Compression-ignition engines are reciprocating internal-combustion engines that are not spark-ignition engines.

a substantial number of medium heavy-duty vehicles use gasoline-fueled engines, and gaseous-fueled engines used in these vehicles would therefore not always be competing directly with diesel-fueled engines as the main alternative.

EPA is also revising the regulation to spell out how to apply enforcement liability for a situation in which the *engine* manufacturer uses deficit credits for one or more model years. Simply put, any time an engine manufacturer is allowed to carry a deficit to the next year, all enforcement liability for the engines that generated the deficit are extended for another year. These provisions are the same as what we have already adopted for heavy-duty *vehicles* subject to GHG standards under 40 CFR part 1037.

##### (3) Evaporative Emission Testing for Natural Gas Vehicles

Heavy-duty vehicles fueled by natural gas have for many years been subject to evaporative emission standards and test procedures. While fuel systems containing gasoline require extensive design features to handle vented fuel, fuel systems containing natural gas generally prevent evaporative losses by remaining sealed. In the case of compressed natural gas, there is a voluntary consensus standard, ANSI NGV1–2006, that is designed to ensure that there are no leaks or losses during a refueling event. Since compressed natural gas systems remain sealed indefinitely once the refueling event is complete, we understand that complying with the ANSI refueling standard is sufficient to demonstrate that the vehicle also complies with all applicable evaporative emission standards. The Light-Duty Tier 3 final rule included provisions to clarify that compressed natural gas systems meeting the applicable ANSI standard are deemed to comply with EPA's evaporative emission standards. In response to comments received on the proposed rule, we are adding a reference to a supplemental ANSI standard that similarly specifies system-integrity requirements for CNG-fueled heavy-duty vehicles that allow for substantially higher refueling rates; this supplemental standard will eventually be incorporated into ANSI NGV1.

Systems using liquefied natural gas (LNG) behave similarly, except that the cryogenically stored fuel needs to be vented to prevent an over-pressure situation if the vehicle is not used for an extended time, as described in Section XI. Such vehicles are currently subject to evaporative emission standards and test procedures, though there are some

substantial questions about how one can best apply the procedures to these systems; not all of the instructions about preconditioning the vehicle are straightforward for cryogenic fuel systems with no evaporative canister. EPA is adopting an approach that is similar to what applies for compressed natural gas systems, which needs some additional attention to address boil-off emissions. SAE J2343 is a voluntary consensus standard that specifies a recommended practice to establish a minimum five-day hold time before boil-off starts to occur for LNG systems. EPA is adopting a requirement that manufacturers of LNG vehicles meet the SAE J2343 standard as a means of demonstrating compliance with evaporative and refueling emission standards.

While the hold-time requirements of SAE J2343 are clear, there appears to be very little description of the procedure to determine how much time passes between a refueling event and initial venting. To ensure that all manufacturers are subject to the same set of requirements, we are adding a minimal set of specifications corresponding to the demonstration under SAE J2343. In particular, the regulation specifies that the tank must remain at rest throughout the measurement procedure, ambient temperatures must remain between 20 and 30 °C, and the hold-time period starts when the tank pressure reaches 690 kPa (100 psi) after a conventional refueling event. We are also adopting a simplified standard that translates the five-day hold time into a maximum allowable pressure build over a shorter time for parked vehicles. In particular, for vehicles parked for at least 12 hours, tank pressure must not increase by more than an average of 9 kPa (1.3 psi) per hour. The pressure increase corresponding to the five-day hold-time standard is about 7.5 kPa per hour. The additional margin is intended to account for variability related to different ambient conditions, vehicle handling, nonlinear pressure increases, measurement instruments, and other factors. This is intended to give vehicle owners a more practical performance measure to evaluate whether tanks continue to meet the hold-time requirement.

Manufacturers may rely on SAE J2343 to meet evaporative and refueling standards immediately with completion of the final rule; this demonstration becomes mandatory for vehicles produced on or after January 1, 2020.

One commenter suggested that we add a reference to European test protocols for CNG heavy-duty vehicles

to allow for a higher refueling flow rate than is allowed under the EPA regulations, which are based on hardware and procedures for light-duty vehicles (ANSI NGV1). We learned that the European protocol is based on systems up to 3000 psi and is therefore not valid for most heavy-duty CNG vehicles in the United States. Representatives of the natural gas industry responded to the comment suggesting the European protocol by recommending that we instead reference a recently published supplement to ANSI NGV1, which accommodates the higher flow rates corresponding to heavy-duty vehicles and current refueling technology. We are accordingly revising the regulation to reference this additional ANSI document, which is known as CSA IR-1-15, "Compressed Natural Gas Vehicle (NGV) High Flow Fueling Connection Devices."

#### (4) Compliance and Other General Provisions

EPA is adopting the following changes that apply broadly for different types of vehicles or engines:

- Providing additional detail about manufacturers obligations with respect to delegated assembly. In response to comments, we have delayed the applicability of these provisions until January 1, 2018 to provide manufacturers with additional lead time. See 40 CFR 1037.150(e) and 1037.621.
- Add a requirement for vehicle manufacturers that sell incomplete vehicles to secondary vehicle manufacturers to provide emission-related assembly instructions to ensure that the completed vehicle will be in a certified configuration.
- Specify parameters for determining a vehicle's curb weight, consistent with current practice for vehicles certified under 40 CFR part 86, subpart S.
- Revise the recordkeeping requirement to specify a uniform eight-year retention period for all data supporting an application for certification. The provision allowing for one-year retention for "routine data" is no longer necessary now that data collection is all recorded in electronic format. EPA is also clarifying that the eight-year retention period is calculated relative to the latest associated application for certification, not from the date the data were generated.
- Change the rounding for analytically derived CO<sub>2</sub> emission rates and target values from the nearest 0.1 g/mile to the nearest 1 g/mile.

- Clarify how manufacturers may amend an application for certification after the end of the model year.

- Remove the general recordkeeping provisions from 40 CFR 1037.735 that are already described in 40 CFR 1037.825.

- Clarify how EPA will conduct selective enforcement audits (SEAs) for engines (in 40 CFR 1036.301) and vehicles and components (in 40 CFR 1037.301–1037.320) with respect to GHG emissions.

- Add provisions to provide a streamlined path for off-cycle credit for adding Phase 2 technologies to Phase 1 vehicles. See 40 CFR 1037.150.

EPA proposed a different equation with a ratio of 0.8330 in 40 CFR 1037.525 for the case of full yaw sweep measurements to determine wind-averaged drag correction as an amendment to the Phase 1 program. Some commenters argued that this change would impact stringency, but we disagree because manufacturers are already subject to EPA compliance using both methods (full yaw sweep and ±6 degree measurements), and this Phase 1 flexibility was not used in setting the level of the Phase 1 standards. Nevertheless, we are adopting the final rule without this change to the Phase 1 standards. Other changes in the existing Phase 1 regulations for MY 2017 will serve to mitigate any impacts, and the agencies are no longer convinced the potential disruption to manufacturers' compliance plan is warranted.

#### *B. Other Compliance Provisions for NHTSA*

##### (1) Standards and Credit Alignment

In Phase 1, the agencies intended GHG and fuel consumption standards for segments of the National Program to be in alignment so that manufacturers will not be required to build vehicles to meet in equivalent standards. Despite the intent, NHTSA and EPA have identified several scenarios where credits and compliance to both sets of standards are not aligned. This misalignment can have various impacts on compliance with the National Program.

For example, a manufacturer of tractors could have two vehicle families that with same number of vehicles but with opposite and equal compliance margins with standards. In this scenario, the first family will over-comply with the GHG standard while the second family will under-comply with the GHG standard by the same amount of grams CO<sub>2</sub>/ton-mile. In calculating credits, the manufacturer will have a net of zero

GHG credits and exactly meet compliance; however, based on conversions and rounding of the standard and performance results that manufacturer could end up earning credits or having a credit deficit under NHTSA's fuel efficiency program.

In order to correct this misalignment, NHTSA proposed to amend the existing fuel consumption standards and the method for calculating performance values for all compliance categories by increasing the significant digits in these conversion values. Increasing the significant digits in these values will result in more precise alignment between final compliance credit balances.

NHTSA proposed that the increase resolution would apply retroactively starting for the model year 2013 standard. However, because the Phase 1 fuel consumption standards created a difference in compliance margins which could potentially have an adversely impact for certain manufacturers who have already developed engineering plans considering previous credit balance, NHTSA sought comments on whether optional to allow manufacturer to continue using the Phase 1 standards. No comments were received in response.

NHTSA is finalizing its standards and performances for the Phase 1 and 2 programs with increased significant digits as the only option for compliance. Retaining the previous accuracy does not maintain a single national program and aligning credit balances is more important because it ensures the same compliance outcome. Manufacturers who may have planned their compliance strategies using the previous approach would not be able to take advantage of any relaxations in the NHTSA program because the national program requires one single compliance fleet and manufacturers would still need to comply with the more stringent EPA standards.

#### (2) Off-Road Exemption Petition Process for Tractors and Vocational Vehicles

In the Phase 1 final rule, the agencies added provisions for certain types of vocational tractors and vocational vehicles that operate off-road to be exempt from standards, although standards will still apply to the engines installed in these vehicles. An exemption was warranted because these vehicles operate in a manner essentially making them incompatible with fuel saving and emission reduction technologies, such as performing work in an off-road environment, being speed restricted, or having off-road components or other features making

them incompatible for roadways. For the Phase 1 program, off-road vehicle manufacturers meeting the exemption provisions are required to provide EPA and NHTSA, through the EPA database, a report within 90 days after the end of each model year identifying its off-road vehicles. The report must provide a description of each excluded vehicle configuration, including an explanation of why it qualifies for the exclusion and the production volume. A manufacturer having an off-road vehicle that does not meet the criteria under the agencies' off-road exemptions in 40 CFR 1037.631 and 49 CFR 535.5 is allowed to submit a petition under 40 CFR 1037.150(h) and 49 CFR 535.8 describing how and why its vehicles should qualify for exclusion based on criteria that are equivalent to those specified in 40 CFR 1037.631.

Under Phase 1 compliance processes, manufacturers have not been using the petitioning process to get approval of an exemption for off-road vehicles that do not meet the specified criteria to qualify for an exemption. Instead, manufacturers have been submitting information to EPA during production for a given model year to determine whether or not these vehicles qualify for an exemption, or if they need to get certificates of conformity for the vehicles they already produced. EPA and NHTSA collaboratively determine whether manufacturers should qualify for an exemption under 40 CFR 1037.150(h) and 49 CFR 535.8, and EPA shares the decision with the manufacturer.

For the Phase 1 and 2 standards, the agencies are revising the regulations to clarify the process for vehicle manufacturers to get approval for an exemption in unusual circumstances in which the vehicle should be exempt even though it does not automatically qualify for an exemption under the criteria specified in 40 CFR 1037.631 and 49 CFR 535.5. Most importantly, we now specify at 40 CFR 1037.150(h) and 49 CFR 535.8 that manufacturers must get approval for the exemption before producing the subject vehicles to avoid violating statutory prohibitions. EPA and NHTSA will continue to collaborate in making any final decisions on exemptions.

Note that vehicles meeting the qualifying criteria under 40 CFR 1037.631 and 49 CFR 535.5 are exempt without request; however, if manufacturers want to address any uncertainty by getting EPA and NHTSA to affirm that their vehicles do in fact meet the specified criteria, they may ask for preliminary approval under 40 CFR 1037.210.

#### (3) Innovative Technology Request Documentation Specifications

For vehicle and engine technologies that can reduce GHG and fuel consumption, but for which there is not yet an established method for quantifying reductions, the agencies encourage the development of such technologies through providing "innovative technology" credits. Manufacturers seeking innovative technology credits must quantify the reductions in fuel consumption and GHG emissions that the technology is expected to achieve, above and beyond those achieved on the existing test procedures.

Manufacturers submitting innovative technology requests must send a detailed description of the technology and a recommended test plan to EPA as detailed in 40 CFR 1036.610 and 1037.610. The test plan must include whether the manufacturer is applying for credits using the improvement factor method or the separate-credit method. It is recommended that manufacturers not conduct testing until the agencies can collaboratively approve the test plan in which a determination is made on the qualification of the technology as innovative. EPA in consultation with NHTSA also makes the decision at that time whether to seek public comments on the test plan if there are unknown factors in the test methodology.

The agencies have received feedback from manufacturers that the final approval process is not clearly defined, which has caused a substantial time commitment from manufacturers. To address this feedback, for the final rule, the agencies are adopting further clarification in 40 CFR 1036.610 and 1037.610 defining the steps manufacturers must follow after an approval is granted for a test plan. This includes specifications for submitting the final documentation to the agencies for final approval and for determining credit amounts. The agencies are adding the same level of detail as required for the final documentation required in EPA's light duty off-cycle program in 40 CFR 86.1869–12(e)(2). These specifications should provide manufacturers with a clear understanding of the required documentation and approval process to reduce the time burden placed on manufacturers.

NHTSA is also adding similar provisions from its light duty CAFE program specified in 49 CFR 531.6(b)(2) and 533.6(c)(2) for limiting the approval of innovative technologies under its program for those technologies related to crash-avoidance technologies, safety

critical systems or systems affecting safety-critical functions, or technologies designed for the purpose of reducing the frequency of vehicle crashes. NHTSA prohibited credits for these technologies under any circumstances in its CAFE program (see 77 FR 62730). NHTSA believes a similar strategy is warranted for heavy-duty vehicle as well.

#### (4) Credit Acquisition Plan Requirements

The National Program was designed to provide manufacturers with averaging, banking and trading (ABT) flexibilities for meeting the GHG and fuel efficiency standards to optimize the effectiveness of the program. As a part of these flexibilities, manufacturers generating a shortfall in fuel consumption credits for a given model year must submit a credit plan to NHTSA describing how it plans to resolve its deficits within 3 models year. To assist manufacturers, NHTSA is modify 49 CFR 535.9(a)(6) of its regulation to clarify and provide guidance to manufacturers on the requirements for a credit allocation plan which contains provisions to acquire credits from another manufacturer which will be earned in future model years.

The current regulations do not specify if future credit acquisition is permitted or not and the revision is intended to clarify that it is, with respect to the limitation a credit shortfall can only be carried forward three years. Providing this clarification is intended to increase transparency within the program and ensure all manufacturers are aware of its available flexibilities. NHTSA is adopting the requirement that in order for a credit allocation plan to be approved, NHTSA will require an agreement signed by both manufacturers. This requirement will assist NHTSA with its determination that the credits will become available to the acquiring manufacturer when they are earned.

#### (5) New Vehicle Field Inspections and Recordkeeping Requirements

Previously, NHTSA decided not to include recordkeeping provisions in its regulations for the Phase 1 program. EPA regulations include recordkeeping requirements in 40 CFR 1036.250, 1036.735, 1036.825, 1037.250, 1037.735, and 1037.825. For the Phase 2 program, NHTSA is adding recordkeeping provisions to facilitate its compliance validation program for the final rule. For the Phase 1 and 2 programs, manufacturers test and conduct modeling to determine GHG emissions and fuel consumption performance, and

EPA and NHTSA perform validation testing. EPA uses the results of the validation tests to create a finalized report that confirms the manufacturer's final model year GHG emissions and fuel consumption results. Each agency will use this report to enforce compliance with its standards.

NHTSA assesses compliance with fuel consumption standards each year, based upon EPA final verified data submitted to NHTSA for its heavy-duty vehicle fuel efficiency program established pursuant to 49 U.S.C. 32902(k). NHTSA may conduct verification testing throughout a given model year in order to validate data received from manufacturers and will discuss any potential issues with EPA and the manufacturer. See 49 CFR 535.9. After the end of the model year, NHTSA may also decide to conduct field inspections in order to confirm whether or not a new vehicle was manufactured as originally certified. NHTSA may conduct field inspections separately or in coordination with EPA. To facilitate inspections, the agencies will add additional provisions to the EPA recordkeeping provisions to require manufacturers to keep build documents for each manufactured tractor or vocational vehicle. Each build document will be required to contain specific information on the design, manufacturing, equipment and certified components for a vehicle. NHTSA will request build documents through EPA and the agencies will collaborate on the finding of all field inspections. Manufacturers will be required to keep records of build documents for a period of 8 calendar years.

### XIII. Other Regulatory Provisions

In addition to the new GHG standards in these rules, EPA and NHTSA are amending various aspects of the regulations as part of the HD GHG Phase 1 standards for heavy-duty highway engines and vehicles, as described in Section XII. EPA is also taking the opportunity to amend regulatory provisions for other requirements that apply for heavy-duty highway engines, and for certain types of nonroad engines and equipment.

Most of the amendments described in this section represent minor technical issues and, as such, were not the subject of extensive comment. Two exceptions are the issues related to glider kits and to competition vehicles, as noted below. The rest of this section, for which we received fewer comments, generally includes only references to the more significant comments, such as comments that impacted our conclusions for the provisions adopted

in the final rule. See the RTC for a more complete discussion of the comments.

For the convenience of the reader, we are republishing some related text that is not being amended. We note, however, that we have not reopened the standards or other fundamental aspects of these programs that remain unchanged substantively.

#### A. Amendments Related to Heavy-Duty Highway Engines and Vehicles

This section describes a range of regulatory amendments for heavy-duty highway engines and vehicles that are not directly related to GHG emission standards. Note that Section XIII. B. describes new requirements for glider kits and Section XIII. F. describes additional changes related to test procedures that affect heavy-duty highway engines.

##### (1) Alternate Emission Standards for Specialty Heavy-Duty Vehicles

Motor vehicles conventionally comprise a familiar set of vehicles within a relatively narrow set of parameters—motorcycles, cars, light trucks, heavy trucks, buses, etc. The definition of “motor vehicle;” however, is written broadly to include a very wide range of vehicles. Almost any vehicle that can be safely operated on streets and highways is considered a motor vehicle under 40 CFR 85.1703. Development of EPA's emission control programs is generally focused on a consideration of the technology, characteristics, and operating parameters of conventional vehicles, and typically includes efforts to address concerns for special cases. For example, the driving schedule for light-duty vehicles includes a variation for vehicles that are not capable of reaching the maximum speeds specified in the Federal Test Procedure.

Industry innovation in some cases leads to some configurations that make it particularly challenging to meet regulatory requirements. We are aware that plug-in hybrid-electric heavy-duty vehicles are an example of this. An engine for such a vehicle is expected to have a much lower power rating and duty cycle of engine speeds and loads than a conventional heavy-duty engine. The costs of regulatory compliance and the mismatch to the specified duty cycle can make it cost-prohibitive for engine manufacturers to certify such an engine under the heavy-duty highway engine program.

To address concerns about certifying atypical engines to highway heavy-duty standards for use in hybrid vehicles, we are therefore adopting a provision allowing manufacturers of heavy-duty

highway vehicles the option to install limited numbers of engines certified to alternate standards. Qualifying engines would be considered motor vehicle engines, but they may be certified to standards that are based on standards adopted for comparable nonroad engines. EPA's nonroad emission standards have reached a point that involves near parity with the level of emission control represented by the emission standards for heavy-duty highway engines. EPA developed these provisions especially for vehicles with hybrid powertrains; however, the same principles apply for three other unusual vehicles types: amphibious vehicles, vehicles with maximum speed at or below 45 miles per hour, and as described below, certain all-terrain vehicles. We are therefore applying the same provisions to these additional vehicles.

California ARB suggested that we limit relief to hybrid vehicles that have a series configuration, or to hybrid vehicles that have a minimum all-electric range. We chose not to adopt these limitations because these features are not fundamental to what we believe is the basis for accommodating special vehicle designs. For example, if a vehicle needs a 20-kW gasoline engine to recharge batteries used for propulsion, and provides a small amount of power directly to the wheels, we believe this should not be disqualified from using the specialty-vehicle provisions because there is no expectation that 20 kW engines will be certified to the conventional highway heavy-duty engine standards anytime in the foreseeable future.

We proposed to offer this flexibility for hybrids, amphibious vehicles, and low-speed vehicles. We also received comment advocating that certain qualifying all-terrain vehicles are in a similar situation since they have unique engine-performance requirements that prevent them from finding compliant highway engines; we have modified the rule to also apply the specialty vehicle provisions to these all-terrain vehicles. The regulations will limit this allowance to vehicles that have portal axles, which are specialized axles that increase ground clearance. Cost and/or performance limits for such axles preclude their use for vehicles intended for use primarily on highways. Thus, we believe vehicles with such axles are designed primarily for off-road operation, while retaining the ability to occasionally operate on highways.

Under approach being adopted for these various vehicles, compression-ignition engines could be certified to alternate standards that are equivalent

to the emission standards under 40 CFR part 1039, and spark-ignition engines could be certified to alternate standards that are equivalent to the Blue Sky emission standards under 40 CFR part 1048.<sup>978</sup> In response to a comment from California ARB, we are adopting a requirement that compression-ignition engines also meet a PM standard (Family Emission Limit) of 0.020 g/kW-hr corresponding to the PM standard that applies for heavy-duty highway engines. Similarly, we are adopting an N<sub>2</sub>O standard of 0.1 g/kW-hr for SCR-equipped diesel-fueled engines that corresponds to the N<sub>2</sub>O standard that applies for heavy-duty highway engines. This collection of standards aligns with our expectation that such engines would generally be expected to use the same technologies to control emissions as engines certified to the applicable emission standards for heavy-duty highway engines. (The regulation being finalized disallows this approach for compression-ignition engines below 56 kW since the nonroad standards for those engines are substantially less stringent than the standards that apply for heavy-duty highway engines). Also, since the nonroad duty cycles generally better represent the in-use operating characteristics of engines in these specialty vehicles, we expect the nonroad test procedures to be at least as effective in achieving effective in-use emission control. The regulations at 40 CFR part 1048 include a simplified form of diagnostic controls, and we are adopting in these rules a simplified diagnostic control requirement for 40 CFR part 1039. These engine-based diagnostic controls substitute for the diagnostic requirements specified in 40 CFR 86.010–18. Note that the diagnostic requirements apply for *engine* systems or components; as such, we generally apply those diagnostic requirements to hybrid powertrain systems and components only if the engine manufacturer includes those features or parameters as part of the certified configuration for their engines. We may revisit issues related to diagnostic requirements for hybrid systems in a future rulemaking.

These alternate standards relate primarily to the engine certification-based emission standards and certification requirements. All vehicle-based requirements for evaporative emissions continue to apply as specified in the regulation. In addition, hybrid vehicles would still be subject to all the standards and requirements that apply to heavy-duty vehicles under 40 CFR

part 1037. For example, manufacturers would need to perform powertrain testing and run GEM to determine the applicable g/ton-mile emission rate for hybrid vehicles. However, the agencies are not requiring vehicle certification for the three other types of specialty vehicles. Low-speed vehicles are already excluded from the vehicle requirements under Phase 1, while the amphibious and all-terrain vehicles would present significant challenges to the vehicle simulations.

This allowance is intended to lower the barrier to introducing innovative technology for motor vehicles. It is not intended to provide a full alternative compliance path to avoid certifying to the emission standards and control requirements for highway engines and vehicles. To accomplish this, EPA will allow a manufacturer to produce no more than 1,000 hybrid vehicles in a single model year under this program, and no more than 200 amphibious vehicles, all-terrain vehicles, or speed-limited vehicles. In the case of hybrid vehicles, we are also acting on California ARB's request that we adopt a sunset provision for hybrid vehicles; accordingly, the simplified certification applies only through model year 2027. In the meantime we will monitor implementation of the program and consider whether there is any long-term need for these or other streamlined certification provisions for hybrid vehicles.

As described in the proposed rule, California ARB is in the process of developing similar provisions for a reduced compliance burden for qualifying highway vehicles toward the goal of incentivizing vehicles with hybrid powertrains and low-NO<sub>x</sub> engines. The incentives generally consist of allowing specific OBD variances or deficiencies (for low-NO<sub>x</sub> engines) or broadly waiving OBD requirements (for hybrid vehicles). To the extent that California ARB certifies vehicles based on approving OBD deficiencies, we would apply a similar discretion for 49-state certification of the same engine model to allow for nationwide sale of those products. If California ARB approves certification of hybrid systems in which the highway OBD requirements are mostly or entirely waived, we would expect to apply the provisions described in this section to allow vehicle manufacturers to produce up to 1000 such vehicles in a given year.

## (2) Chassis Certification of Class 4 Heavy-Duty Vehicles

In the HD Phase 1 rule, the agencies included a provision allowing manufacturers to certify Class 4 and

<sup>978</sup> Blue Sky standards are voluntary low-emission standards under 40 CFR part 1048.



larger heavy-duty vehicles to the chassis-based emission standards in 40 CFR part 86, subpart S. This applied for greenhouse gas emission standards, but not criteria emission standards. EPA revisited this issue in the recent Tier 3 final rule, where we revised the regulation to allow this same flexibility relative to exhaust emission standards for criteria pollutants. However, this change to the regulation conflicted with our response to a comment in that rulemaking that EPA should not change the certification arrangement for criteria pollutants.

EPA requested comment on how best to address this issue in a way that resolves the various and competing concerns. Commenters argued for and against allowing certification of the heavier vehicles to chassis-based emission standards. In the final rule, we are adopting a limited allowance to certify vehicles above 14,000 pounds GVWR using chassis-based certification procedures of 40 CFR part 86, subpart S. In particular, manufacturers may rely on chassis-based certification for heavier vehicles only if there is a family with vehicles at or below 14,000 pounds GVWR that can properly accommodate the bigger vehicles as part of the same family. As part of this arrangement, chassis-certified vehicles above 14,000 pounds GVWR may not rely on a work factor that is greater than the largest work factor that applies for vehicles at or below 14,000 pounds GVWR from the same family.

### (3) Nonconformance Penalties (NCPs)

The Clean Air Act requires that heavy-duty standards for criteria pollutants such as NO<sub>x</sub> reflect the greatest degree of emission reduction achievable through the application of technology that EPA determines will be available. Such “technology-forcing” standards create the risk that one or more manufacturers may lag behind in the development of their technology to meet the standard and, thus, be forced out of the marketplace. Recognizing this risk, Congress enacted CAA section 206(g) (42 U.S.C. 7525(g)), which requires EPA to establish “nonconformance penalties” to protect these technological laggards by allowing them to pay a penalty for engines that temporarily are unable to meet the applicable emission standard, while removing any competitive advantage those technological laggards may have.

On September 5, 2012, EPA adopted final NCPs for heavy heavy-duty diesel engines, which were available to manufacturers of heavy-duty diesel engines unable to meet the current oxides of nitrogen (NO<sub>x</sub>) emission

standard. On December 11, 2013, the U.S. Court of Appeals for the District of Columbia Circuit issued an opinion vacating that Final Rule. It issued its mandate for this decision on April 16, 2014, ending the availability of the NCPs for the current NO<sub>x</sub> standard, as well as vacating certain amendments to the NCP regulations, due to concerns about inadequate notice. In particular, the amendments revised the text explaining how EPA determines when NCPs should be made available. In the NPRM for this rulemaking, EPA proposed to remove the vacated regulatory text specifying penalties, and re-proposed most of the other vacated amendments. Having now provided this additional notice and a full opportunity for comment, we believe that it is appropriate to finalize the proposed changes. EPA is also adopting the proposed new 40 CFR 86.1103–2016 to replace the existing 40 CFR 86.1103–87.

#### (a) Vacated Penalties

In EPA’s regulations, NCP penalties are calculated from inputs specific to the standards for which NCPs are available. The input values are specified in 40 CFR 86.1105–87. EPA is removing paragraph (j) of this section which specifies the vacated inputs for the 2010 NO<sub>x</sub> emission standard. Since all manufacturers are currently complying with these standards, and the court vacated the text in question, it no longer has any purpose.

#### (b) Re-Proposed Text

The 2012 rule made amendments to four different sections in 40 CFR part 86. The amendments to 40 CFR 86.1104–91 and 86.1113–87 were supported during the rulemaking and were not questioned in the Court’s decision. Nevertheless, these revisions were vacated along with the rest of the rule. In the NPRM, EPA re-proposed these changes, even though we had already provided full notice and opportunity for public comment for these changes. Since we are adopting text that is already in the CFR, the final rule consists of leaving these sections of the regulations unchanged.

#### (i) Upper Limits

The changes to 40 CFR 86.1104–91 affect the upper limit. The upper limit (UL) is the emission level established by regulation above which NCPs are not available. A heavy duty engine cannot use NCPs to be certified for a level above the upper limit. CAA section 206(g)(2) refers to the upper limit as a percentage above the emission standard, set by regulation, that corresponds to an emission level EPA determines to be

“practicable.” The upper limit is an important aspect of the NCP regulations not only because it establishes an emission level above which no engine may be certified using NCPs, but it is also a critical component of the cost analysis used to develop the penalty rates. The regulations specify that the relevant costs for determining the COC50 and the COC90 factors are the difference between an engine at the upper limit and one that meets the applicable standards (see 40 CFR 86.1113–87).

The regulatory approach adopted under the prior NCP rules set the upper limit at the prior emission standard when a prior emission standard exists and is then changed to become more stringent. EPA concluded that this upper limit should be reasonably achievable by all manufacturers with engines or vehicles in the relevant class. It should be within reach of all manufacturers of HD engines or HD vehicles that are currently allowed so that they can continue to sell their engines and vehicles while finishing their development of fully complying engines. A manufacturer of a previously certified engine or vehicle should not be forced to immediately remove a HD engine or vehicle from the market when an emission standard becomes more stringent. The prior emission standard generally meets these goals because manufacturers have already certified their vehicles to that standard.

One of EPA’s changes to the regulations in 40 CFR 86.1104–91 clarifies that EPA may set the upper limit at a level below the previous standard if we determine that the lower level is achievable by all engines or vehicles in the relevant subclass. This was the case for the vacated NCP rule. Another change allows us to set the upper limit at a level above the previous standard in unusual circumstances, such as where a new standard for a different pollutant, or other requirement, effectively increases the stringency of the standard for which NCPs would apply. This occurred for heavy heavy-duty engines with the 2004 standards.

#### (ii) Payment of Penalties

The changes to 40 CFR 86.1113–87 correct EPA organizational units and mail codes to which manufacturers must send information. The previous information is no longer valid.

#### (c) Criteria for the Availability of NCPs

Since the promulgation of the first NCP rule in 1985, subsequent NCP rules generally have been described as continuing “phases” of the initial NCP



rule. The first NCP rule (Phase 1), sometimes referred to as the “generic” NCP rule, established three basic criteria for determining the eligibility of emission standards for nonconformance penalties in any given model year (50 FR 35374, August 30, 1985). (For regulatory language, see 40 CFR 86.1103–87). The first criterion is that the emission standard in question must become more difficult to meet. This can occur in two ways, either by the emission standard itself becoming more stringent, or due to its interaction with another emission standard that has become more stringent. Second, substantial work must be required in order to meet the emission standard. EPA considers “substantial work” to mean the application of technology not previously used in that vehicle or engine class/subclass, or a significant modification of existing technology, in order to bring that vehicle/engine into compliance. EPA does not consider minor modifications or calibration changes to be classified as substantial work. Third, EPA must find that a manufacturer is likely to be noncomplying for technological reasons (referred to in earlier rules as a “technological laggard”). Prior NCP rules have considered such a technological laggard to be a manufacturer who cannot meet a particular emission standard due to technological (not economic) difficulties and who, in the absence of NCPs, might be forced from the marketplace. During the 2012 rulemaking, some commenters raised issues relating to EPA’s interpretation of these criteria:

- The extent to which the criteria are intended to constrain EPA’s ability to set NCPs
- The timing for evaluating the criteria
- The meaning of technological laggard

As its primary finding in the 2013 decision, the Court stated that EPA had not provided sufficient notice or opportunity for comment regarding its interpretation of these criteria. To address the Court’s notice and comment concern, EPA solicited comments in the Phase 2 NPRM on our proposed revisions to these criteria. Note that we proposed changes that are different from those at issue during the court case.

#### (i) Constraints on EPA

Several commenters on the 2012 rule argued (implicitly or explicitly) that EPA cannot establish NCPs unless all of the regulatory criteria for NCPs (in 40 CFR 86.1103–87) are met. Some went further to argue that EPA must demonstrate that the criteria are met.

However, the actual regulatory text has never stated that EPA may establish NCPs only if all criteria are met, but rather that EPA shall establish NCPs “provided that EPA finds” the criteria are met. These criteria were included in the regulations to clarify that manufacturers should not expect EPA to initiate a rulemaking to establish NCPs where these criteria were not met. Moreover, the regulations clearly defer to EPA’s judgment for finding that the criteria are met. While EPA must explain the basis of our finding, the regulatory language does not require us to prove or demonstrate that the criteria are met.

This interpretation is consistent with the text of the Clean Air Act, which places no explicit restrictions on when EPA can set NCPs. In fact, it seems to create a presumption that NCPs will be available. The Act actually requires EPA to allow certification of engines that do not meet the standard unless EPA determines the practicable upper limit to be equal to the new emission standard.

To address this confusion, the revised regulatory text explicitly states that where EPA cannot determine if all of the criteria have been met, we may presume that they have. In other words, EPA does not have the burden to prove they have been met. This policy was opposed by Volvo in its comments to this current rulemaking. It stated that EPA findings “must be subject to public review and scrutiny” to “adequately protect complying manufacturers’ competitive interests.” However, EPA sees no basis in the Act to believe that Congress intended EPA to protect complying manufacturers by denying a request for NCPs. Rather, Congress directed EPA to *set the penalty* at a level that would “remove any competitive disadvantage to manufacturers whose engines or vehicles achieve the required degree of emission reduction.”<sup>979</sup> Under the changes being adopted here, compliant manufacturers would retain the ability to challenge whether or not EPA had set penalties at a level that protects them.

#### (ii) Timing for Evaluating Criteria

In order to properly understand the appropriate timing for evaluating each of the NCP criteria, it is necessary to understand the purpose of each. When considered together, these criteria evaluate the likelihood that a manufacturer will be technologically unable to meet a standard on time. However, when EPA initially proposed the NCP criteria, we noted that the first

two criteria addressed whether there was a possibility for a technological laggard to develop. When the first criterion (that there be a new standard) is met, it creates the possibility for a technological laggard to exist. When manufacturers must perform substantial work (as required for the second criterion), it is possible that at least one will be unsuccessful and will become a laggard. Thus, when evaluating these first two criteria, the purpose is to determine whether the standard created the possibility for a laggard to exist. The third criterion is different because it asks whether that *possibility* has turned into a *likelihood* that a technological laggard has developed. For example, a standard may become significantly more stringent and substantial effort might be required for compliance, but all manufacturers may be meeting the applicable standard. In that situation, a technological laggard is not likely and penalties would be unnecessary.

In this context, it becomes clear that since the first two of these criteria are intended to address the question of whether a given standard creates the possibility for this to occur, they are evaluated before the third criterion that addresses the likelihood that the possibility will actually happen. In most cases, it is possible to evaluate these criteria at the point a new standard is adopted. This is the value of these criteria, that they can usually be evaluated long before there is enough information to know whether a technological laggard is actually likely. For example, where EPA adopts a new standard that is not technology-forcing, but rather merely an anti-backsliding standard, EPA could determine at the time it is adopted that the second criterion is not met so that manufacturers would know in advance that no NCPs will be made available for that standard.

One question that arose in the 2012 rule involved how to evaluate the second criterion if significant time has passed and some work toward meeting the standard has already been completed. To address this question, the revised text clarifies that this criterion is to be evaluated based on actual work needed to go from meeting the previous standard to meeting the current standard, regardless of the timing of such changes. EPA looks at whether “substantial work” is or was required to meet the revised standard at any time after the standard was issued—the important question is whether manufacturers who were using technology that met the previous standard would need to build upon that technology to meet the revised standard.

<sup>979</sup> 42 U.S.C. 7525(g)(3)(E).

Other interpretations would seem to be directly contrary to the purpose of the statute, which is designed to allow technological laggards to be able to certify engines even if other manufacturers have met the standard.

#### (iii) Technological Laggards

Questions also arose in 2012 about the meaning of the term “technological laggard.” While the regulations do not define “technological laggard,” EPA has previously interpreted this as meaning a manufacturer who cannot meet the emission standard due to technological difficulties, not merely economic difficulties (67 FR 51464–51465, August 8, 2002). Some have interpreted this to mean that NCPs cannot be made available where a manufacturer tries and fails to meet a standard with one technology but knew that another technology would have allowed them to meet the standard. In other words, that it made a bad business decision. However, EPA’s reference to “economic difficulties” applies where a technological path exists—at the time EPA is evaluating the third criterion—that would allow the manufacturer to meet the standard on time, but the manufacturer chooses not to use it for economic reasons. The key question is whether or not the technological path exists at the time of the evaluation. To address this confusion, the revised text clarifies that where there is uncertainty about whether a failure to meet the standards is a technological failure, EPA may presume that it was. Note that this does not mean that EPA might declare any failure to meet standards as a technological failure. The change would only apply where it is not clear.

#### (4) In-Use Testing

EPA and manufacturers have gained substantial experience with in-use testing over the last four or five years. This has led to important insights in ways that the test protocol can be adjusted to be more effective. EPA is accordingly making the following changes to the regulations in 40 CFR part 86, subparts N and T:

- Revise the NTE exclusion based on aftertreatment temperature to associate the exclusion with the specific aftertreatment device that does not meet the temperature criterion. For example, there should be no NO<sub>x</sub> exclusion if a diesel oxidation catalyst is below the temperature threshold. EPA is also revising the exclusion to consider accommodation of CO emissions when there is a problem with low temperatures in the exhaust.
- Clarify that exhaust temperatures should be measured continuously to

evaluate whether those temperatures stay above the 250 °C threshold.

- Add specifications to describe where to measure temperatures for exhaust systems with multiple aftertreatment devices.
- Include a provision to add 0.00042 g/hp-hr to the PM measurement to account for PM emissions vented to the atmosphere through the crankcase vent.
- Increase the time allowed for submitting quarterly reports from 30 to 45 days after the end of the quarter.

#### (5) Miscellaneous Amendments to 40 CFR Part 86

As described elsewhere, EPA is making several changes to 40 CFR part 86. This includes primarily the GHG standards for Class 2b and 3 heavy-duty vehicles in subpart S. EPA is also making regulatory changes related to hearing procedures, adjustment factors for infrequent regeneration of aftertreatment devices, and the testing program for heavy-duty in-use vehicles.

EPA is making several minor amendments to 40 CFR part 86, including the following:

- Revise 40 CFR 86.1811–17 to clarify that the Tier 2 SFTP for 4,000 mile testing applies to MDPVs, alternative fueled vehicles, and flexible fueled vehicles when operated on a fuel other than gasoline or diesel fuel, even though these vehicles were not subject to SFTP standards under the Tier 2 program. We described this in the Preamble to the Tier 3 final rule, and we are now making this explicit in the regulations.
- Revise 40 CFR 86.1813–17 to clarify that gaseous-fueled vehicles are not subject to the bleed emission test or standard.
- Revise 40 CFR 86.1823 to extend the default catalyst thermal reactivity coefficient for Tier 2 vehicles to also apply for Tier 3 vehicles. This change was inadvertently omitted from the recent Tier 3 rulemaking. EPA will also be interested in a broader review of the appropriate default value for the catalyst thermal reactivity coefficient in some future rulemaking. EPA will be interested in reviewing any available data related to this issue.
- Establish a minimum maintenance interval of 1500 hours for DEF filters for heavy-duty engines. This reflects the technical capabilities for filter durability and the expected maintenance in the field.
- Add crankcase vent filters to the list of maintenance items for heavy-duty engines. This allows manufacturers to specify a maintenance interval of 50,000 miles, or request a shorter interval under § 86.004–25. We are also revising consolidating regulatory provisions in

§ 86.004–25 to allow us to remove § 86.007–25; this reorganization does not change any regulatory requirements.

- Remove the idle CO standard from 40 CFR 86.007–11 and 40 CFR 86.008–10. This standard no longer applies, since all engines are now subject to diagnostic requirements instead of the idle CO standard.
- Revise 40 CFR 86.094–14 to consolidate the streamlined certification procedures for small-volume manufacturers. The consolidated section reduces potential confusion by listing only the provisions that do not apply, rather than trying to create (and maintain) a comprehensive list of all the provisions that apply, in addition to the provisions that do not apply. Except for removing obsolete content, the revised regulation does not include substantive changes to the specified procedures.
- Revise 40 CFR 86.1301 to remove obsolete content.

EPA is also adopting several amendments to remove obsolete text, update cross references, and streamline redundant regulatory text. For example, paragraph (f)(3) of Appendix I includes a duty cycle for heavy-duty spark-ignition engines that is no longer specified as part of the certification process.

#### (6) Applying 40 CFR Part 1068 to Heavy-Duty Highway Engines and Vehicles

As part of the Phase 1 standards, EPA applied the exemption and importation provisions from 40 CFR part 1068, subparts C and D, to heavy-duty highway engines and vehicles. EPA also specified that the defect reporting provisions of 40 CFR 1068.501 were optional. In an earlier rulemaking, EPA applied the selective enforcement auditing under 40 CFR part 1068, subpart E (75 FR 22896, April 30, 2010). EPA is in this rule adopting the rest of 40 CFR part 1068 for heavy-duty highway engines and vehicles, with certain exceptions and special provisions.

40 CFR part 1068 captures a range of compliance provisions that are common across our engine and vehicle programs. These regulatory provisions generally provide the legal framework for implementing a certification-based program. 40 CFR part 1068 works in tandem with the standard-setting part for each type of engine/equipment. This allows EPA to adopt program-specific provisions for emission standards and certification requirements for each type of engine/equipment while taking a uniform approach to the compliance provisions that apply generally.

Many of the provisions in 40 CFR part 1068 were originally written to align with the procedures established in 40 CFR part 85 and part 86. EPA expects the following provisions from 40 CFR part 1068 to not involve a substantive change for heavy-duty highway engines and vehicles:

- Part 1068, subpart A, describes how EPA handles confidential information, how the Administrator may delegate decision-making within the agency, how EPA may enter manufacturers' facilities for inspections, what information manufacturers must submit to EPA, how manufacturers are required to use good engineering judgment related to certification, and how EPA may require testing or perform testing. There is also a description of labeling requirements that apply uniformly for different types of engines/equipment.

- The prohibited acts, penalties, injunction provisions, and related requirements of 40 CFR 1068.101 and 1068.125 correspond to what is specified in Clean Air Act sections 203 through 207 (also see section 213(d)).

- 40 CFR 1068.103 describes how a certificate of conformity applies on a model-year basis. With the exception of the stockpiling provisions in paragraph (g), as described below, these provisions generally mirror what already applies for heavy-duty highway engines.

- 40 CFR 1068.120 describes requirements that apply for rebuilding engines. This includes more detailed provisions describing how the rebuild requirements apply for cases involving a used engine to replace a certified engine.

- 40 CFR part 1068, subpart F, describes procedural requirements for voluntary and mandatory recalls. As noted below, EPA is modifying these regulations to eliminate a few instances where the part 1068 provisions differ from what is specified in 40 CFR part 86, subpart S.

- 40 CFR part 1068, subpart G, describes how EPA would hold a hearing to consider a manufacturer's appeal of an adverse compliance decision from EPA. These procedures apply for penalties associated with violations of the prohibited acts, recall, nonconformance penalties, and generally for decisions related to certification. As noted below, EPA is migrating these procedures from 40 CFR part 86, including an effort to align with EPA-wide regulations that apply in the case of a formal hearing.

EPA is adopting a requirement for manufacturers to comply with the defect-reporting provisions in 40 CFR 1068.501. Defect reporting under 40 CFR 1068.501 involves a more detailed

approach for manufacturers to track possible defects and establishes thresholds to define when manufacturers must perform an investigation to determine an actual rate of emission-related defects. These thresholds are scaled according to production volumes, which allows us to adopt a uniform protocol for everything from locomotives to lawn and garden equipment. Manufacturers that also produce nonroad engines have already been following this protocol for several years. These defect-reporting requirements are also similar to the rules that apply in California.

40 CFR part 1068 includes a definition of "engine" to clarify that an engine becomes subject to certification requirements when a crankshaft is installed in an engine block. At that point, a manufacturer may not ship the engine unless it is covered by a certificate of conformity or an exemption. Most manufacturers have opted into this definition of "engine" as part of the replacement engine exemption as specified in 40 CFR 85.1714. We are making this mandatory for all manufacturers. A related provision is the definition of "date of manufacture," which we use to establish that an engine's model year is also based on the date of crankshaft installation. To address the concern that engine manufacturers might install a large number of crankshafts before new emission standards start to apply as a means of circumventing those standards, we state in 40 CFR 1068.103(g) that manufacturers must follow their normal production plans and schedules for building engines in anticipation of new emission standards. In addition to that broad principle, we state that we will consider engines to be subject to the standards for the new model year if engine assembly is not complete within 30 days after the end of the model year with the less stringent standards.

40 CFR part 1068 also includes provisions related to vehicle manufacturers that install certified engines. EPA states in 40 CFR 1068.105(b) that vehicle manufacturers are in violation of the tampering prohibition if they do not follow the engine manufacturers' emission-related installation instructions, which we approve as part of the certification process.

40 CFR part 1068 also establishes that vehicles have a model year and that installing certified engines includes a requirement that the engine be certified to emission standards corresponding to the vehicle's model year. An exception to allow for normal production and

build schedules is described in 40 CFR 1068.105(a). This "normal-inventory" allowance is intended to allow for installation of previous-tier engines that are produced under a valid certificate by the engine manufacturer shortly before the new emission standards start to apply. Going beyond normal inventory is considered to be "stockpiling." Stockpiling such engines will be considered an unlawful circumvention of the new emission standards. The range of companies and production practices is much narrower for heavy-duty highway engines and vehicles than for nonroad engines and equipment. EPA is therefore finalizing the proposed additional specifications to define or constrain engine-installation schedules that will be considered to fall within normal-inventory practices. In particular, vehicle manufacturers must follow their normal production schedules to use up their supply of "previous-tier" engines once new emission standards start to apply; the regulation further specifies that this allowance may not extend beyond three months into the year in which new standards apply. For any subsequent installation of previous-tier engines, EPA requires that vehicle manufacturers get EPA approval based on a demonstration that the excess inventory is a result of unforeseeable circumstances rather than circumvention of emission standards. EPA approval in those circumstances will be limited to a maximum of 50 engines to be installed for up to three additional months for a single vehicle manufacturer.

We are finalizing these stockpiling provisions, although we received two comments that supported changes from the proposal. Daimler suggested a greater allowance of 1000 or more engines meeting the earlier tier of standards to correspond to prevailing production volumes. This comment appears to reflect an expectation that engine manufacturers would continue to produce these previous-tier engines after the new emission standards have started to apply; however, this is not the case. The inventory allowance is focused on vehicle manufacturers using up their normal inventories of engines that were built before the change in emission standards over some number of months into the New Year. Even high-volume vehicle manufacturers should not be buying large quantities of engines shortly before a change in emission standard. The inventory allowance rather allows for vehicle manufacturers to prudently plan to make a reasonable transition to the new

engines in the months following the point at which the standards start to apply.

Gillig also commented on the stockpiling provisions, advocating a June 30 date for using up their inventory of previous-tier engines. Their production schedule typically involves building a single bus in a day, with the transition to new standards depending on engine manufacturers to provide compliant engines in a timely manner. The proposed allowance was intended to accommodate current business practices that involved using up normal inventory of previous-tier engines within three months after new standards start to apply, with a possible extension to six months if the manufacturer needs additional time to use up the last few of its normal inventory of previous-tier engines. We believe this approach is consistent with Gillig's recommendation.

EPA considered applying 40 CFR part 1068 broadly. It is relatively straightforward to apply the provisions of this part to all engines subject to the criteria emission standards in 40 CFR part 86, subpart A, and the associated vehicles. Manufacturers of comparable nonroad engines are already subject to all these provisions. However, highway motorcycles and Class 2b and 3 heavy-duty vehicles subject to criteria emission standards under 40 CFR part 86, subpart S, are covered by a somewhat different compliance program. EPA is therefore applying only the hearing procedures from 40 CFR part 1068 for highway motorcycles, light-duty vehicles, light-duty trucks, medium-duty passenger vehicles, and chassis-certified Class 2b and 3 heavy-duty vehicles. See Section XIII.D.(1) for a description of the hearing procedures from 40 CFR part 1068.

Note that EPA is amending 40 CFR 85.1701 to specify that the exemption provisions of 40 CFR part 85, subpart R, apply to heavy-duty engines subject to regulation under 40 CFR part 86, subpart A. This is intended to limit the scope of this provision so that it does not apply for Class 2b and 3 heavy-duty vehicles subject to standards under 40 CFR part 86, subpart S. This change corrects an inadvertently broad reference to heavy-duty vehicles in 40 CFR 85.1701.

## B. Amendments Affecting Glider Vehicles and Glider Kits

### (1) Background

EPA proposed several amendments related to both criteria pollutant and GHG emissions from glider vehicles, as well as related provisions for glider

kits.<sup>980</sup> With respect to criteria pollutant emissions, EPA proposed that as of January 1, 2018, most donor engines installed in glider vehicles would have to meet criteria pollutant standards corresponding to the year of assembly of the glider vehicle. This would amend the provision allowing donor engines to meet the standards for the year of the engine. 40 CFR 1037.150(j). EPA further solicited comment on an earlier effective date for this provision. 80 FR 40529.

With respect to GHG emissions, EPA proposed that all glider vehicles (whether produced by large or small manufacturers) meet the Phase 2 vehicle standards (which, among other things, would entail glider kit manufacturers generating fuel maps for each engine that would be used). This would remove a transition provision from the Phase 1 rules which allowed glider vehicles to use engines not certified to the Phase 1 standards. 40 CFR 1037.150(j). Glider vehicles produced by large manufacturers are presently subject to the Phase 1 vehicle standards, but those produced by small manufacturers are not. 40 CFR 1037.150(c). Put a different way, the combination of these two provisions means that non-small businesses could use pre-2013 engines in glider vehicles, but were required to meet (and certify to) the Phase 1 GHG vehicle standards. EPA proposed to require all glider vehicles to meet the applicable GHG standards as of January 1, 2018. See generally 80 FR 40528.

In the March, 2016 Notice of Data Availability, EPA solicited further comment on possible exceptions to the proposal.<sup>981</sup> Specifically, EPA solicited comment with respect to engines meeting 2010 criteria pollutant standards, and for engines still within their original regulatory useful life. 81 FR 10826.<sup>982</sup>

EPA received many comments from manufacturers of both glider kits and glider vehicles, many comments from manufacturers of engines meeting current criteria pollutant standards and dealers selling trucks containing those

<sup>980</sup> Glider vehicles are motor vehicles produced to accept rebuilt engines (or other used engines) along with used axles and/or transmissions. The common commercial term "glider kit" is used here primarily to refer to a chassis into which the used/rebuilt engine is installed. See Figure I-1 in section I.E.1 of this Preamble, showing a picture of a glider kit.

<sup>981</sup> The NODA requested comment on an EPA memorandum "Legal Memorandum Discussing Issues Pertaining to Trailers, Glider Vehicles, and Glider Kits under the Clean Air Act", February 2016, EPA-HQ-OAR-2014-0827-1627, 81 FR 10826.

<sup>982</sup> Glider vehicles and glider kits are exempt from NHTSA's Phase 1 fuel consumption standards. NHTSA did not propose revisions specific to glider vehicles in this rulemaking.

compliant engines, and comments from the NGO community and from CARB. Engine and vehicle manufacturers took opposing positions. Some supported the proposed approach, and urged an earlier effective date to avoid a pre-buy of glider vehicles with highly polluting engines. Others stated that the proposed provisions exceeded EPA's authority to set emission standards for new engines and new vehicles, in addition to objecting to the proposed provisions as a matter of policy. See Section I.E.1 of this document and RTC Section 14.2. Some of the comments helped EPA target flexibility for glider vehicles that serve arguably legitimate purposes (such as reclaiming relatively new powertrains from vehicles chassis that fail prematurely), without causing substantial adverse environmental impacts. All of these comments are fully summarized and responded to in RTC Section 14.2. We set out here the actions we are taking in this Phase 2 rule, and then explain the basis for those actions.

### (2) Overview of Final Rule Provisions for Glider Kits and Glider Vehicles

We are finalizing the proposed glider-related provisions but have made several revisions in recognition of the differences between glider vehicles produced to avoid the 2010 criteria pollutant emission standards and those manufactured for other more legitimate purposes. The provisions being finalized are intended to allow a transition to a long-term program in which manufacture of glider vehicles better reflects the original reason manufacturers began to offer these vehicles—to allow the reuse of relatively new powertrains from damaged vehicles.

Under the provisions being finalized for the long-term program, all glider vehicles will need to be covered by both vehicle and engine certificates. The vehicle certificate will require compliance with the GHG vehicle standards of 40 CFR part 1037. The engine certificate will require compliance with the GHG engine standards of 40 CFR part 1036, plus the criteria pollutant standards of 40 CFR part 86. Used/rebuilt/remanufactured engines may be installed in the glider vehicles without meeting standards for the year of glider vehicle assembly, provided the engines are within their regulatory useful life (or meet similar criteria). These engines would still need to meet criteria pollutant standards corresponding to the year of the engine.

EPA is also finalizing a transitional program that will allow glider vehicle manufacturers additional flexibility. The first step allows each

manufacturer's combined production of glider kits and glider vehicles with higher polluting engines to be at the manufacturer's highest annual production of glider kits and glider vehicles for any year from 2010 to 2014.<sup>983</sup> Any glider vehicles produced in greater volumes would need to meet the engine standards corresponding to the year of the assembly of the glider vehicle. With respect to GHG standards, all vehicles within this allowance will remain subject to the existing Phase 1 requirements for both engines and vehicles, so that small manufacturers would still be exempt from these provisions up to the allowance. Any glider kits and glider vehicles produced beyond this allowance will be subject to all requirements applicable to new engines and new vehicles for MY 2017. Other than the 2017 production limit, EPA will continue the Phase 1 approach until January 1, 2018. This allows small businesses to produce glider kits and glider vehicles up to the production limit without new constraints. Large manufacturers producing complete glider vehicles remain subject to the 40 CFR part 1037 GHG vehicle standards, as they have been since the start of Phase 1. However large manufacturers may provide exempted glider kits to small businesses during this time frame.

Effective January 1, 2018, the long-term program begins generally, but with certain transitional flexibilities. In other words, except for the following allowances, glider vehicles will need to comply with the long-term program. The exceptions are:

- Small businesses may produce a limited number of glider vehicles without meeting either the engine or vehicle standards of the long-term program. Larger vehicle manufacturers may provide glider kits to these small businesses without the assembled vehicle meeting the applicable vehicle standards. This number is limited to the small vehicle manufacturer's highest annual production volume in 2010 through 2014 or 300, whichever is less.
- Model year 2010 and later engines are not required to meet the Phase 1 GHG engine standards.
- Used/rebuilt/remanufactured engines may be installed in the glider vehicles without meeting standards for the year of glider vehicle assembly, provided the engines are within their regulatory useful life (this provision

continues from the transitional program).

These 2018 allowances mostly continue after 2020, but effective January 1, 2021, all glider vehicles will need to meet the Phase 2 GHG vehicle standards. This means that large manufacturers providing glider kits to small manufacturers will need to meet the GHG vehicle standards for the completed vehicle (pursuant to the delegated assembly provisions), or ship the glider kit to the final glider vehicle manufacturer pursuant to the incomplete vehicle provisions (where the final glider vehicle manufacturer would be the certificate holder).

EPA is thus discontinuing both 40 CFR 1037.150(c) and (j) in this Phase 2 rulemaking. As finalized, the Phase 2 regulations will therefore generally treat glider vehicles the same as other new vehicles.<sup>984</sup> As a result, glider vehicles must be certified to the Phase 2 vehicle GHG standards, which (among other things) require a fuel map for the actual engine in order to run GEM. In other words, manufacturers producing glider kits need to meet the applicable GHG vehicle standards and, as part of their compliance demonstration, need to have a fuel map for each engine used. Alternatively, the final assembler could be the entity to obtain the certificate, provided it had substantial control of the overall emissions performance of the completed vehicle. In either case, manufacturers unable to obtain a fuel map for an engine may ask to use a default map, consistent with good engineering judgment.

EPA is also providing a limited allowance for small business manufacturers as described in 40 CFR 1037.150(t), and also providing a generally-applicable allowance that is conditioned on the age of the reused engine as described in 1037.635. See Section XIII.B.(4) below. EPA is also adopting new definitions of "glider vehicle" and "glider kit" in 40 CFR 1037.801 that are generally consistent with the common understanding of these terms as meaning new chassis with a rebuilt or other used engine and new chassis designed to accept a rebuilt or other used engine/powertrain. EPA is also clarifying its requirements for certification and revising its definitions for glider manufacturers, as described below, to ensure that affected manufacturers understand their responsibilities under the regulations.

It is important to emphasize that EPA is not banning gliders. Rather, as described below, EPA is requiring that glider vehicles meet the standards that all other new trucks are required to meet, unless eligible for certain limited exemptions that provide flexibility for small businesses and for certain other specific applications. Moreover, the provisions being finalized are more flexible than those proposed, but focus the additional flexibility on vehicles using relatively clean engines, and on engines within their regulatory useful life, consistent with the original purpose of glider kits and vehicles.<sup>985</sup>

EPA proposed to begin these requirements January 1, 2018, but requested comment on beginning the requirements sooner. Since the NPRM, production of gliders has surged and now likely exceeds 10,000 per year. We are concerned that by finalizing restrictions for 2018 in this rule we risk causing a pre-buy scenario where production surges further in 2017. This would be both very harmful to the environment and disruptive to the market. To avoid these problems and to ensure a smoother transition, we are finalizing a glider kit and glider vehicle production limit for calendar year 2017 for glider vehicles using high polluting engines. The allowable production is based on past sales for all large and small manufacturers. Specifically, each manufacturer's combined 2017 production of glider kits and glider vehicles using high polluting engines will be capped at the manufacturer's highest annual production of glider kits and glider vehicles for any year from 2010 to 2014. All vehicles within this allowance will remain subject to the existing Phase 1 GHG provisions as they presently apply. Any glider kits or glider vehicles produced beyond this allowance will be subject to all requirements applicable to new engines and new vehicles for MY 2017.

### (3) Impacts of Current Glider Market

Current standards for NO<sub>x</sub> and PM (which began in 2007 and took full effect in 2010) are at least 90 percent lower than the most stringent previously applicable standards, so the NO<sub>x</sub> and PM emissions of any glider vehicles using pre-2007 engines are at least ten times higher than emissions from equivalent vehicles being produced with brand new engines.<sup>986</sup> However,

<sup>983</sup> Although discussed here as a limit on the number of glider vehicles that may be produced, these provisions are actually exemptions for manufacturers from the more generally applicable restrictions on the production of glider vehicles, as the following sentence in the text above makes clear.

<sup>984</sup> EPA has structured these regulations for glider vehicles to lay out a general requirement that treats glider vehicles (and the engines installed in them) the same as other new vehicles (and new engines), but also includes several exemptions from this general requirement.

<sup>985</sup> Although discussed here as a limit on the number of glider vehicles that may be produced, these provisions are actually exemptions for manufacturers from the more generally applicable restrictions on the production of glider vehicles.

<sup>986</sup> The NO<sub>x</sub> and PM standards for MY 2007 and later engines are 0.20 g/hp-hr and 0.01 g/hp-hr,

most gliders being produced today use engines originally manufactured before 2002.<sup>987</sup> Since these pre-2002 engines lack both EGR and exhaust aftertreatment, they would have NO<sub>x</sub> and PM emissions 20–40 times higher than current engines. If miscalibrated, emissions could be even higher. Thus, each glider vehicle using an older engine that is purchased instead of a new vehicle with a current MY engine results in significantly higher in-use emissions of air pollutants associated with a host of adverse human health effects, including premature mortality (see Section VIII above).

These emission impacts have been compounded by the increasing sales of these vehicles. Estimates provided to EPA indicate that production of glider vehicles has increased by an order of magnitude from what it was in the 2004–2006 time frame—from a few hundred each year to thousands.<sup>988</sup> Glider vehicle production is not currently being reported to EPA, but EPA estimates that current production is close to 10,000 each year based on comments—including comments from manufacturers of glider vehicles. While the few hundred glider vehicles produced annually in the 2004–2006 timeframe may have been produced for arguably legitimate purposes, such as salvaging powertrains from vehicles otherwise destroyed in crashes, EPA believes (as did many commenters) that the more than tenfold increase in glider kit production since the MY 2007 criteria pollutant emission standards took effect reflects an attempt to avoid these more stringent standards and (ultimately) the Clean Air Act.

At proposal, EPA estimated the environmental impact of 5,000 glider vehicles per year, which would be roughly 2 percent of the Class 8 vehicles manufactured annually.<sup>989</sup> We estimated that at that rate, these gliders could account for as much as one-half of total NO<sub>x</sub> and PM emissions from all

new Class 8 vehicles. Several commenters supported EPA's assessment of the environmental impacts of glider vehicles. Volvo suggested the impacts were even greater, estimating that 2014 glider sales were “on the order of 6,000” and that they emit twice as many tons of PM as the rest of the 2014 vehicles. In later supplemental comments, Volvo provided evidence that current sales have grown to 10,000 or more per year. Even some commenters opposing EPA's proposal acknowledged that glider sales are now over 10,000 units annually. No commenters disagreed with EPA's previous (understated) assessment of NO<sub>x</sub> and PM impacts.

For the final rule, EPA has updated its analysis of the environmental impacts of gliders. The updated analysis used the same emissions modeling tool used to estimate the other emissions impacts of the rule, described in Section VII of the Preamble. The modeling of gliders assumed annual glider sales of 10,000 for 2015 and later, consistent with the comments received on the proposal. The modeling also assumed that these gliders emit at the level equivalent to the engines meeting the MY 1998–2001 standards, since most glider vehicles currently being produced use remanufactured engines of this vintage, and projects them to have the same usage patterns/lifetimes as similar new vehicles. (We did not attempt to account for any miscalibration of these engines). This analysis shows that without the new restrictions, glider vehicles on the road in 2025 would emit nearly 300,000 tons of NO<sub>x</sub> and nearly 8,000 tons of PM annually. Although glider vehicles would make up only 5 percent of heavy-duty tractors on the road, their emissions would represent *about one third* of all NO<sub>x</sub> and PM emissions from heavy-duty tractors in 2025. By restricting the number of glider vehicles with high polluting engines on the road, these excess PM and NO<sub>x</sub> emissions will decrease dramatically, leading to substantial public health-related benefits. Put into monetary terms using PM-related benefit-per-ton values described in Section IX.H, the removal of all unrestricted glider vehicle emissions from the atmosphere would yield between \$6 to \$14 billion in benefits annually (2013\$). It is clear that removing even a fraction of these glider vehicles with high polluting engines from the road will yield substantial health-related benefits.

#### (4) EPA Engine Standards

EPA is thus amending its rules to generally require that glider vehicles produced on or after January 1, 2017 use

engines certified to the standards applicable to the calendar year in which assembly of the glider vehicle is completed, with an exception in 2017 that provides a larger number of glider vehicles under the transitional production allowance. (Other exceptions to this general requirement are discussed later). This requirement applies to all pollutants, and thus encompasses criteria pollutant standards as well as the separate GHG standards. Used or rebuilt engines may be used, as long as they have been certified to the same standards that apply for the calendar year of glider vehicle assembly. For example, if assembly of a glider vehicle is completed in calendar year 2020, the engine must generally meet standards applicable for MY 2020. (If the engine standards for model year 2020 are the same as for model years 2017 through 2019, then any model year 2017 or later engine may be used).

EPA is amending these rules because, with the advent in MY 2007 of more stringent HD diesel engine criteria pollutant standards, continuation of provisions allowing unlimited use of rebuilt and reused engines meeting much earlier MY criteria pollutant standards results in unnecessarily high in-use emissions. See Section XII.B.(3) above. As stated there, these emissions form an increasingly high percentage of the vehicular inventory for such dangerous pollutants as NO<sub>x</sub> and diesel exhaust PM (a likely human carcinogen), all of which are associated with the most serious adverse health effects up to and including premature mortality. GHG emissions from these engines also are controllable. As more glider vehicles are produced, EPA believes these emissions should be controlled to the same levels as other new engines.

The older engines currently being used in most glider vehicles could be retrofitted with exhaust aftertreatment to meet current standards. However, the primary reason these engines have been used is because they do *not* include aftertreatment.<sup>990</sup> Thus, we believe retrofitting these engines would not be a preferred path. The more likely compliance path would be to install a used 2010 or later engine, since such engines are presently available and it would be probably be much simpler and less expensive to use a 2010 engine than to retrofit an older engine to meet current standards. Manufacturers will

respectively. The standards for MY 2004 through 2006 engines were ten times these levels, and earlier standards were even higher.

<sup>987</sup> See, e.g. <http://www.truckinginfo.com/article/story/2013/04/the-return-of-the-glider.aspx>, describing the engines used by a leading manufacturer of glider vehicles (“1999 to 2002-model diesels were known for reliability, longevity and good fuel mileage. Fitzgerald favors Detroit's 12.7-liter Series 60 *from that era*, but also installs pre-EGR 14-liter Cummins and 15-liter Caterpillar diesels. All are rebuilt . . .”) (emphasis added). See also additional documentation of this point in RTC Section 14.2.

<sup>988</sup> “Industry Characterization of Heavy Duty Glider Kits,” MacKay & Company, September 30, 2013.

<sup>989</sup> Frequently Asked Questions about Heavy-Duty “Glider Vehicles” and “Glider Kits,” EPA–420–F–15–904, July 2015.

<sup>990</sup> <http://www.truckinginfo.com/article/story/2013/04/the-return-of-the-glider.aspx>, accessed July 16, 2016.

likely also seek to qualify under other flexibilities provided in the Final Rule.

Recognizing that the environmental impacts of gliders using newer engines will generally be much smaller, EPA requested comment on whether we should treat such gliders differently than gliders using older engines. 80 FR 40528; 81 FR 10826. Based on comments received on the NODA, EPA is finalizing additional flexibilities for newer engines and for engines with very low mileage. More specifically, EPA will allow engines meeting any of the following criteria to be used in glider vehicles without meeting current engine standards for either criteria pollutants or GHGs:

(1) Engines still within their original useful life in terms of both miles and years.

(2) Engines of any age with less than 100,000 miles of engine operation, provided the engines' miles are properly documented.

(3) Engines less than three years old with any number of accumulated miles of engine operation.<sup>991</sup>

Engines covered by these three criteria are consistent with the original intended use of glider kits—the salvaging of relatively new powertrains from vehicle chassis that have been damaged or have otherwise failed prematurely. Most of these engines would be covered by the first criterion. While nearly all of these engines would be model year 2010 or later, this criterion would theoretically allow use of model year 2008 or 2009 engines in calendar years before 2020.

Nevertheless, such engines would have been certified to the same PM standards as the 2010 engines, and would likely have NO<sub>x</sub> emissions at or below 1.2 g/hp-hr (*i.e.*, the typical certification level for engines of that vintage). EPA is adopting the second criterion to address very rare cases that were identified in comments in which annual VMT is so low that engines would not reach

100,000 miles within ten years (the useful life in years). These engines could be higher emitting, but would necessarily be in applications with very low usage, such as a small town fire truck. As such, the total emissions from such vehicles would be very small. The third criterion would address other rare cases such as where an engine is just outside the useful life in miles, or the miles cannot be determined. These engines would necessarily be model year 2015 or later, and would thus all meet the 2010 standards. Considered together, this additional flexibility would have little adverse emission impact because there would be relatively few engines covered by these exceptions and the vast majority would be 2010 or later.

Several commenters supported allowing unlimited production of glider vehicles if they use engines certified to 2010 or later NO<sub>x</sub> and PM standards, without regard to whether the engines were still within their useful life. EPA sees merit in this concept, but is concerned that it may not be appropriate in perpetuity. Obviously, reuse of engines originally certified to the 2010 standards for criteria pollutants would not have the same adverse environmental impacts as the current practice of reusing pre-2002 engines that have NO<sub>x</sub> and PM emissions 20–40 times higher than current engines (or using post-2002 but pre-2007 engines, which remain an order of magnitude more polluting). However, they would not necessarily be as clean for GHG or criteria pollutants as brand new engines with all new aftertreatment components. The Phase 1 and Phase 2 engine standards mean that brand new engines will have lower GHG emissions than pre-Phase 1 engines. See RIA Chapter 8 and RTC Section 14.2.

And used 2010 aftertreatment components may be less effective at reducing NO<sub>x</sub> or PM than when new. Moreover, EPA has been petitioned to adopt more stringent NO<sub>x</sub> and/or PM standards in the future. See Section I.F.(1) above. Thus, while using 2010 engines in glider vehicles would greatly reduce the most serious concerns about NO<sub>x</sub> and PM emissions relative to current gliders, it would not eliminate all adverse environmental impacts.

To balance these factors, EPA is finalizing an interim provision—a provision which may sunset if EPA adopts new more stringent NO<sub>x</sub> or PM standards for heavy duty engines—that will treat gliders using MY 2010 and later engines the same as those using engines within their useful life. This would avoid most of the adverse impacts, especially for NO<sub>x</sub> and PM.

Not requiring these engines to meet the latest GHG standards could have some impacts, but they would likely be small, especially if glider vehicle sales return to pre-2007 levels. EPA will continue to monitor sales patterns and may rescind this flexibility in a future rulemaking.

Several commenters expressed concern about the impact of the proposed changes on small businesses that produce glider vehicles. However, commenters opposing the proposed requirements/clarifications did not address the very significant adverse environmental impacts of the huge increase in glider vehicle production over the last several years. EPA recognized at the time of the proposal that production of a smaller number of other gliders by small manufacturers may be appropriate, at least as an interim allowance. 80 FR 40529. To allow this, EPA is adopting the proposed provision that will somewhat preserve the regulatory status quo for existing small businesses, allowing limited production using highly polluting engines based on recent sales. This means a limited number of glider vehicles produced by small businesses may use older rebuilt or used engines, provided those engines were certified to standards from the year of the engine's manufacture. (Note that beginning in MY 2021, these vehicles will have to meet the GHG vehicle standards, although they would not be required to meet current criteria pollutant standards.) For example, an existing small business that produced glider vehicles between 2010 and 2014, with a peak production of 200 in 2013, may produce up to 200 glider vehicles per year under without having to certify them to the GHG standards, or re-certifying the engines to the now-applicable EPA standards for criteria pollutants (so long as the engine is certified to criteria pollutant standards for the year of its manufacture). To be eligible for this provision, 40 CFR 1037.150(t), the regulation specifies that no small entity may produce more than 300 glider vehicles (including any glider kits it sells to another assembler) using the older engines in any given model year without recertifying the engines to current EPA standards. EPA believes that this level reflects the upper end of the range of production that occurred before significant avoidance of the 2007 criteria pollutant standards began. EPA believes that, given this relief combined with the other changes being made into the final regulations, any small businesses that have been focused on producing gliders for legitimate purposes will not be significantly

<sup>991</sup> EPA's authority to craft different provisions for engines within their useful life, and provisions allowing continued production of glider vehicles using pre-2010 engines comes from CAA authority to consider costs under section 202(a)(2) and 202(a)(3)(D), as well as the broad authority in section 202(a)(3)(D) over engine rebuilding. Thus, many of these flexibilities are tailored to avoid significant and disproportionate economic impacts on small business glider vehicle manufacturers by allowing most small businesses to continue to produce glider vehicles consistent with current levels of production, consistent with the recommendations of the Small Business Advocacy Review panel. See RIA section 12.7.3. Allowing continued use of engines within their original useful life is also consistent with one purpose of the engine rebuilding provisions, which is to find some legitimate means of salvaging heavy duty engines without backsliding from those engines' original certified condition. See 62 FR 54702.



impacted by the new requirements, since they can use donor engines within their regulatory useful life for either age or mileage. See generally RIA Chapter 12.7.3. Only those small businesses that have significantly increased production to create new trucks to avoid the 2010 NO<sub>x</sub> and PM standards will have their sales significantly restricted.

This small business flexibility is intended for small entities for whom glider production is a substantial portion of their revenue to allow them to transition to the long-term program where they would generally install newer cleaner engines. (We recognize that the final regulations will allow some small businesses to produce a limited number of glider vehicles with higher polluting engines as a side business, but do not expect these manufacturers to produce very many glider vehicles.) We intend to monitor its use and may place additional restriction on this flexibility in the future consistent with this intended purpose.

We are also adopting provisions to facilitate a smoother transition for small businesses that assemble glider vehicles from glider kits produced by larger manufacturers. Although the long-term program will require vehicle certificates for glider vehicles produced by small manufacturers using exempted engines, we are delaying the requirement for a vehicle certificate until 2021 for these glider vehicles. This means the large glider kit manufacturers may continue the Phase 1 allowance to sell exempted glider kits (*i.e.*, uncertified glider kits) to small assemblers as previously allowed under Phase 1 by 40 CFR 1037.620. However, beginning January 1, 2021, each glider kit sold to small assemblers will need to have a vehicle certificate the same as is required for other new Phase 1 and Phase 2 glider vehicles.

Although we are allowing this flexibility for glider kit manufacturers, they remain responsible to take reasonable steps to ensure that their glider kits are not used to produce complete vehicles in violation of the regulations. Most importantly, the glider kit manufacturer must comply fully with the requirements of 40 CFR 1037.622, which specifies certain minimum requirements for shipping uncertified incomplete vehicles. If the glider kit manufacturer is the certificate holder, then the glider kit manufacturer would have to comply with the delegated assembly requirements of 40 CFR 1037.621. See 40 CFR 1037.635(d)(3). In addition, we would expect manufacturers of glider kits to have records to verify that the vehicle assembler to whom they are shipping an

uncertified glider kit (which would remain permissible under Phase 1) is aware of the regulatory requirements and is eligible to produce glider vehicles with older engines that do not meet current criteria pollutant standards (*i.e.*, is a small business within the volume limit, or is using engines within their regulatory useful life). For any assembler that is purchasing more than one hundred glider kits in a year from a kit manufacturer, the kit manufacturer should verify that they are not exceeding their allotted number. For smaller assemblers, it may be sufficient to verify that they are not requesting more glider kits from that kit manufacturer than they purchased in any year from 2010 to 2014. Failure to comply with these requirements, or shipping glider kits to an ineligible manufacturer which produces glider vehicles with non-compliant engines, may void the exemption granted pursuant to 40 CFR 1037.621 or 1037.622. For example, as explained in Section I.E.(1)(d) above, supplying glider kits to an ineligible manufacturer could result in causing a violation of the Act, and thus is itself a prohibited act under section 203(a)(1).

Finally, we are adopting a new provision in 40 CFR 1036.150(o) that would allow an engine manufacturer to modify a used engine to be identical to a previously certified configuration. (This is similar to the allowance in 40 CFR 1068.201(i).) This allows the manufacturer to include the used engine in an existing certificate for the purposes of complying with the requirement to meet current standards when installing an engine into a glider vehicle. For example, if an engine manufacture modified a used 2009 engine to be identical to a certified 2017 engine, we would allow the 2009 engine to be covered by the 2017 certificate, which would allow it to be installed into a glider vehicle without restriction.

#### (5) Lead Time for Amended Provisions

Other than the production volume provision discussed at the beginning of this Section XIII.B, the requirement for gliders to meet engine and vehicle standards applicable to other new vehicles and engines do not take effect before January 1, 2018. With respect to the criteria pollutant engine standards, EPA believes this provides sufficient time to “permit the development and application of the requisite control measures” (CAA section 202(a)(3)(D)) because compliant engines are available today, although manufacturers will need several months to change business practices to comply.

Some commenters argued that because some of these requirements relate to criteria pollutant standards, EPA must provide at least four years lead time pursuant to section 202(a)(3)(C) of the Clean Air Act. EPA addresses these comments in Section I.E.(1) and in the RTC Sections 1.3.1 and 14.2. With respect to the vehicle standards, EPA notes that the requirements already apply for vehicles not produced by small businesses. EPA believes that delaying the applicability of the vehicle standards to small businesses until 2021 when Phase 2 takes effect provides ample time to comply with vehicle GHG standards. See CAA section 202(a)(2) (standards to provide lead time sufficient to allow for “development and application of the requisite technology”).

#### (6) Legal Authority and Definitions Under the Clean Air Act

With respect to statutory authority for the criteria pollutant standards under the Clean Air Act, EPA notes first that it has broad authority to control all pollutant emissions from “any” rebuilt heavy duty engines (including engines beyond their statutory useful life). See CAA section 202(a)(3)(D). EPA is to give “appropriate” consideration to issues of cost, energy, and safety in developing such standards, and to provide necessary lead time to implement those standards. If a used engine is placed in a new glider vehicle, the engine will be considered a “new motor vehicle engine” because it is being used in a new motor vehicle. See CAA section 216(3) and Section I.E.(1). With respect to the vehicle-based GHG standards, there is no question that the completed glider vehicle is a “motor vehicle” under the Clean Air Act. Some commenters have questioned whether a glider kit (without an engine) is a motor vehicle. However, EPA considers glider kits to be incomplete motor vehicles and entities manufacturing gliders to be manufacturers of those vehicles, and EPA has the authority to regulate incomplete motor vehicles and manufacturers thereof, including un-motorized chassis. See Section I.E.(1)

Under the CAA, it is also important that “new” is determined based on legal title and does not consider prior use. Thus, glider vehicles that have a new vehicle identification number (VIN) and new title are considered to be “new motor vehicles” even if they incorporate previously used components. It is also the case that under the Clean Air Act, EPA does not consider the fact that a vehicle retained the VIN of the donor vehicle from which the engine was obtained determinative of whether or



not the vehicle is new. See Section I.E.(1) (responding to comment on this point).

The CAA also defines “manufacturer” to include any person who assembles new motor vehicles. As proposed, EPA is revising its regulatory definitions of these terms in 40 CFR 1036.801 and 1037.801 to more clearly reflect these aspects of the CAA definitions. The revised definitions make clear that:

- New glider kits are “new motor vehicles.” Manufacturers therefor must certify to the Phase 2 vehicle standards unless they are selling the glider kit to a secondary manufacturer that has its own certificate.

- Previously used engines installed into glider kits are “new motor vehicle engines.”

- Any person who completes assembly of a glider vehicle is a “manufacturer” thereof.

EPA also notes that under existing regulations, glider kit assemblers (*i.e.* entities that assemble the glider vehicle by adding the donor engine to the kit) are already considered to be secondary vehicle manufacturers, who may receive incomplete vehicles (such as glider kits) from OEMs if they have a valid certificate or exemption (see 40 CFR 1037.622). Secondary vehicle manufacturers may also receive certified glider kits to complete in a delegated assembly agreement (see 40 CFR 1037.621).

To further clarify that EPA considers both glider kits and completed glider vehicles to be motor vehicles, EPA is adding a clarification to our definition of “motor vehicle” in 40 CFR 85.1703 regarding vehicles such as gliders that clearly are intended for use on highways, consistent with the CAA definition of “motor vehicle” in CAA section 216(2). The regulatory definition previously contained a provision stating that vehicles lacking certain safety features required by state or federal law are not “motor vehicles.” EPA recognized that this caveat needed a proper context: Is the safety feature one that would prevent operation on highways? See 80 FR 40529. If not, absence of that feature does not result in the vehicle being other than a motor vehicle. The amendment will consequently make clear that vehicles that are clearly intended for operation on highways are motor vehicles, even if they do not have every safety feature. This clarifying provision takes effect with this rule.

We note that NHTSA and EPA have separate definitions for motor vehicles under their separate statutory authorities. As such, EPA’s determination of how its statute and

regulations apply to glider kits and glider vehicles has no bearing on how NHTSA may apply its safety authority with regard to them.

#### (7) Summary of the Requirements for Glider Vehicles

The provisions being finalized are intended to allow a transition to a long-term program in which use of glider kits is permissible consistent with the original reason manufacturers began to offer glider kits—to allow the reuse of relatively new powertrains from damaged vehicles. The long-term program as well as the transitional program are summarized below.

##### (a) Long-Term Program for Gliders

Ultimately all gliders will need to be covered by both vehicle and engine certificates. The vehicle certificate will require compliance with the GHG vehicle standards of 40 CFR part 1037. The engine certificate will require compliance with the GHG engine standards of 40 CFR part 1036, plus the criteria pollutant standards of 40 CFR part 86. Used/rebuilt engines may be installed in the glider vehicles, provided (1) they meet all standards applicable to the year in which the assembly of the glider vehicle is completed; or (2) meet all standards applicable to the year in which the engine was originally manufactured and also meet one of the following criteria:

- The engine is still within its original useful life in terms of both miles and years.
- The engine has less than 100,000 miles of engine operation.
- The engine is less than three years old.

In most of these cases, the glider vehicles will need to have a vehicle certificate demonstrating compliance with the vehicle GHG standards that apply for the year of assembly. However, in the case of engines with less than 100,000 miles, glider vehicles conforming to the vehicle configuration of the donor vehicle do not need to be recertified to current vehicle standards.

##### (b) Transitional Program for Gliders

For calendar year 2017, each manufacturer’s combined production of glider kits and glider vehicles will be capped at the manufacturer’s highest annual production of glider kits and glider vehicles for any year from 2010 to 2014. All vehicles within this allowance will remain subject to the existing Phase 1 provisions, including its exemptions. Any glider kits or glider vehicles produced beyond this allowance will be subject to the long-term program.

Other than the 2017 production limit, EPA will continue the Phase 1 approach until January 1, 2018. This allows small businesses to produce glider vehicles up to the allowance without other new constraints before 2018. Large manufacturers producing complete glider vehicles remain subject to the 40 CFR part 1037 GHG vehicle standards, as they have been since the start of Phase 1. However large manufacturers may provide exempted glider kits to small businesses during this time frame. Other than the 2017 production limit, EPA will continue the Phase 1 approach until January 1, 2018. This allows small businesses to produce glider vehicles up to the cap without other new constraints before 2018. Large manufacturers producing complete glider vehicles remain subject to the 40 CFR part 1037 GHG vehicle standards, as they have been since the start of Phase 1. However large manufacturers may provide exempted glider kits to small businesses during this time frame.

Effective January 1, 2018, the permissible number of glider vehicles that may be produced without meeting the long-term program will be limited to two specific exceptions. The exceptions are:

- Small businesses may produce a limited number of glider vehicles without meeting either the engine or vehicle standards of the long-term program. Larger vehicle manufacturers may provide glider kits to these small businesses without meeting the applicable vehicle standards. This number is limited to the small manufacturer’s highest annual production volume in 2010 through 2014 or 300, whichever is less.
- Model year 2010 and later engines are not required to meet the Phase 1 GHG engine standards.

These 2018 allowances mostly continue after 2020, but the following change takes effect January 1, 2021:

- All glider kits provided by large manufacturers (including to small manufacturers or for use with 2010 engines) must meet the vehicle standards for the completed vehicle.

EPA is not establishing an end to these transitional provisions at this time. We intend to monitor this industry and will reevaluate the appropriateness of these provisions in the future.

#### *C. Applying the General Compliance Provisions of 40 CFR Part 1068 to Light-Duty Vehicles, Light-Duty Trucks, Chassis-Certified Class 2<sub>B</sub> and 3 Heavy-Duty Vehicles and Highway Motorcycles*

As described above, EPA is applying all the general compliance provisions of 40 CFR part 1068 to heavy-duty engines

and vehicles subject to 40 CFR parts 1036 and 1037. EPA is also applying the amended hearing procedures from 40 CFR part 1068 to highway motorcycles and all vehicles subject to standards under 40 CFR part 86, subpart S. However, based on comments, we are not finalizing broader changes at this time.

Volvo objected to extending the defect-reporting provisions of 40 CFR part 1068 to heavy-duty engines and vehicles. They stated that they have a robust approach to defect-reporting that is largely consistent with what applies under 40 CFR part 1068 (in addition to complying with CARB's warranty-reporting requirements), but argued that it would be cost-prohibitive to comply nationwide with the new federal requirements. They commented that the higher reporting thresholds would lead to fewer reports. We understand and accept that there may be fewer defect reports; in fact, we count this as a positive development since industry and agency efforts toward documenting and addressing defects will be focused on cases that are worthy of greater attention. The defect threshold of 25 units under 40 CFR part 85 is not appropriate for the sales volumes associated with heavy-duty engines and vehicles.

Light-duty automotive manufacturers also objected to the mandatory migration of defect-reporting provisions to 40 CFR part 1068 for heavy-duty vehicles they produce, emphasizing that their light-duty and heavy-duty vehicles should be subject to the same defect-reporting protocol to reduce complexity and risk of error. Although we are not applying the 40 CFR part 1068 defect-reporting requirements to heavy-duty vehicles subject to the requirements of 40 CFR part 86, subpart S, we are applying them to all other heavy-duty vehicles produced by these manufacturers. As noted below, we plan to eventually migrate the defect-reporting provisions for all light-duty and heavy-duty vehicles to 40 CFR part 1068, and see no harm in doing so in steps. These manufacturers also expressed three more detailed concerns about defect reporting under 40 CFR part 1068: (1) Twice-annual investigation reports may show no defects, which would add a paperwork burden for no benefit, (2) the reporting period covers the full useful life, rather than just the first five years, which is the time when most defects appear, and (3) tying defect reporting to warranty claims may discourage extended warranties. The idea behind the investigation reports is that a high rate of possible defects may or may not be

associated with a substantial number of actual defects. The investigation reports are intended to address exactly that question. The burden arises only when the manufacturer has a high enough rate of possible defects to warrant further attention. We see no reason to disregard defect information between five years and the end of the useful life, since manufacturers are responsible for designing their products to last during that entire period. Specifying a shorter period would artificially and arbitrarily reduce the information available to reach a conclusion. If defects don't occur after five years, then there is no additional burden associated with the longer period. EPA does not take a position on the manufacturers' practices regarding extended warranties; however, we feel strongly that a manufacturer's confidence as expressed in an extended warranty should correspond with the same level of confidence in the engines (or components) working to control emissions for that same period.

EPA proposed to also apply the recall provisions from 40 CFR part 1068 for highway motorcycles and for all vehicles subject to standards under 40 CFR part 86, subpart S, and requested comment on applying the defect reporting from 40 CFR part 1068 for those same vehicles. Manufacturers objected to modifying the recall and defect-reporting provisions in this rulemaking. EPA is accordingly not finalizing these additional provisions; EPA intends rather to pursue these changes in a later rulemaking, which will allow both EPA and manufacturers and other stakeholders additional time to carefully consider the range of issues that may be involved. In particular, EPA anticipates the opportunity to apply some learning from the current focus on defeat devices, recall, and defect reporting in the effort to update the regulations.

Note that EPA is amending 40 CFR 85.1701 to specify that the exemption provisions apply to heavy-duty engines subject to regulation under 40 CFR part 86, subpart A. This is intended to limit the scope of this provision so that it does not apply for Class 2b and 3 heavy-duty vehicles subject to standards under 40 CFR part 86, subpart S. This change corrects an inadvertently broad reference to heavy-duty vehicles in 40 CFR 85.1701.

#### *D. Amendments to General Compliance Provisions in 40 CFR Part 1068*

The general compliance provisions in 40 CFR part 1068 apply broadly to many different types of engines and equipment. This section describes how

EPA is amending these procedures to make various corrections and adjustments.

#### (1) Hearing Procedures

EPA is updating and consolidating its regulations related to formal and informal hearings in 40 CFR part 1068, subpart G. This will allow us to rely on a single set of regulations for all the different categories of vehicles, engines, and equipment that are subject to emission standards. EPA also made an effort to write these regulations for improved readability.

The hearing procedures specified in 40 CFR part 1068 apply to the various categories of nonroad engines and equipment (along with the other provisions of part 1068). EPA is in these rules applying these hearing procedures also to heavy-duty highway engines, light-duty motor vehicles, and highway motorcycles. EPA believes there is no reason to treat any of these sectors differently regarding hearing procedures. Automotive and engine manufacturers expressed broad concerns about migrating the hearing procedures in this rulemaking; however, the migration makes no substantive changes to established procedures, and addresses various administrative concerns as noted below.

EPA is adding an introductory section that provides an overview of requesting a hearing for all cases where a person or a company objects to an adverse decision by the agency. In certain circumstances, as spelled out in the regulations, a person or a company can request a hearing before a Presiding Officer. Statutory provisions require formal hearing procedures for administrative enforcement actions seeking civil penalties. The Clean Air Act does not require a formal hearing for other agency decisions; EPA is therefore specifying that informal hearing procedures apply for all such decisions.

The introductory section also adds detailed provisions describing the requirements for submitting information to the agency in a timely manner. These provisions accommodate current practices for electronic submission, distinguish between postal and courier delivery and provide separate requirements for shipments made from inside and outside the United States. The specified deadlines are generally based on the traditional approach of a postmark determining whether a submission is timely or not. Fax, email and courier shipments are similarly specified as needing to be sent by close of business on the day of the deadline. A different approach applies for shipments originating from outside the

United States. Because time in transit can vary dramatically, we are specifying that foreign shipments need to be received in our office by the specified deadline to be considered timely. Given the option to send documents by email or by fax, EPA expects this approach will not pose any disadvantage to anyone making an appeal from outside the United States.

EPA is replacing the current reference to 40 CFR 86.1853-01 for informal hearings with a full-text approach that captures this same material. EPA attempted to write these regulations in a way that does not change the underlying hearing protocol.

The regulations currently reference the formal hearing procedures in 40 CFR 85.1807, which were originally drafted to apply to light-duty motor vehicles. After we adopted the hearing procedures in 40 CFR 85.1807, EPA's Office of Administrative Law Judges finalized a set of regulations defining formal hearing procedures that were intended to apply broadly across the agency for appeals under every applicable statute. See 40 CFR part 22, "Consolidated Rules of Practice Governing the Administrative Assessment of Civil Penalties and the Revocation/Termination or Suspension of Permits." EPA is therefore revising the regulations in 40 CFR part 1068 to simply refer to these formal hearing procedures in 40 CFR part 22.

## (2) Additional Changes to General Compliance Provisions

EPA is also making numerous changes across 40 CFR part 1068 to correct errors, to add clarification, and to make adjustments based on lessons learned from implementing these regulatory provisions. This includes the following changes:

- § 1068.1: Clarify applicability of part 1068 with respect to legacy parts (such as 40 CFR parts 89 through 94).
- § 1068.20: Clarify that EPA's inspection activities do not depend on having a warrant or a court order. As noted in the standard-setting parts, EPA may deny certification or suspend or revoke certificates if a manufacturer denies EPA entry for an attempted inspection or other entry.
- § 1068.27: Clarify that EPA confirmatory testing may be performed before issuance of a certificate of conformity. We are also making an addition to state that we may require manufacturers to give us any special components that are needed for EPA testing.
- § 1068.30: Add definitions of "affiliated companies," "parent company," and "subsidiaries" to clarify

how small-business provisions apply for a range of business relationships.

- § 1068.30: Clarify that in the context of provisions that apply only for certificate holders, a manufacturer can be considered a certificate holder based on the current or previous model year (to avoid problems from having a gap between model years).

- § 1068.30: Spell out contact information for the "Designated Compliance Officer" to clarify how manufacturers should submit information to the agency. This includes email addresses for the various sectors.

- § 1068.32: Add discussion to establish the meaning of various terms and phrases for EPA regulations; for example, we distinguish between standards, requirements, allowances, prohibitions, and provisions. EPA is also clarifying terminology with respect to singular/plural, inclusive lists, notes and examples in the regulatory text, and references to "general" or "typical" circumstances. EPA also describes some of the approach to determining when "unusual circumstances" apply.

- § 1068.45: Allow manufacturers to use coded dates on engine labels; allow EPA to require the manufacturer to share information to read the coded information.

- § 1068.45: Clarify that engine labels are information submissions to EPA.

- §§ 1068.101 and 1068.125: Update penalty amounts to reflect changes to 40 CFR part 19 (81 FR 43094, July 1, 2016).

- § 1068.101: Revise the penalty associated with the tampering prohibition to be an engine-based penalty, as opposed to assessing penalties per day of engine operation. This correction aligns with Clean Air Act section 205.

- § 1068.103: Clarify the process for reinstating certificates after suspending, revoking, or voiding.

- § 1068.103: Clarify that the prohibition against "offering for sale" uncertified engines applies only for engines already produced. It is not a violation to invite customers to buy engines as part of an effort to establish the economic viability of producing engines, as would be expected for market research.

- § 1068.105: Require documentation related to "normal inventory" for stockpiling provision. EPA is also clarifying that there is no specific deadline associated with producing "normal-inventory" engines under this section, but emphasizing that vehicle/equipment manufacturers may not delay engine installation beyond their normal production schedules. EPA is also clarifying that the allowance related to building vehicles/equipment in the

early part of a model year, before the start of a new calendar year corresponding to new emission standards, applies only in cases where vehicle/equipment assembly is complete before the start of the new calendar year. This is intended to prevent manufacturers from circumventing new standards by initiating production of large numbers of vehicles/equipment for eventual completion after new standards have started to apply.

- § 1068.210: Remove the requirement for companies getting approval for a testing exemption to send us written confirmation that they meet the terms and conditions of the exemption. We do not believe this submission is necessary for implementing the testing exemption.

- § 1068.220: Add a description of how we might approve engine operation under the display exemption. This is intended to more carefully address circumstances in which engine operation is part of the display function in question. We will want to consider a wide range of factors in considering such a request; for example, we may be more inclined to approve a request for a display exemption if the extent of operation is very limited, or if the engine/equipment has emission rates that are comparable to what would apply absent the exemption. EPA is also removing the specific prohibition against generating revenue with exempted engines/equipment, since this has an unclear meaning and we can take any possible revenue generation into account in considering whether to approve the exemption on its merits.

- § 1068.230: Add a provision allowing for engine operation under the export exemption only as needed to prepare it for export (this has already been in place in part 85, and in part 1068 for engines/equipment imported for eventual export).

- § 1068.235: Clarify that the standard-setting part may set conditions on an exemption for nonroad competition engines/equipment.

- § 1068.240: Clarify that manufacturers may export engines as an alternative to being destroyed if the engine was replaced with an engine covered by the exemption provisions of § 1068.240(b).

- § 1068.240: Describe the logistics for identifying the disposition of engines being replaced under the replacement engine exemption. In particular, manufacturers will need to resolve the disposition of each engine by the due date for the report under § 1068.240(c) to avoid counting them toward the production limit for

untracked replacement engines. We are delaying the due date for the report until September 30 following the production year to allow more time for manufacturers to make these determinations.

- § 1068.240: Clarify the relationship between paragraphs (d) and (e).
- § 1068.250: Simplify the deadline for requesting small-volume hardship.
- § 1068.255: Clarify that hardship provisions for equipment manufacturers are not limited to small businesses, and that a hardship approval is generally limited to a single instance of producing exempt equipment for up to 12 months.
- § 1068.260: State that manufacturers shipping engines without certain emission-related components need to identify the unshipped components either with a performance specification (where applicable) or with specific part numbers. We are also listing exhaust piping before and after aftertreatment devices as not being emission-related components for purposes of shipping engines in a certified configuration.
- §§ 1068.260 and 1068.262: Revise the text to clarify that provisions related to partially complete engines have limited applicability in the case of equipment subject to equipment-based exhaust emission standards (such as recreational vehicles). These provisions are not intended to prevent the sale of partially complete equipment with respect to evaporative emission standards. We intend to address this in the future by changing the regulation in 40 CFR part 1060 to address this more carefully.
- § 1068.262: Revise text to align with the terminology and description adopted for similar circumstances related to shipment of incomplete heavy-duty vehicles under 40 CFR part 1037.
- § 1068.301: Revise text to more broadly describe importers' responsibility to submit information and store records and explicitly allow electronic submission of EPA declaration forms and other importation documents.
- § 1068.305: Remove the provision specifying that individuals may need to submit taxpayer identification numbers as part of a request for an exemption or exclusion for imported engines/equipment. We do not believe this information is necessary for implementing the exemption and exclusion provisions.
- § 1068.315: Allow for destroying engines/equipment instead of exporting them under the exemption for importing engines/equipment for repairs or alterations.

- § 1068.315: Remove the time constraints on approving extensions to a display exemption for imported engines/equipment. EPA will continue to expect the default time frame of one year to be appropriate, and extension of one to three years is sufficient for most cases; however, we are aware that there are occasional circumstances calling for a longer-term exemption. For example, an engine on display in a museum might appropriately be exempted indefinitely once its place in a standing exhibition is well established.

- § 1068.315: Specify that engines under the ancient engine exemption must be *substantially* in the original configuration.
- § 1068.360: Clarify the provisions related to model year for imported products by removing a circularity regarding "new" engines and "new" equipment.
- § 1068.401: Add explicit statement that SEA testing is at manufacturer's expense. This is consistent with current practice and the rest of the regulatory text.
- § 1068.401: Allow for requiring manufacturers other than the certificate holder to perform selective enforcement audits in cases where multiple manufacturers are cooperatively producing certified engines.
- § 1068.401: State that SEA non-cooperation may lead to suspended or revoked certificate (like production-line testing).
- § 1068.415: Set up new criteria for lower SEA testing rate based on engine power to allow for a reduced testing rate of one engine per day only for engines with maximum engine power above 560 kW, but keep the allowance to approve a lower testing rate; that may be needed, for example, if engine break-in (stabilization) and testing are performed on the same dynamometer. EPA believes it is more appropriate to base reduced testing rates on engine characteristics rather than sales volumes, as has been done in the past.
- § 1068.415: Revise the service accumulation requirement to specify a maximum of eight days for stabilizing a test engine. This is necessary to address a situation where an engine operates only six hours per day to achieve stabilization after well over 50 hours. For such cases, we would expect manufacturers to be able to run engines much more than six hours per day. As with testing rates, manufacturers may ask for our approval to use a longer stabilization period if circumstances don't allow them to meet the specified service accumulation targets.
- § 1068.501, and Appendix I: Clarify that "emission-related components"

include components whose failure *would commonly* increase emissions (not might increase), and whose *primary* purpose is to reduce emissions (not sole purpose); current regulations are not consistent.

- § 1068.501: Add "in-use testing" to list of things to consider for investigating potential defects.
  - § 1068.505: Clarify that manufacturers subject to a mandatory recall must remedy vehicles with an identified nonconformity without regard to their age or mileage at the time of repair, consistent with provisions that already apply under 40 CFR part 85.
  - § 1068.505: Revise the requirement for submitting a remedial report from a 60-day maximum to a 45-day minimum (or 30-day minimum in the event of a hearing). This adjusted approach already applies to motor vehicles under 40 CFR part 85.
  - § 1068.515: Clarify an ambiguity to require that manufacturers identify the facility where repairs or inspections are performed, and allow manufacturers to keep records of those facilities rather than including the information on the recall label.
  - § 1068.530: Specify that recall records must be kept for five years, rather than three years. This is consistent with longstanding recall policy for motor vehicles and motor vehicle engines under 40 CFR part 85.
- In addition, EPA received a comment from Navy on behalf of the Defense Department requesting that we add a provision to allow for an automatic national security exemption in cases where a federal defense agency owns an engine that would need sulfur-sensitive technology to comply with emission standards if it is intended to be used in areas outside the United States where ultra-low sulfur fuel is unavailable. We are adopting this change as part of the final rule. This will reduce the agencies' burden to process what has become a routine process for requesting and approving these exemptions. We are also taking the opportunity to include marine diesel engines in this same section, rather than treating them separately under 40 CFR 1042.635.
- We proposed to revise § 1068.201 to describe how someone may sell an engine under a different exemption than was originally intended or used as a result of unforeseen circumstances. However, we have decided to postpone those regulatory amendments to a future rule. This will give us opportunity to more thoroughly explore all relevant factors, such as:
- Statutory authority and requirements.

- Business interests for managing distribution and inventories of exempted engines.
- Environmental impacts.

#### *E. Amendments to Light-Duty Greenhouse Gas Program Requirements*

EPA is making minor changes to correct errors and clarify regulations in 40 CFR part 86, subpart S, and 40 CFR part 600 relating to EPA's light-duty fuel economy and greenhouse gas emission standards. This includes the following changes:

- § 86.1818–12: Correct a reference in paragraph (c)(4) and clarify that CO<sub>2</sub>-equivalent debits for N<sub>2</sub>O and CH<sub>4</sub> are calculated in Megagrams and rounded to the nearest whole Megagram.
- § 86.1838–01: Correct references in paragraph (d)(3)(iii).
- § 86.1866–12: Correct a reference in paragraph (b).
- § 86.1868–12: Clarify language in the introductory paragraph explaining the model years of applicability of different provisions for air conditioning efficiency credits. In paragraph (e)(5) clarify that the engine-off specification of 2 minutes is intended to be cumulative time. In paragraphs (f)(1), (g)(1), and (g)(3), clarify language by pointing to the definitions in § 86.1803–01.
- § 86.1869–12: Make corrections to the language for readability in paragraph (b)(2). In paragraph (b)(4)(ii) delete the phrase “backup/reverse lights” because these lights were not intended to be part of the stated eligibility criteria for high-efficiency lighting credits. Correct references in paragraph (f).
- § 86.1870–12: Add language that clarifies that a manufacturer that meets the minimum production volume thresholds with a combination of mild and strong hybrid electric pickup trucks is eligible for credits.
- § 86.1871–12: Clarify that credits from model years 2010–2015 are not limited to a life of 5 model years. A recent rule extended the life of 2010–2015 credits to model year 2021; thus, language referring to a 5-year life for emission credits generated in these model years is being removed or revised.
- § 600.113–12: Correct language in paragraph (m)(1), which relates to vehicles operating on LPG, that erroneously refers to methanol and methanol-fueled.
- § 600.113–12: Correct references in paragraph (n) and add a new paragraph (m) that reinstates language mistakenly dropped by a previous regulation.
- § 600.116–12: Correct description of physical quantity to refer to “energy”

rather than “current,” and correct various paragraph references.

- § 600.208–12: Correct a reference in paragraph (a)(2)(iii).
- § 600.210–12: Correct a reference and text in paragraph (c)(2)(iv)(C).
- § 600.311–12: Revise fuel economy label instructions to (1) identify label ratings for model year 2017 and earlier standards certified early to the Tier 3 standards, (2) identify label ratings for Interim Tier 3 vehicles certified to interim bins for model years 2018 through 2024, and (3) clarify that the specified California emission standards determine label ratings only if vehicles are not subject to any EPA standards. All these changes are consistent with current implementation through guidance.
- § 600.510–12: Correct a reference in the equation in paragraph (c)(1)(ii) to apply the air conditioning, off-cycle, and pickup truck credits to the appropriate fleet average MPG value. Revise the regulation to accelerate the transition to fuel economy calculations using utility factors for natural gas vehicles, consistent with the methodology that applies for plug-in hybrid vehicles. This amendment was adopted by Congress as part of Fixing America's Surface Transportation Act, H.R. 22, 114th Cong. § 24341 (2015).

#### *F. Amendments to Highway and Nonroad Test Procedures and Certification Requirements*

##### (1) Testing With Aftertreatment Devices Involving Infrequent Regeneration

Manufacturers generally rely on selective catalytic reaction and diesel particulate filters to meet EPA's emission standards for highway and nonroad compression-ignition engines. These emission control devices typically involve infrequent regeneration, which can have a significant effect on emission rates. EPA has addressed that for each engine type by provisions for infrequent regeneration factors; this is a calculation methodology that allows manufacturers to incorporate the effect of infrequent regeneration into reported emission values whether or not that regeneration occurs during an emission test. EPA adopted separate provisions for highway, locomotive, marine, and land-based nonroad compression-ignition engines. As proposed, EPA is harmonizing the common elements of these procedures in 40 CFR part 1065, and adding clarifying specifications in each of the standard-setting parts for sector-specific provisions. Commenters generally supported this revision. See

Section II for a discussion of how IRAFs will apply for GHGs in Phase 2.

##### (2) Mapping for Constant-Speed Engines Under 40 CFR Part 1065

EPA is revising 40 CFR 1065.510 as it applies to the two-point mapping method for certain constant-speed engines. The regulations previously cited a performance parameter in ISO 8528–5 that does not apply for the design of these engines.

It is common practice for engines that produce electric power to use an isochronous governor for stand-alone generator sets. In some parallel operations of multiple generator sets, droop is added as a method for load sharing. The amount of droop can be tuned by the generator set manufacturer or the site system integrator. Such engines are commonly tested on an engine dynamometer with the isochronous governor.

Mapping with just two points works well for the case of 0 percent droop (*i.e.*, isochronous governor). For this case, a persistent speed error is forced on the engine governor on the second point and this will cause the governor to wind up to its maximum command. The second point is effectively operating on the torque curve instead of the isochronous governor. So, the second point captures the full fueling torque (plus a small amount due to any rising torque curve). This measured torque is used as the maximum test torque for computing the emission test points. Since there is no designed-in droop, some target amount of speed error is needed for the second point. The regulation at 40 CFR 1065.510(d)(5)(iii) has a default target speed on the second point of 97.5 percent of the no-load speed measured on the first point. This results in a persistent speed error of 2.5 percent of the no-load speed. For an 1800 rpm no-load speed, this gives a target speed of 1755 rpm and a 45 rpm speed error on an isochronous governor. If the engine has a torque rise of 20 percent from 1800 to 1200 rpm (0.0333 percent torque rise per rpm), this 45 rpm error will cause a 1.5 percent-of-point error in the determination of the intended maximum test torque. This error is larger than desired for this type of testing. Fortunately, engines and test cells have sufficient speed resolution to select a lower speed error, which reduces this error in maximum test torque. In practice, testing with a speed error at or below 0.5 percent is more than adequate to cause the isochronous governor to wind up to maximum fueling. Using a target speed of 99.5 percent on the second point gives a target speed of 1791 rpm for an 1800

rpm no-load speed and reduces the error on the maximum test torque to a reasonable 0.3 percent of point for the 20 percent torque rise case described above.

For governors with droop, if we attempt the two-point method, we would have to calculate a target speed for the second point based on a designed amount of droop. Unfortunately, the actual governor may not have the same amount of droop as the design droop, which may cause error in the measured torque versus the maximum test torque associated with a complete torque map. Also, the design droop may be based on a torque value that is different from the intended maximum test torque. Thus, the two-point method is not sufficient to yield a maximum test torque equivalent to the value obtained using a multi-point map. Also the allowed speed error on the second point is 20 percent of the speed droop, which allows an unacceptably large error in the maximum test torque.

Thus, for the reasons listed, we are limiting the two-point mapping method to any isochronous governed engines, not just engines used to generate electric power.

#### (3) Calculating Maximum and Intermediate Test Speeds Under 40 CFR Part 1065

EPA is improving the method for calculating maximum and intermediate test speeds by applying a more robust calculation method. The new calculation method is consistent with the methodology used to determine maximum test torque, which we revised in the light-duty Tier 3 rulemaking. Under the previous regulations, the result was a measured maximum test torque at one of the map points. The new calculation method involves interpolation to determine the measured maximum test torque, yielding a more representative maximum value for test torque.

#### (4) Excluding Ethane From Measure Emissions for Gaseous-Fueled Compression-Ignition Engines

EPA proposed to allow manufacturers to use NMOG measurements to demonstrate compliance with NMHC standards. This was primarily intended to address concerns about ethane emissions from natural gas engines inappropriately impacting compliance determinations when the engines are tested using fuels that have relatively high ethane content. Commenters shared that the proposed approach would not accomplish the intended purpose. Some commenters also emphasized that ethane is a

hydrocarbon and an organic compound that has a low ozone reactivity (*i.e.*, ethane emissions do little to contribute to ozone), and that ethane emissions are hard to remove with a catalytic converter. We are finalizing a more direct approach in which engines designed to operate on gaseous fuels are subject to hydrocarbon standards in the form of nonmethane-nonethane hydrocarbons. This approach applies for all the different sectors of mobile compression-ignition engines—heavy-duty highway, land-based nonroad, marine, and locomotive. Excluding ethane from hydrocarbon measurements requires additional test specifications as noted in the following section.

We are adopting an alternative provision that involves reduced test burden by selecting a low-ethane test fuel. In particular, EPA or manufacturers performing measurements with a test fuel containing 1.0 percent ethane or less may measure an engine's NMHC emissions and multiple this value by 0.95 to determine its nonmethane-nonethane hydrocarbon emissions, without separately measuring ethane in the exhaust.

#### (5) Additional Test Procedure Amendments

EPA is adopting the following additional changes to test procedures in 40 CFR part 1065 and part 1066:

- § 1065.202: Revised to prevent specific data collection errors known as aliasing. More specifically, the revision will ensure that aliasing of data collection signal due to filtering or sampling rate does not happen. We believe that all labs are currently preventing aliasing, but this should be described in the regulations.
- § 1065.266: This new section allows the use of an FTIR for determination of NMHC or NMNEHC from engines fueled solely on LPG or natural gas. The measurement of methane and ethane is also allowed for engine fueled with LPG or natural gas, in combination with a liquid fuel, for determination of NMHC or NMNEHC when subtracting methane and/or ethane from a FID-derived THC value. The intent of the NMNEHC provision is to allow the subtraction of ethane from THC in cases where the certification fuel available to the testing lab is high in ethane content.
- § 1065.275: ASTM D6348 was added as a reference method for interpretation of spectra for N<sub>2</sub>O determination by FTIR.
- § 1065.340 and 1065.341: These sections contain a collection of editorial corrections pertaining to CVSs intended

to improve the understanding of the calibration and verification procedures.

- § 1065.366: This new section provides interference verification procedures for FTIR hydrocarbon analyzers allowed under § 1065.266.
- § 1065.640 and 1065.642: These sections contain a collection of editorial corrections pertaining to CVSs intended to improve the understanding of the calculation procedures.
- § 1065.655: Revised to separate out carbon mass fraction of fuel and fuel composition determinations into separate sections to improve readability. This section was also revised to include any fluids injected into the exhaust in the determination of the carbon mass fraction of fuel. This ensures that all fluids in the exhaust are accounted for. Provisions were also added to address how to determine properties when multiple fuel streams (*e.g.*, gaseous and liquid) are used.
- § 1065.1001: Added a definition for diesel exhaust fluid.
- § 1066.110: Revised to allow a shortening of the tailpipe for connection to the CVS and to simultaneously conduct PM background sampling with propane recovery checks. This section was also revised to change the limit on filter face velocity from 100 cm/s to 140 cm/s. The purpose of this is to increase filter mass loading. This change is based on results obtained from the CRC E-99 Phase 1 test program, which showed that there was no loss of semi-volatile PM at this higher filter face velocity. Higher filter mass loadings will help to reduce uncertainty and lessen the impact of background variability on the final PM emission value.
- § 1066.210: Revise the dynamometer force equation to incorporate grade, consistent with the coastdown procedures we are adopting for heavy-duty vehicles. For operation at a level grade, the additional parameters cancel out of the calculation.
- § 1066.605: Adding an equation to the regulations to spell out how to calculate emission rates in grams per mile. This calculation is generally assumed, but we want to include the equation to remove any uncertainty about calculating emission rates from mass emission measurements and driving distance. We also added equations to vary sample extraction ratio instead of changing flow over the filter when performing single filter per test sampling for PM measurement.
- § 1066.815: Create an exception to the maximum value for overall residence time for PM sampling methods that involve collecting samples for combined bags over a duty cycle. This is needed to accommodate the

reduced sample flow rates associated with these procedures. We also added provisions to vary sample extraction ratio instead of changing flow over the filter when performing single filter per test sampling for PM measurement.

#### *G. Amendments Related to Locomotives in 40 CFR Part 1033*

EPA's emission standards and certification requirements for locomotives and locomotive engines under the Clean Air Act are identified in 40 CFR part 1033.

EPA is revising the engine mapping provisions in 40 CFR part 1033 for locomotive testing to denote that manufacturers do not have to meet the cycle limit values in 40 CFR 1065.514 when testing complete locomotives. Also, for engine testing with a dynamometer, while the validation criteria of CFR 1065.514 apply, EPA is allowing manufacturers the option to check validation using manufacturer-declared values for maximum torque, power, and speed. This option will allow them to omit engine mapping under 40 CFR 1065.510, which is already not required. These provisions reduce test burden and cost for the manufacturer, while preserving the integrity of the certification requirements.

EPA is also adopting text that describes the alternate ramped-model cycle provisions in 40 CFR part 1033 as some of the notch setting and durations are inconsistent with the description of the duty cycle in Table 1 of 40 CFR 1033.520. EPA has determined that the table is correct as published and the error lies in the text describing how to carry out the ramped-modal test.

We are also clarifying that locomotives operating on a combination of diesel fuel and gaseous fuel are subject to NMHC standards (or NMNEHC standards), which is the same as if the locomotives operated only on gaseous fuel. With respect to in-use fuels, we are adopting a clarification in 40 CFR 1033.815 regarding allowable fuels for certain Tier 4 and later locomotives. Specifically, we note that locomotives certified on ultra-low sulfur diesel fuel, but that do not include sulfur-sensitive emission controls, may use low sulfur diesel fuel instead of ultra-low sulfur diesel fuel, consistent with good engineering judgment. For example, an obvious case where this would be appropriate (but not the only possible case), is if a railroad had emission data showing the locomotive still met the applicable standards/FELs while operating on the higher sulfur fuel.

We also requested comment on whether EPA should consider notch-specific engine/alternator efficiencies to be confidential business information. However commenters did not support making this change in the regulations.

We requested comment on extending the provisions of 40 CFR 1033.101(i) involving a less stringent CO standard in combination with a more stringent PM standard to Tier 4 locomotives. The existing provisions were developed to provide a compliance path for natural gas locomotives that reflected both the technological capabilities of natural gas locomotives and the relative environmental significance of CO and PM emissions. This provision was not applied to Tier 4 locomotives, because the applicable Tier 4 p.m. standard is already very low (0.03 g/hp-hr). Engine manufacturers commented in favor of adopting alternate standards for Tier 3 and Tier 4 locomotives. We are extending the alternate 10.0 g/bhp-hr CO standard to Tier 3 and Tier 4 locomotives; manufacturers would qualify for the less stringent CO standard by meeting a PM standard of 0.01 g/bhp-hr.

EPA is making numerous additional changes across 40 CFR part 1033 to correct errors, to add clarification, and to make adjustments based on lessons learned from implementing these regulatory provisions. This includes the following changes:

- §§ 1033.30, 1033.730, and 1033.925: Consolidate information-collection provisions into a single section.
- § 1033.101: Allow manufacturers to certify Tier 4 and later locomotives using Low Sulfur Diesel fuel instead of Ultra-Low Sulfur Diesel fuel. Manufacturers may wish to do this to show that their locomotives do not include sulfur-sensitive technology.
- § 1033.120: Reduce extended-warranty requirements to warranties that are actually provided to customers, rather than to any published warranties that are offered. The principle is that the emission-related warranty should not be less effective for emission-related items than for items that are not emission-related.
- § 1033.150: Correct the URL associated with price index information for calculating current costs.
- § 1033.201: Clarify that manufacturers may amend their application for certification after the end of the model year in certain circumstances, but they may not produce locomotives for a given model year after December 31 of the named year.
- § 1033.201: Establish that manufacturers may deliver to EPA for

testing a locomotive/engine that is identical to the test locomotive/engine used for certification. This may be necessary if the test locomotive/engine has accumulated too many hours, or if it is unavailable for any reason.

- § 1033.235: Add an explicit allowance for carryover engine families to include the same kind of within-family running changes that are currently allowed over the course of a model year. The original text may have been understood to require that such running changes be made separate from certifying the engine family for the new model year.

- §§ 1033.235, 1033.245, and 1033.601: Describe how to demonstrate compliance with dual-fuel and flexible-fuel locomotives. This generally involves testing with each separate fuel, or with a worst-case fuel blend.

- § 1033.245: Add instructions for calculating deterioration factors for sawtooth deterioration patterns, such as might be expected for periodic maintenance, such as cleaning or replacing diesel particulate filters.

- § 1033.250: Remove references to routine and standard tests, and remove the shorter recordkeeping requirement for routine data (or data from routine tests). All test records must be kept for eight years. With electronic recording of test data, there should be no advantage to keeping the shorter recordkeeping requirement for a subset of test data. EPA also notes that the eight-year period restarts with certification for a new model year if the manufacturer uses carryover data.

- § 1033.255: Clarify that rendering information false or incomplete after submitting it is the same as submitting false or incomplete information. For example, if there is a change to any corporate information or engine parameters described in the manufacturer's application for certification, the manufacturer must amend the application to include the new information.

- § 1033.255: Clarify that voiding certificates for a recordkeeping or reporting violation would be limited to certificates that relate to the particular recordkeeping or reporting failure.

- § 1033.501: Clarify how testing requirements apply differently for locomotive engines and for complete locomotives.

- § 1033.501: Add paragraph (a)(4) to remove proportionality verification for discrete-mode tests if a single batch fuel measurement is used to determine raw exhaust flow rate. This verification involves statistical assessment that is not valid for the single data point. Requiring manufacturers instead to



simply ensure constant sample flow should adequately address the concern,

- § 1033.515: Provide the option to carry out smoke testing separate from criteria pollutant measurement with a reduced time-in-notch of 3 minutes. This change reestablishes a provision that was previously allowed in 40 CFR 92.124(f).
- §§ 1033.515 and 1033.520: Update terminology by referring to “test intervals” instead of “phases.” This allows us to be consistent with terminology used in 40 CFR part 1065.
- § 1033.520: Correct the example given to describe the testing transition after the second test interval.
- §§ 1033.701 and 1033.730: Describe the process for retiring emission credits. This may be referred to as donating credits to the environment.
- § 1033.710: Clarify that it is not permissible to show a proper balance of credits for a given model by using emission credits from a future model year.
- § 1033.730: Clarify terminology for ABT reports.
- § 1033.815: Add consideration of periodic locomotive inspections in 184-day intervals.
- § 1033.901: Update the contact information for the Designated Compliance Officer.
- § 1033.915: Migrate provisions related to confidential information to 40 CFR part 1068.

We proposed to disallow amending certified configurations after the end of the model year. However, manufacturers shared in their comments that this would change the field-fix policy that has long since allowed for making such changes. We have retracted the proposed change and replaced it with a new paragraph that describes how manufacturers may amend the application for certification during and after the model year, consistent with the current policy regarding field fixes.

#### *H. Amendments Related to Nonroad Diesel Engines in 40 CFR Part 1039*

EPA is adopting two changes to 40 CFR 1039.5 to clarify the scope and applicability of standards under 40 CFR part 1039. First, EPA is stating that engines using the provisions of 40 CFR 1033.625 for non-locomotive-specific engines remain subject to certification requirements as nonroad diesel engines under 40 CFR part 1039. Such engines will need to be certified as both locomotive engines and as nonroad diesel engines. Second, EPA is revising the statement about how manufacturers may certify under 40 CFR part 1051 for engines installed in recreational vehicles (such as all-terrain vehicles or

snowmobiles). EPA is removing text that might be interpreted to mean that there are circumstances in which certification under neither part is required. The proper understanding of EPA’s policy in that regard is that certification under one part is a necessary condition for being exempted from the other part.

In 2008, EPA adopted a requirement in 40 CFR part 1042 for manufacturers to design marine diesel engines using selective catalytic reduction with basic diagnostic functions to ensure that these systems were working as intended (73 FR 37096, June 30, 2008). EPA is applying those same diagnostic control requirements to nonroad diesel engines regulated under 40 CFR part 1039. This addresses the same fundamental concern that engines will not be controlling emissions consistent with the certified configuration if the engine is lacking the appropriate quantity and quality of reductant. While some lead time is needed to make the necessary modifications, we believe it will be straightforward to apply the same designs from marine diesel engines to land-based nonroad diesel engines. EPA is accordingly requiring that manufacturers meet the new diagnostic specifications starting with model year 2018. These diagnostic controls will not affect the current policy related to adjustable parameters and inducements related to selective catalytic reduction.

EPA is making numerous changes across 40 CFR part 1039 to correct errors, to add clarification, and to make adjustments based on lessons learned from implementing these regulatory provisions. This includes the following changes:

- § 1039.2: Add a clarifying note to say that something other than a conventional “manufacturer” may need to certify engines that become new after being placed into service (such as engines converted from highway or stationary use). This is intended to address a possible assumption that only conventional manufacturers can certify engines.
- §§ 1039.30, 1039.730, and 1039.825: Consolidate information-collection provisions into a single section.
- § 1039.107: Remove the reference to deterioration factors for evaporative emissions, since there are no deterioration factors for demonstrating compliance with evaporative emission standards.
- § 1039.104(g): Correct the specified FEL cap for an example scenario illustrating how alternate FEL caps work.
- § 1039.120: Reduce extended-warranty requirements to warranties that are actually provided to the

consumer, rather than to any published warranties that are offered. The principle is that the emission-related warranty should not be less effective for emission-related items than for items that are not emission-related.

- § 1039.125: Add crankcase vent filters to the list of maintenance items.
- § 1039.125: Allow for special maintenance procedures that address low-use engines. For example, owners of recreational marine vessels may need to perform engine maintenance after a smaller number of hours than would otherwise apply based on the limited engine operation over time.
- § 1039.125: Establish a minimum maintenance interval of 1500 hours for DEF filters. This reflects the technical capabilities for filter durability and the expected maintenance in the field.
- § 1039.125: Add fuel-water separator cartridges as an example of a maintenance item that is not emission-related.
- § 1039.125: Add a clearer cross reference to clarify that particulate traps are subject to the same maintenance intervals that apply for catalysts, consistent with the originally adopted maintenance provisions for the Tier 4 standards.
- § 1039.135: Allow for including optional label content only if this does not cause the manufacturer to omit other information based on limited availability of space on the label, and identify counterfeit protection as an additional item that manufacturers may include on the label. We modified the proposed amendment in response to comments to allow for including optional labeling content as long as the additional content doesn’t cause the space limitations that prevent inclusion of other optional information.
- § 1039.201: Clarify that manufacturers may amend their application for certification after the end of the model year in certain circumstances, but they may not produce engines for a given model year after December 31 of the named year.
- § 1039.201: Establish that manufacturers may deliver to EPA for testing an engine that is identical to the test engine used for certification. This may be necessary if the test engine has accumulated too many hours, or if it is unavailable for any reason.
- § 1039.205: Replace the requirement to submit data from invalid tests with a requirement to simply notify EPA in the application for certification if test was invalidated.
- § 1039.205: Add a requirement for manufacturers to include in their application for certification a description of their practice for



importing engines, if applicable. Note that where a manufacturer's engines are imported through a wide variety of means, EPA will not require this description to be comprehensive. In such cases, a short description of the predominant practices will generally be sufficient. As noted in comments from the Truck and Engine Manufacturers Association, engine manufacturers whose primary method of importing engines is by selling them to foreign-based equipment manufacturers for eventual importation into the United States may simply state that these products may be imported at the discretion of the equipment manufacturer. We are also adding a requirement for manufacturers of engines below 560 kW to name a test lab in the United States for the possibility of us requiring tests under a selective enforcement audit. We have adopted these same requirements in many of our other nonroad programs.

- § 1039.235: Add an explicit allowance for carryover engine families to include the same kind of within-family running changes that are currently allowed over the course of a model year. The original text may have been understood to require that such running changes be made separate from certifying the engine family for the new model year.

- §§ 1039.235, 1039.240, and 1039.601: Describe how to demonstrate compliance with dual-fuel and flexible-fuel engines. This generally involves testing with each separate fuel, or with a worst-case fuel blend.

- § 1039.240: Add instructions for calculating deterioration factors for sawtooth deterioration patterns, such as might be expected for periodic maintenance, such as cleaning or replacing diesel particulate filters.

- § 1039.240: Remove the instruction related to calculating NMHC emissions from measured THC results, since this is addressed in 40 CFR part 1065.

- § 1039.250: Remove references to routine and standard tests, and remove the shorter recordkeeping requirement for routine data (or data from routine tests). All test records must be kept for eight years. With electronic recording of test data, there should be no advantage to keeping the shorter recordkeeping requirement for a subset of test data. EPA also notes that the eight-year period restarts with certification for a new model year if the manufacturer uses carryover data.

- § 1039.255: Clarify that rendering information false or incomplete after submitting it is the same as submitting false or incomplete information. For example, if there is a change to any

corporate information or engine parameters described in the manufacturer's application for certification, the manufacturer must amend the application to include the new information.

- § 1039.255: Clarify that voiding certificates for a recordkeeping or reporting violation will be limited to certificates that relate to the particular recordkeeping or reporting failure.

- § 1039.505: Correct the reference to the ISO C1 duty cycle for engines below 19 kW.

- § 1039.515: Correct the citation to 40 CFR 86.1370.

- §§ 1039.605 and 1039.610: Revise the reporting requirement to require detailed information about the previous year, rather than requiring a detailed projection for the year ahead. The information required in advance will be limited to a notification of plans to use the provisions of these sections.

- § 1039.640: Migrate engine branding to § 1068.45.

- § 1039.701 1039.730: Describe the process for retiring emission credits. This may be referred to as donating credits to the environment.

- § 1039.705: Change terminology for counting engines from "point of first retail sale" to "U.S.-direction production volume." This conforms to the usual approach for calculating emission credits for nonroad engines.

- § 1039.710: Clarify that it is not permissible to show a proper balance of credits for a given model by using emission credits from a future model year.

- § 1039.730: Clarify terminology for ABT reports.

- § 1039.740: Clarify that the averaging-set provisions apply for credits generated by Tier 4 engines, not for credits generated from engines subject to earlier standards that are used with Tier 4 engines.

- § 1039.801: Update the contact information for the Designated Compliance Officer.

- § 1039.801: Revise the definition of "model year" to clarify that the calendar year relates to the time that engines are produced under a certificate of conformity.

- § 1039.815: Migrate provisions related to confidential information to 40 CFR part 1068.

We proposed to disallow amending certified configurations after the end of the model year. However, manufacturers shared in their comments that this would change the field-fix policy that has long since allowed for making such changes. We have retracted the proposed change and replaced it with a new paragraph that describes how

manufacturers may amend the application for certification during and after the model year, consistent with the current policy regarding field fixes.

We requested comment on removing regulatory provisions for Independent Commercial Importers from 40 CFR part 1039. These provisions, copied from highway regulations many years ago, generally allow for small businesses to modify small numbers of uncertified products to be in a certified configuration using alternative demonstration procedures, but they have not been used for nonroad engines for at least the last 15 years. We consider these to be obsolete. Commenters supported removal of these provisions, so we are including this change in the final rule.

#### *I. Amendments Related to Marine Diesel Engines in 40 CFR Parts 1042 and 1043*

EPA's emission standards and certification requirements for marine diesel engines under the Clean Air Act are identified in 40 CFR part 1042.

##### (1) Continuous NO<sub>x</sub> Monitoring and On-Off Controls

Manufacturers may produce certain marine diesel engines with on-off features that disable NO<sub>x</sub> controls when the ship is operating outside of a designated Emission Control Area (ECA) as long as certain conditions are met (§ 1042.115(g)). This provision, which applies to Category 3 engines meeting EPA Tier 3 standards, is intended to address the special operating conditions posed by an ECA and allows a ship that operates in and out of designated ECAs to downgrade engine NO<sub>x</sub> emission controls while the ship is operating outside of a designated ECA. This provision also applies for Tier 4 NO<sub>x</sub> standards for those Category 1 and Category 2 auxiliary engines on Category 3 vessels covered by § 1042.650(d); this provision does not apply to any other auxiliary engines or to any non-Category 3 propulsion engines. Engines with allowable on-off controls must be certified to meet the previous tier of NO<sub>x</sub> standards when the advanced NO<sub>x</sub> control strategies are disabled.

Engines with on-off NO<sub>x</sub> controls are required to be equipped to continuously monitor NO<sub>x</sub> concentrations in the exhaust (§ 1042.110(d)). EPA has been asked to clarify what "continuous" means in the context of this requirement. Because the purpose of this requirement is to show that the engine complies with the NO<sub>x</sub> emission limits on a continuous basis, continuous monitoring must be frequent enough to demonstrate that the NO<sub>x</sub> controls are

on and are properly functioning from the time the ship enters the ECA until it leaves, which, depending on the ECA and the ship's itinerary, could be a matter of hours or days. Since many manufacturers equip their emission control systems with NO<sub>x</sub> sensors to monitor and log the performance of the combined engine and emission control system, we are clarifying that continuous monitoring means measuring NO<sub>x</sub> emissions at least every 60 seconds. EPA is also specifying that a manufacturer may request approval of an alternative measurement period if that is necessary for sufficiently accurate measurements. With regard to the functioning of continuous NO<sub>x</sub> monitoring, the continuous emission measurement device must be included as part of the engine system for EPA certification. Continuous NO<sub>x</sub> monitoring must be engaged before the ship enters an ECA and continue until after it exits the ECA. Verification of operation of the system will be included in required periodic vessel surveys and certification that cover nearly all commercial U.S. vessels. Enforcement is expected to be performed on a periodic basis by appropriate authorities when a ship is in port.

It should be noted that the above provisions with respect to on-off controls and continuous emission monitoring do not apply for the 40 CFR part 1042 PM standards. Engines certified to standards under 40 CFR part 1042 must meet the PM limits at all times, except when the operator has applied for and received permission to disable Tier 4 PM controls while operating outside the United States pursuant to any of the provisions of 40 CFR 1042.650(a) through (c).

#### (2) Category 1 and Category 2 Auxiliary Engines on Category 3 Vessels

The regulation at 40 CFR 1042.650(d) exempts auxiliary Category 1 and Category 2 engines installed on U.S.-flag Category 3 vessels from the part 1042 standards if those auxiliary engines meet certain conditions. This provision is intended to facilitate compliance with MARPOL Annex VI by certain qualified Category 3 vessels engaged in international trade and to simplify compliance demonstrations while those vessels are operating in foreign ports and foreign waters. EPA is adopting two revisions to make clear that the engines on the Category 3 vessel must remain in compliance with Annex VI, and EPA is adding clarifying language relating to engines with a power output of 130 kW or less.

First, EPA is revising the regulations to clarify that the urea reporting

requirements in § 1042.660(b) (which requires an owner or operator of any vessel equipped with SCR to report to EPA within 30 days of any operation of such vessel without the appropriate reductant) also apply to Category 1 and Category 2 auxiliary engines on Category 3 vessels that are covered by § 1042.650(d). This will extend the urea reporting requirements to engines between 130 and 600 kW if they rely on SCR to meet the Annex VI Tier III NO<sub>x</sub> limits. Engines covered by § 1042.650(d) are subject to emission standards and testing requirements under MARPOL Annex VI and the NO<sub>x</sub> Technical Code.

Second, EPA is revising 40 CFR 1042.650(d) to clarify that, while these Category 1 and Category 2 auxiliary engines may be designed with on-off NO<sub>x</sub> controls, Annex VI requires that the engines have an EIAPP certificate demonstrating compliance with the applicable NO<sub>x</sub> standards of Annex VI. This includes certification to demonstrate compliance with IMO Tier II NO<sub>x</sub> standards anytime the IMO Tier III NO<sub>x</sub> configuration is disabled.

EPA has become aware that there is some uncertainty about how the scope of EPA's implementation of Annex VI through 40 CFR part 1043 relates to engines with a power output of 130 kW or less. The existing regulations at § 1043.30 state that an EIAPP certificate is required for engines with a power output above 130 kW, but the standards described in § 1043.60 might be interpreted to apply to engines of all sizes. EPA did not intend to appear to create additional requirements or authority under 40 CFR part 1043 that is not contained in Annex VI or its implementing legislation (the Act to Prevent Pollution from Ships). EPA is therefore adding clarifying language to § 1043.60, consistent with Regulation 13 of Annex VI and APPS, to indicate that the international NO<sub>x</sub> limits do not apply to engines with a power output of 130 kW or less. Note that EPA therefore may not issue EIAPP certificates for engines with a power output of 130 kW or less even if manufacturers request it; this also means that such auxiliary engines are not eligible for an exemption under § 1042.650(d).

#### (3) Natural Gas Marine Engines

EPA is also expanding provisions that apply for marine engines designed to operate on both diesel fuel and natural gas. Test requirements apply separately for each "fuel type." EPA generally considers an engine with a single calibration strategy that combines an initial pilot injection of diesel fuel to burn natural gas to be a single fuel type. This applies even if the natural gas

portion must be substantially reduced or eliminated to maintain proper engine operation at light-load conditions. If the engine has a different calibration allowing it to run only on diesel fuel, or on continuous mixtures of diesel fuel and natural gas, we would consider it to be a dual-fuel engine or a flexible-fuel engine, respectively. These terms are used consistently across EPA programs for highway and nonroad applications. There is an effort underway to revise the definition of "dual-fuel" in MARPOL Annex VI, which may be different than EPA's definition. It should be noted that the 40 CFR part 1042 certification testing requirement differs from that specified in MARPOL Annex VI and the NO<sub>x</sub> Technical Code. While the international protocol involves testing only on the engine calibration with the greatest degree of diesel fuel, EPA certification requires manufacturers to perform testing on each separate fuel type. This would involve one set of tests with natural gas (with or without a diesel pilot fuel, as appropriate), and an additional set of tests with diesel fuel alone. This has been required since we first adopted standards, and this is the same policy that applies across all our emission control programs. EPA is also including amended regulatory language to more carefully describe these testing requirements, and to specify how this applies differently for dual-fuel and flexible-fuel engines.

#### (4) Additional Marine Diesel Amendments

EPA is making numerous changes across 40 CFR part 1042 to correct errors, to add clarification, and to make adjustments based on lessons learned from implementing these regulatory provisions. This includes the following changes:

- § 1042.1: Correct the tabulated applicability date for engines with per-cylinder displacement between 7 and 15 liters; this should refer to engines "at or above" 7 liters, rather than "above 7 liters."
- § 1042.1: Replace an incorrect reference to 40 CFR part 89 with a reference to 40 CFR part 94 for marine engines above 37 kW.
- § 1042.2: Add a clarifying note to say that something other than a conventional "manufacturer" may need to certify engines that become new after being placed into service (such as engines converted from highway or stationary use). This is intended to address a possible assumption that only conventional manufacturers can certify engines.

• §§ 1042.30, 1042.730, and 1042.825: Consolidate information-collection provisions into a single section.

• § 1042.101: Revise the text to more carefully identify engine subcategories and better describe the transition between Tier 3 and Tier 4 standards. These changes are intended to clarify which standards apply and are not intended to change the emission standards for any particular size or type of engine.

• § 1042.101 and Appendix III: More precisely define applicability of specific NTE standards for different types of engines and pollutants; correct formulas defining NTE zones and subzones; and add clarifying information to identify subzone points that could otherwise be derived from existing formulas. None of these changes are intended to change the standards, test procedures, or other policies for implementing the NTE standards.

• § 1042.101: Clarify the FEL caps for certain engines above 3700 kW.

• § 1042.101: Add a specification to define "continuous monitor" for parameters requiring repeated discrete measurements, as described above. The rule also includes further clarification on the relationship between on-off NO<sub>x</sub> controls and engine diagnostic systems.

• § 1042.110: Remove the requirement to notify operators regarding an unsafe operating condition, since we can more generally rely on the broader provision in § 1042.115 that prohibits manufacturers from incorporating design strategies that introduce an unreasonable safety risk during engine operation.

• § 1042.110: Clarify that using a NO<sub>x</sub> sensor as an alternative to monitoring DEF concentration applies only if the system includes an alert to inform operators when DEF quality is inadequate. This makes explicit what we believe should have already been understood from the requirement as originally drafted.

• § 1042.120: Reduce extended-warranty requirements to warranties that are actually provided to the consumer, rather than to any published warranties that are offered. The principle is that the emission-related warranty should not be less effective for emission-related items than for items that are not emission-related.

• § 1042.125: Add crankcase vent filters to the list of maintenance items.

• § 1042.125: Allow for special maintenance procedures that address low-use engines. For example, owners of recreational marine vessels may need to perform engine maintenance after a smaller number of hours than would

otherwise apply based on the limited engine operation over time.

• § 1042.125: Establish a minimum maintenance interval of 1500 hours for DEF filters. This reflects the technical capabilities for filter durability and the expected maintenance in the field.

• § 1042.135: Clarify that ULSD labeling is required only for engines that use sulfur-sensitive technology. If an engine can meet applicable emission standards without depending on the use of ULSD, the manufacturer should not be required to state on the engine that ULSD is required.

• § 1042.135: Allow for including optional label content only if this does not cause the manufacturer to omit other information based on limited availability of space on the label. We modified the proposed amendment in response to comments to allow for including optional labeling content as long as the additional content doesn't cause the space limitations that prevent inclusion of other optional information.

• § 1042.201: Clarify that manufacturers may amend their application for certification after the end of the model year in certain circumstances, but they may not produce engines for a given model year after December 31 of the named year.

• § 1042.201: Establish that manufacturers may deliver to EPA for testing an engine that is identical to the test engine used for certification. This may be necessary if the test engine has accumulated too many hours, or if it is unavailable for any reason.

• §§ 1042.205 and 1042.840: Replace the requirement to submit data from invalid tests with a requirement to simply notify EPA in the application for certification if test was invalidated.

• § 1042.235: Add an explicit allowance for carryover engine families to include the same kind of within-family running changes that are currently allowed over the course of a model year. The original text may have been understood to require that such running changes be made separate from certifying the engine family for the new model year.

• §§ 1042.235, 1042.240, and 1042.601: Describe how to demonstrate compliance with dual-fuel and flexible-fuel engines. This generally involves testing with each separate fuel, or with a worst-case fuel blend.

• § 1042.240: Add instructions for calculating deterioration factors for sawtooth deterioration patterns, such as might be expected for periodic maintenance, such as cleaning or replacing diesel particulate filters.

• § 1042.250: Remove references to routine and standard tests, and remove

the shorter recordkeeping requirement for routine data (or data from routine tests). All test records must be kept for eight years. With electronic recording of test data, there should be no advantage to keeping the shorter recordkeeping requirement for a subset of test data. EPA also notes that the eight-year period restarts with certification for a new model year if the manufacturer uses carryover data.

• § 1042.255: Clarify that rendering information false or incomplete after submitting it is the same as submitting false or incomplete information. For example, if there is a change to any corporate information or engine parameters described in the manufacturer's application for certification, the manufacturer must amend the application to include the new information.

• § 1042.255: Clarify that voiding certificates for a recordkeeping or reporting violation will be limited to certificates that relate to the particular recordkeeping or reporting failure.

• § 1042.301: Clarify that the requirements to test production engines does not apply for engines that become new and subject to emission standards as remanufactured engines.

• § 1042.302: Clarify that manufacturers may fulfill the requirement to test each Category 3 production engine by performing the test before or after the engine is installed in the vessel. The largest Category 3 engines are assembled in the vessel, but some smaller Category 3 engines are assembled at a manufacturing facility where they can be more easily tested. Manufacturers must perform such testing on fully assembled production engines rather than relying on test results from test bed engines.

• § 1042.501: Provide instruction on how to verify proportional sampling for discrete mode testing where only one batch fuel measurement is made over the operating mode. This requires that manufacturers hold sampling constant over the sampling period. Manufacturers will verify

proportionality either over a discrete mode by using average exhaust flow rate paired with each recorded sample flow rate, or over the entire duty cycle.

• § 1042.501: Remove test procedure specifications that are already covered in 40 CFR part 1065.

• § 1042.505: Correct the reference to the ISO C1 duty cycle in 40 CFR part 1039.

• § 1042.515: Remove an incorrect cite.

• §§ 1042.605 and 1042.610: Revise the reporting requirement to require detailed information about the previous

year, rather than requiring a detailed projection for the year ahead. The information required in advance will be limited to a notification of plans to use the provisions of these sections.

- § 1042.630: Clarify that dockside examinations are not inspections. Vessels subject to Coast Guard inspection are identified in 46 U.S.C. 3301.
- §§ 1042.601 and 1042.635: Migrate the national security exemption to § 1068.225, including the expanded automatic exemption related the standards that would otherwise require sulfur-sensitive technology. See Section XIII.D(2).
- § 1042.640: Migrate engine branding to § 1068.45.
- § 1042.650: Clarify that vessel operators may modify certified engines if they will be operated for an extended period outside the United States where ULSD will be unavailable. This does not preclude the possibility of vessel operators restoring engines to a certified configuration in anticipation of bringing the vessel back to the United States.
- § 1042.660: Identify the contact information for submitting reports related to operation without SCR reductant.
- § 1042.670: Specify that gas turbine engines are presumed to have an equivalent power density below 35 kW per liter of engine displacement; this is needed to identify which Tier 3 standards apply.
- § 1042.701: Clarify that emission credits generated under 40 CFR part 94 may be used for demonstrating compliance with the Tier 3 and Tier 4 standards in 40 CFR part 1042.
- §§ 1042.701 and 1042.730: Describe the process for retiring emission credits. This may be referred to as donating credits to the environment.
- § 1042.705: Change terminology for counting engines from “point of first retail sale” to “U.S.-direction production volume.” This conforms to the usual approach for calculating emission credits for nonroad engines.
- § 1042.710: Clarify that it is not permissible to show a proper balance of credits for a given model by using emission credits from a future model year.
- § 1042.730: Clarify terminology for ABT reports.
- § 1042.810: Clarify that it is only the remanufacturing standards of subpart I, not the certification standards that are the subject of the applicability determination in § 1042.810.
- § 1042.830: Add a provision to specifically allow voluntary labeling for engines that are not subject to remanufacturing standards, and to

clarify that the label is required for engines that are subject to remanufacturing standards.

- § 1042.901: Update the contact information for the Designated Compliance Officer.
- § 1042.901: Revise the definition of “model year” to correct cites and clarify that the calendar year relates to the time that engines are produced under a certificate of conformity.
- §§ 1042.901 and 1042.910: Update the reference documents for Annex VI and NO<sub>x</sub> Technical Code to include recent changes from the International Maritime Organization.
- § 1042.915: Migrate provisions related to confidential information to 40 CFR part 1068.

We proposed to disallow amending certified configurations after the end of the model year. However, manufacturers shared in their comments that this would change the field-fix policy that has long since allowed for making such changes. We have retracted the proposed change and replaced it with a new paragraph that describes how manufacturers may amend the application for certification during and after the model year, consistent with the current policy regarding field fixes.

#### J. Miscellaneous EPA Amendments

EPA is clarifying that the cold NMHC standards specified in 40 CFR 86.1811–17 do not apply at high altitude. We intended in recent amendments to state that the cold CO standards apply at both low and high altitude, but inadvertently placed that statement where it also covered cold NMHC standards, which contradicts existing regulatory provisions that clearly describe the cold NMHC standards as applying only for low-altitude testing. The change simply moves the new clarifying language to apply only to cold CO standards. We are also restoring the cold NMHC standards in paragraph (g)(2), which were inadvertently removed as part of the earlier amendments.

EPA is revising the specifications for Class 2b and Class 3 vehicles certifying early to the Tier 3 exhaust emission standards under 40 CFR 86.1816–18 to clarify that carryover values apply for formaldehyde. The Preamble to the earlier final rule described these standards properly, but the regulations inadvertently pointed to the Tier 3 values for these vehicles.

EPA is making a minor correction to the In-Use Compliance Program under 40 CFR 86.1846–01. The Light-Duty Tier 3 final rule amended this section by describing how to use SFTP test results in the compliance determination in a way that inadvertently removed a

reference to *low-mileage* SFTP testing. We are restoring the removed text.

EPA is revising the instruction for creating road-load coefficients for cold temperature testing in 40 CFR 1066.710 to simply refer back to 40 CFR 1066.305 where this is described more generally. The text originally adopted in 40 CFR 1066.710 incorrectly describes the calculation for determining those coefficients.

EPA is also adopting two minor amendments related to highway motorcycles. First, we are correcting an error related to the small-volume provisions for highway motorcycles. The regulation included an inadvertent reference to a small-volume threshold based on an annual volume of 3,000 motorcycles produced in the United States. As written, this would not consider any foreign motorcycle production for importation into the United States. This error is corrected by simply revising the text to refer to an annual production volume of motorcycles produced “for” the United States. This change properly reflects small-volume production as it relates to compliance with EPA standards. Second, we are clarifying the language describing how to manage the precision of emission results, both for measured values and for calculating values when applying a deterioration factor. This involves a new reference to the rounding procedures in 40 CFR part 1065 to replace the references to outdated ASTM procedures.

#### K. Competition Vehicles

The proposal included a clarification related to vehicles used for competition to ensure that the Clean Air Act requirements are followed for vehicles used on public roads. This clarification is not being finalized. EPA supports motorsports and its contributions to the American economy and communities all across the country. EPA’s focus is not (nor has it ever been) on vehicles built or used exclusively for racing, but on companies that violate the rules by making and selling products that disable pollution controls on motor vehicles used on public roads. These unlawful defeat devices lead to harmful pollution and adverse health effects. The proposed language was not intended to represent a change in the law or in EPA’s policies or practices towards dedicated competition vehicles. Since our attempt to clarify led to confusion, EPA has decided to eliminate the proposed language from the final rule.

EPA will continue to engage with the racing industry and others in its support for racing, while maintaining the Agency’s focus where it has always

been: Reducing pollution from the cars and trucks that travel along America's roadways and through our neighborhoods.

*L. Amending 49 CFR Parts 512 and 537 To Allow Electronic Submissions and Defining Data Formats for Light-Duty Vehicle Corporate Average Fuel Economy (CAFE) Reports*

To improve efficiency and reduce the burden to manufacturers and the agencies, NHTSA proposed to amend 49 CFR part 537 to eliminate the option for manufacturers to submit pre-model, mid-model and supplemental reports on CD-ROMS, and require only one electronic submission (for each report) electronically via a method proscribed by NHTSA. NHTSA planned to introduce a new electronic format to standardize the method for collecting manufacturer's information. NHTSA also proposed modifying 49 CFR part 512 to include and protect submitted CAFE data elements that need to be treated as confidential business information. For the final rule, NHTSA is not finalizing this proposal in this rulemaking but will consider electronic submission for CAFE reports in a future action.

#### XIV. Statutory and Executive Order Reviews

*A. Executive Order 12866: Regulatory Planning and Review and Executive Order 13563: Improving Regulation and Regulatory Review*

This action is an economically significant regulatory action that was submitted to the Office of Management and Budget (OMB) for review. Any changes made in response to OMB recommendations have been documented in the docket. The agencies prepared an analysis of the potential costs and benefits associated with this action. This analysis, the "Regulatory Impact Analysis—Heavy-Duty GHG and Fuel Efficiency Standards," is available in the docket. The analyses contained in this document are also summarized in Sections VII, VIII, and IX of this Preamble.

*B. National Environmental Policy Act*

This section describes NHTSA's Environmental Impact Statement (EIS) process under the National Environmental Policy Act (NEPA), 42 U.S.C. 4321–4347, and implementing regulations issued by the Council on Environmental Quality (CEQ), 40 CFR parts 1500–1508, and NHTSA, 49 CFR part 520. Pursuant to 49 U.S.C. 304a(b) and DOT's "Final Guidance on MAP–21 Section 1319 Accelerated Decision

making in Environmental Reviews,"<sup>992</sup> NHTSA is issuing a Final Environmental Impact Statement (FEIS)<sup>993</sup> concurrently with its final rule. This Preamble constitutes the Record of Decision (ROD) for NHTSA's final rule establishing Phase 2 fuel efficiency standards for heavy-duty engines and vehicles.<sup>994</sup> NHTSA has determined that concurrent issuance of the FEIS and ROD is not precluded by statutory criteria<sup>995</sup> or practicability considerations.

The first subsection below describes the agency's NEPA process to date, including its scoping notice and Draft Environmental Impact Statement (DEIS). The second subsection describes the FEIS, and the third subsection discusses the ROD. The final subsection includes other regulatory notices related to environmental concerns.

(1) Scoping Notice and Draft Environmental Impact Statement

Under NEPA, a Federal agency must prepare an EIS on proposals for major Federal actions that significantly affect the quality of the human environment.<sup>996</sup> The purpose of an EIS is to inform decision makers and the public of the potential environmental impacts of a proposed action and reasonable alternative actions the agency could take.<sup>997</sup> The EIS is used by the agency, in conjunction with other

relevant material, to plan actions and make decisions.

On July 9, 2014, NHTSA published a notice of intent to prepare an EIS for this rulemaking and requested scoping comments (79 FR 38842). The notice invited Federal, State, and local agencies, Indian tribes, stakeholders, and the public to participate in the scoping process and to help identify the environmental issues and reasonable alternatives to be examined in the EIS. NHTSA considered the comments received on that notice as it prepared its DEIS.

NHTSA released a DEIS for this rulemaking on June 19, 2015, concurrently with its release of the NPRM.<sup>998</sup> NHTSA prepared the DEIS to analyze and disclose the potential environmental impacts of the HD fuel consumption standards and a reasonable range of alternatives. Environmental impacts analyzed in the DEIS included those related to fuel and energy use, air quality, and climate change. The DEIS also described potential environmental impacts to a variety of resource areas, including water resources, biological resources, land use and development, safety, hazardous materials and regulated wastes, noise, socioeconomic, and environmental justice. These resource areas were assessed qualitatively in the DEIS.

The DEIS analyzed five alternative approaches to regulating HD vehicle fuel consumption, including a "preferred alternative" and a "no action alternative." The DEIS evaluated a reasonable range of alternatives under NEPA, and analyzed the direct, indirect, and cumulative impacts of those alternatives in proportion to their significance.

Because of the link between the transportation sector and GHG emissions, NHTSA recognizes the need to consider the possible impacts on climate and global climate change in the analysis of the effects of its fuel consumption standards. NHTSA also recognizes the difficulties and uncertainties involved in such an impact analysis. Accordingly, consistent with CEQ regulations on addressing incomplete or unavailable information in environmental impact analyses, NHTSA reviewed existing credible scientific evidence that was relevant to this analysis and summarized it in the DEIS. NHTSA also employed and summarized the results of research

<sup>992</sup> Section 1319(b) ("Accelerated Decision making in Environmental Reviews") of the Moving Ahead for Progress in the 21st Century Act (MAP–21), Public Law 112–141, instructed a lead agency on an EIS, "to the maximum extent practicable," to develop a "single document that consists of a final environmental impact statement and a record of decision." DOT implemented this provision through guidance, clarifying that "[i]n the case of a NEPA review for a rulemaking where the final rule is the Record of Decision, the [DOT operating administration] should make the completed FEIS available to the decision maker simultaneously with the final rule, unless it is determined that statutory criteria or practicability considerations preclude issuance of the combined document." See [https://www.transportation.gov/sites/dot.gov/files/docs/MAP-21\\_1319\\_Final\\_Guidance.pdf](https://www.transportation.gov/sites/dot.gov/files/docs/MAP-21_1319_Final_Guidance.pdf). Section 1319 was subsequently repealed by Section 1304(j)(2) of the Fixing America's Surface Transportation Act (FAST Act), Public Law 114–94. However, in the same Act, Congress codified an identical provision at 49 U.S.C. 304a. FAST Act, Sec. 1311(a). Because the provision requiring, "to the maximum extent practicable . . . a single document" was not otherwise amended, the requirement and DOT's implementation remain unchanged.

<sup>993</sup> The agency's FEIS is available at its Fuel Economy Web site (<http://www.nhtsa.gov/fuel-economy/>), as well as in Docket No. NHTSA–2014–0074 on [Regulations.gov](http://www.regulations.gov) (<http://www.regulations.gov>).

<sup>994</sup> See 40 CFR 1505.2.

<sup>995</sup> 49 U.S.C. 304a(b)(1)–(2).

<sup>996</sup> 40 CFR 1502.3.

<sup>997</sup> 40 CFR 1502.1.

<sup>998</sup> The agency's DEIS is available at its Fuel Economy Web site (<http://www.nhtsa.gov/fuel-economy/>), as well as in Docket No. NHTSA–2014–0074 on [Regulations.gov](http://www.regulations.gov) (<http://www.regulations.gov>).

models generally accepted in the scientific community.

Although the alternatives have the potential to decrease GHG emissions substantially, the DEIS found they do not prevent climate change, but only result in reductions in the anticipated increases in CO<sub>2</sub> concentrations, temperature, precipitation, and sea level. They will also, to a small degree, delay the point at which certain temperature increases and other physical effects stemming from increased GHG emissions will occur. As discussed in the DEIS, NHTSA presumes that these reductions in climate effects will be reflected in reduced impacts on affected resources. The EPA and the U.S. Department of Energy served as cooperating agencies in the preparation of the DEIS. The DEIS informed NHTSA decision makers in their preparation of the NPRM and in the ongoing rulemaking process. In the DEIS and NPRM, NHTSA invited comments on the DEIS from Federal, State, and local agencies, Indian tribes, stakeholders, and the public by August 31, 2015. NHTSA mailed (both electronically and through U.S. mail) notification of its availability to individuals and entities identified in Chapter 10 of the DEIS. In addition, EPA published a Notice of Availability of the DEIS on June 26, 2015, officially triggering the public comment period.<sup>999</sup> NHTSA subsequently extended the comment period to October 1, 2015.<sup>1000</sup> Comments on the EIS were also invited at the joint NHTSA/EPA public hearings held on the NPRM.

## (2) Final Environmental Impact Statement

NHTSA received many written and oral comments to the NPRM and the DEIS. The written comments submitted to NHTSA and the transcripts from the public hearings are part of the administrative record and are available on the Federal Docket, available online at <http://www.regulations.gov/>, Reference Docket Nos. NHTSA–2014–0074 and NHTSA–2014–0132. NHTSA reviewed, analyzed, and considered all relevant comments it received during the public comment period. The agency then updated and revised the DEIS to prepare the FEIS, which is being released concurrently with this final rule and ROD. For a more detailed discussion of the comments NHTSA received, including the agency's responses to those comments, see Chapter 9 of the FEIS.

In developing the Phase 2 fuel efficiency standards for heavy-duty engines and vehicles adopted in this final rule, NHTSA has been informed by the analyses contained in the *Final Environmental Impact Statement, Phase 2 Fuel Efficiency Standards for Medium- and Heavy-Duty Engines and Vehicles*, Docket No. NHTSA–2014–0074.

NHTSA will submit the FEIS to EPA, in accordance with CEQ NEPA implementing regulations and EPA guidance.<sup>1001</sup> Prior to submission, NHTSA will post the FEIS on its Web site and in the public docket, as well as notify stakeholders and interested parties identified in Chapter 11 of the FEIS about its availability (both electronically and through U.S. mail). EPA will then publish a Notice of Availability of the FEIS in the **Federal Register**.

## (3) Record of Decision

For Federal actions requiring an EIS, the CEQ regulations instruct the action agency to prepare a concise public “record of decision” at the time of its decision. The ROD must state: (1) The agency's decision; (2) all alternatives considered by the agency in reaching its decision, specifying the alternative or alternatives that were considered to be environmentally preferable; (3) the agency's preferences among alternatives based on relevant factors, including economic and technical considerations and agency statutory missions; (4) the factors balanced by the agency in making its decision, including any essential considerations of national policy; (5) how these factors and considerations entered into the agency's decision; and (6) whether all practicable means to avoid or minimize environmental harm from the alternative selected have been adopted, and if not, why they were not.<sup>1002</sup> As stated above, this Preamble constitutes the ROD for NHTSA's final rule establishing Phase 2 fuel efficiency standards for heavy-duty engines and vehicles.

### (a) The Agency's Decision

In the DEIS and FEIS, NHTSA identified Alternative 3 as the Preferred Alternative. Alternative 3, as analyzed in the FEIS, is the regulation finalized by NHTSA in this rulemaking. The standards would result in significant improvements in fuel efficiency for heavy-duty engines and vehicles. These final standards are included at the end

of this document, described extensively in this Preamble, and analyzed for economic and environmental impacts in the RIA and FEIS.

In sum, after carefully reviewing and analyzing all of the information in the public record, RIA, FEIS, and public and agency comments submitted on the DEIS and NPRM, NHTSA has decided to finalize the Preferred Alternative.

## (b) Alternatives NHTSA Considered in Reaching Its Decision

When preparing an EIS, NEPA requires an agency to compare the potential environmental impacts of its proposed action and a reasonable range of alternatives. In the DEIS and FEIS, NHTSA analyzed a No Action Alternative and four action alternatives, which represent a range of potential actions the agency could take. The environmental impacts of these alternatives, in turn, represent a range of potential environmental impacts that could result from NHTSA's chosen action in setting fuel efficiency standards for heavy-duty engines and vehicles.

The No Action Alternative in the DEIS and FEIS assumes that NHTSA would not issue a final rule regarding Phase 2 fuel efficiency standards for heavy-duty engines and vehicles. Instead, it assumes that NHTSA's Phase 1 standards would continue indefinitely. The No Action Alternative therefore reflects the average fuel efficiency levels and GHG emissions performance that manufacturers would achieve without additional regulation. This alternative provided an analytical baseline against which to compare the environmental impacts of the other alternatives presented in the EIS. NEPA expressly requires agencies to consider a “no action” alternative in their NEPA analyses and to compare the effects of not taking action with the effects of action alternatives in order to demonstrate the environmental effects of the action alternatives.<sup>1003</sup>

In the DEIS, in addition to the No Action Alternative, NHTSA analyzed a reasonable range of action alternatives with fuel efficiency standards at various

<sup>999</sup> 80 FR 36803 (Jun. 26, 2015).  
<sup>1000</sup> 80 FR 53513 (Sep. 4, 2015).

<sup>1001</sup> See CEQ implementing regulations at 40 CFR 1506.9; EPA EIS filing guidance at 77 FR 51530 (Aug. 24, 2012).

<sup>1002</sup> 40 CFR 1505.2.

<sup>1003</sup> See 40 CFR 1502.2(e), 1502.14(d). CEQ has explained that “[T]he regulations require the analysis of the no action alternative even if the agency is under a court order or legislative command to act. This analysis provides a benchmark, enabling decision makers to compare the magnitude of environmental effects of the action alternatives. [See 40 CFR 1502.14(c).] \* \* \* Inclusion of such an analysis in the EIS is necessary to inform Congress, the public, and the President as intended by NEPA. [See 40 CFR 1500.1(a).]” Forty Most Asked Questions Concerning CEQ's National Environmental Policy Act Regulations, 46 FR 18026 (Mar. 23, 1981).

levels of stringency, with Alternative 2 the least stringent and Alternative 5 the most stringent. The exact levels of stringency for each alternative were described in Chapter 2 of the DEIS. As noted in the DEIS, based on the different ways the agency could weigh the various considerations, NHTSA believed that the “maximum feasible improvement” in heavy-duty vehicle and engine fuel efficiency fell within that range. In the FEIS, the levels of stringency for Alternatives 2, 4, and 5 are unchanged from the DEIS and are described in Chapter 2 of the FEIS.<sup>1004</sup> However, Alternative 3 (the Preferred Alternative) was revised in response to public comments and additional research. The changes to Alternative 3 are explained extensively in this Preamble, and are reflected in the FEIS.<sup>1005</sup>

Alternatives 2 and 5 were intended to provide the lower and upper bounds of a reasonable range of alternatives. In the EIS, the agency provided environmental analyses of these points, as well as intermediate points, to enable decision makers and the public to determine the environmental impacts of other points that fall between Alternatives 2 and 5. The action alternatives evaluated in the EIS therefore provided decision makers with the ability to select from a wide variety of other potential alternatives with stringencies that fall between Alternatives 2 and 5.

According to the FEIS, Alternative 5 is the overall Environmentally Preferable Alternative because it would result in the largest overall reductions in fuel use and emissions of criteria air pollutants, toxic air pollutants, and GHGs among the alternatives considered.<sup>1006</sup> Under each action

<sup>1004</sup> The environmental impacts reported for these alternatives in the FEIS differ from those reported in the DEIS. These differences result from minor changes in modeling assumptions (such as VMT, fleet profile, upstream emission levels, etc.), technology penetration and effectiveness assumptions, and other incremental updates resulting from public comments and additional research.

<sup>1005</sup> As a result of these changes, Alternative 3 is more stringent than Alternative 4 in some heavy-duty segments, and more stringent overall. NHTSA did not renumber the alternatives (to maintain increasing stringency from Alternative 2 to Alternative 5) in order to allow readers to more easily compare the DEIS to the FEIS, as well as to maintain Alternatives 2, 4, and 5 as benchmarks to which the Preferred Alternative may be compared.

<sup>1006</sup> Although NHTSA is required to identify the Environmentally Preferable Alternative under the CEQ regulations (40 CFR 1505.2(b)), it is under no obligation to select that alternative in its decision. This ROD explains the agency’s preferences among alternatives, the factors balanced by the agency in making its decision (including environmental considerations), and how the factors and considerations balanced by the agency entered into its decision.

alternative the agency considered, the reduction in fuel consumption resulting from greater fuel efficiency causes reductions in GHG emissions compared to the No Action Alternative. In addition, as fuel consumption declines, emissions that occur during fuel refining and distribution also decline. While there may be some increases in fuel consumption and associated tailpipe and upstream emissions resulting from increased driving due to the fuel efficiency rebound effect, these increases are more than offset by reductions resulting from the improved fuel efficiency of regulated heavy vehicles, leading to a net reduction in total emissions. The criteria air pollutant, toxic air pollutant, and GHG emissions reductions are anticipated to improve overall health outcomes and reduce the impacts of climate change on the human environment. As Alternative 5 would result in the greatest reductions in fuel consumption, it also results in the lowest total air pollutant and GHG emissions, and is therefore Environmentally Preferable.<sup>1007</sup>

The environmental impacts associated with the alternatives under consideration are described in Chapters 3–7 of the FEIS. NHTSA considered these environmental impacts in making its decision, and incorporates that analysis by reference here.

#### (c) NHTSA’s Preferences Among Alternatives Based on Relevant Factors; Factors Balanced by NHTSA in Making Its Decision; and How These Factors and Considerations Entered Into NHTSA’s Decision

NHTSA considered various relevant factors in setting Phase 2 fuel efficiency standards for heavy-duty engines and vehicles, including economic, technical, and environmental considerations, as well as safety considerations, consistent with the agency’s statutory mission. This Preamble, which constitutes the ROD for NHTSA’s final rule, provides a complete discussion of the agency’s preferences among alternatives based on relevant factors, the factors balanced by the agency in making its decision, and how the factors and considerations balanced by the agency entered into its decision.

<sup>1007</sup> For some toxic air pollutants, Alternative 3 is the Environmentally Preferable Alternative because it results in the greatest reductions of emissions of those pollutants. However, the greater overall stringency of Alternative 5 results in greater overall emissions reductions among criteria and toxic air pollutants. As a consequence, Alternative 5 results in the greatest reductions of adverse health effects resulting from heavy duty vehicle emissions.

#### (d) Mitigation

The CEQ regulations specify that a ROD must “state whether all practicable means to avoid or minimize environmental harm from the alternative selected have been adopted, and if not, why they were not.”<sup>1008</sup> In essence, this regulation requires NHTSA to address mitigation in the ROD.<sup>1009</sup> The overwhelming majority of the environmental effects of NHTSA’s action are positive (*i.e.*, beneficial environmental impacts) and would not raise issues of mitigation. Overall emissions of criteria and toxic air pollutants are generally projected to decrease under the final standards as compared to their levels under the No Action Alternative. However, analysis of the environmental trends reported in the FEIS for the Preferred Alternative indicates small emissions increases for some air pollutants in some near-term analysis years. The agency forecasts emissions increases for some alternatives because, under all the alternatives analyzed in the FEIS, increases in vehicle use due to improved fuel efficiency are projected to result in growth in total miles traveled by heavy-duty vehicles. The growth in VMT outpaces emissions reductions for some pollutants, resulting in projected increases for these pollutants. In addition, NHTSA’s NEPA analysis predicted increases in emissions of some air pollutants under certain alternatives based on assumptions about the type of technologies manufacturers will use to comply with the standards (particularly APU use). However, for the reasons described in Section 5.5.2.3 of the RIA, some of those air pollutant increases are no longer anticipated to occur.

Although limited harmful impacts of the final standards are projected in some near-term analysis years in the FEIS, the overall environmental impacts of the final standards are anticipated to be overwhelmingly beneficial. NHTSA’s authority to promulgate new fuel efficiency standards for heavy-duty vehicles and engines does not allow the agency to regulate criteria or toxic air pollutants from vehicles or factors affecting those emissions, such as driving habits. Consequently, NHTSA must set fuel efficiency standards but is unable to take steps to mitigate the limited harmful impacts of those standards. However, EPA has taken additional action in this final rule to control PM emissions resulting from APU use that, for the reasons described

<sup>1008</sup> 40 CFR 1505.2(c).

<sup>1009</sup> 40 CFR 1508.20.



in Section 5.5.2.3 of the RIA, would mitigate some of the projected harmful impacts. Further, Chapter 8 of the FEIS outlines a number of other initiatives across the government that could ameliorate the environmental impacts of motor vehicle use, including the use of heavy-duty vehicles.

(4) Other Regulatory Notices Related to Environmental Concerns

This section includes regulatory determinations related to environmental concerns that are not otherwise included in the FEIS. For example, NHTSA addresses the following in the FEIS: Conformity requirements under the Clean Air Act (Chapter 4.1.1.4), the National Historic Preservation Act (Chapter 7.2), and Environmental Justice (Chapter 7.5).

(a) Coastal Zone Management Act (CZMA)

The Coastal Zone Management Act<sup>1010</sup> provides for the preservation, protection, development, and (where possible) restoration and enhancement of the nation's coastal zone resources. Under the statute, States are provided with funds and technical assistance in developing coastal zone management programs. Each participating State must submit its program to the Secretary of Commerce for approval. Once the program has been approved, any activity of a Federal agency, either within or outside of the coastal zone, that affects any land or water use or natural resource of the coastal zone must be carried out in a manner that is consistent, to the maximum extent practicable, with the enforceable policies of the State's program.

NHTSA concludes that the CZMA is not applicable to the agency's decision because it does not involve any activity within, or outside of, the nation's coastal zones as intended by the statute. These standards would mitigate some of the anticipated impacts of global climate change, including potential impacts to coastal zones that would otherwise have occurred in the absence of agency action. However, the agency's action will not directly affect any land or water use or natural resource of a coastal zone.

The agency has conducted a qualitative review of the related direct, indirect, and cumulative impacts of the alternatives on potentially affected resources, including coastal zones, in the FEIS. See Chapter 5.5 of the FEIS.

(b) Floodplain Management (Executive Orders 11988 and 13690; DOT Order 5650.2)

These Orders require Federal agencies to avoid the long- and short-term adverse impacts associated with the occupancy and modification of floodplains, and to restore and preserve the natural and beneficial values served by floodplains. Executive Order 11988 also directs agencies to minimize the impact of floods on human safety, health, and welfare, and to restore and preserve the natural and beneficial values served by floodplains through evaluating the potential effects of any actions the agency may take in a floodplain and ensuring that its program planning and budget requests reflect consideration of flood hazards and floodplain management. DOT Order 5650.2 sets forth DOT policies and procedures for implementing Executive Order 11988. The DOT Order requires that the agency determine if a proposed action is within the limits of a base floodplain, meaning it is encroaching on the floodplain, and whether this encroachment is significant. If significant, the agency is required to conduct further analysis of the proposed action and any practicable alternatives. If a practicable alternative avoids floodplain encroachment, then the agency is required to implement it.

In this rulemaking, the agency is not occupying, modifying, or encroaching on floodplains. The agency, therefore, concludes that the Orders are not applicable to NHTSA's decision. The agency has, however, conducted a review of the alternatives on potentially affected resources, including floodplains, in the FEIS. See Chapter 5.5 of the FEIS.

(c) Preservation of the Nation's Wetlands (Executive Order 11990 & DOT Order 5660.1A)

These Orders require Federal agencies to avoid, to the extent possible, undertaking or providing assistance for new construction located in wetlands unless the agency head finds that there is no practicable alternative to such construction and that the proposed action includes all practicable measures to minimize harms to wetlands that may result from such use. Executive Order 11990 also directs agencies to take action to minimize the destruction, loss, or degradation of wetlands in "conducting Federal activities and programs affecting land use, including but not limited to water and related land resources planning, regulating, and licensing activities." DOT Order 5660.1A sets forth DOT policy for

interpreting Executive Order 11990 and requires that transportation projects "located in or having an impact on wetlands" should be conducted to assure protection of the Nation's wetlands. If a project does have a significant impact on wetlands, an EIS must be prepared.

The agency is not undertaking or providing assistance for new construction located in wetlands. In addition, the agency's action will not affect land use in wetlands, nor is it a transportation project "located in or having an impact on wetlands." Therefore, the agency concludes that these Orders do not apply to NHTSA's decision. The agency has, however, conducted a review of the alternatives on potentially affected resources, including wetlands. See Section 5.5 of the FEIS.

(d) Department of Transportation Act (Section 4(f))

Section 4(f) of the Department of Transportation Act of 1966 (49 U.S.C. 303), as amended, is designed to preserve publicly owned parklands, waterfowl and wildlife refuges, and significant historic sites. Specifically, Section 4(f) provides that DOT agencies cannot approve a transportation program or project that requires the use of any publicly owned land from a significant public park, recreation area, or wildlife and waterfowl refuge, or any land from a significant historic site, and results in a greater than *de minimis* impact unless a determination is made that:

- There is no feasible and prudent alternative that completely avoids the use of Section 4(f) property, and
- The program or project includes all possible planning to minimize harm to the Section 4(f) property resulting from the transportation use.

This rulemaking is not a transportation program or project that requires the use of any publicly owned land. As a result, NHTSA concludes that Section 4(f) is not applicable to NHTSA's decision.

C. Paperwork Reduction Act

The information collection activities in these final rules will be submitted for approval to the Office of Management and Budget (OMB) under the PRA. The Information Collection Request (ICR) document that EPA prepared has been assigned EPA ICR number 2394.05 and OMB Control Number 2060-0678. You can find a copy of the ICR in the docket for these final rules, and it is briefly summarized here. The burden estimates in this section account for the collective information collection burden imposed

<sup>1010</sup> 16 U.S.C. 1451-1466 (as amended).



by both agencies. The information collection requirements are not enforceable until OMB approves them.

The agencies will collect information to ensure compliance with the provisions in these rules. This includes a variety of testing, reporting and recordkeeping requirements for vehicle and engine manufacturers. Section 208(a) of the CAA requires that manufacturers provide information the Administrator may reasonably require to determine compliance with the regulations; submission of the information is therefore mandatory. We will consider confidential all information meeting the requirements of section 208(c) of the CAA.

*Respondents/affected entities:*

Respondents are manufacturers of engines and vehicles within the North American Industry Classification System (NAICS) and use the coding structure as defined by NAICS. 336111, 336112, 333618, 336120, 541514, 811112, 811198, 336111, 336112, 422720, 454312, 541514, 541690, 811198, 333618, 336510, for Motor Vehicle Manufacturers, Engine and Truck Manufacturers, Truck Trailer Manufacturers, Commercial Importers of Vehicles and Vehicle Components, and Alternative Fuel Vehicle Converters and Manufacturers.

*Respondent's obligation to respond:*

The information that is subject to this collection is collected whenever a manufacturer applies for a certificate of conformity. Under section 206 of the CAA (42 U.S.C. 7521), a manufacturer must have a certificate of conformity before a vehicle or engine can be introduced into commerce.

*Estimated number of respondents:* It is estimated that this collection affects approximately 141 engine and vehicle manufacturers.

*Frequency of response:* Annually.

*Total estimated burden:* The burden to the manufacturers affected by these rules has a range based on the number of engines and vehicles a manufacturer produces. The estimated average annual respondent burden associated with the first three implementation years of the Phase 2 program is 61,800 hours (see Table XIV-1). This estimated burden for engine and vehicle manufacturers is an average estimate for both new and existing reporting requirements for calendar years 2017, 2018 and 2019, in which trailer manufacturers will prepare for and begin certifying for Phase 2 while Phase 1 will continue for the other affected manufacturers. Burden is defined at 5 CFR 1320.3(b). Burden means the total time, effort, or financial resources expended by persons to generate, maintain, retain, or disclose

or provide information to or for a Federal agency. This includes the time needed to review instructions; develop, acquire, install, and utilize technology and systems for the purposes of collecting, validating, and verifying information, processing and maintaining information, and disclosing and providing information; adjust the existing ways to comply with any previously applicable instructions and requirements; train personnel to be able to respond to a collection of information; search data sources; complete and review the collection of information; and transmit or otherwise disclose the information.

TABLE XIV-1—BURDEN FOR REPORTING AND RECORDKEEPING REQUIREMENTS

Number of Affected Engine and Vehicle Manufacturers.	141.
Annual Labor Hours for Each Manufacturer to Prepare and Submit Required Information.	Varies.
Total Annual Information Collection Burden.	61,800 Hours.

*Total estimated cost:* The estimated average annual cost associated with the first three implementation years of the Phase 2 program is approximately \$8 million. This includes approximately \$3 million in capital and operation & maintenance costs. This estimated cost for engine and vehicle manufacturers is an average estimate for both new and existing testing, recordkeeping, and reporting requirements for calendar years 2017, 2018 and 2019, in which trailer manufacturers will prepare for and begin certifying for Phase 2 while Phase 1 will continue for the other affected manufacturers.

An agency may not conduct or sponsor, and a person is not required to respond to, a collection of information unless it displays a currently valid OMB control number. The OMB control numbers for EPA's regulations in title 40 are listed in 40 CFR part 9. When OMB approves this ICR, the Agency will announce that approval in the **Federal Register** and publish a technical amendment to 40 CFR part 9 to display the OMB control number for the approved information collection activities contained in this final rule.

*D. Regulatory Flexibility Act*

I certify that this action will not have a significant economic impact on a substantial number of small entities under the RFA. The small entities subject to the requirements of this

action are small businesses. EPA has determined that less than 20 percent, and fewer than 100 regulated entities in each sector may experience an impact of greater than one percent of their annual revenue. Details of this analysis are presented in Chapter 12 of the Regulatory Impact Analysis located in the rulemaking docket (EPA-HQ-OAR-2014-0827), and are summarized below.

Pursuant to section 603 of the RFA, the agencies prepared an initial regulatory flexibility analysis (IRFA) for the proposed rule. Pursuant to section 609(b) of the RFA, the EPA convened a Small Business Advocacy Review (SBAR) Panel to obtain advice and recommendations from representatives of small entities that would potentially be regulated by the rule. A summary of the IRFA and the SBAR Panel's recommendations is presented in the proposed rule (at 80 FR 40542, July 13, 2015). The Final Panel Report is also available in the rulemaking docket.

The agencies identified four industries that would be potentially affected by this rulemaking: Alternative fuel engine converters, heavy-duty engine manufacturers, vocational vehicle chassis manufacturers, and trailer manufacturers. The agencies proposed and sought comment on the recommendations from the Panel. The flexibilities proposed for the engine manufacturers, engine converters, vocational vehicle manufacturers, and glider manufacturers are adopted in the final rule and fewer than 20 percent of the small entities in those sectors are estimated to incur a burden greater than one percent of their annual revenue. In addition to the flexibilities proposed for the trailer program, the agencies reduced the number of small entities regulated by the final rules by limiting the non-box trailer program to three distinct trailer types. As a result, 73 small business trailer manufacturers have zero burden from this rulemaking. Of the remaining small business trailer manufacturers, only 12 percent are estimated to have an economic impact greater than one percent of their annual revenue. As a result of these findings, EPA believes it can certify that these rules will not have a significant economic impact on a substantial number of small entities under the RFA. See Chapter 12.7 and 12.8 of the Regulatory Impact Analysis (RIA) of these rules for a more detailed description of the flexibilities adopted for and economic effects on the small businesses in these sectors.

(1) Legal Basis for Agency Action

Heavy-duty vehicles are classified as those with gross vehicle weight ratings

(GVWR) of greater than 8,500 lb. section 202(a) of the Clean Air Act (CAA) allows EPA to regulate new vehicles and new engines by prescribing emission standards for pollutants which the Administrator finds “may reasonably be anticipated to endanger public health or welfare.” In 2009, EPA found that six greenhouse gases (GHGs) were anticipated to endanger public health or welfare, and new motor vehicles and new motor vehicle engines contribute to

that pollution. This finding was upheld by the unanimous court in *Coalition for Responsible Regulation v. EPA*, 684 F. 3d 102 (D.C. Cir. 2012). Acting under the authority of the CAA, EPA set the first phase of heavy-duty vehicle GHG standards (Phase 1) and specified certification requirements for emissions of four GHGs emitted by mobile sources: carbon dioxide (CO<sub>2</sub>), nitrous oxide (N<sub>2</sub>O), methane (CH<sub>4</sub>), and hydrofluorocarbons (HFC).

(2) Summary of Potentially Affected Small Entities

Table XIV–2 provides an overview of the primary SBA small business categories potentially affected by this regulation. EPA is not aware of any small businesses that manufacture complete heavy-duty pickup trucks and vans or Class 7 and 8 tractors.

TABLE XIV–2—PRIMARY SMALL BUSINESS CATEGORIES POTENTIALLY AFFECTED BY THIS REGULATION

Industry expected in rulemaking	Industry NAICS <sup>a</sup> code	NAICS description	Defined as small entity by SBA if less than or equal to:
Alternative Fuel Engine Converters .....	333999 811198	Misc. General Purpose Machinery All Other Automotive Repair & Maintenance.	500 employees. \$7.5 million (annual receipts).
Voc. Vehicle Chassis, Class 7 & 8 Tractor Manufacturers.	336120	Heavy-Duty Truck Manufacturing ..	1,500 employees.
HD Trailer Manufacturers .....	336212	Truck Trailer Manufacturing .....	1,000 employees.
HD Engine Manufacturers .....	336310	Motor Vehicle Gasoline Engine & Engine Parts.	1,000 employees.

**Note:**

<sup>a</sup>North American Industrial Classification System.

EPA used the criteria for small entities developed by the Small Business Administration under the North American Industry Classification System (NAICS) as a guide. Information about these entities comes from sources including EPA’s certification data, trade association databases, and previous rulemakings that have affected these industries. EPA then found employment information for these companies using the business information database Hoover’s Online (a subsidiary of Dan and Bradstreet). These entities fall under the categories listed in the table.

The agencies believe there are about 178 trailer manufacturers and 147 of these manufacturers qualify as small entities with 1,000 employees or less.<sup>1011</sup> EPA and NHTSA identified ten heavy-duty engine manufacturers that are currently certifying natural gas engines. Six of these companies are small businesses. Seventeen companies meet EPA requirements under 40 CFR part 85 as alternative fuel engine converters. We believe all 17 of the engine converters qualify as small businesses. Currently, 20 manufacturers that make chassis for vocational vehicles certify with EPA under the Phase 1 program and the agencies have identified an additional 19 small

vocational chassis manufacturers that are not currently certifying under Phase 1.

Glider kits and glider vehicles are a subset of tractor and vocational vehicles under the final Phase 2 rulemaking (including for regulation of criteria pollution emissions). Glider vehicle manufacturers traditionally purchase or manufacture new vehicle bodies (vocational vehicles or Class 7 and 8 tractors) for use with older powertrains and/or complete assembly of these vehicles by installing the powertrain. The agencies were aware of four glider vehicle manufacturers (for whom glider vehicle production was a primary business) at the time of the SBAR Panel and we identified three of these manufacturers as small entities. We are not aware of any small businesses that produce glider kits for others to assemble.<sup>1012</sup> Public comments to the proposed rule indicated that nearly 1,200 purchasers of glider kits, and we presume they would all meet the Act’s definition of “manufacturer”, which includes anyone who assembles motor vehicles. See Section I.E.(1)(c). We believe a majority of these manufacturers qualify as small businesses. However, it is likely that few of these entities that purchase glider kits do so as their primary business. It is likely that many (if not most) of these

entities assemble gliders for their own use from glider kits produced by large heavy-duty vehicle manufacturers. NHTSA is not finalizing fuel efficiency regulations applicable to gliders or glider kits at this time.

(3) Potential Reporting, Recordkeeping and Compliance Burdens

For any emission control program, EPA must have assurances that the regulated products will meet the standards. The program that EPA is adopting for manufacturers subject to this rule will include testing, reporting, and recordkeeping requirements. Testing requirements for these manufacturers include use of EPA’s Greenhouse gas Emissions Model (GEM) vehicle simulation tool to obtain the overall CO<sub>2</sub> emissions rate for certification of vocational chassis and trailers, aerodynamic testing to obtain aerodynamic inputs to GEM for some tractor and trailer manufacturers and engine dynamometer testing for alternative fuel engine converters to ensure their conversions meet the CO<sub>2</sub>, CH<sub>4</sub> and N<sub>2</sub>O engine standards. Reporting requirements will likely include emissions test data or model inputs and results, technical data related to the vehicles, and end-of-year sales information. Manufacturers will have to keep records of this information.

(4) Related Federal Rules

The primary federal rule that is related to the Phase 2 rules under consideration is the 2011 Greenhouse

<sup>1011</sup> The Small Business Administration amended its classification criteria for trailer manufacturers between the NPRM and this final rule. The threshold for qualifying as a small business trailer manufacturer is now 1,000 employees. Previously the small business threshold for trailer manufacturers was 500 employees.

<sup>1012</sup> Although this discussion is written based on the assumption that no small businesses produce glider kits for others to assemble, the conclusions would also be valid with respect to small entities that produce glider kits for sale, should they exist.

Gas Emissions and Fuel Efficiency Standards for Medium- and Heavy-Duty Engines and Vehicles (76 FR 57106, September 15, 2011). The Phase 1 program will continue to be in effect in the absence of these final rules. Small businesses are exempt under the Phase 1 program. California adopted its own greenhouse gas initiative, which places aerodynamic requirements on trailers used in long-haul applications.

#### (5) Summary of SBREFA Panel Process and Panel Outreach

##### (a) Significant Panel Findings

The Small Business Advocacy Review Panel (SBAR Panel, or the Panel) considered regulatory options and flexibilities to help mitigate potential adverse effects on small businesses as a result of these rules. During the SBREFA Panel process, the Panel sought out and received comments on the regulatory options and flexibilities that were presented to SERs and Panel members. The recommendations of the Panel are described below and are also located in the SBREFA Final Panel Report, which is available in the public docket.

##### (b) Panel Process

As required by section 609(b) of the RFA, as amended by SBREFA, we also conducted outreach to small entities and convened a SBAR Panel to obtain advice and recommendations of representatives of the small entities that potentially will be subject to the rule's requirements. On October 22, 2014, EPA's Small Business Advocacy Chairperson convened a Panel under section 609(b) of the RFA. In addition to the Chair, the Panel consisted of the Division Director of the Assessment and Standards Division of EPA's Office of Transportation and Air Quality, the Chief Counsel for Advocacy of the Small Business Administration, and the Administrator of the Office of Information and Regulatory Affairs within the Office of Management and Budget.

As part of the SBAR Panel process, we conducted outreach with representatives of small businesses that will potentially be affected by the final rulemaking. We met with these Small Entity Representatives (SERs) to discuss the potential rulemaking approaches and potential options to decrease the impact of the rulemaking on their industries. We distributed outreach materials to the SERs; these materials included background on the rulemaking, possible regulatory approaches, and possible rulemaking alternatives. The Panel met with SERs from the industries that will be directly

affected by the Phase 2 rules on November 5, 2014 (trailer manufacturers) and November 6, 2014 (engine converters and vocational vehicle chassis manufacturers) to discuss the outreach materials and receive feedback on the approaches and alternatives detailed in the outreach packet. The Panel also met with SERs on July 19, 2014 for an initial, introductory outreach meeting, and held a supplementary outreach meeting with the trailer manufacturer SERs on October 28, 2014. The Panel received written comments from the SERs following each meeting in response to discussions had at the meeting and the questions posed to the SERs by the agency. The SERs were specifically asked to provide comment on regulatory alternatives that could help to minimize the rule's impact on small businesses.

The Panel's findings and discussions were based on the information that was available during the Panel process and issues that were raised by the SERs during the outreach meetings and in their comments. It was agreed that EPA should consider the issues raised by the SERs and discussions had by the Panel itself, and that EPA should consider comments on flexibility alternatives that would help to mitigate negative impacts on small businesses to the extent legally allowable by the Clean Air Act.

Alternatives discussed throughout the Panel process included those offered in previous or current EPA rulemakings, as well as alternatives suggested by SERs and Panel members. A summary of these recommendations is detailed below, and a full discussion of the regulatory alternatives and hardship provisions discussed and recommended by the Panel can be found in the SBREFA Final Panel Report. A complete discussion of the provisions for which we are requesting comment and/or proposing in this action can be found in Sections IV.E and V.D of this Preamble with a summary in Chapter 12 of the RIA. Also, the Panel Report includes all comments received from SERs (Appendix B of the Report) and summaries of the two outreach meetings that were held with the SERs. In accordance with the RFA/SBREFA requirements, the Panel evaluated the aforementioned materials and SER comments on issues related to the IRFA. The Panel's recommendations from the Final Panel Report are discussed below.

##### (c) Panel Recommendations

###### (i) Small Business Trailer Manufacturers

Comments from trailer manufacturer SERs indicated that these companies are familiar with most of the technologies

presented during our outreach, but have no experience with EPA certification and do not anticipate they could manage the accounting and reporting requirements without additional staff and extensive training. Performance testing, which is a common requirement for many of EPA's regulatory programs, is largely unfamiliar to these small business manufacturers and the SERs believed the cost of testing would be a significant burden on their companies. In light of this feedback, the Panel recommended a combination of streamlined compliance and targeted exemptions for these small businesses based on the specific trailer types that they manufacture. The Panel believed these strategies would achieve many of the benefits for the environment by driving adoption of CO<sub>2</sub>-reducing technologies, while significantly reducing the burden that these new regulations would introduce on small businesses.

###### (ii) Box Trailer Manufacturers

Box trailer manufacturers have the benefit of relying on the aerodynamic technology development initiated through EPA's voluntary SmartWay program. The Panel was aware that EPA planned to propose a simplified compliance program for all manufacturers, in which aerodynamic device manufacturers have the opportunity to test and certify their devices with EPA as technologies that can be used by trailer manufacturers in their trailer certification. This pre-approved technology strategy was intended to provide all trailer manufacturers a means of complying with the standards without the burden of testing. In the event that this strategy is limited to the early years of the trailer program for all manufacturers, the Panel recommended that small manufacturers continue to be given the option to use pre-approved devices in lieu of testing.

In the event that small trailer manufacturers adopt pre-approved aerodynamic technologies and the appropriate tire technologies for compliance, the Panel recommended an alternative compliance pathway in which small business trailer manufacturers could simply report to EPA that all of their trailers include approved technologies in lieu of collecting all of the required inputs for the GEM vehicle simulation.

###### (iii) Non-Box Trailer Manufacturers

The Panel recommended no aerodynamic requirements for non-box trailers. The non-box trailer SERs indicated that they had no experience installing aerodynamic devices and had

only seen them in prototype-level demonstrations. In terms of the aerodynamic devices currently in use, most non-box trailer SERs identified unique operations in which their trailers are used that preclude the use of those technologies.

Some non-box trailer manufacturers had experience with LRR tires and ATI systems. However, the non-box trailer manufacturer SERs indicated that LRR tires are not currently available for some of their trailer types. The SERs noted that tire manufacturers are currently focused on box trailer applications and there are only a few LRR tire models that meet the needs of their customers. The Panel recommended EPA ensure appropriate availability of these tires in order for it to be deemed a feasible means of achieving these standards and recommended a streamlined compliance process based on the availability of technologies. The Panel suggested the best compliance option from a small business perspective would be for EPA to pre-approve tires, similar to the approach being proposed for aerodynamic technologies, and to maintain a list that could be used to exempt small businesses when no suitable tires are available. However, the Panel recognized the difficulties of maintaining an up-to-date list of certified technologies. The Panel recommended that, if EPA did not adopt the list-based approach, the agency consider a simplified letter-based compliance option that allows manufacturers to petition EPA for an exemption if they are unable to identify tires that meet the LRR performance requirements on a trailer family basis.

(iv) Non-Highway Trailer Manufacturers

The Panel recommended excluding all trailers that spend a significant amount of time in off-road applications. These trailers may not spend much time at highway speeds and aerodynamic devices may interfere with the vehicle's intended purpose. Additionally, tires with lower rolling resistance may not provide the type of traction needed in off-road applications.

(v) Compliance Provisions for all Small Trailer Manufacturers

Due to the potential for reducing a small business's competitiveness compared to the larger manufacturers, as well as the ABT recordkeeping burden, the Panel recommended that EPA consider small business flexibilities to allow small entities to opt out of ABT without placing themselves at a competitive disadvantage to larger firms that adopt ABT, such as a low volume exemption or requiring only

LRR where appropriate. EPA was asked to consider flexibilities for small businesses that would ease and incentivize their participation in ABT, such as streamlined the tracking requirements for small businesses. In addition, the Panel recommended that EPA request comment on the feasibility and consequences of ABT for the trailer program and additional flexibilities that will promote small business participation.

(vi) Lead Time Provisions for all Small Trailer Manufacturers

For all trailer types that will be included in the rule, the Panel recommended a 1-year delay in implementation for small trailer manufacturers at the start of the program to allow them additional lead time to make the proper staffing adjustments and process changes and possibly add new infrastructure to meet these requirements. In the event that EPA is unable to provide pre-approved technologies for manufacturers to choose for compliance, the Panel recommended that EPA provide small business trailer manufacturers an additional 1-year delay for each subsequent increase in stringency. This additional lead time will allow these small businesses to research and market the technologies required by the new standards.

(vii) Small Business Alternative Fuel Engine Converters

To reduce the compliance burden of small business engine converters who convert engines in previously-certified complete vehicles, the Panel recommended allowing engine compliance to be sufficient for certification—meaning that the converted vehicle would not need to be recertified *as a vehicle*. This recommended flexibility would eliminate the need for these small manufacturers to gather all of the additional component-level information in addition to the engine CO<sub>2</sub> performance necessary to properly certify a vehicle with GEM (*e.g.*, transmission data, aerodynamic performance, tire rolling resistance, etc.). In addition, the Panel recommended that small engine converters be able to submit an engineering analysis, in lieu of measurement, to show that their converted engines do not increase N<sub>2</sub>O emissions. Many of the small engine converters are converting SI-engines, and the catalysts in these engines are not expected to substantially impact N<sub>2</sub>O production. Small engine converters that convert CI-engines could

likely certify by ensuring that their controls require changes to the SCR dosing strategies.

The Panel did not recommend separate standards for small business natural gas engine manufacturers. The Panel stated that it believes this would discourage entrance for small manufacturers into this emerging market by adding unnecessary costs to a technology that has the potential to reduce CO<sub>2</sub> tailpipe emissions. In addition, the Panel noted that additional leakage requirements beyond a sealed crankcase for small business natural gas-fueled CI engines and requirements to follow industry standards for leakage could be waived for small businesses with minimal impact on overall GHG emissions.

Finally, the Panel recommended that small engine converters receive a one-year delay in implementation for each increase in stringency throughout the program. This flexibility will provide small converters additional lead time to obtain the necessary equipment and perform calibration testing if needed.

(viii) Emergency Vehicle Chassis Manufacturers

Fire trucks, and many other emergency vehicles, are built for high level of performance and reliability in severe-duty applications. Some of the CO<sub>2</sub>-reducing technologies listed in the materials could compromise the fire truck's ability to perform its duties and many of the other technologies simply provide no benefit in real-world emergency applications. The Panel recommended proposing less stringent standards for emergency vehicle chassis manufactured by small businesses. The Panel suggested that feasible standards could include adoption of LRR tires at the baseline Phase 2 level and installation of a Phase 2-compliant engine. In addition, the Panel recommended a simplified certification approach for small manufacturers who make chassis for emergency vehicles that reduces the number of inputs these manufacturers must obtain for GEM.

(ix) Off-Road Vocational Vehicle Chassis Manufacturers

At the time of the Panel process, EPA's intent was to continue the exemptions in Phase 1 for off-road and low-speed vocational vehicles (see generally 76 FR 57175). These provisions currently apply for vehicles that are defined as "motor vehicles" per 40 CFR 85.1703, but may conduct most of their operations off-road. Vehicles qualifying under these provisions must comply with the applicable engine standard, but need not comply with a

vehicle-level GHG standard. The Panel concluded this exemption is sufficient to cover the small business chassis manufacturers who design chassis for off-road vocational vehicles.

(x) Custom Chassis Manufacturers

The Panel concluded that chassis designed for specialty operations often have limited ability to adopt CO<sub>2</sub> and fuel consumption-reducing technologies due to their unique use patterns. In addition, the manufacturers of these chassis have very small annual sales volumes. The Panel recommended that EPA propose a low volume exemption for these custom chassis manufacturers. The Panel did not receive sufficient information to recommend a specific sales volume, but recommended that EPA request comment on how to design a small business exemption by means of a volume exemption, and an appropriate annual sales volume threshold.

(xi) Glider Manufacturers

The Panel was aware that EPA would like to reduce the production of glider vehicles that have higher emissions of criteria pollutants like NO<sub>x</sub> and PM than current engines, and which could have higher GHG emissions than Phase 2 engines. However, the Panel estimated that the number of vehicles produced by the small businesses who manufacture glider kits is too small to have a substantial impact on the total heavy-duty GHG inventory and recommended that existing small businesses be allowed to continue assembling glider vehicles without having to comply with the GHG requirements.<sup>1013</sup> The Panel recommended that EPA establish an allowance for existing small business glider manufacturers to produce some number of glider vehicles for legitimate purposes, such as for newer vehicles badly damaged in crashes. The Panel recommended that any other limitations on small business glider production be flexible enough to allow sales levels as high as the peak levels in the 2010–2012 timeframe.

*E. Unfunded Mandates Reform Act*

This action contains a federal mandate under UMRA, 2 U.S.C. 1531–1538, that may result in expenditures of \$100 million or more for state, local and tribal governments, in the aggregate, or the private sector in any one year. Accordingly, the agencies have prepared a statement required under section 202 of UMRA. The statement is included in

<sup>1013</sup> The Panel was unaware of the enormous increase in glider vehicle production in recent years, and its attendant adverse environmental impacts. See section XIII.B.(3) and (4) and RTC Section 14.2.

the docket for this action and briefly summarized here.

The agencies have prepared a statement of the cost-benefit analysis as required by section 202 of the UMRA; this discussion can be found in this Preamble, and in the RIA. The agencies believe that this action represents the least costly, most cost-effective approach to achieve the statutory requirements of the rules. Section IX explains why the agencies believe that the fuel savings that will result from this action will lead to lower prices economy wide, improving U.S. international competitiveness. The costs and benefits associated with this action are discussed in more detail above in Section IX and in the Regulatory Impact Analysis, as required by the UMRA.

This action is not subject to the requirements of section 203 of UMRA because it contains no regulatory requirements that might significantly or uniquely affect small governments.

*F. Executive Order 13132: Federalism*

This action does not have federalism implications. It will not have substantial direct effects on the states, on the relationship between the national government and the states, or on the distribution of power and responsibilities among the various levels of government.

In the spirit of Executive Order 13132, and consistent with EPA policy to promote communications between EPA and State and local governments, EPA specifically solicited comment from State and local officials on the proposed rules.

NHTSA notes that EPCA contains a provision (49 U.S.C. 32919(a)) that expressly preempts any State or local government from adopting or enforcing a law or regulation related to fuel economy standards or average fuel economy standards for automobiles covered by an average fuel economy standard under 49 U.S.C. Chapter 329. However, commercial medium- and heavy-duty on-highway vehicles and work trucks are not “automobiles,” as defined in 49 U.S.C. 32901(a)(3). In Phase 1 NHTSA concluded that EPCA’s express preemption provision will not reach the fuel efficiency standards to be established in this rulemaking. NHTSA is reiterating that conclusion here for the Phase 2 standards.

NHTSA also considered the issue of implied or conflict preemption. The possibility of such preemption is dependent upon there being an actual conflict between a standard established by NHTSA in this rulemaking and a State or local law or regulation. See *Spiestma v. Mercury Marine*, 537 U.S.

51, 64–65 (2002). At present, NHTSA has no knowledge of any State or local law or regulation that will actually conflict with one of the fuel efficiency standards to be established in this rulemaking.

*G. Executive Order 13175: Consultation and Coordination With Indian Tribal Governments*

This action does not have tribal implications as specified in Executive Order 13175. These rules will be implemented at the Federal level and impose compliance costs only on vehicle and engine manufacturers. Tribal governments will be affected only to the extent they purchase and use regulated vehicles. Thus, Executive Order 13175 does not apply to this action.

Although Executive Order 13175 does not apply to this action, EPA and NHTSA specifically solicited additional comment from tribal officials in developing this action.

*H. Executive Order 13045: Protection of Children From Environmental Health Risks and Safety Risks*

This action is subject to Executive Order 13045 because it is an economically significant regulatory action as defined by Executive Order 12866, and the agencies believe that the environmental health or safety risk addressed by this action may have a disproportionate effect on children. Accordingly, we have evaluated the environmental health or safety effects of these risks on children. The results of this evaluation are discussed below.

A synthesis of the science and research regarding how climate change may affect children and other vulnerable subpopulations is contained in the Technical Support Document for Endangerment or Cause or Contribute Findings for Greenhouse Gases under section 202(a) of the Clean Air Act, which can be found in the public docket for this action. In making those findings, EPA Administrator placed weight on the fact that certain groups, including children, are particularly vulnerable to climate-related health effects. In those findings, EPA Administrator also determined that the health effects of climate change linked to observed and projected elevated concentrations of GHGs include the increased likelihood of more frequent and intense heat waves, increases in ozone concentrations over broad areas of the country, an increase of the severity of extreme weather events such as hurricanes and floods, and increasing severity of coastal storms due to rising sea levels. These effects can all increase

mortality and morbidity, especially in vulnerable populations such as children, the elderly, and the poor. In addition, the occurrence of wildfires in North America have increased and are likely to intensify in a warmer future. PM emissions from these wildfires can contribute to acute and chronic illnesses of the respiratory system, including pneumonia, upper respiratory diseases, asthma, and chronic obstructive pulmonary disease, especially in children.

The agencies have estimated reductions in projected global mean surface temperature and sea level rise as a result of reductions in GHG emissions associated with the standards finalized in this action (Section VII and NHTSA's FEIS). Due to their vulnerability, children may receive disproportionate benefits from these reductions in temperature and the subsequent reduction of increased ozone and severity of weather events.

Children are also more susceptible than adults to many air pollutants because of differences in physiology, higher per body weight breathing rates and consumption, rapid development of the brain and bodily systems, and behaviors that increase chances for exposure. Even before birth, the developing fetus may be exposed to air pollutants through the mother that affect development and permanently harm the individual.

Infants and children breathe at much higher rates per body weight than adults, with infants under one year of age having a breathing rate up to five times that of adults.<sup>1014</sup> In addition, children breathe through their mouths more than adults and their nasal passages are less effective at removing pollutants, which leads to a higher deposition fraction in their lungs.<sup>1015</sup>

Certain motor vehicle emissions present greater risks to children as well. Early life stages (e.g., children) are thought to be more susceptible to tumor development than adults when exposed to carcinogenic chemicals that act through a mutagenic mode of action.<sup>1016</sup>

<sup>1014</sup> U.S. Environmental Protection Agency. (2009). Metabolically-derived ventilation rates: a revised approach based upon oxygen consumption rates. Washington, DC: Office of Research and Development. EPA/600/R-06/129F. <http://cfpub.epa.gov/ncea/cfm/recorddisplay.cfm?id=202543>.

<sup>1015</sup> Foos, B.; Marty, M.; Schwartz, J.; Bennet, W.; Moya, J.; Jarabek, A.M.; Salmon, A.G. (2008) Focusing on children's inhalation dosimetry and health effects for risk assessment: an introduction. *J Toxicol Environ Health* 71A: 149–165.

<sup>1016</sup> U.S. Environmental Protection Agency. (2005). Supplemental guidance for assessing susceptibility from early-life exposure to carcinogens. Washington, DC: Risk Assessment Forum. EPA/630/R-03/003F. [http://www3.epa.gov/raff/publications/pdfs/childrens\\_supplement\\_final.pdf](http://www3.epa.gov/raff/publications/pdfs/childrens_supplement_final.pdf).

Exposure at a young age to these carcinogens could lead to a higher risk of developing cancer later in life.

The adverse effects of individual air pollutants may be more severe for children, particularly the youngest age groups, than adults. The Integrated Science Assessments and Criteria Documents for a number of pollutants affected by these rules, including those for NO<sub>2</sub>, SO<sub>2</sub>, PM, ozone and CO, describe children as a group with greater susceptibility. Section VIII.A.8 discusses a number of childhood health outcomes associated with proximity to roadways, including evidence for exacerbation of asthma symptoms and suggestive evidence for new onset asthma. In general, these studies do not identify the specific contaminants associated with adverse effects, instead addressing the near-roadway environment as one containing numerous exposures potentially associated with adverse health effects.

There is substantial evidence that people who live or attend school near major roadways are more likely to be of a minority race, Hispanic ethnicity, and/or low SES. Within these highly exposed groups, children's exposure and susceptibility to health effects is greater than adults due to school-related and seasonal activities, behavior, and physiological factors.

Section VIII.C and NHTSA's FEIS describe the expected emissions reductions for non-GHG co-pollutants resulting from these standards. These emissions reductions will lead to reductions in ambient concentrations of PM<sub>2.5</sub>, ozone and other non-GHG co-pollutants. Children are not expected to experience greater ambient concentrations of air pollutants than the general population. However, because of their greater susceptibility to air pollution and their increased time spent outdoors, it is likely that these standards will have particular benefits for children's health.

#### *I. Executive Order 13211: Actions Concerning Regulations That Significantly Affect Energy Supply, Distribution, or Use*

This action is not a "significant energy action" because it is not likely to have a significant adverse effect on the supply, distribution or use of energy. In fact, these rules have a positive effect on energy supply and use. Because the combination of the fuel economy standards and the GHG emission standards will result in significant fuel savings, this action encourages more

[raff/publications/pdfs/childrens\\_supplement\\_final.pdf](http://www3.epa.gov/raff/publications/pdfs/childrens_supplement_final.pdf).

efficient use of fuels. Therefore, we have concluded that this action is not likely to have any adverse energy effects. Our energy effects analysis is described above in Section IX and NHTSA's FEIS.

#### *J. National Technology Transfer and Advancement Act and 1 CFR Part 51*

This action involves technical standards.

The agencies are using the following voluntary consensus standards from SAE International:

- SAE J1025 (August 2012) is a voluntary consensus standard describing how to determine a tire's characteristic value for revolutions per mile. This replaces the proposed approach in which we instructed manufacturers to determine and use tire diameter as an input for modeling vehicle emissions.

- SAE J1252 (July 2012) is a voluntary consensus standards that describes aerodynamic measurement procedures for wind tunnels. Heavy-duty vehicle testing already relies on these reference standards under 40 CFR part 1066.

- SAE J1263 (March 2010) and SAE J2263 (December 2008) are voluntary consensus standards that together establish a test protocol to determine road-load coefficients for properly testing vehicles on a chassis dynamometer to simulate in-use operating conditions. Heavy-duty vehicle testing already relies on these reference standards under 40 CFR part 1066.

- SAE J1594 (July 2010) is a voluntary consensus standards that describes vehicle aerodynamics terminology. Heavy-duty vehicle testing already relies on these reference standards under 40 CFR part 1066.

- SAE J1930 (October 2008) is a voluntary consensus standards that describes terms and abbreviations for engine and vehicle technologies. We are adopting an updated standard to reflect the current version.

- SAE J2071 (Revised June 1994) is a voluntary consensus standards that describes specifications for wind tunnels.

- SAE J2343 (July 2008). This voluntary consensus standard establishes a minimum hold time for LNG-fueled vehicles following a refueling event before the tank vents to relieve pressure. This is described further in Section XIII.A.3.

- SAE J2452 (June 1999) is a voluntary consensus standards that describes a procedure for measuring tire rolling resistance as part of a coastdown procedure.

- SAE J2966 (September 2013) is a voluntary consensus standards that

describes a protocol for using computational fluid dynamics to determine aerodynamic drag.

The regulations for the Phase 1 standards included a reference to SAE J1526 as a test procedure for measuring in-use fuel consumption. An updated version of SAE J1526 was adopted in September 2015. As noted in the proposed rule, we are revising the regulations to reference the updated version of SAE J1526. All SAE documents are available from the publisher's Web site at [www.sae.org](http://www.sae.org).

We are adopting a standard to facilitate measurement with Fourier transform infrared (FTIR) analyzers—ASTM D6348 (February 2012). We are also adopting an updated version of ASTM D4809–13, which specifies test methods for determining the heat of combustion of liquid hydrocarbon fuels for both Phase 1 and Phase 2 standards.

We are referencing a new supplement to ANSI NGV1, which we already use for defining system requirements for compressed natural gas vehicles. The supplement from the same publisher is known as CSA IR–1–15, “Compressed Natural Gas Vehicle (NGV) High Flow Fueling Connection Devices.” This document is available from the ANSI Web site at [www.ansi.org](http://www.ansi.org). The supplement will eventually be incorporated into ANSI NGV1, at which point we would no longer need to reference to CSA IR–1–15.

This action also involves technical standards for which there is no available voluntary consensus standard. First, the agencies are adopting greenhouse gas emission standards for heavy-duty vehicles that depend on computer modeling to predict an emission rate based on various engine and vehicle characteristics. Such a model is not available from other sources, so EPA has developed the Greenhouse Gas Emission Model as a simulation tool for demonstrating compliance with emission standards. See Section II for a detailed description of the model. A working version of this software is available for download at <http://www3.epa.gov/otaq/climate/gem.htm>.

Second, 40 CFR part 1037 includes several test procedures involving calculation with numerous physical quantities. We are incorporating by reference NIST Special Publication 811 to allow for standardization and consistency of units and nomenclature. This standard, which already applies for 40 CFR parts 1065 and 1066, is published by the National Institute of Standards and Technology (Department of Commerce) and is available at no charge at [www.nist.gov](http://www.nist.gov).

Third, the amendments for marine diesel engines involve technical standards related to the requirements that apply internationally. There are no voluntary consensus documents that address these technical standards. In earlier rulemakings, EPA has adopted an incorporation by reference for MARPOL Annex VI and the NO<sub>x</sub> Technical code in 40 CFR parts 1042 and 1043. The International Maritime Organization adopted changes to these documents in 2013 and 2014, which need to be reflected in 40 CFR parts 1042 and 1043. EPA recently adopted the updated reference documents in 40 CFR part 1043. As noted in Section XIV.H.4, this rule includes the remaining step of incorporating the updated IMO documents by reference in 40 CFR part 1042. All these documents are available at [www.imo.org](http://www.imo.org).

#### *K. Executive Order 12898: Federal Actions To Address Environmental Justice in Minority Populations and Low-Income Populations*

The agencies believe the human health or environmental risk addressed by this action will not have potential disproportionately high and adverse human health or environmental effects on minority, low-income or indigenous populations. The results of this evaluation are discussed below.

With respect to GHG emissions, the agencies have determined that these final rules will not have disproportionately high and adverse human health or environmental effects on minority, low-income or indigenous populations because they increase the level of environmental protection for all affected populations without having any disproportionately high and adverse human health or environmental effects on any population, including any minority, low-income or indigenous population. The reductions in CO<sub>2</sub> and other GHGs associated with the standards will affect climate change projections, and the agencies have estimated reductions in projected global mean surface temperatures (Section VII and NHTSA's FEIS). Within communities experiencing adverse impacts related to climate change, certain parts of the population may be especially vulnerable; these include the poor, the elderly, those already in poor health, the disabled, those living alone, and/or indigenous populations dependent on one or a few resources.<sup>1017</sup>

<sup>1017</sup> EPA 2009. Technical Support Document for Endangerment and Cause of Contribute Findings for Greenhouse Gases under section 202(a) of the Clean Air Act. Available at: <http://www3.epa.gov/>

For non-GHG co-pollutants such as ozone, PM<sub>2.5</sub>, and toxics, the agencies have concluded that it is not practicable to determine whether there will be disproportionately high and adverse human health or environmental effects on minority, low income and/or indigenous populations from these rules. As discussed in Section VIII and NHTSA's FEIS, however, based on the magnitude of the non-GHG co-pollutant emissions changes predicted to result from these standards, EPA and NHTSA expect that there will be improvements in ambient air quality that will likely help in mitigating the disparity in racial, ethnic, and economically-based exposures.

#### *L. Endangered Species Act (ESA)*

Section 7(a)(2) of the ESA requires federal agencies, in consultation with the National Oceanic and Atmospheric Administration Fisheries Service and/or the U.S. Fish and Wildlife Service (FWS), to ensure that actions they authorize, fund, or carry out are not likely to jeopardize the continued existence of federally listed endangered or threatened species or result in the destruction or adverse modification of designated critical habitat of such species. 16 U.S.C. 1536(a)(2). Under relevant implementing regulations, section 7(a)(2) applies only to actions where there is discretionary federal involvement or control. 50 CFR 402.03. Further, consultation is required only for actions that “may affect” listed species or critical habitat. 50 CFR 402.14. Consultation is not required where the action has no effect on such species or habitat. Under this standard, it is the federal agency taking the action that evaluates the action and determines whether consultation is required. See 51 FR 19926, 19949 (June 3, 1986). Effects of an action include both the direct and indirect effects that will be added to the environmental baseline. 50 CFR 402.02. Indirect effects are those that are caused by the action, later in time, and that are reasonably certain to occur. *Id.* To trigger a consultation requirement, there must be a causal connection between the federal action, the effect in question, and the listed species, and the effect must be reasonably certain to occur.

As discussed in this Preamble and the FEIS, the agencies note that the projected environmental effects of this rule are highly positive. However, the fact that the rule will have overall positive effects on the environment does not mean that the rule “may affect” any listed species or designated critical



habitat within the meaning of ESA section 7(a)(2) or the implementing regulations or require ESA consultation. We have carefully considered various types of potential environmental effects, including emissions of GHGs and non-GHGs, in reaching the conclusion that ESA consultation is not required for this rule.

With respect to the projected GHG emission reductions, we are mindful of significant legal and technical analysis undertaken by FWS and the U.S. Department of the Interior in the context of listing the polar bear as a threatened species under the ESA. In that context, in 2008, FWS and DOI expressed the view that the best scientific data available were insufficient to draw a causal connection between GHG emissions and effects on the species in its habitat.<sup>1018</sup> The DOI Solicitor concluded that where the effect at issue is climate change, actions involving GHG emissions cannot pass the “may affect” test of the section 7 regulations and thus are not subject to ESA consultation. Similarly, for this action, in the absence of a causal connection between the final rules and an effect to listed species or critical habitat that is reasonably certain to occur, no consultation is required.

The agencies have also previously considered issues relating to GHG emissions in connection with the requirements of ESA section 7(a)(2). Although the GHG emission reductions projected for this rule are large, EPA evaluated comparable or larger reductions in assessing this same issue in the context of the light duty vehicle GHG emission standards for model years 2012–2016 and 2017–2025. There the agency projected emission reductions comparable to, or greater than those projected here over the lifetimes of the model years in question and, based on air quality modeling of potential environmental effects, concluded that “EPA knows of no modeling tool which can link these small, time-attenuated changes in global metrics to particular effects on listed species in particular areas. Extrapolating from global metric to local effect with such small numbers, and accounting for further links in a causative chain, remain beyond current modeling capabilities.” EPA, *Light Duty Vehicle Greenhouse Gas Standards and Corporate Average Fuel Economy*

*Standards*, Response to Comment Document for Joint Rulemaking at 4–102 (Docket EPA–OAR–HQ–2009–4782). EPA reached this conclusion after evaluating issues relating to potential improvements relevant to both temperature and oceanographic pH outputs. EPA’s ultimate finding was that “any potential for a specific impact on listed species in their habitats associated with these very small changes in average global temperature and ocean pH is too remote to trigger the threshold for ESA section 7(a)(2).” *Id.* EPA and NHTSA believe that the same conclusion will apply to the present final rule, given that the projected CO<sub>2</sub> emission reductions are comparable to or less than those projected for either of the light duty vehicle rules. See Section VII.D.2 and Table VII–41 of this Preamble; *See also, e.g., Ground Zero Center for Non-Violent Action v. U.S. Dept. of Navy*, 383 F. 3d 1082, 1091–92 (9th Cir. 2004) (where the likelihood of jeopardy to a species from a federal action is extremely remote, ESA does not require consultation).

#### M. Congressional Review Act (CRA)

This action is subject to the CRA, and the agencies will submit a rule report to each House of the Congress and to the Comptroller General of the United States. This action is a “major rule” as defined by 5 U.S.C. 804(2).

### XV. EPA and NHTSA Statutory Authorities

As described below, the regulations being adopted are authorized separately for EPA and NHTSA under the agencies’ respective statutory authorities. See Section I for a discussion of these authorities.

#### A. EPA

Statutory authority for the vehicle controls is found in CAA section 202(a) (which authorizes standards for emissions of pollutants from new motor vehicles that emissions cause or contribute to air pollution which may reasonably be anticipated to endanger public health or welfare), and CAA sections 202(d), 203–209, 216, and 301 (42 U.S.C. 7521(a), 7521(d), 7522–7543, 7550, and 7601).

EPA makes certain proposed rules available to the Science Advisory Board (SAB), including rules subject to 42 U.S.C. 4365 and rules which are not, but which EPA believes should be made available to the SAB. EPA provided information to the SAB about this rulemaking and on June 11, 2014, the chartered SAB discussed the recommendations of its work group on the planned action and agreed that no

further SAB consideration of the rule or its supporting science was merited. We note further that the substantial NAS report to NHTSA and to Congress evaluating medium- and heavy-duty truck fuel efficiency improvement opportunities (see Section I.A.2 (g) above) would serve as a surrogate for SAB consultation. *See American Petroleum Inst. v. EPA*, 665 F. 2d 1176, 1189 (D.C. Cir. 1981).

#### B. NHTSA

Statutory authority for the fuel consumption standards is found in section 103 of the Energy Independence and Security Act of 2007, 49 U.S.C. 32902(k). EISA authorizes a fuel efficiency improvement program, designed to achieve the maximum feasible improvement to be created for commercial medium- and heavy-duty on-highway vehicles and work trucks, to implement appropriate test methods, measurement metrics, fuel economy standards, and compliance and enforcement protocols that are appropriate, cost-effective and technologically feasible. To the extent motor vehicle safety is implicated, NHTSA’s authority to regulate it is also derived from the National Traffic and Motor Vehicle Safety Act, 49 U.S.C. 30101 *et seq.*

### List of Subjects

#### 40 CFR Part 9

Reporting and recordkeeping requirements.

#### 40 CFR Part 22

Administrative practice and procedure, Air pollution control, Hazardous substances, Hazardous waste, Penalties, Pesticides and pests, Poison prevention, Water pollution control.

#### 40 CFR Part 85

Confidential business information, Imports, Labeling, Motor vehicle pollution, Reporting and recordkeeping requirements, Research, Warranties.

#### 40 CFR Part 86

Administrative practice and procedure, Confidential business information, Incorporation by reference, Labeling, Motor vehicle pollution, Reporting and recordkeeping requirements.

#### 40 CFR Part 600

Administrative practice and procedure, Electric power, Fuel economy, Incorporation by reference, Labeling, Reporting and recordkeeping requirements.

<sup>1018</sup> *See, e.g.,* 73 FR 28212, 28300 (May 15, 2008); 73 FR 76249 (Dec. 16, 2008); Memorandum from David Longly Bernhardt, Solicitor, U.S. Department of the Interior re: “Guidance on the Applicability of the Endangered Species Act’s Consultation Requirements to Proposed Actions Involving the Emission of Greenhouse Gases” (Oct. 3, 2008).



40 CFR Part 1033

Administrative practice and procedure, Air pollution control.

40 CFR Parts 1036 and 1037

Environmental protection, Administrative practice and procedure, Air pollution control, Confidential business information, Incorporation by reference, Labeling, Motor vehicle pollution, Reporting and recordkeeping requirements, Warranties.

40 CFR Part 1039

Environmental protection, Administrative practice and procedure, Air pollution control, Confidential business information, Imports, Labeling, Penalties, Reporting and recordkeeping requirements, Warranties.

40 CFR Part 1042

Environmental protection, Administrative practice and procedure, Air pollution control, Confidential business information, Imports, Incorporation by reference, Labeling, Penalties, Reporting and recordkeeping requirements, Vessels, Warranties.

40 CFR Part 1043

Environmental protection, Administrative practice and procedure, Air pollution control, Imports, Incorporation by reference, Vessels,

Reporting and recordkeeping requirements.

40 CFR Parts 1065 and 1066

Administrative practice and procedure, Air pollution control, Incorporation by reference, Reporting and recordkeeping requirements, Research.

40 CFR Part 1068

Administrative practice and procedure, Confidential business information, Imports, Incorporation by reference, Motor vehicle pollution, Penalties, Reporting and recordkeeping requirements, Warranties.

49 CFR Parts 523, 534, and 535

Fuel economy, Reporting and recordkeeping requirements.

49 CFR Part 538

Administrative practice and procedure, Fuel economy, Motor vehicles, Reporting and recordkeeping requirements.

For the reasons set out in the Preamble, title 40, chapter I of the Code of Federal Regulations is amended as set forth below.

**PART 9—OMB APPROVALS UNDER THE PAPERWORK REDUCTION ACT**

■ 1. The authority citation for part 9 continues to read as follows:

**Authority:** 7 U.S.C. 135 *et seq.*, 136–136y; 15 U.S.C. 2001, 2003, 2005, 2006, 2601–2671; 21 U.S.C. 331j, 346a, 31 U.S.C. 9701; 33 U.S.C. 1251 *et seq.*, 1311, 1313d, 1314, 1318, 1321, 1326, 1330, 1342, 1344, 1345(d) and (e), 1361; E.O. 11735, 38 FR 21243, 3 CFR, 1971–1975 Comp. p. 973; 42 U.S.C. 241, 242b, 243, 246, 300f, 300g, 300g–1, 300g–2, 300g–3, 300g–4, 300g–5, 300g–6, 300j–1, 300j–2, 300j–3, 300j–4, 300j–9, 1857 *et seq.*, 6901–6992k, 7401–7671q, 7542, 9601–9657, 11023, 11048.

- 2. In § 9.1 the table is amended by:
  - a. Adding in numerical order by CFR designation a new undesignated center heading “Control of Emissions from New and In-Use Heavy-Duty Highway Engines” and its entry in numerical order for “1036.825”;
  - b. Adding in numerical order by CFR designation a new undesignated center heading “Control of Emissions from New Heavy-Duty Motor Vehicles” and its entry in numerical order for “1037.825”; and
  - c. Adding in numerical order by CFR designation a new undesignated center heading “Control of NO<sub>x</sub> SO<sub>x</sub>, and PM Emissions from Marine Engines and Vessels Subject to the MARPOL Protocol” and its entries in numerical order for “1043.40–1043.95”.

The additions read as follows:

**§ 9.1 OMB approvals under the Paperwork Reduction Act.**

\* \* \* \* \*

40 CFR citation	OMB control No.
* * * * *	* * * * *
<b>Control of Emissions From New and In-Use Heavy-Duty Highway Engines</b>	
1036.825 .....	2060–0678
<b>Control of Emissions From New Heavy-Duty Motor Vehicles</b>	
1037.825 .....	2060–0678
* * * * *	* * * * *
<b>Control of NO<sub>x</sub>, SO<sub>x</sub>, and PM Emissions From Marine Engines and Vessels Subject to the Marpol Protocol</b>	
1043.40–1043.95 .....	2060–0641
* * * * *	* * * * *

\* \* \* \* \*

**PART 22—CONSOLIDATED RULES OF PRACTICE GOVERNING THE ADMINISTRATIVE ASSESSMENT OF CIVIL PENALTIES AND THE REVOCATION/TERMINATION OR SUSPENSION OF PERMITS**

■ 3. The authority citation for part 22 continues to read as follows:

**Authority:** 7 U.S.C. 136(l); 15 U.S.C. 2615; 33 U.S.C. 1319, 1342, 1361, 1415 and 1418; 42 U.S.C. 300g–3(g), 6912, 6925, 6928, 6991e and 6992d; 42 U.S.C. 7413(d), 7524(c), 7545(d), 7547, 7601 and 7607(a), 9609, and 11045.

**Subpart A—General**

■ 4. Section 22.1 is amended by revising paragraph (a)(2) to read as follows:

**§ 22.1 Scope of this part.**

- (a) \* \* \*
- (2) The assessment of any administrative civil penalty under sections 113(d), 205(c), 211(d) and 213(d) of the Clean Air Act, as amended (42 U.S.C. 7413(d), 7524(c), 7545(d) and 7547(d)), and a determination of nonconforming engines, vehicles or equipment under sections 207(c) and

213(d) of the Clean Air Act, as amended (42 U.S.C. 7541(c) and 7547(d));

\* \* \* \* \*

### Subpart C—Prehearing Procedures

■ 5. Section 22.34 is revised to read as follows:

#### § 22.34 Supplemental rules governing the administrative assessment of civil penalties under the Clean Air Act.

(a) *Scope.* This section shall apply, in conjunction with §§ 22.1 through 22.32, in administrative proceedings to assess a civil penalty conducted under sections 113(d), 205(c), 211(d), and 213(d) of the Clean Air Act, as amended (42 U.S.C. 7413(d), 7524(c), 7545(d), and 7547(d)), and a determination of nonconforming engines, vehicles or equipment under sections 207(c) and 213(d) of the Clean Air Act, as amended (42 U.S.C. 7541(c) and 7547(d)). Where inconsistencies exist between this section and §§ 22.1 through 22.32, this section shall apply.

(b) *Issuance of notice.* Prior to the issuance of a final order assessing a civil penalty or a final determination of nonconforming engines, vehicles or equipment, the person to whom the order or determination is to be issued shall be given written notice of the proposed issuance of the order or determination. Service of a complaint or a consent agreement and final order pursuant to § 22.13 satisfies these notice requirements.

### PART 85—CONTROL OF AIR POLLUTION FROM MOBILE SOURCES

■ 6. The authority citation for part 85 continues to read as follows:

**Authority:** 42 U.S.C. 7401–7671q.

#### Subpart F—Exemption of Clean Alternative Fuel Conversions from Tampering Prohibition

■ 7. Section 85.525 is revised to read as follows:

##### § 85.525 Applicable standards.

To qualify for an exemption from the tampering prohibition, vehicles/engines that have been converted to operate on a different fuel must meet emission standards and related requirements as described in this section. The modified vehicle/engine must meet the requirements that applied for the OEM vehicle/engine, or the most stringent OEM vehicle/engine standards in any allowable grouping. Fleet average standards do not apply unless clean alternative fuel conversions are specifically listed as subject to the standards.

(a) If the vehicle/engine was certified with a Family Emission Limit for NO<sub>x</sub>, NO<sub>x</sub>+HC, NO<sub>x</sub>+NMOG, or particulate matter, as noted on the vehicle/engine emission control information label, the modified vehicle/engine may not exceed this Family Emission Limit.

(b) Compliance with greenhouse gas emission standards is demonstrated as follows:

(1) Subject to the following exceptions and special provisions, compliance with light-duty vehicle greenhouse gas emission standards is demonstrated by complying with the N<sub>2</sub>O and CH<sub>4</sub> standards and provisions set forth in 40 CFR 86.1818–12(f)(1) and the in-use CO<sub>2</sub> exhaust emission standard set forth in 40 CFR 86.1818–12(d) as determined by the OEM for the subconfiguration that is identical to the fuel conversion emission data vehicle (EDV):

(i) If the OEM complied with the light-duty greenhouse gas standards using the fleet averaging option for N<sub>2</sub>O and CH<sub>4</sub>, as allowed under 40 CFR 86.1818–12(f)(2), the calculations of the carbon-related exhaust emissions require the input of grams/mile values for N<sub>2</sub>O and CH<sub>4</sub>, and you are not required to demonstrate compliance with the standalone CH<sub>4</sub> and N<sub>2</sub>O standards.

(ii) If the OEM complied with alternate standards for N<sub>2</sub>O and/or CH<sub>4</sub>, as allowed under 40 CFR 86.1818–12(f)(3), you may demonstrate compliance with the same alternate standards.

(iii) If the OEM complied with the nitrous oxide (N<sub>2</sub>O) and methane (CH<sub>4</sub>) standards and provisions set forth in 40 CFR 86.1818–12(f)(1) or (3), and the fuel conversion CO<sub>2</sub> measured value is lower than the in-use CO<sub>2</sub> exhaust emission standard, you also have the option to convert the difference between the in-use CO<sub>2</sub> exhaust emission standard and the fuel conversion CO<sub>2</sub> measured value into GHG equivalents of CH<sub>4</sub> and/or N<sub>2</sub>O, using 298 g CO<sub>2</sub> to represent 1 g N<sub>2</sub>O and 25 g CO<sub>2</sub> to represent 1 g CH<sub>4</sub>. You may then subtract the applicable converted values from the fuel conversion measured values of CH<sub>4</sub> and/or N<sub>2</sub>O to demonstrate compliance with the CH<sub>4</sub> and/or N<sub>2</sub>O standards.

(iv) Optionally, compliance with greenhouse gas emission requirements may be demonstrated by comparing emissions from the vehicle prior to the fuel conversion to the emissions after the fuel conversion. This comparison must be based on FTP test results from the emission data vehicle (EDV) representing the pre-conversion test group. The sum of CO<sub>2</sub>, CH<sub>4</sub>, and N<sub>2</sub>O shall be calculated for pre- and post-conversion FTP test results, where CH<sub>4</sub>

and N<sub>2</sub>O are weighted by their global warming potentials of 25 and 298, respectively. The post-conversion sum of these emissions must be lower than the pre-conversion conversion greenhouse gas emission results. CO<sub>2</sub> emissions are calculated as specified in 40 CFR 600.113–12. If statements of compliance are applicable and accepted in lieu of measuring N<sub>2</sub>O, as permitted by EPA regulation, the comparison of the greenhouse gas results also need not measure or include N<sub>2</sub>O in the before and after emission comparisons.

(2) Compliance with heavy-duty engine greenhouse gas emission standards is demonstrated by complying with the CO<sub>2</sub>, N<sub>2</sub>O, and CH<sub>4</sub> standards (or FELs, as applicable) and provisions set forth in 40 CFR 1036.108 for the engine family that is represented by the fuel conversion emission data engine (EDE). The following additional provisions apply:

(i) If the fuel conversion CO<sub>2</sub> measured value is lower than the CO<sub>2</sub> standard (or FEL, as applicable), you have the option to convert the difference between the CO<sub>2</sub> standard (or FEL, as applicable) and the fuel conversion CO<sub>2</sub> measured value into GHG equivalents of CH<sub>4</sub> and/or N<sub>2</sub>O, using 298 g/hp-hr CO<sub>2</sub> to represent 1 g/hp-hr N<sub>2</sub>O. Similarly, you may use 34 g/hp-hr CO<sub>2</sub> to represent 1 g/hp-hr CH<sub>4</sub> for model year 2021 and later engines, and you may use 25 g/hp-hr CO<sub>2</sub> to represent 1 g/hp-hr CH<sub>4</sub> for earlier engines. You may then subtract the applicable converted values from the fuel conversion measured values of CH<sub>4</sub> and/or N<sub>2</sub>O to demonstrate compliance with the CH<sub>4</sub> and/or N<sub>2</sub>O standards (or FEL, as applicable).

(ii) Small volume conversion manufacturers may demonstrate compliance with N<sub>2</sub>O standards based on an engineering analysis.

(iii) For conversions of engines installed in vocational vehicles subject to Phase 2 standards under 40 CFR 1037.105 or in tractors subject to Phase 2 standards under 40 CFR 1037.106, conversion manufacturers may omit a demonstration related to the vehicle-based standards, as long as they have a reasonable technical basis for believing that the modified vehicle continues to meet those standards.

(3) Subject to the following exceptions and special provisions, compliance with greenhouse gas emission standards for heavy-duty vehicles subject to 40 CFR 86.1819 is demonstrated by complying with the N<sub>2</sub>O and CH<sub>4</sub> standards and provisions set forth in 40 CFR 86.1819 and the in-use CO<sub>2</sub> exhaust emission standard set forth in 40 CFR 86.1819–14(b) as determined by the OEM for the

subconfiguration that is identical to the fuel conversion emission data vehicle (EDV):

(i) If the OEM complied with alternate standards for N<sub>2</sub>O and/or CH<sub>4</sub>, as allowed under 40 CFR 86.1819–14(c) you may demonstrate compliance with the same alternate standards.

(ii) If you are unable to meet either the N<sub>2</sub>O or CH<sub>4</sub> standards and your fuel conversion CO<sub>2</sub> measured value is lower than the in-use CO<sub>2</sub> exhaust emission standard, you may also convert the difference between the in-use CO<sub>2</sub> exhaust emission standard and the fuel conversion CO<sub>2</sub> measured value into GHG equivalents of CH<sub>4</sub> and/or N<sub>2</sub>O, using 298 g CO<sub>2</sub> to represent 1 g N<sub>2</sub>O. Similarly, you may use 34 g CO<sub>2</sub> to represent 1 g CH<sub>4</sub> for model year 2021 and later vehicles, and you may use 25 g CO<sub>2</sub> to represent 1 g CH<sub>4</sub> for earlier vehicles. You may then subtract the applicable converted values from the fuel conversion measured values of CH<sub>4</sub> and/or N<sub>2</sub>O to demonstrate compliance with the CH<sub>4</sub> and/or N<sub>2</sub>O standards.

(iii) You may alternatively comply with the greenhouse gas emission requirements by comparing emissions from the vehicle before and after the fuel conversion. This comparison must be based on FTP test results from the emission data vehicle (EDV) representing the pre-conversion test group. The sum of CO<sub>2</sub>, CH<sub>4</sub>, and N<sub>2</sub>O shall be calculated for pre- and post-conversion FTP test results, where CH<sub>4</sub> and N<sub>2</sub>O are weighted by their global warming potentials as described in paragraph (b)(3)(ii) of this section. The post-conversion sum of these emissions must be lower than the pre-conversion greenhouse gas emission result. Calculate CO<sub>2</sub> emissions as specified in 40 CFR 600.113. If we waive N<sub>2</sub>O measurement requirements based on a statement of compliance, disregard N<sub>2</sub>O for all measurements and calculations under this paragraph (b)(3)(iii).

(c) Conversion systems for engines that would have qualified for chassis certification at the time of OEM certification may use those procedures, even if the OEM did not. Conversion manufacturers choosing this option must designate test groups using the appropriate criteria as described in this subpart and meet all vehicle chassis certification requirements set forth in 40 CFR part 86, subpart S.

#### Subpart O—Urban Bus Rebuild Requirements

■ 8. Section 85.1406 is amended by revising paragraph (f)(2) to read as follows:

#### § 85.1406 Certification.

\* \* \* \* \*

(f) \* \* \*

(2) If the equipment certifier disagrees with such determination of nonconformity and so advises the Agency, the Administrator shall afford the equipment certifier and other interested persons an opportunity to present their views and evidence in support thereof at a public hearing conducted in accordance with procedures found in 40 CFR part 1068, subpart G.

#### Subpart P—Importation of Motor Vehicles and Motor Vehicle Engines

■ 9. Section 85.1508 is amended by revising paragraph (c) to read as follows:

#### § 85.1508 “In Use” inspections and recall requirements.

\* \* \* \* \*

(c) A certificate holder will be notified whenever the Administrator has determined that a substantial number of a class or category of the certificate holder's vehicles or engines, although properly maintained and used, do not conform to the regulations prescribed under section 202 when in actual use throughout their useful lives (as determined under section 202(d)). After such notification, the Recall Regulations at 40 CFR part 1068, subpart G, shall govern the certificate holder's responsibilities and references to a manufacturer in the Recall Regulations shall apply to the certificate holder.

■ 10. Section 85.1513 is amended by revising paragraph (e)(4) to read as follows:

#### § 85.1513 Prohibited acts; penalties.

\* \* \* \* \*

(e) \* \* \*

(4) Hearings on suspensions and revocations of certificates of conformity or of eligibility to perform modification/testing under § 85.1509 shall be held in accordance with 40 CFR part 1068, subpart G.

\* \* \* \* \*

#### Subpart R—Exclusion and Exemption of Motor Vehicles and Motor Vehicle Engines

■ 11. Section 85.1701 is amended by revising paragraph (a)(1) to read as follows:

#### § 85.1701 General applicability.

(a) \* \* \*

(1) Beginning January 1, 2014, the exemption provisions of 40 CFR part 1068, subpart C, apply instead of the provisions of this subpart for heavy-duty motor vehicle engines regulated

under 40 CFR part 86, subpart A, except that the nonroad competition exemption of 40 CFR 1068.235 and the nonroad hardship exemption provisions of 40 CFR 1068.245, 1068.250, and 1068.255 do not apply for motor vehicle engines.

\* \* \* \* \*

■ 12. Section 85.1703 is amended by adding paragraph (b) to read as follows:

#### § 85.1703 Definition of motor vehicle.

\* \* \* \* \*

(b) Note that, in applying the criterion in paragraph (a)(2) of this section, vehicles that are clearly intended for operation on highways are motor vehicles. Absence of a particular safety feature is relevant only when absence of that feature would prevent operation on highways.

■ 13. Section 85.1706 is amended by revising paragraph (b) to read as follows:

#### § 85.1706 Pre-certification exemption.

\* \* \* \* \*

(b) Any manufacturer that desires a pre-certification exemption and is in the business of importing, modifying or testing uncertified vehicles for resale under the provisions of 40 CFR 85.1501 through 85.1515, must send the request to the Designated Compliance Officer as specified in 40 CFR 1068.30. The Designated Compliance Officer may require such manufacturers to submit information regarding the general nature of the fleet activities, the number of vehicles involved, and a demonstration that adequate record-keeping procedures for control purposes will be employed.

■ 14. Section 85.1711 is revised to read as follows:

#### § 85.1711 Submission of exemption requests.

Requests for exemption or further information concerning exemptions and/or the exemption request review procedure should be addressed to the Designated Compliance Officer as specified at 40 CFR 1068.30.

#### §§ 85.1713 and 85.1714 [Removed]

■ 15. Remove and reserve §§ 85.1713 and 85.1714.

#### Subpart T—Emission Defect Reporting Requirements

■ 16. Section 85.1901 is revised to read as follows:

#### § 85.1901 Applicability.

(a) The requirements of this subpart shall be applicable to all 1972 and later model year motor vehicles and motor vehicle engines, except that the provisions of 40 CFR 1068.501 apply

instead for heavy-duty motor vehicle engines certified under 40 CFR part 86, subpart A, and for heavy-duty motor vehicles certified under 40 CFR part 1037 starting January 1, 2018.

(b) The requirement to report emission-related defects affecting a given class or category of vehicles or engines shall remain applicable for five years from the end of the model year in which such vehicles or engines were manufactured.

■ 17. Section 85.1902 is revised to read as follows:

**§ 85.1902 Definitions.**

For the purposes of this subpart and unless otherwise noted:

(a) *Act* means the Clean Air Act, 42 U.S.C. 7401–7671q, as amended.

(b) *Emission-related defect* means:

(1) A defect in design, materials, or workmanship in a device, system, or assembly described in the approved Application for Certification that affects any parameter or specification enumerated in appendix VIII of this part; or

(2) A defect in the design, materials, or workmanship in one or more emission-related parts, components, systems, software or elements of design which must function properly to ensure continued compliance with emission standards.

(c) *Useful life* has the meaning given in section 202(d) of the Act (42 U.S.C. 7521(d)) and regulations promulgated thereunder.

(d) *Voluntary emissions recall* means a repair, adjustment, or modification program voluntarily initiated and conducted by a manufacturer to remedy any emission-related defect for which direct notification of vehicle or engine owners has been provided, including programs to remedy defects related to emissions standards for CO<sub>2</sub>, CH<sub>4</sub>, N<sub>2</sub>O, and/or carbon-related exhaust emissions.

(e) *Ultimate purchaser* has the meaning given in section 216 of the Act (42 U.S.C. 7550).

(f) *Manufacturer* has the meaning given in section 216 of the Act (42 U.S.C. 7550).

■ 18. Section 85.1906 is amended by revising paragraph (a) to read as follows:

**§ 85.1906 Report filing; Record retention.**

(a) The reports required by §§ 85.1903 and 85.1904 shall be sent to the Designated Compliance Officer as specified at 40 CFR 1068.30.

\* \* \* \* \*

**Subpart V—Emissions Control System Performance Warranty Regulations and Voluntary Aftermarket Part Certification Program**

■ 19. Section 85.2109 is amended by revising paragraph (a)(6) to read as follows:

**§ 85.2109 Inclusion of warranty provisions in owners' manuals and warranty booklets.**

(a) \* \* \*

(6) An explanation that an owner may obtain further information concerning the emission performance warranty or that an owner may report violations of the terms of the Emission Performance Warranty by contacting the Designated Compliance Officer as specified at 40 CFR 1068.30 (Attention: Warranty Claim).

\* \* \* \* \*

■ 20. Section 85.2110 is amended by revising paragraph (b) to read as follows:

**§ 85.2110 Submission of owners' manuals and warranty statements to EPA.**

\* \* \* \* \*

(b) All materials described in paragraph (a) of this section shall be sent to the Designated Compliance Officer as specified at 40 CFR 1068.30 (Attention: Warranty Booklet).

**PART 86 —CONTROL OF EMISSIONS FROM NEW AND IN-USE HIGHWAY VEHICLES AND ENGINES**

■ 21. The authority citation for part 86 continues to read as follows:

**Authority:** 42 U.S.C. 7401–7671q.

■ 22. Section 86.1 is amended by adding paragraph (c)(2), revising paragraph (g)(4), and removing and reserving paragraph (g)(5).

The addition and revision read as follows:

**§ 86.1 Incorporation by reference.**

\* \* \* \* \*

(c) \* \* \*

(2) CSA IR–1–15, Compressed Natural Gas Vehicle (NGV) High Flow Fueling Connection Devices—Supplement to NGV 1–2006, ANSI approved August 26, 2015, IBR approved for § 86.1813–17(f),

\* \* \* \* \*

(g) \* \* \*

(4) SAE J1877, Recommended Practice for Bar-Coded Vehicle Identification Number Label, July 1994, IBR approved for § 86.1807–01(f).

(5) [Reserved]

\* \* \* \* \*

■ 23. Revise the heading of subpart A to read as follows:

**Subpart A—General Provisions for Heavy-Duty Engines and Heavy-Duty Vehicles**

**§ 86.001–35 [Removed]**

■ 24. Remove § 86.001–35.

■ 25. Section 86.004–2 is amended by revising the definition of “Emergency vehicle” to read as follows:

**§ 86.004–2 Definitions.**

\* \* \* \* \*

*Emergency vehicle* has the meaning given in 40 CFR 1037.801.

\* \* \* \* \*

■ 26. Section 86.004–25 is amended as follows:

■ a. By revising the introductory text and paragraph (b)(3)(iii)(A).

■ b. By removing paragraph (b)(3)(vi).

■ c. By revising paragraphs (b)(4)(i), (b)(4)(iii)(D), (b)(4)(iii)(F), and (b)(6)(i)(E).

■ d. By adding paragraph (i).

The addition and revisions read as follows:

**§ 86.004–25 Maintenance.**

Section 86.004–25 includes text that specifies requirements that differ from § 86.094–25. Where a paragraph in § 86.094–25 is applicable to § 86.004–25, this may be indicated by specifying the corresponding paragraph and the statement “[Reserved]. For guidance see § 86.094–25.”

\* \* \* \* \*

(b) \* \* \*

(3) \* \* \*

(iii) \* \* \*

(A) Crankcase ventilation valves and filters.

\* \* \* \* \*

(4) \* \* \*

(i) For diesel-cycle heavy-duty engines, the adjustment, cleaning, repair, or replacement of the following items shall occur at 50,000 miles (or 1,500 hours) of use and at 50,000-mile (or 1,500-hour) intervals thereafter:

(A) Exhaust gas recirculation system related filters and coolers.

(B) Crankcase ventilation valves and filters.

(C) Fuel injector tips (cleaning only).

(D) DEF filters.

\* \* \* \* \*

(iii) \* \* \*

(D) Particulate trap or trap oxidizer systems including related components (adjustment and cleaning only for filter element, replacement of the filter element is not allowed during the useful life).

\* \* \* \* \*

(F) Catalytic converter (adjustment and cleaning only for catalyst beds,

replacement of the bed is not allowed during the useful life).

\* \* \* \* \*

(6)(i) \* \* \*

(E) Crankcase ventilation valves and filters.

\* \* \* \* \*

(i) Notwithstanding the provisions of paragraph (b)(4) and (6) of this section, manufacturers may schedule replacement or repair of particulate trap (or trap oxidizer) systems or catalytic converters (including NO<sub>x</sub> adsorbers), provided that the manufacturer demonstrates to the Administrator's satisfaction that the repair or replacement will be performed according to the schedule and the manufacturer pays for the repair or replacement.

■ 27. Section 86.004–28 is amended by revising paragraph (i) introductory text and adding paragraph (j) to read as follows:

**§ 86.004–28 Compliance with emission standards.**

\* \* \* \* \*

(i) This paragraph (i) describes how to adjust emission results from model year 2020 and earlier heavy-duty engines equipped with exhaust aftertreatment to account for regeneration events. This provision only applies for engines equipped with emission controls that are regenerated on an infrequent basis. For the purpose of this paragraph (i), the term “regeneration” means an event during which emission levels change while the aftertreatment performance is being restored by design. Examples of regenerations are increasing exhaust gas temperature to remove sulfur from an adsorber or increasing exhaust gas temperature to oxidize PM in a trap. For the purpose of this paragraph (i), the term “infrequent” means having an expected frequency of less than once per transient test cycle. Calculation and use of adjustment factors are described in paragraphs (i)(1) through (5) of this section. If your engine family includes engines with one or more AECs for emergency vehicle applications approved under paragraph (4) of the definition of defeat device in § 86.004–2, do not consider additional regenerations resulting from those AECs when calculating emission factors or frequencies under this paragraph (i).

\* \* \* \* \*

(j) For model year 2021 and later engines using aftertreatment technology with infrequent regeneration events that may occur during testing, take one of the following approaches to account for the emission impact of regeneration:

(1) You may use the calculation methodology described in 40 CFR 1065.680 to adjust measured emission results. Do this by developing an upward adjustment factor and a downward adjustment factor for each pollutant based on measured emission data and observed regeneration frequency as follows:

(i) Adjustment factors should generally apply to an entire engine family, but you may develop separate adjustment factors for different configurations within an engine family. Use the adjustment factors from this section for all testing for the engine family.

(ii) You may use carryover or carry-across data to establish adjustment factors for an engine family as described in § 86.001–24(f), consistent with good engineering judgment.

(iii) Identify the value of *F* in each application for the certification for which it applies.

(2) You may ask us to approve an alternate methodology to account for regeneration events. We will generally limit approval to cases where your engines use aftertreatment technology with extremely infrequent regeneration and you are unable to apply the provisions of this section.

(3) You may choose to make no adjustments to measured emission results if you determine that regeneration does not significantly affect emission levels for an engine family (or configuration) or if it is not practical to identify when regeneration occurs. If you choose not to make adjustments under paragraph (j)(1) or (2) of this section, your engines must meet emission standards for all testing, without regard to regeneration.

**§ 86.004–30 [Removed]**

■ 28. Remove § 86.004–30.

■ 29. Section 86.007–11 is amended by ■ a. Revising the introductory text and paragraphs (a)(1)(ii) and (iii), (2)(ii), and (g).

■ b. Adding and reserving paragraph (i).

■ c. Adding paragraph (j).

The revisions and addition read as follows:

**§ 86.007–11 Emission standards and supplemental requirements for 2007 and later model year diesel heavy-duty engines and vehicles.**

This section applies to new 2007 and later model year diesel heavy-duty engines and vehicles. Starting in model year 2021, this section also applies to all heavy HDE, regardless of fuel or combustion cycle (see 40 CFR 1036.140(a) and 1036.150(c)). Section 86.007–11 includes text that specifies

requirements that differ from § 86.004–11. Where a paragraph in § 86.004–11 is identical and applicable to § 86.007–11, this may be indicated by specifying the corresponding paragraph and the statement “[Reserved]. For guidance see § 86.004–11.”

(a)(1) \* \* \*

(ii)(A) *Nonmethane hydrocarbon (NMHC) for engines fueled with diesel fuel.* 0.14 grams per brake horsepower-hour (0.052 grams per megajoule).

(B) *Nonmethane-nonethane hydrocarbon (NMNEHC) for engines fueled with natural gas or liquefied petroleum gas.* 0.14 grams per brake horsepower-hour (0.052 grams per megajoule).

(C) *Nonmethane hydrocarbon equivalent (NMHCE) for engines fueled with methanol.* 0.14 grams per brake horsepower-hour (0.052 grams per megajoule).

(iii) *Carbon monoxide.* 15.5 grams per brake horsepower-hour (5.77 grams per megajoule).

\* \* \* \* \*

(2) \* \* \*

(ii) Shut down the engine after completing the test interval and allow 20±1 minutes to elapse. This is the hot soak.

\* \* \* \* \*

(g) Model year 2018 and later engines at or above 56 kW that will be installed in specialty vehicles as allowed by 40 CFR 1037.605 may meet alternate emission standards as follows:

(1) The engines must be of a configuration that is identical to one that is certified under 40 CFR part 1039, and meet the following additional standards using the same duty cycles that apply under 40 CFR part 1039:

(i) The engines must be certified with a Family Emission Limit for PM of 0.020 g/kW-hr.

(ii) Diesel-fueled engines using selective catalytic reduction must meet an emission standard of 0.1 g/kW-hr for N<sub>2</sub>O.

(2) Except as specified in this paragraph (g), engines certified under this paragraph (g) must meet all the requirements that apply under 40 CFR part 1039 instead of the comparable provisions in this subpart A. Before shipping engines under this section, you must have written assurance from the vehicle manufacturers that they need a certain number of exempted engines under this section. In your annual production report under 40 CFR 1039.250, count these engines separately and identify the vehicle manufacturers that will be installing them. Treat these engines as part of the corresponding engine family under 40

CFR part 1039 for compliance purposes such as selective enforcement audits, in-use testing, defect reporting, and recall.

(3) The engines must be labeled as described in § 86.095–35, with the following statement instead of the one specified in § 86.095–35(a)(3)(iii)(H): “This engine conforms to alternate standards for specialty vehicles under 40 CFR 86.007–11(g)”. Engines certified under this paragraph (g) may not have the label specified for nonroad engines in 40 CFR part 1039 or any other label identifying them as nonroad engines.

(4) In a separate application for a certificate of conformity, identify the corresponding nonroad engine family, describe the label required under this paragraph (g), state that you meet applicable diagnostic requirements under 40 CFR part 1039, and identify your projected U.S.-directed production volume.

(5) No additional certification fee applies for engines certified under this paragraph (g).

(6) Engines certified under this paragraph (g) may not generate or use emission credits under this part or under 40 CFR part 1039. The vehicles in which these engines are installed may generate or use emission credits as described in 40 CFR part 1037.

(7) Engines may instead meet standards for heavy-duty highway engines in California, as demonstrated by an Executive Order issued by the California Air Resources Board.

\* \* \* \* \*

(i) [Reserved]

(j) Engines installed in new glider vehicles are subject to the standards of this section as specified in 40 CFR part 1037.

**§ 86.007–25 [Removed]**

■ 30. Remove § 86.007–25.

**§ 86.007–30 [Amended]**

■ 31. Section 86.007–30 is amended by removing and reserving paragraph (d).

**§ 86.007–35 [Removed]**

■ 32. Remove § 86.007–35.

■ 33. Section 86.008–10 is amended by:

- a. Adding introductory text.
- b. Revising paragraphs (a)(1)(ii) and (iii);
- c. Removing and reserving paragraph (f); and
- d. Revising paragraph (g).

The revisions read as follows:

**§ 86.008–10 Emission standards for 2008 and later model year Otto-cycle heavy-duty engines and vehicles.**

This section applies to new 2008 and later model year Otto-cycle heavy-duty engines and vehicles. Starting in model

year 2021, this section applies to light HDE and medium HDE, but it no longer applies to heavy HDE (see 40 CFR 1036.140(a) and 1036.150(c)).

(a)(1) \* \* \*

(ii)(A) *Nonmethane hydrocarbon (NMHC) for engines fueled with gasoline.* 0.14 grams per brake horsepower-hour (0.052 grams per megajoule).

(B) *Nonmethane-nonethane hydrocarbon (NMNEHC) for engines fueled with natural gas or liquefied petroleum gas.* 0.14 grams per brake horsepower-hour (0.052 grams per megajoule).

(C) *Nonmethane hydrocarbon equivalent (NMHCE) for engines fueled with methanol.* 0.14 grams per brake horsepower-hour (0.052 grams per megajoule).

(D) A manufacturer may elect to include any or all of its Otto-cycle HDE families in any or all of the hydrocarbon emission ABT programs for HDEs, within the restrictions described in § 86.007–15 or § 86.004–15. If the manufacturer elects to include engine families in any of these programs, the hydrocarbon FEL may not exceed 0.30 grams per brake horsepower-hour. This ceiling value applies whether credits for the family are derived from averaging, banking, or trading programs. The hydrocarbon FEL cap is 0.40 for model years before 2011 for manufacturers choosing to certify to the 1.5 g/bhp-hr NO<sub>x</sub> + HC in 2004, as allowed in § 86.005–10.

(iii) Carbon monoxide. 14.4 grams per brake horsepower-hour (5.36 grams per megajoule).

\* \* \* \* \*

(f) [Reserved]

(g) Model year 2018 and later engines that will be installed in specialty vehicles as allowed by 40 CFR 1037.605 may meet alternate emission standards as follows:

(1) The engines must be of a configuration that is identical to one that is certified under 40 CFR part 1048 to the Blue Sky standards under 40 CFR 1048.140.

(2) Except as specified in this paragraph (g), engines certified under this paragraph (g) must meet all the requirements that apply under 40 CFR part 1048 instead of the comparable provisions in this subpart A. Before shipping engines under this section, you must have written assurance from the vehicle manufacturers that they need a certain number of exempted engines under this section. In your annual production report under 40 CFR 1048.250, count these engines separately and identify the vehicle

manufacturers that will be installing them. Treat these engines as part of the corresponding engine family under 40 CFR part 1048 for compliance purposes such as testing production engines, in-use testing, defect reporting, and recall.

(3) The engines must be labeled as described in § 86.095–35, with the following statement instead of the one specified in § 86.095–35(a)(3)(iii)(H): “This engine conforms to alternate standards for specialty vehicles under 40 CFR 86.008–10(g)”. Engines certified under this paragraph (g) may not have the label specified for nonroad engines in 40 CFR part 1048 or any other label identifying them as nonroad engines.

(4) In a separate application for a certificate of conformity, identify the corresponding nonroad engine family, describe the label required under this paragraph (g), state that you meet applicable diagnostic requirements under 40 CFR part 1048, and identify your projected U.S.-directed production volume.

(5) No additional certification fee applies for engines certified under this paragraph (g).

(6) Engines certified under this paragraph (g) may not generate or use emission credits under this part. The vehicles in which these engines are installed may generate or use emission credits as described in 40 CFR part 1037.

(7) Engines may instead meet standards for heavy-duty highway engines in California, as demonstrated by an Executive Order issued by the California Air Resources Board.

■ 34. Section 86.016–1 is amended by revising paragraphs (a)(1) and (2) to read as follows:

**§ 86.016–1 General applicability.**

(a) \* \* \*

(1) The provisions of this subpart related to exhaust emission standards apply for diesel-cycle and Otto-cycle heavy-duty engines installed in vehicles above 14,000 pounds GVWR; however, these vehicles may instead be certified under subpart S of this part in certain circumstances as specified in § 86.1801.

(2) The provisions of this subpart related to exhaust emission standards apply for engines that will be installed in incomplete heavy-duty vehicles at or below 14,000 pounds GVWR; however, these vehicles may instead be certified under subpart S of this part as specified in § 86.1801.

\* \* \* \* \*

■ 35. Section 86.078–6 is revised to read as follows:

**§ 86.078–6 Hearings on certification.**

If a manufacturer's request for a hearing is approved, EPA will follow the hearing procedures specified in 40 CFR part 1068, subpart G.

■ 36. Section 86.084–4 is revised to read as follows:

**§ 86.084–4 Section numbering; construction.**

(a) The model year of initial applicability is indicated by the last two digits of the 5-digit group. A section remains in effect for subsequent model years until it is superseded. The number following the hyphen designates what previous section is replaced by a future regulation. For example, § 86.005–1 applies to model year 2005 and later vehicles and engines until it is superseded. Section 86.016–1 takes effect with model year 2016 and continues to apply until it is superseded; § 86.005–1 no longer applies starting with model year 2016, except as specified by § 86.016–1.

(b) If a regulation in this subpart references a section that has been superseded or no longer exists, this should be understood as a reference to the same section for the appropriate model year. For example, if a regulation in this subpart refers to § 86.001–30, it should be taken as a reference to § 86.007–30 or any later version of that section that applies for the appropriate model year. However, this does not apply if the reference to a superseded section specifically states that the older provision applies instead of any updated provisions from the section in effect for the current model year; this occurs most often as part of the transition to new emission standards.

(c) Except where indicated, the language in this subpart applies to both vehicles and engines. In many instances, language referring to engines is enclosed in parentheses and immediately follows the language discussing vehicles.

**§ 86.085–37 [Amended]**

■ 37. Section 86.085–37 is amended by removing paragraph (d).

■ 38. Section 86.094–14 is revised to read as follows:

**§ 86.094–14 Small-volume manufacturer certification procedures.**

(a)(1) The small-volume manufacturer certification procedures described in paragraphs (b) and (c) of this section are optional. Small-volume manufacturers may use these optional procedures to demonstrate compliance with the general standards and specific emission requirements contained in this subpart.

(2) To satisfy the durability data requirements of the small-volume manufacturer certification procedures, manufacturers of vehicles (or engines) as described in paragraph (b) of this section may use assigned deterioration factors that the Administrator determines by methods described in paragraph (c)(3)(ii) of this section. However, if no deterioration factor data (either the manufacturer's or industry-wide deterioration factor data) are available from previously completed durability data vehicles or engines used for certification, manufacturers of vehicles (or engines) as described in paragraph (b) of this section or with new technology not previously certified may use assigned deterioration factors that the Administrator determines by alternative methods, based on good engineering judgment. The factors that the Administrator determines by alternative methods will be published in an advisory letter or advisory circular.

(b)(1) The optional small-volume manufacturer certification procedures apply to heavy-duty vehicles, and heavy-duty engines produced by manufacturers with U.S. sales, including all vehicles and engines imported under the provisions of §§ 85.1505 and 85.1509 of this chapter (for the model year in which certification is sought) of fewer than 10,000 units (Light-Duty Vehicles, Light-Duty Trucks, Heavy-Duty Vehicles and Heavy-Duty Engines combined).

(2) For the purpose of determining the applicability of paragraph (b)(1) of this section, the sales the Administrator shall use shall be the aggregate of the projected or actual sales of those vehicles and/or engines in any of these groupings:

(i) Vehicles and/or engines produced by two or more firms, one of which is 10 percent or greater part owned by another;

(ii) Vehicles and/or engines produced by any two or more firms if a third party has equity ownership of 10 percent or more in each of the firms;

(iii) Vehicles and/or engines produced by two or more firms having a common corporate officer(s) who is (are) responsible for the overall direction of the companies;

(iv) Vehicles and/or engines imported or distributed by all firms where the vehicles and/or engines are manufactured by the same entity and the importer or distributor is an authorized agent of the entity.

(3) If the aggregated sales, as determined in paragraph (b)(2) of this section are less than 301 units, the manufacturers in the aggregated relationship may certify under the

provisions in this section that apply to manufacturers with sales of less than 301 units.

(4) If the aggregated sales, as determined in paragraph (b)(2) of this section are greater than 300 but fewer than 10,000 units, the manufacturers in the aggregated relationship may certify under the provisions in this section that apply to manufacturers with sales from and including 301 through 9,999 motor vehicles and motor vehicles engines per year.

(5) If the aggregated sales, as determined in paragraph (b)(2) of this section are equal to or greater than 10,000 units, then the manufacturers involved in the aggregated relationship will be allowed to certify a number of units under the small-volume engine family certification procedures (reference § 86.001–24(e)) in accordance with the following criteria:

(i) If a manufacturer purchases less than 50 percent of another manufacturer, each manufacturer retains its right to certify 9,999 units using the small-volume engine family certification procedures.

(ii) If a manufacturer purchases 50 percent or more of another manufacturer, the manufacturer with the over 50 percent interest must share, with the manufacturer it purchased, its 9,999 units under the small-volume engine family certification procedures.

(iii) In a joint venture arrangement (50/50 ownership) between two manufacturers, each manufacturer retains its eligibility for 9,999 units under the small-volume engine family certification procedures, but the joint venture must draw its maximum 9,999 units from the units allocated to its parent manufacturers.

(c) All the provisions of this subpart apply to small-volume manufacturers, except as described in this paragraph (c). The appropriate model year of specific sections shall be determined in accordance with § 86.084–4.

(1) Section 86.080–12 is not applicable.

(2) Small-volume manufacturers shall include in their records all the information that EPA requires in § 86.007–21. This information will be considered part of the manufacturer's application for certification. However, the manufacturer is not required to submit the information to the Administrator unless the Administrator requests it.

(3) Small-volume manufacturers may satisfy the requirements of § 86.001–24(b) and (c) as follows:

(i) *Emission data.* Small-volume manufacturers may select one emission data test vehicle (engine) per engine



family by the worst-case emissions criteria as follows:

(A) *Heavy-duty Otto-cycle engines.* The manufacturer shall select one emission data engine first based on the largest displacement within the engine family. Then within the largest displacement the manufacturer shall select, in the order listed, highest fuel flow at the speed of maximum rated torque, the engine with the most advanced spark timing, no EGR or lowest EGR flow, and no air pump or lowest actual flow air pump.

(B) *Heavy-duty diesel engines.* The manufacturer shall select one emission data engine based on the highest fuel feed per stroke, primarily at the speed of maximum rated torque and secondarily at rated speed.

(ii) *Durability data.* Small-volume manufacturers may satisfy the durability data requirements with the following procedures:

(A) Manufacturers with aggregated sales of less than 301 motor vehicles and motor vehicle engines per year may use assigned deterioration factors that the Administrator determines and prescribes. The factors will be the Administrator's estimate, periodically updated and published in an advisory letter or advisory circular, of the 70th percentile deterioration factors calculated using the industry-wide data base of previously completed durability data vehicles or engines used for certification. However, the manufacturer may, at its option, accumulate miles (hours) on a durability data vehicle (engine) and complete emission tests for the purpose of establishing its own deterioration factors.

(B)(1) Manufacturers with aggregated sales from and including 301 through 9,999 motor vehicles and motor vehicle engines per year certifying light-duty vehicle exhaust emissions from vehicles equipped with proven emission control systems shall use assigned deterioration factors that the manufacturer determines based on its good engineering judgment. However, the manufacturer may not use deterioration factors less than either the average or 70th percentile of all of that manufacturer's deterioration factor data, whichever is less. These minimum deterioration factors shall be calculated according to procedures in paragraph (c)(3)(ii)(B)(2), of this section. If the manufacturer does not have at least two data points to calculate these manufacturer specific average deterioration factors, then the deterioration factors shall be no less than the EPA supplied industry-wide deterioration factors. However, the manufacturer may, at its option, accumulate miles on a durability data

vehicle and complete emission tests for the purpose of establishing its own deterioration factors.

(2) The manufacturer's minimum deterioration factors shall be calculated using the deterioration factors from all engine families, within the same vehicle/engine-fuel usage category (e.g., gasoline-fueled light-duty vehicle, etc.) previously certified to the same emission standards. The manufacturer shall use only deterioration factors from engine families previously certified by the manufacturer and the deterioration factors shall not be included in the calculation more than once. The deterioration factors for each pollutant shall be calculated separately. The manufacturer may, at its option, limit the deterioration factors used in the calculation of the manufacturer's minimum deterioration factors to those from all similar systems to the system being certified if sufficient data (i.e., from at least two certified systems) exists. All data eligible to be grouped as similar system data shall be used in calculating similar system deterioration factors. Any deterioration factors used in calculating similar system deterioration factors shall not be included in calculating the manufacturer's minimum deterioration factors used to certify any of the manufacturer's remaining vehicle systems.

(C) Manufacturers with aggregated sales from 301 through 9,999 motor vehicles and motor vehicle engines and certifying light-duty vehicle exhaust emissions from vehicles equipped with unproven emission control systems shall use deterioration factors that the manufacturer determines from official certification durability data generated by vehicles from engine families representing a minimum of 25 percent of the manufacturer's sales equipped with unproven emission control systems. The sales projections are to be based on total sales projected for each engine/system combination. The durability programs applicable to such manufacturers for this purpose shall be the Standard AMA, the Production AMA and the Alternative Service Accumulation Durability Programs of § 86.094–13. The durability data vehicle (engine) mileage accumulation and emission tests are to be conducted in accordance with § 86.094–13. The manufacturer must develop deterioration factors by generating durability data in accordance with § 86.094–13 on a minimum of 25 percent of the manufacturer's projected sales (by engine/system combination) that is equipped with unproven emission control systems. The

manufacturer must complete the 25 percent durability requirement before the remainder of the manufacturer's sales equipped with unproven emission control systems is certified using manufacturer-determined assigned deterioration factors. Alternatively, any of these manufacturers may, at their option, accumulate miles on durability data vehicles and complete emission tests for the purpose of establishing their own deterioration factors on the remaining sales.

(4) Section 86.001–24(d) and (e) are not applicable.

(5) Small-volume manufacturers shall comply with the following provisions instead of § 86.007–30(a)(2) and (b):

(i) Small-volume manufacturers shall submit an application for certification containing the following elements:

(A) The names, addresses, and telephone numbers of the persons the manufacturer authorizes to communicate with us.

(B) A brief description of the vehicles (or engines) covered by the certificate (the manufacturers' sales data book or advertising, including specifications, may satisfy this requirement for most manufacturers). The description shall include, as a minimum, the following items:

(1) Engine evaporative/refueling family names and vehicle (or engine) configurations.

(2) Vehicle carlines or engine models to be listed on the certificate of conformity.

(3) The test weight and horsepower setting for each vehicle or engine configuration.

(4) Projected sales.

(5) Combustion cycle.

(6) Cooling mechanism.

(7) Number of cylinders.

(8) Displacement.

(9) Fuel system type.

(10) Number of catalytic converters, type, volume, composition, surface area, and total precious metal loading.

(11) Method of air aspiration.

(12) Thermal reactor characteristics.

(13) Suppliers' and/or manufacturers' name and model number of any emission related items of the above, if purchased from a supplier who uses the items in its own certified vehicle(s) or engine(s).

(14) A list of emission component part numbers.

(15) Drawings, calibration curves, and descriptions of emission related components, including those components regulated under § 86.001–22(e), and schematics of hoses and other devices connecting these components.

(16)–(17) [Reserved]

(18) Proof that the manufacturer has obtained or entered an agreement to



purchase, when applicable, the insurance policy required by the § 85.1510(b) of this chapter. The manufacturer may submit a copy of the insurance policy or purchase agreement as proof that the manufacturer has obtained or entered an agreement to purchase the insurance policy.

(19) For each evaporative/refueling emission family, a description of any unique procedures required to perform evaporative and/or refueling emission tests (as applicable) (including canister working capacity, canister bed volume, and fuel temperature profile for the running loss test) for all vehicles in that evaporative/refueling emission family, and a description of the method used to develop those unique procedures.

(20) For each evaporative/refueling emission family:

(i) Canister working capacity, according to the procedures specified in § 86.132–96(h)(1)(iv);

(ii) Canister bed volume; and

(iii) Fuel temperature profile for the running loss test, according to the procedures specified in § 86.129–94(d).

(C) The results of all emission tests the manufacturer performs to demonstrate compliance with the applicable standards.

(D)(1) The following statement signed by the authorized representative of the manufacturer: “The vehicles (or engines) described herein have been tested in accordance with (list of the applicable subparts A, B, I, N, or P) of part 86, title 40, Code of Federal Regulations, and on the basis of those tests are in conformance with that subpart. All the data and records required by that subpart are on file and are available for inspection by the EPA Administrator. We project the total U.S. sales of vehicles (engines) subject to this subpart (including all vehicles and engines imported under the provisions of 40 CFR 85.1505 and 40 CFR 85.1509) to be fewer than 10,000 units.”

(2) [Reserved]

(3) A statement that the vehicles or engines described in the manufacturer’s application for certification are not equipped with auxiliary emission control devices which can be classified as a defeat device as defined in § 86.004–2.

(4) A statement of compliance with section 206(a)(3) of the Clean Air Act (42 U.S.C. 7525(a)(3)).

(5)–(6) [Reserved]

(7) A statement affirming that the manufacturer will provide a list of emission and emission-related service parts, including part number designations and sources of parts, to the vehicle purchaser for all emission and emission-related parts which might

affect vehicle emission performance throughout the useful life of the vehicle. Secondly, it must state that qualified service facilities and emission-related repair parts will be conveniently available to serve its vehicles. In addition, if service facilities are not available at the point of sale or distribution, the manufacturer must indicate that the vehicle purchaser will be provided information identifying the closest authorized service facility to the point of sale, if in the United States, or the closest authorized service facility to the point of distribution to the ultimate purchaser if the vehicle was purchased outside of the United States by the ultimate purchaser. Such information should also be made available to the Administrator upon request.

(E) Manufacturers utilizing deterioration factors determined by the manufacturer based on its good engineering judgment (reference paragraph (c)(3)(ii)(B) of this section) shall provide a description of the method(s) used by the manufacturer to determine the deterioration factors.

(ii) If the manufacturer meets the requirements of this subpart, the Administrator will issue a certificate of conformity for the vehicles or engines described in the application for certification.

(iii) The certificate will be issued for such a period not to exceed one model year as the Administrator may determine and upon such terms as he may deem necessary to assure that any vehicle or engine covered by the certificate will meet the requirements of the Act and of this subpart.

(iv) If, after a review of the statements and descriptions submitted by the manufacturer, the Administrator determines that the manufacturer has not met the applicable requirements, the Administrator shall notify the manufacturer in writing of his intention to deny certification, setting forth the basis for his determination. The manufacturer may request a hearing on the Administrator’s determination. If the manufacturer does not request a hearing or present the required information, the Administrator will deny certification.

(6) Sections 86.079–31 and 86.079–32 are not applicable.

(7) The following provisions apply for small-volume manufacturers instead of the provisions specified in § 86.079–33:

(i) Small-volume manufacturers may make production changes (running changes) without receiving the Administrator’s prior approval. The manufacturer shall assure (by conducting emission tests as it deems necessary) that the affected vehicles

(engines) remain in compliance with the requirements of this part.

(ii) The manufacturer shall notify the Administrator within seven days after implementing any production related change (running change) that would affect vehicle emissions. This notification shall include any changes to the information required under paragraph (c)(5)(i) of this section. The manufacturer shall also amend as necessary its records required under paragraph (c)(2) of this section to confirm the production design change.

(8) Section 86.082–34 is not applicable.

■ 39. Section 86.094–25 is amended by revising paragraphs (b)(2) and (b)(7)(iii) to read as follows:

§ 86.094–25 Maintenance.

\* \* \* \* \*

(b) \* \* \*

(2) Any emission-related maintenance which is performed on vehicles, engines, subsystems, or components must be technologically necessary to assure in-use compliance with the emission standards. The manufacturer must submit data which demonstrate to the Administrator that all of the emission-related scheduled maintenance which is to be performed is technologically necessary. Scheduled maintenance must be approved by the Administrator prior to being performed or being included in the maintenance instructions provided to purchasers under § 86.010–38.

\* \* \* \* \*

(7) \* \* \*

(iii) Any manufacturer may request a hearing on the Administrator’s determinations in this paragraph (b)(7). The request shall be in writing and shall include a statement specifying the manufacturer’s objections to the Administrator’s determinations, and data in support of such objections. If, after review of the request and supporting data, the Administrator finds that the request raises a substantial factual issue, he shall provide the manufacturer a hearing as described in 40 CFR part 1068, subpart G.

\* \* \* \* \*

§§ 86.094–30 and 86.095–14 [Removed]

■ 40. Remove §§ 86.094–30 and 86.095–14.

■ 41. Section 86.095–35 is amended by:

■ a. Revising paragraphs (a) introductory text, (a)(3)(iii)(B), (H), (I), (J), and (K);

■ b. Adding paragraph (c); and

■ c. Revising paragraph (i).

The revisions and addition read as follows:

**§ 86.095–35 Labeling.**

(a) The manufacturer of any motor vehicle (or motor vehicle engine) subject to the applicable emission standards (and family emission limits, as appropriate) of this subpart, shall, at the time of manufacture, affix a permanent legible label, of the type and in the manner described below, containing the information hereinafter provided, to all production models of such vehicles (or engines) available for sale to the public and covered by a Certificate of Conformity under § 86.007–30(a).

\* \* \* \* \*

(3) \* \* \*

(iii) \* \* \*

(B) The full corporate name and trademark of the manufacturer; though the label may identify another company and use its trademark instead of the manufacturer's as long as the manufacturer complies with the branding provisions of 40 CFR 1068.45.

\* \* \* \* \*

(H) The prominent statement: "This engine conforms to U.S. EPA regulations applicable to XXXX Model Year New Heavy-Duty Engines.";

(I) If the manufacturer has an alternate useful life period under the provisions of § 86.094–21(f), the prominent statement: "This engine has been certified to meet U.S. EPA standards for a useful-life period of XXX miles or XXX hours of operation, whichever occurs first. This engine's actual life may vary depending on its service application." The manufacturer may alter this statement only to express the assigned alternate useful life in terms other than miles or hours (e.g., years, or hours only);

(J) For diesel engines, the prominent statement: "This engine has a primary intended service application as a XXX heavy-duty engine." (The primary intended service applications are light, medium, and heavy, as defined in § 86.090–2.);

(K) For engines certified under the alternative standards specified in § 86.007–11(g) or § 86.008–10(g), the following statement: "This engine is certified for only in specialty vehicles as specified in [40 CFR 86.007–11 or 40 CFR 86.008–10]";

\* \* \* \* \*

(c) Vehicles powered by model year 2007 through 2013 diesel-fueled engines

must include permanent, readily visible labels on the dashboard (or instrument panel) and near all fuel inlets that state "Use Ultra Low Sulfur Diesel Fuel Only"; or "Ultra Low Sulfur Diesel Fuel Only".

\* \* \* \* \*

(i) The Administrator may approve in advance other label content and formats, provided the alternative label contains information consistent with this section.

**§ 86.098–14 [Removed]**

■ 42. Remove § 86.098–14.

**Subpart B—Emission Regulations for 1977 and Later Model Year New Light-Duty Vehicles and New Light-Duty Trucks and New Otto-Cycle Complete Heavy-Duty Vehicles; Test Procedures**

■ 43. Section 86.143–96 is amended by revising the equation in paragraph (b)(1)(i) to read as follows:

**§ 86.143–96 Calculations; evaporative emissions.**

\* \* \* \* \*

(b) \* \* \*

(1) \* \* \*

(i) \* \* \*

$$M_{CH3OH} = V_n \times \left[ \frac{(C_{MS1f} \times AV_{1f}) + (C_{MS2f} \times AV_{2f})}{V_{Ef}} \right] - \left[ \frac{(C_{MS1i} \times AV_{1i}) + (C_{MS2i} \times AV_{2i})}{V_{Ei}} \right] + (M_{CH3OH,out} - M_{CH3OH,in})$$

\* \* \* \* \*

**Subpart E—Emission Regulations for 1978 and Later New Motorcycles, General Provisions**

■ 44. Section 86.402–78 is amended by adding, in alphabetical order, a definition for "Round" to paragraph (a) to read as follows:

**§ 86.402–78 Definitions.**

(a) \* \* \*

Round has the meaning given in 40 CFR 1065.1001, unless otherwise specified.

\* \* \* \* \*

■ 45. Section 86.410–2006 is amended by revising paragraph (e) introductory text to read as follows:

**§ 86.410–2006 Emission standards for 2006 and later model year motorcycles.**

\* \* \* \* \*

(e) Manufacturers with fewer than 500 employees worldwide and producing fewer than 3,000 motorcycles per year for the United States are considered small-volume manufacturers for the purposes of this section. The following

provisions apply for these small-volume manufacturers:

\* \* \* \* \*

**§ 86.419–78 [Removed]**

■ 46. Section 86.419–78 is removed.

■ 47. Section 86.419–2006 is amended by revising paragraph (a)(1) to read as follows:

**§ 86.419–2006 Engine displacement, motorcycle classes.**

(a)(1) Engine displacement shall be calculated using nominal engine values and rounded to the nearest whole cubic centimeter.

\* \* \* \* \*

■ 48. Section 86.432–78 is amended by revising paragraph (d) to read as follows:

**§ 86.432–78 Deterioration factor.**

\* \* \* \* \*

(d) An exhaust emission deterioration factor will be calculated by dividing the predicted emissions at the useful life distance by the predicted emissions at the total test distance. Predicted emissions are obtained from the correlation developed in paragraph (c)

of this section. Factor = Predicted total distance emissions ÷ Predicted total test distance emissions.

These interpolated and extrapolated values shall be carried out to four places to the right of the decimal point before dividing one by the other to determine the deterioration factor. The results shall be rounded to three places to the right of the decimal point.

\* \* \* \* \*

■ 49. Section 86.443–78 is revised to read as follows:

**§ 86.443–78 Request for hearing.**

The manufacturer may request a hearing on the Administrator's determination as described in 40 CFR part 1068, subpart G.

■ 50. Section 86.444–78 is revised to read as follows:

**§ 86.444–78 Hearings on certification.**

If a manufacturer's request for a hearing is approved, EPA will follow the hearing procedures specified in 40 CFR part 1068, subpart G.

### Subpart F—Emission Regulations for 1978 and Later New Motorcycles; Test Procedures

■ 51. Section 86.544–90 is amended by revising the introductory text and paragraph (a) to read as follows:

#### § 86.544–90 Calculations; exhaust emissions.

This section describes how to calculate exhaust emissions. Determine emission results for each pollutant to at least one more decimal place than the applicable standard. Apply the deterioration factor, then round the adjusted figure to the same number of decimal places as the emission standard. Compare the rounded emission levels to the emission standard for each emission data vehicle. In the case of NO<sub>x</sub> + HC standards, apply the deterioration factor to each pollutant and then add the results before rounding.

(a) Calculate a composite FTP emission result using the following equation:

$$Y_{wm} = 0.43 \cdot \frac{Y_{ct} + Y_s}{D_{ct} + D_s} + 0.57 \cdot \frac{Y_{ht} + Y_s}{D_{ht} + D_s}$$

Where:

$Y_{wm}$  = Weighted mass emissions of each pollutant (*i.e.*, CO<sub>2</sub>, HC, CO, or NO<sub>x</sub>) in grams per vehicle kilometer and if appropriate, the weighted carbon mass equivalent of total hydrocarbon equivalent, in grams per vehicle kilometer.

$Y_{ct}$  = Mass emissions as calculated from the transient phase of the cold-start test, in grams per test phase.

$Y_s$  = Mass emissions as calculated from the stabilized phase of the cold-start test, in grams per test phase.

$D_{ct}$  = The measured driving distance from the transient phase of the cold-start test, in kilometers.

$D_s$  = The measured driving distance from the stabilized phase of the cold-start test, in kilometers.

$Y_{ht}$  = Mass emissions as calculated from the transient phase of the hot-start test, in grams per test phase.

$D_{ht}$  = The measured driving distance from the transient phase of the hot-start test, in kilometers.

\* \* \* \* \*

### Subpart G—Selective Enforcement Auditing of New Light-Duty Vehicles, Light-Duty Trucks, and Heavy-Duty Vehicles

■ 52. Section 86.614–84 is revised to read as follows:

#### § 86.614–84 Hearings on suspension, revocation, and voiding of certificates of conformity.

The provisions of 40 CFR part 1068, subpart G, apply if a manufacturer requests a hearing regarding suspension, revocation or voiding of certificates of conformity.

■ 53. Section 86.615–84 is revised to read as follows:

#### § 86.615–84 Treatment of confidential information.

The provisions of 40 CFR 1068.10 apply for information you consider confidential.

### Subpart L—Nonconformance Penalties for Gasoline-Fueled and Diesel Heavy-Duty Engines and Heavy-Duty Vehicles, Including Light-Duty Trucks

#### § 86.1103–87 [Removed]

■ 54. Section 86.1103–87 is removed.

■ 55. Section 86.1103–2016 is added to subpart L to read as follows:

#### § 86.1103–2016 Criteria for availability of nonconformance penalties.

(a) *General.* This section describes the three criteria EPA will use to evaluate whether NCPs are appropriate under the Clean Air Act for a given pollutant and a given subclass of heavy-duty engines and heavy-duty vehicles. Together, these criteria evaluate the likelihood that a manufacturer will be technologically unable to meet a standard on time. Note that since the first two of these criteria are intended to address the question of whether a given standard creates the possibility for this to occur, they are evaluated before the third criterion that addresses the likelihood that the possibility will actually happen.

(b) *Criteria.* We will establish NCPs for a given pollutant and subclass when we find that each of the following criteria is met:

(1) There is a new or revised emission standard is more stringent than the previous standard for the pollutant, or an existing standard for that pollutant has become more difficult to achieve because of a new or revised standard. When evaluating this criterion, EPA will consider a new or revised standard to be “new” or “revised” until the point at which all manufacturers already producing U.S.-directed engines or vehicles within the subclass have achieved full compliance with the standard. For purposes of this criterion, EPA will generally not consider compliance using banked emission credits to be “full compliance”.

(2) Substantial work is required to meet the standard for which the NCP is offered, as evaluated from the point at which the standard was adopted or revised (or the point at which the standard became more difficult meet because another standard was adopted

or revised). Substantial work, as used in this paragraph (b)(2), means the application of technology not previously used in an engine or vehicle class or subclass, or the significant modification of existing technology or design parameters, needed to bring the vehicle or engine into compliance with either the more stringent new or revised standard or an existing standard which becomes more difficult to achieve because of a new or revised standard. Note that where this criterion is evaluated after any of the work has been completed, the criterion would be interpreted as whether or not substantial work was required to meet the standard.

(3) There is or is likely to be a technological laggard for the subclass. Note that a technological laggard is a manufacturer that is unable to meet the standard for one or more products within the subclass for technological reasons.

(c) *Evaluation.* (1) We will generally evaluate these criteria in sequence. Where we find that the first criterion has not been met, we will not consider the other two criteria. Where we find that the first criterion has been met but not the second, we will not consider the third criterion. We may announce our findings separately or simultaneously.

(2) We may consider any available information in making our findings.

(3) Where we are uncertain whether the first and/or second criteria have been met, we may presume that they have been met and make our decision based solely on whether or not the third criterion has been met.

(4) Where we find that a manufacturer will fail to meet a standard but are uncertain whether the failure is a technological failure, we may presume that the manufacturer is a technological laggard.

#### § 86.1104–91 [Removed]

■ 56. Section 86.1104–91 is removed.

■ 57. Section 86.1104–2016 is added to subpart L to read as follows:

#### § 86.1104–2016 Determination of upper limits.

EPA shall set a separate upper limit for each phase of NCPs and for each service class.

(a) Except as provided in paragraphs (b), (c) and (d) of this section, the upper limit shall be set as follows:

(1) The upper limit applicable to a pollutant emission standard for a subclass of heavy-duty engines or heavy-duty vehicles for which an NCP is established in accordance with § 86.1103–87, shall be the previous pollutant emission standard for that subclass.

(2) If a manufacturer participates in any of the emissions averaging, trading, or banking programs, and carries over certification of an engine family from the prior model year, the upper limit for that engine family shall be the family emission limit of the prior model year, unless the family emission limit is less than the upper limit determined in paragraph (a)(1) of this section.

(b) If no previous standard existed for the pollutant under paragraph (a) of this section, the upper limit will be developed by EPA during rulemaking.

(c) EPA may set the upper limit during rulemaking at a level below the level specified in paragraph (a) of this section if we determine that a lower level is achievable by all engines or vehicles in that subclass.

(d) EPA may set the upper limit at a level above the level specified in paragraph (a) of this section if we determine that such level will not be achievable by all engines or vehicles in that subclass.

■ 58. Section 86.1105–87 is amended by revising paragraph (e) and removing paragraph (j).

The revision reads as follows:

**§ 86.1105–87 Emission standards for which nonconformance penalties are available.**

\* \* \* \* \*

(e) The values of COC<sub>50</sub>, COC<sub>90</sub>, and MC<sub>50</sub> in paragraphs (a) and (b) of this section are expressed in December 1984 dollars. The values of COC<sub>50</sub>, COC<sub>90</sub>, and MC<sub>50</sub> in paragraphs (c) and (d) of this section are expressed in December 1989 dollars. The values of COC<sub>50</sub>, COC<sub>90</sub>, and MC<sub>50</sub> in paragraph (f) of this section are expressed in December 1991 dollars. The values of COC<sub>50</sub>, COC<sub>90</sub>, and MC<sub>50</sub> in paragraphs (g) and (h) of this section are expressed in December 1994 dollars. The values of COC<sub>50</sub>, COC<sub>90</sub>, and MC<sub>50</sub> in paragraph (i) of this section are expressed in December 2001 dollars. These values shall be adjusted for inflation to dollars as of January of the calendar year preceding the model year in which the NCP is first available by using the change in the overall Consumer Price Index, and rounded to the nearest whole dollar.

\* \* \* \* \*

■ 59. Section 86.1112–87 is amended by revising paragraphs (a)(2)(iii), (a)(3)(iii), (d) and (e)(2) to read as follows:

**§ 86.1112–87 Determining the compliance level and reporting of test results.**

- (a) \* \* \*
- (2) \* \* \*

(iii) The compliance level for the pollutant is the result of the following equation, using the test results obtained in paragraph (a)(2)(ii) of this section and all SEA test results for that pollutant if the PCA follows an SEA failure:

$$CL = \bar{X} + Ks$$

Where:

CL = The compliance level.

$\bar{X}$  = The mean of the final deteriorated test results, as defined by paragraph (e) of this section.

K = A value that depends on the size of the test sample. See table 2 of appendix XII of this part for the value of K that corresponds to the size of the test sample.

s = The sample standard deviation.

Round the compliance level to the same number of significant figures contained in the applicable standard.

(3) \* \* \*

(iii) The compliance level for the pollutant is the result of the following equation, using the test results obtained in (a)(3)(ii) and all SEA test results for that pollutant if the PCA follows an SEA failure:

$$CL = \bar{X} + Ks$$

Where:

CL = The compliance level.

$\bar{X}$  = The mean of the final deteriorated test results, as defined by paragraph (e) of this section.

K = A value that depends on the size of the test sample. See table 3 of appendix XII of this part for the value of K that corresponds to the size of the test sample.

s = The sample standard deviation.

Round the compliance level to the same number of significant figures contained in the applicable standard.

\* \* \* \* \*

(d) Final test results are calculated by summing the initial test results derived in paragraph (c) of this section for each test engine or vehicle, dividing by the number of tests conducted on the engine or vehicle, and rounding to the same number of decimal places contained in the applicable standard expressed to one additional significant figure.

(e) \* \* \*

(2) Round the final deteriorated test results to the same number of significant figures contained in the applicable standard.

\* \* \* \* \*

■ 60. Section 86.1113–87 is amended by revising paragraphs (a)(6), (f) and (g)(3) introductory text to read as follows:

**§ 86.1113–87 Calculation and payment of penalty.**

(a) \* \* \*

(6) In calculating the NCP, appropriate values of the following

predefined terms should be used: CL, S, UL, F, and A<sub>i</sub>. For all other terms, unrounded values of at least five figures beyond the decimal point should be used in calculations leading up to the penalty amount. Any NCP calculated under paragraph (a) of this section will be rounded to the nearest dollar.

\* \* \* \* \*

(f) A manufacturer may request a hearing under 40 CFR part 1068, subpart G, as to whether the compliance level (including a compliance level in excess of the upper limit) was determined properly.

(g) \* \* \*

(3) A manufacturer making payment under paragraph (g)(1) or (2) of this section shall submit the following information by each quarterly due date to the Designated Compliance Officer (see 40 CFR 1036.801). This information shall be submitted even if a manufacturer has no NCP production in a given quarter.

\* \* \* \* \*

■ 61. Section 86.1115–87 is revised to read as follows:

**§ 86.1115–87 Hearing procedures for nonconformance determinations and penalties.**

The provisions of 40 CFR part 1068, subpart G, apply if a manufacturer requests a hearing regarding penalties under this subpart.

**Subpart N—Exhaust Test Procedures for Heavy-Duty Engines**

■ 62. Section 86.1301 is revised to read as follows:

**§ 86.1301 Scope; applicability.**

This subpart specifies gaseous emission test procedures for Otto-cycle and diesel heavy-duty engines, and particulate emission test procedures for diesel heavy-duty engines.

■ 63. Section 86.1362 is amended by revising paragraph (a) to read as follows:

**§ 86.1362 Steady-state testing with a ramped-modal cycle.**

\* \* \* \* \*

(a) Measure emissions by testing the engine on a dynamometer with the following ramped-modal duty cycle to determine whether it meets the applicable steady-state emission standards:

RMC mode	Time in mode (seconds)	Engine speed <sup>1 2</sup>	Torque (percent) <sup>2 3</sup>	CO <sub>2</sub> weighting (percent) <sup>4</sup>
1a Steady-state .....	170	Warm Idle .....	0 .....	6
1b Transition .....	20	Linear Transition .....	Linear Transition.	

RMC mode	Time in mode (seconds)	Engine speed <sup>1 2</sup>	Torque (percent) <sup>2 3</sup>	CO <sub>2</sub> weighting (percent) <sup>4</sup>
2a Steady-state	173	A	100	9
2b Transition	20	Linear Transition	Linear Transition.	
3a Steady-state	219	B	50	10
3b Transition	20	B	Linear Transition.	
4a Steady-state	217	B	75	10
4b Transition	20	Linear Transition	Linear Transition.	
5a Steady-state	103	A	50	12
5b Transition	20	A	Linear Transition.	
6a Steady-state	100	A	75	12
6b Transition	20	A	Linear Transition.	
7a Steady-state	103	A	25	12
7b Transition	20	Linear Transition	Linear Transition.	
8a Steady-state	194	B	100	9
8b Transition	20	B	Linear Transition.	
9a Steady-state	218	B	25	9
9b Transition	20	Linear Transition	Linear Transition.	
10a Steady-state	171	C	100	2
10b Transition	20	C	Linear Transition.	
11a Steady-state	102	C	25	1
11b Transition	20	C	Linear Transition.	
12a Steady-state	100	C	75	1
12b Transition	20	C	Linear Transition.	
13a Steady-state	102	C	50	1
13b Transition	20	Linear Transition	Linear Transition.	
14 Steady-state	168	Warm Idle	0	6

<sup>1</sup> Speed terms are defined in 40 CFR part 1065.

<sup>2</sup> Advance from one mode to the next within a 20-second transition phase. During the transition phase, command a linear progression from the speed or torque setting of the current mode to the speed or torque setting of the next mode.

<sup>3</sup> The percent torque is relative to maximum torque at the commanded engine speed.

<sup>4</sup> Use the specified weighting factors to calculate composite emission results for CO<sub>2</sub> as specified in 40 CFR 1036.501.

\* \* \* \* \*

■ 64. Section 86.1370 is amended by revising paragraphs (g) and (h) and adding paragraphs (i) and (j) to read as follows:

**§ 86.1370 Not-To-Exceed test procedures.**

\* \* \* \* \*

(g) You may exclude emission data based on catalytic aftertreatment temperatures as follows:

(1) For an engine equipped with a catalytic NO<sub>x</sub> aftertreatment system, exclude NO<sub>x</sub> emission data that is collected when the exhaust temperature at any time during the NTE event is less than 250 °C.

(2) For an engine equipped with an oxidizing catalytic aftertreatment system, exclude NMHC and CO emission data that is collected if the exhaust temperature is less than 250 °C at any time during the NTE event.

(3) Using good engineering judgment, measure exhaust temperature within 30 cm downstream of the last applicable catalytic aftertreatment device. Where there are parallel paths, use good engineering judgment to measure the temperature within 30 cm downstream of the last applicable catalytic aftertreatment device in the path with the greatest exhaust flow.

(h) Any emission measurements corresponding to engine operating conditions that do not qualify as a valid

NTE sampling event may be excluded from the determination of the vehicle-pass ratio specified in § 86.1912 for the specific pollutant.

(i) Start emission sampling at the beginning of each valid NTE sampling event, except as needed to allow for zeroing or conditioning the PEMS. For gaseous emissions, PEMS preparation must be complete for all analyzers before starting emission sampling.

(j) Emergency vehicle AECs. If your engine family includes engines with one or more approved AECs for emergency vehicle applications under paragraph (4) of the definition of “defeat device” in § 86.1803, the NTE emission limits do not apply when any of these AECs are active.

**Subpart S—General Compliance Provisions for Control of Air Pollution From New and In-Use Light-Duty Vehicles, Light-Duty Trucks, and Heavy-Duty Vehicles**

■ 65. Section 86.1801–12 is amended as follows:

- a. By removing and reserving paragraph (a)(2)(ii).
- b. By revising paragraph (a)(3)(i).
- c. By redesignating paragraphs (a)(3)(ii) through (iv) as paragraphs (a)(3)(iii) through (v), respectively.
- d. By adding a new paragraph (a)(3)(ii).

The revision and addition read as follows:

**§ 86.1801–12 Applicability.**

- (a) \* \* \*
- (3) \* \* \*

(i) Heavy duty vehicles above 14,000 pounds GVWR may be optionally certified to the exhaust emission standards in this subpart, including the greenhouse gas emission standards, if they are properly included in test group with similar vehicles at or below 14,000 pounds GVWR. Emission standards apply to these vehicles as if they were Class 3 heavy-duty vehicles. The work factor for these vehicles may not be greater than the largest work factor that applies for vehicles in the test group that are at or below 14,000 pounds GVWR (see § 86.1819–14).

(ii) Incomplete heavy-duty vehicles at or below 14,000 pounds GVWR may be optionally certified to the exhaust emission standards in this subpart that apply for heavy-duty vehicles.

\* \* \* \* \*

■ 66. Section 86.1802–01 is revised to read as follows:

**§ 86.1802–01 Section numbering; construction.**

(a) *Section numbering.* The model year of initial applicability is indicated by the section number. The two digits following the hyphen designate the first

model year for which a section is applicable. The section continues to apply to subsequent model years unless a later model year section is adopted. Example: Section 86.18xx–10 applies to model year 2010 and later vehicles. If a § 86.18xx–17 is promulgated, it would apply beginning with the 2017 model year; § 86.18xx–10 would apply only to model years 2010 through 2016, except as specified in § 86.18xx–17.

(b) A section reference without a model year suffix refers to the section applicable for the appropriate model year.

(c) If a regulation in this subpart references a section that has been superseded or no longer exists, this should be understood as a reference to the same section for the appropriate model year. For example, if a regulation in this subpart refers to § 86.1845–01, it should be taken as a reference to § 86.1845–04 or any later version of § 86.1845 that applies for the appropriate model year. However, this does not apply if the reference to a superseded section specifically states that the older provision applies instead of any updated provisions from the section in effect for the current model year; this occurs most often as part of the transition to new emission standards.

■ 67. Section 86.1803–01 is amended as follows:

■ a. By revising the definitions for “Base level”, “Base tire”, “Base vehicle”, and “Basic engine”.

■ b. By adding a definition for “Cab-complete vehicle” in alphabetical order.

■ c. By revising the definitions for “Carbon-related exhaust emissions (CREE)”, “Configuration”, paragraph (1) of “Emergency vehicle”, “Engine code”, “Federal Test Procedure”, “Highway Fuel Economy Test Procedure (HFET)”, “Mild hybrid electric vehicle”, “Model type”, “Production volume”, “Strong hybrid electric vehicle”, “Subconfiguration”, “Transmission class”, and “Transmission configuration”.

■ d. By adding a definition for “Transmission type” in alphabetical order.

The revisions and additions read as follows:

**§ 86.1803–01 Definitions.**

\* *Baselevel* has the meaning given in 40 CFR 600.002 for LDV, LDT, and MDPV. See § 86.1819–14 for heavy-duty vehicles.

*Base tire* has the meaning given in 40 CFR 600.002 for LDV, LDT, and MDPV.

*Base vehicle* has the meaning given in 40 CFR 600.002 for LDV, LDT, and MDPV.

*Basic engine* has the meaning given in 40 CFR 600.002.

\* \* \* \* \*  
*Cab-complete vehicle* means a heavy-duty vehicle that is first sold as an incomplete vehicle that substantially includes its cab. Vehicles known commercially as chassis-cabs, cab-chassis, box-deletes, bed-deletes, cut-away vans are considered cab-complete vehicles. For purposes of this definition, a cab includes a steering column and passenger compartment. Note that a vehicle lacking some components of the cab is a cab-complete vehicle if it substantially includes the cab.

\* \* \* \* \*  
*Carbon-related exhaust emissions (CREE)* has the meaning given in 40 CFR 600.002 for LDV, LDT, and MDPV.

\* \* \* \* \*  
*Configuration* means one of the following:

(1) For LDV, LDT, and MDPV, *configuration* means a subclassification within a test group which is based on engine code, inertia weight class, transmission type and gear ratios, final drive ratio, and other parameters which may be designated by the Administrator.

(2) For HDV, *configuration* has the meaning given in § 86.1819–14(d)(12).

\* \* \* \* \*  
*Emergency vehicle* \* \* \*

(1) For the greenhouse gas emission standards in § 86.1818, *emergency vehicle* means a motor vehicle manufactured primarily for use as an ambulance or combination ambulance-hearse or for use by the United States Government or a State or local government for law enforcement.

\* \* \* \* \*  
*Engine code* means one of the following:

(1) For LDV, LDT, and MDPV, *engine code* means a unique combination within a test group of displacement, fuel injection (or carburetor) calibration, choke calibration, distributor calibration, auxiliary emission control devices, and other engine and emission control system components specified by the Administrator. For electric vehicles, *engine code* means a unique combination of manufacturer, electric traction motor, motor configuration, motor controller, and energy storage device.

(2) For HDV, *engine code* has the meaning given in § 86.1819–14(d)(12).

\* \* \* \* \*  
*Federal Test Procedure* has the meaning given in 40 CFR 1066.801(c)(1)(i).

\* \* \* \* \*

*Highway Fuel Economy Test Procedure (HFET)* has the meaning given in 40 CFR 1066.801(c)(3).

\* \* \* \* \*  
*Mild hybrid electric vehicle* means a hybrid electric vehicle that has start/stop capability and regenerative braking capability, where the recovered energy over the Federal Test Procedure is at least 15 percent but less than 65 percent of the total braking energy, as measured and calculated according to 40 CFR 600.116–12(d).

*Model type* has the meaning given in 40 CFR 600.002 for LDV, LDT, and MDPV.

\* \* \* \* \*  
*Production volume* has the meaning given in 40 CFR 600.002.

\* \* \* \* \*  
*Strong hybrid electric vehicle* means a hybrid electric vehicle that has start/stop capability and regenerative braking capability, where the recovered energy over the Federal Test Procedure is at least 65 percent of the total braking energy, as measured and calculated according to 40 CFR 600.116–12(d).

*Subconfiguration* means one of the following:

(1) For LDV, LDT, and MDPV, *subconfiguration* has the meaning given in 40 CFR 600.002.

(2) For HDV, *subconfiguration* has the meaning given in § 86.1819–14(d)(12).

\* \* \* \* \*  
*Transmission class* has the meaning given in 40 CFR 600.002 for LDV, LDT, and MDPV.

*Transmission configuration* has the meaning given in 40 CFR 600.002.

*Transmission type* means the basic type of the transmission (e.g., automatic, manual, automated manual, semi-automatic, or continuously variable) and does not include the drive system of the vehicle (e.g., front-wheel drive, rear-wheel drive, or four-wheel drive).

\* \* \* \* \*  
 ■ 68. Section 86.1805–17 is amended by revising paragraph (b) to read as follows:

**§ 86.1805–17 Useful life.**  
 \* \* \* \* \*

(b) *Greenhouse gas pollutants.* The emission standards in § 86.1818 apply for a useful life of 10 years or 120,000 miles for LDV and LLDT and 11 years or 120,000 miles for HLDT and MDPV. For non-MDPV heavy-duty vehicles, the emission standards in § 86.1819 apply for a useful life of 11 years or 120,000 miles through model year 2020, and for a useful life of 15 years or 150,000 miles in model year 2021 and later. Manufacturers may certify based on the useful life as specified in paragraph (d) of this section if it is different than the

useful life specified in this paragraph (b).

\* \* \* \* \*

■ 69. Section 86.1811–17 is amended by revising paragraphs (b)(8)(iii)(C) and (g) to read as follows:

**§ 86.1811–17 Exhaust emission standards for light-duty vehicles, light-duty trucks and medium-duty passenger vehicles.**

\* \* \* \* \*

- (b) \* \* \*
- (8) \* \* \*
- (iii) \* \* \*

(C) Vehicles must comply with the Tier 2 SFTP emission standards for NMHC + NO<sub>x</sub> and CO for 4,000-mile testing that are specified in § 86.1811–04(f)(1) if they are certified to transitional Bin 85 or Bin 110 standards, or if they are certified based on a fuel without ethanol, or if they are not certified to the Tier 3 p.m. standard. Note that these standards apply under this section for alternative fueled vehicles, for flexible fueled vehicles when operated on a fuel other than gasoline or diesel fuel, and for MDPVs, even though these vehicles were not subject to the SFTP standards in the Tier 2 program.

\* \* \* \* \*

(g) *Cold temperature exhaust emission standards.* The standards in this paragraph (g) apply for certification and in-use vehicles tested over the test procedures specified in subpart C of this part. These standards apply only to gasoline-fueled vehicles. Multi-fuel, bi-fuel or dual-fuel vehicles must comply with requirements using gasoline only. Testing with other fuels such as a high-level ethanol-gasoline blend, or testing on diesel vehicles, is not required.

(1) *Cold temperature CO standards.* Cold temperature CO exhaust emission standards apply for testing at both low-altitude conditions and high-altitude conditions as follows:

- (i) For LDV and LDT1, the standard is 10.0 g/mile CO.
- (ii) For LDT2, LDT3 and LDT4, the standard is 12.5 grams per mile CO.

(2) *Cold temperature NMHC standards.* The following fleet average cold temperature NMHC standards apply as follows:

(i) The standards are shown in the following table:

**TABLE 5 OF § 86.1811–17—FLEET AVERAGE COLD TEMPERATURE NMHC EXHAUST EMISSION STANDARDS**

Vehicle weight category	Cold temperature NMHC sales-weighted fleet average standard (g/mile)
LDV and LLDLT .....	0.3
HLDLT .....	0.5

(ii) The manufacturer must calculate its fleet average cold temperature NMHC emission level(s) as described in § 86.1864–10(m).

(iii) The standards specified in this paragraph (g)(2) apply only for testing at low-altitude conditions. However, manufacturers must submit an engineering evaluation indicating that common calibration approaches are utilized at high altitudes. Any deviation from low altitude emission control practices must be included in the auxiliary emission control device (AECD) descriptions submitted at certification. Any AECD specific to high altitude must require engineering emission data for EPA evaluation to quantify any emission impact and validity of the AECD.

\* \* \* \* \*

■ 70. Section 86.1813–17 is amended by revising paragraphs (a)(1)(ii), (a)(2)(iii), and (f)(1) to read as follows:

**§ 86.1813–17 Evaporative and refueling emission standards.**

\* \* \* \* \*

- (a) \* \* \*
- (1) \* \* \*

(ii) Measure diurnal, running loss, and hot soak emissions as shown in § 86.130. This includes separate measurements for the two-diurnal test sequence and the three-diurnal test sequence; however, gaseous-fueled vehicles are not subject to any evaporative emission standards using the two-diurnal test sequence.

\* \* \* \* \*

- (2) \* \* \*

(iii) Hydrocarbon emissions must not exceed 0.020 g for LDV and LDT and 0.030 g for HDV when tested using the Bleed Emission Test Procedure adopted by the California Air Resources Board as part of the LEV III program. This procedure quantifies diurnal emissions using the two-diurnal test sequence without measuring hot soak emissions. The standards in this paragraph (a)(2)(iii) do not apply for testing at high-altitude conditions. For vehicles with non-integrated refueling canisters,

the bleed emission test and standard do not apply to the refueling canister. You may perform the Bleed Emission Test Procedure using the analogous test temperatures and the E10 test fuel specified in subpart B of this part.

\* \* \* \* \*

- (f) \* \* \*

(1) Compressed natural gas vehicles must meet the requirements for fueling connection devices as specified in ANSI NGV1–2006 or CSA IR–1–15 (incorporated by reference in § 86.1).

\* \* \* \* \*

■ 71. Section 86.1816–18 is amended by revising paragraphs (a) introductory text, (b)(7)(i) introductory text, and (b)(9) to read as follows:

**§ 86.1816–18 Emission standards for heavy-duty vehicles.**

(a) *Applicability and general provisions.* This section describes exhaust emission standards that apply for model year 2018 and later complete heavy-duty vehicles. These standards are optional for incomplete heavy-duty vehicles and for heavy-duty vehicles above 14,000 pounds GVWR as described in § 86.1801. Greenhouse gas emission standards are specified in § 86.1818 for MDPV and in § 86.1819 for other HDV. See § 86.1813 for evaporative and refueling emission standards. This section may apply to vehicles before model year 2018 as specified in paragraph (b)(11) of this section. Separate requirements apply for MDPV as specified in § 86.1811. See subpart A of this part for requirements that apply for incomplete heavy-duty vehicles and for heavy-duty engines certified independent of the chassis.

The following general provisions apply:

\* \* \* \* \*

- (b) \* \* \*
- (7) \* \* \*

(i) The fleet-average FTP emission standard for NMOG + NO<sub>x</sub> phases in over several years as described in this paragraph (b)(7)(i). You must identify FELs as described in paragraph (b)(4) of this section and calculate a fleet-average emission level to show that you meet the FTP emission standard for NMOG+NO<sub>x</sub> that applies for each model year. You may certify using transitional bin standards specified in Table 5 of this section through model year 2021; these vehicles are subject to the FTP emission standard for formaldehyde as described in § 86.1816–08. You may use the E0 test fuel specified in § 86.113 for gasoline-fueled vehicles certified to the transitional bins; the useful life period for these vehicles is 120,000 miles or 11 years. Fleet-average FTP emission

standards decrease as shown in the following table:

\* \* \* \* \*

(9) Except as specified in paragraph (b)(8) of this section, you may not use credits generated from vehicles certified under § 86.1816–08 for demonstrating compliance with the Tier 3 standards.

\* \* \* \* \*

■ 72. Section 86.1817–05 is amended by revising paragraph (c) introductory text to read as follows:

**§ 86.1817–05 Complete heavy-duty vehicle averaging, trading, and banking program.**

\* \* \* \* \*

(c) *Calculations.* For each participating test group, NO<sub>x</sub> emission credits (positive or negative) are to be calculated according to one of the following equations and rounded to the nearest one-tenth of a Megagram (Mg). Consistent units are to be used throughout the equation.

\* \* \* \* \*

■ 73. Section 86.1818–12 is amended by revising paragraphs (a)(2), (c)(4), and (f)(4) to read as follows:

**§ 86.1818–12 Greenhouse gas emission standards for light-duty vehicles, light-duty trucks, and medium-duty passenger vehicles.**

(a) \* \* \*

(2) The standards specified in this section apply for testing at both low-altitude conditions and high-altitude conditions. However, manufacturers must submit an engineering evaluation indicating that common calibration approaches are utilized at high altitude instead of performing testing for certification, consistent with § 86.1829. Any deviation from low altitude emission control practices must be included in the auxiliary emission control device (AECDD) descriptions submitted at certification. Any AECDD specific to high altitude requires engineering emission data for EPA evaluation to quantify any emission impact and determine the validity of the AECDD.

\* \* \* \* \*

(c) \* \* \*

(4) *Emergency vehicles.* Emergency vehicles may be excluded from the emission standards described in this section. The manufacturer must notify

the Administrator that they are making such an election in the model year reports required under § 600.512 of this chapter. Such vehicles should be excluded from both the calculation of the fleet average standard for a manufacturer under this paragraph (c) and from the calculation of the fleet average carbon-related exhaust emissions in § 600.510–12.

\* \* \* \* \*

(f) \* \* \*

(4) *CO<sub>2</sub>-equivalent debits.* CO<sub>2</sub>-equivalent debits for test groups using an alternative N<sub>2</sub>O and/or CH<sub>4</sub> standard as determined under paragraph (f)(3) of this section shall be calculated according to the following equation and rounded to the nearest whole megagram:  $Debits = [GWP \times (Production) \times (AltStd - Std) \times VLM] \div 1,000,000$

Where:

Debits = CO<sub>2</sub>-equivalent debits for N<sub>2</sub>O or CH<sub>4</sub>, in Megagrams, for a test group using an alternative N<sub>2</sub>O or CH<sub>4</sub> standard, rounded to the nearest whole Megagram;

GWP = 25 if calculating CH<sub>4</sub> debits and 298 if calculating N<sub>2</sub>O debits;

Production = The number of vehicles of that test group domestically produced plus those imported as defined in § 600.511 of this chapter;

AltStd = The alternative standard (N<sub>2</sub>O or CH<sub>4</sub>) selected by the manufacturer under paragraph (f)(3) of this section;

Std = The exhaust emission standard for N<sub>2</sub>O or CH<sub>4</sub> specified in paragraph (f)(1) of this section; and

VLM = 195,264 for passenger automobiles and 225,865 for light trucks.

\* \* \* \* \*

■ 74. Section 86.1819–14 is added to subpart S to read as follows:

**§ 86.1819–14 Greenhouse gas emission standards for heavy-duty vehicles.**

This section describes exhaust emission standards for CO<sub>2</sub>, CH<sub>4</sub>, and N<sub>2</sub>O for heavy-duty vehicles. The standards of this section apply for model year 2014 and later vehicles that are chassis-certified with respect to criteria pollutants under this subpart S. Additional heavy-duty vehicles may be optionally subject to the standards of this section as allowed under paragraph (j) of this section. Any heavy-duty vehicles not subject to standards under this section are instead subject to greenhouse gas standards under 40 CFR

part 1037, and engines installed in these vehicles are subject to standards under 40 CFR part 1036. If you are not the engine manufacturer, you must notify the engine manufacturer that its engines are subject to 40 CFR part 1036 if you intend to use their engines in vehicles that are not subject to standards under this section. Vehicles produced by small businesses may be excluded from the standards of this section as described in paragraph (k)(5) of this section.

(a) *Fleet-average CO<sub>2</sub> emission standards.* Fleet-average CO<sub>2</sub> emission standards apply for the full useful life for each manufacturer as follows:

(1) Calculate a work factor, *WF*, for each vehicle subconfiguration (or group of subconfigurations as allowed under paragraph (a)(4) of this section), rounded to the nearest pound, using the following equation:

$$WF = 0.75 \times (GVWR - \text{Curb Weight} + xwd) + 0.25 \times (GCWR - GVWR)$$

Where:

*xwd* = 500 pounds if the vehicle has four-wheel drive or all-wheel drive; *xwd* = 0 pounds for all other vehicles.

(2) Using the appropriate work factor, calculate a target value for each vehicle subconfiguration (or group of subconfigurations as allowed under paragraph (a)(4) of this section) you produce using one of the following equations, or the phase-in provisions in paragraph (k)(4) of this section, rounding to the nearest whole g/mile:

(i) For model year 2027 and later vehicles with spark-ignition engines:  $CO_2 \text{ Target (g/mile)} = 0.0369 \times WF + 284$

(ii) For model year 2027 and later vehicles with compression-ignition engines or with no engines (such as electric vehicles and fuel cell vehicles):  $CO_2 \text{ Target (g/mile)} = 0.0348 \times WF + 268$

(3) Calculate a production-weighted average of the target values and round it to the nearest whole g/mile. This is your fleet-average standard. All vehicles subject to the standards of this section form a single averaging set. Use the following equation to calculate your fleet-average standard from the target value for each vehicle subconfiguration (*Target<sub>i</sub>*) and U.S.-directed production volume of each vehicle subconfiguration for the given model year (*Volume<sub>i</sub>*):

$$\text{Fleet-Average Standard} = \frac{\sum [Target_i \times Volume_i]}{\sum [Volume_i]}$$

(4) You may group subconfigurations within a configuration together for

purposes of calculating your fleet-average standard as follows:

(i) You may group together subconfigurations that have the same



equivalent test weight (ETW), GVWR, and GCWR. Calculate your work factor and target value assuming a curb weight equal to two times ETW minus GVWR.

(ii) You may group together other subconfigurations if you use the lowest target value calculated for any of the subconfigurations.

(5) The standards specified in this section apply for testing at both low-altitude conditions and high-altitude conditions. However, manufacturers must submit an engineering evaluation indicating that common calibration approaches are utilized at high altitude instead of performing testing for certification, consistent with § 86.1829. Any deviation from low altitude emission control practices must be included in the auxiliary emission control device (AECD) descriptions submitted at certification. Any AECD specific to high altitude requires engineering emission data for EPA evaluation to quantify any emission impact and determine the validity of the AECD.

(b) *Production and in-use CO<sub>2</sub> standards.* Each vehicle you produce that is subject to the standards of this section has an “in-use” CO<sub>2</sub> standard that is calculated from your test result and that applies for selective enforcement audits and in-use testing. This in-use CO<sub>2</sub> standard for each vehicle is equal to the applicable deteriorated emission level multiplied by 1.10 and rounded to the nearest whole g/mile.

(c) *N<sub>2</sub>O and CH<sub>4</sub> standards.* Except as allowed under this paragraph (c), all vehicles subject to the standards of this section must comply with an N<sub>2</sub>O standard of 0.05 g/mile and a CH<sub>4</sub> standard of 0.05 g/mile when calculated according to the provisions of paragraph (d)(4) of this section. You may specify CH<sub>4</sub> and/or N<sub>2</sub>O alternative standards using CO<sub>2</sub> emission credits instead of these otherwise applicable emission standards for one or more test groups. To do this, calculate the CH<sub>4</sub> and/or N<sub>2</sub>O emission credits needed (negative credits) using the equation in this paragraph (c) based on the FEL(s) you specify for your vehicles during certification. You must adjust the calculated emissions by the global warming potential (GWP): GWP equals 34 for CH<sub>4</sub> from model year 2021 and later vehicles, 25 for CH<sub>4</sub> from earlier vehicles, and 298 for N<sub>2</sub>O. This means, for example, that you must use 298 Mg of positive CO<sub>2</sub> credits to offset 1 Mg of negative N<sub>2</sub>O credits. Note that § 86.1818–12(f) does not apply for vehicles subject to the standards of this section. Calculate credits using the

following equation, rounded to the nearest whole number:

$$CO_2 \text{ Credits Needed (Mg)} = [(FEL - Std) \times (U.S.-directed \text{ production volume}) \times (Useful \text{ Life})] \div 1,000,000$$

(d) *Compliance provisions.* The following compliance provisions apply instead of other provisions described in this subpart S:

(1) The CO<sub>2</sub> standards of this section apply with respect to CO<sub>2</sub> emissions, not with respect to carbon-related exhaust emissions (CREE).

(2) The following general credit provisions apply:

(i) Credits you generate under this section may be used only to offset credit deficits under this section. You may bank credits for use in a future model year in which your average CO<sub>2</sub> level exceeds the standard. You may trade credits to another manufacturer according to § 86.1865–12(k)(8). Before you bank or trade credits, you must apply any available credits to offset a deficit if the deadline to offset that credit deficit has not yet passed.

(ii) Vehicles subject to the standards of this section are included in a single greenhouse gas averaging set separate from any averaging set otherwise included in this subpart S.

(iii) Banked CO<sub>2</sub> credits keep their full value for five model years after the year in which they were generated. Unused credits may not be used for more than five model years after the model year in which the credits are generated.

(3) Special credit and incentive provisions related to air conditioning in §§ 86.1867 and 86.1868 do not apply for vehicles subject to the standards of this section.

(4) Measure emissions using the procedures of subpart B of this part and 40 CFR part 1066. Determine separate emission results for the Federal Test Procedure (FTP) described in 40 CFR 1066.801(c)(1) and the Highway Fuel Economy Test (HFET) described in 40 CFR 1066.801(c)(3). Calculate composite emission results from these two test cycles for demonstrating compliance with the CO<sub>2</sub>, N<sub>2</sub>O, and CH<sub>4</sub> standards based on a weighted average of the FTP (55%) and HFET (45%) emission results. Note that this differs from the way the criteria pollutant standards apply.

(5) Apply an additive deterioration factor of zero to measured CO<sub>2</sub> emissions unless good engineering judgment indicates that emissions are likely to deteriorate in use. Use good engineering judgment to develop separate deterioration factors for N<sub>2</sub>O and CH<sub>4</sub>.

(6) Credits are calculated using the useful life value (in miles) in place of

“vehicle lifetime miles” as specified in § 86.1865. Calculate a total credit or debit balance in a model year by adding credits and debits from § 86.1865–12(k)(4), subtracting any CO<sub>2</sub>-equivalent debits for N<sub>2</sub>O or CH<sub>4</sub> calculated according to paragraph (c) of this section, and adding any of the following credits:

(i) Off-cycle technology credits according to paragraph (d)(13) of this section.

(ii) Early credits from vehicles certified under paragraph (k)(2) of this section.

(iii) Advanced-technology credits according to paragraph (k)(7) of this section.

(7) [Reserved]

(8) The provisions of § 86.1818 do not apply.

(9) Calculate your fleet-average emission rate consistent with good engineering judgment and the provisions of § 86.1865. The following additional provisions apply:

(i) Unless we approve a lower number, you must test at least ten subconfigurations. If you produce more than 100 subconfigurations in a given model year, you must test at least ten percent of your subconfigurations. For purposes of this paragraph (d)(9)(i), count carryover tests, but do not include analytically derived CO<sub>2</sub> emission rates, data substitutions, or other untested allowances. We may approve a lower number of tests for manufacturers that have limited product offerings, or low sales volumes. Note that good engineering judgment and other provisions of this part may require you to test more subconfigurations than these minimum values.

(ii) The provisions of paragraph (g) of this section specify how you may use analytically derived CO<sub>2</sub> emission rates.

(iii) At least 90 percent of final production volume at the configuration level must be represented by test data (real, data substituted, or analytical).

(iv) Perform fleet-average CO<sub>2</sub> calculations as described in § 86.1865 and 40 CFR part 600, with the following exceptions:

(A) Use CO<sub>2</sub> emissions values for all test results, intermediate calculations, and fleet average calculations instead of the carbon-related exhaust emission (CREE) values specified in this subpart S and 40 CFR part 600.

(B) Perform intermediate CO<sub>2</sub> calculations for subconfigurations within each configuration using the subconfiguration and configuration definitions in paragraph (d)(12) of this section.

(C) Perform intermediate CO<sub>2</sub> calculations for configurations within

each test group and transmission type (instead of configurations within each base level and base levels within each model type). Use the configuration definition in paragraph (d)(12)(i) of this section.

(D) Do not perform intermediate CO<sub>2</sub> calculations for each base level or for each model type. Base level and model type CO<sub>2</sub> calculations are not applicable to heavy-duty vehicles subject to standards in this section.

(E) Determine fleet average CO<sub>2</sub> emissions for heavy-duty vehicles subject to standards in this section as described in 40 CFR 600.510–12(j), except that the calculations must be performed on the basis of test group and transmission type (instead of the model-type basis specified in the light-duty vehicle regulations), and the calculations for dual-fuel, multi-fuel, and flexible-fuel vehicles must be consistent with the provisions of paragraph (d)(10)(i) of this section.

(10) For dual-fuel, multi-fuel, and flexible-fuel vehicles, perform exhaust testing on each fuel type (for example, gasoline and E85).

(i) For your fleet-average calculations in model year 2016 and later, use either the conventional-fueled CO<sub>2</sub> emission rate or a weighted average of your emission results as specified in 40 CFR 600.510–12(k) for light-duty trucks. For your fleet-average calculations before model year 2016, apply an equal weighting of CO<sub>2</sub> emission results from alternative and conventional fuels.

(ii) If you certify to an alternate standard for N<sub>2</sub>O or CH<sub>4</sub> emissions, you may not exceed the alternate standard when tested on either fuel.

(11) Test your vehicles with an equivalent test weight based on its Adjusted Loaded Vehicle Weight (ALVW). Determine equivalent test weight from the ALVW as specified in 40 CFR 1066.805; round ALVW values

above 14,000 pounds to the nearest 500 pound increment.

(12) The following definitions apply for the purposes of this section:

(i) *Configuration* means a subclassification within a test group based on engine code, transmission type and gear ratios, final drive ratio, and other parameters we designate. Engine code means the combination of both “engine code” and “basic engine” as defined in 40 CFR 600.002.

(ii) *Subconfiguration* means a unique combination within a vehicle configuration (as defined in this paragraph (d)(12)) of equivalent test weight, road-load horsepower, and any other operational characteristics or parameters that we determine may significantly affect CO<sub>2</sub> emissions within a vehicle configuration. Note that for vehicles subject to standards of this section, equivalent test weight (ETW) is based on the ALVW of the vehicle as outlined in paragraph (d)(11) of this section.

(13) This paragraph (d)(13) applies for CO<sub>2</sub> reductions resulting from technologies that were not in common use before 2010 that are not reflected in the specified test procedures. While you are not required to prove that such technologies were not in common use with heavy-duty vehicles before model year 2010, we will not approve your request if we determine they do not qualify. These may be described as off-cycle or innovative technologies. We may allow you to generate emission credits consistent with the provisions of § 86.1869–12(c) and (d). The 5-cycle methodology is not presumed to be preferred over alternative methodologies described in § 86.1869–12(d).

(14) You must submit pre-model year reports before you submit your applications for certification for a given model year. Unless we specify

otherwise, include the information specified for pre-model year reports in 49 CFR 535.8.

(15) You must submit a final report within 90 days after the end of the model year. Unless we specify otherwise, include applicable information identified in § 86.1865–12(l), 40 CFR 600.512, and 49 CFR 535.8(e). The final report must include at least the following information:

- (i) Model year.
- (ii) Applicable fleet-average CO<sub>2</sub> standard.
- (iii) Calculated fleet-average CO<sub>2</sub> value and all the values required to calculate the CO<sub>2</sub> value.
- (iv) Number of credits or debits incurred and all values required to calculate those values.
- (v) Resulting balance of credits or debits.
- (vi) N<sub>2</sub>O emissions.
- (vii) CH<sub>4</sub> emissions.
- (viii) Total and percent leakage rates under paragraph (h) of this section.

(16) You may apply the provisions for delegated assembly as described in 40 CFR 1037.621.

(17) You may calculate emission rates for weight increments less than the 500 pound increment specified for test weight. This does not change the applicable test weights.

(i) Use the ADC equation in paragraph (g) of this section to adjust your emission rates for vehicles in increments of 50, 100, or 250 pounds instead of the 500 test-weight increments. Adjust emissions to the midpoint of each increment. This is the equivalent emission weight. For example, vehicles with a test weight basis of 11,751 to 12,250 pounds (which have an equivalent test weight of 12,000 pounds) could be regrouped into 100 pound increments as follows:

Test weight basis	Equivalent emission weight	Equivalent test weight
11,751–11,850 .....	11,800	12,000
11,851–11,950 .....	11,900	12,000
11,951–12,050 .....	12,000	12,000
12,051–12,150 .....	12,100	12,000
12,151–12,250 .....	12,200	12,000

(ii) You must use the same increment for all equivalent test weight classes across your whole product line in a given model year. You must also specify curb weight for calculating the work factor in a way that is consistent with your approach for determining test weight for calculating ADCs under this paragraph (d)(17).

(e) *Useful life*. The exhaust emission standards of this section apply for the full useful life, as described in § 86.1805.

(f) [Reserved]

(g) *Analytically derived CO<sub>2</sub> emission rates (ADCs)*. This paragraph (g) describes an allowance to use estimated (*i.e.*, analytically derived) CO<sub>2</sub> emission

rates based on baseline test data instead of measured emission rates for calculating fleet-average emissions. Note that these ADCs are similar to ADFEs used for light-duty vehicles. Note also that *F* terms used in this paragraph (g) represent coefficients from the following road load equation:

$$Force = F_0 + F_1 \cdot (velocity) + F_2 \cdot (velocity)^2$$

(1) Except as specified in paragraph (g)(2) of this section, use the following equation to calculate the ADC of a new vehicle from road load force coefficients ( $F_0$ ,  $F_1$ ,  $F_2$ ), axle ratio, and test weight:

$$ADC = CO_{2\text{base}} + 2.18 \cdot \Delta F_0 + 37.4 \cdot \Delta F_1 + 2257 \cdot \Delta F_2 + 189 \cdot \Delta AR + 0.0222 \cdot \Delta ETW$$

Where:

$ADC$  = Analytically derived combined city/highway  $CO_2$  emission rate (g/mile) for a new vehicle.

$CO_{2\text{base}}$  = Combined city/highway  $CO_2$  emission rate (g/mile) of a baseline vehicle.

$\Delta F_0$  =  $F_0$  of the new vehicle –  $F_0$  of the baseline vehicle.

$\Delta F_1$  =  $F_1$  of the new vehicle –  $F_1$  of the baseline vehicle.

$\Delta F_2$  =  $F_2$  of the new vehicle –  $F_2$  of the baseline vehicle.

$\Delta AR$  = Axle ratio of the new vehicle – axle ratio of the baseline vehicle.

$\Delta ETW$  =  $ETW$  of the new vehicle –  $ETW$  of the baseline vehicle.

(2) The purpose of this section is to accurately estimate  $CO_2$  emission rates.

(i) You must apply the provisions of this section consistent with good engineering judgment. For example, do not use the equation in paragraph (g)(1) of this section where good engineering judgment indicates that it will not accurately estimate emissions. You may ask us to approve alternate equations that allow you to estimate emissions more accurately.

(ii) The analytically derived  $CO_2$  equation in paragraph (g)(1) of this section may be periodically updated through publication of an EPA guidance document to more accurately characterize  $CO_2$  emission levels for example, changes may be appropriate based on new test data, future technology changes, or to changes in future  $CO_2$  emission levels. Any EPA guidance document will determine the model year that the updated equation takes effect. We will issue guidance no later than eight months before the effective model year. For example, model year 2014 may start January 2, 2013, so guidance for model year 2014 would be issued by May 1, 2012.

(3) You may select baseline test data without our advance approval if they meet all the following criteria:

(i) Vehicles considered for the baseline test must comply with all applicable emission standards in the model year associated with the ADC.

(ii) You must include in the pool of tests considered for baseline selection all official tests of the same or equivalent basic engine, transmission class, engine code, transmission code,

engine horsepower, dynamometer drive wheels, and compression ratio as the ADC subconfiguration. Do not include tests in which emissions exceed any applicable standard.

(iii) Where necessary to minimize the  $CO_2$  adjustment, you may supplement the pool with tests associated with worst-case engine or transmission codes and carryover or carry-across test groups. If you do, all the data that qualify for inclusion using the elected worst-case substitution (or carryover or carry-across) must be included in the pool as supplemental data (*i.e.*, individual test vehicles may not be selected for inclusion). You must also include the supplemental data in all subsequent pools, where applicable.

(iv) Tests previously used during the subject model year as baseline tests in ten other ADC subconfigurations must be eliminated from the pool.

(v) Select the tested subconfiguration with the smallest absolute difference between the ADC and the test  $CO_2$  emission rate for combined emissions. Use this as the baseline test for the target ADC subconfiguration.

(4) You may ask us to allow you to use baseline test data not fully meeting the provisions of paragraph (g)(3) of this section.

(5) Calculate the ADC rounded to the nearest whole g/mile. Except with our advance approval, the downward adjustment of ADC from the baseline is limited to ADC values 20 percent below the baseline emission rate. The upward adjustment is not limited.

(6) You may not submit an ADC if an actual test has been run on the target subconfiguration during the certification process or on a development vehicle that is eligible to be declared as an emission-data vehicle.

(7) No more than 40 percent of the subconfigurations tested in your final  $CO_2$  submission may be represented by ADCs.

(8) Keep the following records for at least five years, and show them to us if we ask to see them:

(i) The pool of tests.

(ii) The vehicle description and tests chosen as the baseline and the basis for the selection.

(iii) The target ADC subconfiguration.

(iv) The calculated emission rates.

(9) We may perform or order a confirmatory test of any subconfiguration covered by an ADC.

(10) Where we determine that you did not fully comply with the provisions of this paragraph (g), we may require that you comply based on actual test data and that you recalculate your fleet-average emission rate.

(h) *Air conditioning leakage.* Loss of refrigerant from your air conditioning systems may not exceed a total leakage rate of 11.0 grams per year or a percent leakage rate of 1.50 percent per year, whichever is greater. This applies for all refrigerants. Calculate the total leakage rate in g/year as specified in § 86.1867–12(a). Calculate the percent leakage rate as: [total leakage rate (g/yr)] ÷ [total refrigerant capacity (g)] × 100. Round your percent leakage rate to the nearest one-hundredth of a percent. For purpose of this requirement, “refrigerant capacity” is the total mass of refrigerant recommended by the vehicle manufacturer as representing a full charge. Where full charge is specified as a pressure, use good engineering judgment to convert the pressure and system volume to a mass.

(i) [Reserved]

(j) *Optional GHG certification under this subpart.* You may certify certain complete or cab-complete vehicles to the GHG standards of this section. All vehicles optionally certified under this paragraph (j) are deemed to be subject to the GHG standards of this section. Note that for vehicles above 14,000 pounds GVWR and at or below 26,000 pounds GVWR, GHG certification under this paragraph (j) does not affect how you may or may not certify with respect to criteria pollutants.

(1) For GHG compliance, you may certify any complete or cab-complete spark-ignition vehicles above 14,000 pounds GVWR and at or below 26,000 pounds GVWR to the GHG standards of this section even though this section otherwise specifies that you may certify vehicles to the GHG standards of this section only if they are chassis-certified for criteria pollutants.

(2) You may apply the provisions of this section to cab-complete vehicles based on a complete sister vehicle. In unusual circumstances, you may ask us to apply these provisions to Class 2b or Class 3 incomplete vehicles that do not meet the definition of cab-complete.

(i) Except as specified in paragraph (j)(3) of this section, for purposes of this section, a complete sister vehicle is a complete vehicle of the same vehicle configuration as the cab-complete vehicle. You may not apply the provisions of this paragraph (j) to any vehicle configuration that has a four-wheel rear axle if the complete sister vehicle has a two-wheel rear axle.

(ii) Calculate the target value for fleet-average  $CO_2$  emissions under paragraph (a) or (k)(4) of this section based on the work factor value that applies for the complete sister vehicle.

(iii) Test these cab-complete vehicles using the same equivalent test weight

and other dynamometer settings that apply for the complete vehicle from which you used the work factor value (the complete sister vehicle). For GHG certification, you may submit the test data from that complete sister vehicle instead of performing the test on the cab-complete vehicle.

(iv) You are not required to produce the complete sister vehicle for sale to use the provisions of this paragraph (j)(2). This means the complete sister vehicle may be a carryover vehicle from a prior model year or a vehicle created solely for the purpose of testing.

(3) For GHG purposes, if a cab-complete vehicle is not of the same vehicle configuration as a complete sister vehicle due only to certain factors unrelated to coastdown performance, you may use the road-load coefficients from the complete sister vehicle for certification testing of the cab-complete vehicle, but you may not use emission data from the complete sister vehicle for certifying the cab-complete vehicle.

(k) *Interim provisions.* The following provisions apply instead of other provisions in this subpart:

(1) *Incentives for early introduction.* Manufacturers may voluntarily certify in model year 2013 (or earlier model years for electric vehicles) to the greenhouse gas standards that apply starting in model year 2014 as specified in 40 CFR 1037.150(a).

(2) *Early credits.* To generate early credits under this paragraph (k)(2) for any vehicles other than electric vehicles, you must certify your entire U.S.-directed fleet to these standards. If you calculate a separate fleet average for advanced-technology vehicles under paragraph (k)(7) of this section, you must certify your entire U.S.-directed production volume of both advanced and conventional vehicles within the fleet. If some test groups are certified after the start of the model year, you may generate credits only for production that occurs after all test groups are certified. For example, if you produce three test groups in an averaging set and you receive your certificates for those test groups on January 4, 2013, March 15, 2013, and April 24, 2013, you may not generate credits for model year 2013 for vehicles from any of the test groups produced

before April 24, 2013. Calculate credits relative to the standard that would apply in model year 2014 using the applicable equations in this subpart and your model year 2013 U.S.-directed production volumes. These credits may be used to show compliance with the standards of this subpart for 2014 and later model years. We recommend that you notify us of your intent to use this provision before submitting your applications.

(3) *Compliance date.* Compliance with the standards of this section was optional before January 1, 2014 as specified in 40 CFR 1037.150(g).

(4) *Phase-in provisions.* Each manufacturer must choose one of the options specified in paragraphs (k)(4)(i) and (ii) of this section for phasing in the Phase 1 standards. Manufacturers must follow the schedule described in paragraph (k)(4)(iii) of this section for phasing in the Phase 2 standards.

(i) *Phase 1—Option 1.* You may implement the Phase 1 standards by applying CO<sub>2</sub> target values as specified in the following table for model year 2014 through 2020 vehicles:

TABLE 1 OF § 86.1819–14

Model year and engine cycle	Alternate CO <sub>2</sub> target (g/mile)
2014 Spark-Ignition .....	0.0482 × (WF) + 371
2015 Spark-Ignition .....	0.0479 × (WF) + 369
2016 Spark-Ignition .....	0.0469 × (WF) + 362
2017 Spark-Ignition .....	0.0460 × (WF) + 354
2018–2020 Spark-Ignition .....	0.0440 × (WF) + 339
2014 Compression-Ignition .....	0.0478 × (WF) + 368
2015 Compression-Ignition .....	0.0474 × (WF) + 366
2016 Compression-Ignition .....	0.0460 × (WF) + 354
2017 Compression-Ignition .....	0.0445 × (WF) + 343
2018–2020 Compression-Ignition .....	0.0416 × (WF) + 320

(ii) *Phase 1—Option 2.* You may implement the Phase 1 standards by applying CO<sub>2</sub> target values specified in

the following table for model year 2014 through 2020 vehicles:

TABLE 2 OF § 86.1819–14

Model year and engine cycle	Alternate CO <sub>2</sub> target (g/mile)
2014 Spark-Ignition .....	0.0482 × (WF) + 371
2015 Spark-Ignition .....	0.0479 × (WF) + 369
2016–2018 Spark-Ignition .....	0.0456 × (WF) + 352
2019–2020 Spark-Ignition .....	0.0440 × (WF) + 339
2014 Compression-Ignition .....	0.0478 × (WF) + 368
2015 Compression-Ignition .....	0.0474 × (WF) + 366
2016–2018 Compression-Ignition .....	0.0440 × (WF) + 339
2019–2020 Compression-Ignition .....	0.0416 × (WF) + 320

(iii) *Phase 2.* Apply Phase 2 CO<sub>2</sub> target values as specified in the following

table for model year 2021 through 2026 vehicles:

TABLE 3 OF § 86.1819–14

Model year and engine cycle	Alternate CO <sub>2</sub> target (g/mile)
2021 Spark-Ignition .....	0.0429 × (WF) + 331
2022 Spark-Ignition .....	0.0418 × (WF) + 322
2023 Spark-Ignition .....	0.0408 × (WF) + 314
2024 Spark-Ignition .....	0.0398 × (WF) + 306
2025 Spark-Ignition .....	0.0388 × (WF) + 299
2026 Spark-Ignition .....	0.0378 × (WF) + 291
2021 Compression-Ignition .....	0.0406 × (WF) + 312
2022 Compression-Ignition .....	0.0395 × (WF) + 304
2023 Compression-Ignition .....	0.0386 × (WF) + 297
2024 Compression-Ignition .....	0.0376 × (WF) + 289
2025 Compression-Ignition .....	0.0367 × (WF) + 282
2026 Compression-Ignition .....	0.0357 × (WF) + 275

(5) *Provisions for small manufacturers.* Standards apply on a delayed schedule for manufacturers meeting the small business criteria specified in 13 CFR 121.201 (NAICS code 336111); the employee and revenue limits apply to the total number employees and total revenue together for affiliated companies. Qualifying small manufacturers are not subject to the greenhouse gas standards of this section for vehicles with a date of manufacture before January 1, 2022, as specified in 40 CFR 1037.150(c). In addition, small manufacturers producing vehicles that run on any fuel other than gasoline, E85, or diesel fuel may delay complying with every later standard under this part by one model year.

(6) *Alternate N<sub>2</sub>O standards.* Manufacturers may show compliance with the N<sub>2</sub>O standards using an engineering analysis. This allowance also applies for model year 2015 and later test groups carried over from model 2014 consistent with the provisions of § 86.1839. You may not certify to an N<sub>2</sub>O FEL different than the standard without measuring N<sub>2</sub>O emissions.

(7) *Advanced-technology credits.* Provisions for advanced-technology credits apply as described in 40 CFR 1037.615. If you generate credits from Phase 1 vehicles certified with advanced technology, you may multiply these credits by 1.50. If you generate credits from Phase 2 vehicles certified with advanced technology, you may multiply these credits by 3.5 for plug-in hybrid electric vehicles, 4.5 for electric vehicles, and 5.5 for fuel cell vehicles. Advanced-technology credits from Phase 1 vehicles may be used to show compliance with any standards of this part or 40 CFR part 1036 or part 1037, subject to the restrictions in 40 CFR 1037.740. Similarly, you may use up to 60,000 Mg per year of advanced-technology credits generated under 40

CFR 1036.615 or 1037.615 (from Phase 1 vehicles) to demonstrate compliance with the CO<sub>2</sub> standards in this section. Include vehicles generating credits in separate fleet-average calculations (and exclude them from your conventional fleet-average calculation). You must first apply these advanced-technology vehicle credits to any deficits for other vehicles in the averaging set before applying them to other averaging sets.

(8) *Loose engine sales.* This paragraph (k)(8) applies for model year 2023 and earlier spark-ignition engines with identical hardware compared with engines used in vehicles certified to the standards of this section, where you sell such engines as loose engines or as engines installed in incomplete vehicles that are not cab-complete vehicles. You may include such engines in a test group certified to the standards of this section, subject to the following provisions:

(i) Engines certified under this paragraph (k)(8) are deemed to be certified to the standards of 40 CFR 1036.108 as specified in 40 CFR 1036.150(j).

(ii) For 2020 and earlier model years, the maximum allowable U.S.-directed production volume of engines you sell under this paragraph (k)(8) in any given model year is ten percent of the total U.S.-directed production volume of engines of that design that you produce for heavy-duty applications for that model year, including engines you produce for complete vehicles, cab-complete vehicles, and other incomplete vehicles. The total number of engines you may certify under this paragraph (k)(8), of all engine designs, may not exceed 15,000 in any model year. Engines produced in excess of either of these limits are not covered by your certificate. For example, if you produce 80,000 complete model year 2017 Class 2b pickup trucks with a certain engine and 10,000 incomplete model year 2017 Class 3 vehicles with that same engine,

and you do not apply the provisions of this paragraph (k)(8) to any other engine designs, you may produce up to 10,000 engines of that design for sale as loose engines under this paragraph (k)(8). If you produced 11,000 engines of that design for sale as loose engines, the last 1,000 of them that you produced in that model year 2017 would be considered uncertified.

(iii) For model years 2021 through 2023, the U.S.-directed production volume of engines you sell under this paragraph (k)(8) in any given model year may not exceed 10,000 units.

(iv) This paragraph (k)(8) does not apply for engines certified to the standards of 40 CFR 1036.108.

(v) Label the engines as specified in 40 CFR 1036.135 including the following compliance statement: “THIS ENGINE WAS CERTIFIED TO THE ALTERNATE GREENHOUSE GAS EMISSION STANDARDS OF 40 CFR 1036.150(j).” List the test group name instead of an engine family name.

(vi) Vehicles using engines certified under this paragraph (k)(8) are subject to the emission standards of 40 CFR 1037.105.

(vii) For certification purposes, your engines are deemed to have a CO<sub>2</sub> target value and test result equal to the CO<sub>2</sub> target value and test result for the complete vehicle in the applicable test group with the highest equivalent test weight, except as specified in paragraph (k)(8)(vii)(B) of this section. Use these values to calculate your target value, fleet-average emission rate, and in-use emission standard. Where there are multiple complete vehicles with the same highest equivalent test weight, select the CO<sub>2</sub> target value and test result as follows:

(A) If one or more of the CO<sub>2</sub> test results exceed the applicable target value, use the CO<sub>2</sub> target value and test result of the vehicle that exceeds its target value by the greatest amount.

(B) If none of the CO<sub>2</sub> test results exceed the applicable target value, select the highest target value and set the test result equal to it. This means that you may not generate emission credits from vehicles certified under this paragraph (k)(8).

(viii) Production and in-use CO<sub>2</sub> standards apply as described in paragraph (b) of this section.

(ix) N<sub>2</sub>O and CH<sub>4</sub> standards apply as described in paragraph (c) of this section.

(x) State in your applications for certification that your test group and engine family will include engines certified under this paragraph (k)(8). This applies for your greenhouse gas vehicle test group and your criteria pollutant engine family. List in each application the name of the corresponding test group/engine family.

(9) *Credit adjustment for useful life.* For credits that you calculate based on a useful life of 120,000 miles, multiply any banked credits that you carry forward for use in model year 2021 and later by 1.25.

(10) *CO<sub>2</sub> rounding.* For model year 2014 and earlier vehicles, you may round measured and calculated CO<sub>2</sub> emission levels to the nearest 0.1 g/mile, instead of the nearest whole g/mile as specified in paragraphs (a), (b), and (g) of this section.

■ 75. Section 86.1820–01 is amended by revising paragraph (b)(7)(i)(A) to read as follows:

**§ 86.1820–01 Durability group determination.**

\* \* \* \* \*

- (b) \* \* \*
- (7) \* \* \*
- (i) \* \* \*

(A) Vehicles are grouped based upon the value of the grouping statistic determined using the following equation:

$$GS = [(Cat Vol)/(Disp)] \times Loading Rate$$

Where:

GS = Grouping Statistic used to evaluate the range of precious metal loading rates and relative sizing of the catalysts compared to the engine displacement that are allowable within a durability group. The grouping statistic shall be rounded to a tenth of a gram/liter.

Cat Vol = Total volume of the catalyst(s) in liters.

Disp = Displacement of the engine in liters.

Loading rate = The mass of total precious metal(s) in the catalyst (or the total mass of all precious metal(s) of all the catalysts if the vehicle is equipped with multiple catalysts) in grams divided by the total volume of the catalyst(s) in liters.

\* \* \* \* \*

■ 76. Section 86.1823–08 is amended by revising the definition of “R” in paragraph (d)(3) to read as follows:

**§ 86.1823–08 Durability demonstration procedures for exhaust emissions.**

\* \* \* \* \*

- (d) \* \* \*
- (3) \* \* \*

R = Catalyst thermal reactivity coefficient. You may use a default value of 17,500 for the SBC.

\* \* \* \* \*

■ 77. Section 86.1838–01 is amended by revising paragraph (b)(1)(i)(B), adding paragraph (b)(1)(i)(C), and revising paragraph (d)(3)(iii) introductory text to read as follows:

**§ 86.1838–01 Small-volume manufacturer certification procedures.**

\* \* \* \* \*

- (b) \* \* \*
- (1) \* \* \*
- (i) \* \* \*

(B) No small-volume sales threshold applies for the heavy-duty greenhouse gas standards; alternative small-volume criteria apply as described in § 86.1819–14(k)(5).

(C) 15,000 units for all other requirements. See § 86.1845 for separate provisions that apply for in-use testing.

\* \* \* \* \*

- (d) \* \* \*
- (3) \* \* \*

(iii) Notwithstanding the requirements of paragraph (d)(3)(ii) of this section, an applicant may satisfy the requirements of this paragraph (d)(3) if the requirements of this paragraph (d)(3) are completed by an auditor who is an employee of the applicant, provided that such employee:

\* \* \* \* \*

■ 78. Section 86.1844–01 is amended by revising paragraph (d)(4)(ii) and adding paragraph (d)(7)(iv) to read as follows:

**§ 86.1844–01 Information requirements: Application for certification and submittal of information upon request.**

\* \* \* \* \*

- (d) \* \* \*
- (4) \* \* \*

(ii) The equivalency factor required to be calculated in § 86.1823–08(e)(1)(iii)(B), when applicable.

\* \* \* \* \*

- (7) \* \* \*

(iv) For heavy-duty vehicles subject to air conditioning standards under § 86.1819, include the refrigerant leakage rates (leak scores), describe the type of refrigerant, and identify the refrigerant capacity of the air conditioning systems. If another company will install the air

conditioning system, also identify the corporate name of the final installer.

\* \* \* \* \*

■ 79. Section 86.1845–04 is amended by revising paragraph (f)(1) to read as follows:

**§ 86.1845–04 Manufacturer in-use verification testing requirements.**

\* \* \* \* \*

(f)(1) A manufacturer must conduct in-use testing on a test group by determining NMOG exhaust emissions using the same methodology used for certification, as described in § 86.1810–01(o) or 40 CFR 1066.635.

\* \* \* \* \*

■ 80. Section 86.1846–01 is amended by revising paragraph (b)(1)(i) to read as follows:

**§ 86.1846–01 Manufacturer in-use confirmatory testing requirements.**

\* \* \* \* \*

- (b) \* \* \*
- (1) \* \* \*

(i) Additional testing is not required under this paragraph (b)(1) based on evaporative/refueling testing or based on low-mileage Supplemental FTP testing conducted under § 86.1845–04(b)(5)(i). Testing conducted at high altitude under the requirements of § 86.1845–04(c) will be included in determining if a test group meets the criteria triggering the testing required under this section.

\* \* \* \* \*

■ 81. Section 86.1848–10 is amended by revising paragraph (c)(9) to read as follows:

**§ 86.1848–10 Compliance with emission standards for the purpose of certification.**

\* \* \* \* \*

- (c) \* \* \*

(9) For 2012 and later model year LDVs, LDTs, and MDPVs, all certificates of conformity issued are conditional upon compliance with all provisions of §§ 86.1818 and 86.1865 both during and after model year production. Similarly, for 2014 and later model year HDV, and other HDV subject to standards under § 86.1819, all certificates of conformity issued are conditional upon compliance with all provisions of §§ 86.1819 and 86.1865 both during and after model year production. The manufacturer bears the burden of establishing to the satisfaction of the Administrator that the terms and conditions upon which the certificate(s) was (were) issued were satisfied. For recall and warranty purposes, vehicles not covered by a certificate of conformity will continue to be held to the standards stated or referenced in the certificate that

otherwise would have applied to the vehicles.

(i) Failure to meet the fleet average CO<sub>2</sub> requirements will be considered a failure to satisfy the terms and conditions upon which the certificate(s) was (were) issued and the vehicles sold in violation of the fleet average CO<sub>2</sub> standard will not be covered by the certificate(s). The vehicles sold in violation will be determined according to § 86.1865–12(k)(8).

(ii) Failure to comply fully with the prohibition against selling credits that are not generated or that are not available, as specified in § 86.1865–12, will be considered a failure to satisfy the terms and conditions upon which the certificate(s) was (were) issued and the vehicles sold in violation of this prohibition will not be covered by the certificate(s).

(iii) For manufacturers using the conditional exemption under § 86.1801–12(k), failure to fully comply with the fleet production thresholds that determine eligibility for the exemption will be considered a failure to satisfy the terms and conditions upon which the certificate(s) was (were) issued and the vehicles sold in violation of the stated sales and/or production thresholds will not be covered by the certificate(s).

(iv) For manufacturers that are determined to be operationally independent under § 86.1838–01(d), failure to report a material change in their status within 60 days as required by § 86.1838–01(d)(2) will be considered a failure to satisfy the terms and conditions upon which the certificate(s) was (were) issued and the vehicles sold in violation of the operationally independent criteria will not be covered by the certificate(s).

(v) For manufacturers subject to an alternative fleet average greenhouse gas emission standard approved under § 86.1818–12(g), failure to comply with the annual sales thresholds that are required to maintain use of those standards, including the thresholds required for new entrants into the U.S. market, will be considered a failure to satisfy the terms and conditions upon which the certificate(s) was (were) issued and the vehicles sold in violation of stated sales and/or production thresholds will not be covered by the certificate(s).

\* \* \* \* \*

■ 82. Section 86.1853–01 is revised to read as follows:

**§ 86.1853–01 Certification hearings.**

If a manufacturer's request for a hearing is approved, EPA will follow the hearing procedures specified in 40 CFR part 1068, subpart G.

■ 83. Section 86.1862–04 is amended by revising paragraph (d) to read as follows:

**§ 86.1862–04 Maintenance of records and submittal of information relevant to compliance with fleet-average standards.**

\* \* \* \* \*

(d) *Notice of opportunity for hearing.* Any voiding of the certificate under paragraph (a)(6) of this section will be made only after EPA has offered the manufacturer concerned an opportunity for a hearing conducted in accordance with 40 CFR part 1068, subpart G and, if a manufacturer requests such a hearing, will be made only after an initial decision by the Presiding Officer.

**§ 86.1863–07 [Amended]**

■ 84. Section 86.1863–07 is amended by removing and reserving paragraph (h).

■ 85. Section 86.1865–12 is revised to read as follows:

**§ 86.1865–12 How to comply with the fleet average CO<sub>2</sub> standards.**

(a) *Applicability.* (1) Unless otherwise exempted under the provisions of paragraph (d) of this section, CO<sub>2</sub> fleet average exhaust emission standards of this subpart apply to:

(i) 2012 and later model year passenger automobiles and light trucks.

(ii) Heavy-duty vehicles subject to standards under § 86.1819.

(iii) Vehicles imported by ICIs as defined in 40 CFR 85.1502.

(2) The terms “passenger automobile” and “light truck” as used in this section have the meanings given in § 86.1818–12.

(b) *Useful life requirements.* Full useful life requirements for CO<sub>2</sub> standards are defined in §§ 86.1818 and 86.1819. There is not an intermediate useful life standard for CO<sub>2</sub> emissions.

(c) *Altitude.* Greenhouse gas emission standards apply for testing at both low-altitude conditions and at high-altitude conditions, as described in §§ 86.1818 and 86.1819.

(d) *Small volume manufacturer certification procedures.* (1) *Passenger automobiles and light trucks.* Certification procedures for small volume manufacturers are provided in § 86.1838. Small businesses meeting certain criteria may be exempted from the greenhouse gas emission standards in § 86.1818 according to the provisions of § 86.1801–12(j) or (k).

(2) *Heavy-duty vehicles.* HDV manufacturers that qualify as small businesses are not subject to the Phase 1 greenhouse gas standards of this subpart as specified in § 86.1819–14(k)(5).

(e) *CO<sub>2</sub> fleet average exhaust emission standards.* The fleet average standards

referred to in this section are the corporate fleet average CO<sub>2</sub> standards for passenger automobiles and light trucks set forth in § 86.1818–12(c) and (e), and for HDV in § 86.1819. Each manufacturer must comply with the applicable CO<sub>2</sub> fleet average standard on a production-weighted average basis, for each separate averaging set, at the end of each model year, using the procedure described in paragraph (j) of this section. The fleet average CO<sub>2</sub> standards applicable in a given model year are calculated separately for passenger automobiles and light trucks for each manufacturer and each model year according to the provisions in § 86.1818. Calculate the HDV fleet average CO<sub>2</sub> standard in a given model year as described in § 86.1819–14(a).

(f) *In-use CO<sub>2</sub> standards.* In-use CO<sub>2</sub> exhaust emission standards are provided in § 86.1818–12(d) for passenger automobiles and light trucks and in § 86.1819–14(b) for HDV.

(g) *Durability procedures and method of determining deterioration factors (DFs).* Deterioration factors for CO<sub>2</sub> exhaust emission standards are provided in § 86.1823–08(m) for passenger automobiles and light trucks and in § 86.1819–14(d)(5) for HDV.

(h) *Vehicle test procedures.* (1) The test procedures for demonstrating compliance with CO<sub>2</sub> exhaust emission standards are described at § 86.101 and 40 CFR part 600, subpart B.

(2) Testing to determine compliance with CO<sub>2</sub> exhaust emission standards must be on a loaded vehicle weight (LVW) basis for passenger automobiles and light trucks (including MDPV), and on an adjusted loaded vehicle weight (ALVW) basis for non-MDPV heavy-duty vehicles.

(3) Testing for the purpose of providing certification data is required only at low-altitude conditions. If hardware and software emission control strategies used during low-altitude condition testing are not used similarly across all altitudes for in-use operation, the manufacturer must include a statement in the application for certification, in accordance with § 86.1844–01(d)(11), stating what the different strategies are and why they are used.

(i) *Calculating fleet average carbon-related exhaust emissions for passenger automobiles and light trucks.* (1) Manufacturers must compute separate production-weighted fleet average carbon-related exhaust emissions at the end of the model year for passenger automobiles and light trucks, using actual production, where production means vehicles produced and delivered for sale, and certifying model types to



standards as defined in § 86.1818–12. The model type carbon-related exhaust emission results determined according to 40 CFR part 600, subpart F (in units of grams per mile rounded to the nearest whole number) become the certification standard for each model type.

(2) Manufacturers must separately calculate production-weighted fleet average carbon-related exhaust emissions levels for the following averaging sets according to the provisions of 40 CFR part 600, subpart F:

(i) Passenger automobiles subject to the fleet average CO<sub>2</sub> standards specified in § 86.1818–12(c)(2);

(ii) Light trucks subject to the fleet average CO<sub>2</sub> standards specified in § 86.1818–12(c)(3);

(iii) Passenger automobiles subject to the Temporary Leadtime Allowance Alternative Standards specified in § 86.1818–12(e), if applicable; and

(iv) Light trucks subject to the Temporary Leadtime Allowance Alternative Standards specified in § 86.1818–12(e), if applicable.

(j) *Certification compliance and enforcement requirements for CO<sub>2</sub> exhaust emission standards.*

(1) Compliance and enforcement requirements are provided in this section and § 86.1848–10(c)(9).

(2) The certificate issued for each test group requires all model types within that test group to meet the in-use emission standards to which each model type is certified. The in-use standards for passenger automobiles and light duty trucks (including MDPV) are described in § 86.1818–12(d). The in-use standards for non-MDPV heavy-duty vehicles are described in § 86.1819–14(b).

(3) Each manufacturer must comply with the applicable CO<sub>2</sub> fleet average standard on a production-weighted average basis, at the end of each model year. Use the procedure described in paragraph (i) of this section for passenger automobiles and light trucks (including MDPV). Use the procedure described in § 86.1819–14(d)(9)(iv) for non-MDPV heavy-duty vehicles.

(4) Each manufacturer must comply on an annual basis with the fleet average standards as follows:

(i) Manufacturers must report in their annual reports to the Agency that they met the relevant corporate average standard by showing that the applicable production-weighted average CO<sub>2</sub> emission levels are at or below the applicable fleet average standards; or

(ii) If the production-weighted average is above the applicable fleet average standard, manufacturers must obtain and apply sufficient CO<sub>2</sub> credits as

authorized under paragraph (k)(8) of this section. A manufacturer must show that they have offset any exceedance of the corporate average standard via the use of credits. Manufacturers must also include their credit balances or deficits in their annual report to the Agency.

(iii) If a manufacturer fails to meet the corporate average CO<sub>2</sub> standard for four consecutive years, the vehicles causing the corporate average exceedance will be considered not covered by the certificate of conformity (see paragraph (k)(8) of this section). A manufacturer will be subject to penalties on an individual-vehicle basis for sale of vehicles not covered by a certificate.

(iv) EPA will review each manufacturer's production to designate the vehicles that caused the exceedance of the corporate average standard. EPA will designate as nonconforming those vehicles in test groups with the highest certification emission values first, continuing until reaching a number of vehicles equal to the calculated number of noncomplying vehicles as determined in paragraph (k)(8) of this section. In a group where only a portion of vehicles would be deemed nonconforming, EPA will determine the actual nonconforming vehicles by counting backwards from the last vehicle produced in that test group. Manufacturers will be liable for penalties for each vehicle sold that is not covered by a certificate.

(k) *Requirements for the CO<sub>2</sub> averaging, banking and trading (ABT) program.* (1) A manufacturer whose CO<sub>2</sub> fleet average emissions exceed the applicable standard must complete the calculation in paragraph (k)(4) of this section to determine the size of its CO<sub>2</sub> deficit. A manufacturer whose CO<sub>2</sub> fleet average emissions are less than the applicable standard may complete the calculation in paragraph (k)(4) of this section to generate CO<sub>2</sub> credits. In either case, the number of credits or debits must be rounded to the nearest whole number.

(2) There are no property rights associated with CO<sub>2</sub> credits generated under this subpart. Credits are a limited authorization to emit the designated amount of emissions. Nothing in this part or any other provision of law should be construed to limit EPA's authority to terminate or limit this authorization through a rulemaking.

(3) Each manufacturer must comply with the reporting and recordkeeping requirements of paragraph (l) of this section for CO<sub>2</sub> credits, including early credits. The averaging, banking and trading program is enforceable through the certificate of conformity that allows

the manufacturer to introduce any regulated vehicles into U.S. commerce.

(4) Credits are earned on the last day of the model year. Manufacturers must calculate, for a given model year and separately for passenger automobiles, light trucks, and heavy-duty vehicles, the number of credits or debits it has generated according to the following equation rounded to the nearest megagram:

$$CO_2 \text{ Credits or Debits (Mg)} = [(CO_2 \text{ Standard} - \text{Manufacturer's Production-Weighted Fleet Average } CO_2 \text{ Emissions}) \times (\text{Total Number of Vehicles Produced}) \times (\text{Mileage})] \div 1,000,000$$

Where:

*CO<sub>2</sub> Standard* = the applicable standard for the model year as determined in § 86.1818 or § 86.1819;

*Manufacturer's Production-Weighted Fleet Average CO<sub>2</sub> Emissions* = average calculated according to paragraph (i) of this section;

*Total Number of Vehicles Produced* = the number of vehicles domestically produced plus those imported as defined in § 600.511–08 of this chapter; and

*Mileage* = useful life value (in miles) for HDV, and vehicle lifetime miles of 195,264 for passenger automobiles and 225,865 for light trucks.

(5) Determine total HDV debits and credits for a model year as described in § 86.1819–14(d)(6). Determine total passenger car and light truck debits and credits for a model year as described in this paragraph (k)(5). Total credits or debits generated in a model year, maintained and reported separately for passenger automobiles and light trucks, shall be the sum of the credits or debits calculated in paragraph (k)(4) of this section and any of the following credits, if applicable, minus any CO<sub>2</sub>-equivalent debits for N<sub>2</sub>O and/or CH<sub>4</sub> calculated according to the provisions of § 86.1818–12(f)(4):

(i) Air conditioning leakage credits earned according to the provisions of § 86.1867–12(b).

(ii) Air conditioning efficiency credits earned according to the provisions of § 86.1868–12(c).

(iii) Off-cycle technology credits earned according to the provisions of § 86.1869–12(d).

(iv) Full size pickup truck credits earned according to the provisions of § 86.1870–12(c).

(v) CO<sub>2</sub>-equivalent debits for N<sub>2</sub>O and/or CH<sub>4</sub> accumulated according to the provisions of § 86.1818–12(f)(4).

(6) Unused CO<sub>2</sub> credits generally retain their full value through five model years after the model year in which they were generated. Credits remaining at the end of the fifth model



year after the model year in which they were generated may not be used to demonstrate compliance for later model years. The following particular provisions apply for passenger cars and light trucks:

(i) Unused CO<sub>2</sub> credits from the 2009 model year shall retain their full value through the 2014 model year. Credits from the 2009 model year that remain at the end of the 2014 model year may not be used to demonstrate compliance for later model years.

(ii) Unused CO<sub>2</sub> credits from the 2010 through 2015 model years shall retain their full value through the 2021 model year. Credits remaining from these model years at the end of the 2021 model year may not be used to demonstrate compliance for later model years.

(7) Credits may be used as follows:

(i) Credits generated and calculated according to the method in paragraphs (k)(4) and (5) of this section may not be used to offset deficits other than those deficits accrued within the respective averaging set, except that credits may be transferred between the passenger automobile and light truck fleets of a given manufacturer. Credits may be banked and used in a future model year in which a manufacturer's average CO<sub>2</sub> level exceeds the applicable standard. Credits may also be traded to another manufacturer according to the provisions in paragraph (k)(8) of this section. Before trading or carrying over credits to the next model year, a manufacturer must apply available credits to offset any deficit, where the deadline to offset that credit deficit has not yet passed. This paragraph (k)(7)(i) applies for MDPV, but not for other HDV.

(ii) The use of credits shall not change Selective Enforcement Auditing or in-use testing failures from a failure to a non-failure. The enforcement of the averaging standard occurs through the vehicle's certificate of conformity as described in paragraph (k)(8) of this section. A manufacturer's certificate of conformity is conditioned upon compliance with the averaging provisions. The certificate will be void ab initio if a manufacturer fails to meet the corporate average standard and does not obtain appropriate credits to cover its shortfalls in that model year or subsequent model years (see deficit carry-forward provisions in paragraph (k)(8) of this section).

(iii) The following provisions apply for passenger automobiles and light trucks under the Temporary Leadtime Allowance Alternative Standards:

(A) Credits generated by vehicles subject to the fleet average CO<sub>2</sub>

standards specified in § 86.1818–12(c) may only be used to offset a deficit generated by vehicles subject to the Temporary Leadtime Allowance Alternative Standards specified in § 86.1818–12(e).

(B) Credits generated by a passenger automobile or light truck averaging set subject to the Temporary Leadtime Allowance Alternative Standards specified in § 86.1818–12(e)(4)(i) or (ii) may be used to offset a deficit generated by an averaging set subject to the Temporary Leadtime Allowance Alternative Standards through the 2015 model year, except that manufacturers qualifying under the provisions of § 86.1818–12(e)(3) may use such credits to offset a deficit generated by an averaging set subject to the Temporary Leadtime Allowance Alternative Standards through the 2016 model year.

(C) Credits generated by an averaging set subject to the Temporary Leadtime Allowance Alternative Standards specified in § 86.1818–12(e)(4)(i) or (ii) of this section may not be used to offset a deficit generated by an averaging set subject to the fleet average CO<sub>2</sub> standards specified in § 86.1818–12(c)(2) or (3) or otherwise transferred to an averaging set subject to the fleet average CO<sub>2</sub> standards specified in § 86.1818–12(c)(2) or (3).

(D) Credits generated by vehicles subject to the Temporary Leadtime Allowance Alternative Standards specified in § 86.1818–12(e)(4)(i) or (ii) may be banked for use in a future model year (to offset a deficit generated by an averaging set subject to the Temporary Leadtime Allowance Alternative Standards). All such credits may not be used to demonstrate compliance for model year 2016 and later vehicles, except that manufacturers qualifying under the provisions of § 86.1818–12(e)(3) may use such credits to offset a deficit generated by an averaging set subject to the Temporary Leadtime Allowance Alternative Standards through the 2016 model year.

(E) A manufacturer with any vehicles subject to the Temporary Leadtime Allowance Alternative Standards specified in § 86.1818–12(e)(4)(i) or (ii) of this section in a model year in which that manufacturer also generates credits with vehicles subject to the fleet average CO<sub>2</sub> standards specified in § 86.1818–12(c) may not trade or bank credits earned against the fleet average standards in § 86.1818–12(c) for use in a future model year.

(iv) Credits generated in the 2017 through 2020 model years under the provisions of § 86.1818–12(e)(3)(ii) may not be traded or otherwise provided to another manufacturer.

(v) Credits generated under any alternative fleet average standards approved under § 86.1818–12(g) may not be traded or otherwise provided to another manufacturer.

(8) The following provisions apply if a manufacturer calculates that it has negative credits (also called “debits” or a “credit deficit”) for a given model year:

(i) The manufacturer may carry the credit deficit forward into the next three model years. Such a carry-forward may only occur after the manufacturer exhausts any supply of banked credits. The deficit must be covered with an appropriate number of credits that the manufacturer generates or purchases by the end of the third model year. Any remaining deficit is subject to a voiding of the certificate ab initio, as described in this paragraph (k)(8). Manufacturers are not permitted to have a credit deficit for four consecutive years.

(ii) If the credit deficit is not offset within the specified time period, the number of vehicles not meeting the fleet average CO<sub>2</sub> standards (and therefore not covered by the certificate) must be calculated.

(A) Determine the negative credits for the noncompliant vehicle category by multiplying the total megagram deficit by 1,000,000 and then dividing by the mileage specified in paragraph (k)(4) of this section.

(B) Divide the result by the fleet average standard applicable to the model year in which the debits were first incurred and round to the nearest whole number to determine the number of vehicles not meeting the fleet average CO<sub>2</sub> standards.

(iii) EPA will determine the vehicles not covered by a certificate because the condition on the certificate was not satisfied by designating vehicles in those test groups with the highest carbon-related exhaust emission values first and continuing until reaching a number of vehicles equal to the calculated number of non-complying vehicles as determined in this paragraph (k)(8). The same approach applies for HDV, except that EPA will make these designations by ranking test groups based on CO<sub>2</sub> emission values. If these calculations determines that only a portion of vehicles in a test group contribute to the debit situation, then EPA will designate actual vehicles in that test group as not covered by the certificate, starting with the last vehicle produced and counting backwards.

(iv)(A) If a manufacturer ceases production of passenger automobiles, light trucks, or heavy-duty vehicles, the manufacturer continues to be responsible for offsetting any debits

outstanding within the required time period. Any failure to offset the debits will be considered a violation of paragraph (k)(8)(i) of this section and may subject the manufacturer to an enforcement action for sale of vehicles not covered by a certificate, pursuant to paragraphs (k)(8)(ii) and (iii) of this section.

(B) If a manufacturer is purchased by, merges with, or otherwise combines with another manufacturer, the controlling entity is responsible for offsetting any debits outstanding within the required time period. Any failure to offset the debits will be considered a violation of paragraph (k)(8)(i) of this section and may subject the manufacturer to an enforcement action for sale of vehicles not covered by a certificate, pursuant to paragraphs (k)(8)(ii) and (iii) of this section.

(v) For purposes of calculating the statute of limitations, a violation of the requirements of paragraph (k)(8)(i) of this section, a failure to satisfy the conditions upon which a certificate(s) was issued and hence a sale of vehicles not covered by the certificate, all occur upon the expiration of the deadline for offsetting debits specified in paragraph (k)(8)(i) of this section.

(9) The following provisions apply to CO<sub>2</sub> credit trading:

(i) EPA may reject CO<sub>2</sub> credit trades if the involved manufacturers fail to submit the credit trade notification in the annual report.

(ii) A manufacturer may not sell credits that are no longer valid for demonstrating compliance based on the model years of the subject vehicles, as specified in paragraph (k)(6) of this section.

(iii) In the event of a negative credit balance resulting from a transaction, both the buyer and seller are liable for the credit shortfall. EPA may void ab initio the certificates of conformity of all test groups that generate or use credits in such a trade.

(iv)(A) If a manufacturer trades a credit that it has not generated pursuant to this paragraph (k) or acquired from another party, the manufacturer will be considered to have generated a debit in the model year that the manufacturer traded the credit. The manufacturer must offset such debits by the deadline for the annual report for that same model year.

(B) Failure to offset the debits within the required time period will be considered a failure to satisfy the conditions upon which the certificate(s) was issued and will be addressed pursuant to paragraph (k)(8) of this section.

(v) A manufacturer may only trade credits that it has generated pursuant to paragraphs (k)(4) and (5) of this section or acquired from another party.

(1) *Maintenance of records and submittal of information relevant to compliance with fleet average CO<sub>2</sub> standards*—(1) *Maintenance of records.*

(i) Manufacturers producing any light-duty vehicles, light-duty trucks, medium-duty passenger vehicles, or other heavy-duty vehicles subject to the provisions in this subpart must establish, maintain, and retain all the following information in adequately organized records for each model year:

(A) Model year.

(B) Applicable fleet average CO<sub>2</sub> standards for each averaging set as defined in paragraph (i) of this section.

(C) The calculated fleet average CO<sub>2</sub> value for each averaging set as defined in paragraph (i) of this section.

(D) All values used in calculating the fleet average CO<sub>2</sub> values.

(ii) Manufacturers must establish, maintain, and retain all the following information in adequately organized records for each vehicle produced that is subject to the provisions in this subpart:

(A) Model year.

(B) Applicable fleet average CO<sub>2</sub> standard.

(C) EPA test group.

(D) Assembly plant.

(E) Vehicle identification number.

(F) Carbon-related exhaust emission standard (automobile and light truck only), N<sub>2</sub>O emission standard, and CH<sub>4</sub> emission standard to which the vehicle is certified.

(G) In-use carbon-related exhaust emission standard for passenger automobiles and light truck, and in-use CO<sub>2</sub> standard for HDV.

(H) Information on the point of first sale, including the purchaser, city, and state.

(iii) Manufacturers must retain all required records for a period of eight years from the due date for the annual report. Records may be stored in any format and on any media, as long as manufacturers can promptly send EPA organized written records in English if requested by the Administrator. Manufacturers must keep records readily available as EPA may review them at any time.

(iv) The Administrator may require the manufacturer to retain additional records or submit information not specifically required by this section.

(v) Pursuant to a request made by the Administrator, the manufacturer must submit to the Administrator the information that the manufacturer is required to retain.

(vi) EPA may void ab initio a certificate of conformity for vehicles certified to emission standards as set forth or otherwise referenced in this subpart for which the manufacturer fails to retain the records required in this section or to provide such information to the Administrator upon request, or to submit the reports required in this section in the specified time period.

(2) *Reporting.* (i) Each manufacturer must submit an annual report. The annual report must contain for each applicable CO<sub>2</sub> standard, the calculated fleet average CO<sub>2</sub> value, all values required to calculate the CO<sub>2</sub> emissions value, the number of credits generated or debits incurred, all the values required to calculate the credits or debits, and the resulting balance of credits or debits. For each applicable alternative N<sub>2</sub>O and/or CH<sub>4</sub> standard selected under the provisions of § 86.1818–12(f)(3) for passenger automobiles and light trucks (or § 86.1819–14(c) for HDV), the report must contain the CO<sub>2</sub>-equivalent debits for N<sub>2</sub>O and/or CH<sub>4</sub> calculated according to § 86.1818–12(f)(4) (or § 86.1819–14(c) for HDV) for each test group and all values required to calculate the number of debits incurred.

(ii) For each applicable fleet average CO<sub>2</sub> standard, the annual report must also include documentation on all credit transactions the manufacturer has engaged in since those included in the last report. Information for each transaction must include all of the following:

(A) Name of credit provider.

(B) Name of credit recipient.

(C) Date the trade occurred.

(D) Quantity of credits traded in megagrams.

(E) Model year in which the credits were earned.

(iii) Manufacturers calculating air conditioning leakage and/or efficiency credits under paragraph § 86.1871–12(b) shall include the following information for each model year and separately for passenger automobiles and light trucks and for each air conditioning system used to generate credits:

(A) A description of the air conditioning system.

(B) The leakage credit value and all the information required to determine this value.

(C) The total credits earned for each averaging set, model year, and region, as applicable.

(iv) Manufacturers calculating advanced technology vehicle credits under paragraph § 86.1871–12(c) shall include the following information for each model year and separately for passenger automobiles and light trucks:

(A) The number of each model type of eligible vehicle sold.

(B) The cumulative model year production of eligible vehicles starting with the 2009 model year.

(C) The carbon-related exhaust emission value by model type and model year.

(v) Manufacturers calculating off-cycle technology credits under paragraph § 86.1871–12(d) shall include, for each model year and separately for passenger automobiles and light trucks, all test results and data required for calculating such credits.

(vi) Unless a manufacturer reports the data required by this section in the annual production report required under § 86.1844–01(e) or the annual report required under § 600.512–12 of this chapter, a manufacturer must submit an annual report for each model year after production ends for all affected vehicles produced by the manufacturer subject to the provisions of this subpart and no later than May 1 of the calendar year following the given model year. Annual reports must be submitted to: Director, Compliance Division, U.S. Environmental Protection Agency, 2000 Traverwood Dr., Ann Arbor, Michigan 48105.

(vii) Failure by a manufacturer to submit the annual report in the specified time period for all vehicles subject to the provisions in this section is a violation of section 203(a)(1) of the Clean Air Act (42 U.S.C. 7522 (a)(1)) for each applicable vehicle produced by that manufacturer.

(viii) If EPA or the manufacturer determines that a reporting error occurred on an annual report previously submitted to EPA, the manufacturer's credit or debit calculations will be recalculated. EPA may void erroneous credits, unless traded, and will adjust erroneous debits. In the case of traded erroneous credits, EPA must adjust the selling manufacturer's credit balance to reflect the sale of such credits and any resulting credit deficit.

(3) *Notice of opportunity for hearing.* Any voiding of the certificate under paragraph (l)(1)(vi) of this section will be made only after EPA has offered the affected manufacturer an opportunity for a hearing conducted in accordance with 40 CFR part 1068, subpart G, and, if a manufacturer requests such a hearing, will be made only after an initial decision by the Presiding Officer.

■ 86. Section 86.1866–12 is amended by adding introductory text and revising paragraph (b) introductory text to read as follows:

**§ 86.1866–12 CO<sub>2</sub> credits for advanced technology vehicles.**

This section describes how to apply CO<sub>2</sub> credits for advanced technology passenger automobiles and light trucks (including MDPV). This section does not apply for heavy-duty vehicles that are not MDPV.

\* \* \* \* \*

(b) For electric vehicles, plug-in hybrid electric vehicles, fuel cell vehicles, dedicated natural gas vehicles, and dual-fuel natural gas vehicles as those terms are defined in § 86.1803–01, that are certified and produced for U.S. sale in the 2017 through 2021 model years and that meet the additional specifications in this section, the manufacturer may use the production multipliers in this paragraph (b) when determining the manufacturer's fleet average carbon-related exhaust emissions under § 600.510–12 of this chapter. Full size pickup trucks eligible for and using a production multiplier are not eligible for the performance-based credits described in § 86.1870–12(b).

\* \* \* \* \*

■ 87. Section 86.1867–12 is amended by revising the introductory text to read as follows:

**§ 86.1867–12 CO<sub>2</sub> credits for reducing leakage of air conditioning refrigerant.**

Manufacturers may generate credits applicable to the CO<sub>2</sub> fleet average program described in § 86.1865–12 by implementing specific air conditioning system technologies designed to reduce air conditioning refrigerant leakage over the useful life of their passenger automobiles and/or light trucks (including MDPV); only the provisions of paragraph (a) of this section apply for non-MDPV heavy-duty vehicles. Credits shall be calculated according to this section for each air conditioning system that the manufacturer is using to generate CO<sub>2</sub> credits. Manufacturers may also generate early air conditioning refrigerant leakage credits under this section for the 2009 through 2011 model years according to the provisions of § 86.1871–12(b).

\* \* \* \* \*

■ 88. Section 86.1868–12 is amended by revising the introductory text and paragraphs (e)(5), (f)(1), (g)(1), and (g)(3) introductory text to read as follows:

**§ 86.1868–12 CO<sub>2</sub> credits for improving the efficiency of air conditioning systems.**

Manufacturers may generate credits applicable to the CO<sub>2</sub> fleet average program described in § 86.1865–12 by implementing specific air conditioning system technologies designed to reduce

air conditioning-related CO<sub>2</sub> emissions over the useful life of their passenger automobiles and/or light trucks (including MDPV). The provisions of this section do not apply for non-MDPV heavy-duty vehicles. Credits shall be calculated according to this section for each air conditioning system that the manufacturer is using to generate CO<sub>2</sub> credits. Manufacturers may also generate early air conditioning efficiency credits under this section for the 2009 through 2011 model years according to the provisions of § 86.1871–12(b). For model years 2012 and 2013 the manufacturer may determine air conditioning efficiency credits using the requirements in paragraphs (a) through (d) of this section. For model years 2014 through 2016 the eligibility requirements specified in either paragraph (e) or (f) of this section must be met before an air conditioning system is allowed to generate credits. For model years 2017 through 2019 the eligibility requirements specified in paragraph (f) of this section must be met before an air conditioning system is allowed to generate credits. For model years 2020 and later the eligibility requirements specified in paragraph (g) of this section must be met before an air conditioning system is allowed to generate credits.

\* \* \* \* \*

(e) \* \* \*

(5) Air conditioning systems with compressors that are solely powered by electricity shall submit Air Conditioning Idle Test Procedure data to be eligible to generate credits in the 2014 and later model years, but such systems are not required to meet a specific threshold to be eligible to generate such credits, as long as the engine remains off for a period of at least 2 cumulative minutes during the air conditioning on portion of the Idle Test Procedure in § 86.165–12(d).

(f) \* \* \*

(1) The manufacturer shall perform the AC17 test specified in 40 CFR 1066.845 on each unique air conditioning system design and vehicle platform combination (as those terms are defined in § 86.1803) for which the manufacturer intends to accrue air conditioning efficiency credits. The manufacturer must test at least one unique air conditioning system within each vehicle platform in a model year, unless all unique air conditioning systems within a vehicle platform have been previously tested. A unique air conditioning system design is a system with unique or substantially different component designs or types and/or system control strategies (e.g., fixed

displacement vs. variable displacement compressors, orifice tube vs. thermostatic expansion valve, single vs. dual evaporator, etc.). In the first year of such testing, the tested vehicle configuration shall be the highest production vehicle configuration within each platform. In subsequent model years the manufacturer must test other unique air conditioning systems within the vehicle platform, proceeding from the highest production untested system until all unique air conditioning systems within the platform have been tested, or until the vehicle platform experiences a major redesign. Whenever a new unique air conditioning system is tested, the highest production configuration using that system shall be the vehicle selected for testing. Air conditioning system designs which have similar cooling capacity, component types, and control strategies, yet differ in terms of compressor pulley ratios or condenser or evaporator surface areas will not be considered to be unique system designs. The test results from one unique system design may represent all variants of that design. Manufacturers must use good engineering judgment to identify the unique air conditioning system designs which will require AC17 testing in subsequent model years. Results must be reported separately for all four phases (two phases with air conditioning off and two phases with air conditioning on) of the test to the Environmental Protection Agency, and the results of the calculations required in 40 CFR 1066.845 must also be reported. In each subsequent model year additional air conditioning system designs, if such systems exist, within a vehicle platform that is generating air conditioning credits must be tested using the AC17 procedure. When all unique air conditioning system designs within a platform have been tested, no additional testing is required within that platform, and credits may be carried over to subsequent model years until there is a significant change in the platform design, at which point a new sequence of testing must be initiated. No more than one vehicle from each credit-generating platform is required to be tested in each model year.

\* \* \* \* \*

(g) \* \* \*

(1) For each air conditioning system (as defined in § 86.1803) selected by the manufacturer to generate air conditioning efficiency credits, the manufacturer shall perform the AC17 Air Conditioning Efficiency Test Procedure specified in 40 CFR 1066.845,

according to the requirements of this paragraph (g).

\* \* \* \* \*

(3) For the first model year for which an air conditioning system is expected to generate credits, the manufacturer must select for testing the projected highest-selling configuration within each combination of vehicle platform and air conditioning system (as those terms are defined in § 86.1803). The manufacturer must test at least one unique air conditioning system within each vehicle platform in a model year, unless all unique air conditioning systems within a vehicle platform have been previously tested. A unique air conditioning system design is a system with unique or substantially different component designs or types and/or system control strategies (e.g., fixed-displacement vs. variable displacement compressors, orifice tube vs. thermostatic expansion valve, single vs. dual evaporator, etc.). In the first year of such testing, the tested vehicle configuration shall be the highest production vehicle configuration within each platform. In subsequent model years the manufacturer must test other unique air conditioning systems within the vehicle platform, proceeding from the highest production untested system until all unique air conditioning systems within the platform have been tested, or until the vehicle platform experiences a major redesign. Whenever a new unique air conditioning system is tested, the highest production configuration using that system shall be the vehicle selected for testing. Credits may continue to be generated by the air conditioning system installed in a vehicle platform provided that:

\* \* \* \* \*

■ 89. Section 86.1869–12 is amended by adding introductory text and revising paragraphs (b)(2) introductory text, (b)(4)(ii), and (f) to read as follows:

**§ 86.1869–12 CO<sub>2</sub> credits for off-cycle CO<sub>2</sub>-reducing technologies.**

This section describes how manufacturers may generate credits for off-cycle CO<sub>2</sub>-reducing technologies. The provisions of this section do not apply for non-MDPV heavy-duty vehicles, except that § 86.1819–14(d)(13) describes how to apply paragraphs (c) and (d) of this section for those vehicles.

\* \* \* \* \*

(b) \* \* \*

(2) The maximum allowable decrease in the manufacturer's combined passenger automobile and light truck fleet average CO<sub>2</sub> emissions attributable to use of the default credit values in

paragraph (b)(1) of this section is 10 grams per mile. If the total of the CO<sub>2</sub> g/mi credit values from paragraph (b)(1) of this section does not exceed 10 g/mi for any passenger automobile or light truck in a manufacturer's fleet, then the total off-cycle credits may be calculated according to paragraph (f) of this section. If the total of the CO<sub>2</sub> g/mi credit values from paragraph (b)(1) of this section exceeds 10 g/mi for any passenger automobile or light truck in a manufacturer's fleet, then the gram per mile decrease for the combined passenger automobile and light truck fleet must be determined according to paragraph (b)(2)(i) of this section to determine whether the 10 g/mi limitation has been exceeded.

\* \* \* \* \*

(4) \* \* \*

(ii) *High efficiency exterior lighting* means a lighting technology that, when installed on the vehicle, is expected to reduce the total electrical demand of the exterior lighting system when compared to conventional lighting systems. To be eligible for this credit, the high efficiency lighting must be installed in one or more of the following lighting components: low beam, high beam, parking/position, front and rear turn signals, front and rear side markers, taillights, and/or license plate lighting.

\* \* \* \* \*

(f) *Calculation of total off-cycle credits.* Total off-cycle credits in Megagrams of CO<sub>2</sub> (rounded to the nearest whole number) shall be calculated separately for passenger automobiles and light trucks according to the following formula:

$$\text{Total Credits (Megagrams)} = (\text{Credit} \times \text{Production} \times \text{VLM}) \div 1,000,000$$

Where:

Credit = the credit value in grams per mile determined in paragraph (b), (c) or (d) of this section.

Production = The total number of passenger automobiles or light trucks, whichever is applicable, produced with the off-cycle technology to which to the credit value determined in paragraph (b), (c), or (d) of this section applies.

VLM = vehicle lifetime miles, which for passenger automobiles shall be 195,264 and for light trucks shall be 225,865.

■ 90. Section 86.1870–12 is amended by revising the section heading, introductory text, and paragraph (a) introductory text and adding paragraph (a)(3) to read as follows:

**§ 86.1870–12 CO<sub>2</sub> credits for qualifying full-size light pickup trucks.**

Full-size pickup trucks may be eligible for additional credits based on the implementation of hybrid technologies or on exhaust emission

performance, as described in this section. Credits may be generated under either paragraph (a) or (b) of this section for a qualifying pickup truck, but not both. The provisions of this section do not apply for heavy-duty vehicles.

(a) *Credits for implementation of hybrid electric technology.* Full size pickup trucks that implement hybrid electric technologies may be eligible for an additional credit under this paragraph (a). Pickup trucks earning the credits under this paragraph (a) may not earn the credits described in paragraph (b) of this section. To claim this credit, the manufacturer must measure the recovered energy over the Federal Test Procedure according to 40 CFR 600.116–12(d) to determine whether a vehicle is a mild or strong hybrid electric vehicle. To provide for EPA testing, the vehicle must be able to broadcast battery pack voltage via an on-board diagnostics parameter ID channel.

\* \* \* \* \*

(3) If you produce both mild and strong hybrid electric full size pickup trucks but do not qualify for credits under paragraph (a)(1) or (2) of this section, your hybrid electric full size pickup trucks may be eligible for a credit of 10 grams/mile. To receive this credit in a given model year, you must produce a quantity of hybrid electric full size pickup trucks such that the proportion of combined mild and strong full size hybrid electric pickup trucks produced in a model year, when compared to your total production of full size pickup trucks, is not less than the required minimum percentages specified in paragraph (a)(1) of this section.

\* \* \* \* \*

■ 91. Section 86.1871–12 is amended by revising the introductory text and paragraphs (a) introductory text, (b)(1), and (d) to read as follows:

**§ 86.1871–12 Optional early CO<sub>2</sub> credit programs.**

Manufacturers may optionally generate CO<sub>2</sub> credits in the 2009 through 2011 model years for use in the 2012 and later model years subject to EPA approval and to the provisions of this section. The provisions of § 86.1819–14(k)(1) and (2) apply instead of the provisions of this section for non-MDPV heavy-duty vehicles. Manufacturers may generate early fleet average credits, air conditioning leakage credits, air conditioning efficiency credits, early advanced technology credits, and early off-cycle technology credits. Manufacturers generating any credits under this section must submit an early credits report to the Administrator as

required in this section. The terms “sales” and “sold” as used in this section shall mean vehicles produced for U.S. sale, where “U.S.” means the states and territories of the United States. The expiration date of unused CO<sub>2</sub> credits is based on the model year in which the credits are earned, as described in § 86.1865–12(k)(6).

(a) *Early fleet average CO<sub>2</sub> reduction credits.* Manufacturers may optionally generate credits for reductions in their fleet average CO<sub>2</sub> emissions achieved in the 2009 through 2011 model years. To generate early fleet average CO<sub>2</sub> reduction credits, manufacturers must select one of the four pathways described in paragraphs (a)(1) through (4) of this section. The manufacturer may select only one pathway, and that pathway must remain in effect for the 2009 through 2011 model years. Fleet average credits (or debits) must be calculated and reported to EPA for each model year under each selected pathway.

\* \* \* \* \*

(b) *Early air conditioning leakage and efficiency credits.* (1) Manufacturers may optionally generate air conditioning refrigerant leakage credits according to the provisions of § 86.1867 and/or air conditioning efficiency credits according to the provisions of § 86.1868 in model years 2009 through 2011. Credits must be tracked by model type and model year.

\* \* \* \* \*

(d) *Early off-cycle technology credits.* Manufacturers may optionally generate credits for the implementation of certain CO<sub>2</sub>-reducing technologies according to the provisions of § 86.1869 in model years 2009 through 2011. Credits must be tracked by model type and model year.

\* \* \* \* \*

**Subpart T—Manufacturer-Run In-Use Testing Program for Heavy-Duty Diesel Engines**

■ 92. Section 86.1910 is amended by revising paragraph (i) to read as follows:

**§ 86.1910 How must I prepare and test my in-use engines?**

\* \* \* \* \*

(i) You may count a vehicle as meeting the vehicle-pass criteria described in § 86.1912 if a shift day of testing or two-shift days of testing (with the requisite non-idle/idle operation time as in paragraph (g) of this section), or if the extended testing you elected under paragraph (h) of this section does not generate a single valid NTE sampling event, as described in § 86.1912(b). Count the vehicle towards

meeting your testing requirements under this subpart.

\* \* \* \* \*

■ 93. Section 86.1912 is revised to read as follows:

**§ 86.1912 How do I determine whether an engine meets the vehicle-pass criteria?**

In general, the average emissions for each regulated pollutant must remain at or below the NTE threshold in paragraph (a) of this section for at least 90 percent of the valid NTE sampling events, as defined in paragraph (b) of this section. For 2007 through 2009 model year engines, the average emissions from every NTE sampling event must also remain below the NTE thresholds in paragraph (g)(2) of this section. Perform the following steps to determine whether an engine meets the vehicle-pass criteria:

(a) Determine the NTE threshold for each pollutant subject to an NTE standard by adding all three of the following terms and rounding the result to the same number of decimal places as the applicable NTE standard:

- (1) The applicable NTE standard.
- (2) The in-use compliance testing margin specified in § 86.007–11(h), if any.

(3) An accuracy margin for portable in-use equipment when testing is performed under the special provisions of § 86.1930, depending on the pollutant, as follows:

- (i) NMHC: 0.17 g/hp-hr.
- (ii) CO: 0.60 g/hp-hr.
- (iii) NO<sub>x</sub>: 0.50 g/hp-hr.
- (iv) PM: 0.10 g/hp-hr.
- (v) NO<sub>x</sub> + NMHC: 0.67 g/hp-hr.

(4) Accuracy margins for portable in-use equipment when testing is not performed under the special provisions of § 86.1930 for 2007 through 2009 model year engine families that are selected for testing in any calendar year as follows:

- (i) NMHC using the emission calculation method specified in 40 CFR 1065.650(a)(1): 0.02 g/hp-hr.
- (ii) NMHC using the emission calculation method specified in 40 CFR 1065.650(a)(3): 0.01 g/hp-hr.
- (iii) NMHC using an alternative emission calculation method we approve under 40 CFR 1065.915(d)(5)(iv): 0.01 g/hp-hr.
- (iv) CO using the emission calculation method specified in 40 CFR 1065.650(a)(1): 0.5 g/hp-hr.
- (v) CO using the emission calculation method specified in 40 CFR 1065.650(a)(3): 0.25 g/hp-hr.
- (vi) CO using an alternative emission calculation method we approve under 40 CFR 1065.915(d)(5)(iv): 0.25 g/hp-hr.

(vii) NO<sub>x</sub> using the emission calculation method specified in 40 CFR 1065.650(a)(1): 0.45 g/hp-hr.

(viii) NO<sub>x</sub> using the emission calculation method specified in 40 CFR 1065.650(a)(3): 0.15 g/hp-hr.

(ix) NO<sub>x</sub> using an alternative emission calculation method we approve under 40 CFR 1065.915(d)(5)(iv): 0.15 g/hp-hr.

(x) NO<sub>x</sub> + NMHC using the emission calculation method specified in 40 CFR 1065.650(a)(1): 0.47 g/hp-hr.

(xi) NO<sub>x</sub> + NMHC using the emission calculation method specified in 40 CFR 1065.650(a)(3): 0.16 g/hp-hr.

(xii) NO<sub>x</sub> + NMHC using an alternative emission calculation method we approve under 40 CFR

1065.915(d)(5)(iv): 0.16 g/hp-hr.

(xiii) PM: 0.006 g/hp-hr.

(5) Accuracy margins for portable in-use equipment when testing is not performed under the special provisions of § 86.1930 for 2010 or later model year engines families that are selected for testing in any calendar year as follows:

(i) NMHC using any emission calculation method specified in 40 CFR 1065.650(a) or an alternative emission calculation method we approve under 40 CFR 1065.915(d)(5)(iv): 0.01 g/hp-hr.

(ii) CO using any emission calculation method specified in 40 CFR 1065.650(a) or an alternative emission calculation method we approve under 40 CFR 1065.915(d)(5)(iv): 0.25 g/hp-hr.

(iii) NO<sub>x</sub> using any emission calculation method specified in 40 CFR 1065.650(a) or an alternative emission calculation method we approve under 40 CFR 1065.915(d)(5)(iv): 0.15 g/hp-hr.

(iv) PM: 0.006 g/hp-hr.

(b) For the purposes of this subpart, a valid NTE sampling event consists of

at least 30 seconds of continuous operation in the NTE control area. An NTE event begins when the engine starts to operate in the NTE control area and continues as long as engine operation remains in this area (see § 86.1370).

When determining a valid NTE sampling event, exclude all engine operation in approved NTE limited testing regions under § 86.1370–2007(b)(6) and any approved NTE deficiencies under § 86.007–11(a)(4)(iv). Engine operation in the NTE control area of less than 30 contiguous seconds does not count as a valid NTE sampling event; operating periods of less than 30 seconds in the NTE control area, but outside of any allowed deficiency area or limited testing region, will not be added together to make a 30 second or longer event. Exclude any portion of a sampling event that would otherwise exceed the 5.0 percent limit for the time-weighted carve-out defined in § 86.1370–2007(b)(7). For EGR-equipped engines, exclude any operation that occurs during the cold-temperature operation defined by the equations in § 86.1370–2007(f)(1).

(c) Calculate the average emission level for each pollutant over each valid NTE sampling event as specified in 40 CFR part 1065, subpart G, using each NTE event as an individual test interval. This should include valid NTE events from all days of testing.

(d) If the engine has an open crankcase, account for these emissions by adding 0.00042 g/hp-hr to the PM emission result for every NTE event.

(e) Calculate a time-weighted vehicle-pass ratio ( $R_{pass}$ ) for each pollutant. To do this, first sum the time from each

valid NTE sampling event whose average emission level is at or below the NTE threshold for that pollutant, then divide this value by the sum of the engine operating time from all valid NTE events for that pollutant. Round the resulting vehicle-pass ratio to two decimal places.

(1) Calculate the time-weighted vehicle-pass ratio for each pollutant as follows:

$$R_{pass} = \frac{\sum_{m=1}^{n_{pass}} t}{\sum_{k=1}^{n_{total}} t}$$

Where:

$n_{pass}$  = the number of valid sampling events for which the average emission level is at or below the NTE threshold.

$n_{total}$  = the total number of valid NTE sampling events.

(2) For both the numerator and the denominator of the vehicle-pass ratio, use the smallest of the following values for determining the duration,  $t$ , of any NTE sampling event:

(i) The measured time in the NTE zone that is valid for an NTE sampling event.

(ii) 600 seconds.

(iii) 10 times the length of the shortest valid NTE sampling event for all testing with that engine.

(f) The following example illustrates how to select the duration of NTE sampling events for calculations, as described in paragraph (f) of this section:

NTE sample	Duration of NTE sample (seconds)	Duration limit applied?	Duration used in calculations (seconds)
1 .....	45	No .....	45
2 .....	168	No .....	168
3 .....	605	Yes. Use 10 times shortest valid NTE .....	450
4 .....	490	Yes. Use 10 times shortest valid NTE .....	450
5 .....	65	No .....	65

(g) Engines meet the vehicle-pass criteria under this section if they meet both of the following criteria:

(1) The vehicle-pass ratio calculated according to paragraph (e) of this section must be at least 0.90 for each pollutant.

(2) For model year 2007 through 2009 engines, emission levels from every valid NTE sampling event must be less than 2.0 times the NTE thresholds calculated according to paragraph (a) of this section for all pollutants, except

that engines certified to a NO<sub>x</sub> FEL at or below 0.50 g/hp-hr may meet the vehicle-pass criteria for NO<sub>x</sub> if measured NO<sub>x</sub> emissions from every valid NTE sample are less than either 2.0 times the NTE threshold for NO<sub>x</sub> or 2.0 g/hp-hr, whichever is greater.

■ 94. Section 86.1920 is amended by revising paragraph (b) introductory text to read as follows:

**§ 86.1920 What in-use testing information must I report to EPA?**

\* \* \* \* \*

(b) Within 45 days after the end of each calendar quarter, send us reports containing the test data from each engine for which testing was completed during the calendar quarter.

Alternatively, you may separately send us the test data within 30 days after you complete testing for an engine. If you request it, we may allow additional time to send us this information. Once you

send us information under this section, you need not send that information again in later reports. Prepare your test reports as follows:

\* \* \* \* \*

**Appendix I to Part 86—[Amended]**

■ 95. Appendix I to part 86 is amended by removing paragraph (f)(3).

**PART 600—FUEL ECONOMY AND GREENHOUSE GAS EXHAUST EMISSIONS OF MOTOR VEHICLES**

■ 96. The authority citation for part 600 continues to read as follows:

**Authority:** 49 U.S.C. 32901–23919q, Pub. L. 109–58.

**Subpart A—General Provisions**

■ 97. Section 600.001 is amended by revising paragraph (a) to read as follows:

**§ 600.001 General applicability.**

(a) The provisions of this part apply to 2008 and later model year automobiles that are not medium duty passenger vehicles, and to 2011 and later model year automobiles including medium-duty passenger vehicles. The test procedures in subpart B of this part also apply to 2014 and later heavy-duty vehicles subject to standards under 40 CFR part 86, subpart S.

\* \* \* \* \*

■ 98. Section 600.002 is amended by revising the definitions for “Engine code”, “Subconfiguration”, “Transmission class”, and “Vehicle configuration” to read as follows:

**§ 600.002 Definitions.**

\* \* \* \* \*

*Engine code* means one of the following:

(1) For LDV, LDT, and MDPV, *engine code* means a unique combination, within an engine-system combination (as defined in § 86.1803 of this chapter), of displacement, fuel injection (or carburetion or other fuel delivery system), calibration, distributor calibration, choke calibration, auxiliary emission control devices, and other engine and emission control system components specified by the Administrator. For electric vehicles, engine code means a unique combination of manufacturer, electric traction motor, motor configuration, motor controller, and energy storage device.

(2) For HDV, *engine code* has the meaning given in § 86.1819–14(d)(12) of this chapter.

\* \* \* \* \*

*Subconfiguration* means one of the following:

(1) For LDV, LDT, and MDPV, *subconfiguration* means a unique combination within a vehicle configuration of equivalent test weight, road-load horsepower, and any other operational characteristics or parameters which the Administrator determines may significantly affect fuel economy or CO<sub>2</sub> emissions within a vehicle configuration.

(2) For HDV, *subconfiguration* has the meaning given in § 86.1819–14(d)(12) of this chapter.

\* \* \* \* \*

*Transmission class* means a group of transmissions having the following common features: Basic transmission type (e.g., automatic, manual, automated manual, semi-automatic, or continuously variable); number of forward gears used in fuel economy testing (e.g., manual four-speed, three-

speed automatic, two-speed semi-automatic); drive system (e.g., front wheel drive, rear wheel drive; four wheel drive), type of overdrive, if applicable (e.g., final gear ratio less than 1.00, separate overdrive unit); torque converter type, if applicable (e.g., non-lockup, lockup, variable ratio); and other transmission characteristics that may be determined to be significant by the Administrator.

\* \* \* \* \*

*Vehicle configuration* means one of the following:

(1) For LDV, LDT, and MDPV, *vehicle configuration* means a unique combination of basic engine, engine code, inertia weight class, transmission configuration, and axle ratio within a base level.

(2) For HDV, *vehicle configuration* has the meaning given for “configuration” in § 86.1819–14(d)(12) of this chapter.

\* \* \* \* \*

**Subpart B—Fuel Economy and Carbon-Related Exhaust Emission Test Procedures**

■ 99. Section 600.113–12 is amended by revising paragraphs (m), (n) introductory text, (n)(2), and (n)(3) and adding paragraph (o) to read as follows:

**§ 600.113–12 Fuel economy, CO<sub>2</sub> emissions, and carbon-related exhaust emission calculations for FTP, HFET, US06, SC03 and cold temperature FTP tests.**

\* \* \* \* \*

(m)(1) For automobiles fueled with liquefied petroleum gas and automobiles designed to operate on gasoline and liquefied petroleum gas, the fuel economy in miles per gallon of liquefied petroleum gas is to be calculated using the following equation:

$$mpg_e = \frac{CWF_{fuel} \cdot SG_{fuel} \cdot 3781.8}{CWF_{HC} \cdot HC + 0.429 \cdot CO + 0.273 \cdot CO_2}$$

Where:

mpg<sub>e</sub> = miles per gasoline gallon equivalent of liquefied petroleum gas.

CWF<sub>fuel</sub> = carbon weight fraction based on the hydrocarbon constituents in the liquefied petroleum gas fuel as obtained in paragraph (f)(5) of this section and rounded according to paragraph (g)(3) of this section.

SG = Specific gravity of the fuel as determined in paragraph (f)(5) of this section and rounded according to paragraph (g)(3) of this section.

3781.8 = Grams of H<sub>2</sub>O per gallon conversion factor.

CWF<sub>HC</sub> = Carbon weight fraction of exhaust hydrocarbon = CWF<sub>fuel</sub> as determined in

paragraph (f)(4) of this section and rounded according to paragraph (f)(3) of this section.

HC = Grams/mile HC as obtained in paragraph (g)(2) of this section.

CO = Grams/mile CO as obtained in paragraph (g)(2) of this section.

CO<sub>2</sub> = Grams/mile CO<sub>2</sub> as obtained in paragraph (g)(2) of this section.

(2)(i) For automobiles fueled with liquefied petroleum gas and automobiles designed to operate on gasoline and liquefied petroleum gas, the carbon-related exhaust emissions in grams per mile while operating on liquefied petroleum gas is to be

calculated for 2012 and later model year vehicles using the following equation and rounded to the nearest 1 gram per mile:

$$CREE = (CWF_{HC} / 0.273 \times HC) + (1.571 \times CO) + CO_2$$

Where:

CREE means the carbon-related exhaust emission value as defined in § 600.002.

CWF<sub>HC</sub> = Carbon weight fraction of exhaust hydrocarbon = CWF<sub>fuel</sub> as determined in paragraph (f)(5) of this section and rounded according to paragraph (g)(3) of this section.

HC = Grams/mile HC as obtained in paragraph (g)(2) of this section.



CO = Grams/mile CO as obtained in paragraph (g)(2) of this section.  
 CO<sub>2</sub> = Grams/mile CO<sub>2</sub> as obtained in paragraph (g)(2) of this section.

(ii) For manufacturers complying with the fleet averaging option for N<sub>2</sub>O and CH<sub>4</sub> as allowed under § 86.1818 of this chapter, the carbon-related exhaust emissions in grams per mile for 2012 and later model year automobiles fueled with liquefied petroleum gas and automobiles designed to operate on mixtures of gasoline and liquefied petroleum gas while operating on liquefied petroleum gas is to be calculated using the following equation and rounded to the nearest 1 gram per mile:

$$CREE = [(CWF_{exHC}/0.273) \times NMHC] + (1.571 \times CO) + CO_2 + (298 \times N_2O) + (25 \times CH_4)$$

Where:

CREE means the carbon-related exhaust emission value as defined in § 600.002.  
 CWF<sub>HC</sub> = Carbon weight fraction of exhaust hydrocarbon = CWF<sub>Fuel</sub> as determined in paragraph (f)(5) of this section and rounded according to paragraph (g)(3) of this section.  
 NMHC = Grams/mile HC as obtained in paragraph (g)(2) of this section.  
 CO = Grams/mile CO as obtained in paragraph (g)(2) of this section.  
 CO<sub>2</sub> = Grams/mile CO<sub>2</sub> as obtained in paragraph (g)(2) of this section.  
 N<sub>2</sub>O = Grams/mile N<sub>2</sub>O as obtained in paragraph (g)(2) of this section.  
 CH<sub>4</sub> = Grams/mile CH<sub>4</sub> as obtained in paragraph (g)(2) of this section.

(n) Manufacturers shall determine CO<sub>2</sub> emissions and carbon-related exhaust emissions for electric vehicles, fuel cell vehicles, and plug-in hybrid electric vehicles according to the provisions of this paragraph (n). Subject to the limitations on the number of vehicles produced and delivered for sale as described in § 86.1866 of this chapter, the manufacturer may be allowed to use a value of 0 grams/mile to represent the emissions of fuel cell vehicles and the proportion of electric operation of a electric vehicles and plug-in hybrid electric vehicles that is derived from

electricity that is generated from sources that are not onboard the vehicle, as described in paragraphs (n)(1) through (3) of this section. For purposes of labeling under this part, the CO<sub>2</sub> emissions for electric vehicles shall be 0 grams per mile. Similarly, for purposes of labeling under this part, the CO<sub>2</sub> emissions for plug-in hybrid electric vehicles shall be 0 grams per mile for the proportion of electric operation that is derived from electricity that is generated from sources that are not onboard the vehicle. For manufacturers no longer eligible to use 0 grams per mile to represent electric operation, and for all 2026 and later model year electric vehicles, fuel cell vehicles, and plug-in hybrid electric vehicles, the provisions of this paragraph (n) shall be used to determine the non-zero value for CREE for purposes of meeting the greenhouse gas emission standards described in § 86.1818 of this chapter.

(2) For plug-in hybrid electric vehicles, the carbon-related exhaust emissions in grams per mile is to be calculated according to the provisions of § 600.116, except that the CREE for charge-depleting operation shall be the sum of the CREE associated with gasoline consumption and the net upstream CREE determined according to paragraph (n)(1) of this section, rounded to the nearest one gram per mile.

(3) For 2012 and later model year fuel cell vehicles, the carbon-related exhaust emissions in grams per mile shall be calculated using the method specified in paragraph (n)(1) of this section, except that CREE<sub>UP</sub> shall be determined according to procedures established by the Administrator under § 600.111–08(f). As described in § 86.1866 of this chapter, the value of CREE may be set equal to zero for a certain number of 2012 through 2025 model year fuel cell vehicles.

(o) Equations for fuels other than those specified in this section may be used with advance EPA approval.

Alternate calculation methods for fuel economy and carbon-related exhaust emissions may be used in lieu of the methods described in this section if shown to yield equivalent or superior results and if approved in advance by the Administrator.

■ 100. Section 600.116–12 is amended as follows:

- a. By revising paragraph (c)(1) introductory text.
- b. By redesignating paragraphs (c)(2) through (9) as paragraphs (c)(3) through (10), respectively.
- c. By adding a new paragraph (c)(2).
- d. By revising newly redesignated paragraph (c)(4).
- e. By revising newly redesignated paragraph (c)(5) introductory text.
- f. By revising paragraphs (d)(1)(i)(C), (d)(1)(ii), (d)(2)(ii), and (d)(3).

The revisions and addition read as follows:

**§ 600.116–12 Special procedures related to electric vehicles and hybrid electric vehicles.**

\* \* \* \* \*  
 (c) \* \* \*

(1) To determine CREE values to demonstrate compliance with GHG standards, calculate composite values representing combined operation during charge-depleting and charge-sustaining operation using the following utility factors except as specified in this paragraph (c):

\* \* \* \* \*

(2) Determine fuel economy values to demonstrate compliance with CAFE standards as follows:

(i) For vehicles that are not dual fueled automobiles, determine fuel economy using the utility factors described in paragraph (c)(1) of this section. Do not use the petroleum-equivalence factors described in 10 CFR 474.3.

(ii) Except as described in paragraph (c)(2)(iii) of this section, determine fuel economy for dual fueled automobiles from the following equation, separately for city and highway driving:

$$MPGe_{CAFE} = \frac{1}{\left( \frac{0.5}{MPG_{gas}} + \frac{0.5}{MPG_{elec}} \right)}$$

Where:

MPG<sub>gas</sub> = The miles per gallon measured while operating on gasoline during charge-sustaining operation as

determined using the procedures of SAE J1711.  
 MPG<sub>elec</sub> = The miles per gallon equivalent measured while operating on electricity. Calculate this value by dividing the equivalent all-electric range determined

from the equation in § 86.1866–12(b)(2)(ii) by the corresponding measured Watt-hours of energy consumed; apply the appropriate petroleum-equivalence factor from 10 CFR 474.3 to convert Watt-hours to



gallons equivalent. Note that if vehicles use no gasoline during charge-depleting operation,  $MPGe_{elec}$  is the same as the

charge-depleting fuel economy specified in SAE J1711.

(iii) For 2016 and later model year dual fueled automobiles, you may

determine fuel economy based on the following equation, separately for city and highway driving:

$$MPGe_{CAFE} = \frac{1}{\left( \frac{UF}{MPGe_{elec}} + \frac{(1-UF)}{MPGe_{gas}} \right)}$$

Where:

UF = The appropriate utility factor for city or highway driving as described in paragraph (c)(1) of this section.

\* \* \* \* \*

(4) You may calculate performance values under paragraphs (c)(1) through (3) of this section by combining phases during FTP testing. For example, you may treat the first 7.45 miles as a single phase by adding the individual utility factors for that portion of driving and assigning emission levels to the combined phase. Do this consistently throughout a test run.

(5) Instead of the utility factors specified in paragraphs (c)(1) through (3) of this section, calculate utility factors using the following equation for vehicles whose maximum speed is less than the maximum speed specified in the driving schedule, where the vehicle's maximum speed is determined, to the nearest 0.1 mph, from observing the highest speed over the first duty cycle (FTP, HFET, etc.):

\* \* \* \* \*

- (d) \* \* \*
- (1) \* \* \*
- (i) \* \* \*

(C) Determine braking power in kilowatts using the following equation. Note that during braking events,  $P_{brake}$ ,  $P_{accel}$ , and  $P_{roadload}$  will all be negative (*i.e.*, resistive) forces on the vehicle.

$$P_{brake} = P_{accel} - P_{roadload}$$

Where:

$P_{accel}$  = the value determined in paragraph (d)(1)(i)(B) of this section;  
 $P_{roadload}$  = the value determined in paragraph (d)(1)(i)(A) of this section; and  
 $P_{brake} = 0$  if  $P_{accel}$  is greater than or equal to  $P_{roadload}$ .

(ii) The total maximum braking energy ( $E_{brake}$ ) that could theoretically be recovered is equal to the absolute value of the sum of all the values of  $P_{brake}$  determined in paragraph (d)(1)(i)(C) of this section, divided by 36000 (to convert 10 Hz data to hours) and rounded to the nearest 0.01 kilowatt-hours.

- (2) \* \* \*

(ii) At each sampling point where current is flowing into the battery,

calculate the energy flowing into the battery, in Watt-hours, as follows:

$$E_t = \frac{I_t \cdot V_{nominal}}{36,000}$$

Where:

$E_t$  = the energy flowing into the battery, in Watt-hours, at time  $t$  in the test;

$I_t$  = the electrical current, in Amps, at time  $t$  in the test; and

$V_{nominal}$  = the nominal voltage of the hybrid battery system determined according to paragraph (d)(4) of this section.

\* \* \* \* \*

(3) The percent of braking energy recovered by a hybrid system relative to the total available energy is determined by the following equation, rounded to the nearest one percent:

$$\text{Energy Recovered \%} = \frac{E_{rec}}{E_{brake}} \cdot 100$$

Where:

$E_{rec}$  = The actual total energy recovered, in kilowatt-hours, as determined in paragraph (d)(2) of this section; and

$E_{brake}$  = The theoretical maximum amount of energy, in kilowatt-hours, that could be recovered by a hybrid electric vehicle over the FTP test cycle, as determined in paragraph (d)(1) of this section.

\* \* \* \* \*

**Subpart C—Procedures for Calculating Fuel Economy and Carbon-Related Exhaust Emission Values**

■ 101. Section 600.208–12 is amended by revising paragraph (a)(2)(iii) to read as follows:

**§ 600.208–12 Calculation of FTP-based and HFET-based fuel economy, CO<sub>2</sub> emissions, and carbon-related exhaust emissions for a model type.**

- (a) \* \* \*
- (2) \* \* \*

(iii) All subconfigurations within the new base level are represented by test data in accordance with § 600.010(c)(1)(iii).

\* \* \* \* \*

■ 102. Section 600.210–12 is amended by revising paragraph (c)(2)(iv)(C) to read as follows:

**§ 600.210–12 Calculation of fuel economy and CO<sub>2</sub> emission values for labeling.**

\* \* \* \* \*

- (c) \* \* \*
- (2) \* \* \*
- (iv) \* \* \*

(C) Calculate a composite city CO<sub>2</sub> emission rate and a composite highway CO<sub>2</sub> emission rate by combining the separate results for battery and engine operation using the procedures described in § 600.116. Use these values to calculate the vehicle's combined CO<sub>2</sub> emissions as described in paragraph (c)(2)(i) of this section.

\* \* \* \* \*

**Subpart D—Fuel Economy Labeling**

■ 103. Section 600.311–12 is amended by revising paragraph (g) to read as follows:

**§ 600.311–12 Determination of values for fuel economy labels.**

\* \* \* \* \*

(g) *Smog rating.* Establish a rating for exhaust emissions other than CO<sub>2</sub> based on the applicable emission standards for the appropriate model year as shown in Tables 1 through 3 of this section. Unless specified otherwise, use the California emission standards to select the smog rating only for vehicles not certified to any EPA standards. For Independent Commercial Importers that import vehicles not subject to Tier 2 or Tier 3 emission standards, the vehicle's smog rating is 1. Similarly, if a manufacturer certifies vehicles to emission standards that are less stringent than all the identified standards for any reason, the vehicle's smog rating is 1. If EPA or California emission standards change in the future, we may revise the emission levels corresponding to each rating for future model years as appropriate to reflect the changed standards. If this occurs, we would publish the revised ratings as described in § 600.302–12(k), allowing sufficient lead time to make the

changes; we would also expect to initiate a rulemaking to update the smog rating in the regulation.

TABLE 1 OF § 600.311–12—CRITERIA FOR ESTABLISHING SMOG RATING FOR MODEL YEAR 2025 AND LATER

Rating	U.S. EPA Tier 3 emission standard	California Air Resources Board LEV III emission standard
1	Bin 160	LEV 160.
2	Bin 125	ULEV125.
4	Bin 70	ULEV70.
5	Bin 50	ULEV50.
6	Bin 30	SULEV30.
7	Bin 20	SULEV20.
10	Bin 0	ZEV.

TABLE 2 OF § 600.311–12—CRITERIA FOR ESTABLISHING SMOG RATING FOR MODEL YEARS 2018–2024

Rating	U.S. EPA Tier 3 emission standard	U.S EPA Tier 2 emission standard	California Air Resources Board LEV III emission standard
1	Bin 160	Bin 5 through Bin 8	LEV 160.
3	Bin 125, Bin 110	Bin 4	ULEV125.
5	Bin 85, Bin 70	Bin 3	ULEV70.
6	Bin 50		ULEV50.
7	Bin 30	Bin 2	SULEV30.
8	Bin 20		SULEV20.
10	Bin 0	Bin 1	ZEV.

TABLE 3 OF § 600.311–12—CRITERIA FOR ESTABLISHING SMOG RATING THROUGH MODEL YEAR 2017

Rating	U.S. EPA Tier 2 emission standard	U.S. EPA Tier 3 emission standard	California Air Resources Board LEV II emission standard	California Air Resources Board LEV III emission standard
1			ULEV & LEV II large trucks.	
2	Bin 8		SULEV II large trucks.	
3	Bin 7.			
4	Bin 6		LEV II, option 1.	
5	Bin 5	Bin 160	LEV II	LEV160.
6	Bin 4	Bin 125, Bin 110	ULEV II	ULEV125.
7	Bin 3	Bin 85, Bin 70, Bin 50		ULEV70, ULEV50.
8	Bin 2 <sup>1</sup>	Bin 30	SULEV II	SULEV30.
9		Bin 20	PZEV	SULEV20, PZEV.
10	Bin 1	Bin 0	ZEV	ZEV.

<sup>1</sup> Vehicles qualify with a rating of 9 instead of 8 if they are certified to the EPA Tier 2, Bin 2 standards, and they are sold nationwide in a configuration that is certified in California to the PZEV or SULEV20 standards.

\* \* \* \* \*

**Subpart F—Procedures for Determining Manufacturer’s Average Fuel Economy and Manufacturer’s Average Carbon-Related Exhaust Emissions**

- 104. Section 600.510–12 is amended as follows:
- a. By revising the entry for “MPG =” in paragraph (c)(1)(ii) after the equation.
- b. By revising paragraphs (c)(2)(vi) introductory text, (c)(2)(vii)(A) introductory text, and (h).

The revisions read as follows:

**§ 600.510–12 Calculation of average fuel economy and average carbon-related exhaust emissions.**

\* \* \* \* \*

- (c) \* \* \*
- (1) \* \* \*
- (ii) \* \* \*

MPG = the average fuel economy for a category of vehicles determined according to paragraph (h) of this section;

\* \* \* \* \*

- (c) \* \* \*
- (2) \* \* \*

(vi) For natural gas dual fuel model types, for model years 1993 through 2016, the harmonic average of the following two terms; the result rounded to the nearest 0.1 mpg:

\* \* \* \* \*

(vii)(A) For natural gas dual fuel model types, for model years after 2016, the combined model type fuel economy determined according to the following formula and rounded to the nearest 0.1 mpg:

\* \* \* \* \*

(h) The increase in average fuel economy determined in paragraph (c) of this section attributable to dual fueled

automobiles is subject to a maximum value that applies separately to each category of automobile specified in paragraph (a)(1) of this section. The increase in average fuel economy attributable to vehicles fueled by electricity or, for model years 2016 and later, by compressed natural gas, is not subject to a maximum value. The following maximum values apply under this paragraph (h):

Model year	Maximum increase (mpg)
1993–2014	1.2
2015	1.0
2016	0.8
2017	0.6
2018	0.4
2019	0.2
2020 and later	0.0

(1) The Administrator shall calculate the increase in average fuel economy to determine if the maximum increase provided in this paragraph (h) has been reached. The Administrator shall calculate the increase in average fuel economy for each category of automobiles specified in paragraph (a)(1) of this section by subtracting the average fuel economy values calculated in accordance with this section, assuming all alcohol dual fueled automobiles are operated exclusively on gasoline (or diesel fuel), from the average fuel economy values determined in paragraph (c) of this section. The difference is limited to the maximum increase specified in this paragraph (h).

(2) [Reserved]

\* \* \* \* \*

**PART 1033—CONTROL OF EMISSIONS FROM LOCOMOTIVES**

■ 105. The authority citation for part 1033 continues to read as follows:

Authority: 42 U.S.C. 7401–7671q.

**Subpart A—Overview and Applicability**

■ 106. Section 1033.1 is amended by revising paragraph (e) to read as follows:

**§ 1033.1 Applicability.**

\* \* \* \* \*

(e) The provisions of this part apply as specified for locomotives manufactured or remanufactured on or after July 7, 2008. See § 1033.102 to determine whether the standards of this part or the standards specified in Appendix I of this part apply for model years 2008 through 2012. For example, for a locomotive that was originally manufactured in 2007 and remanufactured on April 10, 2014, the provisions of this part begin to apply on April 10, 2014.

■ 107. Section 1033.30 is revised to read as follows:

**§ 1033.30 Submission of information.**

Unless we specify otherwise, send all reports and requests for approval to the Designated Compliance Officer (see § 1033.901). See § 1033.925 for additional reporting and recordkeeping provisions.

**Subpart B—Emission Standards and Related Requirements**

■ 108. Section 1033.101 is amended by revising paragraphs (f)(1)(ii), (f)(2)(i) and (iii), and (i) to read as follows:

**§ 1033.101 Exhaust emission standards.**

\* \* \* \* \*

(f) \* \* \*

(1) \* \* \*

(ii) Gaseous-fueled locomotives: Nonmethane-nonethane emissions (NMNEHC). This includes dual-fuel and flexible-fuel locomotives that use a combination of a gaseous fuel and a nongaseous fuel.

\* \* \* \* \*

(2) \* \* \*

(i) Certify your Tier 4 and later diesel-fueled locomotives for operation with only Ultra Low Sulfur Diesel (ULSD) fuel. Use ULSD as the test fuel for these locomotives. You may alternatively certify Tier 4 and later locomotives using Low Sulfur Diesel Fuel (LSD).

\* \* \* \* \*

(iii) Certify your Tier 3 and earlier diesel-fueled locomotives for operation with either ULSD fuel or LSD fuel if they do not include sulfur-sensitive technology or if you demonstrate compliance using an LSD test fuel (including commercial LSD fuel).

\* \* \* \* \*

(i) *Alternate CO standards.*

Manufacturers/remanufacturers may certify locomotives to an alternate CO emission standard of 10.0 g/bhp-hr instead of the otherwise applicable CO standard if they also certify those locomotives to alternate PM standards as follows:

(1) The alternate PM standard for Tier 0, Tier 1, and Tier 2 locomotives is one-half of the otherwise applicable PM standard. For example, a manufacturer certifying Tier 2 switch locomotives to a 0.065 g/bhp-hr PM standard may certify those locomotives to the alternate CO standard of 10.0 g/bhp-hr.

(2) The alternate PM standard for Tier 3 and Tier 4 locomotives is 0.01 g/bhp-hr.

\* \* \* \* \*

■ 109. Section 1033.102 is revised to read as follows:

**§ 1033.102 Transition to the standards specified in this subpart.**

(a) The Tier 0 and Tier 1 standards of § 1033.101 apply for new locomotives beginning January 1, 2010, except as specified in § 1033.150(a). The Tier 0 and Tier 1 standards specified in Appendix I of this part apply for earlier model years.

(b) Except as specified in § 1033.150(a), the Tier 2 standards of § 1033.101 apply for new locomotives beginning January 1, 2013. The Tier 2 standards specified in Appendix I of this part apply for earlier model years.

(c) The Tier 3 and Tier 4 standards of § 1033.101 apply for the model years specified in that section.

■ 110. Section 1033.120 is amended by revising paragraph (b) to read as follows:

**§ 1033.120 Emission-related warranty requirements.**

\* \* \* \* \*

(b) *Warranty period.* Except as specified in this paragraph, the minimum warranty period is one-third of the useful life. Your emission-related warranty must be valid for at least as long as the minimum warranty periods listed in this paragraph (b) in MW-hrs of operation (or miles for Tier 0 locomotives not equipped with MW-hr meters) and years, whichever comes first. You may offer an emission-related warranty more generous than we require. The emission-related warranty for the locomotive may not be shorter than any basic mechanical warranty you provide without charge for the locomotive. Similarly, the emission-related warranty for any component may not be shorter than any warranty you provide without charge for that component. This means that your warranty may not treat emission-related and nonemission-related defects differently for any component. If you provide an extended warranty to individual owners for any components covered in paragraph (c) of this section for an additional charge, your emission-related warranty must cover those components for those owners to the same degree. If the locomotive does not record MW-hrs, we base the warranty periods in this paragraph (b) only on years. The warranty period begins when the locomotive is placed into service, or back into service after remanufacture.

\* \* \* \* \*

■ 111. Section 1033.135 is amended by revising paragraph (b)(3) to read as follows:

**§ 1033.135 Labeling.**

\* \* \* \* \*

(b) \* \* \*

(3) Label diesel-fueled locomotives near the fuel inlet to identify the allowable fuels, consistent with § 1033.101. For example, Tier 4 locomotives with sulfur-sensitive technology (or that otherwise require ULSD for compliance) should be labeled “ULTRA LOW SULFUR DIESEL FUEL ONLY”. You do not need to label Tier 3 and earlier locomotives certified for use with both LSD and ULSD.

\* \* \* \* \*

■ 112. Section 1033.150 is amended by revising paragraphs (a)(4)(ii) and (g) introductory text to read as follows:

**§ 1033.150 Interim provisions.**

\* \* \* \* \*

(a) \* \* \*

(4) \* \* \*

(ii) Calculate all costs in current dollars (for the month prior to the date

you submit your application). Calculate fuel costs based on a fuel price adjusted by the Association of American Railroads' monthly railroad fuel price index (P), which is available at <https://www.aar.org/data-center/rail-cost-indexes>. (Use values indexed to a price of 100.0 for July 15, 1990.) Calculate a new fuel price using the following equation:

$$\text{Fuel Price} = (\$2.76 \text{ per gallon}) \times (P / 539.8)$$

\* \* \* \* \*

(g) *Optional interim Tier 4 compliance provisions for NO<sub>x</sub> emissions.* For model years 2015 through 2022, manufacturers may choose to certify some or all of their Tier 4 line-haul engine families according to the optional compliance provisions of this paragraph (g). The following provisions apply to all locomotives in those families:

\* \* \* \* \*

**Subpart C—Certifying Engine Families**

■ 113. Section 1033.201 is amended by revising paragraphs (a) and (g) to read as follows:

**§ 1033.201 General requirements for obtaining a certificate of conformity.**

\* \* \* \* \*

(a) You must send us a separate application for a certificate of conformity for each engine family. A certificate of conformity is valid for new production from the indicated effective date, until the end of the model year for which it is issued, which may not extend beyond December 31 of that year. No certificate will be issued after December 31 of the model year. You may amend your application for certification after the end of the model year in certain circumstances as described in §§ 1033.220 and 1033.225. You must renew your certification annually for any locomotives you continue to produce.

\* \* \* \* \*

(g) We may require you to deliver your test locomotives (including test engines, as applicable) to a facility we designate for our testing (see § 1033.235(c)). Alternatively, you may choose to deliver another engine/locomotive that is identical in all material respects to the test locomotive, or another engine/locomotive that we determine can appropriately serve as an emission-data locomotive for the engine family.

\* \* \* \* \*

■ 114. Section 1033.225 is amended by revising the section heading and adding

paragraphs (b)(4) and (g) to read as follows:

**§ 1033.225 Amending applications for certification.**

\* \* \* \* \*

(b) \* \* \*  
(4) Include any other information needed to make your application correct and complete.

\* \* \* \* \*

(g) You may produce engines as described in your amended application for certification and consider those engines to be in a certified configuration if we approve a new or modified engine configuration during the model year under paragraph (d) of this section. Similarly, you may modify in-use engines as described in your amended application for certification and consider those engines to be in a certified configuration if we approve a new or modified engine configuration at any time under paragraph (d) of this section. Modifying a new or in-use engine to be in a certified configuration does not violate the tampering prohibition of 40 CFR 1068.101(b)(1), as long as this does not involve changing to a certified configuration with a higher family emission limit.

■ 115. Section 1033.235 is amended by revising paragraphs (b), (c) introductory text, (c)(4), and (d)(1) to read as follows:

**§ 1033.235 Emission testing required for certification.**

\* \* \* \* \*

(b) Test your emission-data locomotives using the procedures and equipment specified in subpart F of this part. In the case of dual-fuel locomotives, measure emissions when operating with each type of fuel for which you intend to certify the locomotive. In the case of flexible-fuel locomotives, measure emissions when operating with the fuel mixture that best represents in-use operation or is most likely to have the highest NO<sub>x</sub> emissions, though you may ask us instead to perform tests with both fuels separately if you can show that intermediate mixtures are not likely to occur in use.

(c) We may perform confirmatory testing by measuring emissions from any of your emission-data locomotives or other locomotives from the engine family.

\* \* \* \* \*

(4) Before we test one of your locomotives, we may calibrate it within normal production tolerances for anything we do not consider an adjustable parameter. For example, this would apply for a parameter that is subject to production variability because

it is adjustable during production, but is not considered an adjustable parameter (as defined in § 1033.901) because it is permanently sealed.

(d) \* \* \*

(1) The engine family from the previous model year differs from the current engine family only with respect to model year, items identified in § 1033.225(a), or other factors not related to emissions. We may waive this criterion for differences we determine not to be relevant.

\* \* \* \* \*

■ 116. Section 1033.245 is amended by revising the introductory text and paragraph (b) introductory text and adding paragraphs (b)(3) through (5) to read as follows:

**§ 1033.245 Deterioration factors.**

Establish deterioration factors for each pollutant to determine whether your locomotives will meet emission standards for each pollutant throughout the useful life, as described in § 1033.240. Determine deterioration factors as described in this section, either with an engineering analysis, with pre-existing test data, or with new emission measurements. The deterioration factors are intended to reflect the deterioration expected to result during the useful life of a locomotive maintained as specified in § 1033.125. If you perform durability testing, the maintenance that you may perform on your emission-data locomotive is limited to the maintenance described in § 1033.125. You may carry across a deterioration factor from one engine family to another consistent with good engineering judgment.

\* \* \* \* \*

(b) Apply deterioration factors as follows:

\* \* \* \* \*

(3) *Sawtooth and other nonlinear deterioration patterns.* The deterioration factors described in paragraphs (b)(1) and (2) of this section assume that the highest useful life emissions occur either at the end of useful life or at the low-hour test point. The provisions of this paragraph (b)(3) apply where good engineering judgment indicates that the highest emissions over the useful life will occur between these two points. For example, emissions may increase with service accumulation until a certain maintenance step is performed, then return to the low-hour emission levels and begin increasing again. Base deterioration factors for locomotives with such emission patterns on the difference between (or ratio of) the point at which the highest emissions occur

and the low-hour test point. Note that this applies for maintenance-related deterioration only where we allow such critical emission-related maintenance.

(4) *Dual-fuel and flexible-fuel engines.* In the case of dual-fuel and flexible-fuel locomotives, apply deterioration factors separately for each fuel type by measuring emissions with each fuel type at each test point. You may accumulate service hours on a single emission-data engine using the type of fuel or the fuel mixture expected to have the highest combustion and exhaust temperatures; you may ask us to approve a different fuel mixture if you demonstrate that a different criterion is more appropriate.

(5) *Deterioration factor for crankcase emissions.* If your engine vents crankcase emissions to the exhaust or to the atmosphere, you must account for crankcase emission deterioration, using good engineering judgment. You may use separate deterioration factors for crankcase emissions of each pollutant (either multiplicative or additive) or include the effects in combined deterioration factors that include exhaust and crankcase emissions together for each pollutant.

\* \* \* \* \*

■ 117. Section 1033.250 is amended by revising paragraphs (b)(3)(iv) and (c) to read as follows:

**§ 1033.250 Reporting and recordkeeping.**

\* \* \* \* \*

- (b) \* \* \*
- (3) \* \* \*

(iv) All your emission tests (valid and invalid), including the date and purpose of each test and documentation of test parameters as specified in part 40 CFR part 1065, and the date and purpose of each test.

\* \* \* \* \*

(c) Keep required data from emission tests and all other information specified in this section for eight years after we issue your certificate. If you use the same emission data or other information for a later model year, the eight-year period restarts with each year that you continue to rely on the information.

\* \* \* \* \*

■ 118. Section 1033.255 is amended by revising paragraphs (c)(2), (c)(4), (d), and (e) to read as follows:

**§ 1033.255 EPA decisions.**

\* \* \* \* \*

- (c) \* \* \*

(2) Submit false or incomplete information (paragraph (e) of this section applies if this is fraudulent). This includes doing anything after submission of your application to

render any of the submitted information false or incomplete.

\* \* \* \* \*

(4) Deny us from completing authorized activities (see 40 CFR 1068.20). This includes a failure to provide reasonable assistance.

\* \* \* \* \*

(d) We may void the certificate of conformity for an engine family if you fail to keep records, send reports, or give us information as required under this part or the Act. Note that these are also violations of 40 CFR 1068.101(a)(2).

(e) We may void your certificate if we find that you intentionally submitted false or incomplete information. This includes rendering submitted information false or incomplete after submission.

\* \* \* \* \*

**Subpart D—Manufacturer and Remanufacturer Production Line Testing and Audit Programs**

■ 119. Section 1033.301 is amended by revising paragraph (a) to read as follows:

**§ 1033.301 Applicability.**

\* \* \* \* \*

(a) The requirements of §§ 1033.310, 1033.315, 1033.320, and 1033.330 apply only to manufacturers of freshly manufactured locomotives or locomotive engines (including those used for repowering). We may also apply these requirements to remanufacturers of any locomotives for which there is reason to believe production problems exist that could affect emission performance. When we make a determination that production problems may exist that could affect emission performance, we will notify the remanufacturer(s). The requirements of §§ 1033.310, 1033.315, 1033.320, and 1033.330 will apply as specified in the notice.

\* \* \* \* \*

**§ 1033.320 [Amended]**

■ 120. Section 1033.320 is amended by redesignating paragraphs (e)(6) and (e)(7) as paragraphs (e)(5) and (e)(6), respectively.

**Subpart F—Test Procedures**

■ 121. Section 1033.501 is amended by revising paragraph (a)(3) and adding paragraphs (a)(4), (a)(5), and (j) to read as follows:

**§ 1033.501 General provisions.**

(a) \* \* \*

(3) The following provisions apply for engine mapping, duty-cycle generation, and cycle validation to account for the

fact that locomotive operation and locomotive duty cycles are based on operator demand from locomotive notch settings, not on target values for engine speed and load:

(i) The provisions related to engine mapping, duty-cycle generation, and cycle validation in 40 CFR 1065.510, 1065.512, and 1065.514 do not apply for testing complete locomotives.

(ii) The provisions related to engine mapping and duty-cycle generation in 40 CFR 1065.510 and 1065.512 are not required for testing with an engine dynamometer; however, the cycle validation criteria of 40 CFR 1065.514 apply for such testing. Demonstrate compliance with cycle validation criteria based on manufacturer-declared values for maximum torque, maximum power, and maximum test speed, or determine these values from an engine map generated according to 40 CFR 1065.510. If you test using a ramped-modal cycle, you may perform cycle validation over all the test intervals together.

(4) If you perform discrete-mode testing and use only one batch fuel measurement to determine your mean raw exhaust flow rate, you must target a constant sample flow rate over the mode. Verify proportional sampling as described in 40 CFR 1065.545 using the mean raw exhaust molar flow rate paired with each recorded sample flow rate.

(5) If you perform discrete-mode testing by grouping the modes in the same manner as the test intervals of the ramped modal cycle using three different dilution settings for the groups, as allowed in § 1033.515(c)(5)(ii), you may verify proportional sampling over each group instead of each discrete mode.

\* \* \* \* \*

(j) The following provisions apply for locomotives using aftertreatment technology with infrequent regeneration events that may occur during testing:

(1) Adjust measured emissions to account for aftertreatment technology with infrequent regeneration as described in § 1033.535.

(2) Invalidate a smoke test if active regeneration starts to occur during the test.

■ 122. Section 1033.515 is amended by revising paragraphs (c)(2)(ii), (c)(4), and (c)(5)(ii) to read as follows:

**§ 1033.515 Discrete-mode steady-state emission tests of locomotives and locomotive engines.**

\* \* \* \* \*

- (c) \* \* \*
- (2) \* \* \*

(ii) The sample period is 300 seconds for all test modes except mode 8. The sample period for test mode 8 is 600 seconds.

\* \* \* \* \*

(4) If applicable, begin the smoke test at the start of the test mode A. Continue collecting smoke data until the completion of test mode 8. You may perform smoke measurements independent of criteria pollutant measurements by repeating the test over the duty cycle. If you choose this option, the minimum time-in-notch is 3.0 minutes for duty cycles in which only smoke is measured. Refer to § 1033.101 to determine applicability of smoke testing and § 1033.525 for details on how to conduct a smoke test.

(5) \* \* \*

(ii) Group the modes in the same manner as the test intervals of the ramped modal cycle and use three different dilution settings for the groups. Use one setting for both idle modes, one for dynamic brake through Notch 5, and one for Notch 6 through Notch 8. For each group, ensure that the mode with the highest exhaust flow (typically normal idle, Notch 5, and Notch 8) meets the criteria for minimum dilution ratio in 40 CFR part 1065.

\* \* \* \* \*

■ 123. Section 1033.520 is revised to read as follows:

**§ 1033.520 Alternative ramped modal cycles.**

(a) Locomotive testing over a ramped modal cycle is intended to improve measurement accuracy at low emission levels by allowing the use of batch sampling of PM and gaseous emissions over multiple locomotive notch settings. Ramped modal cycles combine multiple test modes of a discrete-mode steady-state into a single sample period. Time in notch is varied to be proportional to weighting factors. The ramped modal cycle for line-haul locomotives is shown in Table 1 to this section. The ramped modal cycle for switch locomotives is shown in Table 2 to this section. Both ramped modal cycles consist of a warm-up followed by three test intervals that are each weighted in a manner that maintains the duty-cycle weighting of the line-haul and switch locomotive duty cycles in § 1033.530. You may use ramped modal cycle testing for any locomotives certified under this part.

(b) Ramped modal testing requires continuous gaseous analyzers and three separate PM filters (one for each test

interval). You may collect a single batch sample for each test interval, but you must also measure gaseous emissions continuously to allow calculation of notch caps as required under § 1033.101.

(c) You may operate the engine in any way you choose to warm it up. Then follow the provisions of 40 CFR part 1065, subpart F for general pre-test procedures (including engine and sampling system pre-conditioning).

(d) Begin the test by operating the locomotive over the pre-test portion of the cycle. For locomotives not equipped with catalysts, you may begin the test as soon as the engine reaches its lowest idle setting. For catalyst-equipped locomotives, you may begin the test in normal idle mode if the engine does not reach its lowest idle setting within 15 minutes. If you do start in normal idle, run the low idle mode after normal idle, then resume the specified mode sequence (without repeating the normal idle mode).

(e) Start the test according to 40 CFR 1065.530.

(1) Each test interval begins when operator demand is set to the first operator demand setting of each test interval of the ramped modal cycle. Each test interval ends when the time in mode is reached for the last mode in the test interval.

(2) For PM emissions (and other batch sampling), the sample period over which emissions for the test interval are averaged generally begins within 10 seconds after the operator demand is changed to start the test interval and ends within 5 seconds of the sampling time for the test mode is reached (see Table 1 to this section). You may ask to delay the start of the sample period to account for sample system residence times longer than 10 seconds.

(3) Use good engineering judgment when transitioning between test intervals.

(i) You should come as close as possible to simultaneously:

(A) Ending batch sampling of the previous test interval.

(B) Starting batch sampling of the next test interval.

(C) Changing the operator demand to the notch setting for the first mode in the next test interval.

(ii) Avoid the following:

(A) Overlapping batch sampling of the two test intervals.

(B) An unnecessarily long delay before starting the next test interval.

(iii) For example, the following sequence would generally be appropriate:

(A) End batch sampling for Interval 2 after 304 seconds in Notch 5.

(B) Switch the operator demand to Notch 6 one second later.

(C) Begin batch sampling for Interval 3 one second after switching to Notch 6.

(4) If applicable, begin the smoke test at the start of the first test interval of the applicable ramped modal cycle. Continue collecting smoke data until the completion of final test interval. You may perform smoke measurements independent of criteria pollutant measurements by rerunning the test over the duty cycle. If you choose this option, the minimum time-in-notch is 3.0 minutes for duty cycles in which only smoke is measured. Refer to § 1033.101 to determine applicability of the smoke standards and § 1033.525 for details on how to conduct a smoke test.

(5) Proceed through each test interval of the applicable ramped modal cycle in the order specified until the test is completed.

(6) If you must void a test interval, you may repeat it. To do so, begin with a warm engine operating at the notch setting for the last mode in the previous test interval. You do not need to repeat later test intervals if they were valid. (**Note:** You must report test results for all voided tests and test intervals.)

(7) Following the completion of the third test interval of the applicable ramped modal cycle, conduct the post-test sampling procedures specified in 40 CFR 1065.530.

(f) Calculate your cycle-weighted brake-specific emission rates as follows:

(1) For each test interval  $j$ :

(i) Calculate emission rates ( $E_{ij}$ ) for each pollutant  $i$  as the total mass emissions divided by the total time in the test interval.

(ii) Calculate average power ( $P_j$ ) as the total work divided by the total time in the test interval.

(2) For each pollutant, calculate your cycle-weighted brake-specific emission rate using the following equation, where  $w_j$  is the weighting factor for test interval  $j$ :

$$E_{ij} = \frac{w_1 \cdot E_{i1} + w_2 \cdot E_{i2} + w_3 \cdot E_{i3}}{w_1 \cdot P_1 + w_2 \cdot P_2 + w_3 \cdot P_3}$$

(g) The following tables define applicable ramped modal cycles for line-haul and switch locomotives:

TABLE 1 TO § 1033.520—LINE-HAUL LOCOMOTIVE RAMPED MODAL CYCLE

RMC test interval	Weighting factor	RMC mode	Time in mode (seconds)	Notch setting
Pre-test idle .....	NA	NA	600 to 900	Lowest idle setting. <sup>1</sup>
Interval 1 (Idle test) .....	0.380	A B	600 600	Low Idle. <sup>2</sup> Normal Idle.
<b>Interval Transition</b>				
Interval 2 .....	0.389	C	1000	Dynamic Brake. <sup>3</sup>
		1	520	Notch 1.
		2	520	Notch 2.
		3	416	Notch 3.
		4	352	Notch 4.
		5	304	Notch 5.
<b>Interval Transition</b>				
Interval 3 .....	0.231	6	144	Notch 6.
		7	111	Notch 7.
		8	600	Notch 8.

<sup>1</sup> See paragraph (d) of this section for alternate pre-test provisions.  
<sup>2</sup> Operate at normal idle for modes A and B if not equipped with multiple idle settings.  
<sup>3</sup> Operate at normal idle if not equipped with a dynamic brake.

TABLE 2 TO § 1033.520—SWITCH LOCOMOTIVE RAMPED MODAL CYCLE

RMC test interval	Weighting factor	RMC mode	Time in mode (seconds)	Notch setting
Pre-test idle .....	NA	NA	600 to 900	Lowest idle setting. <sup>1</sup>
Interval 1 (Idle test) .....	0.598	A B	600 600	Low Idle. <sup>2</sup> Normal Idle.
<b>Interval Transition</b>				
Interval 2 .....	0.377	1	868	Notch 1.
		2	861	Notch 2.
		3	406	Notch 3.
		4	252	Notch 4.
		5	252	Notch 5.
<b>Interval Transition</b>				
Interval 3 .....	0.025	6	1080	Notch 6.
		7	144	Notch 7.
		8	576	Notch 8.

<sup>1</sup> See paragraph (d) of this section for alternate pre-test provisions.  
<sup>2</sup> Operate at normal idle for modes A and B if not equipped with multiple idle settings.

■ 124. Section 1033.535 is revised to read as follows:

**§ 1033.535 Adjusting emission levels to account for infrequently regenerating aftertreatment devices.**

For locomotives using aftertreatment technology with infrequent regeneration events that may occur during testing, take one of the following approaches to account for the emission impact of regeneration:

(a) You may use the calculation methodology described in 40 CFR 1065.680 to adjust measured emission results. Do this by developing an upward adjustment factor and a downward adjustment factor for each pollutant based on measured emission

data and observed regeneration frequency as follows:

(1) Adjustment factors should generally apply to an entire engine family, but you may develop separate adjustment factors for different configurations within an engine family. Use the adjustment factors from this section for all testing for the engine family.

(2) You may use carryover or carry-across data to establish adjustment factors for an engine family as described in § 1033.235, consistent with good engineering judgment.

(3) Determine the frequency of regeneration, *F*, as described in 40 CFR 1065.680 from in-use operating data or from running repetitive tests in a laboratory. If the engine is designed for

regeneration at fixed time intervals, you may apply good engineering judgment to determine *F* based on those design parameters.

(4) Identify the value of *F* in each application for the certification for which it applies.

(5) Apply the provisions for ramped-modal testing based on measurements for each test interval rather than the whole ramped-modal test.

(b) You may ask us to approve an alternate methodology to account for regeneration events. We will generally limit approval to cases where your engines use aftertreatment technology with extremely infrequent regeneration and you are unable to apply the provisions of this section.

(c) You may choose to make no adjustments to measured emission results if you determine that regeneration does not significantly affect emission levels for an engine family (or configuration) or if it is not practical to identify when regeneration occurs. If you choose not to make adjustments under paragraph (a) or (b) of this section, your locomotives must meet emission standards for all testing, without regard to regeneration.

**Subpart G—Special Compliance Provisions**

■ 125. Section 1033.601 is amended by adding paragraph (f) to read as follows:

**§ 1033.601 General compliance provisions.**

\* \* \* \* \*

(f) *Multi-fuel locomotives.* Subpart C of this part describes how to test and certify dual-fuel and flexible-fuel locomotives. Some multi-fuel locomotives may not fit either of those defined terms. For such locomotives, we will determine whether it is most appropriate to treat them as single-fuel locomotives, dual-fuel locomotives, or flexible-fuel locomotives based on the range of possible and expected fuel mixtures. For example, a locomotive might burn natural gas but initiate combustion with a pilot injection of diesel fuel. If the locomotive is designed to operate with a single fueling algorithm (*i.e.*, fueling rates are fixed at a given engine speed and load condition), we would generally treat it as a single-fuel locomotive. In this context, the combination of diesel fuel and natural gas would be its own fuel type. If the locomotive is designed to also operate on diesel fuel alone, we would generally treat it as a dual-fuel locomotive. If the locomotive is designed to operate on varying mixtures of the two fuels, we would generally treat it as a flexible-fuel locomotive. To the extent that requirements vary for the different fuels or fuel mixtures, we may apply the more stringent requirements.

**§ 1033.640 [Amended]**

■ 126. Section 1033.640 is amended by redesignating the second paragraph (c) and paragraphs (d) and (e) as paragraphs (d) through (f), respectively.

**Subpart H—Averaging, Banking, and Trading for Certification**

■ 127. Section 1033.701 is amended by adding paragraph (k) to read as follows:

**§ 1033.701 General provisions.**

\* \* \* \* \*

(k) You may use either of the following approaches to retire or forego emission credits:

(1) You may retire emission credits generated from any number of your locomotives. This may be considered donating emission credits to the environment. Identify any such credits in the reports described in § 1033.730. Locomotives must comply with the applicable FELs even if you donate or sell the corresponding emission credits under this paragraph (e). Those credits may no longer be used by anyone to demonstrate compliance with any EPA emission standards.

(2) You may certify a family using an FEL below the emission standard as described in this part and choose not to generate emission credits for that family. If you do this, you do not need to calculate emission credits for those families and you do not need to submit or keep the associated records described in this subpart for that family.

■ 128. Section 1033.710 is amended by revising paragraph (c) to read as follows:

**§ 1033.710 Averaging emission credits.**

\* \* \* \* \*

(c) If you certify an engine family to an FEL that exceeds the otherwise applicable emission standard, you must obtain enough emission credits to offset the engine family's deficit by the due date for the final report required in § 1033.730. The emission credits used to address the deficit may come from your other engine families that generate emission credits in the same model year, from emission credits you have banked from previous model years, or from emission credits generated in the same or previous model years that you obtained through trading or by transfer.

■ 129. Section 1033.725 is amended by revising paragraph (b)(2) to read as follows:

**§ 1033.725 Requirements for your application for certification.**

\* \* \* \* \*

(b) \* \* \*

(2) Detailed calculations of projected emission credits (positive or negative) based on projected production volumes. We may require you to include similar calculations from your other engine families to demonstrate that you will be able to avoid negative credit balances for the model year. If you project negative emission credits for a family, state the source of positive emission credits you expect to use to offset the negative emission credits.

■ 130. Section 1033.730 is amended by revising paragraphs (b)(1), (b)(4), (c)(2), and (d) to read as follows:

**§ 1033.730 ABT reports.**

\* \* \* \* \*

(b) \* \* \*

(1) Engine family designation and averaging sets (whether switch, line-haul, or both).

\* \* \* \* \*

(4) The projected and actual U.S.-directed production volumes for the model year as described in § 1033.705. If you changed an FEL during the model year, identify the actual U.S.-directed production volume associated with each FEL.

\* \* \* \* \*

(c) \* \* \*

(2) State whether you will retain any emission credits for banking. If you choose to retire emission credits that would otherwise be eligible for banking, identify the engine families that generated the emission credits, including the number of emission credits from each family.

\* \* \* \* \*

(d) If you trade emission credits, you must send us a report within 90 days after the transaction, as follows:

(1) As the seller, you must include the following information in your report:

(i) The corporate names of the buyer and any brokers.

(ii) A copy of any contracts related to the trade.

(iii) The averaging set corresponding to the engine families that generated emission credits for the trade, including the number of emission credits from each averaging set.

(2) As the buyer, you must include the following information in your report:

(i) The corporate names of the seller and any brokers.

(ii) A copy of any contracts related to the trade.

(iii) How you intend to use the emission credits, including the number of emission credits you intend to apply for each averaging set.

\* \* \* \* \*

■ 131. Section 1033.735 is amended by revising paragraphs (a) and (b) to read as follows:

**§ 1033.735 Required records.**

(a) You must organize and maintain your records as described in this section.

(b) Keep the records required by this section for at least eight years after the due date for the end-of-year report. You may not use emission credits for any engines if you do not keep all the records required under this section. You must therefore keep these records to continue to bank valid credits.

\* \* \* \* \*



**Subpart I—Requirements for Owners and Operators**

■ 132. Section 1033.815 is amended by revising paragraphs (b) and (c) introductory text to read as follows:

**§ 1033.815 Maintenance, operation, and repair.**

(b) Perform unscheduled maintenance in a timely manner. This includes malfunctions identified through the locomotive’s emission control diagnostics system and malfunctions discovered in components of the diagnostics system itself. For most repairs, this paragraph (b) requires that the maintenance be performed no later than the locomotive’s next periodic (92-day or 184-day) inspection. See paragraph (e) of this section, for reductant replenishment requirements in a locomotive equipped with an SCR system.

(c) For locomotives equipped with emission controls requiring the use of specific fuels, lubricants, or other fluids, proper maintenance includes complying with the manufacturer/remanufacturer’s specifications for such fluids when operating the locomotives. This requirement applies without regard to whether misfueling permanently disables the emission controls. For locomotives certified on ultra-low sulfur diesel fuel, but that do not include sulfur-sensitive emission controls, you may use low-sulfur diesel fuel instead of ultra-low sulfur diesel fuel, consistent with good engineering judgment. The following additional provisions apply for locomotives equipped with SCR systems requiring the use of urea or other reductants:

**Subpart J—Definitions and Other Reference Information**

■ 133. Section 1033.901 is amended as follows:

- a. By revising the definition for “Designated Compliance Officer”.
- b. By adding definitions for “Dual-fuel” and “Flexible-fuel” in alphabetical order.
- c. By revising the definitions for “Remanufacture system or remanufacturing system”, “Sulfur-sensitive technology”, and “Total hydrocarbon equivalent”.

The revisions and addition read as follows:

**§ 1033.901 Definitions.**

*Designated Compliance Officer* means the Director, Diesel Engine Compliance

Center, U.S. Environmental Protection Agency, 2000 Traverwood Drive, Ann Arbor, MI 48105; *complianceinfo@epa.gov*; *epa.gov/otaq/verify*.

*Dual-fuel* means relating to a locomotive designed for operation on two different fuels but not on a continuous mixture of those fuels (see § 1033.601(f)). For purposes of this part, such a locomotive remains a dual-fuel locomotive even if it is designed for operation on three or more different fuels.

*Flexible-fuel* means relating to a locomotive designed for operation on any mixture of two or more different fuels (see § 1033.601(f)).

*Remanufacture system or remanufacturing system* means all components (or specifications for components) and instructions necessary to remanufacture a locomotive or locomotive engine in accordance with applicable requirements of this part.

*Sulfur-sensitive technology* means an emission control technology that would experience a significant drop in emission control performance or emission-system durability when a locomotive is operated on low-sulfur diesel fuel with a sulfur concentration of 300 to 500 ppm as compared to when it is operated on ultra low-sulfur diesel fuel (*i.e.*, fuel with a sulfur concentration less than 15 ppm). Exhaust gas recirculation is not a sulfur-sensitive technology.

*Total hydrocarbon equivalent* has the meaning given in 40 CFR 1065.1001. This generally means the sum of the carbon mass contributions of non-oxygenated hydrocarbon, alcohols and aldehydes, or other organic compounds that are measured separately as contained in a gas sample, expressed as exhaust hydrocarbon from petroleum-fueled locomotives. The atomic hydrogen-to-carbon ratio of the equivalent hydrocarbon is 1.85:1.

■ 134. Section 1033.915 is revised to read as follows:

**§ 1033.915 Confidential information.**

The provisions of 40 CFR 1068.10 apply for information you consider confidential.

■ 135. Section 1033.925 is revised to read as follows:

**§ 1033.925 Reporting and recordkeeping requirements.**

(a) This part includes various requirements to submit and record data or other information. Unless we specify otherwise, store required records in any format and on any media and keep them readily available for eight years after you send an associated application for certification, or eight years after you generate the data if they do not support an application for certification. You are expected to keep your own copy of required records rather than relying on someone else to keep records on your behalf. We may review these records at any time. You must promptly send us organized, written records in English if we ask for them. We may require you to submit written records in an electronic format.

(b) The regulations in § 1033.255, 40 CFR 1068.25, and 40 CFR 1068.101 describe your obligation to report truthful and complete information. This includes information not related to certification. Failing to properly report information and keep the records we specify violates 40 CFR 1068.101(a)(2), which may involve civil or criminal penalties.

(c) Send all reports and requests for approval to the Designated Compliance Officer (see § 1033.801).

(d) Any written information we require you to send to or receive from another company is deemed to be a required record under this section. Such records are also deemed to be submissions to EPA. We may require you to send us these records whether or not you are a certificate holder.

(e) Under the Paperwork Reduction Act (44 U.S.C. 3501 *et seq.*), the Office of Management and Budget approves the reporting and recordkeeping specified in the applicable regulations. Failing to properly report information and keep the records we specify violates 40 CFR 1068.101(a)(2), which may involve civil or criminal penalties. The following items illustrate the kind of reporting and recordkeeping we require for locomotives regulated under this part:

(1) We specify the following requirements related to locomotive certification in this part 1033:

(i) In § 1033.150 we include various reporting and recordkeeping requirements related to interim provisions.

(ii) In subpart C of this part we identify a wide range of information required to certify engines.

(iii) In § 1033.325 we specify certain records related to production-line testing.

(iv) In subpart G of this part we identify several reporting and recordkeeping items for making demonstrations and getting approval related to various special compliance provisions.

(v) In §§ 1033.725, 1033.730, and 1033.735 we specify certain records related to averaging, banking, and trading.

(vi) In subpart I of this part we specify certain records related to meeting requirements for remanufactured engines.

(2) We specify the following requirements related to testing in 40 CFR part 1065:

(i) In 40 CFR 1065.2 we give an overview of principles for reporting information.

(ii) In 40 CFR 1065.10 and 1065.12 we specify information needs for establishing various changes to published test procedures.

(iii) In 40 CFR 1065.25 we establish basic guidelines for storing test information.

(iv) In 40 CFR 1065.695 we identify the specific information and data items to record when measuring emissions.

(3) We specify the following requirements related to the general compliance provisions in 40 CFR part 1068:

(i) In 40 CFR 1068.5 we establish a process for evaluating good engineering judgment related to testing and certification.

(ii) In 40 CFR 1068.25 we describe general provisions related to sending and keeping information.

(iii) In 40 CFR 1068.27 we require manufacturers to make locomotives available for our testing or inspection if we make such a request.

(iv) In 40 CFR part 1068, subpart C, we identify several reporting and recordkeeping items for making demonstrations and getting approval related to various exemptions.

(v) In 40 CFR part 1068, subpart D, we identify several reporting and recordkeeping items for making demonstrations and getting approval

related to importing locomotives and engines.

(vi) In 40 CFR 1068.450 and 1068.455 we specify certain records related to testing production-line locomotives in a selective enforcement audit.

(vii) In 40 CFR 1068.501 we specify certain records related to investigating and reporting emission-related defects.

(viii) In 40 CFR 1068.525 and 1068.530 we specify certain records related to recalling nonconforming locomotives.

(ix) In 40 CFR part 1068, subpart G, we specify certain records for requesting a hearing.

■ 136. Appendix I to part 1033 is added to read as follows:

**Appendix I to Part 1033—Original Standards for Tier 0, Tier 1 and Tier 2 Locomotives**

(a) The following emission standards applied for new locomotives not yet subject to this part 1033:

Type of standard	Year of original manufacture	Tier	Standards (g/bhp-hr)		
			NO <sub>x</sub>	PM—primary	PM—alternate <sup>1</sup>
Line-haul .....	1973–1992	Tier 0 .....	9.5	0.60	0.30
	1993–2004	Tier 1 .....	7.4	0.45	0.22
	2005–2011	Tier 2 .....	5.5	0.20	0.10
Switch .....	1973–1992	Tier 0 .....	14.0	0.72	0.36
	1993–2004	Tier 1 .....	11.0	0.54	0.27
	2005–2011	Tier 2 .....	8.1	0.24	0.12

<sup>1</sup> Locomotives certified to the alternate PM standards are also subject to alternate CO standards of 10.0 for the line-haul cycle and 12.0 for the switch cycle.

(b) The original Tier 0, Tier 1, and Tier 2 standards for HC and CO emissions and smoke are the same standards identified in § 1033.101.

■ 137. Part 1036 is revised to read as follows:

**PART 1036—CONTROL OF EMISSIONS FROM NEW AND IN-USE HEAVY-DUTY HIGHWAY ENGINES**

**Subpart A—Overview and Applicability**

- Sec.
- 1036.1 Does this part apply for my engines?
- 1036.2 Who is responsible for compliance?
- 1036.5 Which engines are excluded from this part’s requirements?
- 1036.10 How is this part organized?
- 1036.15 Do any other regulation parts apply to me?
- 1036.30 Submission of information.

**Subpart B—Emission Standards and Related Requirements**

- 1036.100 Overview of exhaust emission standards.
- 1036.108 Greenhouse gas emission standards.
- 1036.115 Other requirements.

- 1036.130 Installation instructions for vehicle manufacturers.
- 1036.135 Labeling.
- 1036.140 Primary intended service class and engine cycle.
- 1036.150 Interim provisions.

**Subpart C—Certifying Engine Families**

- 1036.205 What must I include in my application?
- 1036.210 Preliminary approval before certification.
- 1036.225 Amending my application for certification.
- 1036.230 Selecting engine families.
- 1036.235 Testing requirements for certification.
- 1036.241 Demonstrating compliance with greenhouse gas emission standards.
- 1036.250 Reporting and recordkeeping for certification.
- 1036.255 What decisions may EPA make regarding my certificate of conformity?

**Subpart D—Testing Production Engines**

- 1036.301 Measurements related to GEM inputs in a selective enforcement audit.

**Subpart E—In-use Testing**

- 1036.401 In-use testing.

**Subpart F—Test Procedures**

- 1036.501 How do I run a valid emission test?
- 1036.505 Ramped-modal testing procedures.
- 1036.510 Engine data and information for vehicle certification.
- 1036.525 Hybrid engines.
- 1036.530 Calculating greenhouse gas emission rates.
- 1036.535 Determining steady-state engine fuel maps and fuel consumption at idle.
- 1036.540 Determining cycle-average engine fuel maps.

**Subpart G—Special Compliance Provisions**

- 1036.601 What compliance provisions apply?
- 1036.605 GHG exemption for engines used in specialty vehicles.
- 1036.610 Off-cycle technology credits and adjustments for reducing greenhouse gas emissions.
- 1036.615 Engines with Rankine cycle waste heat recovery and hybrid powertrains.
- 1036.620 Alternate CO<sub>2</sub> standards based on model year 2011 compression-ignition engines.
- 1036.625 In-use compliance with family emission limits (FELs).

1036.630 Certification of engine GHG emissions for powertrain testing.

#### Subpart H—Averaging, Banking, and Trading for Certification

- 1036.701 General provisions.
- 1036.705 Generating and calculating emission credits.
- 1036.710 Averaging.
- 1036.715 Banking.
- 1036.720 Trading.
- 1036.725 What must I include in my application for certification?
- 1036.730 ABT reports.
- 1036.735 Recordkeeping.
- 1036.740 Restrictions for using emission credits.
- 1036.745 End-of-year CO<sub>2</sub> credit deficits.
- 1036.750 What can happen if I do not comply with the provisions of this subpart?
- 1036.755 Information provided to the Department of Transportation.

#### Subpart I—Definitions and Other Reference Information

- 1036.801 Definitions.
  - 1036.805 Symbols, abbreviations, and acronyms.
  - 1036.810 Incorporation by reference.
  - 1036.815 Confidential information.
  - 1036.820 Requesting a hearing.
  - 1036.825 Reporting and recordkeeping requirements.
- Appendix I to Part 1036—Default Engine Fuel Maps for § 1036.540

Authority: 42 U.S.C. 7401—7671q.

#### Subpart A—Overview and Applicability

##### § 1036.1 Does this part apply for my engines?

(a) Except as specified in § 1036.5, the provisions of this part apply for engines that will be installed in heavy-duty vehicles (including glider vehicles) above 14,000 pounds GVWR for propulsion. These provisions also apply for engines that will be installed in incomplete heavy-duty vehicles at or below 14,000 pounds GVWR unless the engine is installed in a vehicle that is covered by a certificate of conformity under 40 CFR part 86, subpart S.

(b) This part does not apply with respect to exhaust emission standards for HC, CO, NO<sub>x</sub>, or PM except as follows:

(1) The provisions of § 1036.601 apply.

(2) 40 CFR parts 85 and/or 86 may specify that certain provisions apply.

(c) The provisions of this part also apply for fuel conversions of all engines described in paragraph (a) of this section as described in 40 CFR 85.502.

(d) Gas turbine heavy-duty engines and other heavy-duty engines not meeting the definition *compression-ignition* or *spark-ignition* are deemed to be compression-ignition engines for purposes of this part.

##### § 1036.2 Who is responsible for compliance?

The regulations in this part 1036 contain provisions that affect both engine manufacturers and others. However, the requirements of this part are generally addressed to the engine manufacturer(s). The term “you” generally means the engine manufacturer(s), especially for issues related to certification. Additional requirements and prohibitions apply to other persons as specified in subpart G of this part and 40 CFR part 1068.

##### § 1036.5 Which engines are excluded from this part’s requirements?

(a) The provisions of this part do not apply to engines used in medium-duty passenger vehicles or other heavy-duty vehicles that are subject to regulation under 40 CFR part 86, subpart S, except as specified in 40 CFR part 86, subpart S, and § 1036.150(j). For example, this exclusion applies for engines used in vehicles certified to the standards of 40 CFR 86.1819.

(b) An engine installed in a heavy-duty vehicle that is not used to propel the vehicle is not a heavy-duty engine. The provisions of this part therefore do not apply to these engines. Note that engines used to indirectly propel the vehicle (such as electrical generator engines that provide power to batteries for propulsion) are subject to this part. See 40 CFR part 1039, 1048, or 1054 for other requirements that apply for these auxiliary engines. See 40 CFR part 1037 for requirements that may apply for vehicles using these engines, such as the evaporative emission requirements of 40 CFR 1037.103.

(c) The provisions of this part do not apply to aircraft or aircraft engines. Standards apply separately to certain aircraft engines, as described in 40 CFR part 87.

(d) The provisions of this part do not apply to engines that are not internal combustion engines. For example, the provisions of this part do not apply to fuel cells. Note that gas turbine engines are internal combustion engines.

(e) The provisions of this part do not apply for model year 2013 and earlier heavy-duty engines unless they were:

(1) Voluntarily certified to this part.

(2) Installed in a glider vehicle subject to 40 CFR part 1037.

##### § 1036.10 How is this part organized?

This part 1036 is divided into the following subparts:

(a) Subpart A of this part defines the applicability of this part 1036 and gives an overview of regulatory requirements.

(b) Subpart B of this part describes the emission standards and other

requirements that must be met to certify engines under this part. Note that § 1036.150 describes certain interim requirements and compliance provisions that apply only for a limited time.

(c) Subpart C of this part describes how to apply for a certificate of conformity.

(d) Subpart D of this part addresses testing of production engines.

(e) Subpart E of this part describes provisions for testing in-use engines.

(f) Subpart F of this part describes how to test your engines (including references to other parts of the Code of Federal Regulations).

(g) Subpart G of this part describes requirements, prohibitions, and other provisions that apply to engine manufacturers, vehicle manufacturers, owners, operators, rebuilders, and all others.

(h) Subpart H of this part describes how you may generate and use emission credits to certify your engines.

(i) Subpart I of this part contains definitions and other reference information.

##### § 1036.15 Do any other regulation parts apply to me?

(a) Part 86 of this chapter describes additional requirements that apply to engines that are subject to this part 1036. This part extensively references portions of 40 CFR part 86. For example, the regulations of part 86 specify emission standards and certification procedures related to criteria pollutants.

(b) Part 1037 of this chapter describes requirements for controlling evaporative emissions and greenhouse gas emissions from heavy-duty vehicles, whether or not they use engines certified under this part. It also includes standards and requirements that apply instead of the standards and requirements of this part in some cases.

(c) Part 1065 of this chapter describes procedures and equipment specifications for testing engines to measure exhaust emissions. Subpart F of this part 1036 describes how to apply the provisions of part 1065 of this chapter to determine whether engines meet the exhaust emission standards in this part.

(d) Certain provisions of part 1068 of this chapter apply as specified in § 1036.601 to everyone, including anyone who manufactures, imports, installs, owns, operates, or rebuilds any of the engines subject to this part 1036, or vehicles containing these engines. Part 1068 of this chapter describes general provisions that apply broadly, but do not necessarily apply for all engines or all persons. See § 1036.601 to

determine how to apply the part 1068 regulations for heavy-duty engines. The issues addressed by these provisions include these seven areas:

- (1) Prohibited acts and penalties for engine manufacturers, vehicle manufacturers, and others.
- (2) Rebuilding and other aftermarket changes.
- (3) Exclusions and exemptions for certain engines.
- (4) Importing engines.
- (5) Selective enforcement audits of your production.
- (6) Recall.
- (7) Procedures for hearings.
- (e) Other parts of this chapter apply if referenced in this part.

**§ 1036.30 Submission of information.**

Unless we specify otherwise, send all reports and requests for approval to the Designated Compliance Officer (see § 1036.801). See § 1036.825 for additional reporting and recordkeeping provisions.

**Subpart B—Emission Standards and Related Requirements**

**§ 1036.100 Overview of exhaust emission standards.**

Engines used in vehicles certified to the applicable chassis standards for greenhouse gases described in 40 CFR 86.1819 are not subject to the standards specified in this part. All other engines subject to this part must meet the

greenhouse gas standards in § 1036.108 in addition to the criteria pollutant standards of 40 CFR part 86.

**§ 1036.108 Greenhouse gas emission standards.**

This section contains standards and other regulations applicable to the emission of the air pollutant defined as the aggregate group of six greenhouse gases: Carbon dioxide, nitrous oxide, methane, hydrofluorocarbons, perfluorocarbons, and sulfur hexafluoride. This section describes the applicable CO<sub>2</sub>, N<sub>2</sub>O, and CH<sub>4</sub> standards for engines. These standards do not apply for engines used in vehicles subject to (or voluntarily certified to) the CO<sub>2</sub>, N<sub>2</sub>O, and CH<sub>4</sub> standards for vehicles specified in 40 CFR 86.1819.

(a) *Emission standards.* Emission standards apply for engines measured using the test procedures specified in subpart F of this part as follows:

- (1) CO<sub>2</sub> emission standards in this paragraph (a)(1) apply based on testing as specified in subpart F of this part. The applicable test cycle for measuring CO<sub>2</sub> emissions differs depending on the engine family's primary intended service class and the extent to which the engines will be (or were designed to be) used in tractors. For medium and heavy heavy-duty engines certified as tractor engines, measure CO<sub>2</sub> emissions using the steady-state duty cycle specified in 40 CFR 86.1362 (referred to as the

ramped-modal cycle, or RMC, even though emission sampling involves measurements from discrete modes). This is intended for engines designed to be used primarily in tractors and other line-haul applications. Note that the use of some RMC-certified tractor engines in vocational applications does not affect your certification obligation under this paragraph (a)(1); see other provisions of this part and 40 CFR part 1037 for limits on using engines certified to only one cycle. For medium and heavy heavy-duty engines certified as both tractor and vocational engines, measure CO<sub>2</sub> emissions using the steady-state duty cycle and the transient duty cycle (sometimes referred to as the FTP engine cycle), both of which are specified in 40 CFR part 86, subpart N. This is intended for engines that are designed for use in both tractor and vocational applications. For all other engines (including engines meeting spark-ignition standards), measure CO<sub>2</sub> emissions using the appropriate transient duty cycle specified in 40 CFR part 86, subpart N.

(i) The CO<sub>2</sub> standard is 627 g/hp-hr for all spark-ignition engines for model years 2016 through 2020. This standard continues to apply in later model years for all spark-ignition engines that are not heavy heavy-duty engines.

(ii) The following CO<sub>2</sub> standards apply for compression-ignition engines (in g/hp-hr):

Model years	Light heavy-duty	Medium heavy-duty—vocational	Heavy heavy-duty—vocational	Medium heavy-duty—tractor	Heavy heavy-duty—tractor
2014–2016 .....	600	600	567	502	475
2017–2020 .....	576	576	555	487	460

(iii) The following CO<sub>2</sub> standards apply for compression-ignition engines and all heavy heavy-duty engines (in g/hp-hr):

Model years	Light heavy-duty	Medium heavy-duty—vocational	Heavy heavy-duty—vocational	Medium heavy-duty—tractor	Heavy heavy-duty—tractor
2021–2023 .....	563	545	513	473	447
2024–2026 .....	555	538	506	461	436
2027 and later .....	552	535	503	457	432

(iv) You may certify spark-ignition engines to the compression-ignition standards for the appropriate model year under this paragraph (a). If you do this, those engines are treated as compression-ignition engines for all the provisions of this part.

(2) The CH<sub>4</sub> emission standard is 0.10 g/hp-hr when measured over the applicable transient duty cycle specified in 40 CFR part 86, subpart N. This

standard begins in model year 2014 for compression-ignition engines and in model year 2016 for spark-ignition engines. Note that this standard applies for all fuel types just like the other standards of this section.

(3) The N<sub>2</sub>O emission standard is 0.10 g/hp-hr when measured over the transient duty cycle specified in 40 CFR part 86, subpart N. This standard begins in model year 2014 for compression-

ignition engines and in model year 2016 for spark-ignition engines.

(b) *Family Certification Levels.* You must specify a CO<sub>2</sub> Family Certification Level (FCL) for each engine family. The FCL may not be less than the certified emission level for the engine family. The CO<sub>2</sub> Family Emission Limit (FEL) for the engine family is equal to the FCL multiplied by 1.03.

(c) *Averaging, banking, and trading.* You may generate or use emission credits under the averaging, banking, and trading (ABT) program described in subpart H of this part for demonstrating compliance with CO<sub>2</sub> emission standards. Credits (positive and negative) are calculated from the difference between the FCL and the applicable emission standard. As described in § 1036.705, you may use CO<sub>2</sub> credits to certify your engine families to FELs for N<sub>2</sub>O and/or CH<sub>4</sub>, instead of the N<sub>2</sub>O/CH<sub>4</sub> standards of this section that otherwise apply. Except as specified in §§ 1036.150 and 1036.705, you may not generate or use credits for N<sub>2</sub>O or CH<sub>4</sub> emissions.

(d) *Useful life.* The exhaust emission standards of this section apply for the full useful life, expressed in service miles, operating hours, or calendar years, whichever comes first. The useful life values applicable to the criteria pollutant standards of 40 CFR part 86 apply for the standards of this section, except that the spark-ignition standards and the standards for model year 2021 and later light heavy-duty compression-ignition engines apply over a useful life of 15 years or 150,000 miles, whichever comes first.

(e) *Applicability for testing.* The emission standards in this subpart apply as specified in this paragraph (e) to all duty-cycle testing (according to the applicable test cycles) of testable configurations, including certification, selective enforcement audits, and in-use testing. The CO<sub>2</sub> FCLs serve as the CO<sub>2</sub> emission standards for the engine family with respect to certification and confirmatory testing instead of the standards specified in paragraph (a)(1) of this section. The FELs serve as the emission standards for the engine family with respect to all other duty-cycle testing. See §§ 1036.235 and 1036.241 to determine which engine configurations within the engine family are subject to testing. Note that engine fuel maps and powertrain test results also serve as standards as described in § 1036.535, § 1036.540, § 1036.630 and 40 CFR 1037.550.

(f) *Multi-fuel engines.* For dual-fuel, multi-fuel, and flexible-fuel engines, perform exhaust testing on each fuel type (for example, gasoline and E85).

(1) This paragraph (f)(1) applies where you demonstrate the relative amount of each fuel type that your engines consume in actual use. Based on your demonstration, we will specify a weighting factor and allow you to submit the weighted average of your emission results. For example, if you certify an E85 flexible-fuel engine and we determine the engine will produce

one-half of its work from E85 and one-half of its work from gasoline, you may apply a 50 percent weighting factor to each of your E85 and gasoline emission results.

(2) If you certify your engine family to N<sub>2</sub>O and/or CH<sub>4</sub> FELs the FELs apply for testing on all fuel types for which your engine is designed, to the same extent as criteria emission standards apply.

#### § 1036.115 Other requirements.

(a) The warranty and maintenance requirements, adjustable parameter provisions, and defeat device prohibition of 40 CFR part 86 apply with respect to the standards of this part.

(b) You must perform fuel mapping for your engine as described in § 1036.510(b).

(c) You must design and produce your engines to comply with evaporative emission standards as follows:

(1) For complete heavy-duty vehicles you produce, you must certify the vehicles to emission standards as specified in 40 CFR 1037.103.

(2) For incomplete heavy-duty vehicles, and for engines used in vehicles you do not produce, you do not need to certify your engines to evaporative emission standards or otherwise meet those standards. However, vehicle manufacturers certifying their vehicles with your engines may depend on you to produce your engines according to their specifications. Also, your engines must meet applicable exhaust emission standards in the installed configuration.

#### § 1036.130 Installation instructions for vehicle manufacturers.

(a) If you sell an engine for someone else to install in a vehicle, give the engine installer instructions for installing it consistent with the requirements of this part. Include all information necessary to ensure that an engine will be installed in its certified configuration.

(b) Make sure these instructions have the following information:

(1) Include the heading: "Emission-related installation instructions".

(2) State: "Failing to follow these instructions when installing a certified engine in a heavy-duty motor vehicle violates federal law, subject to fines or other penalties as described in the Clean Air Act."

(3) Provide all instructions needed to properly install the exhaust system and any other components.

(4) Describe any necessary steps for installing any diagnostic system required under 40 CFR part 86.

(5) Describe how your certification is limited for any type of application. For

example, if you certify heavy heavy-duty engines to the CO<sub>2</sub> standards using only transient FTP testing, you must make clear that the engine may not be installed in tractors.

(6) Describe any other instructions to make sure the installed engine will operate according to design specifications in your application for certification. This may include, for example, instructions for installing aftertreatment devices when installing the engines.

(7) State: "If you install the engine in a way that makes the engine's emission control information label hard to read during normal engine maintenance, you must place a duplicate label on the vehicle, as described in 40 CFR 1068.105."

(c) Give the vehicle manufacturer fuel map results as described in § 1036.510(b).

(d) You do not need installation instructions for engines that you install in your own vehicles.

(e) Provide instructions in writing or in an equivalent format. For example, you may post instructions on a publicly available Web site for downloading or printing. If you do not provide the instructions in writing, explain in your application for certification how you will ensure that each installer is informed of the installation requirements.

#### § 1036.135 Labeling.

Label your engines as described in 40 CFR 86.007–35(a)(3), with the following additional information:

(a) [Reserved]

(b) Identify the emission control system. Use terms and abbreviations as described in 40 CFR 1068.45 or other applicable conventions.

(c) Identify any limitations on your certification. For example, if you certify heavy heavy-duty engines to the CO<sub>2</sub> standards using only transient cycle testing, include the statement "VOCATIONAL VEHICLES ONLY".

(d) You may ask us to approve modified labeling requirements in this part 1036 if you show that it is necessary or appropriate. We will approve your request if your alternate label is consistent with the requirements of this part. We may also specify modified labeling requirement to be consistent with the intent of 40 CFR part 1037.

#### § 1036.140 Primary intended service class and engine cycle.

You must identify a single primary intended service class for each engine family that best describes vehicles for which you design and market the engine, as follows:

(a) Divide compression-ignition engines into primary intended service classes based on the following engine and vehicle characteristics:

(1) Light heavy-duty engines usually are not designed for rebuild and do not have cylinder liners. Vehicle body types in this group might include any heavy-duty vehicle built from a light-duty truck chassis, van trucks, multi-stop vans, and some straight trucks with a single rear axle. Typical applications would include personal transportation, light-load commercial delivery, passenger service, agriculture, and construction. The GVWR of these vehicles is normally at or below 19,500 pounds.

(2) Medium heavy-duty engines may be designed for rebuild and may have cylinder liners. Vehicle body types in this group would typically include school buses, straight trucks with single rear axles, city tractors, and a variety of special purpose vehicles such as small dump trucks, and refuse trucks. Typical applications would include commercial short haul and intra-city delivery and pickup. Engines in this group are normally used in vehicles whose GVWR ranges from 19,501 to 33,000 pounds.

(3) Heavy heavy-duty engines are designed for multiple rebuilds and have cylinder liners. Vehicles in this group are normally tractors, trucks, straight trucks with dual rear axles, and buses used in inter-city, long-haul applications. These vehicles normally exceed 33,000 pounds GVWR.

(b) Divide spark-ignition engines into primary intended service classes as follows:

(1) Spark-ignition engines that are best characterized by paragraph (a)(1) or (2) of this section are in a separate "spark-ignition" primary intended service class.

(2) Spark-ignition engines that are best characterized by paragraph (a)(3) of this section share a primary intended service class with compression-ignition heavy heavy-duty engines. Gasoline-fueled engines are presumed not to be characterized by paragraph (a)(3) of this section; for example, vehicle manufacturers may install some number of gasoline-fueled engines in Class 8 trucks without causing the engine manufacturer to consider those to be heavy heavy-duty engines.

(c) References to "spark-ignition standards" in this part relate only to the spark-ignition engines identified in paragraph (b)(1) of this section. References to "compression-ignition standards" in this part relate to compression-ignition engines, to spark-ignition engines optionally certified to standards that apply to compression-

ignition engines, and to all engines identified under paragraph (b)(2) of this section as heavy heavy-duty engines.

#### **§ 1036.150 Interim provisions.**

The provisions in this section apply instead of other provisions in this part.

(a) *Early banking of greenhouse gas emissions.* You may generate CO<sub>2</sub> emission credits for engines you certify in model year 2013 (2015 for spark-ignition engines) to the standards of § 1036.108.

(1) Except as specified in paragraph (a)(2) of this section, to generate early credits, you must certify your entire U.S.-directed production volume within that averaging set to these standards. This means that you may not generate early credits while you produce engines in the averaging set that are certified to the criteria pollutant standards but not to the greenhouse gas standards. Calculate emission credits as described in subpart H of this part relative to the standard that would apply for model year 2014 (2016 for spark-ignition engines).

(2) You may generate early credits for an individual compression-ignition engine family where you demonstrate that you have improved a model year 2013 engine model's CO<sub>2</sub> emissions relative to its 2012 baseline level and certify it to an FCL below the applicable standard. Calculate emission credits as described in subpart H of this part relative to the lesser of the standard that would apply for model year 2014 engines or the baseline engine's CO<sub>2</sub> emission rate. Use the smaller U.S.-directed production volume of the 2013 engine family or the 2012 baseline engine family. We will not allow you to generate emission credits under this paragraph (a)(2) unless we determine that your 2013 engine is the same engine as the 2012 baseline or that it replaces it.

(3) You may bank credits equal to the surplus credits you generate under this paragraph (a) multiplied by 1.50. For example, if you have 10 Mg of surplus credits for model year 2013, you may bank 15 Mg of credits. Credit deficits for an averaging set prior to model year 2014 (2016 for spark-ignition engines) do not carry over to model year 2014 (2016 for spark-ignition engines). We recommend that you notify us of your intent to use this provision before submitting your applications.

(b) *Model year 2014 N<sub>2</sub>O standards.* In model year 2014 and earlier, manufacturers may show compliance with the N<sub>2</sub>O standards using an engineering analysis. This allowance also applies for later families certified

using carryover CO<sub>2</sub> data from model 2014 consistent with § 1036.235(d).

(c) *Engine cycle classification.* Through model year 2020, engines meeting the definition of spark-ignition, but regulated as diesel engines under 40 CFR part 86, must be certified to the requirements applicable to compression-ignition engines under this part. Such engines are deemed to be compression-ignition engines for purposes of this part. Similarly, through model year 2020, engines meeting the definition of compression-ignition, but regulated as Otto-cycle under 40 CFR part 86 must be certified to the requirements applicable to spark-ignition engines under this part. Such engines are deemed to be spark-ignition engines for purposes of this part. See § 1036.140 for provisions that apply for model year 2021 and later.

(d) *Small manufacturers.* The standards of this part apply on a delayed schedule for manufacturers meeting the small business criteria specified in 13 CFR 121.201. Apply the small business criteria for NAICS code 336310 for engine manufacturers with respect to gasoline-fueled engines and 333618 for engine manufacturers with respect to other engines; the employee limits apply to the total number employees together for affiliated companies. Qualifying small manufacturers are not subject to the greenhouse gas emission standards in § 1036.108 for engines with a date of manufacture on or after November 14, 2011 but before January 1, 2022. In addition, qualifying small manufacturers producing engines that run on any fuel other than gasoline, E85, or diesel fuel may delay complying with every later standard under this part by one model year. Small manufacturers may certify their engines and generate emission credits under this part 1036 before standards start to apply, but only if they certify their entire U.S.-directed production volume within that averaging set for that model year. Note that engines not yet subject to standards must nevertheless supply fuel maps to vehicle manufacturers as described in paragraph (n) of this section. Note also that engines produced by small manufacturers are subject to criteria pollutant standards.

(e) *Alternate phase-in standards.* Where a manufacturer certifies all of its model year 2013 compression-ignition engines within a given primary intended service class to the applicable alternate standards of this paragraph (e), its compression-ignition engines within that primary intended service class are subject to the standards of this paragraph (e) for model years 2013

through 2016. This means that once a manufacturer chooses to certify a primary intended service class to the

standards of this paragraph (e), it is not allowed to opt out of these standards. Engines certified to these standards are

not eligible for early credits under paragraph (a) of this section.

Tractors	LHD Engines	MHD Engines	HHD Engines
Model Years 2013–2015 .....	NA .....	512 g/hp-hr ....	485 g/hp-hr.
Model Years 2016 and later <sup>1</sup> .....	NA .....	487 g/hp-hr ....	460 g/hp-hr.
Vocational .....	LHD Engines	MHD Engines	HHD Engines
Model Years 2013–2015 .....	618 g/hp-hr ....	618 g/hp-hr ....	577 g/hp-hr.
Model Years 2016 through 2020 <sup>a</sup> .....	576 g/hp-hr ....	576 g/hp-hr ....	555 g/hp-hr.

<sup>1</sup> **Note:** these alternate standards for 2016 and later are the same as the otherwise applicable standards for 2017 through 2020.

(f) *Separate OBD families.* This paragraph (f) applies where you separately certify engines for the purpose of applying OBD requirements (for engines used in vehicles under 14,000 pounds GVWR) from non-OBD engines that could be certified as a single engine family. You may treat the two engine families as a single engine family in certain respects for the purpose of this part, as follows:

(1) This paragraph (f) applies only where the two families are identical in all respects except for the engine ratings offered and the inclusion of OBD.

(2) For purposes of this part and 40 CFR part 86, the two families remain two separate families except for the following:

(i) Specify the testable configurations of the non-OBD engine family as the testable configurations for the OBD family.

(ii) Submit the same CO<sub>2</sub>, N<sub>2</sub>O, and CH<sub>4</sub> emission data for both engine families.

(g) *Assigned deterioration factors.* You may use assigned deterioration factors (DFs) without performing your own durability emission tests or engineering analysis as follows:

(1) You may use an assigned additive DF of 0.0 g/hp-hr for CO<sub>2</sub> emissions from engines that do not use advanced or off-cycle technologies. If we determine it to be consistent with good engineering judgment, we may allow you to use an assigned additive DF of 0.0 g/hp-hr for CO<sub>2</sub> emissions from your engines with advanced or off-cycle technologies.

(2) You may use an assigned additive DF of 0.020 g/hp-hr for N<sub>2</sub>O emissions from any engine through model year 2020, and 0.010 g/hp-hr for later model years.

(3) You may use an assigned additive DF of 0.020 g/hp-hr for CH<sub>4</sub> emissions from any engine.

(h) *Advanced-technology credits.* If you generate credits from model year 2020 and earlier engines certified for advanced technology, you may multiply these credits by 1.5, except that you may not apply this multiplier and the early-credit multiplier of paragraph (a) of this section.

(i) *CO<sub>2</sub> credits for low N<sub>2</sub>O emissions.* If you certify your model year 2014, 2015, or 2016 engines to an N<sub>2</sub>O FEL less than 0.04 g/hp-hr (provided you measure N<sub>2</sub>O emissions from your emission-data engines), you may generate additional CO<sub>2</sub> credits under this paragraph (i). Calculate the additional CO<sub>2</sub> credits from the following equation instead of the equation in § 1036.705:

$$\text{CO}_2 \text{ Credits (Mg)} = (0.04 - \text{FEL}_{\text{N}_2\text{O}}) \cdot (\text{CF}) \cdot (\text{Volume}) \cdot (\text{UL}) \cdot (10^{-6}) \cdot (298)$$

(j) *Alternate standards under 40 CFR part 86.* This paragraph (j) describes alternate emission standards for loose engines certified under 40 CFR 86.1819–14(k)(8). The standards of § 1036.108 do not apply for these engines. The standards in this paragraph (j) apply for emissions measured with the engine installed in a complete vehicle consistent with the provisions of 40 CFR 86.1819–14(k)(8)(vi). The only requirements of this part that apply to these engines are those in this paragraph (j), §§ 1036.115 through 1036.135, 1036.535, and 1036.540.

(k) [Reserved]

(l) *Credit adjustment for spark-ignition engines and light heavy-duty compression-ignition engines.* For emission credits generated from model year 2020 and earlier engines subject to spark-ignition standards and light heavy-duty compression-ignition engines, multiply any banked credits that you carry forward to demonstrate compliance with model year 2021 and later standards by 1.36.

(m) *Infrequent regeneration.* For model year 2020 and earlier, you may invalidate any test interval with respect to CO<sub>2</sub> measurements if an infrequent regeneration event occurs during the test interval. Note that § 1036.530 specifies how to apply infrequent regeneration adjustment factors for later model years.

(n) *Supplying fuel maps.* Engine manufacturers not yet subject to standards under § 1036.108 in model year 2021 must supply vehicle manufacturers with fuel maps (or powertrain test results) as described in § 1036.130 for those engines.

(o) *Engines used in glider vehicles.* For purposes of recertifying a used engine for installation in a glider vehicle, we may allow you to include in an existing certified engine family those engines you modify (or otherwise demonstrate) to be identical to engines already covered by the certificate. We would base such an approval on our review of any appropriate documentation. These engines must have emission control information labels that accurately describe their status.

(p) *Transition to Phase 2 CO<sub>2</sub> standards.* If you certify all your model year 2020 engines within an averaging set to the model year 2021 FTP and SET standards and requirements, you may apply the provisions of this paragraph (p) for enhanced generation and use of emission credits. These provisions apply separately for medium heavy-duty engines and heavy heavy-duty engines.

(1) GHG emission credits you generate with model year 2018 through 2024 engines may be used through model year 2030, instead of being limited to a five-year credit life as specified in § 1036.740(d).

(2) You may certify your model year 2024 through 2026 engines to the following alternative standards:

Model years	Medium heavy-duty—vocational	Heavy heavy-duty—vocational	Medium heavy-duty—tractor	Heavy heavy-duty—tractor
2024–2026 .....	538	506	467	442

### Subpart C—Certifying Engine Families

#### § 1036.205 What must I include in my application?

Submit an application for certification as described in 40 CFR 86.007–21, with the following additional information:

(a) Describe the engine family's specifications and other basic parameters of the engine's design and emission controls with respect to compliance with the requirements of this part. Describe in detail all system components for controlling greenhouse gas emissions, including all auxiliary emission control devices (AECs) and all fuel-system components you will install on any production or test engine. Identify the part number of each component you describe. For this paragraph (a), treat as separate AECs any devices that modulate or activate differently from each other.

(b) Describe any test equipment and procedures that you used if you performed any tests that did not also involve measurement of criteria pollutants. Describe any special or alternate test procedures you used (see 40 CFR 1065.10(c)).

(c) Include the emission-related installation instructions you will provide if someone else installs your engines in their vehicles (see § 1036.130).

(d) Describe the label information specified in § 1036.135. We may require you to include a copy of the label.

(e) Identify the CO<sub>2</sub> FCLs with which you are certifying engines in the engine family; also identify any FELs that apply for CH<sub>4</sub> and N<sub>2</sub>O. The actual U.S.-directed production volume of configurations that have CO<sub>2</sub> emission rates at or below the FCL and CH<sub>4</sub> and N<sub>2</sub>O emission rates at or below the applicable standards or FELs must be at least one percent of your actual (not projected) U.S.-directed production volume for the engine family. Identify configurations within the family that have emission rates at or below the FCL and meet the one percent requirement. For example, if your U.S.-directed production volume for the engine family is 10,583 and the U.S.-directed production volume for the tested rating is 75 engines, then you can comply with this provision by setting your FCL so that one more rating with a U.S.-directed production volume of at least 31 engines meets the FCL. Where

applicable, also identify other testable configurations required under

§ 1036.230(b)(2).

(f) Identify the engine family's deterioration factors and describe how you developed them (see § 1036.241). Present any test data you used for this.

(g) Present emission data to show that you meet emission standards, as follows:

(1) Present exhaust emission data for CO<sub>2</sub>, CH<sub>4</sub>, and N<sub>2</sub>O on an emission-data engine to show that your engines meet the applicable emission standards we specify in § 1036.108. Show emission figures before and after applying deterioration factors for each engine. In addition to the composite results, show individual measurements for cold-start testing and hot-start testing over the transient test cycle. For each of these tests, also include the corresponding exhaust emission data for criteria emissions. Note that § 1036.235 allows you to submit an application in certain cases without new emission data.

(2) [Reserved]

(h) State whether your certification is limited for certain engines. For example, if you certify heavy heavy-duty engines to the CO<sub>2</sub> standards using only transient testing, the engines may be installed only in vocational vehicles.

(i) Unconditionally certify that all the engines in the engine family comply with the requirements of this part, other referenced parts of the CFR, and the Clean Air Act. Note that § 1036.235 specifies which engines to test to show that engines in the entire family comply with the requirements of this part.

(j) Include the information required by other subparts of this part. For example, include the information required by § 1036.725 if you participate in the ABT program.

(k) Include the warranty statement and maintenance instructions if we request them.

(l) Include other applicable information, such as information specified in this part or 40 CFR part 1068 related to requests for exemptions.

(m) For imported engines or equipment, identify the following:

(1) Describe your normal practice for importing engines. For example, this may include identifying the names and addresses of any agents you have authorized to import your engines. Engines imported by nonauthorized

agents are not covered by your certificate.

(2) The location of a test facility in the United States where you can test your engines if we select them for testing under a selective enforcement audit, as specified in 40 CFR part 1068, subpart E.

(n) Include information needed to certify vehicles to GHG standards under 40 CFR part 1037 as described in § 1036.510.

#### § 1036.210 Preliminary approval before certification.

If you send us information before you finish the application, we may review it and make any appropriate determinations, especially for questions related to engine family definitions, auxiliary emission control devices, adjustable parameters, deterioration factors, testing for service accumulation, and maintenance. Decisions made under this section are considered to be preliminary approval, subject to final review and approval. We will generally not reverse a decision where we have given you preliminary approval, unless we find new information supporting a different decision. If you request preliminary approval related to the upcoming model year or the model year after that, we will make best-efforts to make the appropriate determinations as soon as practicable. We will generally not provide preliminary approval related to a future model year more than two years ahead of time.

#### § 1036.225 Amending my application for certification.

Before we issue you a certificate of conformity, you may amend your application to include new or modified engine configurations, subject to the provisions of this section. After we have issued your certificate of conformity, you may send us an amended application requesting that we include new or modified engine configurations within the scope of the certificate, subject to the provisions of this section. You must also amend your application if any changes occur with respect to any information that is included or should be included in your application.

(a) You must amend your application before you take any of the following actions:

(1) Add an engine configuration to an engine family. In this case, the engine



configuration added must be consistent with other engine configurations in the engine family with respect to the criteria listed in § 1036.230.

(2) Change an engine configuration already included in an engine family in a way that may affect emissions, or change any of the components you described in your application for certification. This includes production and design changes that may affect emissions any time during the engine's lifetime.

(3) Modify an FEL and FCL for an engine family as described in paragraph (f) of this section.

(b) To amend your application for certification, send the relevant information to the Designated Compliance Officer.

(1) Describe in detail the addition or change in the engine model or configuration you intend to make.

(2) Include engineering evaluations or data showing that the amended engine family complies with all applicable requirements. You may do this by showing that the original emission-data engine is still appropriate for showing that the amended family complies with all applicable requirements.

(3) If the original emission-data engine for the engine family is not appropriate to show compliance for the new or modified engine configuration, include new test data showing that the new or modified engine configuration meets the requirements of this part.

(4) Include any other information needed to make your application correct and complete.

(c) We may ask for more test data or engineering evaluations. You must give us these within 30 days after we request them.

(d) For engine families already covered by a certificate of conformity, we will determine whether the existing certificate of conformity covers your newly added or modified engine. You may ask for a hearing if we deny your request (see § 1036.820).

(e) For engine families already covered by a certificate of conformity, you may start producing the new or modified engine configuration any time after you send us your amended application and before we make a decision under paragraph (d) of this section. However, if we determine that the affected engines do not meet applicable requirements, we will notify you to cease production of the engines and may require you to recall the engines at no expense to the owner.

Choosing to produce engines under this paragraph (e) is deemed to be consent to recall all engines that we determine do not meet applicable emission standards

or other requirements and to remedy the nonconformity at no expense to the owner. If you do not provide information required under paragraph (c) of this section within 30 days after we request it, you must stop producing the new or modified engines.

(f) You may ask us to approve a change to your FEL in certain cases after the start of production, but before the end of the model year. If you change an FEL for CO<sub>2</sub>, your FCL for CO<sub>2</sub> is automatically set to your new FEL divided by 1.03. The changed FEL may not apply to engines you have already introduced into U.S. commerce, except as described in this paragraph (f). You may ask us to approve a change to your FEL in the following cases:

(1) You may ask to raise your FEL for your engine family at any time. In your request, you must show that you will still be able to meet the emission standards as specified in subparts B and H of this part. Use the appropriate FELs/FCLs with corresponding production volumes to calculate emission credits for the model year, as described in subpart H of this part.

(2) You may ask to lower the FEL for your engine family only if you have test data from production engines showing that emissions are below the proposed lower FEL (or below the proposed FCL for CO<sub>2</sub>). The lower FEL/FCL applies only to engines you produce after we approve the new FEL/FCL. Use the appropriate FELs/FCLs with corresponding production volumes to calculate emission credits for the model year, as described in subpart H of this part.

(g) You may produce engines as described in your amended application for certification and consider those engines to be in a certified configuration if we approve a new or modified engine configuration during the model year under paragraph (d) of this section. Similarly, you may modify in-use engines as described in your amended application for certification and consider those engines to be in a certified configuration if we approve a new or modified engine configuration at any time under paragraph (d) of this section. Modifying a new or in-use engine to be in a certified configuration does not violate the tampering prohibition of 40 CFR 1068.101(b)(1), as long as this does not involve changing to a certified configuration with a higher family emission limit.

#### **§ 1036.230 Selecting engine families.**

See 40 CFR 86.001–24 for instructions on how to divide your product line into families of engines that are expected to have similar emission characteristics

throughout the useful life. You must certify your engines to the standards of § 1036.108 using the same engine families you use for criteria pollutants under 40 CFR part 86. The following provisions also apply:

(a) Engines certified as hybrid engines may not be included in an engine family with engines with conventional powertrains. Note that this does not prevent you from including engines in a conventional family if they are used in hybrid vehicles, as long as you certify them conventionally.

(b) If you certify engines in the family for use as both vocational and tractor engines, you must split your family into two separate subfamilies. Indicate in the application for certification that the engine family is to be split.

(1) Calculate emission credits relative to the vocational engine standard for the number of engines sold into vocational applications and relative to the tractor engine standard for the number of engines sold into non-vocational tractor applications. You may assign the numbers and configurations of engines within the respective subfamilies at any time before submitting the end-of-year report required by § 1036.730. If the family participates in averaging, banking, or trading, you must identify the type of vehicle in which each engine is installed; we may alternatively allow you to use statistical methods to determine this for a fraction of your engines. Keep records to document this determination.

(2) If you restrict use of the test configuration for your split family to only tractors, or only vocational vehicles, you must identify a second testable configuration for the other type of vehicle (or an unrestricted configuration). Identify this configuration in your application for certification. The FCL for the engine family applies for this configuration as well as the primary test configuration.

(c) If you certify in separate engine families engines that could have been certified in vocational and tractor engine subfamilies in the same engine family, count the two families as one family for purposes of determining your obligations with respect to the OBD requirements and in-use testing requirements of 40 CFR part 86. Indicate in the applications for certification that the two engine families are covered by this paragraph (c).

(d) Engine configurations within an engine family must use equivalent greenhouse gas emission controls. Unless we approve it, you may not produce nontested configurations without the same emission control hardware included on the tested

configuration. We will only approve it if you demonstrate that the exclusion of the hardware does not increase greenhouse gas emissions.

(e) If you certify both engine fuel maps and powertrain fuel maps for an engine family, you may split the engine family into two separate subfamilies. Indicate this in your application for certification, and identify whether one or both of these sets of fuel maps applies for each group of engines. If you do not split your family, all engines within the family must conform to the engine fuel maps, including any engines for which the powertrain maps also apply.

#### **§ 1036.235 Testing requirements for certification.**

This section describes the emission testing you must perform to show compliance with the greenhouse gas emission standards in § 1036.108.

(a) Select a single emission-data engine from each engine family as specified in 40 CFR part 86. The standards of this part apply only with respect to emissions measured from this tested configuration and other configurations identified in § 1036.205(e). Note that configurations identified in § 1036.205(e) are considered to be “tested configurations”. Whether or not you actually tested them for certification. However, you must apply the same (or equivalent) emission controls to all other engine configurations in the engine family. In other contexts, the tested configuration is sometimes referred to as the “parent configuration”, although the terms are not synonymous.

(b) Test your emission-data engines using the procedures and equipment specified in subpart F of this part. In the case of dual-fuel and flexible-fuel engines, measure emissions when operating with each type of fuel for which you intend to certify the engine. (Note: measurement of criteria emissions from flexible-fuel engines generally involves operation with the fuel mixture that best represents in-use operation, or with the fuel mixture with the highest emissions.) Measure CO<sub>2</sub>, CH<sub>4</sub>, and N<sub>2</sub>O emissions using the specified duty cycle(s), including cold-start and hot-start testing as specified in 40 CFR part 86, subpart N. The following provisions apply regarding test cycles for demonstrating compliance with tractor and vocational standards:

(1) If you are certifying the engine for use in tractors, you must measure CO<sub>2</sub> emissions using the applicable ramped-modal cycle specified in § 1036.505, and

measure CH<sub>4</sub>, and N<sub>2</sub>O emissions using the specified transient cycle.

(2) If you are certifying the engine for use in vocational applications, you must measure CO<sub>2</sub>, CH<sub>4</sub>, and N<sub>2</sub>O emissions using the specified transient duty cycle, including cold-start and hot-start testing as specified in 40 CFR part 86, subpart N.

(3) You may certify your engine family for both tractor and vocational use by submitting CO<sub>2</sub> emission data from both ramped-modal and transient cycle testing and specifying FCLs for both.

(4) Some of your engines certified for use in tractors may also be used in vocational vehicles, and some of your engines certified for use in vocational may be used in tractors. However, you may not knowingly circumvent the intent of this part (to reduce in-use emissions of CO<sub>2</sub>) by certifying engines designed for tractors or vocational vehicles (and rarely used in the other application) to the wrong cycle. For example, we would generally not allow you to certify all your engines to the ramped-modal cycle without certifying any to the transient cycle.

(c) We may perform confirmatory testing by measuring emissions from any of your emission-data engines. If your certification includes powertrain testing as specified in 40 CFR 1036.630, this paragraph (c) also applies for the powertrain test results.

(1) We may decide to do the testing at your plant or any other facility. If we do this, you must deliver the engine to a test facility we designate. The engine you provide must include appropriate manifolds, aftertreatment devices, electronic control units, and other emission-related components not normally attached directly to the engine block. If we do the testing at your plant, you must schedule it as soon as possible and make available the instruments, personnel, and equipment we need.

(2) If we measure emissions on your engine, the results of that testing become the official emission results for the engine as specified in this paragraph (c). Unless we later invalidate these data, we may decide not to consider your data in determining if your engine family meets applicable requirements.

(3) Before we test one of your engines, we may set its adjustable parameters to any point within the physically adjustable ranges.

(4) Before we test one of your engines, we may calibrate it within normal production tolerances for anything we do not consider an adjustable parameter. For example, this would apply for an engine parameter that is subject to production variability because it is

adjustable during production, but is not considered an adjustable parameter (as defined in § 1036.801) because it is permanently sealed. For parameters that relate to a level of performance that is itself subject to a specified range (such as maximum power output), we will generally perform any calibration under this paragraph (c)(4) in a way that keeps performance within the specified range.

(5) We may use our emission test results for steady-state, idle, cycle-average and powertrain fuel maps, as long as we perform at least three valid tests. We will use mean values for each point to specify our fuel maps and may use the resulting fuel maps as the official emission results. We may also consider how the different fuel maps affect GEM emission results as part of our decision. We will not replace individual points from your fuel map, but we may make separate determinations for steady-state, idle, cycle-average and powertrain fuel maps.

(6) If you supply cycle-average engine fuel maps for the highway cruise cycles instead of generating a steady-state fuel map for these cycles, we may perform a confirmatory test of your engine fuel maps for the highway cruise cycles by either of the following methods:

(i) Directly measuring the highway cruise cycle-average fuel maps.

(ii) Measuring a steady-state fuel map as described in paragraph (c)(5) of this section and using it in GEM to create our own cycle-average engine fuel maps for the highway cruise cycles.

(d) You may ask to use carryover emission data from a previous model year instead of doing new tests, but only if all the following are true:

(1) The engine family from the previous model year differs from the current engine family only with respect to model year, items identified in § 1036.225(a), or other characteristics unrelated to emissions. We may waive this criterion for differences we determine not to be relevant.

(2) The emission-data engine from the previous model year remains the appropriate emission-data engine under paragraph (b) of this section.

(3) The data show that the emission-data engine would meet all the requirements that apply to the engine family covered by the application for certification.

(e) We may require you to test a second engine of the same configuration in addition to the engine tested under paragraph (a) of this section.

(f) If you use an alternate test procedure under 40 CFR 1065.10 and later testing shows that such testing does not produce results that are equivalent to the procedures specified

in subpart F of this part, we may reject data you generated using the alternate procedure.

**§ 1036.241 Demonstrating compliance with greenhouse gas emission standards.**

(a) For purposes of certification, your engine family is considered in compliance with the emission standards in § 1036.108 if all emission-data engines representing the tested configuration of that engine family have test results showing official emission results and deteriorated emission levels at or below the standards. Note that your FCLs are considered to be the applicable emission standards with which you must comply for certification.

(b) Your engine family is deemed not to comply if any emission-data engine representing the tested configuration of that engine family has test results showing an official emission result or a deteriorated emission level for any pollutant that is above an applicable emission standard (generally the FCL). Note that you may increase your FCL if any certification test results exceed your initial FCL.

(c) Apply deterioration factors to the measured emission levels for each pollutant to show compliance with the applicable emission standards. Your deterioration factors must take into account any available data from in-use testing with similar engines. Apply deterioration factors as follows:

(1) *Additive deterioration factor for greenhouse gas emissions.* Except as specified in paragraphs (c)(2) and (3) of this section, use an additive deterioration factor for exhaust emissions. An additive deterioration factor is the difference between the highest exhaust emissions (typically at the end of the useful life) and exhaust emissions at the low-hour test point. In these cases, adjust the official emission results for each tested engine at the selected test point by adding the factor to the measured emissions. If the factor is less than zero, use zero. Additive deterioration factors must be specified to one more decimal place than the applicable standard.

(2) *Multiplicative deterioration factor for greenhouse gas emissions.* Use a multiplicative deterioration factor for a pollutant if good engineering judgment calls for the deterioration factor for that pollutant to be the ratio of the highest exhaust emissions (typically at the end of the useful life) to exhaust emissions at the low-hour test point. Adjust the official emission results for each tested engine at the selected test point by multiplying the measured emissions by the deterioration factor. If the factor is

less than one, use one. A multiplicative deterioration factor may not be appropriate in cases where testing variability is significantly greater than engine-to-engine variability. Multiplicative deterioration factors must be specified to one more significant figure than the applicable standard.

(3) *Sawtooth and other nonlinear deterioration patterns.* The deterioration factors described in paragraphs (c)(1) and (2) of this section assume that the highest useful life emissions occur either at the end of useful life or at the low-hour test point. The provisions of this paragraph (c)(3) apply where good engineering judgment indicates that the highest useful life emissions will occur between these two points. For example, emissions may increase with service accumulation until a certain maintenance step is performed, then return to the low-hour emission levels and begin increasing again. Such a pattern may occur with battery-based electric hybrid engines. Base deterioration factors for engines with such emission patterns on the difference between (or ratio of) the point at which the highest emissions occur and the low-hour test point. Note that this applies for maintenance-related deterioration only where we allow such critical emission-related maintenance.

(4) [Reserved]

(5) *Dual-fuel and flexible-fuel engines.* In the case of dual-fuel and flexible-fuel engines, apply deterioration factors separately for each fuel type by measuring emissions with each fuel type at each test point. You may accumulate service hours on a single emission-data engine using the type of fuel or the fuel mixture expected to have the highest combustion and exhaust temperatures; you may ask us to approve a different fuel mixture if you demonstrate that a different criterion is more appropriate.

(d) Calculate emission data using measurements to at least one more decimal place than the applicable standard. Apply the deterioration factor to the official emission result, as described in paragraph (c) of this section, then round the adjusted figure to the same number of decimal places as the emission standard. Compare the rounded emission levels to the emission standard for each emission-data engine.

(e) If you identify more than one configuration in § 1036.205(e), we may test (or require you to test) any of the identified configurations. We may also require you to provide an engineering analysis that demonstrates that untested configurations listed in § 1036.205(e) comply with their FCL.

**§ 1036.250 Reporting and recordkeeping for certification.**

(a) Within 90 days after the end of the model year, send the Designated Compliance Officer a report including the total U.S.-directed production volume of engines you produced in each engine family during the model year (based on information available at the time of the report). Report the production by serial number and engine configuration. Small manufacturers may omit this requirement. You may combine this report with reports required under subpart H of this part.

(b) Organize and maintain the following records:

(1) A copy of all applications and any summary information you send us.

(2) Any of the information we specify in § 1036.205 that you were not required to include in your application.

(c) Keep routine data from emission tests required by this part (such as test cell temperatures and relative humidity readings) for one year after we issue the associated certificate of conformity. Keep all other information specified in this section for eight years after we issue your certificate.

(d) Store these records in any format and on any media, as long as you can promptly send us organized, written records in English if we ask for them. You must keep these records readily available. We may review them at any time.

**§ 1036.255 What decisions may EPA make regarding my certificate of conformity?**

(a) If we determine your application is complete and shows that the engine family meets all the requirements of this part and the Act, we will issue a certificate of conformity for your engine family for that model year. We may make the approval subject to additional conditions.

(b) We may deny your application for certification if we determine that your engine family fails to comply with emission standards or other requirements of this part or the Clean Air Act. We will base our decision on all available information. If we deny your application, we will explain why in writing.

(c) In addition, we may deny your application or suspend or revoke your certificate if you do any of the following:

(1) Refuse to comply with any testing or reporting requirements.

(2) Submit false or incomplete information (paragraph (e) of this section applies if this is fraudulent). This includes doing anything after submission of your application to

render any of the submitted information false or incomplete.

(3) Render inaccurate any test data.

(4) Deny us from completing authorized activities (see 40 CFR 1068.20). This includes a failure to provide reasonable assistance.

(5) Produce engines for importation into the United States at a location where local law prohibits us from carrying out authorized activities.

(6) Fail to supply requested information or amend your application to include all engines being produced.

(7) Take any action that otherwise circumvents the intent of the Act or this part, with respect to your engine family.

(d) We may void the certificate of conformity for an engine family if you fail to keep records, send reports, or give us information as required under this part or the Act. Note that these are also violations of 40 CFR 1068.101(a)(2).

(e) We may void your certificate if we find that you intentionally submitted false or incomplete information. This includes rendering submitted information false or incomplete after submission.

(f) If we deny your application or suspend, revoke, or void your certificate, you may ask for a hearing (see § 1036.820).

**Subpart D—Testing Production Engines**

**§ 1036.301 Measurements related to GEM inputs in a selective enforcement audit.**

(a) Selective enforcement audits apply for engines as specified in 40 CFR part 1068, subpart E. This section describes how this applies uniquely in certain circumstances.

(b) Selective enforcement audit provisions apply with respect to your fuel maps as follows:

(1) A selective enforcement audit for an engine with respect to fuel maps would consist of performing measurements with production engines to determine fuel-consumption rates as declared for GEM simulations, and running GEM for the vehicle configurations specified in paragraph (b)(2) of this section based on those measured values. The engine is

considered passing for a given configuration if the new modeled emission result for each applicable duty cycle is at or below the modeled emission result corresponding to the declared GEM inputs. The engine is considered failing for a given configuration if the new modeled emission result for any applicable duty cycle is above the modeled emission result corresponding to the declared GEM inputs.

(2) Evaluate cycle-average fuel maps by running GEM based on simulated vehicle configurations representing the interpolated center of every group of four test points that define a boundary of cycle work and average engine speed divided by average vehicle speed. These simulated vehicle configurations are defined from the four surrounding points based on averaging values for vehicle mass, drag area (if applicable), tire rolling resistance, tire size, and axle ratio. The regulatory subcategory is defined by the regulatory subcategory of the vehicle configuration with the greatest mass from those four test points. Figure 1 of this section illustrates a determination of vehicle configurations for engines used in tractors and Vocational HDV using a fixed tire size (see § 1036.540(c)(3)(iii)). The vehicle configuration from the upper-left quadrant is defined by values for Tests 1, 2, 4, and 5 from Table 3 of § 1036.540. Calculate vehicle mass as the average of the values from the four tests. Determine the weight reduction needed for GEM to simulate this calculated vehicle mass by comparing the average vehicle mass to the default vehicle mass for the vehicle subcategory from the four points that has the greatest mass, with the understanding that two-thirds of weight reduction for tractors is applied to vehicle weight and one-third is understood to represent increased payload. This is expressed mathematically as  $M_{avg} = M_{subcategory} - \frac{2}{3} \cdot M_{reduction}$ , which can be solved for  $M_{reduction}$ . For vocational vehicles, half of weight reduction is applied to vehicle weight and half is understood to represent increased payload. Use the following values for default vehicle masses by vehicle subcategory:

TABLE 1 OF § 1036.301—DEFAULT VEHICLE MASS BY VEHICLE SUB-CATEGORY

Vehicle subcategory	Default vehicle mass (kg)
Vocational Light HDV .....	7,257
Vocational Medium HDV .....	11,408
Class 7 Mid-Roof Day Cab ..	20,910
Class 8 Mid-Roof Day Cab ..	29,529
Class 8 High-Roof Sleeper Cab .....	31,978
Heavy-Haul Tractor .....	53,750

(3) This paragraph (b)(3) provides an example to illustrate how to determine GEM input values for the four vehicle configurations identified in paragraph (b)(2) of this section. If axle ratio is 2.5 for Tests 1 and 2, and 3.5 for Tests 4 and 5, the average value is 3.0. A tire size of 500 revolutions per mile would apply for all four tests, so the average tire size would be that same value. Similarly,  $C_{rr}$  is 6.9 kg/tonne since that value applies for all four points. The calculated average value of  $C_dA$  is 6.9 m<sup>2</sup>. The calculated average vehicle mass is 28,746.5 kg. Weight reduction is 4,847 kg or 10,686 pounds ( $\frac{3}{2} \cdot (31,978 - 28,746.5)$ ).

(4) Because your cycle-average map may have more or fewer test points, you may have more than or fewer than the number of audit points shown in Figure 1 of this section. If the audit includes fuel-map testing in conjunction with engine testing relative to exhaust emission standards, the fuel-map simulations for the whole set of vehicles and duty cycles counts as a single test result for purposes of evaluating whether the engine family meets the pass-fail criteria under 40 CFR 1068.420. If the audit includes only fuel-map testing, determine emission results from at least three different engine configurations simulated with each applicable vehicle configuration identified in § 1036.540; the fuel-map simulation for each vehicle configuration counts as a separate test for the engine.

Figure 1 of § 1036.301 – Sample of SEA Test Points

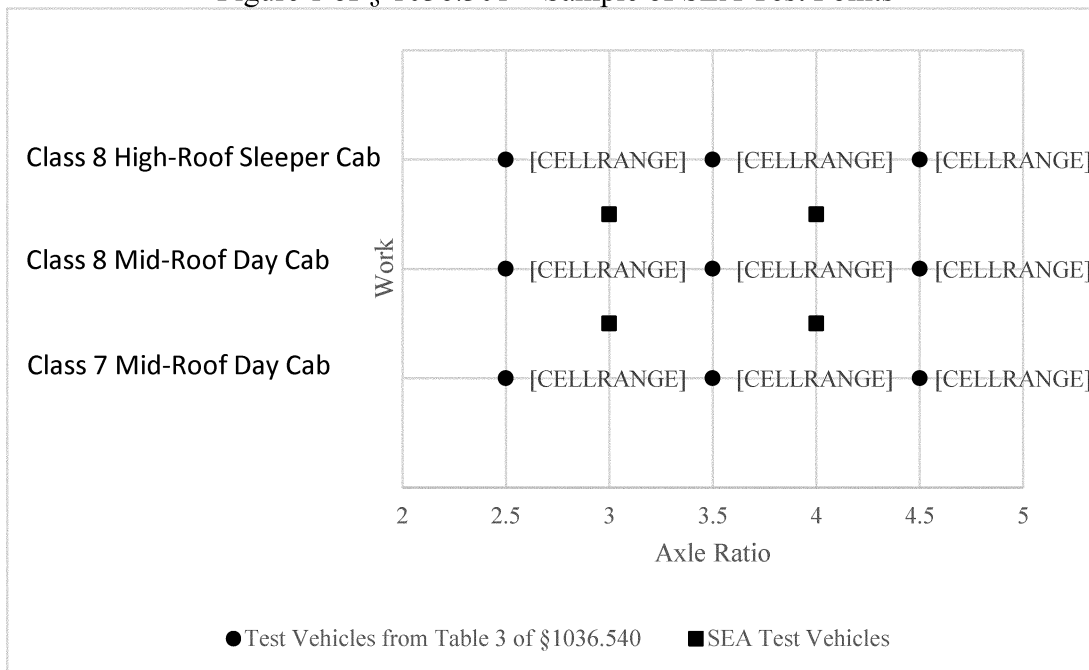

(c) If your certification includes powertrain testing as specified in 40 CFR 1036.630, these selective enforcement audit provisions apply with respect to powertrain test results as specified in 40 CFR part 1037, subpart D, and 40 CFR 1037.550. We may allow manufacturers to instead perform the engine-based testing to simulate the powertrain test as specified in 40 CFR 1037.551.

(d) We may suspend or revoke certificates for any appropriate configurations within one or more engine families based on the outcome of a selective enforcement audit.

#### Subpart E—In-Use Testing

##### § 1036.401 In-use testing.

We may perform in-use testing of any engine family subject to the standards of this part, consistent with the Clean Air Act and the provisions of § 1036.235. Note that this provision does not affect your obligation to test your in-use engines as described in 40 CFR part 86, subpart T.

#### Subpart F—Test Procedures

##### § 1036.501 How do I run a valid emission test?

(a) Use the equipment and procedures specified in this subpart and 40 CFR 86.1305 to determine whether engines

meet the emission standards in § 1036.108.

(b) You may use special or alternate procedures to the extent we allow them under 40 CFR 1065.10.

(c) This subpart is addressed to you as a manufacturer, but it applies equally to anyone who does testing for you, and to us when we perform testing to determine if your engines meet emission standards.

(d) For engines that use aftertreatment technology with infrequent regeneration events, apply infrequent regeneration adjustment factors as described in § 1036.530.

(e) Test hybrid engines as described in § 1036.525 and 40 CFR part 1065.

(f) Determine engine fuel maps as described in § 1036.510(b).

(g) The following additional provisions apply for testing to demonstrate compliance with the emission standards in § 1036.108 for model year 2021 and later engines:

(1) If your engine is intended for installation in a vehicle equipped with stop-start technology, you may use good engineering judgment to turn the engine off during the idle portions of the duty cycle to represent in-use operation, consistent with good engineering judgment.

(2) Use one of the following methods to measure CO<sub>2</sub> emissions:

(i) Use the ramped-modal cycle specified in § 1036.505 using either continuous or batch sampling.

(ii) Measure CO<sub>2</sub> emissions over the ramped-modal cycle specified in 40 CFR 86.1362 using continuous sampling. Integrate the test results by mode to establish separate emission rates for each mode (including the transition following each mode, as applicable). Apply the weighting factors specified in 40 CFR 86.1362 to calculate a composite emission result.

(3) Measure or calculate emissions of criteria pollutants corresponding to your measurements to demonstrate compliance with CO<sub>2</sub> standards. These test results are not subject to the duty-cycle standards of 40 CFR part 86, subpart A.

##### § 1036.505 Ramped-modal testing procedures.

(a) Starting in model year 2021, you must measure CO<sub>2</sub> emissions using the ramped-modal cycle in 40 CFR 86.1362 as described in § 1036.501, or using the ramped-modal cycle in this section.

(b) Measure emissions using the ramped-modal duty cycle shown in the following table to determine whether engines meet the steady-state compression-ignition standards specified in subpart B of this part:

TABLE 1 OF § 1036.505—RAMPED-MODAL DUTY CYCLE

RMC mode	Time in mode (seconds)	Engine speed <sup>1 2</sup>	Torque (percent) <sup>2 3</sup>
1a Steady-state .....	124	Warm Idle .....	0.
1b Transition .....	20	Linear Transition .....	Linear Transition.
2a Steady-state .....	196	A .....	100.
2b Transition .....	20	Linear Transition .....	Linear Transition.
3a Steady-state .....	220	B .....	50.
3b Transition .....	20	B .....	Linear Transition.
4a Steady-state .....	220	B .....	75.
4b Transition .....	20	Linear Transition .....	Linear Transition.
5a Steady-state .....	268	A .....	50.
5b Transition .....	20	A .....	Linear Transition.
6a Steady-state .....	268	A .....	75.
6b Transition .....	20	A .....	Linear Transition.
7a Steady-state .....	268	A .....	25.
7b Transition .....	20	Linear Transition .....	Linear Transition.
8a Steady-state .....	196	B .....	100.
8b Transition .....	20	B .....	Linear Transition.
9a Steady-state .....	196	B .....	25.
9b Transition .....	20	Linear Transition .....	Linear Transition.
10a Steady-state .....	28	C .....	100.
10b Transition .....	20	C .....	Linear Transition.
11a Steady-state .....	4	C .....	25.
11b Transition .....	20	C .....	Linear Transition.
12a Steady-state .....	4	C .....	75.
12b Transition .....	20	C .....	Linear Transition.
13a Steady-state .....	4	C .....	50.
13b Transition .....	20	Linear Transition .....	Linear Transition.
14 Steady-state .....	144	Warm Idle .....	0.

<sup>1</sup> Speed terms are defined in 40 CFR part 1065.

<sup>2</sup> Advance from one mode to the next within a 20 second transition phase. During the transition phase, command a linear progression from the speed or torque setting of the current mode to the speed or torque setting of the next mode.

<sup>3</sup> The percent torque is relative to maximum torque at the commanded engine speed.

**§ 1036.510 Engine data and information for vehicle certification.**

You must give vehicle manufacturers information as follows so they can certify model year 2021 and later vehicles:

(a) Identify engine make, model, fuel type, engine family name, calibration identification, and engine displacement. Also identify which standards the engines meet.

(b) This paragraph (b) describes three different methods to generate engine fuel maps. Manufacturers may generally rely on any of the three mapping methods. However, manufacturers must generate fuel maps using either cycle-average or powertrain testing as described in paragraphs (b)(2) and (3) of this section for hybrid engines and hybrid vehicles. Also, vehicle manufacturers must use the powertrain method for any vehicle with a transmission that is not automatic, automated manual, manual, or dual-clutch.

(1) *Combined steady-state and cycle-average.* Determine steady-state engine fuel maps and fuel consumption at idle as described in § 1036.535, and determine cycle-average engine fuel maps as described in § 1036.540, excluding cycle-average fuel maps for highway cruise cycles.

(2) *Cycle-average.* Determine fuel consumption at idle as described in § 1036.535, and determine cycle-average engine fuel maps as described in § 1036.540, including cycle-average engine fuel maps for highway cruise cycles. In this case, you do not need to determine steady-state engine fuel maps under § 1036.535. Fuel mapping for highway cruise cycles using cycle-average testing is an alternate method, which means that we may do confirmatory testing based on steady-state fuel mapping for highway cruise cycles even if you do not; however, we will use the steady-state fuel maps to create cycle-average fuel maps. In § 1036.540 we define the vehicle configurations for testing; we may add more vehicle configurations to better represent your engine's operation for the range of vehicles in which your engines will be installed (see 40 1065.10(c)(1)).

(3) *Powertrain.* Generate a powertrain fuel map as described in 40 CFR 1037.550. In this case, you do not need to perform fuel mapping under § 1036.535 or § 1036.540.

(d) Provide the following information if you generate engine fuel maps using either paragraph (b)(1) or (2) of this section:

(1) Full-load torque curve for installed engines, and the full-load torque curve

of the engine with the highest fueling rate that shares the same engine hardware, including the turbocharger, as described in 40 CFR 1065.510. You may use 40 CFR 1065.510(b)(5)(i) for engines subject to spark-ignition standards. Measure the torque curve for hybrid engines as described in 40 CFR 1065.510(g) with the hybrid system active.

(2) Motoring torque map as described in 40 CFR 1065.510(c)(2) and (4) for conventional and hybrid engines, respectively.

(3) Declared engine idle speed. For vehicles with manual transmissions, this is the engine speed with the transmission in neutral. For all other vehicles, this is the engine's idle speed when the transmission is in drive.

**§ 1036.525 Hybrid engines.**

(a) If your engine system includes features that recover and store energy during engine motoring operation, test the engine as described in paragraph (d) of this section. For purposes of this section, features that recover energy between the engine and transmission are considered related to engine motoring.

(b) If you produce a hybrid engine designed with power take-off capability and sell the engine coupled with a

transmission, you may calculate a reduction in CO<sub>2</sub> emissions resulting from the power take-off operation as described in 40 CFR 1037.540. Quantify the CO<sub>2</sub> reduction for your engines using the vehicle-based procedures, consistent with good engineering judgment.

(c) For engines that include electric hybrid systems, test the engine with the hybrid electric motor, the rechargeable energy storage system (RESS), and the power electronics between the hybrid electric motor and the RESS. You may ask us to modify the provisions of this section for testing engines with other kinds of hybrid systems.

(d) Measure emissions using the same procedures that apply for testing non-hybrid engines under this part, except as specified in this part and 40 CFR part 1065. For ramped-modal testing, deactivate the hybrid features unless we specify otherwise. The following provisions apply for testing hybrid engines:

(1) *Engine mapping.* Map the engine as specified in 40 CFR 1065.510. This requires separate torque maps for the engine with and without the hybrid features active. For transient testing, denormalize the duty cycle using the map generated with the hybrid feature active. For steady-state testing, denormalize the duty cycle using the map generated without the hybrid feature.

(2) *Engine shutdown during testing.* If you will configure production engines to shut down automatically during idle operation, you may let the engine shut down during the idle portions of the duty cycle.

(3) *Work calculation.* Calculate positive and negative work done over the cycle according to 40 CFR 1065.650(d), except that you must set power to zero to calculate negative work done for any period over the cycle where the engine produces net positive power or where the negative power is solely from the engine and not the hybrid system.

(4) *Limits on braking energy.* Calculate brake energy fraction,  $x_b$ , as follows:

(i) Calculate  $x_b$  as the integrated negative work over the cycle divided by the integrated positive work over the cycle according to Eq. 1036.525-1. Calculate the brake energy limit for the engine,  $x_{bl}$ , according to Eq. 1036.525-2. If  $x_b$  is less than or equal to  $x_{bl}$ , use the integrated positive work for your emission calculations. If  $x_b$  is greater than  $x_{bl}$  use Eq. 1036.525-3 to calculate an adjusted value for cycle work,  $W_{cycle}$ , and use  $W_{cycle}$  as the work value for calculating emission results. You may set an instantaneous brake target that

will prevent  $x_b$  from being larger than  $x_{bl}$  to avoid the need to subtract extra brake work from positive work.

$$x_b = \left| \frac{W_{neg}}{W_{pos}} \right|$$

Eq. 1036.525-1

Where:

$W_{neg}$  = the negative work over the cycle.

$W_{pos}$  = the positive work over the cycle.

$$x_{bl} = 4.158 \cdot 10^{-4} \cdot P_{max} + 0.2247$$

Eq. 1036.525-2

Where:

$P_{max}$  = the maximum power of the engine with the hybrid system engaged.

$$W_{cycle} = W_{pos} - \left( \left| W_{neg} \right| - x_{bl} \cdot W_{pos} \right)$$

Eq. 1036.525-3

Where:

$W_{cycle}$  = cycle work when  $x_b$  is greater than  $x_{bl}$ .

*Example:*

$W_{neg}$  = 4.69 kW-hr

$W_{pos}$  = 14.67 kW-hr

$P_{max}$  = 223 kW

$$x_b = \left| \frac{1.69}{14.67} \right| = 0.320 \text{ kW}$$

$x_{bl} = 4.158 \cdot 10^{-4} \cdot 223 + 0.2247 = 0.317 \text{ kW}$

since  $x_b > x_{bl}$ ;

$W_{cycle} = 14.67 - (|4.59| - 0.317 \cdot 14.67) = 14.63 \text{ kW-hr}$

(ii) Convert from g/kW-hr to g/hp-hr as the final step in calculating emission results.

(5) *State of charge.* Correct for the net energy change of the energy storage device as described in 40 CFR 1066.501.

#### § 1036.530 Calculating greenhouse gas emission rates.

This section describes how to calculate official emission results for CO<sub>2</sub>, CH<sub>4</sub>, and N<sub>2</sub>O.

(a) Calculate brake-specific emission rates for each applicable duty cycle as specified in 40 CFR 1065.650. Apply infrequent regeneration adjustment factors to your cycle-average results as described in 40 CFR 86.004-28 for CO<sub>2</sub> starting in model year 2021. You may optionally apply infrequent regeneration adjustment factors for CH<sub>4</sub> and N<sub>2</sub>O.

(b) Adjust CO<sub>2</sub> emission rates calculated under paragraph (a) of this section for measured test fuel properties as specified in this paragraph (b). This adjustment is intended to make official

emission results independent of differences in test fuels within a fuel type. Use good engineering judgment to develop and apply testing protocols to minimize the impact of variations in test fuels.

(1) Determine mass-specific net energy content,  $E_{mfuelmeas}$ , also known as lower heating value, in MJ/kg, expressed to at least three decimal places, as follows:

(i) For liquid fuels, determine  $E_{mfuelmeas}$  according to ASTM D4809 (incorporated by reference in § 1036.810).

(ii) For gaseous fuels, determine  $E_{mfuelmeas}$  using good engineering judgment.

(2) Determine your test fuel's carbon mass fraction,  $w_C$ , as described in 40 CFR 1065.655(d), expressed to at least three decimal places; however, you must measure fuel properties rather than using the default values specified in Table 1 of 40 CFR 1065.655. Have the sample analyzed by three different labs and use the arithmetic mean of the results as your test fuel's  $w_C$ .

(3) If, over a period of time, you receive multiple fuel deliveries from a single stock batch of test fuel, you may use constant values for mass-specific energy content and carbon mass fraction, consistent with good engineering judgment. To use this provision, you must demonstrate that every subsequent delivery comes from the same stock batch and that the fuel has not been contaminated.

(4) Correct measured CO<sub>2</sub> emission rates as follows:

$$e_{CO2cor} = e_{CO2} \cdot \frac{E_{mfuelmeas}}{E_{mfuelCref} \cdot w_{Cmeas}}$$

Eq. 1036.530-1

Where:

$e_{CO2}$  = the calculated CO<sub>2</sub> emission result.

$E_{mfuelmeas}$  = the mass-specific net energy content of the test fuel as determined in paragraph (b)(1) of this section. Note that dividing this value by  $w_{Cmeas}$  (as is done in this equation) equates to a carbon-specific net energy content having the same units as  $E_{mfuelCref}$ .

$E_{mfuelCref}$  = the reference value of carbon-mass-specific net energy content for the appropriate fuel type, as determined in Table 1 of this section.

$w_{Cmeas}$  = carbon mass fraction of the test fuel (or mixture of test fuels) as determined in paragraph (b)(2) of this section.

*Example:*

$e_{CO2} = 630.0 \text{ g/hp-hr}$

$E_{mfuelmeas} = 42.528 \text{ MJ/kg}$

$E_{mfuelCref} = 49.3112 \text{ MJ/kgC}$

$w_{Cmeas} = 0.870$

$$e_{CO2cor} = 630.0 \cdot \frac{42.528}{49.3112 \cdot 0.870} \quad e_{CO2cor} = 624.5 \text{ g/hp}\cdot\text{hr}$$

TABLE 1 OF § 1036.530—REFERENCE FUEL PROPERTIES

Fuel type <sup>1</sup>	Reference fuel carbon-mass-specific net energy content, $E_{mfuelCref}$ (MJ/kgC) <sup>2</sup>	Reference fuel carbon mass fraction, $w_{Cref}$ <sup>2</sup>
Diesel fuel .....	49.3112	0.874
Gasoline .....	50.4742	0.846
Natural Gas .....	66.2910	0.750
LPG .....	56.5218	0.820
Dimethyl Ether .....	55.3886	0.521
High-level ethanol-gasoline blends .....	50.3211	0.576

<sup>1</sup> For fuels that are not listed, you must ask us to approve reference fuel properties.

<sup>2</sup> For multi-fuel streams, such as natural gas with diesel fuel pilot injection, use good engineering judgment to determine blended values for  $E_{mfuelCref}$  and  $w_{Cref}$  using the values in this table.

(c) Your official emission result for each pollutant equals your calculated brake-specific emission rate multiplied by all applicable adjustment factors, other than the deterioration factor.

**§ 1036.535 Determining steady-state engine fuel maps and fuel consumption at idle.**

This section describes how to determine an engine’s steady-state fuel map and fuel consumption at idle for model year 2021 and later vehicles. Vehicle manufacturers may need these values to demonstrate compliance with emission standards under 40 CFR part 1037 as described in § 1036.510.

(a) *General test provisions.* Perform fuel mapping using the procedure described in paragraph (b) of this section to establish measured fuel-consumption rates at a range of engine speed and load settings. Measure fuel consumption at idle using the procedure described in paragraph (c) of this section. If you perform cycle-average mapping for highway cruise cycles as described in § 1037.540, omit mapping under paragraph (b) of the section and instead perform mapping as described in paragraph (c) and (d) of this section. Use these measured fuel-consumption values to declare fuel-consumption rates for certification as described in paragraph (e) of this section.

(1) Map the engine as described in § 1036.510(a)(2) and (3), and perform emission measurements as described in 40 CFR 1065.501 and 1065.530 for discrete-mode steady-state testing. This section uses engine parameters and variables that are consistent with 40 CFR part 1065.

(2) Measure NO<sub>x</sub> emissions for each specified sampling period in g/s. You may perform these measurements using a NO<sub>x</sub> emission-measurement system

that meets the requirements of 40 CFR part 1065, subpart J. Include these measured NO<sub>x</sub> values any time you report to us your fuel consumption values from testing under this section. If a system malfunction prevents you from measuring NO<sub>x</sub> emissions during a test under this section but the test otherwise gives valid results, you may consider this a valid test and omit the NO<sub>x</sub> emission measurements; however, we may require you to repeat the test if we determine that you inappropriately voided the test with respect to NO<sub>x</sub> emission measurement.

(b) *Steady-state fuel mapping.* Determine fuel-consumption rates for each engine configuration over a series of steady-state engine operating points as described in this paragraph (b). You may use shared data across an engine platform to the extent that the fuel-consumption rates remain valid. For example, if you test a high-output configuration and create a different configuration that uses the same fueling strategy but limits the engine operation to be a subset of that from the high-output configuration, you may use the fuel-consumption rates for the reduced number of mapped points for the low-output configuration, as long as the narrower map includes at least 70 points. Perform fuel mapping as follows:

(1) Select ten speed points that include warm idle speed,  $f_{idle}$ , the highest speed above maximum power at which 70% of maximum power occurs,  $n_{hi}$ , and eight equally spaced points between  $f_{idle}$  and  $n_{hi}$ . Control speed to within ±1% of  $n_{hi}$  (see 40 CFR 1065.610(c)).

(2) Select ten torque values, including  $T = 0$ , maximum mapped torque,  $T_{max\ mapped}$ , and eight equally spaced points between  $T = 0$  and  $T_{max\ mapped}$ . Replace any torque setpoints that are above the

mapped torque at a given speed,  $T_{max}$ , minus 5 percent of  $T_{max\ mapped}$ , with one test point at  $T_{max}$ . Control engine torque to within ±5% of  $T_{max\ mapped}$ .

(3) You may need to adjust dynamometer settings any time the engine is operating on the low-speed or high-speed governor to maintain stable engine operation. You may change the dynamometer’s speed setpoint as needed to avoid activating the engine’s governor. You may alternatively set the dynamometer mode to torque-control, in which case speed can fall outside of ±1% of  $n_{hi}$ .

(4) Precondition the engine as described in 40 CFR 1065.510(b)(2).

(5) Within 60 seconds after concluding the preconditioning procedure, operate the engine at  $n_{hi}$  and  $T_{max}$ .

(6) After the engine operates at the set speed and torque for 60 seconds, start recording measurements using one of the following methods:

(i) *Carbon mass balance.* Record speed and torque and measure emissions and other inputs needed to run the chemical balance in 40 CFR 1065.655(c) for (29 to 31) seconds; determine the corresponding mean values for the sampling period. We will use carbon mass balance.

(ii) *Direct measurement of fuel flow.* Record speed and torque and measure fuel consumption with a fuel flow meter for (29 to 31) seconds; determine the corresponding mean values for the sampling period.

(7) After completing the sampling period described in paragraph (b)(6) of this section, linearly ramp the engine over 15 seconds to the next lowest torque value while holding speed constant. Perform the measurements described at the new torque setting and



repeat this sequence for all remaining torque values down to  $T = 0$ .

(8) Continue testing to complete fuel mapping as follows:

(i) At  $T = 0$ , linearly ramp the engine over 15 seconds to operate at the next lowest speed value and increase torque to  $T_{\max}$ . Perform measurements for all the torque values at the selected speed as described in paragraphs (b)(6) and (7) of this section. Repeat this sequence for all remaining speed values down to  $f_{\text{idle}}$  to complete the fuel-mapping procedure. You may interrupt the mapping sequence to calibrate emission-

measurement instrumentation only during stabilization at  $T_{\max}$  for a given speed. If you use batch sampling to measure background emissions, you may sample periodically into the bag over the course of multiple test intervals defined by the period between calibrations of emission-measurement instrumentation. The background sample must be applied to correct emissions sampled over the test interval(s) between calibrations.

(ii) If an infrequent regeneration event occurs during fuel mapping, invalidate

all the measurements made at that engine speed. Allow the regeneration event to finish, then restart engine stabilization at  $T_{\max}$  at the same engine speed and continue with measurements from that point in the fuel-mapping sequence.

(9) If you determine fuel-consumption rates using emission measurements from the raw or diluted exhaust, calculate the mean fuel mass flow rate,  $\bar{m}_{\text{fuel}}$ , for each point in the fuel map using the following equation:

$$\bar{m}_{\text{fuel}} = \frac{M_C}{w_{\text{Cmeas}}} \cdot \left( \bar{n}_{\text{exh}} \cdot \frac{\bar{x}_{\text{Ccombdry}}}{1 + \bar{x}_{\text{H}_2\text{Oexhdry}}} - \frac{\bar{m}_{\text{CO}_2\text{DEF}}}{M_{\text{CO}_2}} \right)$$

Eq. 1036.535-1

Where:

$\bar{m}_{\text{fuel}}$  = mean fuel mass flow rate for a given fuel map setpoint, expressed to at least the nearest 0.001 g/s.

$M_C$  = molar mass of carbon.

$w_{\text{Cmeas}}$  = carbon mass fraction of fuel (or mixture of test fuels) as determined in 40 CFR 1065.655(d), except that you may not use the default properties in Table 1 of 40 CFR 1065.655 to determine  $\alpha$ ,  $\beta$ , and  $w_C$  for liquid fuels.

$\bar{n}_{\text{exh}}$  = the mean raw exhaust molar flow rate from which you measured emissions according to 40 CFR 1065.655.

$\bar{x}_{\text{Ccombdry}}$  = the mean concentration of carbon from fuel and any injected fluids in the exhaust per mole of dry exhaust as determined in 40 CFR 1065.655(c).

$\bar{x}_{\text{H}_2\text{Oexhdry}}$  = the mean concentration of  $\text{H}_2\text{O}$  in exhaust per mole of dry exhaust as determined in 40 CFR 1065.655(c).

$\bar{m}_{\text{CO}_2\text{DEF}}$  = the mean  $\text{CO}_2$  mass emission rate resulting from diesel exhaust fluid decomposition as determined in

paragraph (b)(10) of this section. If your engine does not use diesel exhaust fluid, or if you choose not to perform this correction, set  $\bar{m}_{\text{CO}_2\text{DEF}}$  equal to 0.

$M_{\text{CO}_2}$  = molar mass of carbon dioxide.

*Example:*

$M_C = 12.0107$  g/mol

$w_{\text{Cmeas}} = 0.869$

$\bar{n}_{\text{exh}} = 25.534$  mol/s

$\bar{x}_{\text{Ccombdry}} = 0.002805$  mol/mol

$\bar{x}_{\text{H}_2\text{Oexhdry}} = 0.0353$  mol/mol

$\bar{m}_{\text{CO}_2\text{DEF}} = 0.0726$  g/s

$M_{\text{CO}_2} = 44.0095$  g/mol

$$\bar{m}_{\text{fuel}} = \frac{12.0107}{0.869} \cdot \left( 25.534 \cdot \frac{0.002805}{1 + 0.0353} - \frac{0.0726}{44.0095} \right) = 0.933 \text{ g/s}$$

(10) If you determine fuel-consumption rates using emission measurements with engines that utilize

diesel exhaust fluid for  $\text{NO}_x$  control, correct for the mean  $\text{CO}_2$  mass emissions resulting from diesel exhaust

fluid decomposition at each fuel map setpoint using the following equation:

$$\bar{m}_{\text{CO}_2\text{DEF}} = \bar{m}_{\text{DEF}} \cdot \frac{M_{\text{CO}_2} \cdot w_{\text{CH}_4\text{N}_2\text{O}}}{M_{\text{CH}_4\text{N}_2\text{O}}}$$

Eq. 1036.535-2

Where:

$\bar{m}_{\text{DEF}}$  = the mean mass flow rate of injected urea solution diesel exhaust fluid for a given sampling period, determined directly from the engine control module, or measured separately, consistent with good engineering judgment.

$M_{\text{CO}_2}$  = molar mass of carbon dioxide.

$w_{\text{CH}_4\text{N}_2\text{O}}$  = mass fraction of urea in diesel exhaust fluid aqueous solution. Note that the subscript "CH<sub>4</sub>N<sub>2</sub>O" refers to urea as a pure compound and the subscript "DEF" refers to the aqueous 32.5% urea diesel exhaust fluid as a solution of urea in water with a nominal urea concentration of 32.5%.

$M_{\text{CH}_4\text{N}_2\text{O}}$  = molar mass of urea.

*Example:*

$\bar{m}_{\text{DEF}} = 0.304$  g/s

$M_{\text{CO}_2} = 44.0095$  g/mol

$w_{\text{CH}_4\text{N}_2\text{O}} = 32.5\% = 0.325$

$M_{\text{CH}_4\text{N}_2\text{O}} = 60.05526$  g/mol

$$\bar{m}_{\text{CO}_2\text{DEF}} = 0.304 \cdot \frac{44.0095 \cdot 0.325}{60.05526} = 0.0726 \text{ g/s}$$

(11) Correct the measured or calculated mean fuel mass flow rate,

$\bar{m}_{\text{fuel}}$  at each engine operating condition to a mass-specific net energy content of

a reference fuel using the following equation:

$$\bar{m}_{\text{fuelcor}} = \bar{m}_{\text{fuel}} \cdot \frac{E_{\text{mfuelmeas}}}{E_{\text{mfuelCref}} \cdot w_{\text{Cref}}}$$

Eq. 1036.535-3

Where:

$E_{\text{mfuelmeas}}$  = the mass-specific net energy content of the test fuel as determined in § 1036.530(b)(1).

$E_{\text{mfuelCref}}$  = the reference value of carbon-mass-specific net energy content for the appropriate fuel. Use the values shown in Table 1 of § 1036.530 for the

designated fuel types, or values we approve for other fuel types.  
 $w_{\text{Cref}}$  = the reference value of carbon mass fraction for the test fuel as shown in Table 1 of § 1036.530 for the designated fuels. For other fuels, use the reference carbon mass fraction of diesel fuel for engines subject to compression-ignition

standards, and use the reference carbon mass fraction of gasoline for engines subject to spark-ignition standards.

*Example:*

$\bar{m}_{\text{fuel}} = 0.933 \text{ g/s}$   
 $E_{\text{mfuelmeas}} = 42.7984 \text{ MJ/kgC}$   
 $E_{\text{mfuelCref}} = 49.3112 \text{ MJ/kgC}$   
 $w_{\text{Cref}} = 0.874$

$$\bar{m}_{\text{fuel}} = 0.933 \cdot \frac{42.7984}{49.3112 \cdot 0.874} = 0.927 \text{ g/s}$$

(c) *Fuel consumption at idle.* Determine values for fuel-consumption rate at idle for each engine configuration as described in this paragraph (c). You may use shared data across engine configurations, consistent with good engineering judgment. Perform measurements as follows:

(1) Precondition the engine as described in 40 CFR 1065.510(b)(2).

(2) Within 60 seconds after concluding the preconditioning procedure, operate the engine at its minimum declared warm idle speed,  $f_{\text{idlemin}}$ , as described in 40 CFR 1065.510(b)(3), set zero torque, and start the sampling period. Continue sampling for (595 to 605) seconds. Perform measurements using carbon mass balance. Record speed and torque and measure emissions and other inputs as described in 40 CFR 1065.655(c); determine the corresponding mean values for the sampling period. Calculate the mean fuel mass flow rate,  $\bar{m}_{\text{fuel}}$ , during the sampling period as

described in paragraph (b)(9) of this section.

Manufacturers may instead measure fuel consumption with a fuel flow meter and determine the corresponding mean values for the sampling period.

(3) Repeat the steps in paragraphs (c)(1) and (2) of this section with the engine set to operate at a torque setting of 100 N·m.

(4) Repeat the steps in paragraphs (c)(1) through (3) of this section with the engine operated at its declared maximum warm idle speed,  $f_{\text{idlemax}}$ .

(5) If an infrequent regeneration event occurs during this procedure, invalidate any measurements made at that idle condition. Allow the regeneration event to finish, then repeat the measurement and continue with the test sequence.

(6) Correct the measured or calculated mean fuel mass flow rate,  $\bar{m}_{\text{fuel}}$  at each of the four idle settings to account for mass-specific net energy content as described in paragraph (b)(11) of this section.

(d) *Steady-state fuel maps used for cycle-average fuel mapping of the cruise cycles.* Use the appropriate default steady-state engine fuel map as specified in Appendix I to this part to generate cycle-average fuel maps under § 1036.540, as amended based on the measurements specified in this paragraph (d). Measure fuel consumption at idle at the four specified engine operating conditions. For any values from the default map that lie within the boundaries of the engine speed and torque values represented by these idle-operating points, use the measured values instead of the default values. You may use shared data across engine configurations, consistent with good engineering judgment. Determine values for fuel-consumption rate at idle for each engine configuration as follows:

(1) Determine idle torque,  $T_{\text{idle}}$ , at the engine's maximum warm idle speed using the following equation:

$$T_{\text{idle[speed]}} = \left( \frac{T_{\text{finstall}} \cdot f_{\text{idle[speed]}}^2}{f_{\text{finstall}}^2} + \frac{P_{\text{acc}}}{f_{\text{idle[speed]}}} \right) \cdot 1.1$$

Eq. 1036.535-4

Where:

$T_{\text{finstall}}$  = the maximum engine torque at  $f_{\text{finstall}}$ .  
 $f_{\text{idle[speed]}}$  = the applicable engine idle speed as described in this paragraph (d).

$f_{\text{finstall}}$  = the stall speed of the torque converter; use  $f_{\text{ntest}}$  or 2250 rpm, whichever is lower.

$P_{\text{acc}}$  = accessory power for the vehicle class; use 1500 W for Vocational Light HDV, 2500 W for Vocational Medium HDV, and 3500 W for Tractors and Vocational Heavy HDV.

*Example:*

$T_{\text{finstall}} = 1870 \text{ N·m}$   
 $f_{\text{ntest}} = 1740.8 \text{ r/min} = 182.30 \text{ rad/s}$   
 $f_{\text{finstall}} = 1740.8 \text{ r/min} = 182.30 \text{ rad/s}$   
 $f_{\text{idlemax}} = 700 \text{ r/min} = 73.30 \text{ rad/s}$   
 $P_{\text{acc}} = 1500 \text{ W}$

$$T_{\text{idlemax}} = \left( \frac{1870 \cdot 73.30^2}{182.30^2} + \frac{1500}{73.30} \right) \cdot 1.1 = 352.12 \text{ N} \cdot \text{m}$$

(2) Precondition the engine as described in 40 CFR 1065.510(b)(2).

(3) Within 60 seconds after concluding the preconditioning procedure, operate the engine at its maximum declared warm idle speed,  $f_{\text{idlemax}}$ , as described in 40 CFR 1065.510(b)(3), set torque to the value determined in paragraph (d)(1) of this section, after the engine operates at the set speed and torque for 60 seconds, start the sampling period. Continue sampling for (29 to 31) seconds. Perform measurements using carbon mass balance. Record speed and torque and measure emissions and other inputs as described in 40 CFR 1065.655(c); determine the corresponding mean values for the sampling period. Calculate the mean fuel mass flow rate,  $\bar{m}_{\text{fuel}}$ , during the sampling period as described in paragraph (b)(9) of this section. Manufacturers may instead measure fuel consumption with a fuel flow meter and determine the corresponding mean values for the sampling period.

(4) Repeat the steps in paragraphs (d)(2) and (3) of this section with the engine set to operate at zero torque.

(5) Repeat the steps in paragraphs (d)(1) through (4) of this section with the engine operated at its declared minimum warm idle speed,  $f_{\text{idlemin}}$ .

(6) If an infrequent regeneration event occurs during this procedure, invalidate any measurements made at that idle condition. Allow the regeneration event to finish, then repeat the measurement and continue with the test sequence.

(7) Correct the measured or calculated mean fuel mass flow rate,  $\bar{m}_{\text{fuel}}$  at each of the four idle settings to account for mass-specific net energy content as described in paragraph (b)(11) of this section.

(e) *Measured vs. declared fuel-consumption rates.* Select fuel-consumption rates in g/s to characterize the engine's fuel maps. These declared values may not be lower than any

corresponding measured values determined in paragraphs (b) through (d) of this section. You may select any value that is at or above the corresponding measured value. These declared fuel-consumption rates, which serve as emission standards under § 1036.108, are the values that vehicle manufacturers will use for certification under 40 CFR part 1037. Note that production engines are subject to GEM cycle-weighted limits as described in § 1036.301.

**§ 1036.540 Determining cycle-average engine fuel maps.**

(a) *Overview.* This section describes how to determine an engine's cycle-average fuel maps for model year 2021 and later vehicles with transient cycles. This may also apply for highway cruise cycles as described in § 1036.510. Vehicle manufacturers may need one or both of these to demonstrate compliance with emission standards under 40 CFR part 1037. Generating cycle-average engine fuel maps consists of the following steps:

(1) Determine the engine's torque maps as described in § 1036.510(a).

(2) Determine the engine's steady-state fuel map and fuel consumption at idle as described in § 1036.535.

(3) Simulate several different vehicle configurations using GEM (see 40 CFR 1037.520) to create new engine duty cycles, as described in paragraph (c) of this section. The transient vehicle duty cycles for this simulation are in 40 CFR part 1037, Appendix I; the highway cruise cycles with grade are in 40 CFR part 1037, Appendix IV. Note that GEM simulation relies on vehicle service classes as described in 40 CFR 1037.140.

(4) Test the engines using the new duty cycles to determine fuel consumption, cycle work, and average vehicle speed as described in paragraph (d) of this section and establish GEM inputs for those parameters for further vehicle simulations as described in paragraph (e) of this section.

(b) *General test provisions.* The following provisions apply for testing under this section:

(1) To perform fuel mapping under this section for hybrid engines, make sure the engine and its hybrid features are appropriately configured to represent the hybrid features in your testing.

(2) Measure NO<sub>x</sub> emissions for each specified sampling period in grams. You may perform these measurements using a NO<sub>x</sub> emission-measurement system that meets the requirements of 40 CFR part 1065, subpart J. Include these measured NO<sub>x</sub> values any time you report to us your fuel consumption values from testing under this section. If a system malfunction prevents you from measuring NO<sub>x</sub> emissions during a test under this section but the test otherwise gives valid results, you may consider this a valid test and omit the NO<sub>x</sub> emission measurements; however, we may require you to repeat the test if we determine that you inappropriately voided the test with respect to NO<sub>x</sub> emission measurement.

(3) This section uses engine parameters and variables that are consistent with 40 CFR part 1065.

(c) *Create engine cycles.* Use GEM to simulate several different vehicle configurations to create transient and highway cruise engine cycles corresponding to each vehicle configuration, as follows:

(1) Set up GEM to simulate vehicle operation based on your engine's torque maps, steady-state fuel maps, and fuel consumption at idle as described in paragraph (a)(1) and (2) of this section.

(2) Set up GEM with transmission gear ratios for different vehicle service classes and vehicle duty cycles as described in Table 1 of this section. These values are based on automatic or automated manual transmissions, but they apply for all transmission types.

TABLE 1 OF § 1036.540—ASSIGNED TRANSMISSION GEAR RATIOS

Gear number	Light HDV and medium HDV	Tractors and heavy HDV, transient cycle	Tractors and heavy HDV, highway cruise cycle
1	3.10	3.51	12.8
2	1.81	1.91	9.25
3	1.41	1.43	6.76
4	1.00	1.00	4.90
5	0.71	0.74	3.58
6	0.61	0.64	2.61

TABLE 1 OF § 1036.540—ASSIGNED TRANSMISSION GEAR RATIOS—Continued

Gear number	Light HDV and medium HDV	Tractors and heavy HDV, transient cycle	Tractors and heavy HDV, highway cruise cycle
7 .....	.....	.....	1.89
8 .....	.....	.....	1.38
9 .....	.....	.....	1.00
10 .....	.....	.....	0.73

(3) Run GEM for each simulated vehicle configuration as follows:

(i) Use one of the following equations to determine tire size,  $\frac{f_{ntire}}{v_{vehicle}}$ , and drive axle ratio,

$k_a$ , at each of the defined engine speeds in Tables 2 through 4 of this section:

(A) Select a value for  $\left[ \frac{f_{ntire}}{v_{vehicle}} \right]_{[speed]}$  and solve for  $k_{a[speed]}$  using the following

equation:

$$k_{a[speed]} = \frac{f_{n[speed]}}{\left[ \frac{f_{ntire}}{v_{vehicle}} \right]_{[speed]} \cdot k_{topgear} \cdot v_{ref}}$$

Eq. 1036.540-1

Where:

$f_{n[speed]}$  = engine's angular speed as determined in paragraph (c)(3)(ii) or (iii) of this section.

$k_{topgear}$  = transmission gear ratio in the highest available gear from Table 4 of this section (for powertrain testing use actual top gear ratio).

$v_{ref}$  = reference speed. Use 65 mi/hr for the transient cycle and the 65 mi/hr highway cruise cycle, and use 55 mi/hr for the 55 mi/hr highway cruise cycle.

(B) Select a value for  $k_{a[speed]}$  and solve for  $\left[ \frac{f_{ntire}}{v_{vehicle}} \right]_{[speed]}$  using the following

equation:

$$\left[ \frac{f_{ntire}}{v_{vehicle}} \right]_{[speed]} = \frac{f_{n[speed]}}{k_{a[speed]} \cdot k_{topgear} \cdot v_{ref}}$$

Eq. 1036.540-2

*Example:*  
This example is for a vocational Light HDV or vocational Medium HDV with a 6-speed

automatic transmission at B speed (Test 3 or 4 in Table 2 of this section).  
 $f_{\text{refB}} = 1870 \text{ r/min} = 31.17 \text{ r/s}$

$k_{\text{aB}} = 4.0$   
 $k_{\text{topgear}} = 0.61$   
 $v_{\text{ref}} = 65 \text{ mi/hr} = 29.06 \text{ m/s}$

$$\left[ \frac{f_{\text{ntire}}}{v_{\text{vehicle}}} \right]_{\text{B}} = \frac{31.17}{4.0 \cdot 0.61 \cdot 29.06} = 0.4396 \text{ rev/m}$$

(ii) Test at least eight different vehicle configurations for engines that will be installed in vocational Light HDV or vocational Medium HDV. If the engine will also be installed in vocational Heavy HDV, use good engineering judgment to select at least nine test configurations that best represent the

range of vehicles. For example, if your engines will be installed in vocational Medium HDV and vocational Heavy HDV, you might select Tests 1 through 6 of Table 2 of this section to represent Class 7 vehicles and Tests 3, 6, and 9 of Table 3 of this section to represent Class 8 vehicles. You may test your

engine using additional vehicle configurations with different  $k_a$  and  $C_{\text{rr}}$  values to represent a wider range of in-use vehicle configurations. Set  $C_{\text{dA}}$  to 5.4 for all test configurations. For powertrain testing, set  $M_{\text{rotating}}$  to 340 kg and  $Eff_{\text{axle}}$  to 0.955 for all test configurations.

Set the axle ratio,  $k_a$ , and tire size,  $\frac{f_{\text{ntire}}}{v_{\text{vehicle}}}$ , for each test configuration based on the

corresponding designated engine speed (A, B, C, or  $f_{\text{ntest}}$ ) at 65 mi/hr for the transient cycle and the 65 mi/hr

highway cruise cycle, and at 55 mi/hr for the 55 mi/hr highway cruise cycle. These engine speeds apply equally for

engines subject to spark-ignition standards. Use the following settings specific to each vehicle configuration:

Table 2 of § 1036.540—Vehicle Settings for Testing Vocational Light HDV or Vocational Medium HDV

	Test 1	Test 2	Test 3	Test 4	Test 5	Test 6	Test 7	Test 8
$C_{\text{rr}}$ (kg/tonne)	6.2	7.7	6.2	7.7	6.2	7.7	6.2	7.7
$\frac{f_{\text{ntire}}}{v_{\text{vehicle}}}$ and $k_a$ for CI engines at engine speed	A	A	B	B	C	C	Maximum test speed	Maximum test speed
$\frac{f_{\text{ntire}}}{v_{\text{vehicle}}}$ and $k_a$ for SI engines at engine speed	Minimum NTE exclusion speed	Minimum NTE exclusion speed	A	A	B	B	C	C
GEM Regulatory Subcategory	LHD	MHD	LHD	MHD	LHD	MHD	LHD	MHD
$M$ (kg)	7,257	11,408	7,257	11,408	7,257	11,408	7,257	11,408

(iii) Test nine different vehicle configurations for engines that will be installed in vocational Heavy HDV and for tractors that are not heavy-haul tractors. Test over six different test

configurations for heavy-haul tractors. You may test your engines for additional configurations with different  $k_a$ ,  $C_{\text{dA}}$ , and  $C_{\text{rr}}$  values to represent a wider range of in-use vehicle

configurations. Set  $C_{\text{rr}}$  to 6.9 for all nine defined test configurations. For powertrain testing, set  $Eff_{\text{axle}}$  to 0.955 for all test configurations. Set the axle ratio,  $k_a$ ,

and tire size,  $\frac{f_{\text{ntire}}}{v_{\text{vehicle}}}$ , for each test configuration based on the corresponding designated

engine speed (B,  $f_{\text{ntest}}$ , or the minimum NTE exclusion speed as determined in

40 CFR 86.1370(b)(1)) at 65 mi/hr. Use the settings specific to each test

configuration as shown in Table 3 or Table 4 of this section, as appropriate.

Engines subject to testing under both Table 3 and Table 4 of this section need not repeat overlapping test

configurations, so complete fuel mapping requires testing 12 (not 15) test configurations for those engines. Note

that  $M_{rotating}$  is needed for powertrain testing but not for engine testing. Tables 3 and 4 follow:

Table 3 of § 1036.540—Vehicle Settings for Testing General Purpose Tractors and Vocational Heavy HDV

	Test 1	Test 2	Test 3	Test 4	Test 5	Test 6	Test 7	Test 8	Test 9
$C_dA$	5.4	4.7	4.0	5.4	4.7	4.0	5.4	4.7	4.0
$M_{rotating}$ (kg)	1,021	794	794	1,021	794	794	1,021	794	794
$\frac{f_{ntire}}{v_{vehicle}}$ and $k_a$ at engine speed	Minimum NTE exclusion speed	Minimum NTE exclusion speed	Minimum NTE exclusion speed	B	B	B	Maximum test speed	Maximum test speed	Maximum test speed
GEM Regulatory Subcategory	C8_SC_H_R	C8_DC_M_R	C7_DC_MR	C8_S_C_HR	C8_D_C_MR	C7_D_C_MR	C8_SC_H_R	C8_DC_MR	C7_DC_MR
Vehicle Weight Reduction (lbs)	0	13,275	6,147	0	13,275	6,147	0	13,275	6,147
$M$ (kg)	31,978	25,515	19,051	31,978	25,515	19,051	31,978	25,515	19,051

Table 4 of § 1036.540—Vehicle Settings for Testing Heavy-Haul Tractors

	Test 1	Test 2	Test 3	Test 4	Test 5	Test 6
$C_dA$	5.0	5.4	5.0	5.4	5.0	5.4
$M_{rotating}$ (kg)	1,021	1,021	1,021	1,021	1,021	1,021
$\frac{f_{ntire}}{v_{vehicle}}$ and $k_a$ at engine speed	Minimum NTE exclusion speed	Minimum NTE exclusion speed	B	B	Maximum test speed	Maximum test speed
GEM Regulatory Subcategory	C8_HH	C8_SC_HR	C8_HH	C8_SC_HR	C8_HH	C8_SC_HR
$M$ (kg)	53,751	31,978	53,751	31,978	53,751	31,978

(iv) Use the defined values in Tables 1 through 4 of this section to set up GEM with the correct regulatory subcategory and vehicle weight reduction, if applicable, to achieve the target vehicle mass,  $M$ , for each test.

(4) Use the GEM output of instantaneous engine speed and engine flywheel torque for each of the vehicle configurations to generate a 10 Hz transient duty cycle corresponding to each vehicle configuration operating over each vehicle duty cycle.

(d) *Test the engine with GEM cycles.* Test the engine over each of the transient duty cycles generated in paragraph (c) of this section as follows:

(1) Precondition the engine either as described in 40 CFR 1037.510(a)(2)(i) for the transient duty-cycle and 40 CFR 1037.510(a)(2)(ii) for the highway cruise duty cycles using the Test 1 vehicle configuration, and then continue testing

the different configurations in the order presented in this section. Measure emissions as described in 40 CFR part 1065; perform cycle validation according to 40 CFR part 1065, subpart F, except as noted in this paragraph (d)(1). If the range of reference speeds is less than 10 percent of the mean reference speed, you need to meet only the standard error of estimate in Table 2 of 40 CFR 1065.514. For purposes of cycle validation, treat points as being at idle if reference speed is at or below declared idle speed. For plug-in hybrid engines, precondition the battery and then complete all back-to-back tests for each test configuration according to 40 CFR 1066.501 before moving to the next test configuration. You may send signals to the engine controller during the test, such as current transmission gear and vehicle speed, if that allows engine

operation during the test to better represent in-use operation.

(2) If an infrequent regeneration event occurs during a mapping test interval, invalidate that test interval. Continue operating the vehicle to allow the regeneration event to finish, then repeat engine preconditioning and resume testing at the start of the invalidated test cycle.

(3) For each test, record measurements needed to determine fuel mass using carbon mass balance. Record speed and torque and measure emissions and other inputs as described in 40 CFR 1065.655(c). Manufacturers may instead measure fuel consumption with a fuel flow meter. For hybrid powertrains with no plug-in capability, correct for the net energy change of the energy storage device as described in 40 CFR 1066.501. For plug-in hybrid engines, follow 40 CFR 1066.501 to

determine End-of-Test for charge-depleting operation; to do this, you must get our advance approval for a utility factor curve. We will approve your utility factor curve if you can show that you created it from sufficient in-use data of vehicles in the same application

as the vehicles in which the PHEV engine will be installed.

(4) Calculate the fuel mass flow rate,  $m_{\text{fuel}}$ , for each duty cycle using one of the following equations:

(i) Determine fuel-consumption rates using emission measurements from the

raw or diluted exhaust, calculate the mass of fuel for each duty cycle,  $m_{\text{fuel}[\text{cycle}]}$ , as follows:

(A) For calculations that use continuous measurement of emissions and continuous CO<sub>2</sub> from urea, calculate  $m_{\text{fuel}[\text{cycle}]}$  using the following equation:

$$m_{\text{fuel}[\text{cycle}]} = \frac{M_C}{w_{\text{Cmeas}}} \cdot \left( \sum_{i=1}^N \left( \dot{n}_{\text{exh}_i} \cdot \frac{x_{\text{Ccombdry}_i}}{1 + x_{\text{H}_2\text{Oexhdry}_i}} \cdot \Delta t \right) - \frac{1}{M_{\text{CO}_2}} \sum_{i=1}^N \left( \dot{m}_{\text{CO}_2\text{DEF}_i} \cdot \Delta t \right) \right)$$

Eq. 1036.540-3

Where:

$M_C$  = molar mass of carbon.

$w_{\text{Cmeas}}$  = carbon mass fraction of fuel (or mixture of test fuels) as determined in 40 CFR 1065.655(d), except that you may not use the default properties in Table 1 of 40 CFR 1065.655 to determine  $\alpha$ ,  $\beta$ , and  $w_C$  for liquid fuels.

$i$  = an indexing variable that represents one recorded emission value.

$N$  = total number of measurements over the duty cycle.

$\dot{n}_{\text{exh}}$  = exhaust molar flow rate from which you measured emissions.

$x_{\text{Ccombdry}}$  = amount of carbon from fuel and any injected fluids in the exhaust per

mole of dry exhaust as determined in 40 CFR 1065.655(c).

$x_{\text{H}_2\text{Oexhdry}}$  = amount of H<sub>2</sub>O in exhaust per mole of exhaust as determined in 40 CFR 1065.655(c).

$\Delta t = 1/f_{\text{record}}$ .

$M_{\text{CO}_2}$  = molar mass of carbon dioxide.

$\dot{m}_{\text{CO}_2\text{DEF}}$  = mass emission rate of CO<sub>2</sub> resulting from diesel exhaust fluid decomposition over the duty cycle as determined from § 1036.535(b)(10). If your engine does not utilize diesel exhaust fluid for emission control, or if you choose not to perform this correction, set  $\dot{m}_{\text{CO}_2\text{DEF}}$  equal to 0.

Example:

$M_C = 12.0107$  g/mol

$w_{\text{Cmeas}} = 0.867$

$N = 6680$

$\dot{n}_{\text{exh}1} = 2.876$  mol/s

$\dot{n}_{\text{exh}2} = 2.224$  mol/s

$x_{\text{Ccombdry}1} = 2.61 \cdot 10^{-3}$  mol/mol

$x_{\text{Ccombdry}2} = 1.91 \cdot 10^{-3}$  mol/mol

$x_{\text{H}_2\text{Oexhdry}1} = 3.53 \cdot 10^{-2}$  mol/mol

$x_{\text{H}_2\text{Oexhdry}2} = 3.13 \cdot 10^{-2}$  mol/mol

$f_{\text{record}} = 10$  Hz

$\Delta t = 1/10 = 0.1$  s

$M_{\text{CO}_2} = 44.0095$  g/mol

$\dot{m}_{\text{CO}_2\text{DEF}1} = 0.0726$  g/s

$\dot{m}_{\text{CO}_2\text{DEF}2} = 0.0751$  g/s

$$m_{\text{fueltransient}} = \frac{12.0107}{0.867} \cdot \left( \left( \begin{array}{l} 2.876 \cdot \frac{2.61 \cdot 10^{-3}}{1 + 3.53 \cdot 10^{-2}} \cdot 0.1 + \\ 2.224 \cdot \frac{1.91 \cdot 10^{-3}}{1 + 3.13 \cdot 10^{-2}} \cdot 0.1 + \\ \dots + \dot{n}_{\text{exh}_{6680}} \cdot \frac{x_{\text{Ccombdry}_{6680}}}{1 + x_{\text{H}_2\text{Oexhdry}_{6680}}} \cdot \Delta t_{6680} \end{array} \right) - \frac{1}{44.0095} \cdot (0.0726 \cdot 1.0 + 0.0751 \cdot 1.0 + \dots + \dot{m}_{\text{CO}_2\text{DEF}_{6680}} \cdot \Delta t_{6680}) \right)$$

$M_{\text{fueltransient}} = 1619.6$  g

(B) If you measure batch emissions and continuous CO<sub>2</sub> from urea, calculate  $m_{\text{fuel}[\text{cycle}]}$  using the following equation:

$$m_{\text{fuel}[\text{cycle}]} = \frac{M_C}{w_{\text{Cmeas}}} \cdot \left( \frac{\bar{x}_{\text{Ccombdry}}}{1 + \bar{x}_{\text{H}_2\text{Oexhdry}}} \cdot \sum_{i=1}^N (\dot{n}_{\text{exh}_i} \cdot \Delta t) - \frac{1}{M_{\text{CO}_2}} \sum_{i=1}^N (\dot{m}_{\text{CO}_2\text{DEF}_i} \cdot \Delta t) \right)$$

Eq. 1036.540-4

(C) If you measure continuous emissions and batch CO<sub>2</sub> from urea,

calculate  $m_{\text{fuel}[\text{cycle}]}$  using the following equation:

$$m_{\text{fuel}[\text{cycle}]} = \frac{M_C}{w_{\text{Cmeas}}} \cdot \left( \sum_{i=1}^N \left( \dot{n}_{\text{exh}_i} \cdot \frac{x_{\text{Ccombdry}_i}}{1 + x_{\text{H}_2\text{Oexhdry}_i}} \cdot \Delta t \right) - \frac{m_{\text{CO}_2\text{DEF}}}{M_{\text{CO}_2}} \right)$$

Eq. 1036.540-5

(D) If you measure batch emissions and batch CO<sub>2</sub> from urea, calculate *m<sub>fuel[cycle]</sub>* using the following equation:

$$m_{\text{fuel}[\text{cycle}]} = \frac{M_C}{w_{\text{Cmeas}}} \cdot \left( \frac{\bar{x}_{\text{Ccombdry}}}{1 + \bar{x}_{\text{H}_2\text{Oexhdry}}} \cdot \sum_{i=1}^N (\dot{n}_{\text{exh}_i} \cdot \Delta t) - \frac{m_{\text{CO}_2\text{DEF}}}{M_{\text{CO}_2}} \right)$$

Eq. 1036.540-6

(ii) Manufacturers may choose to measure fuel mass flow rate. Calculate

the mass of fuel for each duty cycle, *m<sub>fuel[cycle]</sub>*, as follows:

$$m_{\text{fuel}} = \sum_{i=1}^N \dot{m}_{\text{fuel}_i} \cdot \Delta t$$

Eq. 1036.540-7

Where:

*i* = an indexing variable that represents one recorded value.

*N* = total number of measurements over the duty cycle. For batch fuel mass measurements, set *N* = 1.

*m<sub>fuel<sub>i</sub></sub>* = the fuel mass flow rate, for each point, *i*, starting from *i* = 1.

$\Delta t = 1/f_{\text{record}}$

*f<sub>record</sub>* = the data recording frequency.

Example:

*N* = 6680

*m<sub>fuel<sub>1</sub></sub>* = 1.856 g/s

*m<sub>fuel<sub>2</sub></sub>* = 1.962 g/s

*f<sub>record</sub>* = 10 Hz

$\Delta t = 1/10 = 0.1$  s

*m<sub>fueltransient</sub>* = (1.856 + 1.962 + . . . + *m<sub>fuel6680</sub>*) · 0.1

*m<sub>fueltransient</sub>* = 111.95 g

(5) Correct the measured or calculated fuel mass flow rate, *m<sub>fuel</sub>*, for each test result to a mass-specific net energy content of a reference fuel as described

in § 1036.535(b)(11), replacing with *m<sub>fuel</sub>* with *m<sub>fuel</sub>* in Eq. 1036.535-3.

(6) For engines designed for plug-in hybrid electric vehicles, the mass of fuel for each cycle, *m<sub>fuel[cycle]</sub>*, is the utility factor-weighted fuel mass. This is done by calculating *m<sub>fuel</sub>* for the full charge-depleting and charge-sustaining portions of the test and weighting the results, using the following equation:

$$m_{\text{fuel}[\text{cycle}],\text{plug-in}} = m_{\text{fuel}[\text{cycle}],\text{CD}} \cdot UF_{D_{\text{CD}}} + m_{\text{fuel}[\text{cycle}],\text{CS}} \cdot (1 - UF_{D_{\text{CD}}})$$

Eq. 1036.540-8

Where:

*m<sub>fuel[cycle],CD</sub>* = total mass of fuel for all the tests in the charge-depleting portion of the test.

*UF<sub>D<sub>CD</sub></sub>* = utility factor fraction at distance *D<sub>CD</sub>* as determined by interpolating the approved utility factor curve.

*m<sub>fuel[cycle],CS</sub>* = total mass of fuel for all the tests in the charge-sustaining portion of the test.

$$D_{\text{CD}} = \sum_{i=1}^N (v_i \cdot \Delta t_i)$$

Eq. 1036.540-9

Where:

*v* = vehicle velocity at each time step. For tests completed under this section, *v* is

the vehicle velocity in the GEM duty-cycle file. For tests under 40 CFR



1037.550,  $v$  is the vehicle velocity as determined by Eq. 1037.550–1. Note that this should include complete and incomplete charge-depleting tests.

(e) *Determine GEM inputs.* Use the results of engine testing in paragraph (d) of this section to determine the GEM

inputs for the transient duty cycle and optionally for each of the highway cruise cycles corresponding to each simulated vehicle configuration as follows:

(1) Your declared fuel mass consumption,  $m_{\text{fueltransient}}$ . The declared

values may be at or above the values calculated in paragraph (d) of this section, as described in § 1036.535(e).

(2) Engine output speed per unit vehicle speed,

$$\frac{\bar{f}_{\text{engine}}}{\bar{v}_{\text{vehicle}}},$$

by taking the average engine speed measured during the engine test while the vehicle is moving and dividing it by the average vehicle speed provided by GEM. Note that the engine cycle created

by GEM has a flag to indicate when the vehicle is moving.

(3) Positive work determined according to 40 CFR 1065,  $W_{\text{transient}}$ .

(4) The following table illustrates the GEM data inputs corresponding to the different vehicle configurations:

Table 5 of § 1036.540—Example test result output matrix for Class 8 vocational vehicles

	Test 1	Test 2	Test 3	Test 4	Test 5	Test 6	Test 7	Test 8	Test 9
$m_{\text{fueltransient}}$									
$\frac{\bar{f}_{\text{engine}}}{\bar{v}_{\text{engine}}}$									
$W_{\text{transient}}$									

**Subpart G—Special Compliance Provisions**

**§ 1036.601 What compliance provisions apply?**

(a) Engine and vehicle manufacturers, as well as owners, operators, and rebuilders of engines subject to the requirements of this part, and all other persons, must observe the provisions of this part, the provisions of 40 CFR part 1068, and the provisions of the Clean Air Act. The provisions of 40 CFR part 1068 apply for heavy-duty highway engines as specified in that part, subject to the following provisions:

(1) The exemption provisions of 40 CFR 1068.201 through 1068.230, 1068.240, and 1068.260 through 265 apply for heavy-duty motor vehicle engines. The other exemption provisions, which are specific to nonroad engines, do not apply for heavy-duty vehicles or heavy-duty engines.

(2) The tampering prohibition in 40 CFR 1068.101(b)(1) applies for alternative fuel conversions as specified in 40 CFR part 85, subpart F.

(3) The warranty-related prohibitions in section 203(a)(4) of the Act (42 U.S.C. 7522(a)(4)) apply to manufacturers of new heavy-duty highway engines in addition to the prohibitions described in 40 CFR 1068.101(b)(6). We may assess a

civil penalty up to \$44,539 for each engine or vehicle in violation.

(b) Engines exempted from the applicable standards of 40 CFR part 86 under the provisions of 40 CFR part 1068 are exempt from the standards of this part without request.

(c) The emergency vehicle field modification provisions of 40 CFR 85.1716 apply with respect to the standards of this part.

(d) Subpart C of this part describes how to test and certify dual-fuel and flexible-fuel engines. Some multi-fuel engines may not fit either of those defined terms. For such engines, we will determine whether it is most appropriate to treat them as single-fuel engines, dual-fuel engines, or flexible-fuel engines based on the range of possible and expected fuel mixtures. For example, an engine might burn natural gas but initiate combustion with a pilot injection of diesel fuel. If the engine is designed to operate with a single fueling algorithm (*i.e.*, fueling rates are fixed at a given engine speed and load condition), we would generally treat it as a single-fuel engine. In this context, the combination of diesel fuel and natural gas would be its own fuel type. If the engine is designed to also operate on diesel fuel alone, we would generally treat it as a dual-fuel engine. If the engine is designed to operate on varying

mixtures of the two fuels, we would generally treat it as a flexible-fuel engine. To the extent that requirements vary for the different fuels or fuel mixtures, we may apply the more stringent requirements.

**§ 1036.605 GHG exemption for engines used in specialty vehicles.**

Engines certified to the alternative standards specified in 40 CFR 86.007–11 and 86.008–10 for use in specialty vehicles as described in 40 CFR 1037.605 are exempt from the standards of this part. See 40 CFR part 1037 for provisions that apply to the vehicle.

**§ 1036.610 Off-cycle technology credits and adjustments for reducing greenhouse gas emissions.**

(a) You may ask us to apply the provisions of this section for CO<sub>2</sub> emission reductions resulting from powertrain technologies that were not in common use with heavy-duty vehicles before model year 2010 that are not reflected in the specified test procedure. While you are not required to prove that such technologies were not in common use with heavy-duty vehicles before model year 2010, we will not approve your request if we determine that they do not qualify. We will apply these provisions only for technologies that will result in a measurable, demonstrable, and verifiable real-world

CO<sub>2</sub> reduction. Note that prior to model year 2016, these technologies were referred to as “innovative technologies”.

(b) The provisions of this section may be applied as either an improvement factor (used to adjust emission results) or as a separate credit, consistent with good engineering judgment. Note that the term “credit” in this section describes an additive adjustment to emission rates and is not equivalent to an emission credit in the ABT program of subpart H of this part. We recommend that you base your credit/adjustment on A to B testing of pairs of engines/vehicles differing only with respect to the technology in question.

(1) Calculate improvement factors as the ratio of in-use emissions with the technology divided by the in-use emissions without the technology. Adjust the emission results by multiplying by the improvement factor. Use the improvement-factor approach where good engineering judgment indicates that the actual benefit will be proportional to emissions measured over the test procedures specified in this part. For example, the benefits from technologies that reduce engine operation would generally be proportional to the engine’s emission rate.

(2) Calculate separate credits based on the difference between the in-use emission rate (g/ton-mile) with the technology and the in-use emission rate without the technology. Subtract this value from your measured emission result and use this adjusted value to determine your FEL. We may also allow you to calculate the credits based on g/hp-hr emission rates. Use the separate-credit approach where good engineering judgment indicates that the actual benefit will not be proportional to emissions measured over the test procedures specified in this part.

(3) We may require you to discount or otherwise adjust your improvement factor or credit to account for uncertainty or other relevant factors.

(c) Send your request to the Designated Compliance Officer. We recommend that you do not begin collecting test data (for submission to EPA) before contacting us. For technologies for which the vehicle manufacturer could also claim credits (such as transmissions in certain circumstances), we may require you to include a letter from the vehicle manufacturer stating that it will not seek credits for the same technology. Your request must contain the following items:

(1) A detailed description of the off-cycle technology and how it functions to reduce CO<sub>2</sub> emissions under

conditions not represented on the duty cycles required for certification.

(2) A list of the engine configurations that will be equipped with the technology.

(3) A detailed description and justification of the selected test engines.

(4) All testing and simulation data required under this section, plus any other data you have considered in your analysis. You may ask for our preliminary approval of your test plan under § 1036.210.

(5) A complete description of the methodology used to estimate the off-cycle benefit of the technology and all supporting data, including engine testing and in-use activity data. Also include a statement regarding your recommendation for applying the provisions of this section for the given technology as an improvement factor or a credit.

(6) An estimate of the off-cycle benefit by engine model, and the fleetwide benefit based on projected sales of engine models equipped with the technology.

(7) A demonstration of the in-use durability of the off-cycle technology, based on any available engineering analysis or durability testing data (either by testing components or whole engines).

(d) We may seek public comment on your request, consistent with the provisions of 40 CFR 86.1869–12(d). However, we will generally not seek public comment on credits/adjustments based on A to B engine dynamometer testing, chassis testing, or in-use testing.

(e) We may approve an improvement factor or credit for any configuration that is properly represented by your testing.

(1) For model years before 2021, you may continue to use an approved improvement factor or credit for any appropriate engine families in future model years through 2020.

(2) For model years 2021 and later, you may not rely on an approval for model years before 2021. You must separately request our approval before applying an improvement factor or credit under this section for 2021 and later engines, even if we approved an improvement factor or credit for similar engine models before model year 2021. Note that approvals for model year 2021 and later may carry over for multiple years.

#### **§ 1036.615 Engines with Rankine cycle waste heat recovery and hybrid powertrains.**

This section specifies how to generate advanced-technology emission credits for hybrid powertrains that include

energy storage systems and regenerative braking (including regenerative engine braking) and for engines that include Rankine-cycle (or other bottoming cycle) exhaust energy recovery systems. This section applies only for model year 2020 and earlier engines.

(a) *Pre-transmission hybrid powertrains.* Test pre-transmission hybrid powertrains with the hybrid engine test procedures of 40 CFR part 1065 or with the post-transmission test procedures in 40 CFR 1037.550. Pre-transmission hybrid powertrains are those engine systems that include features to recover and store energy during engine motoring operation but not from the vehicle’s wheels. Engines certified with pre-transmission hybrid powertrains must be certified to meet the diagnostic requirements of 40 CFR 86.018–10 with respect to powertrain components and systems; if different manufacturers produce the engine and the hybrid powertrain, the hybrid powertrain manufacturer may separately certify its powertrain relative to diagnostic requirements.

(b) *Rankine engines.* Test engines that include Rankine-cycle exhaust energy recovery systems according to the test procedures specified in subpart F of this part unless we approve alternate procedures.

(c) *Calculating credits.* Calculate credits as specified in subpart H of this part. Credits generated from engines and powertrains certified under this section may be used in other averaging sets as described in § 1036.740(c).

(d) *Off-cycle technologies.* You may certify using both the provisions of this section and the off-cycle technology provisions of § 1036.610, provided you do not double-count emission benefits.

#### **§ 1036.620 Alternate CO<sub>2</sub> standards based on model year 2011 compression-ignition engines.**

For model years 2014 through 2016, you may certify your compression-ignition engines to the CO<sub>2</sub> standards of this section instead of the CO<sub>2</sub> standards in § 1036.108. However, you may not certify engines to these alternate standards if they are part of an averaging set in which you carry a balance of banked credits. You may submit applications for certifications before using up banked credits in the averaging set, but such certificates will not become effective until you have used up (or retired) your banked credits in the averaging set. For purposes of this section, you are deemed to carry credits in an averaging set if you carry credits from advanced technology that are allowed to be used in that averaging set.

(a) The standards of this section are determined from the measured emission rate of the test engine of the applicable baseline 2011 engine family or families as described in paragraphs (b) and (c) of this section. Calculate the CO<sub>2</sub> emission rate of the baseline test engine using the same equations used for showing compliance with the otherwise applicable standard. The alternate CO<sub>2</sub> standard for light and medium heavy-duty vocational-certified engines (certified for CO<sub>2</sub> using the transient cycle) is equal to the baseline emission rate multiplied by 0.975. The alternate CO<sub>2</sub> standard for tractor-certified engines (certified for CO<sub>2</sub> using the ramped-modal cycle) and all other heavy heavy-duty engines is equal to the baseline emission rate multiplied by 0.970. The in-use FEL for these engines is equal to the alternate standard multiplied by 1.03.

(b) This paragraph (b) applies if you do not certify all your engine families in the averaging set to the alternate standards of this section. Identify separate baseline engine families for each engine family that you are certifying to the alternate standards of this section. For an engine family to be considered the baseline engine family, it must meet the following criteria:

(1) It must have been certified to all applicable emission standards in model year 2011. If the baseline engine was certified to a NO<sub>x</sub> FEL above the standard and incorporated the same emission control technologies as the new engine family, you may adjust the baseline CO<sub>2</sub> emission rate to be equivalent to an engine meeting the 0.20 g/hp-hr NO<sub>x</sub> standard (or your higher FEL as specified in this paragraph (b)(1)), using certification results from model years 2009 through 2011, consistent with good engineering judgment.

(i) Use the following equation to relate model year 2009–2011 NO<sub>x</sub> and CO<sub>2</sub> emission rates (g/hp-hr): CO<sub>2</sub> = a × log(NO<sub>x</sub>) + b.

(ii) For model year 2014–2016 engines certified to NO<sub>x</sub> FELs above 0.20 g/hp-hr, correct the baseline CO<sub>2</sub> emissions to the actual NO<sub>x</sub> FELs of the 2014–2016 engines.

(iii) Calculate separate adjustments for emissions over the ramped-modal cycle and the transient cycle.

(2) The baseline configuration tested for certification must have the same engine displacement as the engines in the engine family being certified to the alternate standards, and its rated power must be within five percent of the highest rated power in the engine family being certified to the alternate standards.

(3) The model year 2011 U.S.-directed production volume of the configuration tested must be at least one percent of the total 2011 U.S.-directed production volume for the engine family.

(4) The tested configuration must have cycle-weighted BSFC equivalent to or better than all other configurations in the engine family.

(c) This paragraph (c) applies if you certify all your engine families in the primary intended service class to the alternate standards of this section. For purposes of this section, you may combine light heavy-duty and medium heavy-duty engines into a single averaging set. Determine your baseline CO<sub>2</sub> emission rate as the production-weighted emission rate of the certified engine families you produced in the 2011 model year. If you produce engines for both tractors and vocational vehicles, treat them as separate averaging sets. Adjust the CO<sub>2</sub> emission rates to be equivalent to an engine meeting the average NO<sub>x</sub> FEL of new engines (assuming engines certified to the 0.20 g/hp-hr NO<sub>x</sub> standard have a NO<sub>x</sub> FEL equal to 0.20 g/hp-hr), as described in paragraph (b)(1) of this section.

(d) Include the following statement on the emission control information label: “THIS ENGINE WAS CERTIFIED TO AN ALTERNATE CO<sub>2</sub> STANDARD UNDER § 1036.620.”

(e) You may not bank CO<sub>2</sub> emission credits for any engine family in the same averaging set and model year in which you certify engines to the standards of this section. You may not bank any advanced-technology credits in any averaging set for the model year you certify under this section (since such credits would be available for use in this averaging set). Note that the provisions of § 1036.745 apply for deficits generated with respect to the standards of this section.

(f) You need our approval before you may certify engines under this section, especially with respect to the numerical value of the alternate standards. We will not approve your request if we determine that you manipulated your engine families or test engine configurations to certify to less stringent standards, or that you otherwise have not acted in good faith. You must keep and provide to us any information we need to determine that your engine families meet the requirements of this section. Keep these records for at least five years after you stop producing engines certified under this section.

#### § 1036.625 In-use compliance with family emission limits (FELs).

Section 1036.225 describes how to change the FEL for an engine family during the model year. This section, which describes how you may ask us to increase an engine family's FEL after the end of the model year, is intended to address circumstances in which it is in the public interest to apply a higher in-use FEL based on forfeiting an appropriate number of emission credits. For example, this may be appropriate where we determine that recalling vehicles would not significantly reduce in-use emissions. We will generally not allow this option where we determine the credits being forfeited would likely have expired.

(a) You may ask us to increase an engine family's FEL after the end of the model year if you believe some of your in-use engines exceed the CO<sub>2</sub> FEL that applied during the model year (or the CO<sub>2</sub> emission standard if the family did not generate or use emission credits). We may consider any available information in making our decision to approve or deny your request.

(b) If we approve your request under this section, you must apply emission credits to cover the increased FEL for all affected engines. Apply the emission credits as part of your credit demonstration for the current production year. Include the appropriate calculations in your final report under § 1036.730.

(c) Submit your request to the Designated Compliance Officer. Include the following in your request:

(1) Identify the names of each engine family that is the subject of your request. Include separate family names for different model years.

(2) Describe why your request does not apply for similar engine models or additional model years, as applicable.

(3) Identify the FEL(s) that applied during the model year and recommend a replacement FEL for in-use engines; include a supporting rationale to describe how you determined the recommended replacement FEL.

(4) Describe whether the needed emission credits will come from averaging, banking, or trading.

(d) If we approve your request, we will identify the replacement FEL. The value we select will reflect our best judgment to accurately reflect the actual in-use performance of your engines, consistent with the testing provisions specified in this part. We may apply the higher FELs to other engine families from the same or different model years to the extent they used equivalent emission controls. We may include any

appropriate conditions with our approval.

(e) If we order a recall for an engine family under 40 CFR 1068.505, we will no longer approve a replacement FEL under this section for any of your engines from that engine family, or from any other engine family that relies on equivalent emission controls.

**§ 1036.630 Certification of engine GHG emissions for powertrain testing.**

For engines included in powertrain families under 40 CFR part 1037, you may choose to include the corresponding engine emissions in your engine families under this part 1036 instead of (or in addition to) the otherwise applicable engine fuel maps.

(a) If you choose to certify powertrain fuel maps in an engine family, the declared powertrain emission levels become standards that apply for selective enforcement audits and in-use testing. We may require that you provide to us the engine test cycle (not normalized) corresponding to a given powertrain for each of the specified duty cycles.

(b) If you choose to certify only fuel map emissions for an engine family and to not certify emissions over powertrain test cycles under 40 CFR 1037.550, we will not presume you are responsible for emissions over the powertrain cycles. However, where we determine that you are responsible in whole or in part for the emission exceedance in such cases, we may require that you participate in any recall of the affected vehicles. Note that this provision to limit your responsibility does not apply if you also hold the certificate of conformity for the vehicle.

(c) If you split an engine family into subfamilies based on different fuel-mapping procedures as described in § 1036.230(e), the fuel-mapping procedures you identify for certifying each subfamily also apply for selective enforcement audits and in-use testing.

**Subpart H—Averaging, Banking, and Trading for Certification**

**§ 1036.701 General provisions.**

(a) You may average, bank, and trade (ABT) emission credits for purposes of certification as described in this subpart and in subpart B of this part to show compliance with the standards of § 1036.108. Participation in this program is voluntary. (Note: As described in subpart B of this part, you must assign an FCL to all engine families, whether or not they participate in the ABT provisions of this subpart.)

(b) The definitions of subpart I of this part apply to this subpart in addition to the following definitions:

(1) *Actual emission credits* means emission credits you have generated that we have verified by reviewing your final report.

(2) *Averaging set* means a set of engines in which emission credits may be exchanged. See § 1036.740.

(3) *Broker* means any entity that facilitates a trade of emission credits between a buyer and seller.

(4) *Buyer* means the entity that receives emission credits as a result of a trade.

(5) *Reserved emission credits* means emission credits you have generated that we have not yet verified by reviewing your final report.

(6) *Seller* means the entity that provides emission credits during a trade.

(7) *Standard* means the emission standard that applies under subpart B of this part for engines not participating in the ABT program of this subpart.

(8) *Trade* means to exchange emission credits, either as a buyer or seller.

(c) Emission credits may be exchanged only within an averaging set, except as specified in § 1036.740.

(d) You may not use emission credits generated under this subpart to offset any emissions that exceed an FCL or standard. This applies for all testing, including certification testing, in-use testing, selective enforcement audits, and other production-line testing. However, if emissions from an engine exceed an FCL or standard (for example, during a selective enforcement audit), you may use emission credits to recertify the engine family with a higher FCL that applies only to future production.

(e) You may use either of the following approaches to retire or forego emission credits:

(1) You may retire emission credits generated from any number of your engines. This may be considered donating emission credits to the environment. Identify any such credits in the reports described in § 1036.730. Engines must comply with the applicable FELs even if you donate or sell the corresponding emission credits under this paragraph (h). Those credits may no longer be used by anyone to demonstrate compliance with any EPA emission standards.

(2) You may certify an engine family using an FEL (FCL for CO<sub>2</sub>) below the emission standard as described in this part and choose not to generate emission credits for that family. If you do this, you do not need to calculate emission credits for those engine families and you do not need to submit or keep the associated records described in this subpart for that family.

(f) Emission credits may be used in the model year they are generated. Surplus emission credits may be banked for future model years. Surplus emission credits may sometimes be used for past model years, as described in § 1036.745.

(g) You may increase or decrease an FCL during the model year by amending your application for certification under § 1036.225. The new FCL may apply only to engines you have not already introduced into commerce.

(h) See § 1036.740 for special credit provisions that apply for greenhouse gas credits generated under 40 CFR 86.1819–14(k)(7) or § 1036.615 or 40 CFR 1037.615.

(i) Unless the regulations explicitly allow it, you may not calculate credits more than once for any emission reduction. For example, if you generate CO<sub>2</sub> emission credits for a hybrid engine under this part for a given vehicle, no one may generate CO<sub>2</sub> emission credits for that same hybrid engine and vehicle under 40 CFR part 1037. However, credits could be generated for identical vehicles using engines that did not generate credits under this part.

(j) Credits you generate with compression-ignition engines in 2020 and earlier model years may be used in model year 2021 and later only if the credit-generating engines were certified to the tractor engine standards in § 1036.108 and credits were calculated relative to the tractor engine standards. You may otherwise use emission credits generated in one model year without adjustment for certifying vehicles in a later model year, even if emission standards are different.

(k) Engine families you certify with a nonconformance penalty under 40 CFR part 86, subpart L, may not generate emission credits.

**§ 1036.705 Generating and calculating emission credits.**

(a) The provisions of this section apply separately for calculating emission credits for each pollutant.

(b) For each participating family, calculate positive or negative emission credits relative to the otherwise applicable emission standard based on the engine family's FCL for greenhouse gases. If your engine family is certified to both the vocational and tractor engine standards, calculate credits separately for the vocational engines and the tractor engines (as specified in paragraph (b)(3) of this section). Calculate positive emission credits for a family that has an FCL below the standard. Calculate negative emission credits for a family that has an FCL above the standard. Sum your positive

and negative credits for the model year before rounding. Round the sum of emission credits to the nearest megagram (Mg), using consistent units throughout the following equations:

(1) For vocational engines:

$$\text{Emission credits (Mg)} = (\text{Std} - \text{FCL}) \cdot (\text{CF}) \cdot (\text{Volume}) \cdot (\text{UL}) \cdot (10^{-6})$$

Where:

Std = the emission standard, in g/hp-hr, that applies under subpart B of this part for engines not participating in the ABT program of this subpart (the "otherwise applicable standard").

FCL = the Family Certification Level for the engine family, in g/hp-hr, measured over the transient duty cycle, rounded to the same number of decimal places as the emission standard.

CF = a transient cycle conversion factor (hp-hr/mile), calculated by dividing the total (integrated) horsepower-hour over the duty cycle (average of vocational engine configurations weighted by their production volumes) by 6.3 miles for engines subject to spark-ignition standards and 6.5 miles for engines subject to compression-ignition. This represents the average work performed by vocational engines in the family over the mileage represented by operation over the duty cycle.

Volume = the number of vocational engines eligible to participate in the averaging, banking, and trading program within the given engine family during the model year, as described in paragraph (c) of this section.

UL = the useful life for the given engine family, in miles.

(2) For tractor engines:

$$\text{Emission credits (Mg)} = (\text{Std} - \text{FCL}) \cdot (\text{CF}) \cdot (\text{Volume}) \cdot (\text{UL}) \cdot (10^{-6})$$

Where:

Std = the emission standard, in g/hp-hr, that applies under subpart B of this part for engines not participating in the ABT program of this subpart (the "otherwise applicable standard").

FCL = the Family Certification Level for the engine family, in g/hp-hr, measured over the ramped-modal cycle rounded to the same number of decimal places as the emission standard.

CF = a transient cycle conversion factor (hp-hr/mile), calculated by dividing the total (integrated) horsepower-hour over the duty cycle (average of tractor-engine configurations weighted by their production volumes) by 6.3 miles for engines subject to spark-ignition standards and 6.5 miles for engines subject to compression-ignition standards. This represents the average work performed by tractor engines in the family over the mileage represented by operation over the duty cycle. Note that this calculation requires you to use the transient cycle conversion factor even for engines certified to standards based on the ramped-modal cycle.

Volume = the number of tractor engines eligible to participate in the averaging,

banking, and trading program within the given engine family during the model year, as described in paragraph (c) of this section.

UL = the useful life for the given engine family, in miles.

(3) For engine families certified to both the vocational and tractor engine standards, we may allow you to use statistical methods to estimate the total production volumes where a small fraction of the engines cannot be tracked precisely.

(4) You may not generate emission credits for tractor engines (*i.e.*, engines not certified to the transient cycle for CO<sub>2</sub>) installed in vocational vehicles (including vocational tractors certified under 40 CFR 1037.630 or exempted under 40 CFR 1037.631). We will waive this provision where you demonstrate that less than five percent of the engines in your tractor family were installed in vocational vehicles. For example, if you know that 96 percent of your tractor engines were installed in non-vocational tractors, but cannot determine the vehicle type for the remaining four percent, you may generate credits for all the engines in the family.

(5) You may generate CO<sub>2</sub> emission credits from a model year 2021 or later medium heavy-duty engine family subject to spark-ignition standards for exchanging with other engine families only if the engines in the family are gasoline-fueled. You may generate CO<sub>2</sub> credits from these engine families only for the purpose of offsetting CH<sub>4</sub> and/or N<sub>2</sub>O emissions within the same engine family as described in paragraph (d) of this section.

(c) As described in § 1036.730, compliance with the requirements of this subpart is determined at the end of the model year based on actual U.S.-directed production volumes. Keep appropriate records to document these production volumes. Do not include any of the following engines to calculate emission credits:

(1) Engines that you do not certify to the CO<sub>2</sub> standards of this part because they are permanently exempted under subpart G of this part or under 40 CFR part 1068.

(2) Exported engines.

(3) Engines not subject to the requirements of this part, such as those excluded under § 1036.5. For example, do not include engines used in vehicles certified to the greenhouse gas standards of 40 CFR 86.1819.

(4) Any other engines if we indicate elsewhere in this part 1036 that they are not to be included in the calculations of this subpart.

(d) You may use CO<sub>2</sub> emission credits to show compliance with CH<sub>4</sub> and/or

N<sub>2</sub>O FELs instead of the otherwise applicable emission standards. To do this, calculate the CH<sub>4</sub> and/or N<sub>2</sub>O emission credits needed (negative credits) using the equation in paragraph (b) of this section, using the FEL(s) you specify for your engines during certification instead of the FCL. You must use 34 Mg of positive CO<sub>2</sub> credits to offset 1 Mg of negative CH<sub>4</sub> credits for model year 2021 and later engines, and you must use 25 Mg of positive CO<sub>2</sub> credits to offset 1 Mg of negative CH<sub>4</sub> credits for earlier engines. You must use 298 Mg of positive CO<sub>2</sub> credits to offset 1 Mg of negative N<sub>2</sub>O credits.

#### § 1036.710 Averaging.

(a) Averaging is the exchange of emission credits among your engine families. You may average emission credits only within the same averaging set, except as specified in § 1036.740.

(b) You may certify one or more engine families to an FCL above the applicable standard, subject to any applicable FEL caps and other the provisions in subpart B of this part, if you show in your application for certification that your projected balance of all emission-credit transactions in that model year is greater than or equal to zero, or that a negative balance is allowed under § 1036.745.

(c) If you certify an engine family to an FCL that exceeds the otherwise applicable standard, you must obtain enough emission credits to offset the engine family's deficit by the due date for the final report required in § 1036.730. The emission credits used to address the deficit may come from your other engine families that generate emission credits in the same model year (or from later model years as specified in § 1036.745), from emission credits you have banked, or from emission credits you obtain through trading.

#### § 1036.715 Banking.

(a) Banking is the retention of surplus emission credits by the manufacturer generating the emission credits for use in future model years for averaging or trading.

(b) You may designate any emission credits you plan to bank in the reports you submit under § 1036.730 as reserved credits. During the model year and before the due date for the final report, you may designate your reserved emission credits for averaging or trading.

(c) Reserved credits become actual emission credits when you submit your final report. However, we may revoke these emission credits if we are unable to verify them after reviewing your reports or auditing your records.

(d) Banked credits retain the designation of the averaging set in which they were generated.

#### **§ 1036.720 Trading.**

(a) Trading is the exchange of emission credits between manufacturers. You may use traded emission credits for averaging, banking, or further trading transactions. Traded emission credits remain subject to the averaging-set restrictions based on the averaging set in which they were generated.

(b) You may trade actual emission credits as described in this subpart. You may also trade reserved emission credits, but we may revoke these emission credits based on our review of your records or reports or those of the company with which you traded emission credits. You may trade banked credits within an averaging set to any certifying manufacturer.

(c) If a negative emission credit balance results from a transaction, both the buyer and seller are liable, except in cases we deem to involve fraud. See § 1036.255(e) for cases involving fraud. We may void the certificates of all engine families participating in a trade that results in a manufacturer having a negative balance of emission credits. See § 1036.745.

#### **§ 1036.725 What must I include in my application for certification?**

(a) You must declare in your application for certification your intent to use the provisions of this subpart for each engine family that will be certified using the ABT program. You must also declare the FELs/FCL you select for the engine family for each pollutant for which you are using the ABT program. Your FELs must comply with the specifications of subpart B of this part, including the FEL caps. FELs/FCLs must be expressed to the same number of decimal places as the applicable standards.

(b) Include the following in your application for certification:

(1) A statement that, to the best of your belief, you will not have a negative balance of emission credits for any averaging set when all emission credits are calculated at the end of the year; or a statement that you will have a negative balance of emission credits for one or more averaging sets, but that it is allowed under § 1036.745.

(2) Detailed calculations of projected emission credits (positive or negative) based on projected U.S.-directed production volumes. We may require you to include similar calculations from your other engine families to project your net credit balances for the model

year. If you project negative emission credits for a family, state the source of positive emission credits you expect to use to offset the negative emission credits.

#### **§ 1036.730 ABT reports.**

(a) If any of your engine families are certified using the ABT provisions of this subpart, you must send an end-of-year report by March 31 following the end of the model year and a final report by September 30 following the end of the model year. We may waive the requirement to send an end-of-year report.

(b) Your end-of-year and final reports must include the following information for each engine family participating in the ABT program:

(1) Engine-family designation and averaging set.

(2) The emission standards that would otherwise apply to the engine family.

(3) The FCL for each pollutant. If you change the FCL after the start of production, identify the date that you started using the new FCL and/or give the engine identification number for the first engine covered by the new FCL. In this case, identify each applicable FCL and calculate the positive or negative emission credits as specified in § 1036.225.

(4) The projected and actual U.S.-directed production volumes for the model year. If you changed an FCL during the model year, identify the actual production volume associated with each FCL.

(5) The transient cycle conversion factor for each engine configuration as described in § 1036.705.

(6) Useful life.

(7) Calculated positive or negative emission credits for the whole engine family. Identify any emission credits that you traded, as described in paragraph (d)(1) of this section.

(c) Your end-of-year and final reports must include the following additional information:

(1) Show that your net balance of emission credits from all your participating engine families in each averaging set in the applicable model year is not negative, except as allowed under § 1036.745. Your credit tracking must account for the limitation on credit life under § 1036.740(d).

(2) State whether you will reserve any emission credits for banking.

(3) State that the report's contents are accurate.

(d) If you trade emission credits, you must send us a report within 90 days after the transaction, as follows:

(1) As the seller, you must include the following information in your report:

(i) The corporate names of the buyer and any brokers.

(ii) A copy of any contracts related to the trade.

(iii) The averaging set corresponding to the engine families that generated emission credits for the trade, including the number of emission credits from each averaging set.

(2) As the buyer, you must include the following information in your report:

(i) The corporate names of the seller and any brokers.

(ii) A copy of any contracts related to the trade.

(iii) How you intend to use the emission credits, including the number of emission credits you intend to apply for each averaging set.

(e) Send your reports electronically to the Designated Compliance Officer using an approved information format.

If you want to use a different format, send us a written request with justification for a waiver.

(f) Correct errors in your end-of-year or final report as follows:

(1) You may correct any errors in your end-of-year report when you prepare the final report, as long as you send us the final report by the time it is due.

(2) If you or we determine within 270 days after the end of the model year that errors mistakenly decreased your balance of emission credits, you may correct the errors and recalculate the balance of emission credits. You may not make these corrections for errors that are determined more than 270 days after the end of the model year. If you report a negative balance of emission credits, we may disallow corrections under this paragraph (f)(2).

(3) If you or we determine any time that errors mistakenly increased your balance of emission credits, you must correct the errors and recalculate the balance of emission credits.

#### **§ 1036.735 Recordkeeping.**

(a) You must organize and maintain your records as described in this section. We may review your records at any time.

(b) Keep the records required by this section for at least eight years after the due date for the end-of-year report. You may not use emission credits for any engines if you do not keep all the records required under this section. You must therefore keep these records to continue to bank valid credits. Store these records in any format and on any media, as long as you can promptly send us organized, written records in English if we ask for them. You must keep these records readily available. We may review them at any time.

(c) Keep a copy of the reports we require in §§ 1036.725 and 1036.730.

(d) Keep records of the engine identification number (usually the serial number) for each engine you produce that generates or uses emission credits under the ABT program. You may identify these numbers as a range. If you change the FEL after the start of production, identify the date you started using each FCL and the range of engine identification numbers associated with each FCL. You must also identify the purchaser and destination for each engine you produce to the extent this information is available.

(e) We may require you to keep additional records or to send us relevant information not required by this section in accordance with the Clean Air Act.

**§ 1036.740 Restrictions for using emission credits.**

The following restrictions apply for using emission credits:

(a) *Averaging sets.* Except as specified in paragraph (c) of this section, emission credits may be exchanged only within the following averaging sets:

(1) Engines subject to spark-ignition standards.

(2) Light heavy-duty engines subject to compression-ignition standards.

(3) Medium heavy-duty engines subject to compression-ignition standards.

(4) Heavy heavy-duty engines.

(b) *Applying credits to prior year deficits.* Where your credit balance for the previous year is negative, you may apply credits to that credit deficit only after meeting your credit obligations for the current year.

(c) *Credits from hybrid engines and other advanced technologies.* Credits you generate under § 1036.615 may be used for any of the averaging sets identified in paragraph (a) of this section; you may also use those credits to demonstrate compliance with the CO<sub>2</sub> emission standards in 40 CFR 86.1819 and 40 CFR part 1037. Similarly, you may use Phase 1 advanced-technology credits generated under 40 CFR 86.1819–14(k)(7) or 40 CFR 1037.615 to demonstrate compliance with the CO<sub>2</sub> standards in this part. In the case of engines subject to spark-ignition standards and compression-ignition light heavy-duty engines, you may not use more than 60,000 Mg of credits from other averaging sets in any model year.

(1) The maximum amount of CO<sub>2</sub> credits you may bring into the following service class groups is 60,000 Mg per model year:

(i) Engines subject to spark-ignition standards, light heavy-duty compression-ignition engines, and light heavy-duty vehicles. This group comprises the averaging sets listed in

paragraphs (a)(1) and (2) of this section and the averaging set listed in 40 CFR 1037.740(a)(1).

(ii) Medium heavy-duty engines subject to compression-ignition standards and medium heavy-duty vehicles. This group comprises the averaging sets listed in paragraph (a)(3) of this section and 40 CFR 1037.740(a)(2).

(iii) Heavy heavy-duty engines subject to compression-ignition standards and heavy heavy-duty vehicles. This group comprises the averaging sets listed in paragraph (a)(4) of this section and 40 CFR 1037.740(a)(3).

(2) Paragraph (c)(1) of this section does not limit the advanced-technology credits that can be used within a service class group if they were generated in that same service class group.

(d) *Credit life.* Credits may be used only for five model years after the year in which they are generated. For example, credits you generate in model year 2018 may be used to demonstrate compliance with emission standards only through model year 2023.

(e) *Other restrictions.* Other sections of this part specify additional restrictions for using emission credits under certain special provisions.

**§ 1036.745 End-of-year CO<sub>2</sub> credit deficits.**

Except as allowed by this section, we may void the certificate of any engine family certified to an FCL above the applicable standard for which you do not have sufficient credits by the deadline for submitting the final report.

(a) Your certificate for an engine family for which you do not have sufficient CO<sub>2</sub> credits will not be void if you remedy the deficit with surplus credits within three model years. For example, if you have a credit deficit of 500 Mg for an engine family at the end of model year 2015, you must generate (or otherwise obtain) a surplus of at least 500 Mg in that same averaging set by the end of model year 2018.

(b) You may not bank or trade away CO<sub>2</sub> credits in the averaging set in any model year in which you have a deficit.

(c) You may apply only surplus credits to your deficit. You may not apply credits to a deficit from an earlier model year if they were generated in a model year for which any of your engine families for that averaging set had an end-of-year credit deficit.

(d) You must notify us in writing how you plan to eliminate the credit deficit within the specified time frame. If we determine that your plan is unreasonable or unrealistic, we may deny an application for certification for a vehicle family if its FEL would increase your credit deficit. We may

determine that your plan is unreasonable or unrealistic based on a consideration of past and projected use of specific technologies, the historical sales mix of your vehicle models, your commitment to limit production of higher-emission vehicles, and expected access to traded credits. We may also consider your plan unreasonable if your credit deficit increases from one model year to the next. We may require that you send us interim reports describing your progress toward resolving your credit deficit over the course of a model year.

(e) If you do not remedy the deficit with surplus credits within three model years, we may void your certificate for that engine family. We may void the certificate based on your end-of-year report. Note that voiding a certificate applies *ab initio*. Where the net deficit is less than the total amount of negative credits originally generated by the family, we will void the certificate only with respect to the number of engines needed to reach the amount of the net deficit. For example, if the original engine family generated 500 Mg of negative credits, and the manufacturer's net deficit after three years was 250 Mg, we would void the certificate with respect to half of the engines in the family.

(f) For purposes of calculating the statute of limitations, the following actions are all considered to occur at the expiration of the deadline for offsetting a deficit as specified in paragraph (a) of this section:

(1) Failing to meet the requirements of paragraph (a) of this section.

(2) Failing to satisfy the conditions upon which a certificate was issued relative to offsetting a deficit.

(3) Selling, offering for sale, introducing or delivering into U.S. commerce, or importing vehicles that are found not to be covered by a certificate as a result of failing to offset a deficit.

**§ 1036.750 What can happen if I do not comply with the provisions of this subpart?**

(a) For each engine family participating in the ABT program, the certificate of conformity is conditioned upon full compliance with the provisions of this subpart during and after the model year. You are responsible to establish to our satisfaction that you fully comply with applicable requirements. We may void the certificate of conformity for an engine family if you fail to comply with any provisions of this subpart.

(b) You may certify your engine family to an FCL above an applicable standard based on a projection that you



will have enough emission credits to offset the deficit for the engine family. See § 1036.745 for provisions specifying what happens if you cannot show in your final report that you have enough actual emission credits to offset a deficit for any pollutant in an engine family.

(c) We may void the certificate of conformity for an engine family if you fail to keep records, send reports, or give us information we request. Note that failing to keep records, send reports, or give us information we request is also a violation of 42 U.S.C. 7522(a)(2).

(d) You may ask for a hearing if we void your certificate under this section (see § 1036.820).

#### **§ 1036.755 Information provided to the Department of Transportation.**

After receipt of each manufacturer's final report as specified in § 1036.730 and completion of any verification testing required to validate the manufacturer's submitted final data, we will issue a report to the Department of Transportation with CO<sub>2</sub> emission information and will verify the accuracy of each manufacturer's equivalent fuel consumption data that required by NHTSA under 49 CFR 535.8. We will send a report to DOT for each engine manufacturer based on each regulatory category and subcategory, including sufficient information for NHTSA to determine fuel consumption and associated credit values. See 49 CFR 535.8 to determine if NHTSA deems submission of this information to EPA to also be a submission to NHTSA.

#### **Subpart I—Definitions and Other Reference Information**

##### **§ 1036.801 Definitions.**

The following definitions apply to this part. The definitions apply to all subparts unless we note otherwise. All undefined terms have the meaning the Act gives to them. The definitions follow:

*Act* means the Clean Air Act, as amended, 42 U.S.C. 7401–7671q.

*Adjustable parameter* has the meaning given in 40 CFR part 86.

*Advanced technology* means technology certified under 40 CFR 86.1819–14(k)(7), § 1036.615, or 40 CFR 1037.615.

*Aftertreatment* means relating to a catalytic converter, particulate filter, or any other system, component, or technology mounted downstream of the exhaust valve (or exhaust port) whose design function is to decrease emissions in the engine exhaust before it is exhausted to the environment. Exhaust gas recirculation (EGR) and turbochargers are not aftertreatment.

*Aircraft* means any vehicle capable of sustained air travel more than 100 feet above the ground.

*Alcohol-fueled engine* mean an engine that is designed to run using an alcohol fuel. For purposes of this definition, alcohol fuels do not include fuels with a nominal alcohol content below 25 percent by volume.

*Auxiliary emission control device* means any element of design that senses temperature, motive speed, engine rpm, transmission gear, or any other parameter for the purpose of activating, modulating, delaying, or deactivating the operation of any part of the emission control system.

*Averaging set* has the meaning given in § 1036.740.

*Calibration* means the set of specifications and tolerances specific to a particular design, version, or application of a component or assembly capable of functionally describing its operation over its working range.

*Carryover* means relating to certification based on emission data generated from an earlier model year as described in § 1036.235(d).

*Certification* means relating to the process of obtaining a certificate of conformity for an engine family that complies with the emission standards and requirements in this part.

*Certified emission level* means the highest deteriorated emission level in an engine family for a given pollutant from the applicable transient and/or steady-state testing, rounded to the same number of decimal places as the applicable standard. Note that you may have two certified emission levels for CO<sub>2</sub> if you certify a family for both vocational and tractor use.

*Complete vehicle* means a vehicle meeting the definition of complete vehicle in 40 CFR 1037.801 when it is first sold as a vehicle. For example, where a vehicle manufacturer sells an incomplete vehicle to a secondary vehicle manufacturer, the vehicle is not a complete vehicle under this part, even after its final assembly.

*Compression-ignition* means relating to a type of reciprocating, internal-combustion engine that is not a spark-ignition engine. Note that § 1036.1 also deems gas turbine engines and other engines to be compression-ignition engines.

*Crankcase emissions* means airborne substances emitted to the atmosphere from any part of the engine crankcase's ventilation or lubrication systems. The crankcase is the housing for the crankshaft and other related internal parts.

*Criteria pollutants* means emissions of NO<sub>x</sub>, HC, PM, and CO. Note that these

pollutants are also sometimes described collectively as “non-greenhouse gas pollutants”, although they do not necessarily have negligible global warming potentials.

*Designated Compliance Officer* means one of the following:

(1) For engines subject to compression-ignition standards, *Designated Compliance Officer* means Director, Diesel Engine Compliance Center, U.S. Environmental Protection Agency, 2000 Traverwood Drive, Ann Arbor, MI 48105; *complianceinfo@epa.gov*; *epa.gov/otaq/verify*.

(2) For engines subject to spark-ignition standards, *Designated Compliance Officer* means Director, Gasoline Engine Compliance Center, U.S. Environmental Protection Agency, 2000 Traverwood Drive, Ann Arbor, MI 48105; *nonroad-si-cert@epa.gov*; *epa.gov/otaq/verify*.

*Deteriorated emission level* means the emission level that results from applying the appropriate deterioration factor to the official emission result of the emission-data engine. Note that where no deterioration factor applies, references in this part to the *deteriorated emission level* mean the official emission result.

*Deterioration factor* means the relationship between emissions at the end of useful life (or point of highest emissions if it occurs before the end of useful life) and emissions at the low-hour/low-mileage test point, expressed in one of the following ways:

(1) For multiplicative deterioration factors, the ratio of emissions at the end of useful life (or point of highest emissions) to emissions at the low-hour test point.

(2) For additive deterioration factors, the difference between emissions at the end of useful life (or point of highest emissions) and emissions at the low-hour test point.

*Diesel exhaust fluid (DEF)* means a liquid reducing agent (other than the engine fuel) used in conjunction with selective catalytic reduction to reduce NO<sub>x</sub> emissions. *Diesel exhaust fluid* is generally understood to be an aqueous solution of urea conforming to the specifications of ISO 22241.

*Dual-fuel* means relating to an engine designed for operation on two different types of fuel but not on a continuous mixture of those fuels (see § 1036.601(d)). For purposes of this part, such an engine remains a dual-fuel engine even if it is designed for operation on three or more different fuels.

*Emission control system* means any device, system, or element of design that



controls or reduces the emissions of regulated pollutants from an engine.

*Emission-data engine* means an engine that is tested for certification. This includes engines tested to establish deterioration factors.

*Emission-related maintenance* means maintenance that substantially affects emissions or is likely to substantially affect emission deterioration.

*Engine configuration* means a unique combination of engine hardware and calibration (related to the emission standards) within an engine family. Engines within a single engine configuration differ only with respect to normal production variability or factors unrelated to compliance with emission standards.

*Engine family* has the meaning given in § 1036.230.

*Excluded* means relating to engines that are not subject to some or all of the requirements of this part as follows:

(1) An engine that has been determined not to be a heavy-duty engine is excluded from this part.

(2) Certain heavy-duty engines are excluded from the requirements of this part under § 1036.5.

(3) Specific regulatory provisions of this part may exclude a heavy-duty engine generally subject to this part from one or more specific standards or requirements of this part.

*Exempted* has the meaning given in 40 CFR 1068.30.

*Exhaust gas recirculation* means a technology that reduces emissions by routing exhaust gases that had been exhausted from the combustion chamber(s) back into the engine to be mixed with incoming air before or during combustion. The use of valve timing to increase the amount of residual exhaust gas in the combustion chamber(s) that is mixed with incoming air before or during combustion is not considered exhaust gas recirculation for the purposes of this part.

*Family certification level (FCL)* means a CO<sub>2</sub> emission level declared by the manufacturer that is at or above emission test results for all emission-data engines. The FCL serves as the emission standard for the engine family with respect to certification testing if it is different than the otherwise applicable standard. The FCL must be expressed to the same number of decimal places as the emission standard it replaces.

*Family emission limit (FEL)* means an emission level declared by the manufacturer to serve in place of an otherwise applicable emission standard (other than CO<sub>2</sub> standards) under the ABT program in subpart H of this part. The FEL must be expressed to the same

number of decimal places as the emission standard it replaces. The FEL serves as the emission standard for the engine family with respect to all required testing except certification testing for CO<sub>2</sub>. The CO<sub>2</sub> FEL is equal to the CO<sub>2</sub> FCL multiplied by 1.03 and rounded to the same number of decimal places as the standard (e.g., the nearest whole g/hp-hr for the 2016 CO<sub>2</sub> standards).

*Flexible-fuel* means relating to an engine designed for operation on any mixture of two or more different types of fuels (see § 1036.601(d)).

*Fuel type* means a general category of fuels such as diesel fuel, gasoline, or natural gas. There can be multiple grades within a single fuel type, such as premium gasoline, regular gasoline, or gasoline with 10 percent ethanol.

*Good engineering judgment* has the meaning given in 40 CFR 1068.30. See 40 CFR 1068.5 for the administrative process we use to evaluate good engineering judgment.

*Greenhouse gas* means one or more compounds regulated under this part based primarily on their impact on the climate. This generally includes CO<sub>2</sub>, CH<sub>4</sub>, and N<sub>2</sub>O.

*Greenhouse gas Emissions Model (GEM)* means the GEM simulation tool described in 40 CFR 1037.520. Note that an updated version of GEM applies starting in model year 2021.

*Gross vehicle weight rating (GVWR)* means the value specified by the vehicle manufacturer as the maximum design loaded weight of a single vehicle, consistent with good engineering judgment.

*Heavy-duty engine* means any engine which the engine manufacturer could reasonably expect to be used for motive power in a heavy-duty vehicle. For purposes of this definition in this part, the term "engine" includes internal combustion engines and other devices that convert chemical fuel into motive power. For example, a fuel cell or a gas turbine used in a heavy-duty vehicle is a heavy-duty engine.

*Heavy-duty vehicle* means any motor vehicle above 8,500 pounds GVWR or that has a vehicle curb weight above 6,000 pounds or that has a basic vehicle frontal area greater than 45 square feet. *Curb weight* and *Basic vehicle frontal area* have the meaning given in 40 CFR 86.1803.

*Hybrid* means relating to an engine or powertrain that includes energy storage features other than a conventional battery system or conventional flywheel. Supplemental electrical batteries and hydraulic accumulators are examples of hybrid energy storage systems. Note that certain provisions in this part treat

hybrid engines and powertrains intended for vehicles that include regenerative braking different than those intended for vehicles that do not include regenerative braking.

*Hydrocarbon (HC)* means the hydrocarbon group on which the emission standards are based for each fuel type. For alcohol-fueled engines, HC means nonmethane hydrocarbon equivalent (NMHCE). For all other engines, HC means nonmethane hydrocarbon (NMHC).

*Identification number* means a unique specification (for example, a model number/serial number combination) that allows someone to distinguish a particular engine from other similar engines.

*Incomplete vehicle* means a vehicle meeting the definition of incomplete vehicle in 40 CFR 1037.801 when it is first sold (or otherwise delivered to another entity) as a vehicle.

*Innovative technology* means technology certified under § 1036.610 (also described as "off-cycle technology").

*Liquefied petroleum gas (LPG)* means a liquid hydrocarbon fuel that is stored under pressure and is composed primarily of nonmethane compounds that are gases at atmospheric conditions. Note that, although this commercial term includes the word "petroleum", LPG is not considered to be a petroleum fuel under the definitions of this section.

*Low-hour* means relating to an engine that has stabilized emissions and represents the undeteriorated emission level. This would generally involve less than 125 hours of operation.

*Manufacture* means the physical and engineering process of designing, constructing, and/or assembling a heavy-duty engine or a heavy-duty vehicle.

*Manufacturer* has the meaning given in section 216(1) of the Act. In general, this term includes any person who manufactures or assembles an engine, vehicle, or piece of equipment for sale in the United States or otherwise introduces a new engine into commerce in the United States. This includes importers who import engines or vehicles for resale.

*Medium-duty passenger vehicle* has the meaning given in 40 CFR 86.1803.

*Model year* means the manufacturer's annual new model production period, except as restricted under this definition. It must include January 1 of the calendar year for which the model year is named, may not begin before January 2 of the previous calendar year, and it must end by December 31 of the named calendar year. Manufacturers

may not adjust model years to circumvent or delay compliance with emission standards or to avoid the obligation to certify annually.

*Motor vehicle* has the meaning given in 40 CFR 85.1703.

*Natural gas* means a fuel whose primary constituent is methane.

*New motor vehicle engine* has the meaning given in the Act. This generally means a motor vehicle engine meeting the criteria of either paragraph (1), (2), or (3) of this definition.

(1) A motor vehicle engine for which the ultimate purchaser has never received the equitable or legal title is a *new motor vehicle engine*. This kind of engine might commonly be thought of as “brand new” although a *new motor vehicle engine* may include previously used parts. Under this definition, the engine is new from the time it is produced until the ultimate purchaser receives the title or places it into service, whichever comes first.

(2) An imported motor vehicle engine is a *new motor vehicle engine* if it was originally built on or after January 1, 1970.

(3) Any motor vehicle engine installed in a new motor vehicle.

*Noncompliant engine* means an engine that was originally covered by a certificate of conformity, but is not in the certified configuration or otherwise does not comply with the conditions of the certificate.

*Nonconforming engine* means an engine not covered by a certificate of conformity that would otherwise be subject to emission standards.

*Nonmethane hydrocarbon (NMHC)* means the sum of all hydrocarbon species except methane, as measured according to 40 CFR part 1065.

*Nonmethane hydrocarbon equivalent (NMHCE)* has the meaning given in 40 CFR 1065.1001.

*Off-cycle technology* means technology certified under § 1036.610 (also described as “innovative technology”).

*Official emission result* means the measured emission rate for an emission-data engine on a given duty cycle before the application of any deterioration factor, but after the applicability of any required regeneration or other adjustment factors.

*Owners manual* means a document or collection of documents prepared by the engine or vehicle manufacturer for the owner or operator to describe appropriate engine maintenance, applicable warranties, and any other information related to operating or keeping the engine. The owners manual is typically provided to the ultimate purchaser at the time of sale. The

owners manual may be in paper or electronic format.

*Oxides of nitrogen* has the meaning given in 40 CFR 1065.1001.

*Percent* has the meaning given in 40 CFR 1065.1001. Note that this means percentages identified in this part are assumed to be infinitely precise without regard to the number of significant figures. For example, one percent of 1,493 is 14.93.

*Placed into service* means put into initial use for its intended purpose, excluding incidental use by the manufacturer or a dealer.

*Preliminary approval* means approval granted by an authorized EPA representative prior to submission of an application for certification, consistent with the provisions of § 1036.210.

*Primary intended service class* has the meaning given in § 1036.140.

*Rechargeable Energy Storage System (RESS)* means the component(s) of a hybrid engine or vehicle that store recovered energy for later use, such as the battery system in an electric hybrid vehicle.

*Relating to* as used in this section means relating to something in a specific, direct manner. This expression is used in this section only to define terms as adjectives and not to broaden the meaning of the terms.

*Revoke* has the meaning given in 40 CFR 1068.30.

*Round* has the meaning given in 40 CFR 1065.1001.

*Scheduled maintenance* means adjusting, repairing, removing, disassembling, cleaning, or replacing components or systems periodically to keep a part or system from failing, malfunctioning, or wearing prematurely. It also may mean actions you expect are necessary to correct an overt indication of failure or malfunction for which periodic maintenance is not appropriate.

*Small manufacturer* means a manufacturer meeting the criteria specified in 13 CFR 121.201. The employee and revenue limits apply to the total number of employees and total revenue together for affiliated companies. Note that manufacturers with low production volumes may or may not be “small manufacturers”.

*Spark-ignition* means relating to a gasoline-fueled engine or any other type of engine with a spark plug (or other sparking device) and with operating characteristics significantly similar to the theoretical Otto combustion cycle. Spark-ignition engines usually use a throttle to regulate intake air flow to control power during normal operation.

*Steady-state* has the meaning given in 40 CFR 1065.1001.

*Suspend* has the meaning given in 40 CFR 1068.30.

*Test engine* means an engine in a test sample.

*Test sample* means the collection of engines selected from the population of an engine family for emission testing. This may include testing for certification, production-line testing, or in-use testing.

*Tractor* means a vehicle meeting the definition of “tractor” in 40 CFR 1037.801, but not classified as a “vocational tractor” under 40 CFR 1037.630, or relating to such a vehicle.

*Tractor engine* means an engine certified for use in tractors. Where an engine family is certified for use in both tractors and vocational vehicles, “tractor engine” means an engine that the engine manufacturer reasonably believes will be (or has been) installed in a tractor. Note that the provisions of this part may require a manufacturer to document how it determines that an engine is a tractor engine.

*Ultimate purchaser* means, with respect to any new engine or vehicle, the first person who in good faith purchases such new engine or vehicle for purposes other than resale.

*United States* has the meaning given in 40 CFR 1068.30.

*Upcoming model year* means for an engine family the model year after the one currently in production.

*U.S.-directed production volume* means the number of engines, subject to the requirements of this part, produced by a manufacturer for which the manufacturer has a reasonable assurance that sale was or will be made to ultimate purchasers in the United States. This does not include engines certified to state emission standards that are different than the emission standards in this part.

*Vehicle* has the meaning given in 40 CFR 1037.801.

*Vocational engine* means an engine certified for use in vocational vehicles. Where an engine family is certified for use in both tractors and vocational vehicles, “vocational engine” means an engine that the engine manufacturer reasonably believes will be (or has been) installed in a vocational vehicle. Note that the provisions of this part may require a manufacturer to document how it determines that an engine is a vocational engine.

*Vocational vehicle* means a vehicle meeting the definition of “vocational” vehicle in 40 CFR 1037.801.

*Void* has the meaning given in 40 CFR 1068.30.

*We (us, our)* means the Administrator of the Environmental Protection Agency and any authorized representatives.

**§ 1036.805 Symbols, abbreviations, and acronyms.**

The procedures in this part generally follow either the International System of Units (SI) or the United States customary units, as detailed in NIST Special Publication 811 (incorporated by reference in § 1036.810). See 40 CFR 1065.20 for specific provisions related to these conventions. This section summarizes the way we use symbols, units of measure, and other abbreviations.

(a) *Symbols for chemical species.* This part uses the following symbols for chemical species and exhaust constituents:

Symbol	Species
C .....	carbon.
CH <sub>4</sub> .....	methane.
CH <sub>4</sub> N <sub>2</sub> O ...	urea.
CO .....	carbon monoxide.
CO <sub>2</sub> .....	carbon dioxide.
H <sub>2</sub> O .....	water.
HC .....	hydrocarbon.

Symbol	Species
NMHC .....	nonmethane hydrocarbon.
NMHCE ...	nonmethane hydrocarbon equivalent.
NO .....	nitric oxide.
NO <sub>2</sub> .....	nitrogen dioxide.
NO <sub>x</sub> .....	oxides of nitrogen.
N <sub>2</sub> O .....	nitrous oxide.
PM .....	particulate matter.

(b) *Symbols for quantities.* This part uses the following symbols and units of measure for various quantities:

Symbol	Quantity	Unit	Unit symbol	Unit in terms of SI base units
$\alpha$ .....	atomic hydrogen-to-carbon ratio .....	mole per mole .....	mol/mol .....	1.
$\beta$ .....	atomic oxygen-to-carbon ratio .....	mole per mole .....	mol/mol .....	1.
$C_{dA}$ .....	drag area .....	meter squared .....	m <sup>2</sup> .....	m <sup>2</sup> .
$C_{rr}$ .....	coefficient of rolling resistance .....	kilogram per metric ton .....	kg/tonne .....	10 <sup>-3</sup> .
$D$ .....	distance .....	miles or meters .....	mi or m .....	m.
$e$ .....	mass weighted emission result .....	grams/ton-mile .....	g/ton-mi .....	g/kg-km.
$Eff$ .....	efficiency .....	.....	.....	.....
$E_{in}$ .....	mass-specific net energy content .....	megajoules/kilogram .....	MJ/kg .....	m <sup>2</sup> Cs <sup>-2</sup> .
$f_n$ .....	angular speed (shaft) .....	revolutions per minute .....	r/min .....	$\pi$ C30.s <sup>-1</sup> .
$i$ .....	indexing variable .....	.....	.....	.....
$k_a$ .....	drive axle ratio .....	.....	.....	.....
$k_{topgear}$ .....	highest available transmission gear .....	.....	.....	.....
$m$ .....	mass .....	pound mass or kilogram .....	lbm or kg .....	kg.
$M$ .....	molar mass .....	gram per mole .....	g/mol .....	10 <sup>-3</sup> CkgCmol <sup>-1</sup> .
$M$ .....	vehicle mass .....	kilogram .....	kg .....	kg.
$M_{rotating}$ .....	inertial mass of rotating components .....	kilogram .....	kg .....	kg.
$N$ .....	total number in a series .....	.....	.....	.....
$P$ .....	power .....	kilowatt .....	kW .....	10 <sup>3</sup> Cm <sup>2</sup> CkgCs <sup>-3</sup> .
$T$ .....	torque (moment of force) .....	newton meter .....	NCm. ....	m <sup>2</sup> CkgCs <sup>-2</sup> .
$t$ .....	time .....	second .....	s .....	s.
$\Delta t$ .....	time interval, period, 1/frequency .....	second .....	s .....	s.
$UF$ .....	utility factor .....	.....	.....	.....
$v$ .....	speed .....	miles per hour or meters persecond. ....	mi/hr or m/s .....	mCs <sup>-1</sup> .
$W$ .....	work .....	kilowatt-hour .....	kWChr .....	3.6Cm <sup>2</sup> CkgCs <sup>-1</sup> .
$w_C$ .....	carbon mass fraction .....	gram/gram .....	g/g .....	1.
$w_{CH4N2O}$ ..	urea mass fraction .....	gram/gram .....	g/g .....	1.
$x$ .....	amount of substance mole fraction .....	mole per mole .....	mol/mol .....	1.
$x_b$ .....	brake energy fraction .....	.....	.....	.....
$x_{bl}$ .....	brake energy limit .....	.....	.....	.....

(c) *Superscripts.* This part uses the following superscripts to define a quantity:

Superscript	Quantity
overbar (such as $\bar{y}$ )	arithmetic mean.
overdot overdot (such as $\ddot{y}$ ).	quantity per unit time.

(d) *Subscripts.* This part uses the following subscripts to define a quantity:

Subscript	Quantity
65 .....	65 miles per hour.
A .....	A speed.
acc .....	accessory.
app .....	approved.
axle .....	axle.
B .....	B speed.
C .....	C speed.

Subscript	Quantity
Ccombdry .....	carbon from fuel per mole of dry exhaust.
CD .....	charge-depleting.
CO2DEF .....	CO <sub>2</sub> resulting from diesel exhaust fluid decomposition.
comb .....	combustion.
cor .....	corrected.
CS .....	charge-sustaining.
cycle .....	test cycle.
DEF .....	diesel exhaust fluid.
engine .....	engine.
exh .....	raw exhaust.
fuel .....	fuel.
H2Oexhaustdry ...	H <sub>2</sub> O in exhaust per mole of exhaust.
hi .....	high.
i .....	an individual of a series.
idle .....	idle.
m .....	mass.
max .....	maximum.
mapped .....	mapped.

Subscript	Quantity
meas .....	measured quantity.
neg .....	negative.
pos .....	positive.
record .....	record.
ref .....	reference quantity.
speed .....	speed.
stall .....	stall.
test .....	test.
tire .....	tire.
transient .....	transient.
vehicle .....	vehicle.

(e) *Other acronyms and abbreviations.* This part uses the following additional abbreviations and acronyms:

- ABT averaging, banking, and trading
- AECD auxiliary emission control device
- ASTM American Society for Testing and Materials
- BTU British thermal units

CD charge-depleting  
 CFR Code of Federal Regulations  
 CI compression ignition  
 CS charge-sustaining  
 DF deterioration factor  
 DOT Department of Transportation  
 E85 gasoline blend including  
     nominally 85 percent denatured  
     ethanol  
 EPA Environmental Protection Agency  
 FCL Family Certification Level  
 FEL Family Emission Limit  
 GEM Greenhouse gas Emissions Model  
 g/hp-hr grams per brake horsepower-  
     hour  
 GVWR gross vehicle weight rating  
 LPG liquefied petroleum gas  
 NARA National Archives and Records  
     Administration  
 NHTSA National Highway Traffic  
     Safety Administration  
 NTE not-to-exceed  
 RESS rechargeable energy storage  
     system  
 RMC ramped-modal cycle  
 rpm revolutions per minute  
 SCR Selective catalytic reduction  
 SI spark ignition  
 U.S. United States  
 U.S.C. United States Code

(f) *Prefixes.* This part uses the following prefixes to define a quantity:

Symbol	Quantity	Value
μ	micro	10 <sup>-6</sup>
m	milli	10 <sup>-3</sup>
c	centi	10 <sup>-2</sup>
k	kilo	10 <sup>3</sup>
M	mega	10 <sup>6</sup>

**§ 1036.810 Incorporation by reference.**

(a) Certain material is incorporated by reference into this part with the approval of the Director of the Federal Register under 5 U.S.C. 552(a) and 1 CFR part 51. To enforce any edition other than that specified in this section, the Environmental Protection Agency must publish a document in the **Federal Register** and the material must be available to the public. All approved material is available for inspection at U.S. EPA, Air and Radiation Docket and Information Center, 1301 Constitution Ave., NW., Room B102, EPA West Building, Washington, DC 20460, (202) 202-1744, and is available from the sources listed below. It is also available for inspection at the National Archives and Records Administration (NARA). For information on the availability of this material at NARA, call 202-741-6030, or go to [http://www.archives.gov/federal\\_register/code\\_of\\_federal\\_regulations/ibr\\_locations.html](http://www.archives.gov/federal_register/code_of_federal_regulations/ibr_locations.html).

(b) American Society for Testing and Materials, 100 Barr Harbor Drive, P.O. Box C700, West Conshohocken, PA,

19428-2959, (877) 909-2786, <http://www.astm.org/>.

(1) ASTM D4809-13 Standard Test Method for Heat of Combustion of Liquid Hydrocarbon Fuels by Bomb Calorimeter (Precision Method), approved May 1, 2013, (“ASTM D4809”), IBR approved for § 1036.530(b).

(2) [Reserved]

(c) National Institute of Standards and Technology, 100 Bureau Drive, Stop 1070, Gaithersburg, MD 20899-1070, (301) 975-6478, or [www.nist.gov](http://www.nist.gov).

(1) NIST Special Publication 811, Guide for the Use of the International System of Units (SI), 2008 Edition, March 2008, IBR approved for § 1036.805.

(2) [Reserved]

**§ 1036.815 Confidential information.**

The provisions of 40 CFR 1068.10 apply for information you consider confidential.

**§ 1036.820 Requesting a hearing.**

(a) You may request a hearing under certain circumstances, as described elsewhere in this part. To do this, you must file a written request, including a description of your objection and any supporting data, within 30 days after we make a decision.

(b) For a hearing you request under the provisions of this part, we will approve your request if we find that your request raises a substantial factual issue.

(c) If we agree to hold a hearing, we will use the procedures specified in 40 CFR part 1068, subpart G.

**§ 1036.825 Reporting and recordkeeping requirements.**

(a) This part includes various requirements to submit and record data or other information. Unless we specify otherwise, store required records in any format and on any media and keep them readily available for eight years after you send an associated application for certification, or eight years after you generate the data if they do not support an application for certification. You are expected to keep your own copy of required records rather than relying on someone else to keep records on your behalf. We may review these records at any time. You must promptly send us organized, written records in English if we ask for them. We may require you to submit written records in an electronic format.

(b) The regulations in § 1036.255 and 40 CFR 1068.25 and 1068.101 describe your obligation to report truthful and complete information. This includes information not related to certification.

Failing to properly report information and keep the records we specify violates 40 CFR 1068.101(a)(2), which may involve civil or criminal penalties.

(c) Send all reports and requests for approval to the Designated Compliance Officer (see § 1036.801).

(d) Any written information we require you to send to or receive from another company is deemed to be a required record under this section. Such records are also deemed to be submissions to EPA. Keep these records for eight years unless the regulations specify a different period. We may require you to send us these records whether or not you are a certificate holder.

(e) Under the Paperwork Reduction Act (44 U.S.C. 3501 *et seq.*), the Office of Management and Budget approves the reporting and recordkeeping specified in the applicable regulations. The following items illustrate the kind of reporting and recordkeeping we require for engines and vehicles regulated under this part:

(1) We specify the following requirements related to engine certification in this part 1036:

(i) In § 1036.135 we require engine manufacturers to keep certain records related to duplicate labels sent to vehicle manufacturers.

(ii) In § 1036.150 we include various reporting and recordkeeping requirements related to interim provisions.

(iii) In subpart C of this part we identify a wide range of information required to certify engines.

(iv) In subpart G of this part we identify several reporting and recordkeeping items for making demonstrations and getting approval related to various special compliance provisions.

(v) In §§ 1036.725, 1036.730, and 1036.735 we specify certain records related to averaging, banking, and trading.

(2) We specify the following requirements related to testing in 40 CFR part 1065:

(i) In 40 CFR 1065.2 we give an overview of principles for reporting information.

(ii) In 40 CFR 1065.10 and 1065.12 we specify information needs for establishing various changes to published test procedures.

(iii) In 40 CFR 1065.25 we establish basic guidelines for storing test information.

(iv) In 40 CFR 1065.695 we identify the specific information and data items to record when measuring emissions.

(3) We specify the following requirements related to the general

compliance provisions in 40 CFR part 1068:

(i) In 40 CFR 1068.5 we establish a process for evaluating good engineering judgment related to testing and certification.

(ii) In 40 CFR 1068.25 we describe general provisions related to sending and keeping information

(iii) In 40 CFR 1068.27 we require manufacturers to make engines available for our testing or inspection if we make such a request.

(iv) In 40 CFR 1068.105 we require vehicle manufacturers to keep certain records related to duplicate labels from engine manufacturers.

(v) In 40 CFR 1068.120 we specify recordkeeping related to rebuilding engines.

(vi) In 40 CFR part 1068, subpart C, we identify several reporting and recordkeeping items for making demonstrations and getting approval related to various exemptions.

(vii) In 40 CFR part 1068, subpart D, we identify several reporting and recordkeeping items for making demonstrations and getting approval related to importing engines.

(viii) In 40 CFR 1068.450 and 1068.455 we specify certain records related to testing production-line engines in a selective enforcement audit.

(ix) In 40 CFR 1068.501 we specify certain records related to investigating and reporting emission-related defects.

(x) In 40 CFR 1068.525 and 1068.530 we specify certain records related to recalling nonconforming engines.

(xi) In 40 CFR part 1068, subpart G, we specify certain records for requesting a hearing.

**Appendix I to Part 1036 — Default Engine Fuel Maps for § 1036.540**

This appendix includes default steady-state fuel maps for performing cycle-average engine fuel mapping as described in §§ 1036.535 and 1036.540.

(a) Use the following default fuel map for compression-ignition engines that will be installed in Tractors and Vocational Heavy HDV:

Engine speed (r/min)	Engine torque (N·m)	Fuel mass rate (g/sec)
666.7	0	0.436
833.3	0	0.665
1000	0	0.94
1166.7	0	1.002
1333.3	0	1.17
1500	0	1.5
1666.7	0	1.899
1833.3	0	2.378
2000	0	2.93
2166.7	0	3.516
2333.3	0	4.093

Engine speed (r/min)	Engine torque (N·m)	Fuel mass rate (g/sec)	Engine speed (r/min)	Engine torque (N·m)	Fuel mass rate (g/sec)
2500	0	4.672	1500	1800	14.547
500	300	0.974	1666.7	1800	16.485
666.7	300	1.405	1833.3	1800	18.697
833.3	300	1.873	2000	1800	21.535
1000	300	2.324	2166.7	1800	24.981
1166.7	300	2.598	2333.3	1800	28.404
1333.3	300	2.904	2500	1800	31.768
1500	300	3.397	500	2100	13.128
1666.7	300	3.994	666.7	2100	12.936
1833.3	300	4.643	833.3	2100	12.325
2000	300	5.372	1000	2100	11.421
2166.7	300	6.141	1166.7	2100	13.174
2333.3	300	7.553	1333.3	2100	14.969
2500	300	8.449	1500	2100	16.971
500	600	1.723	1666.7	2100	19.274
666.7	600	2.391	1833.3	2100	22.09
833.3	600	3.121	2000	2100	25.654
1000	600	3.756	2166.7	2100	29.399
1166.7	600	4.197	2333.3	2100	32.958
1333.3	600	4.776	2500	2100	36.543
1500	600	5.492	500	2400	17.446
1666.7	600	6.277	666.7	2400	16.922
1833.3	600	7.129	833.3	2400	15.981
2000	600	8.069	1000	2400	14.622
2166.7	600	9.745	1166.7	2400	15.079
2333.3	600	11.213	1333.3	2400	17.165
2500	600	12.59	1500	2400	19.583
500	900	2.637	1666.7	2400	22.408
666.7	900	3.444	1833.3	2400	25.635
833.3	900	4.243	2000	2400	29.22
1000	900	4.997	2166.7	2400	33.168
1166.7	900	5.802	2333.3	2400	37.233
1333.3	900	6.702	2500	2400	41.075
1500	900	7.676	500	2700	22.365
1666.7	900	8.7	666.7	2700	21.511
1833.3	900	9.821	833.3	2700	20.225
2000	900	11.08	1000	2700	17.549
2166.7	900	13.051	1166.7	2700	17.131
2333.3	900	15.002	1333.3	2700	19.588
2500	900	16.862	1500	2700	22.514
500	1200	3.833	1666.7	2700	25.574
666.7	1200	4.679	1833.3	2700	28.909
833.3	1200	5.535	2000	2700	32.407
1000	1200	6.519	2166.7	2700	36.18
1166.7	1200	7.603	2333.3	2700	40.454
1333.3	1200	8.735	2500	2700	44.968
1500	1200	9.948	500	3000	27.476
1666.7	1200	11.226	666.7	3000	22.613
1833.3	1200	12.622	833.3	3000	19.804
2000	1200	14.228	1000	3000	17.266
2166.7	1200	16.488	1166.7	3000	19.197
2333.3	1200	18.921	1333.3	3000	22.109
2500	1200	21.263	1500	3000	25.288
500	1500	6.299	1666.7	3000	28.44
666.7	1500	6.768	1833.3	3000	31.801
833.3	1500	6.95	2000	3000	35.405
1000	1500	8.096	2166.7	3000	39.152
1166.7	1500	9.399	2333.3	3000	42.912
1333.3	1500	10.764	2500	3000	47.512
1500	1500	12.238			
1666.7	1500	13.827			
1833.3	1500	15.586			
2000	1500	17.589			
2166.7	1500	20.493			
2333.3	1500	23.366			
2500	1500	26.055			
500	1800	9.413			
666.7	1800	9.551			
833.3	1800	8.926			
1000	1800	9.745			
1166.7	1800	11.26			
1333.3	1800	12.819			
			Engine speed (r/min)	Engine torque (N·m)	Fuel mass rate (g/sec)
			708.3	0	0.255
			916.7	0	0.263
			1125	0	0.342

(b) Use the following default fuel map for compression-ignition engines that will be installed in Vocational Light HDV and Medium HDV:

Engine speed (r/min)	Engine torque (N·m)	Fuel mass rate (g/sec)
708.3	0	0.255
916.7	0	0.263
1125	0	0.342

Engine speed (r/min)	Engine torque (N·m)	Fuel mass rate (g/sec)	Engine speed (r/min)	Engine torque (N·m)	Fuel mass rate (g/sec)	Engine speed (r/min)	Engine torque (N·m)	Fuel mass rate (g/sec)
1333.3	0	0.713	2791.7	600	11.914	875	0	0.535
1541.7	0	0.885	3000	600	13.286	1250	0	0.734
1750	0	1.068	500	720	2.744	1625	0	0.975
1958.3	0	1.27	708.3	720	3.535	2000	0	1.238
2166.7	0	1.593	916.7	720	4.356	2375	0	1.506
2375	0	1.822	1125	720	5.102	2750	0	1.772
2583.3	0	2.695	1333.3	720	5.968	3125	0	2.07
2791.7	0	4.016	1541.7	720	6.826	3500	0	2.394
3000	0	5.324	1750	720	7.733	3875	0	2.795
500	120	0.515	1958.3	720	8.703	4250	0	3.312
708.3	120	0.722	2166.7	720	9.792	4625	0	3.349
916.7	120	0.837	2375	720	10.984	5000	0	3.761
1125	120	1.097	2583.3	720	12.311	500	65	0.458
1333.3	120	1.438	2791.7	720	13.697	875	65	0.759
1541.7	120	1.676	3000	720	15.071	1250	65	1.065
1750	120	1.993	500	840	3.518	1625	65	1.43
1958.3	120	2.35	708.3	840	4.338	2000	65	1.812
2166.7	120	2.769	916.7	840	5.186	2375	65	2.22
2375	120	3.306	1125	840	6.063	2750	65	2.65
2583.3	120	4.004	1333.3	840	6.929	3125	65	3.114
2791.7	120	4.78	1541.7	840	7.883	3500	65	3.646
3000	120	5.567	1750	840	8.94	3875	65	4.225
500	240	0.862	1958.3	840	10.093	4250	65	4.861
708.3	240	1.158	2166.7	840	11.329	4625	65	5.328
916.7	240	1.462	2375	840	12.613	5000	65	6.028
1125	240	1.85	2583.3	840	13.983	500	130	0.666
1333.3	240	2.246	2791.7	840	15.419	875	130	1.063
1541.7	240	2.603	3000	840	16.853	1250	130	1.497
1750	240	3.086	500	960	4.251	1625	130	1.976
1958.3	240	3.516	708.3	960	5.098	2000	130	2.469
2166.7	240	4.093	916.7	960	5.974	2375	130	3.015
2375	240	4.726	1125	960	6.917	2750	130	3.59
2583.3	240	5.372	1333.3	960	7.889	3125	130	4.218
2791.7	240	6.064	1541.7	960	8.913	3500	130	4.9
3000	240	6.745	1750	960	10.152	3875	130	5.652
500	360	1.221	1958.3	960	11.482	4250	130	6.484
708.3	360	1.651	2166.7	960	12.87	4625	130	7.308
916.7	360	2.099	2375	960	14.195	5000	130	8.294
1125	360	2.62	2583.3	960	15.562	500	195	0.856
1333.3	360	3.116	2791.7	960	16.995	875	195	1.377
1541.7	360	3.604	3000	960	18.492	1250	195	1.923
1750	360	4.172	500	1080	4.978	1625	195	2.496
1958.3	360	4.754	708.3	1080	5.928	2000	195	3.111
2166.7	360	5.451	916.7	1080	6.877	2375	195	3.759
2375	360	6.16	1125	1080	7.827	2750	195	4.49
2583.3	360	7.009	1333.3	1080	8.838	3125	195	5.269
2791.7	360	8.007	1541.7	1080	9.91	3500	195	6.13
3000	360	8.995	1750	1080	11.347	3875	195	7.124
500	480	1.676	1958.3	1080	12.85	4250	195	8.189
708.3	480	2.194	2166.7	1080	14.398	4625	195	9.288
916.7	480	2.76	2375	1080	15.745	5000	195	10.561
1125	480	3.408	2583.3	1080	17.051	500	260	1.079
1333.3	480	4.031	2791.7	1080	18.477	875	260	1.716
1541.7	480	4.649	3000	1080	19.971	1250	260	2.373
1750	480	5.309	500	1200	5.888	1625	260	3.083
1958.3	480	6.052	708.3	1200	6.837	2000	260	3.832
2166.7	480	6.849	916.7	1200	7.787	2375	260	4.599
2375	480	7.681	1125	1200	8.736	2750	260	5.443
2583.3	480	8.783	1333.3	1200	9.786	3125	260	6.391
2791.7	480	10.073	1541.7	1200	10.908	3500	260	7.444
3000	480	11.36	1750	1200	12.541	3875	260	8.564
500	600	2.147	1958.3	1200	14.217	4250	260	9.821
708.3	600	2.787	2166.7	1200	15.925	4625	260	11.268
916.7	600	3.478	2375	1200	17.3	5000	260	12.828
1125	600	4.227	2583.3	1200	18.606	500	325	1.354
1333.3	600	4.999	2791.7	1200	19.912	875	325	2.06
1541.7	600	5.737	3000	1200	21.357	1250	325	2.844
1750	600	6.511				1625	325	3.696
1958.3	600	7.357				2000	325	4.579
2166.7	600	8.289				2375	325	5.466
2375	600	9.295				2750	325	6.434
2583.3	600	10.541				3125	325	7.542

(c) Use the following default fuel map for all spark-ignition engines:

Engine speed (r/min)	Engine torque (N-m)	Fuel mass rate (g/sec)
3500	325	8.685
3875	325	9.768
4250	325	11.011
4625	325	13.249
5000	325	15.095
500	390	1.609
875	390	2.44
1250	390	3.317
1625	390	4.31
2000	390	5.342
2375	390	6.362
2750	390	7.489
3125	390	8.716
3500	390	9.865
3875	390	10.957
4250	390	12.405
4625	390	15.229
5000	390	17.363
500	455	2.245
875	455	2.969
1250	455	3.867
1625	455	4.992
2000	455	6.215
2375	455	7.415
2750	455	8.76
3125	455	10.175
3500	455	11.53
3875	455	12.889
4250	455	14.686
4625	455	17.243
5000	455	19.633
500	520	3.497
875	520	4.444
1250	520	5.084
1625	520	5.764
2000	520	7.205
2375	520	8.597
2750	520	10.135
3125	520	11.708
3500	520	12.962
3875	520	14.225
4250	520	15.647
4625	520	17.579
5000	520	20.031
500	585	5.179
875	585	5.962
1250	585	5.8
1625	585	6.341
2000	585	7.906
2375	585	9.452
2750	585	10.979
3125	585	13.019
3500	585	13.966
3875	585	15.661
4250	585	16.738
4625	585	17.935
5000	585	19.272
500	650	6.834
875	650	7.316
1250	650	5.632
1625	650	6.856
2000	650	8.471
2375	650	10.068
2750	650	11.671
3125	650	14.655
3500	650	14.804
3875	650	16.539
4250	650	18.415
4625	650	19.152
5000	650	20.33

■ 138. Part 1037 is revised to read as follows:

**PART 1037—CONTROL OF EMISSIONS FROM NEW HEAVY-DUTY MOTOR VEHICLES**

**Subpart A—Overview and Applicability**

- Sec. C
- 1037.1 Applicability.
- 1037.2 Who is responsible for compliance?
- 1037.5 Excluded vehicles.
- 1037.10 How is this part organized?
- 1037.15 Do any other regulation parts apply to me?
- 1037.30 Submission of information.

**Subpart B—Emission Standards and Related Requirements**

- 1037.101 Overview of emission standards for heavy-duty vehicles.
- 1037.102 Exhaust emission standards for NO<sub>x</sub>, HC, PM, and CO.
- 1037.103 Evaporative and refueling emission standards.
- 1037.104 Exhaust emission standards for chassis-certified heavy-duty vehicles at or below 14,000 pounds GVWR.
- 1037.105 CO<sub>2</sub> emission standards for vocational vehicles.
- 1037.106 Exhaust emission standards for tractors above 26,000 pounds GVWR.
- 1037.107 Emission standards for trailers.
- 1037.115 Other requirements.
- 1037.120 Emission-related warranty requirements.
- 1037.125 Maintenance instructions and allowable maintenance.
- 1037.130 Assembly instructions for secondary vehicle manufacturers.
- 1037.135 Labeling.
- 1037.140 Classifying vehicles and determining vehicle parameters.
- 1037.150 Interim provisions.

**Subpart C—Certifying Vehicle Families**

- 1037.201 General requirements for obtaining a certificate of conformity.
- 1037.205 What must I include in my application?
- 1037.210 Preliminary approval before certification.
- 1037.211 Preliminary approval for manufacturers of aerodynamic devices.
- 1037.220 Amending maintenance instructions.
- 1037.225 Amending applications for certification.
- 1037.230 Vehicle families, sub-families, and configurations.
- 1037.231 Powertrain families.
- 1037.232 Axle and transmission families.
- 1037.235 Testing requirements for certification.
- 1037.241 Demonstrating compliance with exhaust emission standards for greenhouse gas pollutants.
- 1037.243 Demonstrating compliance with evaporative emission standards.
- 1037.250 Reporting and recordkeeping.
- 1037.255 What decisions may EPA make regarding my certificate of conformity?

**Subpart D—Testing Production Vehicles and Engines**

- 1037.301 Overview of measurements related to GEM inputs in a selective enforcement audit.
- 1037.305 Audit procedures for tractors— aerodynamic testing.
- 1037.310 Audit procedures for trailers.
- 1037.315 Audit procedures related to powertrain testing.
- 1037.320 Audit procedures for axles and transmissions.

**Subpart E—In-use Testing**

- 1037.401 General provisions.

**Subpart F—Test and Modeling Procedures**

- 1037.501 General testing and modeling provisions.
- 1037.510 Duty-cycle exhaust testing.
- 1037.515 Determining CO<sub>2</sub> emissions to show compliance for trailers.
- 1037.520 Modeling CO<sub>2</sub> emissions to show compliance for vocational vehicles and tractors.
- 1037.525 Aerodynamic measurements for tractors.
- 1037.526 Aerodynamic measurements for trailers.
- 1037.527 Aerodynamic measurements for vocational vehicles.
- 1037.528 Coastdown procedures for calculating drag area (C<sub>d</sub>A).
- 1037.530 Wind-tunnel procedures for calculating drag area (C<sub>d</sub>A).
- 1037.532 Using computational fluid dynamics to calculate drag area (C<sub>d</sub>A).
- 1037.534 Constant-speed procedure for calculating drag area (C<sub>d</sub>A).
- 1037.540 Special procedures for testing vehicles with hybrid power take-off.
- 1037.550 Powertrain testing.
- 1037.551 Engine-based simulation of powertrain testing.
- 1037.555 Special procedures for testing Phase 1 hybrid systems.
- 1037.560 Axle efficiency test.
- 1037.565 Transmission efficiency test.

**Subpart G—Special Compliance Provisions**

- 1037.601 General compliance provisions.
- 1037.605 Installing engines certified to alternate standards for specialty vehicles.
- 1037.610 Vehicles with off-cycle technologies.
- 1037.615 Advanced technologies.
- 1037.620 Responsibilities for multiple manufacturers.
- 1037.621 Delegated assembly.
- 1037.622 Shipment of partially complete vehicles to secondary vehicle manufacturers.
- 1037.630 Special purpose tractors.
- 1037.631 Exemption for vocational vehicles intended for off-road use.
- 1037.635 Glider kits and glider vehicles.
- 1037.640 Variable vehicle speed limiters.
- 1037.645 In-use compliance with family emission limits (FELs).
- 1037.655 Post-useful life vehicle modifications.
- 1037.660 Idle-reduction technologies.
- 1037.665 Production and in-use tractor testing.
- 1037.670 Optional CO<sub>2</sub> emission standards for tractors at or above 120,000 pounds GCWR.

**Subpart H—Averaging, Banking, and Trading for Certification**

- 1037.701 General provisions.
- 1037.705 Generating and calculating emission credits.
- 1037.710 Averaging.
- 1037.715 Banking.
- 1037.720 Trading.
- 1037.725 What must I include in my application for certification?
- 1037.730 ABT reports.
- 1037.735 Recordkeeping.
- 1037.740 Restrictions for using emission credits.
- 1037.745 End-of-year CO<sub>2</sub> credit deficits.
- 1037.750 What can happen if I do not comply with the provisions of this subpart?
- 1037.755 Information provided to the Department of Transportation.

**Subpart I—Definitions and Other Reference Information**

- 1037.801 Definitions.
- 1037.805 Symbols, abbreviations, and acronyms.
- 1037.810 Incorporation by reference.
- 1037.815 Confidential information.
- 1037.820 Requesting a hearing.
- 1037.825 Reporting and recordkeeping requirements.

Appendix I to Part 1037—Heavy-duty Transient Test Cycle

Appendix II to Part 1037—Power Take-Off Test Cycle

Appendix III to Part 1037—Emission Control Identifiers

Appendix IV to Part 1037—Heavy-duty Grade Profile for Phase 2 Steady-State Test Cycles

Appendix V to Part 1037—Power Take-Off Utility Factors

**Authority:** 42 U.S.C. 7401–7671q.

**Subpart A—Overview and Applicability****§ 1037.1 Applicability.**

(a) This part contains standards and other regulations applicable to the emission of the air pollutant defined as the aggregate group of six greenhouse gases: carbon dioxide, nitrous oxide, methane, hydrofluorocarbons, perfluorocarbons, and sulfur hexafluoride. The regulations in this part 1037 apply for all new heavy-duty vehicles, except as provided in §§ 1037.5 and 1037.104. This includes electric vehicles and vehicles fueled by conventional and alternative fuels. This also includes certain trailers as described in §§ 1037.5, 1037.150, and 1037.801.

(b) The provisions of this part apply for alternative fuel conversions as specified in 40 CFR part 85, subpart F.

**§ 1037.2 Who is responsible for compliance?**

The regulations in this part 1037 contain provisions that affect both vehicle manufacturers and others.

However, the requirements of this part are generally addressed to the vehicle manufacturer(s). The term “you” generally means the vehicle manufacturer(s), especially for issues related to certification. See § 1037.801 for the definition of “manufacturer” and § 1037.620 for provisions related to compliance when there are multiple entities meeting the definition of “manufacturer.” Additional requirements and prohibitions apply to other persons as specified in subpart G of this part and 40 CFR part 1068.

**§ 1037.5 Excluded vehicles.**

Except for the definitions specified in § 1037.801, this part does not apply to the following vehicles:

(a) Vehicles not meeting the definition of “motor vehicle” in § 1037.801.

(b) Vehicles excluded from the definition of “heavy-duty vehicle” in § 1037.801 because of vehicle weight, weight rating, and frontal area (such as light-duty vehicles and light-duty trucks).

(c) Vehicles produced in model years before 2014, unless they were certified under § 1037.150.

(d) Medium-duty passenger vehicles and other vehicles subject to the light-duty greenhouse gas standards of 40 CFR part 86. See 40 CFR 86.1818 for greenhouse gas standards that apply for these vehicles. An example of such a vehicle would be a vehicle meeting the definition of “heavy-duty vehicle” in § 1037.801 and 40 CFR 86.1803, but also meeting the definition of “light truck” in 40 CFR 86.1818–12(b)(2).

(e) Vehicles subject to the heavy-duty greenhouse gas standards of 40 CFR part 86. See 40 CFR 86.1819 for greenhouse gas standards that apply for these vehicles. This generally applies for complete heavy-duty vehicles at or below 14,000 pounds GVWR.

(f) Aircraft meeting the definition of “motor vehicle”. For example, this would include certain convertible aircraft that can be adjusted to operate on public roads. Standards apply separately to certain aircraft engines, as described in 40 CFR part 87.

(g) Non-box trailers other than flatbed trailers, tank trailers, and container chassis.

(h) Trailers meeting one or more of the following characteristics:

(1) Trailers with four or more axles and trailers less than 35 feet long with three axles (*i.e.*, trailers intended for hauling very heavy loads).

(2) Trailers intended for temporary or permanent residence, office space, or other work space, such as campers, mobile homes, and carnival trailers.

(3) Trailers with a gap of at least 120 inches between adjacent axle centerlines. In the case of adjustable axle spacing, this refers to the closest possible axle positioning.

(4) Trailers built before January 1, 2018.

(5) Note that the definition of “trailer” in § 1037.801 excludes equipment that serves similar purposes but are not intended to be pulled by a tractor. This exclusion applies to such equipment whether or not they are known commercially as trailers. For example, any equipment pulled by a heavy-duty vehicle with a pintle hook or hitch instead of a fifth wheel does not qualify as a trailer under this part.

(i) Where it is unclear, you may ask us to make a determination regarding the exclusions identified in this section. We recommend that you make your request before you produce the vehicle.

**§ 1037.10 How is this part organized?**

This part 1037 is divided into the following subparts:

(a) Subpart A of this part defines the applicability of part 1037 and gives an overview of regulatory requirements.

(b) Subpart B of this part describes the emission standards and other requirements that must be met to certify vehicles under this part. Note that § 1037.150 discusses certain interim requirements and compliance provisions that apply only for a limited time.

(c) Subpart C of this part describes how to apply for a certificate of conformity for vehicles subject to the standards of § 1037.105 or § 1037.106.

(d) Subpart D of this part addresses testing of production vehicles.

(e) Subpart E of this part addresses testing of in-use vehicles.

(f) Subpart F of this part describes how to test your vehicles and perform emission modeling (including references to other parts of the Code of Federal Regulations) for vehicles subject to the standards of § 1037.105 or § 1037.106.

(g) Subpart G of this part and 40 CFR part 1068 describe requirements, prohibitions, and other provisions that apply to manufacturers, owners, operators, rebuilders, and all others. Section 1037.601 describes how 40 CFR part 1068 applies for heavy-duty vehicles.

(h) Subpart H of this part describes how you may generate and use emission credits to certify vehicles.

(i) Subpart I of this part contains definitions and other reference information.



**§ 1037.15 Do any other regulation parts apply to me?**

(a) Parts 1065 and 1066 of this chapter describe procedures and equipment specifications for testing engines and vehicles to measure exhaust emissions. Subpart F of this part 1037 describes how to apply the provisions of part 1065 and part 1066 of this chapter to determine whether vehicles meet the exhaust emission standards in this part.

(b) As described in § 1037.601, certain requirements and prohibitions of part 1068 of this chapter apply to everyone, including anyone who manufactures, imports, installs, owns, operates, or rebuilds any of the vehicles subject to this part 1037. Part 1068 of this chapter describes general provisions that apply broadly, but do not necessarily apply for all vehicles or all persons. The issues addressed by these provisions include these seven areas:

- (1) Prohibited acts and penalties for manufacturers and others.
- (2) Rebuilding and other aftermarket changes.
- (3) Exclusions and exemptions for certain vehicles.
- (4) Importing vehicles.
- (5) Selective enforcement audits of your production.
- (6) Recall.
- (7) Procedures for hearings.
- (c) [Reserved]
- (d) Other parts of this chapter apply if referenced in this part.

**§ 1037.30 Submission of information.**

Unless we specify otherwise, send all reports and requests for approval to the Designated Compliance Officer (see § 1037.801). See § 1037.825 for additional reporting and recordkeeping provisions.

**Subpart B—Emission Standards and Related Requirements****§ 1037.101 Overview of emission standards for heavy-duty vehicles.**

(a) This part specifies emission standards for certain vehicles and for certain pollutants. This part contains standards and other regulations applicable to the emission of the air pollutant defined as the aggregate group of six greenhouse gases: Carbon dioxide, nitrous oxide, methane, hydrofluorocarbons, perfluorocarbons, and sulfur hexafluoride.

(b) The regulated emissions are addressed in four groups:

(1) *Exhaust emissions of NO<sub>x</sub>, HC, PM, and CO.* These pollutants are sometimes described collectively as “criteria pollutants” because they are either criteria pollutants under the Clean Air Act or precursors to the

criteria pollutant ozone. These pollutants are also sometimes described collectively as “non-greenhouse gas pollutants”, although they do not necessarily have negligible global warming potential. As described in § 1037.102, standards for these pollutants are provided in 40 CFR part 86.

(2) *Exhaust emissions of CO<sub>2</sub>, CH<sub>4</sub>, and N<sub>2</sub>O.* These pollutants are described collectively in this part as “greenhouse gas pollutants” because they are regulated primarily based on their impact on the climate. These standards are provided in §§ 1037.105 through 1037.107.

(3) *Hydrofluorocarbons.* These pollutants are also “greenhouse gas pollutants” but are treated separately from exhaust greenhouse gas pollutants listed in paragraph (b)(2) of this section. These standards are provided in § 1037.115.

(4) *Fuel evaporative emissions.* These requirements are described in § 1037.103.

(c) The regulated heavy-duty vehicles are addressed in different groups as follows:

(1) For criteria pollutants, vocational vehicles and tractors are regulated based on gross vehicle weight rating (GVWR), whether they are considered “spark-ignition” or “compression-ignition,” and whether they are first sold as complete or incomplete vehicles.

(2) For greenhouse gas pollutants, vehicles are regulated in the following groups:

- (i) Tractors above 26,000 pounds GVWR.
- (ii) Trailers.
- (iii) Vocational vehicles.

(3) The greenhouse gas emission standards apply differently depending on the vehicle service class as described in § 1037.140. In addition, standards apply differently for vehicles with spark-ignition and compression-ignition engines. References in this part 1037 to “spark-ignition” or “compression-ignition” generally relate to the application of standards under 40 CFR 1036.140. For example, a vehicle with an engine certified to spark-ignition standards under 40 CFR part 1036 is generally subject to requirements under this part 1037 that apply for spark-ignition vehicles. However, note that emission standards for heavy-duty engines are considered to be compression-ignition standards for purposes of applying vehicle emission standards under this part. Also, for spark-ignition engines voluntarily certified as compression-ignition engines under 40 CFR part 1036, you must choose at certification whether

your vehicles are subject to spark-ignition standards or compression-ignition standards.

(4) For evaporative and refueling emissions, vehicles are regulated based on the type of fuel they use. Vehicles fueled with volatile liquid fuels or gaseous fuels are subject to evaporative emission standards. Vehicles up to a certain size that are fueled with gasoline, diesel fuel, ethanol, methanol, or LPG are subject to refueling emission standards.

**§ 1037.102 Exhaust emission standards for NO<sub>x</sub>, HC, PM, and CO.**

See 40 CFR part 86 for the exhaust emission standards for NO<sub>x</sub>, HC, PM, and CO that apply for heavy-duty vehicles.

**§ 1037.103 Evaporative and refueling emission standards.**

(a) *Applicability.* Evaporative and refueling emission standards apply to heavy-duty vehicles as follows:

(1) Complete and incomplete heavy-duty vehicles at or below 14,000 pounds GVWR must meet evaporative and refueling emission standards as specified in 40 CFR part 86, subpart S, instead of the requirements specified in this section.

(2) Heavy-duty vehicles above 14,000 pounds GVWR that run on volatile liquid fuel (such as gasoline or ethanol) or gaseous fuel (such as natural gas or LPG) must meet evaporative and refueling emission standards as specified in this section.

(b) *Emission standards.* The evaporative and refueling emission standards and measurement procedures specified in 40 CFR 86.1813 apply for vehicles above 14,000 pounds GVWR, except as described in this section. The evaporative emission standards phase in over model years 2018 through 2022, with provisions allowing for voluntary compliance with the standards as early as model year 2015. Count vehicles subject to standards under this section the same as heavy-duty vehicles at or below 14,000 pounds GVWR to comply with the phase-in requirements specified in 40 CFR 86.1813. These vehicles may generate and use emission credits as described in 40 CFR part 86, subpart S, but only for vehicles that are tested for certification instead of relying on the provisions of paragraph (c) of this section. The following provisions apply instead of what is specified in 40 CFR 86.1813:

(1) The refueling standards in 40 CFR 86.1813–17(b) apply to complete vehicles starting in model year 2022; they are optional for incomplete vehicles.

(2) The leak standard in 40 CFR 86.1813–17(a)(4) does not apply.

(3) The FEL cap relative to the diurnal plus hot soak standard for low-altitude testing is 1.9 grams per test.

(4) The diurnal plus hot soak standard for high-altitude testing is 2.3 grams per test.

(5) Testing does not require measurement of exhaust emissions. Disregard references in subpart B of this part to procedures, equipment specifications, and recordkeeping related to measuring exhaust emissions. All references to the exhaust test under 40 CFR part 86, subpart B, are considered the “dynamometer run” as part of the evaporative testing sequence under this subpart.

(6) Vehicles not yet subject to the Tier 3 standards in 40 CFR 86.1813 must meet evaporative emission standards as specified in 40 CFR 86.008–10(b)(1) and (2) for Otto-cycle applications and 40 CFR 86.007–11(b)(3)(ii) and (b)(4)(ii) for diesel-cycle applications.

(c) *Compliance demonstration.* You may provide a statement in the application for certification that vehicles above 14,000 pounds GVWR comply with evaporative and refueling emission standards instead of submitting test data if you include an engineering analysis describing how vehicles include design parameters, equipment, operating controls, or other elements of design that adequately demonstrate that vehicles comply with the standards. We would expect emission control components and systems to exhibit a comparable degree of control relative to vehicles that comply based on testing. For example, vehicles that comply under this paragraph (c) should rely on comparable material specifications to limit fuel permeation, and components should be sized and calibrated to correspond with the appropriate fuel capacities, fuel flow rates, purge strategies, and other vehicle operating characteristics. You may alternatively show that design parameters are comparable to those for vehicles at or below 14,000 pounds GVWR certified under 40 CFR part 86, subpart S.

(d) *CNG refueling requirement.* Compressed natural gas vehicles must meet the requirements for fueling connection devices as specified in 40 CFR 86.1813–17(f)(1). Vehicles meeting these requirements are deemed to comply with evaporative and refueling emission standards.

(e) *LNG refueling requirement.* Fuel tanks for liquefied natural gas vehicles must meet the hold-time requirements in Section 4.2 of SAE J2343 (incorporated by reference in

§ 1037.810), as modified by this paragraph (e). All pressures noted are gauge pressure. Vehicles with tanks meeting these requirements are deemed to comply with evaporative and refueling emission standards. The provisions of this paragraph (e) are optional for vehicles produced before January 1, 2020. The hold-time requirements of SAE J2343 apply, with the following clarifications and additions:

(1) Hold time must be at least 120 hours. Use the following procedure to determine hold time for an LNG fuel tank that will be installed on a heavy-duty vehicle:

(i) Prepare the stored (offboard) fuel and the vehicle such that tank pressure after the refueling event stabilizes below 690 kPa.

(ii) Fill the tank to the point of automatic shutoff using a conventional refueling system. This is intended to achieve a net full condition.

(iii) The hold time starts when tank pressure increases to 690 kPa, and ends when the tank first vents for pressure relief. Use good engineering judgment to document the point at which the pressure-relief valve opens.

(iv) Keep the tank at rest away from direct sun with ambient temperatures between (10 and 30) °C throughout the measurement procedure.

(2) Following a complete refueling event as described in paragraph (e)(1) of this section and a short drive, installed tanks may not increase in pressure by more than 9 kPa per hour over a minimum 12 hour interval when parked away from direct sun with ambient temperatures at or below 30 °C. Calculate the allowable pressure gain by multiplying the park time in hours by 9 and rounding to the nearest whole number. Do not include the first hour after engine shutdown, and start the test only when tank pressure is between 345 and 900 kPa.

(3) The standards described in this paragraph (e) apply over the vehicle’s useful life as specified in paragraph (f) of this section. The warranty requirements of § 1037.120 also apply for these standards.

(4) You may specify any amount of inspection and maintenance, consistent with good engineering judgment, to ensure that tanks meet the standards in this paragraph (e) during and after the useful life.

(f) *Useful life.* The evaporative emission standards of this section apply for the full useful life, expressed in service miles or calendar years, whichever comes first. The useful life values for the standards of this section are the same as the values described for

evaporative emission standards in 40 CFR 86.1805.

(g) *Auxiliary engines and separate fuel systems.* The provisions of this paragraph (g) apply for vehicles with auxiliary engines. This includes any engines installed in the final vehicle configuration that contribute no motive power through the vehicle’s transmission.

(1) Auxiliary engines and associated fuel-system components must be installed when testing complete vehicles. If the auxiliary engine draws fuel from a separate fuel tank, you must fill the extra fuel tank before the start of diurnal testing as described for the vehicle’s main fuel tank. Use good engineering judgment to ensure that any nonmetal portions of the fuel system related to the auxiliary engine have reached stabilized levels of permeation emissions. The auxiliary engine must not operate during the running loss test or any other portion of testing under this section.

(2) For testing with incomplete vehicles, you may omit installation of auxiliary engines and associated fuel-system components as long as those components installed in the final configuration are certified to meet the applicable emission standards for Small SI equipment described in 40 CFR 1054.112 or for Large SI engines in 40 CFR 1048.105. For any fuel-system components that you do not install, your installation instructions must describe this certification requirement.

**§ 1037.104 Exhaust emission standards for chassis-certified heavy-duty vehicles at or below 14,000 pounds GVWR.**

Heavy-duty vehicles at or below 14,000 pounds GVWR are not subject to the provisions of this part 1037 if they are subject to 40 CFR part 86, subpart S, including all vehicles certified under 40 CFR part 86, subpart S. See especially 40 CFR 86.1819 and 86.1865 for emission standards and compliance provisions that apply for these vehicles.

**§ 1037.105 CO<sub>2</sub> emission standards for vocational vehicles.**

(a) The standards of this section apply for the following vehicles:

(1) Heavy-duty vehicles at or below 14,000 pounds GVWR that are excluded from the standards in 40 CFR 86.1819 or that use engines certified under § 1037.150(m).

(2) Vehicles above 14,000 pounds GVWR and at or below 26,000 pounds GVWR, but not certified to the vehicle standards in 40 CFR 86.1819.

(3) Vehicles above 26,000 pounds GVWR that are not tractors.

(4) Vocational tractors.

(b) CO<sub>2</sub> standards in this paragraph (b) apply based on modeling and testing as specified in subpart F of this part. The provisions of § 1037.241 specify how to comply with these standards. Standards

differ based on engine cycle, vehicle size, and intended vehicle duty cycle. See § 1037.510(c) to determine which duty cycle applies.

(1) Model year 2027 and later vehicles are subject to CO<sub>2</sub> standards corresponding to the selected subcategories as shown in the following table:

TABLE 1 OF § 1037.105—PHASE 2 CO<sub>2</sub> STANDARDS FOR MODEL YEAR 2027 AND LATER VOCATIONAL VEHICLES [g/ton-mile]

Engine cycle	Vehicle size	Multi-purpose	Regional	Urban
Compression-ignition .....	Light HDV .....	330	291	367
Compression-ignition .....	Medium HDV .....	235	218	258
Compression-ignition .....	Heavy HDV .....	230	189	269
Spark-ignition .....	Light HDV .....	372	319	413
Spark-ignition .....	Medium HDV .....	268	247	297

(2) Model year 2024 through 2026 vehicles are subject to CO<sub>2</sub> standards corresponding to the selected

subcategories as shown in the following table:

TABLE 2 OF § 1037.105—PHASE 2 CO<sub>2</sub> STANDARDS FOR MODEL YEAR 2024 THROUGH 2026 VOCATIONAL VEHICLES [g/ton-mile]

Engine cycle	Vehicle size	Multi-purpose	Regional	Urban
Compression-ignition .....	Light HDV .....	344	296	385
Compression-ignition .....	Medium HDV .....	246	221	271
Compression-ignition .....	Heavy HDV .....	242	194	283
Spark-ignition .....	Light HDV .....	385	324	432
Spark-ignition .....	Medium HDV .....	279	251	310

(3) Model year 2021 Through 2023 vehicles are subject to CO<sub>2</sub> standards corresponding to the selected

subcategories as shown in the following table:

TABLE 3 OF § 1037.105—PHASE 2 CO<sub>2</sub> STANDARDS FOR MODEL YEAR 2021 THROUGH 2023 VOCATIONAL VEHICLES [g/ton-mile]

Engine cycle	Vehicle size	Multi-purpose	Regional	Urban
Compression-ignition .....	Light HDV .....	373	311	424
Compression-ignition .....	Medium HDV .....	265	234	296
Compression-ignition .....	Heavy HDV .....	261	205	308
Spark-ignition .....	Light HDV .....	407	335	461
Spark-ignition .....	Medium HDV .....	293	261	328

(4) Model year 2014 through 2020 vehicles are subject to Phase 1 CO<sub>2</sub>

standards as shown in the following table:

TABLE 4 OF § 1037.105—PHASE 1 CO<sub>2</sub> STANDARDS FOR MODEL YEAR 2014 THROUGH 2020 VOCATIONAL VEHICLES [g/ton-mile]

Vehicle size	CO <sub>2</sub> standard for model years 2014–2016	CO <sub>2</sub> standard for model year 2017 and later
Light HDV .....	388	373
Medium HDV .....	234	225
Heavy HDV .....	226	222

(c) No CH<sub>4</sub> or N<sub>2</sub>O standards apply under this section. See 40 CFR part 1036 for CH<sub>4</sub> or N<sub>2</sub>O standards that apply to engines used in these vehicles.

(d) You may generate or use emission credits for averaging, banking, and trading to demonstrate compliance with the standards in paragraph (b) of this section as described in subpart H of this

part. This requires that you specify a Family Emission Limit (FEL) for CO<sub>2</sub> for each vehicle subfamily. The FEL may not be less than the result of emission modeling from § 1037.520. These FELs

serve as the emission standards for the vehicle subfamily instead of the standards specified in paragraph (b) of this section.

(e) The exhaust emission standards of this section apply for the full useful life, expressed in service miles or calendar years, whichever comes first. The following useful life values apply for the standards of this section:

(1) 150,000 miles or 15 years, whichever comes first, for Light HDV.

(2) 185,000 miles or 10 years, whichever comes first, for Medium HDV.

(3) 435,000 miles or 10 years, whichever comes first, for Heavy HDV.

(f) See § 1037.631 for provisions that exempt certain vehicles used in off-road operation from the standards of this section.

(g) You may optionally certify a vocational vehicle to the standards and useful life applicable to a heavier vehicle service class (such as Medium HDV instead of Light HDV). Provisions related to generating emission credits apply as follows:

(1) If you certify all your vehicles from a given vehicle service class in a

given model year to the standards and useful life that applies for a heavier vehicle service class, you may generate credits as appropriate for the heavier service class.

(2) Class 8 hybrid vehicles with light or medium heavy-duty engines may be certified to compression-ignition standards for the Heavy HDV service class. You may generate and use credits as allowed for the Heavy HDV service class.

(3) Except as specified in paragraphs (g)(1) and (2) of this section, you may not generate credits with the vehicle. If you include lighter vehicles in a subfamily of heavier vehicles with an FEL below the standard, exclude the production volume of lighter vehicles from the credit calculation. Conversely, if you include lighter vehicles in a subfamily with an FEL above the standard, you must include the production volume of lighter vehicles in the credit calculation.

(h) You may optionally certify certain vocational vehicles to alternative Phase 2 standards as specified in this paragraph (h) instead of the standards specified in paragraph (b) of this

section. You may apply these provisions to any qualifying vehicles even though these standards were established for custom chassis. For example, large diversified vehicle manufacturers may certify vehicles to the refuse hauler standards of this section as long as the manufacturer ensures that those vehicles qualify as refuse haulers when placed into service. GEM simulates vehicle operation for each type of vehicle based on an assigned vehicle service class, independent of the vehicle's actual characteristics, as shown in Table 5 of this section; however, standards apply for the vehicle's useful life based on its actual characteristics as specified in paragraph (e) of this section. Vehicles certified to these standards must include the following statement on the emission control label: "THIS VEHICLE WAS CERTIFIED AS A [identify vehicle type as identified in Table 5 of this section] UNDER 40 CFR 1037.105(h)." These custom-chassis standards apply as follows:

(1) The following alternative emission standards apply by vehicle type and model year as follows:

TABLE 5 OF § 1037.105—PHASE 2 CUSTOM CHASSIS STANDARDS  
[g/ton-mile]

Vehicle type <sup>1</sup>	Assigned vehicle service class	MY 2021–2026	MY 2027+
School bus .....	Medium HDV .....	291	271
Motor home .....	Medium HDV .....	228	226
Coach bus .....	Heavy HDV .....	210	205
Other bus .....	Heavy HDV .....	300	286
Refuse hauler .....	Heavy HDV .....	313	298
Concrete mixer .....	Heavy HDV .....	319	316
Mixed-use vehicle .....	Heavy HDV .....	319	316
Emergency vehicle .....	Heavy HDV .....	324	319

<sup>1</sup> Vehicle types are generally defined in § 1037.801. "Other bus" includes any bus that is not a school bus or a coach bus. A "mixed-use vehicle" is one that meets at least one of the criteria specified in § 1037.631(a)(1) and at least one of the criteria in § 1037.631(a)(2), but not both.

(2) You may generate or use emission credits for averaging to demonstrate compliance with the alternative standards as described in subpart H of this part. This requires that you specify a Family Emission Limit (FEL) for CO<sub>2</sub> for each vehicle subfamily. The FEL may not be less than the result of emission modeling as described in § 1037.520. These FELs serve as the emission standards for the vehicle subfamily instead of the standards specified in this paragraph (h). Calculate credits using the equation in § 1037.705(b) with the standard payload for the assigned vehicle service class and the useful life identified in paragraph (e) of this section. Each separate vehicle type identified in Table 5 of this section (or group of vehicle

types identified in a single row) represents a separate averaging set. You may not use averaging for vehicles meeting standards under paragraph (h)(5) through (7) of this section, and you may not bank or trade emission credits from any vehicles certified under this paragraph (h).

(3) [Reserved]

(4) For purposes of emission modeling under § 1037.520, consider motor homes and coach buses to be subject to the Regional duty cycle, and consider all other vehicles to be subject to the Urban duty cycle.

(5) Emergency vehicles are deemed to comply with the standards of this paragraph (h) if they use tires with TRRL at or below 8.4 kg/tonne (8.7 g/

tonne for model years 2021 through 2026).

(6) Concrete mixers and mixed-use vehicles are deemed to comply with the standards of this paragraph (h) if they use tires with TRRL at or below 7.1 kg/tonne (7.6 g/tonne for model years 2021 through 2026).

(7) Motor homes are deemed to comply with the standards of this paragraph (h) if they have tires with TRRL at or below 6.0 kg/tonne (6.7 g/tonne for model years 2021 through 2026) and automatic tire inflation systems or tire pressure monitoring systems with wheels on all axles.

(8) Vehicles certified to standards under this paragraph (h) must use engines certified under 40 CFR part 1036 for the appropriate model year,

except that motor homes and emergency vehicles may use engines certified with the loose-engine provisions of § 1037.150(m). This also applies for vehicles meeting standards under paragraphs (h)(5) through (7) of this section.

**§ 1037.106 Exhaust emission standards for tractors above 26,000 pounds GVWR.**

(a) The CO<sub>2</sub> standards of this section apply for tractors above 26,000 pounds GVWR. Note that the standards of this section do not apply for vehicles classified as “vocational tractors” under § 1037.630.

(b) The CO<sub>2</sub> standards for tractors above 26,000 pounds GVWR in Table 1 of this section apply based on modeling and testing as described in subpart F of this part. The provisions of § 1037.241 specify how to comply with these standards.

TABLE 1 OF § 1037.106—CO<sub>2</sub> STANDARDS FOR CLASS 7 AND CLASS 8 TRACTORS BY MODEL YEAR [g/ton-mile]

Subcategory <sup>1</sup>	Phase 1 standards for model years 2014–2016	Phase 1 standards for model years 2017–2020	Phase 2 standards for model years 2021–2023	Phase 2 standards for model years 2024–2026	Phase 2 standards for model year 2027 and later
Class 7 Low-Roof (all cab styles) .....	107	104	105.5	99.8	96.2
Class 7 Mid-Roof (all cab styles) .....	119	115	113.2	107.1	103.4
Class 7 High-Roof (all cab styles) .....	124	120	113.5	106.6	100.0
Class 8 Low-Roof Day Cab .....	81	80	80.5	76.2	73.4
Class 8 Low-Roof Sleeper Cab .....	68	66	72.3	68.0	64.1
Class 8 Mid-Roof Day Cab .....	88	86	85.4	80.9	78.0
Class 8 Mid-Roof Sleeper Cab .....	76	73	78.0	73.5	69.6
Class 8 High-Roof Day Cab .....	92	89	85.6	80.4	75.7
Class 8 High-Roof Sleeper Cab .....	75	72	75.7	70.7	64.3
Heavy-Haul Tractors .....	.....	.....	52.4	50.2	48.3

<sup>1</sup> Sub-category terms are defined in § 1037.801.

(c) No CH<sub>4</sub> or N<sub>2</sub>O standards apply under this section. See 40 CFR part 1036 for CH<sub>4</sub> or N<sub>2</sub>O standards that apply to engines used in these vehicles.

(d) You may generate or use emission credits for averaging, banking, and trading as described in subpart H of this part. This requires that you calculate a credit quantity if you specify a Family Emission Limit (FEL) that is different than the standard specified in this section for a given pollutant. The FEL may not be less than the result of emission modeling from § 1037.520. These FELs serve as the emission standards for the specific vehicle subfamily instead of the standards specified in paragraph (a) of this section.

(e) The exhaust emission standards of this section apply for the full useful life, expressed in service miles or calendar years, whichever comes first. The following useful life values apply for the standards of this section:

(1) 185,000 miles or 10 years, whichever comes first, for vehicles at or below 33,000 pounds GVWR.

(2) 435,000 miles or 10 years, whichever comes first, for vehicles above 33,000 pounds GVWR.

(f) You may optionally certify Class 7 tractors to Class 8 standards as follows:

(1) You may optionally certify 4×2 tractors with heavy heavy-duty engines to the standards and useful life for Class 8 tractors, with no restriction on generating or using emission credits within the Class 8 averaging set.

(2) You may optionally certify Class 7 tractors not covered by paragraph (f)(1) of this section to the standards and useful life for Class 8 tractors. Credit provisions apply as follows:

(i) If you certify all your Class 7 tractors to Class 8 standards, you may use these Heavy HDV credits without restriction.

(ii) This paragraph (f)(2)(ii) applies if you certify some Class 7 tractors to Class 8 standards under this paragraph (f)(2) but not all of them. If you include Class 7 tractors in a subfamily of Class 8 tractors with an FEL below the standard, exclude the production volume of Class 7 tractors from the credit calculation.

Conversely, if you include Class 7 tractors in a subfamily of Class 8 tractors with an FEL above the standard, you must include the production volume of Class 7 tractors in the credit calculation.

(g) Diesel auxiliary power units installed on tractors subject to standards under this section must meet PM standards as follows:

(1) For model years 2021 through 2023, the APU engine must be certified under 40 CFR part 1039 with a deteriorated emission level for PM at or below 0.15 g/kW-hr.

(2) Starting in model year 2024, auxiliary power units installed on tractors subject to standards under this section must be certified to the PM emission standard specified in 40 CFR 1039.699. Selling, offering for sale, or introducing or delivering into commerce in the United States or importing into the United States a new tractor subject

to this standard is a violation of 40 CFR 1068.101(a)(1) unless the auxiliary power unit has a valid certificate of conformity and the required label showing that it meets the PM standard of this paragraph (g)(2).

(3) See § 1037.660(e) for requirements that apply for diesel APUs in model year 2020 and earlier tractors.

**§ 1037.107 Emission standards for trailers.**

The exhaust emission standards specified in this section apply to trailers based on the effect of trailer designs on the performance of the trailer in conjunction with a tractor; this accounts for the effect of the trailer on the tractor’s exhaust emissions, even though trailers themselves have no exhaust emissions.

(a) Standards apply for trailers based on modeling and testing as described in subpart F of this part, as follows:

(1) Different levels of stringency apply for box vans depending on features that may affect aerodynamic performance. You may optionally meet less stringent standards for different trailer types, which we characterize as follows:

(i) For trailers 35 feet or longer, you may designate as “non-aero box vans” those box vans that have a rear lift gate or rear hinged ramp, and at least one of the following side features: Side lift gate, side-mounted pull-out platform, steps for side-door access, a drop-deck design, or belly boxes that occupy at least half the length of both sides of the trailer between the centerline of the landing gear and the leading edge of the

front wheels. For trailers less than 35 feet long, you may designate as “non-aero box vans” any refrigerated box vans with at least one of the side features identified for longer trailers.

(ii) You may designate as “partial-aero box vans” those box vans that have at least one of the side features identified

in paragraph (a)(1)(i) of this section. Long box vans may also qualify as partial-aero box vans if they have a rear lift gate or rear hinged ramp. Note that this paragraph (a)(1)(ii) does not apply for box vans designated as “non-aero box vans” under paragraph (a)(1)(i) of this section.

(iii) “Full-aero box vans” are box vans that are not designated as non-aero box vans or partial-aero box vans under this paragraph (a)(1).

(2) CO<sub>2</sub> standards apply for full-aero box vans as specified in the following table:

TABLE 1 OF § 1037.107—PHASE 2 CO<sub>2</sub> STANDARDS FOR FULL-AERO BOX VANS  
[g/ton-mile]

Model year	Dry van		Refrigerated van	
	Short	Long	Short	Long
2018–2020 .....	125.4	81.3	129.1	83.0
2021–2023 .....	123.7	78.9	127.5	80.6
2024–2026 .....	120.9	77.2	124.7	78.9
2027+ .....	118.8	75.7	122.7	77.4

(3) CO<sub>2</sub> standards apply for partial-aero box vans as specified in the following table:

TABLE 2 OF § 1037.107—PHASE 2 CO<sub>2</sub> STANDARDS FOR PARTIAL-AERO BOX VANS  
[g/ton-mile]

Model year	Dry van		Refrigerated van	
	Short	Long	Short	Long
2018–2020 .....	125.4	81.3	129.1	83.0
2021+ .....	123.7	80.6	127.5	82.3

(4) Non-box trailers and non-aero box vans must meet standards as follows:

(i) Trailers must use automatic tire inflation systems or tire pressure monitoring systems with wheels on all axles.

(ii) Non-box trailers must use tires with a TRRL at or below 5.1 kg/tonne. Through model year 2020, non-box trailers may instead use tires with a TRRL at or below 6.0 kg/tonne.

(iii) Non-aero box vans must use tires with a TRRL at or below 4.7 kg/tonne. Through model year 2020, non-aero box vans may instead use tires with a TRRL at or below 5.1 kg/tonne.

(5) Starting in model year 2027, you may generate or use emission credits for averaging to demonstrate compliance with the standards specified in paragraph (a)(2) of this section as described in subpart H of this part. This requires that you specify a Family Emission Limit (FEL) for CO<sub>2</sub> for each vehicle subfamily. The FEL may not be less than the result of the emission calculation in § 1037.515. The FEL may not be greater than the appropriate standard for model year 2018 trailers. These FELs serve as the emission standards for the specific vehicle subfamily instead of the standards specified in paragraph (a) of this

section. You may not use averaging for non-box trailers, partial-aero box vans, or non-aero box vans that meet standards under paragraph (a)(3) or (a)(4) of this section, and you may not use emission credits for banking or trading for any trailers.

(6) The provisions of § 1037.241 specify how to comply with the standards of this section.

(b) No CH<sub>4</sub>, N<sub>2</sub>O, or HFC standards apply under this section.

(c) The emission standards of this section apply for a useful life of 10 years.

**§ 1037.115 Other requirements.**

Vehicles required to meet the emission standards of this part must meet the following additional requirements, except as noted elsewhere in this part:

(a) *Adjustable parameters.* Vehicles that have adjustable parameters must meet all the requirements of this part for any adjustment in the physically adjustable range. We may require that you set adjustable parameters to any specification within the adjustable range during any testing. See 40 CFR 86.094–22 for information related to determining whether or not an operating parameter is considered adjustable. You

must ensure safe vehicle operation throughout the physically adjustable range of each adjustable parameter, including consideration of production tolerances. Note that adjustable roof fairings and trailer rear fairings are deemed not to be adjustable parameters.

(b) *Prohibited controls.* You may not design your vehicles with emission control devices, systems, or elements of design that cause or contribute to an unreasonable risk to public health, welfare, or safety while operating. For example, this would apply if the vehicle emits a noxious or toxic substance it would otherwise not emit that contributes to such an unreasonable risk.

(c) [Reserved]

(d) *Defeat devices.* 40 CFR 1068.101 prohibits the use of defeat devices.

(e) *Air conditioning leakage.* Loss of refrigerant from your air conditioning systems may not exceed a total leakage rate of 11.0 grams per year or a percent leakage rate of 1.50 percent per year, whichever is greater. This applies for all refrigerants. Calculate the total leakage rate in g/year as specified in 40 CFR 86.1867–12(a). Calculate the percent leakage rate as: [total leakage rate (g/yr)] ÷ [total refrigerant capacity (g)] × 100. Round your percent leakage rate to the

nearest one-hundredth of a percent. This paragraph (e) does not apply for refrigeration units on trailers; similarly, this paragraph (e) does not apply for self-contained air conditioning or refrigeration units on vocational vehicles even if they draw electrical power from engines used to propel the vehicles. For purposes of this requirement, "refrigerant capacity" is the total mass of refrigerant recommended by the vehicle manufacturer as representing a full charge. Where full charge is specified as a pressure, use good engineering judgment to convert the pressure and system volume to a mass. If air conditioning systems with capacity above 3000 grams of refrigerant are designed such that a compliance demonstration under 40 CFR 86.1867-12(a) is impossible or impractical, you may ask to use alternative means to demonstrate that your air conditioning system achieves an equivalent level of control.

**§ 1037.120 Emission-related warranty requirements.**

(a) *General requirements.* You must warrant to the ultimate purchaser and each subsequent purchaser that the new vehicle, including all parts of its emission control system, meets two conditions:

(1) It is designed, built, and equipped so it conforms at the time of sale to the ultimate purchaser with the requirements of this part.

(2) It is free from defects in materials and workmanship that cause the vehicle to fail to conform to the requirements of this part during the applicable warranty period.

(b) *Warranty period.* (1) Your emission-related warranty must be valid for at least:

(i) 5 years or 50,000 miles for Light HDV.

(ii) 5 years or 100,000 miles for Medium HDV (except tires).

(iii) 5 years for trailers (except tires).

(iv) 1 year for tires installed on trailers, and 2 years or 24,000 miles for all other tires.

(2) You may offer an emission-related warranty more generous than we require. The emission-related warranty for the vehicle may not be shorter than any basic mechanical warranty you provide to that owner without charge for the vehicle. Similarly, the emission-related warranty for any component may not be shorter than any warranty you provide to that owner without charge for that component. This means that your warranty for a given vehicle may not treat emission-related and nonemission-related defects differently

for any component. The warranty period begins when the vehicle is placed into service.

(c) *Components covered.* The emission-related warranty covers tires, automatic tire inflation systems, tire pressure monitoring systems, vehicle speed limiters, idle-reduction systems, hybrid system components, and devices added to the vehicle to improve aerodynamic performance (not including standard components such as hoods or mirrors even if they have been optimized for aerodynamics), to the extent such emission-related components are included in your application for certification. The emission-related warranty also covers other added emission-related components to the extent they are included in your application for certification. The emission-related warranty covers all components whose failure would increase a vehicle's emissions of air conditioning refrigerants (for vehicles subject to air conditioning leakage standards), and it covers all components whose failure would increase a vehicle's evaporative emissions (for vehicles subject to evaporative emission standards). The emission-related warranty covers these components even if another company produces the component. Your emission-related warranty does not need to cover components whose failure would not increase a vehicle's emissions of any regulated pollutant.

(d) *Limited applicability.* You may deny warranty claims under this section if the operator caused the problem through improper maintenance or use, as described in 40 CFR 1068.115. For example, it may be appropriate to require the seals on automatic tire inflation systems to be replaced during the warranty period.

(e) *Owners manual.* Describe in the owners manual the emission-related warranty provisions from this section that apply to the vehicle.

**§ 1037.125 Maintenance instructions and allowable maintenance.**

Give the ultimate purchaser of each new vehicle written instructions for properly maintaining and using the vehicle, including the emission control system. The maintenance instructions also apply to service accumulation on any of your emission-data vehicles. See paragraph (i) of this section for requirements related to tire replacement.

(a) *Critical emission-related maintenance.* Critical emission-related maintenance includes any adjustment, cleaning, repair, or replacement of critical emission-related components.

This may also include additional emission-related maintenance that you determine is critical if we approve it in advance. You may schedule critical emission-related maintenance on these components if you demonstrate that the maintenance is reasonably likely to be done at the recommended intervals on in-use vehicles. We will accept scheduled maintenance as reasonably likely to occur if you satisfy any of the following conditions:

(1) You present data showing that, if a lack of maintenance increases emissions, it also unacceptably degrades the vehicle's performance.

(2) You present survey data showing that at least 80 percent of vehicles in the field get the maintenance you specify at the recommended intervals.

(3) You provide the maintenance free of charge and clearly say so in your maintenance instructions.

(4) You otherwise show us that the maintenance is reasonably likely to be done at the recommended intervals.

(b) *Recommended additional maintenance.* You may recommend any additional amount of maintenance on the components listed in paragraph (a) of this section, as long as you state clearly that these maintenance steps are not necessary to keep the emission-related warranty valid. If operators do the maintenance specified in paragraph (a) of this section, but not the recommended additional maintenance, this does not allow you to disqualify those vehicles from in-use testing or deny a warranty claim. Do not take these maintenance steps during service accumulation on your emission-data vehicles.

(c) *Special maintenance.* You may specify more frequent maintenance to address problems related to special situations, such as atypical vehicle operation. You must clearly state that this additional maintenance is associated with the special situation you are addressing. We may disapprove your maintenance instructions if we determine that you have specified special maintenance steps to address vehicle operation that is not atypical, or that the maintenance is unlikely to occur in use. If we determine that certain maintenance items do not qualify as special maintenance under this paragraph (c), you may identify this as recommended additional maintenance under paragraph (b) of this section.

(d) *Noncritical emission-related maintenance.* Subject to the provisions of this paragraph (d), you may schedule any amount of emission-related inspection or maintenance that is not covered by paragraph (a) of this section

(that is, maintenance that is neither explicitly identified as critical emission-related maintenance, nor that we approve as critical emission-related maintenance). Noncritical emission-related maintenance generally includes maintenance on the components we specify in 40 CFR part 1068, Appendix I, that is not covered in paragraph (a) of this section. You must state in the owners manual that these steps are not necessary to keep the emission-related warranty valid. If operators fail to do this maintenance, this does not allow you to disqualify those vehicles from in-use testing or deny a warranty claim. Do not take these inspection or maintenance steps during service accumulation on your emission-data vehicles.

(e) *Maintenance that is not emission-related.* For maintenance unrelated to emission controls, you may schedule any amount of inspection or maintenance. You may also take these inspection or maintenance steps during service accumulation on your emission-data vehicles, as long as they are reasonable and technologically necessary. You may perform this nonemission-related maintenance on emission-data vehicles at the least frequent intervals that you recommend to the ultimate purchaser (but not the intervals recommended for severe service).

(f) *Source of parts and repairs.* State clearly in your written maintenance instructions that a repair shop or person of the owner's choosing may maintain, replace, or repair emission control devices and systems. Your instructions may not require components or service identified by brand, trade, or corporate name. Also, do not directly or indirectly condition your warranty on a requirement that the vehicle be serviced by your franchised dealers or any other service establishments with which you have a commercial relationship. You may disregard the requirements in this paragraph (f) if you do one of two things:

- (1) Provide a component or service without charge under the purchase agreement.
- (2) Get us to waive this prohibition in the public's interest by convincing us the vehicle will work properly only with the identified component or service.

(g) [Reserved]

(h) *Owners manual.* Explain the owner's responsibility for proper maintenance in the owners manual.

(i) *Tire maintenance and replacement.* Include instructions that will enable the owner to replace tires so

that the vehicle conforms to the original certified vehicle configuration.

**§ 1037.130 Assembly instructions for secondary vehicle manufacturers.**

(a) If you sell a certified incomplete vehicle to a secondary vehicle manufacturer, give the secondary vehicle manufacturer instructions for completing vehicle assembly consistent with the requirements of this part. Include all information necessary to ensure that the final vehicle assembly (including the engine for vehicles other than trailers) will be in its certified configuration.

(b) Make sure these instructions have the following information:

- (1) Include the heading: "Emission-related installation instructions".
- (2) State: "Failing to follow these instructions when completing assembly of a heavy-duty motor vehicle violates federal law, subject to fines or other penalties as described in the Clean Air Act."

(3) Describe the necessary steps for installing any diagnostic system required under 40 CFR part 86.

(4) Describe how your certification is limited for any type of application, as illustrated in the following examples:

(i) If the incomplete vehicle is at or below 8,500 pounds GVWR, state that the vehicle's certification is valid under this part 1037 only if the final configuration has a vehicle curb weight above 6,000 pounds or basic vehicle frontal area above 45 square feet.

(ii) If your engine will be installed in a vehicle that you certify to meet diurnal emission standards using an evaporative canister, but you do not install the fuel tank, identify the maximum permissible fuel tank capacity.

(5) Describe any other instructions to make sure the vehicle will operate according to design specifications in your application for certification.

(c) Provide instructions in writing or in an equivalent format. You may include this information with the incomplete vehicle document required by DOT. If you do not provide the instructions in writing, explain in your application for certification how you will ensure that each installer is informed of the installation requirements.

**§ 1037.135 Labeling.**

(a) Assign each vehicle a unique identification number and permanently affix, engrave, or stamp it on the vehicle in a legible way. The vehicle identification number (VIN) serves this purpose.

(b) At the time of manufacture, affix a permanent and legible label

identifying each vehicle. The label must meet the requirements of 40 CFR 1068.45.

(c) The label must—

(1) Include the heading "VEHICLE EMISSION CONTROL INFORMATION".

(2) Include your full corporate name and trademark. You may identify another company and use its trademark instead of yours if you comply with the branding provisions of 40 CFR 1068.45.

(3) Include EPA's standardized designation for the vehicle family.

(4) State the regulatory subcategory that determines the applicable emission standards for the vehicle family (see definition in § 1037.801).

(5) State the date of manufacture [DAY (optional), MONTH, and YEAR]. You may omit this from the label if you stamp, engrave, or otherwise permanently identify it elsewhere on the vehicle, in which case you must also describe in your application for certification where you will identify the date on the vehicle.

(6) Identify the emission control system. Use terms and abbreviations as described in Appendix III to this part or other applicable conventions. Phase 2 tractors and Phase 2 vocational vehicles may omit this information.

(7) Identify any requirements for fuel and lubricants that do not involve fuel-sulfur levels.

(8) State: "THIS VEHICLE COMPLIES WITH U.S. EPA REGULATIONS FOR [MODEL YEAR] HEAVY-DUTY VEHICLES."

(9) If you rely on another company to design and install fuel tanks in incomplete vehicles that use an evaporative canister for controlling diurnal emissions, include the following statement: "THIS VEHICLE IS DESIGNED TO COMPLY WITH EVAPORATIVE EMISSION STANDARDS WITH UP TO x GALLONS OF FUEL TANK CAPACITY." Complete this statement by identifying the maximum specified fuel tank capacity associated with your certification.

(d) You may add information to the emission control information label as follows:

(1) You may identify other emission standards that the vehicle meets or does not meet (such as European standards).

(2) You may add other information to ensure that the vehicle will be properly maintained and used.

(3) You may add appropriate features to prevent counterfeit labels. For example, you may include the vehicle's unique identification number on the label.



(e) You may ask us to approve modified labeling requirements in this part 1037 if you show that it is necessary or appropriate. We will approve your request if your alternate label is consistent with the requirements of this part.

**§ 1037.140 Classifying vehicles and determining vehicle parameters.**

(a) Where applicable, a vehicle's roof height and a trailer's length are determined from nominal design specifications, as provided in this section. Specify design values for roof height and trailer length to the nearest inch.

(b) Base roof height on fully inflated tires having a static loaded radius equal to the arithmetic mean of the largest and smallest static loaded radius of tires you offer or a standard tire we approve.

(c) Base trailer length on the outer dimensions of the load-carrying structure. Do not include aerodynamic devices or HVAC units.

(d) The nominal design specifications must be within the range of the actual values from production vehicles considering normal production variability. In the case of roof height, use the mean tire radius specified in paragraph (b) of this section. If after production begins it is determined that your nominal design specifications do not represent production vehicles, we may require you to amend your application for certification under § 1037.225.

(e) If your vehicle is equipped with an adjustable roof fairing, measure the roof height with the fairing in its lowest setting.

(f) For any provisions in this part that depend on the number of axles on a vehicle, include lift axles or any other installed axles that can be used to carry the vehicle's weight while in motion.

(g) The standards and other provisions of this part apply to specific vehicle service classes for tractors and vocational vehicles as follows:

(1) Phase 1 and Phase 2 tractors are divided based on GVWR into Class 7 tractors and Class 8 tractors. Where provisions apply to both tractors and vocational vehicles, Class 7 tractors are considered "Medium HDV" and Class 8 tractors are considered "Heavy HDV".

(2) Phase 1 vocational vehicles are divided based on GVWR. "Light HDV" includes Class 2b through Class 5 vehicles; "Medium HDV includes Class 6 and Class 7 vehicles; and "Heavy HDV includes Class 8 vehicles.

(3) Phase 2 vocational vehicles with spark-ignition engines are divided based on GVWR. "Light HDV" includes Class 2b through Class 5 vehicles, and

"Medium HDV includes Class 6 through Class 8 vehicles.

(4) Phase 2 vocational vehicles with compression-ignition engines are divided as follows:

(i) Class 2b through Class 5 vehicles are considered "Light HDV".

(ii) Class 6 through 8 vehicles are considered "Heavy HDV" if the installed engine's primary intended service class is heavy heavy-duty (see 40 CFR 1036.140). All other Class 6 through Class 8 vehicles are considered "Medium HDV".

(5) In certain circumstances, you may certify vehicles to standards that apply for a different vehicle service class. For example, see §§ 1037.105(g) and 1037.106(f). If you optionally certify vehicles to different standards, those vehicles are subject to all the regulatory requirements as if the standards were mandatory.

(h) Use good engineering judgment to identify the intended duty cycle (Urban, Multi-Purpose, or Regional) for each of your vocational vehicle configurations based on the expected use of the vehicles.

**§ 1037.150 Interim provisions.**

The provisions in this section apply instead of other provisions in this part.

(a) *Incentives for early introduction.* The provisions of this paragraph (a) apply with respect to tractors and vocational vehicles produced in model years before 2014. Manufacturers may voluntarily certify in model year 2013 (or earlier model years for electric vehicles) to the greenhouse gas standards of this part.

(1) This paragraph (a)(1) applies for regulatory subcategories subject to the standards of § 1037.105 or § 1037.106. Except as specified in paragraph (a)(3) of this section, to generate early credits under this paragraph for any vehicles other than electric vehicles, you must certify your entire U.S.-directed production volume within the regulatory subcategory to these standards. Except as specified in paragraph (a)(4) of this section, if some vehicle families within a regulatory subcategory are certified after the start of the model year, you may generate credits only for production that occurs after all families are certified. For example, if you produce three vehicle families in an averaging set and you receive your certificates for those families on January 4, 2013, March 15, 2013, and April 24, 2013, you may not generate credits for model year 2013 production in any of the families that occurs before April 24, 2013. Calculate credits relative to the standard that would apply in model year 2014 using

the equations in subpart H of this part. You may bank credits equal to the surplus credits you generate under this paragraph (a) multiplied by 1.50. For example, if you have 1.0 Mg of surplus credits for model year 2013, you may bank 1.5 Mg of credits. Credit deficits for an averaging set prior to model year 2014 do not carry over to model year 2014. These credits may be used to show compliance with the standards of this part for 2014 and later model years. We recommend that you notify EPA of your intent to use this provision before submitting your applications.

(2) [Reserved]

(3) You may generate emission credits for the number of additional SmartWay designated tractors (relative to your 2012 production), provided you do not generate credits for those vehicles under paragraph (a)(1) of this section. Calculate credits for each regulatory subcategory relative to the standard that would apply in model year 2014 using the equations in subpart H of this part. Use a production volume equal to the number of designated model year 2013 SmartWay tractors minus the number of designated model year 2012 SmartWay tractors. You may bank credits equal to the surplus credits you generate under this paragraph (a)(3) multiplied by 1.50. Your 2012 and 2013 model years must be equivalent in length.

(4) This paragraph (a)(4) applies where you do not receive your final certificate in a regulatory subcategory within 30 days of submitting your final application for that subcategory. Calculate your credits for all production that occurs 30 days or more after you submit your final application for the subcategory.

(b) *Phase 1 coastdown procedures.* For tractors subject to Phase 1 standards under § 1037.106, the default method for measuring drag area ( $C_dA$ ) is the coastdown procedure specified in 40 CFR part 1066, subpart D. This includes preparing the tractor and the standard trailer with wheels meeting specifications of § 1037.528(b) and submitting information related to your coastdown testing under § 1037.528(h).

(c) *Provisions for small manufacturers.* Standards apply on a delayed schedule for manufacturers meeting the small business criteria specified in 13 CFR 121.201. Apply the small business criteria for NAICS code 336120 for vocational vehicles and tractors and 336212 for trailers; the employee limits apply to the total number employees together for affiliated companies. Qualifying small manufacturers are not subject to the greenhouse gas standards of §§ 1037.105 and 1037.106 for vehicles with a date of

manufacture before January 1, 2022. Similarly, qualifying small manufacturers are not subject to the greenhouse gas standards of § 1037.107 for trailers with a date of manufacture before January 1, 2019. In addition, qualifying small manufacturers producing vehicles that run on any fuel other than gasoline, E85, or diesel fuel may delay complying with every later standard under this part by one model year. Qualifying manufacturers must notify the Designated Compliance Officer each model year before introducing these excluded vehicles into U.S. commerce. This notification must include a description of the manufacturer's qualification as a small business under 13 CFR 121.201. You must label your excluded vehicles with the following statement: "THIS VEHICLE IS EXCLUDED UNDER 40 CFR 1037.150(c)." Small manufacturers may certify their vehicles under this part 1037 before standards start to apply; however, they may generate emission credits only if they certify their entire U.S.-directed production volume within the applicable averaging set for that model year.

(d) *Air conditioning leakage for vocational vehicles.* The air conditioning leakage standard of § 1037.115 does not apply for model year 2020 and earlier vocational vehicles.

(e) *Delegated assembly.* The delegated-assembly provisions of § 1037.621 do not apply before January 1, 2018.

(f) *Electric vehicles.* Tailpipe emissions of regulated pollutants from electric vehicles (as defined in § 1037.801) are deemed to be zero. No emission testing is required for electric vehicles. Use good engineering judgment to apply other requirements of this part to electric vehicles.

(g) *Compliance date.* Compliance with the standards of this part was optional prior to January 1, 2014. This means that if your 2014 model year begins before January 1, 2014, you may certify for a partial model year that begins on January 1, 2014 and ends on the day your model year would normally end. You must label model year 2014 vehicles excluded under this paragraph (g) with the following statement: "THIS VEHICLE IS EXCLUDED UNDER 40 CFR 1037.150(g)."

(h) *Off-road vehicle exemption.* (1) Vocational vehicles with a date of manufacture before January 1, 2021 automatically qualify for an exemption under § 1037.631 if the tires installed on the vehicle have a maximum speed rating at or below 55 miles per hour.

(2) In unusual circumstances, vehicle manufacturers may ask us to exempt vehicles under § 1037.631 based on other criteria that are equivalent to those specified in § 1037.631(a); however, we will normally not grant relief in cases where the vehicle manufacturer has credits or can otherwise comply with applicable standards. Request approval for an exemption under this paragraph (h) before you produce the subject vehicles. Send your request with supporting information to the Designated Compliance Officer; we will coordinate with NHTSA in making a determination under § 1037.210. If you introduce into U.S. commerce vehicles that depend on our approval under this paragraph (h) before we inform you of our approval, those vehicles violate 40 CFR 1068.101(a)(1).

(i) *Limited carryover from Phase 1 to Phase 2.* The provisions for carryover data in § 1037.235(d) do not allow you to use aerodynamic test results from Phase 1 to support a compliance demonstration for Phase 2 certification.

(j) *Limited prohibition related to early model year engines.* The provisions of this paragraph (j) apply only for vehicles that have a date of manufacture before January 1, 2018. See § 1037.635 for related provisions that apply in later model years. The prohibition in § 1037.601 against introducing into U.S. commerce a vehicle containing an engine not certified to the standards applicable for the calendar year of installation does not apply for vehicles using model year 2014 or 2015 spark-ignition engines, or any model year 2013 or earlier engines.

(k) *Verifying drag areas from in-use tractors.* This paragraph (k) applies for tractors instead of § 1037.401(b) through model year 2020. We may measure the drag area of your vehicles after they have been placed into service. To account for measurement variability, your vehicle is deemed to conform to the regulations of this part with respect to aerodynamic performance if we measure its drag area to be at or below the maximum drag area allowed for the bin above the bin to which you certified (for example, Bin II if you certified the vehicle to Bin III), unless we determine that you knowingly produced the vehicle to have a higher drag area than is allowed for the bin to which it was certified.

(l) *Optional sister-vehicle certification under 40 CFR part 86.* You may certify certain complete or cab-complete vehicles to the GHG standards of 40 CFR 86.1819 instead of the standards of § 1037.105 as specified in 40 CFR 86.1819–14(j).

(m) *Loose engine sales.* Manufacturers may certify certain spark-ignition engines along with chassis-certified heavy-duty vehicles where they are identical to engines used in those vehicles as described in 40 CFR 86.1819–14(k)(8). Vehicles in which those engines are installed are subject to standards under this part as specified in § 1037.105.

(n) *Transition to engine-based model years.* The following provisions apply for production and ABT reports during the transition to engine-based model year determinations for tractors and vocational vehicles in 2020 and 2021:

(1) If you install model year 2020 or earlier engines in your vehicles in calendar year 2020, include all those Phase 1 vehicles in your production and ABT reports related to model year 2020 compliance, although we may require you identify these separately from vehicles produced in calendar year 2019.

(2) If you install model year 2020 engines in your vehicles in calendar year 2021, submit production and ABT reports for those Phase 1 vehicles separate from the reports you submit for Phase 2 vehicles with model year 2021 engines.

(o) *Interim useful life for light heavy-duty vocational vehicles.* Class 2b through Class 5 vocational vehicles certified to Phase 1 standards are subject to a useful life of 110,000 miles or 10 years, whichever comes first, instead of the useful life specified in § 1037.105. For emission credits generated from these Phase 1 vehicles, multiply any banked credits that you carry forward to demonstrate compliance with Phase 2 standards by 1.36.

(p) *Credit multiplier for advanced technology.* If you generate credits from Phase 1 vehicles certified with advanced technology, you may multiply these credits by 1.50, except that you may not apply this multiplier in addition to the early-credit multiplier of paragraph (a) of this section. If you generate credits from model year 2027 and earlier Phase 2 vehicles certified with advanced technology, you may multiply these credits by 3.5 for plug-in hybrid electric vehicles, 4.5 for electric vehicles, and 5.5 for fuel cell vehicles.

(q) *Vehicle families for advanced and off-cycle technologies.* Apply the following provisions for grouping vehicles into families if you use off-cycle technologies under § 1037.610 or advanced technologies under § 1037.615:

(1) For vocational vehicles and tractors subject to Phase 1 standards, create separate vehicle families for vehicles that contain advanced or off-

cycle technologies; group those vehicles together in a vehicle family if they use the same advanced or off-cycle technologies.

(2) For vocational vehicles and tractors subject to Phase 2 standards, create separate vehicle families if there is a credit multiplier for advanced technology; group those vehicles together in a vehicle family if they use the same multiplier.

(r) *Conversion to mid-roof and high-roof configurations.* Secondary vehicle manufacturers that qualify as small manufacturers may convert low- and mid-roof tractors to mid- and high-roof configurations without recertification for the purpose of building a custom sleeper tractor or converting it to run on natural gas, as follows:

(1) The original low- or mid-roof tractor must be covered by a valid certificate of conformity.

(2) The modifications may not increase the frontal area of the tractor beyond the frontal area of the equivalent mid- or high-roof tractor with the corresponding standard trailer. Note that these dimensions have a tolerance of  $\pm 2$  inches. Use good engineering judgment to achieve aerodynamic performance similar to or better than the certifying manufacturer's corresponding mid- or high-roof tractor.

(3) Add a permanent supplemental label to the vehicle near the original manufacturer's emission control information label. On the label identify your full corporate name and include the following statement: "THIS VEHICLE WAS MODIFIED AS ALLOWED UNDER 40 CFR 1037.150."

(4) We may require that you submit annual production reports as described in § 1037.250.

(5) Modifications made under this paragraph (r) do not violate 40 CFR 1068.101(b)(1).

(s) *Confirmatory testing for  $F_{alt-aero}$ .* If we conduct coastdown testing to verify your  $F_{alt-aero}$  value for Phase 2 tractors, we will make our determination using a statistical analysis consistent with the principles of SEA testing in § 1037.305. We will calculate confidence intervals using the same equations and will not replace your test results with ours if your result falls within our confidence interval or is greater than our test result.

(t) *Glider kits and glider vehicles.* (1) Glider vehicles conforming to the requirements in this paragraph (t)(1) are exempt from the Phase 1 emission standards of this part 1037 prior to January 1, 2021. Engines in such vehicles (including vehicles produced after January 1, 2021) remain subject to the requirements of 40 CFR part 86 applicable for the engines' original

model year, but not subject to the Phase 1 or Phase 2 standards of 40 CFR part 1036 unless they were originally manufactured in model year 2014 or later.

(i) You are eligible for this exemption if you are a small manufacturer and you sold one or more glider vehicles in 2014 under the provisions of § 1037.150(c). You do not qualify if you only produced glider vehicles for your own use. You must notify us of your plans to use this exemption before you introduce exempt vehicles into U.S. commerce. In your notification, you must identify your annual U.S.-directed production volume (and sales, if different) of such vehicles for calendar years 2010 through 2014. Vehicles you produce before notifying us are not exempt under this section.

(ii) In a given calendar year, you may produce up to 300 exempt vehicles under this section, or up to the highest annual production volume you identify in paragraph (t)(1) of this section, whichever is less.

(iii) Identify the number of exempt vehicles you produced under this exemption for the preceding calendar year in your annual report under § 1037.250.

(iv) Include the appropriate statement on the label required under § 1037.135, as follows:

(A) For Phase 1 vehicles, "THIS VEHICLE AND ITS ENGINE ARE EXEMPT UNDER 40 CFR 1037.150(t)(1)."

(B) For Phase 2 vehicles, "THE ENGINE IN THIS VEHICLE IS EXEMPT UNDER 40 CFR 1037.150(t)(1)."

(v) If you produce your glider vehicle by installing remanufactured or previously used components in a glider kit produced by another manufacturer, you must provide the following to the glider kit manufacturer prior to obtaining the glider kit:

(A) Your name, the name of your company, and contact information.

(B) A signed statement that you are a qualifying small manufacturer and that your production will not exceed the production limits of this paragraph (t)(1). This statement is deemed to be a submission to EPA, and we may require the glider kit manufacturer to provide a copy to us at any time.

(vi) This exemption is valid for a given vehicle and engine only if you meet all the requirements and conditions of this paragraph (t)(1) that apply with respect to that vehicle and engine. Introducing such a vehicle into U.S. commerce without meeting all applicable requirements and conditions violates 40 CFR 1068.101(a)(1).

(vii) Companies that are not small manufacturers may sell uncertified

incomplete vehicles without engines to small manufacturers for the purpose of producing exempt vehicles under this paragraph (t)(1), subject to the provisions of § 1037.622. However, such companies must take reasonable steps to ensure that their incomplete vehicles will be used in conformance with the requirements of this part 1037.

(2) Glider vehicles produced using engines certified to model year 2010 or later standards for all pollutants are subject to the same provisions that apply to vehicles using engines within their useful life in § 1037.635.

(3) For calendar year 2017, you may produce a limited number of glider kits and/or glider vehicles subject to the requirements applicable to model year 2016 glider vehicles, instead of the requirements of § 1037.635. The limit applies to your combined 2017 production of glider kits and glider vehicles and is equal to your highest annual production of glider kits and glider vehicles for any year from 2010 to 2014. Any glider kits or glider vehicles produced beyond this cap are subject to the provisions of § 1037.635. Count any glider kits and glider vehicles you produce under paragraph (t)(1) of this section as part of your production with respect to this paragraph (t)(3).

(u) *Streamlined preliminary approval for trailer devices.* Before January 1, 2018, manufacturers of aerodynamic devices for trailers may ask for preliminary EPA approval of compliance data for their devices based on qualifying for designation under the SmartWay program based on measured  $C_{dA}$  values, whether or not that involves testing or other methods specified in § 1037.526. Trailer manufacturers may certify based on  $\Delta C_{dA}$  values established under this paragraph (u) through model year 2020. Manufacturers must perform testing as specified in subpart F of this part for any vehicles or aerodynamic devices not qualifying for approval under this paragraph (u).

(v) *Transitional allowances for trailers.* Through model year 2026, trailer manufacturers may calculate a number of trailers that are exempt from the standards and certification requirements of this part. Calculate the number of exempt box vans in a given model year by multiplying your total U.S.-directed production volume of certified box vans by 0.20 and rounding to the nearest whole number; however, in no case may the number of exempted box vans be greater than 350 units in any given model year. Repeat this calculation to determine the number of non-box trailers, up to 250 annual units, that are exempt from standards and certification requirements. Perform the

calculation based on your projected production volumes in the first year that standards apply; in later years, use actual production volumes from the preceding model year. Include these calculated values and your production volumes of exempt trailers in your annual production report under § 1037.250. You must apply a label meeting the requirements of 40 CFR 1068.45(a) that identifies your corporate name and states that the trailer is exempt under the provisions of § 1037.150. Unlabeled trailers will be considered in violation of 40 CFR 1068.101(a)(1).

(w) *Roll-up doors for non-aero box vans.* Through model year 2023, box vans may qualify for non-aero or partial-aero standards under § 1037.107 by treating roll-up rear doors as being equivalent to rear lift gates.

(x) *Aerodynamic testing for trailers.* Section 1037.526 generally requires you to adjust  $\Delta C_{dA}$  values from alternate test methods to be equivalent to measurements with the primary test method. This paragraph (x) describes approximations that we believe are consistent with good engineering judgment; however, you may not use these approximations where we determine that clear and convincing evidence shows that they would significantly overestimate actual improvements in aerodynamic performance.

(1) You may presume that CFD measurements at a yaw angle of  $4.5^\circ$  are equal to measurements made using the primary method, and you may use them without adjustment.

(2) You may presume that coastdown measurements at yaw angles smaller than  $\pm 4.5^\circ$  are equal to measurements made using the primary method, and you may use them without adjustment. This applies equally for device manufacturers, but it does not apply for EPA testing.

(3) You may use testing or analytical methods to adjust coastdown measurements to account for aerodynamic effects at a yaw angle of  $\pm 4.5^\circ$ . This applies for rear fairings and other devices whose performance is affected by yaw angle.

(y) *Transition to Phase 2 standards.* The following provisions allow for enhanced generation and use of emission credits from Phase 1 tractors and vocational vehicles for meeting the Phase 2 standards:

(1) For vocational Light HDV and vocational Medium HDV, emission credits you generate in model years 2018 through 2021 may be used through model year 2027, instead of being limited to a five-year credit life as

specified in § 1037.740(c). For Class 8 vocational vehicles with medium heavy-duty engines, we will approve your request to generate these credits in and use these credits for the Medium HDV averaging set if you show that these vehicles would qualify as Medium HDV under the Phase 2 program as described in § 1037.140(g)(4).

(2) You may use the off-cycle provisions of § 1037.610 to apply technologies to Phase 1 vehicles as follows:

(i) You may apply an improvement factor of 0.988 for tractors and vocational vehicles with automatic tire inflation systems on all axles.

(ii) For vocational vehicles with automatic engine shutdown systems that conform with § 1037.660, you may apply an improvement factor of 0.95.

(iii) For vocational vehicles with stop-start systems that conform with § 1037.660, you may apply an improvement factor of 0.92.

(iv) For vocational vehicles with neutral-idle systems conforming with § 1037.660, you may apply an improvement factor of 0.98. You may adjust this improvement factor if we approve a partial reduction under § 1037.660(a)(2); for example, if your design reduces fuel consumption by half as much as shifting to neutral, you may apply an improvement factor of 0.99.

(3) Small manufacturers may generate emission credits for natural gas-fueled vocational vehicles as follows:

(i) Small manufacturers may certify their vehicles instead of relying on the exemption of paragraph (c) of this section. The provisions of this part apply for such vehicles, except as specified in this paragraph (y)(3).

(ii) Use Phase 1 GEM to determine a CO<sub>2</sub> emission level for your vehicle, then multiply this value by the engine's FCL for CO<sub>2</sub> and divide by the engine's applicable CO<sub>2</sub> emission standard.

(z) *Constraints for vocational duty cycles.* The following provisions apply to determinations of vocational duty cycles as described in § 1037.140:

(1) The Regional duty cycle applies if the engine was certified based on testing only with the ramped-modal cycle.

(2) The Regional duty cycle applies for coach buses and motor homes you certify under § 1037.105(b).

(3) You may not select the Urban duty cycle for any vehicle with a manual or single-clutch automated manual transmission.

(4) Starting in model year 2024, you must select the Regional duty cycle for any vehicle with a manual transmission.

(5) You may select the Urban duty cycle for a hybrid vehicle equipped with

regenerative braking, unless it is equipped with a manual transmission.

(6) You may select the Urban duty cycle for any vehicle with a hydrokinetic torque converter paired with an automatic transmission, or a continuously variable automatic transmission, or a dual-clutch transmission with no more than two consecutive forward gears between which it is normal for both clutches to be momentarily disengaged.

(aa) *Custom-chassis standards.* The following provisions apply uniquely to small manufacturers under the custom-chassis standards of § 1037.105(h):

(1) You may use emission credits generated under § 1037.105(d), including banked or traded credits from any averaging set. Such credits remain subject to other limitations that apply under subpart H of this part.

(2) You may produce up to 200 drayage tractors in a given model year to the standards described in § 1037.105(h) for "other buses". Treat these drayage tractors as being in their own averaging set.

### Subpart C—Certifying Vehicle Families

#### § 1037.201 General requirements for obtaining a certificate of conformity.

(a) You must send us a separate application for a certificate of conformity for each vehicle family. A certificate of conformity is valid from the indicated effective date until the end of the model year for which it is issued. You must renew your certification annually for any vehicles you continue to produce.

(b) The application must contain all the information required by this part and must not include false or incomplete statements or information (see § 1037.255).

(c) We may ask you to include less information than we specify in this subpart, as long as you maintain all the information required by § 1037.250.

(d) You must use good engineering judgment for all decisions related to your application (see 40 CFR 1068.5).

(e) An authorized representative of your company must approve and sign the application.

(f) See § 1037.255 for provisions describing how we will process your application.

(g) We may perform confirmatory testing on your vehicles or components; for example, we may test vehicles to verify drag areas or other GEM inputs. This includes tractors used to determine  $F_{alt-aero}$  under § 1037.525. We may require you to deliver your test vehicles or components to a facility we designate for our testing. Alternatively, you may

choose to deliver another vehicle or component that is identical in all material respects to the test vehicle or component, or a different vehicle or component that we determine can appropriately serve as an emission-data vehicle for the family. We may perform confirmatory testing on engines under 40 CFR part 1036 and may require you to apply modified fuel maps from that testing for certification under this part.

(h) The certification and testing provisions of 40 CFR part 86, subpart S, apply instead of the provisions of this subpart relative to the evaporative and refueling emission standards specified in § 1037.103, except that § 1037.245 describes how to demonstrate compliance with evaporative emission standards. For vehicles that do not use an evaporative canister for controlling diurnal emissions, you may certify with respect to exhaust emissions and use the provisions of § 1037.622 to let a different company certify with respect to evaporative emissions.

(i) Vehicles and installed engines must meet exhaust, evaporative, and refueling emission standards and certification requirements in 40 CFR part 86 or 40 CFR part 1036, as applicable. Include the information described in 40 CFR part 86, subpart S, or 40 CFR 1036.205 in your application for certification in addition to what we specify in § 1037.205 so we can issue a single certificate of conformity for all the requirements that apply for your vehicle and the installed engine.

#### **§ 1037.205 What must I include in my application?**

This section specifies the information that must be in your application, unless we ask you to include less information under § 1037.201(c). We may require you to provide additional information to evaluate your application. References to testing and emission-data vehicles refer to testing vehicles or components to measure any quantity that serves as an input value for modeling emission rates under § 1037.515 or 1037.520.

(a) Describe the vehicle family's specifications and other basic parameters of the vehicle's design and emission controls. List the fuel type on which your vocational vehicles and tractors are designed to operate (for example, ultra-low-sulfur diesel fuel).

(b) Explain how the emission control system operates. As applicable, describe in detail all system components for controlling greenhouse gas emissions, including all auxiliary emission control devices (AECs) and all fuel-system components you will install on any production vehicle. Identify the part number of each component you

describe. For this paragraph (b), treat as separate AECs any devices that modulate or activate differently from each other. Also describe your modeling inputs as described in §§ 1037.515 and 1037.520, with the following additional information if it applies for your vehicles:

(1) Describe your design for vehicle speed limiters, consistent with § 1037.640.

(2) Describe your design for predictive cruise control.

(3) Describe your design for automatic engine shutdown systems, consistent with § 1037.660.

(4) Describe your engineering analysis demonstrating that your air conditioning compressor qualifies as a high-efficiency model as described in 40 CFR 86.1868–12(h)(5).

(5) Describe your design for idle-reduction technology, including the logic for engine shutdown and the maximum duration of engine operation after the onset of any vehicle conditions described in § 1037.660.

(6) If you perform powertrain testing under § 1037.550, report both CO<sub>2</sub> and NO<sub>x</sub> emission levels corresponding to each test run.

(7) Describe the configuration and basic design of hybrid systems. Include measurements for vehicles with hybrid power take-off systems.

(8) If you install auxiliary power units in tractors under § 1037.106(g), identify the family name associated with the engine's certification under 40 CFR part 1039. Starting in model year 2024, also identify the family name associated with the auxiliary power unit's certification to the standards of 40 CFR 1039.699.

(9) Describe how you meet any applicable criteria in § 1037.631(a)(1) and (2).

(c) For vehicles subject to air conditioning standards, include:

(1) The refrigerant leakage rates (leak scores).

(2) The type of refrigerant and the refrigerant capacity of the air conditioning systems.

(3) The corporate name of the final installer of the air conditioning system.

(d) Describe any vehicles or components you selected for testing and the reasons for selecting them.

(e) Describe any test equipment and procedures that you used, including any special or alternate test procedures you used (see § 1037.501). Include information describing the procedures you used to determine  $C_{dA}$  values as specified in §§ 1037.525 through 1037.527. Describe which type of data you are using for engine fuel maps (see 40 CFR 1036.510). If your trailer

certification relies on approved data from device manufacturers, identify the device and device manufacturer.

(f) Describe how you operated any emission-data vehicle before testing, including the duty cycle and the number of vehicle operating miles used to stabilize emission-related performance. Explain why you selected the method of service accumulation. Describe any scheduled maintenance you did.

(g) Where applicable, list the specifications of any test fuel to show that it falls within the required ranges we specify in 40 CFR part 1065.

(h) Identify the vehicle family's useful life.

(i) Include the maintenance instructions and warranty statement you will give to the ultimate purchaser of each new vehicle (see §§ 1037.120 and 1037.125).

(j) Describe your emission control information label (see § 1037.135).

(k) Identify the emission standards or FELs to which you are certifying vehicles in the vehicle family. For families containing multiple subfamilies, this means that you must identify the highest and lowest FELs to which any of your subfamilies will be certified.

(l) Where applicable, identify the vehicle family's deterioration factors and describe how you developed them. Present any emission test data you used for this (see § 1037.241(c)).

(m) Where applicable, state that you operated your emission-data vehicles as described in the application (including the test procedures, test parameters, and test fuels) to show you meet the requirements of this part.

(n) [Reserved]

(o) Report calculated and modeled emission results as follows:

(1) For vocational vehicles and tractors, report modeling results for ten configurations. Include modeling inputs and detailed descriptions of how they were derived. Unless we specify otherwise, include the configuration with the highest modeling result, the lowest modeling result, and the configurations with the highest projected sales.

(2) For trailers that demonstrate compliance with g/ton-mile emission standards as described in § 1037.515, report the CO<sub>2</sub> emission result for the configuration with the highest calculated value. If your trailer family generates or uses emission credits, also report the CO<sub>2</sub> emission results for the configuration with the lowest calculated value, and for the configuration with the highest projected sales.

(p) Where applicable, describe all adjustable operating parameters (see § 1037.115), including production tolerances. You do not need to include parameters that do not affect emissions covered by your application. Include the following in your description of each parameter:

(1) The nominal or recommended setting.

(2) The intended physically adjustable range.

(3) The limits or stops used to establish adjustable ranges.

(4) Information showing why the limits, stops, or other means of inhibiting adjustment are effective in preventing adjustment of parameters on in-use vehicles to settings outside your intended physically adjustable ranges.

(q) [Reserved]

(r) Unconditionally certify that all the vehicles in the vehicle family comply with the requirements of this part, other referenced parts of the CFR, and the Clean Air Act.

(s) Include good-faith estimates of U.S.-directed production volumes by subfamily. We may require you to describe the basis of your estimates.

(t) Include the information required by other subparts of this part. For example, include the information required by § 1037.725 if you plan to generate or use emission credits.

(u) Include other applicable information, such as information specified in this part or 40 CFR part 1068 related to requests for exemptions.

(v) Name an agent for service located in the United States. Service on this agent constitutes service on you or any of your officers or employees for any action by EPA or otherwise by the United States related to the requirements of this part.

#### **§ 1037.210 Preliminary approval before certification.**

If you send us information before you finish the application, we may review it and make any appropriate determinations. Decisions made under this section are considered to be preliminary approval, subject to final review and approval. We will generally not reverse a decision where we have given you preliminary approval, unless we find new information supporting a different decision. If you request preliminary approval related to the upcoming model year or the model year after that, we will make best-efforts to make the appropriate determinations as soon as practicable. We will generally not provide preliminary approval related to a future model year more than two years ahead of time.

#### **§ 1037.211 Preliminary approval for manufacturers of aerodynamic devices.**

(a) If you design or manufacture aerodynamic devices for trailers, you may ask us to provide preliminary approval for the measured performance of your devices. While decisions made under this section are considered to be preliminary approval, we will not reverse a decision where we have given you preliminary approval, unless we find new information supporting a different decision. For example, where we measure the performance of your device after giving you preliminary approval and its measured performance is less than your data indicated, we may rescind the preliminary approval of your test results.

(b) To request this, you must provide test data for  $\Delta C_d A$  values as specified in § 1037.150(u) or § 1037.526. Trailer manufacturers may use approved  $\Delta C_d A$  values as inputs under § 1037.515 to support their application for certification.

#### **§ 1037.220 Amending maintenance instructions.**

You may amend your emission-related maintenance instructions after you submit your application for certification as long as the amended instructions remain consistent with the provisions of § 1037.125. You must send the Designated Compliance Officer a written request to amend your application for certification for a vehicle family if you want to change the emission-related maintenance instructions in a way that could affect emissions. In your request, describe the proposed changes to the maintenance instructions. If operators follow the original maintenance instructions rather than the newly specified maintenance, this does not allow you to disqualify those vehicles from in-use testing or deny a warranty claim.

(a) If you are decreasing or eliminating any specified maintenance, you may distribute the new maintenance instructions to your customers 30 days after we receive your request, unless we disapprove your request. This would generally include replacing one maintenance step with another. We may approve a shorter time or waive this requirement.

(b) If your requested change would not decrease the specified maintenance, you may distribute the new maintenance instructions any time after you send your request. For example, this paragraph (b) would cover adding instructions to increase the frequency of filter changes for vehicles in severe-duty applications.

(c) You need not request approval if you are making only minor corrections (such as correcting typographical mistakes), clarifying your maintenance instructions, or changing instructions for maintenance unrelated to emission control. We may ask you to send us copies of maintenance instructions revised under this paragraph (c).

#### **§ 1037.225 Amending applications for certification.**

Before we issue you a certificate of conformity, you may amend your application to include new or modified vehicle configurations, subject to the provisions of this section. After we have issued your certificate of conformity, you may send us an amended application requesting that we include new or modified vehicle configurations within the scope of the certificate, subject to the provisions of this section. You must amend your application if any changes occur with respect to any information that is included or should be included in your application.

(a) You must amend your application before you take any of the following actions:

(1) Add any vehicle configurations to a vehicle family that are not already covered by your application. For example, if your application identifies three possible engine models, and you plan to produce vehicles using an additional engine model, then you must amend your application before producing vehicles with the fourth engine model. The added vehicle configurations must be consistent with other vehicle configurations in the vehicle family with respect to the criteria listed in § 1037.230.

(2) Change a vehicle configuration already included in a vehicle family in a way that may change any of the components you described in your application for certification, or make any other changes that would make the emissions inconsistent with the information in your application. This includes production and design changes that may affect emissions any time during the vehicle's lifetime.

(3) Modify an FEL for a vehicle family as described in paragraph (f) of this section.

(b) To amend your application for certification, send the relevant information to the Designated Compliance Officer.

(1) Describe in detail the addition or change in the vehicle model or configuration you intend to make.

(2) Include engineering evaluations or data showing that the amended vehicle family complies with all applicable requirements. You may do this by

showing that the original emission-data vehicle is still appropriate for showing that the amended family complies with all applicable requirements.

(3) If the original emission-data vehicle or emission modeling for the vehicle family is not appropriate to show compliance for the new or modified vehicle configuration, include new test data or emission modeling showing that the new or modified vehicle configuration meets the requirements of this part.

(4) Include any other information needed to make your application correct and complete.

(c) We may ask for more test data or engineering evaluations. You must give us these within 30 days after we request them.

(d) For vehicle families already covered by a certificate of conformity, we will determine whether the existing certificate of conformity covers your newly added or modified vehicle. You may ask for a hearing if we deny your request (see § 1037.820).

(e) For vehicle families already covered by a certificate of conformity, you may start producing the new or modified vehicle configuration any time after you send us your amended application and before we make a decision under paragraph (d) of this section. However, if we determine that the affected vehicles do not meet applicable requirements, we will notify you to cease production of the vehicles and may require you to recall the vehicles at no expense to the owner. Choosing to produce vehicles under this paragraph (e) is deemed to be consent to recall all vehicles that we determine do not meet applicable emission standards or other requirements and to remedy the nonconformity at no expense to the

owner. If you do not provide information required under paragraph (c) of this section within 30 days after we request it, you must stop producing the new or modified vehicles.

(f) You may ask us to approve a change to your FEL in certain cases after the start of production. The changed FEL may not apply to vehicles you have already introduced into U.S. commerce, except as described in this paragraph (f). You may ask us to approve a change to your FEL in the following cases:

(1) You may ask to raise your FEL for your vehicle subfamily at any time. In your request, you must show that you will still be able to meet the emission standards as specified in subparts B and H of this part. Use the appropriate FELs with corresponding production volumes to calculate emission credits for the model year, as described in subpart H of this part.

(2) Where testing applies, you may ask to lower the FEL for your vehicle subfamily only if you have test data from production vehicles showing that emissions are below the proposed lower FEL. Otherwise, you may ask to lower your FEL for your vehicle subfamily at any time. The lower FEL applies only to vehicles you produce after we approve the new FEL. Use the appropriate FELs with corresponding production volumes to calculate emission credits for the model year, as described in subpart H of this part.

(3) You may ask to add an FEL for your vehicle family at any time.

(g) You may produce vehicles as described in your amended application for certification and consider those vehicles to be in a certified configuration if we approve a new or modified vehicle configuration during the model year under paragraph (d) of

this section. Similarly, you may modify in-use vehicles as described in your amended application for certification and consider those vehicles to be in a certified configuration if we approve a new or modified vehicle configuration at any time under paragraph (d) of this section. Modifying a new or in-use vehicle to be in a certified configuration does not violate the tampering prohibition of 40 CFR 1068.101(b)(1), as long as this does not involve changing to a certified configuration with a higher family emission limit. See § 1037.621(g) for special provisions that apply for changing to a different certified configuration in certain circumstances.

**§ 1037.230 Vehicle families, sub-families, and configurations.**

(a) For purposes of certifying your vehicles to greenhouse gas standards, divide your product line into families of vehicles based on regulatory subcategories as specified in this section. Subcategories are specified using terms defined in § 1037.801. Your vehicle family is limited to a single model year.

(1) Apply subcategories for vocational vehicles and vocational tractors as shown in Table 1 of this section. This involves 15 separate subcategories for Phase 2 vehicles to account for engine characteristics, GVWR, and the selection of duty cycle for vocational vehicles as specified in § 1037.510; vehicles may additionally fall into one of the subcategories defined by the custom-chassis standards in § 1037.105(h). Divide Phase 1 vehicles into three GVWR-based vehicle service classes as shown in Table 1 of this section, disregarding additional specified characteristics. Table 1 follows:

TABLE 1 OF § 1037.230—VOCATIONAL VEHICLE SUBCATEGORIES

Engine cycle	Light HDV	Medium HDV	Heavy HDV
Compression-ignition .....	Urban ..... Multi-Purpose .....	Urban ..... Multi-Purpose .....	Urban. Multi-Purpose. Regional.
Spark-ignition .....	Regional ..... Urban ..... Multi-Purpose .....	Regional ..... Urban. Multi-Purpose. Regional.	

(2) Apply subcategories for tractors (other than vocational tractors) as

shown in Table 2 of this section. Vehicles may additionally fall into one

of the subcategories defined by the optional tractor standards in § 1037.670.

TABLE 2 OF § 1037.230—TRACTOR SUBCATEGORIES

Class 7	Class 8	
Low-roof tractors .....	Low-roof day cabs .....	Low-roof sleeper cabs.
Mid-roof tractors .....	Mid-roof day cabs .....	Mid-roof sleeper cabs.
High-roof tractors .....	High-roof day cabs .....	High-roof sleeper cabs.
	Heavy-haul tractors (starting with Phase 2).	



(3) Apply subcategories for trailers as shown in the following table:

TABLE 3 OF § 1037.230—TRAILER SUBCATEGORIES

Full-aero trailers	Partial-aero trailers	Other trailers
Long dry box vans .....	Long dry box vans .....	Non-aero trailers.
Short dry box vans .....	Short dry box vans .....	Non-box trailers.
Long refrigerated box vans .....	Long refrigerated box vans..	
Short refrigerated box vans .....	Short refrigerated box vans..	

(b) If the vehicles in your family are being certified to more than one FEL, subdivide your greenhouse gas vehicle families into subfamilies that include vehicles with identical FELs. Note that you may add subfamilies at any time during the model year.

(c) Group vehicles into configurations consistent with the definition of “vehicle configuration” in § 1037.801. Note that vehicles with hardware or software differences that are related to measured or modeled emissions are considered to be different vehicle configurations even if they have the same modeling inputs and FEL. Note also, that you are not required to separately identify all configurations for certification. Note that you are not required to identify all possible configurations for certification; also, you are required to include in your end-of-year report only those configurations you produced.

(d) You may combine dissimilar vehicles into a single vehicle family in special circumstances as follows:

(1) For a Phase 1 vehicle model that straddles a roof-height, cab type, or GVWR division, you may include all the vehicles in the same vehicle family if you certify the vehicle family to the more stringent standard. For roof height, this means you must certify to the taller roof standards. For cab-type and GVWR, this means you must certify to the numerically lower standards.

(2) For a Phase 2 vehicle model that includes a range of GVWR values that straddle weight classes, you may include all the vehicles in the same vehicle family if you certify the vehicle family to the numerically lower CO<sub>2</sub> emission standard from the affected service classes. Vehicles that are optionally certified to a more stringent standard under this paragraph (d)(2) are subject to useful-life and all other provisions corresponding to the weight class with the numerically lower CO<sub>2</sub> emission standard. For a Phase 2 tractor model that includes a range of roof heights that straddle subcategories, you may include all the vehicles in the same vehicle family if you certify the vehicle

family to the appropriate subcategory as follows:

(i) You may certify mid-roof tractors as high-roof tractors, but you may not certify high-roof tractors as mid-roof tractors.

(ii) For tractor families straddling the low-roof/mid-roof division, you may certify the family based on the primary roof-height as long as no more than 10 percent of the tractors are certified to the otherwise inapplicable subcategory. For example, if 95 percent of the tractors in the family are less than 120 inches tall, and the other 5 percent are 122 inches tall, you may certify the tractors as a single family in the low-roof subcategory.

(iii) Determine the appropriate aerodynamic bin number based on the actual roof height if you measure a C<sub>d</sub>A value. However, use the GEM input for the bin based on the standards to which you certify. For example, if you certify as mid-roof tractors some low-roof tractors with a measured C<sub>d</sub>A value of 4.2 m<sup>2</sup>, they qualify as Bin IV; and you must input into GEM the mid-roof Bin IV value of 5.85 m<sup>2</sup>.

(3) You may include refrigerated box vans in a vehicle family with dry box vans by treating them all as dry box vans for demonstrating compliance with emission standards. You may include certain other types of trailers in a vehicle family with a different type of trailer, such that the combined set of trailers are all subject to the more stringent standards, as follows:

(i) Standards for long trailers are more stringent than standards for short trailers.

(ii) Standards for long dry box vans are more stringent than standards for short refrigerated box vans.

(iii) Standards for non-aero box vans are more stringent than standards for non-box trailers.

(e) You may divide your families into more families than specified in this section.

(f) You may ask us to allow you to group into the same configuration vehicles that have very small body hardware differences that do not significantly affect drag areas.

**§ 1037.231 Powertrain families.**

(a) If you choose to perform powertrain testing as specified in § 1037.550, use good engineering judgment to divide your product line into powertrain families that are expected to have similar fuel consumptions and CO<sub>2</sub> emission characteristics throughout the useful life. Your powertrain family is limited to a single model year.

(b) Except as specified in paragraph (c) of this section, group powertrains in the same powertrain family if they share all the following attributes:

- (1) Engine family.
- (2) Shared vehicle service class grouping, as follows:
  - (i) Light HDV or Medium HDV.
  - (ii) Heavy HDV other than heavy-haul tractors.
  - (iii) Heavy-haul tractors.
- (3) Number of clutches.
- (4) Type of clutch (e.g., wet or dry).
- (5) Presence and location of a fluid coupling such as a torque converter.
- (6) Gear configuration, as follows:
  - (i) Planetary (e.g., simple, compound, meshed-planet, stepped-planet, multi-stage).
  - (ii) Countershaft (e.g., single, double, triple).
  - (iii) Continuously variable (e.g., pulley, magnetic, toroidal).
- (7) Number of available forward gears, and transmission gear ratio for each available forward gear, if applicable.
- (8) Transmission oil sump configuration (e.g., conventional or dry).
- (9) The power transfer configuration of any hybrid technology (e.g., series or parallel).
- (10) The energy storage device and capacity of any hybrid technology (e.g., 10 MJ hydraulic accumulator, 10 kW·hr Lithium-ion battery pack, 10 MJ ultracapacitor bank).
- (11) The rated output of any hybrid mechanical power technology (e.g., 50 kW electric motor).

(c) For powertrains that share all the attributes described in paragraph (b) of this section, divide them further into separate powertrain families based on common calibration attributes. Group powertrains in the same powertrain



family to the extent that powertrain test results and corresponding emission levels are expected to be similar throughout the useful life.

(d) You may subdivide a group of powertrains with shared attributes under paragraph (b) of this section into different powertrain families.

(e) In unusual circumstances, you may group powertrains into the same powertrain family even if they do not have shared attributes under in paragraph (b) of this section if you show that their emission characteristics throughout the useful life will be similar.

(f) If you include the axle when performing powertrain testing for the family, you must limit the family to include only those axles represented by the test results. You may include multiple axle ratios in the family if you test with the axle expected to produce the highest emission results.

#### **§ 1037.232 Axle and transmission families.**

(a) If you choose to perform axle testing as specified in § 1037.560 or transmission testing as specified in § 1037.565, use good engineering judgment to divide your product line into axle or transmission families that are expected to have similar hardware, noting that efficiencies can differ across the members of a family. Note that, while there is no certification for axle and transmission families under this part, vehicle manufacturers may rely on axle and transmission test data to certify their vehicles.

(b) Except as specified in paragraph (d) of this section, group axles in the same axle family if they have the same number of drive axles and the same load rating.

(c) Except as specified in paragraph (d) of this section, group transmissions in the same transmission family if they share all the following attributes:

(1) Number and type of clutches (wet or dry).

(2) Presence and location of a fluid coupling such as a torque converter.

(3) Gear configuration, as follows:

(i) Planetary (*e.g.*, simple, compound, meshed-planet, stepped-planet, multi-stage).

(ii) Countershaft (*e.g.*, single, double, triple).

(iii) Continuously variable (*e.g.*, pulley, magnetic, toroidal). Note that GEM does not accommodate efficiency testing for continuously variable transmissions.

(4) Transmission oil sump configuration (conventional or dry).

(d) You may subdivide a group of axles or powertrains with shared attributes under paragraph (b) or (c) of this section into different families.

#### **§ 1037.235 Testing requirements for certification.**

This section describes the emission testing you must perform to show compliance with respect to the greenhouse gas emission standards in subpart B of this part, and to determine any input values from §§ 1037.515 and 1037.520 that involve measured quantities.

(a) Select emission-data vehicles that represent production vehicles and components for the vehicle family consistent with the specifications in §§ 1037.205(o), 1037.515, and 1037.520. Where the test results will represent multiple vehicles or components with different emission performance, use good engineering judgment to select worst-case emission data vehicles or components. In the case of powertrain testing under § 1037.550, select a test engine and test transmission by considering the whole range of vehicle models covered by the powertrain family and the mix of duty cycles specified in § 1037.510.

(b) Test your emission-data vehicles (including emission-data components) using the procedures and equipment specified in subpart F of this part. Measure emissions (or other parameters, as applicable) using the specified procedures.

(c) We may perform confirmatory testing by measuring emissions (or other parameters, as applicable) from any of your emission-data vehicles.

(1) We may decide to do the testing at your plant or any other facility. If we do this, you must deliver the vehicle or component to a test facility we designate. The vehicle or component you provide must be in a configuration that is suitable for testing. For example, vehicles must have the tires you used for testing, and tractors must be set up with the trailer you used for testing. If we do the testing at your plant, you must schedule it as soon as possible and make available the instruments, personnel, and equipment we need (see paragraph (g) of this section for provisions that apply specifically for testing a tractor's aerodynamic performance).

(2) If we measure emissions (or other parameters, as applicable) from your vehicle or component, the results of that testing become the official emission results for the vehicle or component. Note that changing the official emission result does not necessarily require a change in the declared modeling input value. Unless we later invalidate these data, we may decide not to consider your data in determining if your vehicle family meets applicable requirements.

(3) Before we test one of your vehicles or components, we may set its adjustable parameters to any point within the physically adjustable ranges, if applicable.

(4) Before we test one of your vehicles or components, we may calibrate it within normal production tolerances for anything we do not consider an adjustable parameter. For example, this would apply for a vehicle parameter that is subject to production variability because it is adjustable during production, but is not considered an adjustable parameter (as defined in § 1037.801) because it is permanently sealed. For parameters that relate to a level of performance that is itself subject to a specified range (such as maximum power output), we will generally perform any calibration under this paragraph (c)(4) in a way that keeps performance within the specified range. Note that this paragraph (c)(4) does not allow us to test your vehicles in a condition that would be unrepresentative of production vehicles.

(d) You may ask to use carryover data for a vehicle or component from a previous model year instead of doing new tests if the applicable emission-data vehicle from the previous model year remains the appropriate emission-data vehicle under paragraph (b) of this section.

(e) We may require you to test a second vehicle or component of the same configuration in addition to the vehicle or component tested under paragraph (a) of this section.

(f) If you use an alternate test procedure under 40 CFR 1065.10 and later testing shows that such testing does not produce results that are equivalent to the procedures specified in subpart F of this part, we may reject data you generated using the alternate procedure.

(g) We may perform testing to verify your aerodynamic drag area values using any method specified in subpart F of this part. The following additional provisions apply:

(1) We intend to use the same aerodynamic test facility you used, and if you provide any instruments you used, we intend to use those instruments to perform our testing.

(2) We may perform coastdown testing to verify your tractor drag area for any certified configuration. If you use an alternate method for determining aerodynamic drag area for tractors, we may perform testing to verify  $F_{alt-aero}$  as specified in subpart F of this part.

(3) We may test trailers (and devices receiving preliminary approval) using the wind-tunnel method described in § 1037.530. We may also test using an

alternate method; however, we will determine how to appropriately correct or correlate those results to testing with the wind-tunnel method.

(h) You may ask us to use analytically derived GEM inputs for untested configurations as identified in subpart F of this part based on interpolation of all relevant measured values for related configurations, consistent with good engineering judgment. We may establish specific approval criteria base on prevailing industry practice. If we allow this, we may test any configurations. We may also require you to test any configurations as part of a selective enforcement audit.

**§ 1037.241 Demonstrating compliance with exhaust emission standards for greenhouse gas pollutants.**

(a) Compliance determinations for purposes of certification depend on whether or not you participate in the ABT program in subpart H of this part.

(1) If none of your vehicle families generate or use emission credits in a given model year, each of your vehicle families is considered in compliance with the CO<sub>2</sub> emission standards in §§ 1037.105 through 1037.107 if all vehicle configurations in the family have calculated or modeled CO<sub>2</sub> emission rates from § 1037.515 or § 1037.520 that are at or below the applicable standards. A vehicle family is deemed not to comply if any vehicle configuration in the family has a calculated or modeled CO<sub>2</sub> emission rate that is above the applicable standard.

(2) If you generate or use emission credits with one or more vehicle families in a given model year, your vehicle families within an averaging set are considered in compliance with the CO<sub>2</sub> emission standards in §§ 1037.105 through 1037.107 if the sum of positive and negative credits for all vehicle configurations in those vehicle families lead to a zero balance or a positive balance of credits, except as allowed by § 1037.745. Note that the FEL is considered to be the applicable emission standard for an individual configuration.

(b) For non-box trailers and non-aero box vans, your vehicle family is considered in compliance with the emission standards if all vehicle configurations in that family meet specified design standards and have TRRL values at or below the specified standard. Your family is deemed not to comply for certification if any trailer does not meet specified design standards or if any vehicle configuration in that family has a measured TRRL value above the specified standard.

(c) We may require you to provide an engineering analysis showing that the performance of your emission controls will not deteriorate during the useful life with proper maintenance. If we determine that your emission controls are likely to deteriorate during the useful life, we may require you to develop and apply deterioration factors consistent with good engineering judgment. For example, you may need to apply a deterioration factor to address deterioration of battery performance for a hybrid electric vehicle. Where the highest useful life emissions occur between the end of useful life and at the low-hour test point, base deterioration factors for the vehicles on the difference between (or ratio of) the point at which the highest emissions occur and the low-hour test point.

**§ 1037.243 Demonstrating compliance with evaporative emission standards.**

(a) For purposes of certification, your vehicle family is considered in compliance with the evaporative emission standards in subpart B of this part if you prepare an engineering analysis showing that your vehicles in the family will comply with applicable standards throughout the useful life, and there are no test results from an emission-data vehicle representing the family that exceed an emission standard.

(b) Your evaporative emission family is deemed not to comply if your engineering analysis is not adequate to show that all the vehicles in the family will comply with applicable emission standards throughout the useful life, or if a test result from an emission-data vehicle representing the family exceeds an emission standard.

(c) To compare emission levels with emission standards, apply deterioration factors to the measured emission levels. Establish an additive deterioration factor based on an engineering analysis that takes into account the expected aging from in-use vehicles.

(d) Apply the deterioration factor to the official emission result, as described in paragraph (c) of this section, then round the adjusted figure to the same number of decimal places as the emission standard. Compare the rounded emission levels to the emission standard for each emission-data vehicle.

(e) Your analysis to demonstrate compliance with emission standards must take into account your design strategy for vehicles that require testing. Specifically, vehicles above 14,000 pounds GVWR are presumed to need the same technologies that are required for heavy-duty vehicles at or below 14,000 pounds GVWR. Similarly, your

analysis to establish a deterioration factor must take into account your testing to establish deterioration factors for smaller vehicles.

**§ 1037.250 Reporting and recordkeeping.**

(a) Within 90 days after the end of the model year, send the Designated Compliance Officer a report including the total U.S.-directed production volume of vehicles you produced in each vehicle family during the model year (based on information available at the time of the report). Report by vehicle identification number and vehicle configuration and identify the subfamily identifier. Report uncertified vehicles sold to secondary vehicle manufacturers. We may waive the reporting requirements of this paragraph (a) for small manufacturers.

(b) Organize and maintain the following records:

(1) A copy of all applications and any summary information you send us.

(2) Any of the information we specify in § 1037.205 that you were not required to include in your application.

(3) A detailed history of each emission-data vehicle (including emission-related components), if applicable.

(4) Production figures for each vehicle family divided by assembly plant.

(5) Keep a list of vehicle identification numbers for all the vehicles you produce under each certificate of conformity. Also identify the technologies that make up the certified configuration for each vehicle you produce.

(c) Keep required data from emission tests and all other information specified in this section for eight years after we issue your certificate. If you use the same emission data or other information for a later model year, the eight-year period restarts with each year that you continue to rely on the information.

(d) Store these records in any format and on any media, as long as you can promptly send us organized, written records in English if we ask for them. You must keep these records readily available. We may review them at any time.

(e) If you fail to properly keep records or to promptly send us information as required under this part, we may require that you submit the information specified in this section after each calendar quarter, and we may require that you routinely send us information that the regulation requires you to submit only if we request it. If we find that you are fraudulent or grossly negligent or otherwise act in bad faith regarding information reporting and recordkeeping, we may require that you

send us a detailed description of the certified configuration for each vehicle before you produce it.

**§ 1037.255 What decisions may EPA make regarding my certificate of conformity?**

(a) If we determine your application is complete and shows that the vehicle family meets all the requirements of this part and the Act, we will issue a certificate of conformity for your vehicle family for that model year. We may make the approval subject to additional conditions.

(b) We may deny your application for certification if we determine that your vehicle family fails to comply with emission standards or other requirements of this part or the Clean Air Act. We will base our decision on all available information. If we deny your application, we will explain why in writing.

(c) In addition, we may deny your application or suspend or revoke your certificate if you do any of the following:

(1) Refuse to comply with any testing or reporting requirements.

(2) Submit false or incomplete information (paragraph (e) of this section applies if this is fraudulent). This includes doing anything after submission of your application to render any of the submitted information false or incomplete.

(3) Render any test data inaccurate.

(4) Deny us from completing authorized activities (see 40 CFR 1068.20). This includes a failure to provide reasonable assistance.

(5) Produce vehicles for importation into the United States at a location where local law prohibits us from carrying out authorized activities.

(6) Fail to supply requested information or amend your application to include all vehicles being produced.

(7) Take any action that otherwise circumvents the intent of the Act or this part, with respect to your vehicle family.

(d) We may void the certificate of conformity for a vehicle family if you

fail to keep records, send reports, or give us information as required under this part or the Act. Note that these are also violations of 40 CFR 1068.101(a)(2).

(e) We may void your certificate if we find that you intentionally submitted false or incomplete information. This includes rendering submitted information false or incomplete after submission.

(f) If we deny your application or suspend, revoke, or void your certificate, you may ask for a hearing (see § 1037.820).

**Subpart D—Testing Production Vehicles and Engines**

**§ 1037.301 Overview of measurements related to GEM inputs in a selective enforcement audit.**

(a) We may require you to perform selective enforcement audits under 40 CFR part 1068, subpart E, with respect to any GEM inputs in your application for certification. Sections 1037.305 through 1037.315 describe how this applies uniquely in certain circumstances.

(b) A selective enforcement audit for this part 1037 consists of performing measurements with production vehicles relative to one or more declared values for GEM inputs, and using those measured values in place of your declared values to run GEM. Except as specified in this subpart, the vehicle is considered passing if the new modeled emission result is at or below the modeled emission result corresponding to the declared GEM inputs. If you report an FEL for the vehicle configuration before the audit, we will instead consider the vehicle passing if the new cycle-weighted emission result matches or exceeds the efficiency improvement is at or below the FEL.

(c) We may audit your production components and your records to confirm that physical parameters are correct, such as dimensional accuracy and material selection. We may also audit your records to confirm that you are properly documenting the certified configurations of production vehicles.

(d) Selective enforcement audit provisions for fuel maps apply to engine manufacturers as specified in 40 CFR 1036.301. See § 1037.315 for selective enforcement audit provisions applicable to powertrain fuel maps.

(e) We may suspend or revoke certificates based on the outcome of a selective enforcement audit for any appropriate configurations within one or more vehicle families.

(f) We may apply selective enforcement audit provisions with respect to off-cycle technologies, with any necessary modifications, consistent with good engineering judgment.

**§ 1037.305 Audit procedures for tractors— aerodynamic testing.**

To perform a selective enforcement audit with respect to drag area for tractors, use the reference method specified in § 1037.525; we may instead require you to use the same method you used for certification. The following provisions apply instead of 40 CFR 1068.420 for a selective enforcement audit with respect to drag area:

(a) Determine whether or not a tractor fails to meet standards as follows:

(1) We will select a vehicle configuration for testing. Perform a coastdown measurement with the vehicle in its production configuration according to § 1037.528. Instead of the process described in § 1037.528(h)(12), determine your test result as described in this paragraph (a). You must have an equal number of runs in each direction.

(2) Measure a yaw curve for your test vehicle using your alternate method according to § 1037.525(b)(3). You do not need to test at the coastdown effective. You may use a previously established yaw curve from your certification testing if it is available.

(3) Using this yaw curve, perform a regression using values of drag area,  $C_{dA_{alt}}$ , and yaw angle,  $\psi_{alt}$ , to determine the air-direction correction coefficients,  $a_0$ ,  $a_1$ ,  $a_2$ ,  $a_3$ , and  $a_4$ , for the following equation:

$$C_{dA_{alt}}(\psi) = a_0 + a_1 \cdot \psi_{alt} + a_2 \cdot \psi_{alt}^2 + a_3 \cdot \psi_{alt}^3 + a_4 \cdot \psi_{alt}^4$$

Eq. 1037.305-1

(4) Adjust the drag area value from each coastdown run,  $C_{dA_{run}}$ , from the

yaw angle of each run,  $\psi_{run}$ , to  $\pm 4.5^\circ$  to represent a wind-averaged drag area

value,  $C_{dA_{wa}}$  by applying Eq. 1037.305-1 as follows:

$$C_d A_{wa-run} = C_d A_{run} \cdot \left[ \frac{C_d A_{alt,4.5^\circ} + C_d A_{alt,-4.5^\circ}}{C_d A_{alt,\psi run} + C_d A_{alt,-\psi run}} \right]$$

Eq. 1037.305-2

(5) Perform additional coastdown measurements until you reach a pass or fail decision under this paragraph (a).

(6) Calculate statistical values to characterize cumulative test results at

least once per day based on an equal number of coastdown runs in each direction. Determine the wind-averaged drag area value for the test  $C_d A_{wa}$  by averaging all  $C_d A_{wa-run}$  values for all

days of testing. Determine the upper and lower bounds of the drag area value,  $C_d A_{wa-bounded}$ , expressed to two decimal places, using a confidence interval as follows:

$$C_d A_{wa-bounded} = C_d A_{wa} \pm \left( \frac{1.5 \cdot \sigma}{\sqrt{n}} + 0.03 \right)$$

Eq. 1037.305-3

Where:

$C_d A_{wa-bounded}$  = the upper bound,  $C_d A_{wa-upper}$ , and lower bound,  $C_d A_{wa-lower}$ , of the drag area value, where  $C_d A_{wa-upper}$  is the larger number.

$C_d A_{wa}$  = the average of all  $C_d A_{wa-run}$  values.

$\sigma$  = the standard deviation of all  $C_d A_{run}$  values (see 40 CFR 1065.602(c)).

$n$  = the total number of coastdown runs.

(7) Compliance is determined based on the values of  $C_d A_{wa-upper}$  and  $C_d A_{wa-lower}$  relative to the adjusted bin boundary. For purposes of this section, the upper limit of a bin is expressed as the specified value plus 0.05 to account for rounding. For example, for a bin including values of 5.5–5.9 m<sup>2</sup>, being above the upper limit means exceeding 5.95. The vehicle reaches a pass or fail decision relative to the adjusted bin boundary based on one of the following criteria:

(i) The vehicle passes if  $C_d A_{wa-upper}$  is less than or equal to the upper limit of the bin to which you certified the vehicle.

(ii) The vehicle fails if  $C_d A_{wa-lower}$  is greater than the upper limit of the bin to which you certified the vehicle.

(iii) The vehicle passes if you perform 100 coastdown runs and  $C_d A_{wa-upper}$  is greater than and  $C_d A_{wa-lower}$  is lower than the upper limit of the bin to which you certified the vehicle.

(iv) The vehicle fails if you choose to stop testing before reaching a final determination under this paragraph (a)(7).

(b) If you reach a pass decision on the first test vehicle, the emission family passes the SEA and you may stop testing. If you reach a fail decision on the first test vehicle, repeat the testing described in paragraph (a) of this section for two additional vehicles of

the same configuration, or of a different configuration that we specify. Continue testing two additional vehicles for each failing vehicle until you reach a pass or fail decision for the family based on one of the following criteria:

(1) The emission family passes if at any point more than 50 percent of the vehicles have reached a pass decision.

(2) The emission family fails if six vehicles reach a fail decision.

(3) The emission family passes if you test 11 vehicles with five or fewer vehicles reaching a fail decision.

(4) The emission family fails if you choose to stop testing before reaching a final determination under this paragraph (b).

(c) We may suspend a certificate of conformity as described in 40 CFR 1068.430 if your emission family fails an SEA, subject to the following provisions:

(1) We may reinstate a suspended certificate if you revise  $F_{alt-aero}$  or make other changes to your testing methodology to properly correlate your testing to the reference method specified in § 1037.525.

(2) We may require you to apply any adjustments and corrections determined under paragraph (c)(1) of this section to your other emission families in any future application for certification.

(d) If we test some of your vehicles in addition to your testing, we may decide not to include your test results as official data for those vehicles if there is substantial disagreement between your testing and our testing. We will reinstate your data as valid if you show us that we made an error and your data are correct. If we perform testing, we may choose to stop testing after any number of tests and not determine a failure.

(e) If we rely on our test data instead of yours, we will notify you in writing of our decision and the reasons we believe your facility is not appropriate for doing the tests we require under this paragraph (b). You may request in writing that we consider your test results from the same facility for future testing if you show us that you have made changes to resolve the problem.

(f) We may allow you to perform additional replicate tests with a given vehicle or to test additional vehicles, consistent with good engineering judgment.

(g) You must assign the appropriate  $C_d A$  bin for your compliance demonstration at the end of the model year for every configuration you tested that failed under this section.

#### § 1037.310 Audit procedures for trailers.

(a) We may audit trailer manufacturers to ensure that trailers are being produced to conform with the certificate of conformity. If this involves aerodynamic measurements, we will specify how to adapt the protocol described in § 1037.305 to appropriately evaluate trailer performance.

(b) We may require device manufacturers that obtain preliminary approval under § 1037.211 to perform aerodynamic testing of production samples of approved devices to ensure that the devices conform to the approved configuration.

#### § 1037.315 Audit procedures related to powertrain testing.

(a) For vehicles certified based on powertrain testing as specified in § 1037.550, we may apply the selective enforcement audit requirements to the powertrain. If engine manufacturers

perform the powertrain testing and include those results in their certification under 40 CFR part 1036, they are responsible for selective enforcement audits related to those results. Otherwise, the certificate holder for the vehicle is responsible for the selective enforcement audit.

(b) The following provisions apply for a selective enforcement audit with respect to powertrain testing:

(1) A selective enforcement audit for powertrains would generally consist of performing a test with the complete powertrain (engine and transmission together). We may alternatively allow you to test the engine on a dynamometer with no installed transmission as described in § 1037.551.

(2) Recreate a set of test results for each of three separate powertrains. Generate GEM results for each of the configurations that are defined as the centers of each group of four points that define a boundary of cycle work and average powertrain speed divided by average vehicle speed, for each of the three selected powertrains. See 40 CFR 1036.301(b)(2) for an example on how these points are defined. Each unique map for a given configuration with a particular powertrain constitutes a separate test for purposes of evaluating whether the vehicle family meets the pass-fail criteria under 40 CFR 1068.420. The test result for a single test run in the audit is considered passing if it is at or below the value selected as an input for GEM. Perform testing with the same GEM configurations for additional powertrains as needed to reach a pass-fail decision under 40 CFR 1068.240.

#### **§ 1037.320 Audit procedures for axles and transmissions.**

Selective enforcement audit provisions apply for axles and transmissions relative to the efficiency demonstrations of §§ 1037.560 and 1037.565 as follows:

(a) A selective enforcement audit for axles or transmissions would consist of performing measurements with a production axle or transmission to determine mean power loss values as declared for GEM simulations, and running GEM over one or more applicable duty cycles based on those measured values. The engine is considered passing for a given configuration if the new modeled emission result for every applicable duty cycle is at or below the modeled emission result corresponding to the declared GEM inputs.

(b) Run GEM for each applicable vehicle configuration identified in 40 CFR 1036.540. For axle testing, this may require omitting several vehicle

configurations based on selecting axle ratios that correspond to the tested axle. The GEM result for each vehicle configuration counts as a separate test for determining whether the family passes or fails the audit. Select additional production axles or transmissions to perform additional tests as needed.

#### **Subpart E—In-Use Testing**

##### **§ 1037.401 General provisions.**

(a) We may perform in-use testing of any vehicle subject to the standards of this part. For example, we may test vehicles to verify drag areas or other GEM inputs as specified in paragraph (b) of this section.

(b) We may measure the drag area of a vehicle you produced after it has been placed into service. We may use any of the procedures as specified in §§ 1037.525 through 1037.527 for measuring drag area. Your vehicle conforms to the regulations of this part with respect to aerodynamic performance if we measure its drag area to be at or below the maximum drag area allowed for the bin to which that configuration was certified.

#### **Subpart F—Test and Modeling Procedures**

##### **§ 1037.501 General testing and modeling provisions.**

This subpart specifies how to perform emission testing and emission modeling required elsewhere in this part.

(a) Except as specified in subpart B of this part, you must demonstrate that you meet emission standards using emission modeling as described in §§ 1037.515 and 1037.520. This modeling depends on several measured values as described in this subpart F. You may use fuel-mapping information from the engine manufacturer as described in 40 CFR 1036.535 and 1036.540, or you may use powertrain testing as described in § 1037.550.

(b) Where exhaust emission testing is required, use equipment and procedures as described in 40 CFR part 1065 and part 1066. Measure emissions of all the exhaust constituents subject to emission standards as specified in 40 CFR part 1065 and part 1066. Use the applicable duty cycles specified in § 1037.510.

(c) See 40 CFR 86.101 and 86.1813 for measurement procedures that apply for evaporative and refueling emissions.

(d) Use the applicable fuels specified 40 CFR part 1065 to perform valid tests.

(1) For service accumulation, use the test fuel or any commercially available fuel that is representative of the fuel that in-use vehicles will use.

(2) For diesel-fueled vehicles, use the appropriate diesel fuel specified for emission testing. Unless we specify otherwise, the appropriate diesel test fuel is ultra-low sulfur diesel fuel.

(3) For gasoline-fueled vehicles, use the gasoline for “general testing” as specified in 40 CFR 86.1305.

(e) You may use special or alternate procedures as specified in 40 CFR 1065.10.

(f) This subpart is addressed to you as a manufacturer, but it applies equally to anyone who does testing for you, and to us when we perform testing to determine if your vehicles meet emission standards.

(g) Apply this paragraph (g) whenever we specify the use of standard trailers. Unless otherwise specified, a tolerance of  $\pm 2$  inches applies for all nominal trailer dimensions.

(1) The standard trailer for high-roof tractors must meet the following criteria:

(i) It is an unloaded two-axle dry van 53.0 feet long, 102 inches wide, and 162 inches high (measured from the ground with the trailer level).

(ii) It has a king pin located with its center  $36 \pm 0.5$  inches from the front of the trailer and a minimized trailer gap (no greater than 45 inches).

(iii) It has a simple orthogonal shape with smooth surfaces and nominally flush rivets. Except as specified in paragraph (g)(1)(v) of this section, the standard trailer does not include any aerodynamic features such as side fairings, rear fairings, or gap reducers. It may have a scuff band no more than 0.13 inches thick.

(iv) It includes dual 22.5 inch wheels, standard tandem axle, standard mudflaps, and standard landing gear. The centerline of the tandem axle assembly must be  $145 \pm 5$  inches from the rear of the trailer. The landing gear must be installed in a conventional configuration.

(v) For the Phase 2 standards, include side skirts meeting the specifications of this paragraph (g)(1)(v). The side skirts must be mounted flush with both sides of the trailer. The skirts must be an isosceles trapezoidal shape. Each skirt must have a height of  $36 \pm 2$  inches. The top edge of the skirt must be straight with a length of  $341 \pm 2$  inches. The bottom edge of the skirt must be straight with a length of  $268 \pm 2$  inches and have a ground clearance of  $8 \pm 2$  inches through that full length. The sides of the skirts must be straight. The rearmost point of the skirts must be mounted  $32 \pm 2$  inches in front of the centerline of the trailer tandem axle assembly. We may approve your request to use a skirt with different dimensions if these

specified values are impractical or inappropriate for your test trailer, and you propose alternative dimensions that provide an equivalent or comparable degree of aerodynamic drag for your test configuration.

(2) The standard trailer for mid-roof tractors is an empty two-axle tank trailer  $42 \pm 1$  feet long by 140 inches high and 102 inches wide.

(i) It has a  $40 \pm 1$  feet long cylindrical tank with a  $7000 \pm 7$  gallon capacity, smooth surface, and rounded ends.

(ii) The standard tank trailer does not include any aerodynamic features such as side fairings, but does include a centered 20 inch manhole, side-centered ladder, and lengthwise walkway. It includes dual 24.5 inch wheels.

(3) The standard trailer for low-roof tractors is an unloaded two-axle flatbed trailer  $53 \pm 1$  feet long and 102 inches wide.

(i) The deck height is  $60.0 \pm 0.5$  inches in the front and  $55.0 \pm 0.5$  inches in the rear. The standard trailer does not include any aerodynamic features such as side fairings.

(ii) It includes an air suspension and dual 22.5 inch wheels on tandem axles.

(h) Use a standard tractor for measuring aerodynamic drag of trailers. Standard tractors must be certified at Bin III (or more aerodynamic if a Bin III tractor is unavailable) for Phase 1 or Phase 2 under § 1037.520(b)(1) or (3). The standard tractor for long trailers is a Class 8 high-roof sleeper cab. The standard tractor for short trailers is a Class 7 or Class 8 high-roof day cab with a  $4 \times 2$  drive-axle configuration.

#### § 1037.510 Duty-cycle exhaust testing.

This section applies for powertrain testing, cycle-average engine fuel mapping, certain off-cycle testing under § 1037.610, and the advanced-technology provisions of § 1037.615.

(a) Measure emissions by testing the vehicle on a chassis dynamometer or the powertrain on a powertrain dynamometer with the applicable duty cycles. Each duty cycle consists of a series of speed commands over time—variable speeds for the transient test and constant speeds for the highway cruise tests. None of these cycles include vehicle starting or warmup.

(1) Perform testing for Phase 1 vehicles as follows to generate credits or adjustment factors for off-cycle or advanced technologies:

(i) *Transient cycle.* The transient cycle is specified in Appendix I of this part. Warm up the vehicle. Start the duty cycle within 30 seconds after concluding the preconditioning procedure. Start sampling emissions at the start of the duty cycle.

(ii) *Cruise cycle.* For the 55 mi/hr and 65 mi/hr highway cruise cycles, warm up the vehicle at the test speed, then sample emissions for 300 seconds while maintaining vehicle speed within  $\pm 1.0$  mi/hr of the speed setpoint; this speed tolerance applies instead of the approach specified in 40 CFR 1066.425(b)(1) and (2).

(2) For cycle-average engine fuel mapping under 40 CFR 1036.540 or powertrain testing under §§ 1037.550 or 1037.555, perform testing as described in this paragraph (a)(2) to generate GEM inputs for each simulated vehicle configuration, and for each of the four test runs representing different idle speed settings. You may perform any number of these test runs directly in succession once the engine or powertrain is warmed up. If you interrupt the test sequence with a break of up to 30 minutes, such as to perform analyzer calibration, repeat operation over the previous duty cycle to precondition the vehicle before restarting the test sequence. Perform testing as follows:

(i) *Transient cycle.* The transient cycle is specified in Appendix I of this part. Initially warm up the engine or powertrain by operating over one transient cycle. Within 60 seconds after concluding the warm up cycle, start emission sampling while the vehicle operates over the duty cycle.

(ii) *Highway cruise cycle.* The grade portion of the route corresponding to the 55 mi/hr and 65 mi/hr highway cruise cycles is specified in Appendix IV of this part. Initially warm up the engine or powertrain by operating it over the duty cycle. Within 60 seconds after concluding the preconditioning cycle, start emission sampling while the vehicle operates over the duty cycle, maintaining vehicle speed between

– 1.0 mi/hr and 3.0 mi/hr of the speed setpoint; this speed tolerance applies instead of the approach specified in 40 CFR 1066.425(b)(1) and (2).

(iii) *Drive idle.* Perform testing at a loaded idle condition for Phase 2 vocational vehicles. Warm up the powertrain by operating it at 65 mi/hr for 600 seconds. Within 10 seconds after concluding the preconditioning cycle, set the engine to operate at idle speed for 90 seconds, with the brake applied and the transmission in drive (or clutch depressed for manual transmission), and sample emissions to determine mean emission values (in g/s) over the last 30 seconds of idling.

(iv) *Parked idle.* Perform testing at an unloaded idle condition for Phase 2 vocational vehicles. Warm up the powertrain by operating it at 65 mi/hr for 600 seconds. Within 60 seconds after concluding the preconditioning cycle, set the engine to operate at idle speed for 600 seconds, with the transmission in park (or the transmission in neutral with the parking brake applied for manual transmissions), and sample emissions to determine mean emission values (in g/s) over the full 600 seconds of idling.

(3) Where applicable, perform testing on a chassis dynamometer as follows:

(i) *Transient cycle.* The transient cycle is specified in Appendix I of this part. Warm up the vehicle by operating over one transient cycle. Within 60 seconds after concluding the warm up cycle, start emission sampling and operate the vehicle over the duty cycle.

(ii) *Highway cruise cycle.* The grade portion of the route corresponding to the 55 mi/hr and 65 mi/hr highway cruise cycles is specified in Appendix IV of this part. Warm up the vehicle by operating it at the appropriate speed setpoint over the duty cycle. Within 60 seconds after concluding the preconditioning cycle, start emission sampling and operate the vehicle over the duty cycle, maintaining vehicle speed within  $\pm 1.0$  mi/hr of the speed setpoint; this speed tolerance applies instead of the approach specified in 40 CFR 1066.425(b)(1) and (2).

(b) Calculate the official emission result from the following equation:

$$e_{CO2comp} = \frac{1}{PL \cdot \bar{v}_{moving} \cdot (1 - w_{drive-idle} - w_{parked-idle})} \cdot \left( (1 - w_{drive-idle} - w_{parked-idle}) \cdot \left( \frac{w_{transient} \cdot m_{transient}}{D_{transient}} + \frac{w_{55} \cdot m_{55}}{D_{55}} + \frac{w_{65} \cdot m_{65}}{D_{65}} \right) \cdot \bar{v}_{moving} + w_{drive-idle} \cdot \bar{m}_{drive-idle} + w_{parked-idle} \cdot \bar{m}_{parked-idle} \right)$$

Eq. 1037.510-1

Where:

$e_{CO2comp}$  = total composite mass of CO<sub>2</sub> emissions in g/ton-mile, rounded to the nearest whole number for vocational vehicles and to the first decimal place for tractors.

$PL$  = the standard payload, in tons, as specified in § 1037.705.

$\bar{v}_{moving}$  = mean composite weighted driven vehicle speed, excluding idle operation, as shown in Table 1 of this section for Phase 2 vocational vehicles. For other vehicles, let  $\bar{v}_{moving} = 1$ .

$w_{[cycle]}$  = weighting factor for the appropriate test cycle, as shown in Table 1 of this section.

$m_{[cycle]}$  = CO<sub>2</sub> mass emissions over each test cycle (other than idle).

$D_{[cycle]}$  = the total driving distance for the indicated duty cycle. Use 2.842 miles for the transient cycle, and use 13.429 miles for both of the highway cruise cycles.

$\bar{m}_{[cycle]-idle}$  = CO<sub>2</sub> emission rate at idle.

*Example:* Class 7 vocational vehicle meeting the Phase 2 standards based on the Regional duty cycle.  
 $PL = 5.6$  tons

$\bar{v}_{moving} = 38.41$  mi/hr

$w_{transient} = 20\% = 0.20$

$w_{drive-idle} = 0\% = 0$

$w_{parked-idle} = 25\% = 0.25$

$w_{55} = 24\% = 0.24$

$w_{65} = 56\% = 0.56$

$m_{transient} = 4083$  g

$m_{55} = 13834$  g

$m_{65} = 17018$  g

$D_{transient} = 2.8449$  miles

$D_{55} = 13.429$  miles

$D_{65} = 13.429$  miles

$\bar{m}_{drive-idle} = 4188$  g/hr

$\bar{m}_{parked-idle} = 3709$  g/hr

$$e_{CO2} = \frac{1}{5.6 \cdot 41.93 \cdot (1 - 0 - 0.25)} \cdot \left( (1 - 0.0 - 0.25) \cdot \left( \frac{0.20 \cdot 4083}{2.8449} + \frac{0.24 \cdot 13834}{13.429} + \frac{0.56 \cdot 17018}{13.429} \right) \cdot 41.93 + 0.0 \cdot 4188 + 0.25 \cdot 3709 \right) = 228 \text{ g/ton-mile}$$

(c) Weighting factors apply for each type of vehicle and for each duty cycle as follows:

(1) GEM applies weighting factors for specific types of tractors as shown in Table 1 of this section.

(2) GEM applies weighting factors for vocational vehicles as shown in Table 1 of this section. Modeling for Phase 2 vocational vehicles depends on characterizing vehicles by duty cycle to apply proper weighting factors and average speed values. Select either

Urban, Regional, or Multi-Purpose as the most appropriate duty cycle for modeling emission results with each vehicle configuration, as specified in §§ 1037.140 and 1037.150.

(3) Table 1 follows:

TABLE 1 OF § 1037.510—WEIGHTING FACTORS FOR DUTY CYCLES

	Distance-weighted			Time-weighted <sup>1</sup>			Average speed during non-idle cycles (mi/hr) <sup>2</sup>
	Transient	55 mi/hr cruise (percent)	65 mi/hr cruise (percent)	Drive idle (percent)	Parked idle (percent)	Non-idle (percent)	
Day Cabs .....	19	17	64	.....	.....	.....	.....
Sleeper Cabs .....	5	9	86	.....	.....	.....	.....
Heavy-haul tractors .....	19	17	64	.....	.....	.....	.....
Vocational—Regional .....	20	24	56	0	25	75	38.41
Vocational—Multi-Purpose (2b-7) .....	54	29	17	17	25	58	23.18
Vocational—Multi-Purpose (8) .....	54	23	23	17	25	58	23.27
Vocational—Urban (2b-7) .....	92	8	0	15	25	60	16.25
Vocational—Urban (8) .....	90	10	0	15	25	60	16.51
Vocational with conventional powertrain (Phase 1 only) .....	42	21	37	.....	.....	.....	.....
Vocational Hybrid Vehicles (Phase 1 only) .....	75	9	16	.....	.....	.....	.....

<sup>1</sup> Note that these drive idle and non-idle weighting factors do not reflect additional drive idle that occurs during the transient cycle. The transient cycle does not include any parked idle.

<sup>2</sup> These values apply even for vehicles not following the specified speed traces.

(d) For transient testing, compare actual second-by-second vehicle speed

with the speed specified in the test cycle and ensure any differences are

consistent with the criteria as specified in 40 CFR 1066.425. If the speeds do not

conform to these criteria, the test is not valid and must be repeated.

(e) Run test cycles as specified in 40 CFR part 1066. For testing vehicles equipped with cruise control over the highway cruise cycles, use the vehicle's cruise control to control the vehicle speed. For vehicles equipped with adjustable vehicle speed limiters, test the vehicle with the vehicle speed limiter at its highest setting.

(f) For Phase 1, test the vehicle using its adjusted loaded vehicle weight,

unless we determine this would be unrepresentative of in-use operation as specified in 40 CFR 1065.10(c)(1).

(g) For hybrid vehicles, correct for the net energy change of the energy storage device as described in 40 CFR 1066.501.

**§ 1037.515 Determining CO<sub>2</sub> emissions to show compliance for trailers.**

This section describes a compliance approach for trailers that is consistent with the modeling for vocational vehicles and tractors described in

§ 1037.520, but is simplified consistent with the smaller number of trailer parameters that affect CO<sub>2</sub> emissions. Note that the calculated CO<sub>2</sub> emission rate, *e*<sub>CO<sub>2</sub></sub>, is equivalent to the value that would result from running GEM with the same input values.

(a) *Compliance equation.* Calculate CO<sub>2</sub> emissions for demonstrating compliance with emission standards for each trailer configuration.

(1) Use the following equation:

$$e_{CO_2} = (C_1 + C_2 \cdot TRRL + C_3 \cdot \Delta C_d A + C_4 \cdot WR) \cdot C_5$$

Eq. 1037.515-1

Where:

*C<sub>i</sub>* = constant values for calculating CO<sub>2</sub> emissions from this regression equation derived from GEM, as shown in Table 1 of this section. Let *C<sub>5</sub>* = 0.988 for trailers

that have automatic tire inflation systems with all wheels, and let *C<sub>5</sub>* = 0.990 for trailers that have tire pressure monitoring systems with all wheels (or a mix of the two systems); otherwise, let *C<sub>5</sub>* = 1.

*TRRL* = tire rolling resistance level as specified in paragraph (b) of this section. *ΔC<sub>d</sub>A* = the *ΔC<sub>d</sub>A* value for the trailer as specified in paragraph (c) of this section. *WR* = weight reduction as specified in paragraph (d) or (e) of this section.

TABLE 1 OF § 1037.515—REGRESSION COEFFICIENTS FOR CALCULATING CO<sub>2</sub> EMISSIONS

Trailer category	<i>C<sub>1</sub></i>	<i>C<sub>2</sub></i>	<i>C<sub>3</sub></i>	<i>C<sub>4</sub></i>
Long dry box van .....	76.1	1.67	-5.82	-0.00103
Long refrigerated box van .....	77.4	1.75	-5.78	-0.00103
Short dry box van .....	117.8	1.78	-9.48	-0.00258
Short refrigerated box van .....	121.1	1.88	-9.36	-0.00264

(2) The following is an example for calculating the mass of CO<sub>2</sub> emissions, *e*<sub>CO<sub>2</sub></sub>, from a long dry box van that has a tire pressure monitoring system for all wheels, an aluminum suspension assembly, aluminum floor, and is designated as Bin IV:

*C<sub>1</sub>* = 76.1  
*C<sub>2</sub>* = 1.67  
*TRRL* = 4.6 kg/tonne  
*C<sub>3</sub>* = -5.82  
*ΔC<sub>d</sub>A* = 0.7 m<sup>2</sup>  
*C<sub>4</sub>* = -0.00103  
*WR* = 655 lbs  
*C<sub>5</sub>* = 0.990  
*e*<sub>CO<sub>2</sub></sub> = (76.1 + 1.67 + (-5.82 · 0.7) + (-0.00103 · 655)) · 0.990  
*e*<sub>CO<sub>2</sub></sub> = 78.24 g/ton-mile

(b) *Tire rolling resistance.* Use the procedure specified in § 1037.520(c) to

determine the tire rolling resistance level for your tires. Note that you may base tire rolling resistance levels on measurements performed by tire manufacturers, as long as those measurements meet this part's specifications.

(c) *Drag area.* You may use *ΔC<sub>d</sub>A* values approved under § 1037.211 for device manufacturers if your trailers are properly equipped with those devices. Determine *ΔC<sub>d</sub>A* values for other trailers based on testing. Measure *C<sub>d</sub>A* and determine *ΔC<sub>d</sub>A* values as described in § 1037.526(a). You may use *ΔC<sub>d</sub>A* values from one trailer configuration to represent any number of additional trailers based on worst-case testing. This means that you may apply *ΔC<sub>d</sub>A* values from your measurements to any trailer

models of the same category with drag area at or below that of the tested configuration. For trailers in the short dry box vans and short refrigerated box vans that are not 28 feet long, apply the *ΔC<sub>d</sub>A* value established for a comparable 28-foot trailer model; you may use the same devices designed for 28-foot trailers or you may adapt those devices as appropriate for the different trailer length, consistent with good engineering judgment. For example, 48-foot trailers may use longer side skirts than the skirts that were tested with a 28-foot trailer. Trailer and device manufacturers may seek preliminary approval for these adaptations. Determine bin levels based on *ΔC<sub>d</sub>A* test results as described in the following table:

TABLE 2 OF § 1037.515—BIN DETERMINATIONS FOR TRAILERS BASED ON AERODYNAMIC TEST RESULTS

[*ΔC<sub>d</sub>A* in m<sup>2</sup>]

If a trailer's measured <i>ΔC<sub>d</sub>A</i> is . . .	designate the trailer as . . .	and use the following value for <i>ΔC<sub>d</sub>A</i>
≤0.09 .....	Bin I .....	0.0
0.10–0.39 .....	Bin II .....	0.1
0.40–0.69 .....	Bin III .....	0.4
0.70–0.99 .....	Bin IV .....	0.7



TABLE 2 OF § 1037.515—BIN DETERMINATIONS FOR TRAILERS BASED ON AERODYNAMIC TEST RESULTS—Continued  
[ $\Delta C_d A$  in m<sup>2</sup>]

If a trailer's measured $\Delta C_d A$ is . . . . .	designate the trailer as . . . . .	and use the following value for $\Delta C_d A$
1.00–1.39 .....	Bin V .....	1.0
1.40–1.79 .....	Bin VI .....	1.4
>1.80 .....	Bin VII .....	1.8

(d) *Weight reduction.* Determine weight reduction for a trailer configuration by summing all applicable values, as follows:

(1) Determine weight reduction for using lightweight materials for wheels as described in § 1037.520(e).

(2) Apply weight reductions for other components made with light-weight materials as shown in the following table:

TABLE 3 OF § 1037.515—WEIGHT REDUCTIONS FOR TRAILERS  
[pounds]

Component	Material	Weight reduction (pounds)
Structure for Suspension Assembly <sup>1</sup> .....	Aluminum .....	280
Hub and Drum (per axle) .....	Aluminum .....	80
Floor <sup>2</sup> .....	Aluminum .....	375
Floor <sup>2</sup> .....	Composite (wood and plastic) .....	245
Floor Crossmembers <sup>2</sup> .....	Aluminum .....	250
Landing Gear .....	Aluminum .....	50
Rear Door .....	Aluminum .....	187
Rear Door Surround .....	Aluminum .....	150
Roof Bows .....	Aluminum .....	100
Side Posts .....	Aluminum .....	300
Slider Box .....	Aluminum .....	150
Upper Coupler Assembly .....	Aluminum .....	430

<sup>1</sup> For tandem-axle suspension sub-frames made of aluminum, apply a weight reduction of 280 pounds. Use good engineering judgment to estimate a weight reduction for using aluminum sub-frames with other axle configurations.

<sup>2</sup> Calculate a smaller weight reduction for short trailers by multiplying the indicated values by 0.528 (28/53).

(e) *Off-cycle.* You may apply the off-cycle provisions of § 1037.610 to trailers as follows:

(1) You may account for weight reduction based on measured values instead of using paragraph (d) of this section. Quantify the weight reduction by measuring the weight of a trailer in a certified configuration and comparing it to the weight of an equivalent trailer without weight-reduction technologies. This qualifies as A to B testing under § 1037.610. Use good engineering judgment to select an equivalent trailer representing a baseline configuration. Use the calculated weight reduction in Eq. 1037.515–1 to calculate the trailer's CO<sub>2</sub> emission rate.

(2) If your off-cycle technology reduces emissions in a way that is proportional to measured emissions as described in § 1037.610(b)(1), multiply the trailer's CO<sub>2</sub> emission rate by the appropriate improvement factor.

(3) If your off-cycle technology does not yield emission reductions that are proportional to measured emissions, as described in § 1037.610(b)(2), calculate an adjusted CO<sub>2</sub> emission rate for your

trailers by subtracting the appropriate off-cycle credit.

(4) Note that these off-cycle provisions do not apply for trailers subject to design standards.

**§ 1037.520 Modeling CO<sub>2</sub> emissions to show compliance for vocational vehicles and tractors.**

This section describes how to use the Greenhouse gas Emissions Model (GEM) (incorporated by reference in § 1037.810) to show compliance with the CO<sub>2</sub> standards of §§ 1037.105 and 1037.106 for vocational vehicles and tractors. Use GEM version 2.0.1 to demonstrate compliance with Phase 1 standards; use GEM Phase 2, Version 3.0 to demonstrate compliance with Phase 2 standards. Use good engineering judgment when demonstrating compliance using GEM. See § 1037.515 for calculation procedures for demonstrating compliance with trailer standards.

(a) *General modeling provisions.* To run GEM, enter all applicable inputs as specified by the model.

(1) GEM inputs apply for Phase 1 standards as follows:

(i) Model year and regulatory subcategory (see § 1037.230).

(ii) Coefficient of aerodynamic drag or drag area, as described in paragraph (b) of this section (tractors only).

(iii) Steer and drive tire rolling resistance, as described in paragraph (c) of this section.

(iv) Vehicle speed limit, as described in paragraph (d) of this section (tractors only).

(v) Vehicle weight reduction, as described in paragraph (e) of this section (tractors only for Phase 1).

(vi) Automatic engine shutdown systems, as described in § 1037.660 (only for Class 8 sleeper cabs). Enter a GEM input value of 5.0 g/ton-mile, or an adjusted value as specified in § 1037.660.

(2) For Phase 2 vehicles, the GEM inputs described in paragraphs (a)(1)(i) through (v) of this section continue to apply. Note that the provisions related to vehicle speed limiters and automatic engine shutdown systems are available for vocational vehicles in Phase 2. The

rest of this section describes additional GEM inputs for demonstrating compliance with Phase 2 standards. Simplified versions of GEM apply for limited circumstances as follows:

- (i) You may use default engine fuel maps for glider kits as described in § 1037.635.
- (ii) If you certify vehicles to the custom-chassis standards specified in § 1037.105(h), run GEM by identifying the vehicle type and entering "NA" instead of what would otherwise apply

for, tire revolutions per mile, engine information, transmission information, drive axle ratio, axle efficiency, and aerodynamic improvement as specified in paragraphs (c)(1), (f), (g)(1), (g)(3), (i), and (m) of this section, respectively. Incorporate other GEM inputs as specified in this section.

(b) *Coefficient of aerodynamic drag and drag area for tractors.* Determine the appropriate drag area,  $C_dA$ , for tractors as described in this paragraph

(b). Use the recommended method or an alternate method to establish a value for  $C_dA$  expressed in  $m^2$  to one decimal place, as specified in § 1037.525. Where we allow you to group multiple configurations together, measure  $C_dA$  of the worst-case configuration.

(1) Except as specified in paragraph (b)(2) of this section, determine the Phase 1 bin level for your vehicle based on measured  $C_dA$  values as shown in the following tables: $C_dA$

TABLE 1 OF § 1037.520— $C_d$  INPUTS FOR PHASE 1 HIGH-ROOF TRACTORS

Tractor type	Bin level	If your measured $\Delta C_dA$ ( $m^2$ ) is . . .	Then your $C_d$ input is . . .
High-Roof Day Cabs	Bin I	$\geq 8.0$	0.79
	Bin II	7.1–7.9	0.72
	Bin III	6.2–7.0	0.63
	Bin IV	5.6–6.1	0.56
	Bin V	$\leq 5.5$	0.51
High-Roof Sleeper Cabs	Bin I	$\geq 7.6$	0.75
	Bin II	6.8–7.5	0.68
	Bin III	6.3–6.7	0.60
	Bin IV	5.6–6.2	0.52
	Bin V	$\leq 5.5$	0.47

TABLE 2 OF § 1037.520— $C_d$  INPUTS FOR PHASE 1 LOW-ROOF AND MID-ROOF TRACTORS

Tractor type	Bin level	If your measured $C_dA$ ( $m^2$ ) is . . .	Then your $C_d$ input is . . .
Low-Roof Day and Sleeper Cabs	Bin I	$\geq 5.1$	0.77
	Bin II	$\leq 5.0$	0.71
Mid-Roof Day and Sleeper Cabs	Bin I	$\geq 5.6$	0.87
	Bin II	$\leq 5.5$	0.82

(2) For Phase 1 low- and mid-roof tractors, you may instead determine your drag area bin based on the drag area bin of an equivalent high-roof tractor. If the high-roof tractor is in Bin I or Bin II, then you may assume your equivalent low- and mid-roof tractors

are in Bin I. If the high-roof tractor is in Bin III, Bin IV, or Bin V, then you may assume your equivalent low- and mid-roof tractors are in Bin II.

(3) For Phase 2 tractors other than heavy-haul tractors, determine bin levels and  $C_dA$  inputs as follows:

(i) Determine bin levels for high-roof tractors based on aerodynamic test results as described in the following table:

TABLE 3 OF § 1037.520—BIN DETERMINATIONS FOR PHASE 2 HIGH-ROOF TRACTORS BASED ON AERODYNAMIC TEST RESULTS  
[ $C_dA$  in  $m^2$ ]

Tractor type	Bin I	Bin II	Bin III	Bin IV	Bin V	Bin VI	Bin VII
Day Cabs	$\geq 7.2$	6.6–7.1	6.0–6.5	5.5–5.9	5.0–5.4	4.5–4.9	$\leq 4.4$
Sleeper Cabs	$\geq 6.9$	6.3–6.8	5.7–6.2	5.2–5.6	4.7–5.1	4.2–4.6	$\leq 4.1$

(ii) For low- and mid-roof tractors, you may either use the same bin level that applies for an equivalent high-roof

tractor as shown in Table 3 of this section, or you may determine your bin

level based on aerodynamic test results as described in Table 4 of this section.

TABLE 4 OF § 1037.520—BIN DETERMINATIONS FOR PHASE 2 LOW-ROOF AND MID-ROOF TRACTORS BASED ON AERODYNAMIC TEST RESULTS  
[ $C_dA$  in  $m^2$ ]

Tractor type	Bin I	Bin II	Bin III	Bin IV	Bin V	Bin VI	Bin VII
Low-Roof Cabs .....	≥5.4	4.9–5.3	44.5–4.8	4.1–4.4	3.8–4.0	3.5–3.7	≤3.4
Mid-Roof Cabs .....	≥5.9	5.5–5.8	5.1–5.4	4.7–5.0	4.4–4.6	4.1–4.3	≤4.0

(iii) Determine the  $C_dA$  input according to the tractor’s bin level as described in the following table:

TABLE 5 OF § 1037.520—PHASE 2  $C_dA$  TRACTOR INPUTS BASED ON BIN LEVEL

Tractor type	Bin I	Bin II	Bin III	Bin IV	Bin V	Bin VI	Bin VII
High-Roof Day Cabs ....	7.45	6.85	6.25	5.70	5.20	4.70	4.20
High-Roof Sleeper Cabs .....	7.15	6.55	5.95	5.40	4.90	4.40	3.90
Low-Roof Cabs .....	6.00	5.60	5.15	4.75	4.40	4.10	3.80
Mid-Roof Cabs .....	7.00	6.65	6.25	5.85	5.50	5.20	4.90

(4) Note that, starting in model year 2027, GEM internally reduces  $C_{dA}$  for high-roof tractors by 0.3  $m^2$  to simulate adding a rear fairing to the standard trailer.

(c) *Tire revolutions per mile and rolling resistance.* You must have a tire revolutions per mile (TRPM) and a tire rolling resistance level (TRRL) for each tire configuration. For purposes of this section, you may consider tires with the same SKU number to be the same configuration. Determine TRRL input values separately for drive and steer tires; determine TRPM only for drive tires.

(1) Use good engineering judgment to determine a tire’s revolutions per mile to the nearest whole number as specified in SAE J1025 (incorporated by reference in § 1037.810). Note that for tire sizes that you do not test, we will treat your analytically derived revolutions per mile the same as test results, and we may perform our own testing to verify your values. We may require you to test a sample of additional tire sizes that we select.

(2) Measure tire rolling resistance in kg per metric ton as specified in ISO 28580 (incorporated by reference in § 1037.810), except as specified in this paragraph (c). Use good engineering judgment to ensure that your test results are not biased low. You may ask us to identify a reference test laboratory to which you may correlate your test results. Prior to beginning the test procedure in Section 7 of ISO 28580 for a new bias-ply tire, perform a break-in procedure by running the tire at the

specified test speed, load, and pressure for 60 ± 2 minutes.

(3) For each tire design tested, measure rolling resistance of at least three different tires of that specific design and size. Perform the test at least once for each tire. Calculate the arithmetic mean of these results to the nearest 0.1 kg/tonne and use this value or any higher value as your GEM input for TRRL. You must test at least one tire size for each tire model, and may use engineering analysis to determine the rolling resistance of other tire sizes of that model. Note that for tire sizes that you do not test, we will treat your analytically derived rolling resistances the same as test results, and we may perform our own testing to verify your values. We may require you to test a small sub-sample of untested tire sizes that we select.

(4) If you obtain your test results from the tire manufacturer or another third party, you must obtain a signed statement from the party supplying those test results to verify that tests were conducted according to the requirements of this part. Such statements are deemed to be submissions to EPA.

(5) For tires marketed as light truck tires that have load ranges C, D, or E, use as the GEM input TRRL multiplied by 0.87.

(6) For vehicles with at least three drive axles or for vehicles with more than three axles total, use good engineering judgment to combine tire rolling resistance into three values (steer, drive 1, and drive 2) for use in GEM. This may require performing a

weighted average of tire rolling resistance from multiple axles based on the typical load on each axle.

(7) For vehicles with a single rear axle, enter “NA” as the TRRL value for drive axle 2.

(d) *Vehicle speed limit.* If the vehicles will be equipped with a vehicle speed limiter, input the maximum vehicle speed to which the vehicle will be limited (in miles per hour rounded to the nearest 0.1 mile per hour) as specified in § 1037.640. Use good engineering judgment to ensure the limiter is tamper resistant. We may require you to obtain preliminary approval for your designs.

(e) *Vehicle weight reduction.* Develop a weight-reduction as a GEM input as described in this paragraph (e). Enter the sum of weight reductions as described in this paragraph (e), or enter zero if there is no weight reduction. For purposes of this paragraph (e), high-strength steel is steel with tensile strength at or above 350 MPa.

(1) Vehicle weight reduction inputs for wheels are specified relative to dual-wide tires with conventional steel wheels. For purposes of this paragraph (e)(1), an aluminum alloy qualifies as light-weight if a dual-wide drive wheel made from this material weighs at least 21 pounds less than a comparable conventional steel wheel. The inputs are listed in Table 6 of this section. For example, a tractor or vocational vehicle with aluminum steer wheels and eight (4 × 2) dual-wide aluminum drive wheels would have an input of 210 pounds (2 × 21 + 8 × 21).

TABLE 6 OF § 1037.520—WHEEL-RELATED WEIGHT REDUCTIONS

Weight-reduction technology	Weight reduction— Phase 1 (lb per wheel)	Weight reduction— Phase 2 (lb per wheel)
Wide-Base Single Drive Tire with: <sup>1</sup>		
Steel Wheel .....	84	84
Aluminum Wheel .....	139	147
Light-Weight Aluminum Alloy Wheel .....	147	147
Wide-Base Single Trailer Tire with: <sup>1</sup>		
Steel Wheel .....		84
Aluminum or Aluminum Alloy Wheel .....		131
Steer Tire, Dual-wide Drive Tire, or Dual-wide Trailer Tire with:		
High-Strength Steel Wheel .....	8	8
Aluminum Wheel .....	21	25
Light-Weight Aluminum Alloy Wheel .....	30	25

<sup>1</sup> The weight reduction for wide-base tires accounts for reduced tire weight relative to dual-wide tires.

(2) Weight reduction inputs for tractor components other than wheels are specified in the following table:

TABLE 7 OF § 1037.520—NONWHEEL-RELATED WEIGHT REDUCTIONS FROM ALTERNATIVE MATERIALS FOR TRACTORS  
[Pounds]

Weight reduction technologies	Aluminum	High-strength steel	Thermoplastic
Door .....	20	6	
Roof .....	60	18	
Cab rear wall .....	49	16	
Cab floor .....	56	18	
Hood Support Structure System .....	15	3	
Hood and Front Fender .....			65
Day Cab Roof Fairing .....			18
Sleeper Cab Roof Fairing .....	75	20	40
Aerodynamic Side Extender .....			10
Fairing Support Structure System .....	35	6	
Instrument Panel Support Structure .....	5	1	
Brake Drums—Drive (set of 4) .....	140	74	
Brake Drums—Non Drive (set of 2) .....	60	42	
Frame Rails .....	440	87	
Crossmember—Cab .....	15	5	
Crossmember—Suspension .....	25	6	
Crossmember—Non Suspension (3) .....	15	5	
Fifth Wheel .....	100	25	
Radiator Support .....	20	6	
Fuel Tank Support Structure .....	40	12	
Steps .....	35	6	
Bumper .....	33	10	
Shackles .....	10	3	
Front Axle .....	60	15	
Suspension Brackets, Hangers .....	100	30	
Transmission Case .....	50	12	
Clutch Housing .....	40	10	
Fairing Support Structure System .....	35	6	
Drive Axle Hubs (set of 4) .....	80	20	
Non Drive Hubs (2) .....	40	5	
Two-piece driveshaft .....	20	5	
Transmission/Clutch Shift Levers .....	20	4	

(3) Weight-reduction inputs for vocational-vehicle components other than wheels are specified in the following table:

TABLE 8 OF § 1037.520—NONWHEEL-RELATED WEIGHT REDUCTIONS FROM ALTERNATIVE MATERIALS FOR PHASE 2 VOCATIONAL VEHICLES  
[Pounds]

Component	Material	Vehicle type		
		Light HDV	Medium HDV	Heavy HDV
Axle Hubs—Non-Drive .....	Aluminum .....	40		40
Axle Hubs—Non-Drive .....	High Strength Steel .....	5		5
Axle—Non-Drive .....	Aluminum .....	60		60
Axle—Non-Drive .....	High Strength Steel .....	15		15
Brake Drums—Non-Drive .....	Aluminum .....	60		60
Brake Drums—Non-Drive .....	High Strength Steel .....	42		42
Axle Hubs—Drive .....	Aluminum .....	40		80
Axle Hubs—Drive .....	High Strength Steel .....	10		20
Brake Drums—Drive .....	Aluminum .....	70		140
Brake Drums—Drive .....	High Strength Steel .....	37		74
Suspension Brackets, Hangers .....	Aluminum .....	67		100
Suspension Brackets, Hangers .....	High Strength Steel .....	20		30
Crossmember—Cab .....	Aluminum .....	10	15	15
Crossmember—Cab .....	High Strength Steel .....	2	5	5
Crossmember—Non-Suspension .....	Aluminum .....	15	15	15
Crossmember—Non-Suspension .....	High Strength Steel .....	5	5	5
Crossmember—Suspension .....	Aluminum .....	15	25	25
Crossmember—Suspension .....	High Strength Steel .....	6	6	6
Driveshaft .....	Aluminum .....	12	40	50
Driveshaft .....	High Strength Steel .....	5	10	12
Frame Rails .....	Aluminum .....	120	300	440
Frame Rails .....	High Strength Steel .....	40	40	87

(4) Apply vehicle weight inputs for changing technology configurations as follows:

(i) For Class 8 tractors or for Class 8 vocational vehicles with a permanent 6 × 2 axle configuration, apply a weight reduction input of 300 pounds. This does not apply for coach buses certified to custom-chassis standards under § 1037.105(h).

(ii) For Class 8 tractors with 4 × 2 axle configuration, apply a weight reduction input of 400 pounds.

(iii) For tractors with installed engines with displacement below 14.0 liters, apply a weight reduction of 300 pounds.

(iv) For tractors with single-piece driveshafts with a total length greater than 86 inches, apply a weight reduction of 43 pounds for steel driveshafts and 63 pounds for aluminum driveshafts.

(5) You may ask to apply the off-cycle technology provisions of § 1037.610 for weight reductions not covered by this paragraph (e).

(f) *Engine characteristics.* Enter information from the engine manufacturer to describe the installed engine and its operating parameters as described in 40 CFR 1036.510. The fuel-mapping information must apply for the vehicle's GVWR; for example, if you install a medium heavy-duty engine in a Class 8 vehicle, the engine must have additional fuel-mapping information for

the heavier vehicle. Note that you do not need fuel consumption at idle for tractors.

(g) *Vehicle characteristics.* Enter the following information to describe and the vehicle and its operating parameters:

(1) Transmission make, model, and type. Also identify the gear ratio for every available forward gear to two decimal places, and identify the lowest gear involving a locked torque converter, if applicable. For vehicles with a manual transmission, GEM applies a 2% emission increase relative to automated manual transmissions. If your vehicle has a dual-clutch transmission, use good engineering judgment to determine if it can be accurately represented in GEM as an automated manual transmission. We may require you to perform a powertrain test with dual-clutch transmissions to show that they can be properly simulated as an automated manual transmission.

(2) Drive axle configuration. Select a drive axle configuration to represent your vehicle for modeling.

(i) 4 × 2: One drive axle and one non-drive axle.

(ii) 6 × 2: One drive axle and two non-drive axles.

(iii) 6 × 4: Two or more drive axles, or more than three total axles. Note that this includes, for example, a vehicle with two drive axles out of four total

axles (otherwise known as an 8×4 configuration).

(iv) 6 × 4D: An axle that can automatically switch between 6 × 2 and 6 × 4 configuration. When the axle is in the 6 × 2 configuration the input and output of the disconnectable axle must be mechanically disconnected from the drive shaft and the wheels to qualify.

(3) Drive axle ratio,  $k_a$ . If a vehicle is designed with two or more user-selectable axle ratios, use the drive axle ratio that is expected to be engaged for the greatest driving distance. If the vehicle does not have a drive axle, such as a hybrid vehicle with direct electric drive, let  $k_a = 1$ .

(4) GEM inputs associated with powertrain testing include powertrain family, transmission calibration identifier, test data from § 1037.550, and the powertrain test configuration (dynamometer connected to transmission output or wheel hub). You do not need to identify or provide inputs for transmission gear ratios, fuel map data, or engine torque curves, which would otherwise be required under paragraph (f) of this section.

(h) *Idle-reduction technologies.* Identify whether your vehicle has qualifying idle-reduction technologies, subject to the qualifying criteria in § 1037.660, as follows:

(1) Stop-start technology and automatic engine shutdown systems

apply for vocational vehicles. See paragraph (j) of this section for automatic engine shutdown systems for tractors.

(2) Neutral idle applies for tractors and vocational vehicles.

(i) *Axle and transmission efficiency.* You may use axle efficiency maps as described in § 1037.560 and transmission efficiency maps as described in § 1037.565 to replace the default values in GEM. If you obtain your test results from the axle manufacturer, transmission manufacturer, or another third party, you must obtain a signed statement from the party supplying those test results to verify that tests were conducted according to the requirements of this part. Such statements are deemed to be submissions to EPA.

(j) *Additional reduction technologies.* Enter input values in GEM as follows to characterize the percentage CO<sub>2</sub> emission reduction corresponding to

certain technologies and vehicle configurations, or enter 0:

(1) *Intelligent controls.* Enter 2 for tractors with predictive cruise control. This includes any cruise control system that incorporates satellite-based global-positioning data for controlling operator demand. For other vehicles, enter 1.5 if they have neutral coasting, unless good engineering judgment indicates that a lower percentage should apply.

(2) *Accessory load.* Enter the following values related to accessory loads; if more than one item applies, enter the sum of those values:

(i) If vocational vehicles have electrically powered pumps for steering, enter 0.5 for vocational vehicles certified with the Regional duty cycle, and enter 1 for tractors and other vocational vehicles.

(ii) If tractors have electrically powered pumps for both steering and engine cooling, enter 1.

(iii) If vehicles have a high-efficiency air conditioning compressor, enter 0.5

for tractors and vocational Heavy HDV, and enter 1 for other vocational vehicles. This includes mechanically powered compressors meeting the specifications described in 40 CFR 86.1868–12(h)(5), and all electrically powered compressors.

(3) *Tire-pressure systems.* Enter 1.2 for vehicles with automatic tire inflation systems on all axles (1.1 for Multi-Purpose and Urban vocational vehicles). Enter 1.0 for vehicles with tire pressure monitoring systems on all axles (0.9 for Multi-Purpose and Urban vocational vehicles). If vehicles use a mix of the two systems, treat them as having only tire pressure monitoring systems.

(4) *Extended-idle reduction.* Enter values as shown in the following table for sleeper cabs equipped with idle-reduction technology meeting the requirements of § 1037.660 that are designed to automatically shut off the main engine after 300 seconds or less:

TABLE 9 OF § 1037.520—GEM INPUT VALUES FOR AES SYSTEMS

Technology	GEM input values	
	Adjustable	Tamper-resistant
Standard AES system .....	1	4
With diesel APU .....	3	4
With battery APU .....	5	6
With automatic stop-start .....	3	3
Fuel-operated heater .....	2	3

(5) *Other.* Additional GEM inputs may apply as follows:

(i) Enter 1.7 and 0.9, respectively, for school buses and coach buses that have at least seven available forward gears.

(ii) If we approve off-cycle technology under § 1037.610 in the form of an improvement factor, enter the improvement factor expressed as a percentage reduction in CO<sub>2</sub> emissions. (**Note:** In the case of approved off-cycle technologies whose benefit is quantified as a g/ton-mile credit, apply the credit to the GEM result, not as a GEM input value.)

(k) *Vehicles with hybrid power take-off.* For vocational vehicles, determine the delta PTO emission result of your engine and hybrid power take-off system as described in § 1037.540.

(l) [Reserved]

(m) *Aerodynamic improvements for vocational vehicles.* For vocational vehicles certified using the Regional duty cycle, enter ΔC<sub>d</sub>A values to account for using aerodynamic devices as follows:

(1) Enter 0.2 for vocational vehicles with an installed rear fairing if the

vehicle is at least 7 m long with a minimum frontal area of 8 m<sup>2</sup>.

(2) For vehicles at least 11 m long with a minimum frontal area of 9 m<sup>2</sup>, enter 0.5 if the vehicle has both skirts and a front fairing, and enter 0.3 if it has only one of those devices.

(3) You may determine input values for these or other technologies based on aerodynamic measurements as described in § 1037.527.

(n) *Alternate fuels.* For fuels other than those identified in GEM, perform the simulation by identifying the vehicle as being diesel-fueled if the engine is subject to the compression-ignition standard, or as being gasoline-fueled if the engine is subject to the spark-ignition standards. Correct the engine or powertrain fuel map for mass-specific net energy content as described in 40 CFR 1036.535(b).

**§ 1037.525 Aerodynamic measurements for tractors.**

This section describes a methodology for quantifying aerodynamic drag for use in determining input values for tractors as described in § 1037.520.

(a) *General provisions.* The GEM input for a tractor's aerodynamic performance is a C<sub>d</sub> value for Phase 1 and a C<sub>d</sub>A value for Phase 2. The input value is measured or calculated for a tractor in a specific test configuration with a trailer, such as a high-roof tractor with a box van meeting the requirements for the standard trailer.

(1) Aerodynamic measurements may involve any of several different procedures. Measuring with different procedures introduces variability, so we identify the coastdown method in § 1037.528 as the primary (or reference) procedure. You may use other procedures with our advance approval as described in paragraph (d) of this section, but we require that you adjust your test results from other test methods to correlate with coastdown test results. All adjustments must be consistent with good engineering judgment. Submit information describing how you quantify aerodynamic drag from coastdown testing, whether or not you use an alternate method.

(2) Test high-roof tractors with a standard trailer as described in § 1037.501(g)(1). Note that the standard

trailer for Phase 1 tractors is different from that of later model years. Note also that GEM may model a different configuration than the test configuration, but accounts for this internally. Test low-roof and mid-roof tractors without a trailer; however, you may test low-roof and mid-roof tractors with a trailer to evaluate off-cycle technologies.

(b) *Adjustments to correlate with coastdown testing.* Adjust aerodynamic drag values from alternate methods to be equivalent to the corresponding values from coastdown measurements as follows:

(1) Determine the functional relationship between your alternate method and coastdown testing. Unless good engineering judgment dictates

$$F_{\text{alt-aero}} = \frac{C_d A_{\text{effective-yaw-coastdown}}}{C_d A_{\text{effective-yaw-alt}}}$$

Eq. 1037.525-1

(2) Determine  $F_{\text{alt-aero}}$  by performing coastdown testing and applying your alternate method on the same vehicles. Consider all applicable test data including data collected during selective enforcement audits. Where you have test results from multiple vehicles expected to have the same  $F_{\text{alt-aero}}$ , you may either average the  $F_{\text{alt-aero}}$  values or select any greater value. Unless we approve another vehicle, one vehicle must be a Class 8 high-roof sleeper cab with a full aerodynamics package pulling a standard trailer. Where you have more than one tractor model meeting these criteria, use the tractor model with the highest projected sales. If you do not have such a tractor model, you may use your most comparable tractor model with our prior approval. In the case of alternate methods other than those specified in this subpart, good engineering judgment may require you to determine your adjustment factor based on results from more than the specified minimum number of vehicles.

(3) Measure the drag area using your alternate method for a Phase 2 tractor used to determine  $F_{\text{alt-aero}}$  with testing at yaw angles of  $0^\circ$ ,  $\pm 1^\circ$ ,  $\pm 3^\circ$ ,  $\pm 4.5^\circ$ ,  $\pm 6^\circ$ , and  $\pm 9^\circ$  (you may include additional angles), using direction conventions described in Figure 2 of SAE J1252 (incorporated by reference in § 1037.810). Also, determine the drag

area at the coastdown effective yaw angle,  $C_d A_{\text{effective-yaw-alt}}$ , by taking the average drag area at  $\psi_{\text{eff}}$  and  $-\psi_{\text{eff}}$  for your vehicle using the same alternate method.

(4) For Phase 2 testing, determine separate values of  $F_{\text{alt-aero}}$  for a minimum of one high-roof day cab and one high-roof sleeper cab for 2021, 2024, and 2027 model years based on testing as described in paragraph (b)(2) of this section (six tests total). For any untested tractor models, apply the value of  $F_{\text{alt-aero}}$  from the tested tractor model that best represents the aerodynamic characteristics of the untested tractor model, consistent with good engineering judgment. Testing under this paragraph (b)(4) continues to be valid for later model years until you change the tractor model in a way that causes the test results to no longer represent production vehicles. You must also determine unique values of  $F_{\text{alt-aero}}$  for low-roof and mid-roof tractors if you determine  $C_d A$  values based on low or mid-roof tractor testing as shown in Table 4 of § 1037.520. For Phase 1 testing, if good engineering judgment allows it, you may calculate a single, constant value of  $F_{\text{alt-aero}}$  for your whole product line by dividing the coastdown drag area,  $C_d A_{\text{coastdown}}$ , by  $C_d A_{\text{alt}}$ .

(5) Determine  $F_{\text{alt-aero}}$  to at least three decimal places. For example, if your

otherwise, assume that coastdown drag is proportional to drag measured using alternate methods. This means you may apply a constant adjustment factor,  $F_{\text{alt-aero}}$ , for a given alternate drag measurement method using the following equation, where the effective yaw angle,  $\psi_{\text{eff}}$ , is assumed to be zero degrees for Phase 1 and is determined from coastdown test results for Phase 2:

coastdown testing results in a drag area of 6.430, but your wind tunnel method results in a drag area of 6.200,  $F_{\text{alt-aero}}$  would be 1.037 (or a higher value you declare).

(6) If a tractor and trailer cannot be configured to meet the gap requirements, test with the trailer positioned as close as possible to the specified gap dimension and use good engineering judgment to correct the results to be equivalent to a test configuration meeting the specified gap dimension.

(c) *Yaw sweep corrections.* Aerodynamic features can have a different effectiveness for reducing wind-averaged drag than is predicted by zero-yaw drag. The following procedures describe how to determine a tractor's  $C_d A$  values to account for wind-averaged drag and differences from coastdown testing:

(1) For Phase 2 testing with an alternate method, apply the following method using your alternate method for aerodynamic testing:

(i) For all testing, calculate the wind-averaged drag area from the alternate method,  $C_d A_{\text{wa-alt}}$ , using an average of measurements at  $-4.5$  and  $+4.5$  degrees.

(ii) Determine your wind-averaged drag area,  $C_d A_{\text{wa}}$ , rounded to one decimal place, using the following equation:

$$C_d A_{\text{wa}} = C_d A_{\text{wa-alt}} \cdot F_{\text{alt-aero}}$$

Eq. 1037.525-2

(2) For Phase 2 coastdown test results, apply the following method:

(i) For all coastdown testing, determine your effective yaw angle from coastdown,  $C_d A_{\text{effective-yaw-coastdown}}$ .

(ii) Use an alternate method to calculate the ratio of the wind-averaged drag area (using an average of measurements at  $-4.5$  and  $+4.5$  degrees,  $C_d A_{\text{wa-alt}}$ ) to the drag area at the effective yaw angle,  $C_d A_{\text{effective-yaw}}$ .

(iii) Determine your wind-averaged drag area,  $C_d A_{\text{wa}}$ , rounded to one decimal place, using the following equation:

$$C_d A_{wa} = C_d A_{\text{effective-yaw-coastdown}} \cdot \frac{C_d A_{wa\text{-alt}}}{C_d A_{\text{effective-yaw}}}$$

Eq. 1037.525-3

(3) Different approximations apply for Phase 1. For Phase 1 testing, you may correct your zero-yaw drag area as follows if the ratio of the zero-yaw drag area divided by yaw-sweep drag area for your vehicle is greater than 0.8065

(which represents the ratio expected for a typical Class 8 high-roof sleeper cab):  
 (i) Determine the zero-yaw drag area,  $C_d A_{\text{zero-yaw}}$ , and the yaw-sweep drag area for your vehicle using the same alternate method as specified in this subpart. Measure the drag area for  $0^\circ$ ,  $-6^\circ$ , and

$+6^\circ$ . Use the arithmetic mean of the  $-6^\circ$  and  $+6^\circ$  drag areas as the  $\pm 6^\circ$  drag area,  $C_d A_{\pm 6}$ .

(ii) Calculate your yaw-sweep correction factor,  $CF_{ys}$ , using the following equation:

$$CF_{ys} = \frac{C_d A_{\pm 6} \cdot 0.8065}{C_d A_{\text{zero-yaw}}}$$

Eq. 1037.525-4

(iii) Calculate your corrected drag area for determining the aerodynamic bin by multiplying the measured zero-yaw drag area by  $CF_{ys}$ , as determined using Eq. 1037.525-4, as applicable. You may

apply the correction factor to drag areas measured using other procedures. For example, apply  $CF_{ys}$  to drag areas measured using the coastdown method. If you use an alternate method, apply an

alternate correction,  $F_{\text{alt-aero}}$ , and calculate the final drag area using the following equation:

$$C_d A = F_{\text{alt-aero}} \cdot CF_{ys} \cdot C_d A_{\text{zero-alt}}$$

Eq. 1037.525-5

(iv) You may ask us to apply  $CF_{ys}$  to similar vehicles incorporating the same design features.

(v) As an alternative, you may calculate the wind-averaged drag area according to SAE J1252 (incorporated by reference in § 1037.810) and substitute this value into Eq. 1037.525-4 for the  $\pm 6^\circ$  drag area.

(d) *Approval of alternate methods.* You must obtain preliminary approval before using any method other than coastdown testing to quantify aerodynamic drag. We will approve your request if you show that your procedures produce data that are the same as or better than coastdown testing with respect to repeatability and unbiased correlation. Note that the correlation is not considered to be biased if there is a bias before correction, but you remove the bias using  $F_{\text{alt-aero}}$ . Send your request for approval to the Designated Compliance Officer. Keep records of the information specified in this paragraph (d). Unless we specify otherwise, include this information with your request. You must provide any information we require to evaluate whether you may apply the provisions of this section. Include additional information related

to your alternate method as described in §§ 1037.530 through 1037.534. If you use a method other than those specified in this subpart, include all the following information, as applicable:

- (1) Official name/title of the procedure.
- (2) Description of the procedure.
- (3) Cited sources for any standardized procedures that the method is based on.
- (4) Description and rationale for any modifications/deviations from the standardized procedures.
- (5) Data comparing the procedure to the coastdown reference procedure.
- (6) Additional information specified for the alternate methods described in §§ 1037.530 through 1037.534 as applicable to this method (e.g., source location/address, background/history).

#### **§ 1037.526 Aerodynamic measurements for trailers.**

This section describes a methodology for determining aerodynamic drag area,  $C_d A$  for use in determining input values for box vans as described in §§ 1037.515 and 1037.520.

(a) A trailer's aerodynamic performance for demonstrating compliance with standards is based on a  $\Delta C_d A$  value relative to a baseline

trailer. Determine these  $\Delta C_d A$  values by performing A to B testing, as follows:

(1) Determine a baseline  $C_d A$  value for a standard tractor pulling a test trailer representing a production configuration; use a 53-foot test trailer to represent long trailers and a 28-foot test trailer to represent short trailers. Repeat this testing with the same tractor and the applicable baseline trailer. For testing long trailers, the baseline trailer is a trailer meeting the specifications for a Phase 1 standard trailer in § 1037.501(g)(1); for testing refrigerated box vans, use a baseline trailer with an installed HVAC unit that properly represents a baseline configuration correlated with the production configuration. For testing short trailers, use a 28-foot baseline trailer with a single axle that meets the same specifications as the Phase 1 standard trailer, except as needed to accommodate the reduced trailer length.

(2) Use good engineering judgment to perform paired tests that accurately demonstrate the reduction in aerodynamic drag associated with the improved design. For example, the gap dimension should be the same for all paired tests, and effective yaw angle



between paired tests should differ by no more than 1.0°.

(3) Measure  $C_{dA}$  in  $m^2$  to two decimal places. Calculate  $\Delta C_{dA}$  by subtracting the drag area for the test trailer from the drag area for the baseline trailer.

(b) The default method for measuring is the wind-tunnel procedure as specified in § 1037.530. You may test using alternate methods as follows:

(1) If we approve it in advance, you may instead use one of the alternate methods specified in §§ 1037.528 through 1037.532, consistent with good engineering judgment, which may require that you adjust your test results from the alternate test method to correlate with the primary method. If you request our approval to determine  $\Delta C_{dA}$  using an alternate method, you must submit additional information as described in paragraph (d) of this section.

(2) The principles of 40 CFR 1065.10(c)(1) apply for aerodynamic test methods. Specifically, we may require that you use coastdown measurements if we determine that certain technologies are not suited to evaluation with wind-tunnel testing or CFD, such as nonrigid materials whose physical characteristics change in scaled-model testing. You may similarly reference 40 CFR 1065.10(c)(1) in your request to use coastdown testing as an alternate method.

(c) The following provisions apply for combining multiple devices under this section for the purpose of certifying trailers:

(1) If the device manufacturer establishes a  $\Delta C_{dA}$  value in a single test with multiple aerodynamic devices installed, trailer manufacturers may use that  $\Delta C_{dA}$  value directly for the same combination of aerodynamic devices installed on production trailers.

(2) Trailer manufacturers may combine  $\Delta C_{dA}$  values for aerodynamic devices that are not tested together, as long as each device does not significantly impair the effectiveness of another, consistent with good engineering judgment. To approximate the overall benefit of multiple devices, calculate a composite  $\Delta C_{dA}$  value for multiple aerodynamic devices by applying the full  $\Delta C_{dA}$  value for the device with the greatest aerodynamic improvement, adding the second-highest  $\Delta C_{dA}$  value multiplied by 0.9, and adding any other  $\Delta C_{dA}$  values multiplied by 0.8.

(d) You must send us a description of your plan to perform testing under this section before you start testing. We will evaluate whether plans for wind-tunnel testing meet the specifications of § 1037.530, and will tell you if you may

or must use any other method to determine drag coefficients. We will approve your request to use an alternate method if you show that your procedures produce data that are the same as or better than wind-tunnel testing with respect to repeatability and unbiased correlation. Note that the correlation is not considered to be biased if there is a bias before correction, but you apply a correction to remove the bias. Send your testing plan to the Designated Compliance Officer. Keep records of the information specified in this paragraph (d). Unless we specify otherwise, include this information with your request. You must provide any information we require to evaluate whether you may apply the provisions of this section. Include additional information related to your alternate method as described in §§ 1037.528 through 1037.534.

#### § 1037.527 Aerodynamic measurements for vocational vehicles.

This section describes a methodology for determining aerodynamic drag area,  $C_{dA}$ , for use in determining input values for vocational vehicles as described in § 1037.520. This measurement is optional.

(a) Determine  $\Delta C_{dA}$  values by performing A to B testing as described for trailers in § 1037.526, with any appropriate adjustments, consistent with good engineering judgment.

(b) [Reserved]

#### § 1037.528 Coastdown procedures for calculating drag area ( $C_{dA}$ ).

The coastdown procedures in this section describe how to calculate drag area,  $C_{dA}$ , for Phase 2 tractors, trailers, and vocational vehicles, subject to the provisions of §§ 1037.525 through 1037.527. These procedures are considered the primary procedures for tractors, but alternate procedures for trailers. Follow the provisions of Sections 1 through 9 of SAE J2263 (incorporated by reference in § 1037.810), with the clarifications and exceptions described in this section. Several of these exceptions are from SAE J1263 (incorporated by reference in § 1037.810). The coastdown procedures in 40 CFR 1066.310 apply instead of the provisions of this section for Phase 1 tractors.

(a) The terms and variables identified in this section have the meaning given in SAE J1263 (incorporated by reference in § 1037.810) and J2263 unless specified otherwise.

(b) To determine  $C_{dA}$  values for a tractor, perform coastdown testing with a tractor-trailer combination using the manufacturer's tractor and a standard

trailer. To determine  $C_{dA}$  values for a trailer, perform coastdown testing with a tractor-trailer combination using a standard tractor. Prepare tractors and trailers for testing as follows:

(1) Install instrumentation for performing the specified measurements.

(2) After adding vehicle instrumentation, verify that there is no brake drag or other condition that prevents the wheels from rotating freely. Do not apply the parking brake at any point between this inspection and the end of the measurement procedure.

(3) Install tires mounted on steel rims in a dual configuration (except for steer tires). The tires must—

(i) Be SmartWay-Verified or have a coefficient of rolling resistance at or below 5.1 kg/metric ton.

(ii) Have accumulated at least 2,000 miles but have no less than 50 percent of their original tread depth, as specified for truck cabs in SAE J1263.

(iii) Not be retreads or have any apparent signs of chunking or uneven wear.

(iv) Be size 295/75R22.5 or 275/80R22.5.

(v) Be inflated to the proper tire pressure as specified in Sections 6.6 and 8.1 of SAE J2263.

(vi) Be of the same tire model for a given axle.

(4) Perform an inspection or wheel alignment for both the tractor and the trailer to ensure that wheel position is within the manufacturer's specifications.

(c) The test condition specifications described in Sections 7.1 through 7.4 of SAE J1263 apply, with the following exceptions and additional provisions:

(1) We recommend that you not perform coastdown testing if winds are expected to exceed 6.0 mi/hr.

(2) The average of the component of the wind speed parallel to the road must not exceed 6.0 mi/hr. This constraint is in addition to those in Section 7.3 of SAE J1263.

(3) If road grade is greater than 0.02% over the length of the test surface, you must determine elevation as a function of distance along the length of the test surface and incorporate this into the analysis.

(4) Road grade may exceed 0.5% for limited portions of the test surface as long as it does not affect coastdown results, consistent with good engineering judgment.

(5) The road surface temperature must be at or below 50 °C. Use good engineering judgment to measure road surface temperature.

(d)  $C_{dA}$  calculations are based on measured speed values while the vehicle coasts down through a high-

speed range from 70 to 60 mi/hr, and through a low-speed range from 20 to 10 mi/hr. Disable any vehicle speed limiters that prevent travel above 72 mi/hr. Measure vehicle speed at a minimum recording frequency of 10 Hz, in conjunction with time-of-day data. Determine vehicle speed using either of the following methods:

(1) *Complete coastdown runs.* Operate the vehicle at a top speed above 72.0 mi/hr and allow the vehicle to coast down to 8.0 mi/hr or lower. Collect data for the high-speed range over a test segment that includes speeds from 72.0 down to 58.0 mi/hr, and collect data for the low-speed range over a test segment that includes speeds from 22.0 down to 8.0 mi/hr.

(2) *Split coastdown runs.* Collect data during a high-speed coastdown while the vehicle coasts through a test segment that includes speeds from 72.0 mi/hr down to 58.0 mi/hr. Similarly, collect data during a low-speed coastdown while the vehicle coasts through a test segment that includes speeds from 22.0 mi/hr down to 8.0 mi/hr. Perform one high-speed coastdown segment or two consecutive high-speed coastdown segments in one direction, followed by the same number of low-speed coastdown segments in the same direction, and then perform that same number of measurements in the opposite direction. You may not split runs as described in Section 9.3.1 of SAE J2263 except as allowed under this paragraph (d)(2).

(e) Measure wind speed, wind direction, air temperature, and air pressure at a recording frequency of 10 Hz, in conjunction with time-of-day data. Use at least one stationary electro-mechanical anemometer and suitable data loggers meeting SAE J1263 specifications, subject to the following additional specifications for the anemometer placed along the test surface:

(1) You must start a coastdown measurement within 24 hours after completing zero-wind and zero-angle calibrations.

(2) Place the anemometer at least 50 feet from the nearest tree and at least 25 feet from the nearest bush (or equivalent features). Position the anemometer adjacent to the test surface, near the midpoint of the length of the track, between 2.5 and 3.0 body widths from the expected location of the test vehicle's centerline as it passes the anemometer. Record the location of the anemometer along the test track, to the nearest 10 feet.

(3) Mount the anemometer at a height that is within 6 inches of half the test vehicle's body height.

(4) The height of vegetation surrounding the anemometer may not exceed 10% of the anemometer's mounted height, within a radius equal to the anemometer's mounted height.

(f) Measure air speed and relative wind direction (yaw angle) onboard the vehicle at a minimum recording frequency of 10 Hz, in conjunction with time-of-day data, using an anemometer and suitable data loggers that meet the requirements of Sections 5.4 of SAE J2263. The yaw angle must be measured to a resolution and accuracy of  $\pm 0.5^\circ$ . Mount the anemometer such that it measures air speed at 1.5 meters above the top of the leading edge of the trailer. If obstructions at the test site do not allow for this mounting height, then mount the anemometer such that it measures air speed at least 0.85 meters above the top of the leading edge of the trailer.

(g) Perform the following calculations to filter and correct measured data:

(1) For any measured values not identified as outliers, use those measured values directly in the calculations specified in this section. Filter air speed, yaw angle, wind speed, wind direction, and vehicle speed

measurements to replace outliers for every measured value as follows:

(i) Determine a median measured value to represent the measurement point and the measurements 3 seconds before and after that point. In the first and last three seconds of the coastdown run, use all available data to determine the median measured value. The measurement window for determining the median value will accordingly include 61 measurements in most cases, and will always include at least 31 measurements (for 10 Hz recording frequency).

(ii) Determine the median absolute deviation corresponding to each measurement window from paragraph (g)(1)(i) of this section. This generally results from calculating 61 absolute deviations from the median measured value and determining the median from those 61 deviations. Calculate the standard deviation for each measurement window by multiplying the median absolute deviation by 1.4826; calculate three standard deviations by multiplying the median absolute deviation by 4.4478. Note that the factor 1.4826 is a statistical constant that relates median absolute deviations to standard deviations.

(iii) A measured value is an outlier if the measured value at a given point differs from the median measured value by more than three standard deviations. Replace each outlier with the median measured value from paragraph (g)(1)(i) of this section. This technique for filtering outliers is known as the Hampel method.

(2) For each high-speed and each low-speed segment, correct measured air speed using the wind speed and wind direction measurements described in paragraph (e) of this section as follows:

(i) Calculate the theoretical air speed,  $v_{\text{air,th}}$ , for each 10-Hz set of measurements using the following equation:

$$v_{\text{air,th}} = \sqrt{w^2 + v^2 + 2 \cdot v \cdot w \cdot \cos(\phi_w + \phi_{\text{veh}})}$$

Eq. 1037.528-1

Where:

$w$  = filtered wind speed.

$v$  = filtered vehicle speed.

$\phi_w$  = filtered wind direction. Let  $\phi_w = 0^\circ$  for air flow in the first travel direction, with values increasing counterclockwise. For

example, if the vehicle starts by traveling eastbound, then  $\phi_w = 270^\circ$  means a wind from the south.

$\phi_{\text{veh}}$  = the vehicle direction. Use  $\phi_{\text{veh}} = 0^\circ$  for travel in the first direction, and use  $\phi_{\text{veh}} = 180^\circ$  for travel in the opposite direction.

*Example:*

$w = 7.1$  mi/hr

$v = 64.9$  mi/hr

$\phi_w = 47.0^\circ$

$\phi_{\text{veh}} = 0^\circ$

$$v_{\text{air,th}} = \sqrt{7.1^2 + 64.9^2 + 2 \cdot 64.9 \cdot 7.1 \cdot \cos(47 + 0)}$$

$v_{\text{air,th}} = 69.93$  mi/hr

(ii) Perform a linear regression using paired values of  $v_{\text{air,th}}$  and measured air speed,  $v_{\text{air,meas}}$ , to determine the air-speed correction coefficients,  $\alpha_0$  and  $\alpha_1$ , based on the following equation:

$$v_{\text{air,th}} = \alpha_0 + \alpha_1 \cdot v_{\text{air,meas}}$$

Eq. 1037.528-2

(iii) Correct each measured value of air speed using the following equation:

$$v_{\text{air}} = \alpha_0 + \alpha_1 \cdot v_{\text{air,meas}}$$

Eq. 1037.528-3

(3) Correct measured air direction using the wind speed and wind

direction measurements described in paragraph (e) of this section as follows:

(i) Calculate the theoretical air direction,  $\psi_{\text{air,th}}$ , using the following equation:

$$\psi_{\text{air,th}} = \arctan\left(\frac{w \cdot \sin(\phi_w + \phi_{veh})}{v + w \cdot \cos(\phi_w + \phi_{veh})}\right)$$

Eq. 1037.528-4

*Example:*  
 $w = 7.1$  mi/hr

$v = 64.9$  mi/hr  
 $\phi_w = 47.0^\circ$

$\phi_{veh} = 0^\circ$

$$\psi_{\text{air,th}} = \arctan\left(\frac{7.1 \cdot \sin(47.0 + 0)}{64.9 + 7.1 \cdot \cos(47.0 + 0)}\right)$$

$\psi_{\text{air,th}} = 4.26^\circ$

(ii) Perform a linear regression using paired values of  $\psi_{\text{air,th}}$  and measured air direction,  $\psi_{\text{air,meas}}$ , to determine the air-

direction correction coefficients,  $\beta_0$  and  $\beta_1$ , based on the following equation:

$$\psi_{\text{air,th}} = \beta_0 + \beta_1 \cdot \psi_{\text{air,meas}}$$

Eq. 1037.528-5

(iii) Correct each measured value of air direction using the following equation:

$$\psi_{\text{air}} = \beta_0 + \beta_1 \cdot \psi_{\text{air,meas}}$$

Eq. 1037.528-6

(h) Determine drag area,  $C_dA$ , using the following procedure instead of the procedure specified in Section 10 of SAE J1263:

(1) Calculate the vehicle's effective mass,  $M_e$ , to account for rotational inertia by adding 56.7 kg to the measured vehicle mass,  $M$ , (in kg) for each tire making road contact.

(2) Operate the vehicle and collect data over the high-speed range and low-speed range as specified in paragraph (d)(1) or (2) of this section. If the vehicle has a speed limiter that prevents it from exceeding 72 mi/hr, you must disable the speed limiter for testing.

(3) Calculate mean vehicle speed at each speed start point (70 and 20 mi/hr) and end point (60 and 10 mi/hr) as follows:

(i) Calculate the mean vehicle speed to represent the start point of each speed range as the arithmetic average of measured speeds throughout the speed interval defined as 2.00 mi/hr above the nominal starting speed point to 2.00 mi/hr below the nominal starting speed point, expressed to at least two decimal places. Determine the timestamp corresponding to the starting point of each speed range as the time midpoint of the  $\pm 2.00$  mi/hr speed interval.

(ii) Repeat the calculations described in paragraph (h)(3)(i) of this section corresponding to the end point speed (60 or 10 mi/hr) to determine the time at which the vehicle reaches the end speed, and the mean vehicle speed representing the end point of each speed range.

(iii) If you incorporate grade into your calculations, use the average values for the elevation and distance traveled over each interval.

(4) Calculate the road-load force,  $F$ , for each speed range using the following equation:

$$F = -M_e \cdot \frac{\bar{v}_{start} - \bar{v}_{end}}{\bar{t}_{start} - \bar{t}_{end}} + M \cdot a_g \cdot \frac{\bar{h}_{start} - \bar{h}_{end}}{|\bar{D}_{start} - \bar{D}_{end}|}$$

Eq. 1037.528-7

Where:

$M_e$  = the vehicle's effective mass.

$\bar{v}$  = average vehicle speed at the start or end of each speed range, as described in paragraph (h)(3) of this section.

$\bar{t}$  = timestamp at which the vehicle reaches the starting or ending speed expressed to at least one decimal place.

$M$  = the vehicle's measured mass.

$a_g$  = acceleration of Earth's gravity, as described in 40 CFR 1065.630.

$\bar{h}$  = average elevation at the start or end of each speed range expressed to at least two decimal places.

$\bar{D}$  = distance traveled on the road surface from a fixed reference location along the road to the start or end of each speed range expressed to at least one decimal place.

Example:

$M_e = 17,129$  kg (18 tires in contact with the road surface)

$\bar{v}_{start} = 69.97$  mi/hr = 31.28 m/s

$\bar{v}_{end} = 59.88$  mi/hr = 26.77 m/s

$\bar{t}_{start} = 3.05$  s

$\bar{t}_{end} = 19.11$  s

$M = 16,108$  kg

$a_g = 9.8061$  m/s<sup>2</sup>

$\bar{h}_{start} = 0.044$  m

$\bar{h}_{end} = 0.547$  m

$\bar{D}_{start} = 706.8$  ft = 215.4 m

$\bar{D}_{end} = 2230.2$  ft = 697.8 m

$$F = -17129 \cdot \frac{31.28 - 26.77}{3.05 - 19.11} + 16108 \cdot 9.8061 \cdot \frac{0.044 - 0.547}{|215.4 - 697.8|}$$

$F = 4645.5$  N

(5) For tractor testing, calculate the drive-axle spin loss force at high and low speeds,  $F_{spin[ speed ]}$ , and determine  $\Delta F_{spin}$  as follows:

(i) Use the results from the axle efficiency test described in § 1037.560 for the drive axle model installed in the tractor being tested for this coastdown procedure.

(ii) Perform a second-order regression of axle power loss in W from only the zero-torque test points with wheel speed,  $f_{nwheel}$ , in r/s from the axle efficiency test to determine coefficients  $c_0$ ,  $c_1$ , and  $c_2$ .

$$P_{loss} = c_0 + c_1 \cdot f_{nwheel} + c_2 \cdot f_{nwheel}^2$$

Eq. 1037.528-8

(iii) Calculate  $F_{spin[ speed ]}$  using the following equation:

$$F_{spin[ speed ]} = \frac{1}{\bar{v}_{seg[ speed ]}} \left[ c_0 + c_1 \cdot \bar{v}_{seg[ speed ]} \cdot TRPM + c_2 \cdot \left( \bar{v}_{seg[ speed ]} \cdot TRPM \right)^2 \right]$$

Eq. 1037.528-9

Where:  $\bar{v}_{\text{seg}[\text{speed}]}$  = the mean vehicle speed of all vehicle speed measurements in each low-speed and high-speed segment.  
 TRPM = tire revolutions per mile for the drive tire model installed on the tractor

being tested according to § 1037.520(c)(1).  
*Example:*  
 $\bar{v}_{\text{seg}hi} = 28.86 \text{ m/s}$   
 $\bar{v}_{\text{seg}lo} = 5.84 \text{ m/s}$   
 $TRPM = 508 \text{ r/mi} = 0.315657 \text{ r/m}$

$c_0 = -206.841 \text{ W}$   
 $c_1 = 239.8279 \text{ W}\cdot\text{s/r}$   
 $c_2 = 21.27505 \text{ W}\cdot\text{s}^2/\text{r}^2$

$$F_{\text{spin}hi} = \frac{1}{28.86} \cdot \left[ -206.841 + 239.8279 \cdot 28.86 \cdot 0.315657 + 21.27505 \cdot (28.86 \cdot 0.315657)^2 \right]$$

$F_{\text{spin}hi} = 129.7 \text{ N}$   
 $F_{\text{spin}lo} = 52.7 \text{ N}$

(iv) Calculate  $\Delta F_{\text{spin}}$  using the following equation:

$$\Delta F_{\text{spin}} = F_{\text{spin}hi} - F_{\text{spin}lo}$$

Eq. 1037.528-10

*Example:*  
 $\Delta F_{\text{spin}} = 129.7 - 52.7 = 77.0 \text{ N}$

(6) For tractor testing, calculate the tire rolling resistance force at high and low speeds for steer, drive, and trailer

axle positions,  $F_{\text{TRR}[\text{speed},\text{axle}]}$ , and determine  $\Delta F_{\text{TRR}}$  as follows:

(i) Conduct a stepwise coastdown tire rolling resistance test with three tires for each tire model installed on the vehicle

using SAE J2452 (incorporated by reference in § 1037.810) for the following test points (which replace the test points in Table 3 of SAE J2452):

TABLE 1 OF § 1037.528—STEPWISE COASTDOWN TEST POINTS FOR DETERMINING TIRE ROLLING RESISTANCE AS A FUNCTION OF SPEED

Step #	Load (% of max)	Inflation pressure (% of max)
1 .....	20	100
2 .....	55	70
3 .....	85	120
4 .....	85	100
5 .....	100	95

(ii) Calculate  $F_{\text{TRR}[\text{speed},\text{axle}]}$  using the following equation:

$$F_{\text{TRR}[\text{speed},\text{axle}]} = n_{t,[\text{axle}]} \cdot P_{[\text{axle}]}^\alpha \cdot \left( \frac{L_{[\text{axle}]}}{n_{t,[\text{axle}]}} \right)^{\beta_{[\text{axle}]}} \cdot (a_{[\text{axle}]} + b_{[\text{axle}]} \cdot \bar{v}_{\text{seg}[\text{speed}]} + c_{[\text{axle}]} \cdot \bar{v}_{\text{seg}[\text{speed}]}^2)$$

Eq. 1037.528-11

Where:

$n_{t,[\text{axle}]}$  = number of tires at the axle position.  
 $P_{[\text{axle}]}$  = the inflation pressure set and measured on the tires at the axle position at the beginning of the coastdown test.  
 $L_{[\text{axle}]}$  = the load over the axle at the axle position on the coastdown test vehicle.  
 $\alpha_{[\text{axle}]}$ ,  $\beta_{[\text{axle}]}$ ,  $a_{[\text{axle}]}$ ,  $b_{[\text{axle}]}$ , and  $c_{[\text{axle}]}$  = regression coefficients from SAE J2452 that are specific to axle position.

*Example:*  
 $n_{t,\text{steer}} = 2$

$P_{\text{steer}} = 758.4 \text{ kPa}$   
 $L_{\text{steer}} = 51421.2 \text{ N}$   
 $\alpha_{\text{steer}} = -0.2435$   
 $\beta_{\text{steer}} = 0.9576$   
 $a_{\text{steer}} = 0.0434$   
 $b_{\text{steer}} = 5.4 \cdot 10^{-5}$   
 $c_{\text{steer}} = 5.53 \cdot 10^{-7}$   
 $n_{t,\text{drive}} = 8$   
 $P_{\text{drive}} = 689.5 \text{ kPa}$   
 $L_{\text{drive}} = 55958.4 \text{ N}$   
 $\alpha_{\text{drive}} = -0.3146$   
 $\beta_{\text{drive}} = 0.9914$   
 $a_{\text{drive}} = 0.0504$

$b_{\text{drive}} = 1.11 \cdot 10^{-4}$   
 $c_{\text{drive}} = 2.86 \cdot 10^{-7}$   
 $n_{t,\text{trailer}} = 8$   
 $P_{\text{trailer}} = 689.5 \text{ kPa}$   
 $L_{\text{trailer}} = 45727.5 \text{ N}$   
 $\alpha_{\text{trailer}} = -0.3982$   
 $\beta_{\text{trailer}} = 0.9756$   
 $a_{\text{trailer}} = 0.0656$   
 $b_{\text{trailer}} = 1.51 \cdot 10^{-4}$   
 $c_{\text{trailer}} = 2.94 \cdot 10^{-7}$   
 $\bar{v}_{\text{seg}hi} = 28.86 \text{ m/s} = 103.896 \text{ km/hr}$   
 $\bar{v}_{\text{seg}lo} = 5.84 \text{ m/s} = 21.024 \text{ km/hr}$

$$F_{\text{TRRhi,steer}} = 2 \cdot 758.4^{-0.2435} \cdot \left( \frac{51421.2}{2} \right)^{0.9576} \cdot \left( 0.0434 + 5.4 \cdot 10^5 \cdot 103.896 + 5.53 \cdot 10^{-7} \cdot 103.896^2 \right)$$

$$\begin{aligned} F_{\text{TRRhi,steer}} &= 365.6 \text{ N} \\ F_{\text{TRRhi,drive}} &= 431.4 \text{ N} \\ F_{\text{TRRhi,trailer}} &= 231.7 \text{ N} \\ F_{\text{TRRlo,steer}} &= 297.8 \text{ N} \end{aligned}$$

$$\begin{aligned} F_{\text{TRRlo,drive}} &= 350.7 \text{ N} \\ F_{\text{TRRlo,trailer}} &= 189.0 \text{ N} \end{aligned}$$

a given speed for each axle position and determine  $\Delta F_{\text{TRR}}$  as follows:

(iii) Calculate  $F_{\text{TRR[ speed]}}$  by summing the tire rolling resistance calculations at

$$F_{\text{TRR[ speed]}} = F_{\text{TRR,[ speed]steer}} + F_{\text{TRR,[ speed]drive}} + F_{\text{TRR,[ speed]trailer}}$$

Eq. 1037.528-12

*Example:*

$$\begin{aligned} F_{\text{TRRhi}} &= 365.6 + 431.4 + 231.7 = 1028.7 \text{ N} \\ F_{\text{TRRlo}} &= 297.8 + 350.7 + 189.0 = 837.5 \text{ N} \end{aligned}$$

(iv) Adjust  $F_{\text{TRR[ speed]}}$  to the ambient temperature during the coastdown segment as follows:

$$F_{\text{TRR[ speed],adj}} = F_{\text{TRR[ speed]}} \cdot \left[ 1 + 0.006 \cdot (24 - \bar{T}_{\text{seg[ speed]}}) \right]$$

Eq. 1037.528-13

Where:

$\bar{T}_{\text{seg[ speed]}}$  = the average ambient temperature during the low or high speed segments.

*Example:*

$$F_{\text{TRRhi}} = 1028.7 \text{ N}$$

$$F_{\text{TRRlo}} = 837.5 \text{ N}$$

$$\bar{T}_{\text{seghi}} = 25.5 \text{ }^\circ\text{C}$$

$$\bar{T}_{\text{seglo}} = 25.1 \text{ }^\circ\text{C}$$

$$F_{\text{TRRhi,adj}} = 1028.7 \cdot [1 + 0.006 \cdot (24 - 25.5)] = 1019.4 \text{ N}$$

$$F_{\text{TRRlo,adj}} = 837.5 \cdot [1 + 0.006 \cdot (24 - 25.1)] = 832.0 \text{ N}$$

(v) Determine  $\Delta F_{\text{TRR}}$  as follows:

$$\Delta F_{\text{TRR}} = F_{\text{TRRhi,adj}} + F_{\text{TRRlo,adj}}$$

Eq. 1037.528-14

*Example:*

$$\Delta F_{\text{TRR}} = 1019.4 - 832.0 = 187.4 \text{ N}$$

(7) For trailer testing, determine  $\Delta F_{\text{TRR}}$  using a default value adjusted to the ambient temperature instead of performing a rolling resistance test, as follows:

$$\Delta F_{\text{TRR}} = \Delta F_{\text{TRR,def}} \left[ 1 + 0.006 \cdot (24 - \bar{T}_{\text{coast}}) \right]$$

Eq. 1037.528-15

Where:

$\Delta F_{\text{TRR,def}}$  = default rolling resistance force speed adjustment; Use 215 N for long box vans and 150 N for short box vans.

$\bar{T}_{\text{coast}}$  = the average ambient temperature during both low and high speed segments.

*Example:*

$$\Delta F_{\text{TRR,def}} = 215 \text{ N}$$

$$\bar{T}_{\text{coast}} = 25.5 \text{ }^\circ\text{C}$$

$$\Delta F_{\text{TRR}} = 215 \cdot [1 + 0.0006 \cdot (24 - 25.5)] = 213.1 \text{ N}$$

(8) Square the air speed measurements and calculate average

squared air speed during each speed range for each run,  $\bar{v}_{\text{air,hi}}^2$  and  $\bar{v}_{\text{air,lo}}^2$ .

(9) Average the  $F_{\text{lo}}$  and  $\bar{v}_{\text{air,lo}}^2$  values for each pair of runs in opposite directions. If running complete coastdowns as described in paragraph (d)(1) or one high-speed segment per direction as described in paragraph (d)(2), average every two  $F_{\text{lo}}$  and  $\bar{v}_{\text{air,lo}}^2$  values. If running two high-speed segments per direction as described in paragraph (d)(2), average every four  $F_{\text{lo}}$  and  $\bar{v}_{\text{air,lo}}^2$  values. Use these values as

$F_{\text{lo,pair}}$  and  $\bar{v}_{\text{air,lo,pair}}^2$  in the calculations in this paragraph (h) to apply to each of the two or four high-speed segments from the same runs as the low-speed segments used to determine  $F_{\text{lo,pair}}$  and  $\bar{v}_{\text{air,lo,pair}}^2$ .

(10) Calculate average air temperature  $\bar{T}$  and air pressure  $\bar{P}_{\text{act}}$  during each high-speed run.

(11) Calculate drag area,  $C_d A$ , in  $\text{m}^2$  for each high-speed segment using the following equation, expressed to at least three decimal places:

$$C_d A = \frac{2 \cdot (F_{hi} - F_{lo, pair} - \Delta F_{spin} - \Delta F_{TRR})}{(\bar{v}_{air, hi}^2 - \bar{v}_{air, lo, pair}^2)} \cdot \frac{R \cdot \bar{T}}{\bar{P}_{act}}$$

Eq. 1037.528-16

Where:

$F_{hi}$  = road load force at high speed determined from Eq. 1037.528-7.  
 $F_{lo, pair}$  = the average of  $F_{lo}$  values for a pair of opposite direction runs calculated as described in paragraph (h)(9) of this section.  
 $\Delta F_{spin}$  = the difference in drive-axle spin loss force between high-speed and low-speed coastdown segments. This is described in paragraph (h)(5) of this section for tractor testing. Let  $\Delta F_{spin} = 110$  N for trailer testing.

$\Delta F_{TRR}$  = the difference in tire rolling resistance force between high-speed and low-speed coastdown segments as described in paragraphs (h)(6) or (7) of this section.

$\bar{v}_{air, lo, pair}^2$  = the average of  $\bar{v}_{air, lo}^2$  values for a pair of opposite direction runs calculated as described in paragraph (h)(9) of this section.

$R$  = specific gas constant = 287.058 J/(kg·K).

$\bar{T}$  = mean air temperature expressed to at least one decimal place.

$\bar{P}_{act}$  = mean absolute air pressure expressed to at least one decimal place.

Example:

$F_{hi} = 4645.5$  N

$F_{lo, pair} = 1005.0$  N

$\Delta F_{spin} = 77.0$  N

$\Delta F_{TRR} = 187.4$  N

$\bar{v}_{air, hi}^2 = 933.4$  m<sup>2</sup>/s<sup>2</sup>

$\bar{v}_{air, lo, pair}^2 = 43.12$  m<sup>2</sup>/s<sup>2</sup>

$R = 287.058$  J/(kg·K)

$\bar{T} = 285.97$  K

$\bar{P}_{act} = 101.727$  kPa = 101727 Pa

$$C_d A = \frac{2 \cdot (4640.5 - 1005.0 - 77.0 - 187.4)}{(933.4 - 43.12)} \cdot \frac{287.058 \cdot 285.97}{101727}$$

$C_d A = 6.120$  m<sup>2</sup>

(12) Calculate your final  $C_d A$  value from the high-speed segments as follows:

(i) Eliminate all points where there were known equipment problems or other measurement problems.

(ii) Of the remaining points, calculate the median of the absolute value of the yaw angles,  $\psi_{med}$ , and eliminate all  $C_d A$  values that differ by more than 1.0° from  $\psi_{med}$ .

(iii) Of the remaining points, calculate the mean and standard deviation of  $C_d A$  and eliminate all values that differ by more than 2.0 standard deviations from the mean value.

(iv) There must be at least 24 points remaining. Of the remaining points, recalculate the mean yaw angle. Round the mean yaw angle to the nearest 0.1°. This final result is the effective yaw angle,  $\psi_{eff}$ , for coastdown testing.

(v) For the same set of points, recalculate the mean  $C_d A$ . This is the final result of the coastdown test,

$C_{dA}^{effective-yaw-coastdown}$ .

(i) [Reserved]

(j) Include the following information in your application for certification:

(1) The name, location, and description of your test facilities, including background/history, equipment and capability, and track and facility elevation, along with the grade and size/length of the track.

(2) Test conditions for each test result, including date and time, wind speed and direction, ambient temperature and humidity, vehicle speed, driving distance, manufacturer name, test vehicle/model type, model year,

applicable family, tire type and rolling resistance, weight of tractor-trailer (as tested), and driver identifier(s).

(3) Average  $C_d A$  and yaw angle results and all the individual run results (including voided or invalid runs).

#### § 1037.530 Wind-tunnel procedures for calculating drag area ( $C_d A$ ).

The wind-tunnel procedure specified in this section is considered to be the primary procedure for trailers, but is an alternate procedure for tractors.

(a) You may measure drag areas consistent with published SAE procedures as described in this section using any wind tunnel recognized by the Subsonic Aerodynamic Testing Association, subject to the provisions of §§ 1037.525 through 1037.527. If your wind tunnel does not meet the specifications described in this section, you may ask us to approve it as an alternate method under § 1037.525(d) or § 1037.526(d). All wind tunnels and wind tunnel tests must meet the specifications described in SAE J1252 (incorporated by reference in § 1037.810), with the following exceptions and additional provisions:

(1) The Overall Vehicle Reynolds number,  $Re_{v, o}$ , must be at least  $1.0 \cdot 10^6$ . Tests for Reynolds effects described in Section 7.1 of SAE J1252 are not required.

(2) For full-scale wind tunnel tractor testing, use good engineering judgment to select a trailer that is a reasonable representation of the trailer used for reference coastdown testing. For example, where your wind tunnel is not long enough to test the tractor with a standard 53 foot box van, it may be

appropriate to use a shorter box van. In such a case, the correlation developed using the shorter trailer would only be valid for testing with the shorter trailer.

(3) For reduced-scale wind tunnel testing, use a one-eighth or larger scale model of a tractor and trailer that is sufficient to simulate airflow through the radiator inlet grill and across an engine geometry that represents engines commonly used in your test vehicle.

(b) Open-throat wind tunnels must also meet the specifications of SAE J2071 (incorporated by reference in § 1037.810).

(c) To determine  $C_d A$  values for certifying tractors, perform wind-tunnel testing with a tractor-trailer combination using the manufacturer's tractor and a standard trailer. To determine  $C_d A$  values for certifying trailers, perform wind-tunnel testing with a tractor-trailer combination using a standard tractor. Use a moving/rolling floor if the facility has one. For Phase 1 tractors, conduct the wind tunnel tests at a zero yaw angle. For Phase 2 vehicles, conduct the wind tunnel tests by measuring the drag area at yaw angles of +4.5° and -4.5° and calculating the average of those two values.

(d) In your request to use wind-tunnel testing for tractors, or in your application for certification for trailers, describe how you meet all the specifications that apply under this section, using terminology consistent with SAE J1594 (incorporated by reference in § 1037.810). If you request our approval to use wind-tunnel testing even though you do not meet all the specifications of this section, describe how your method nevertheless qualifies

as an alternate method under § 1037.525(d) or 1037.526(d) and include all the following information:

(1) Identify the name and location of the test facility for your wind-tunnel method.

(2) Background and history of the wind tunnel.

(3) The wind tunnel's layout (with diagram), type, and construction (structural and material).

(4) The wind tunnel's design details: The type and material for corner turning vanes, air settling specification, mesh screen specification, air straightening method, tunnel volume, surface area, average duct area, and circuit length.

(5) Specifications related to the wind tunnel's flow quality: Temperature control and uniformity, airflow quality, minimum airflow velocity, flow uniformity, angularity and stability, static pressure variation, turbulence intensity, airflow acceleration and deceleration times, test duration flow quality, and overall airflow quality achievement.

(6) Test/working section information: Test section type (e.g., open, closed, adaptive wall) and shape (e.g., circular, square, oval), length, contraction ratio, maximum air velocity, maximum dynamic pressure, nozzle width and height, plenum dimensions and net volume, maximum allowed model scale, maximum model height above road, strut movement rate (if applicable), model support, primary boundary layer slot, boundary layer elimination method, and photos and diagrams of the test section.

(7) Fan section description: Fan type, diameter, power, maximum rotational speed, maximum speed, support type, mechanical drive, and sectional total weight.

(8) Data acquisition and control (where applicable): Acquisition type, motor control, tunnel control, model balance, model pressure measurement, wheel drag balances, wing/body panel balances, and model exhaust simulation.

(9) Moving ground plane or rolling road (if applicable): Construction and material, yaw table and range, moving ground length and width, belt type, maximum belt speed, belt suction mechanism, platen instrumentation, temperature control, and steering.

(10) Facility correction factors and purpose.

**§ 1037.532 Using computational fluid dynamics to calculate drag area ( $C_dA$ ).**

This section describes how to use commercially available computational fluid dynamics (CFD) software to determine  $C_dA$  values, subject to the

provisions of §§ 1037.525 through 1037.527. This is considered to be an alternate method for both tractors and trailers.

(a) For Phase 2 vehicles, use SAE J2966 (incorporated by reference in § 1037.810), with the following clarifications and exceptions:

(1) Vehicles are subject to the requirement to meet standards based on the average of testing at yaw angles of  $+4.5^\circ$  or  $-4.5^\circ$ ; however, you may submit your application for certification with CFD results based on only one of those yaw angles.

(2) For CFD code with a Navier-Stokes based solver, follow the additional steps in paragraph (d) of this section. For Lattice-Boltzmann based CFD code, follow the additional steps in paragraph (e) of this section.

(3) Simulate a Reynolds number of 5.1 million and an air speed of 65 mi/hr.

(4) Perform the General On-Road Simulation (not the Wind Tunnel Simulation).

(5) Use a free stream turbulence intensity of 0.0%.

(6) Choose time steps that can accurately resolve intrinsic flow instabilities, consistent with good engineering judgment.

(7) The result must be drag area ( $C_dA$ ), not drag coefficient ( $C_d$ ), based on an air speed of 65 mi/hr.

(8) Submit information as described in paragraph (g) of this section.

(b) For Phase 1 tractors, apply the procedures as specified in paragraphs (c) through (f) of this section. Paragraphs (c) through (f) of section apply for Phase 2 vehicles only as specified in paragraph (a) of this section.

(c) To determine  $C_dA$  values for certifying a tractor, perform CFD modeling based on a tractor-trailer combination using the manufacturer's tractor and a standard trailer. To determine  $C_dA$  values for certifying a trailer, perform CFD modeling based on a tractor-trailer combination using a standard tractor. Perform all CFD modeling as follows:

(1) Specify a blockage ratio at or below 0.2% to simulate open-road conditions.

(2) Assume zero yaw angle.

(3) Model the tractor with an open grill and representative back pressures based on available data describing the tractor's pressure characteristics.

(4) Enable the turbulence model and mesh deformation.

(5) Model tires and ground plane in motion to simulate a vehicle moving forward in the direction of travel.

(6) Apply the smallest cell size to local regions on the tractor and trailer in areas of high flow gradients and smaller-

geometry features (e.g., the A-pillar, mirror, visor, grille and accessories, trailer-leading edge, trailer-trailing edge, rear bogey, tires, and tractor-trailer gap).

(7) Simulate a vehicle speed of 55 mi/hr.

(d) Take the following steps for CFD code with a Navier-Stokes formula solver:

(1) Perform an unstructured, time-accurate analysis using a mesh grid size with a total volume element count of at least 50 million cells of hexahedral and/or polyhedral mesh cell shape, surface elements representing the geometry consisting of no less than 6 million elements, and a near-wall cell size corresponding to a  $y^+$  value of less than 300.

(2) Perform the analysis with a turbulence model and mesh deformation enabled (if applicable) with boundary layer resolution of  $\pm 95\%$ . Once the results reach this resolution, demonstrate the convergence by supplying multiple, successive convergence values for the analysis. The turbulence model may use k-epsilon (k- $\epsilon$ ), shear stress transport k-omega (SST k- $\omega$ ), or other commercially accepted methods.

(e) For Lattice-Boltzmann based CFD code, perform an unstructured, time-accurate analysis using a mesh grid size with total surface elements of at least 50 million cells using cubic volume elements and triangular and/or quadrilateral surface elements with a near-wall cell size of no greater than 6 mm on local regions of the tractor and trailer in areas of high flow gradients and smaller geometry features, with cell sizes in other areas of the mesh grid starting at twelve millimeters and increasing in size from this value as the distance from the tractor and trailer increases.

(f) You may ask us to allow you to perform CFD analysis using parameters and criteria other than those specified in this section, consistent with good engineering judgment. In your request, you must demonstrate that you are unable to perform modeling based on the specified conditions (for example, you may have insufficient computing power, or the computations may require inordinate time), or you must demonstrate that different criteria (such as a different mesh cell shape and size) will yield better results. In your request, you must also describe your recommended alternative parameters and criteria, and describe how this approach will produce results that adequately represent a vehicle's in-use performance. We may require that you supply data demonstrating that your selected parameters and criteria will



provide a sufficient level of detail to yield an accurate analysis. If you request an alternative approach because it will yield better results, we may require that you perform CFD analysis using both your recommended criteria and parameters and the criteria and parameters specified in this section to compare the resulting key aerodynamic characteristics, such as pressure profiles, drag build-up, and turbulent/laminar flow at key points around the tractor-trailer combination.

(g) Include the following information in your request to determine  $C_{dA}$  values using CFD:

- (1) The name of the software.
- (2) The date and version number of the software.
- (3) The name of the company producing the software and the corresponding address, phone number, and Web site.
- (4) Identify whether the software uses Navier-Stokes or Lattice-Boltzmann equations.
- (5) Describe the input values you will use to simulate the vehicle's aerodynamic performance for comparing to coastdown results.

**§ 1037.534 Constant-speed procedure for calculating drag area ( $C_{dA}$ ).**

This section describes how to use constant-speed aerodynamic drag testing to determine  $C_{dA}$  values, subject to the provisions of § 1037.525. This is considered to be an alternate method for tractors.

(a) *Test track.* Select a test track that meets the specifications described in § 1037.528(c)(3).

(b) *Ambient conditions.* At least two tests are required. For one of the tests, ambient conditions must remain within the specifications described in § 1037.528(c) throughout the preconditioning and measurement procedure. The other tests must also meet those specifications except for the wind conditions. The wind conditions must be such that 80 percent of the values of yaw angle,  $\psi_{air}$ , from the 50 mi/hr and 70 mi/hr test segments are between  $4^\circ$  and  $10^\circ$  or between  $-4^\circ$  and  $-10^\circ$ .

(c) *Vehicle preparation.* Perform testing with a tractor-trailer combination using the manufacturer's tractor and a standard trailer. Prepare tractors and trailers for testing as described in § 1037.528(b). Install measurement instruments meeting the requirements of 40 CFR part 1065, subpart C, that have been calibrated as described in 40 CFR part 1065, subpart D, as follows:

(1) Measure torque at each of the drive wheels using a hub torque meter or a rim torque meter. If testing a tractor

with two drive axles, you may disconnect one of the drive axles from receiving torque from the driveshaft, in which case you would measure torque at only the wheels that receive torque from the driveshaft. Set up instruments to read engine rpm for calculating rotational speed at the point of the torque measurements, or install instruments for measuring the rotational speed of the wheels directly.

(2) Install instrumentation to measure vehicle speed at 10 Hz, with an accuracy and resolution of 0.1 mi/hr. Also install instrumentation for reading engine rpm from the engine's onboard computer.

(3) Mount an anemometer on the trailer as described in § 1037.528(f).

(4) Fill the vehicle's fuel tanks so they are at maximum capacity at the start of the measurement procedure.

(5) Measure the weight over each axle to the nearest 20 kg, with a full fuel tank, including the driver and any passengers that will be in the vehicle during the test.

(d) *Measurement procedure.* The measurement sequence consists of vehicle preconditioning followed by stabilization and measurement over five consecutive constant-speed test segments with three different speed setpoints (10, 50, and 70 mi/hr). Each test segment is divided into smaller increments for data analysis.

(1) Precondition the vehicle and zero the torque meters as follows:

(i) If you are using rim torque meters, zero the torque meters by lifting each instrumented axle and recording torque signals for at least 30 seconds, and then drive the vehicle at 50 mi/hr for at least 30 minutes.

(ii) If you are using any other kind of torque meter, drive the vehicle at 50 mi/hr for at least 30 minutes, and then allow the vehicle to coast down from full speed to a complete standstill while the clutch is disengaged or the transmission is in neutral, without braking. Zero the torque meters within 60 seconds after the vehicle stops moving by recording the torque signals for at least 30 seconds, and directly resume vehicle preconditioning at 50 mi/hr for at least 1.25 mi.

(iii) You may calibrate instruments during the preconditioning drive.

(2) Perform testing as described in paragraph (d)(3) of this section over a sequence of test segments at constant vehicle speed as follows:

(i)  $300 \pm 30$  seconds in each direction at 10 mi/hr.

(ii)  $450 \pm 30$  seconds in each direction at 70 mi/hr.

(iii)  $450 \pm 30$  seconds in each direction at 50 mi/hr.

(iv)  $450 \pm 30$  seconds in each direction at 70 mi/hr.

(v)  $450 \pm 30$  seconds in each direction at 50 mi/hr.

(vi)  $300 \pm 30$  seconds in each direction at 10 mi/hr.

(3) When the vehicle preconditioning described in paragraph (d)(1) of this section is complete, stabilize the vehicle at the specified speed for at least 200 meters and start taking measurements. The test segment starts when you start taking measurements for all parameters.

(4) During the test segment, continue to operate the vehicle at the speed setpoint, maintaining constant speed and torque within the ranges specified in paragraph (e) of this section. Drive the vehicle straight with minimal steering; do not change gears. Perform measurements as follows during the test segment:

(i) Measure the rotational speed of the driveshaft, axle, or wheel where the torque is measured, or calculate it from engine rpm in conjunction with gear and axle ratios, as applicable.

(ii) Measure vehicle speed in conjunction with time-of-day data.

(iii) Measure ambient conditions, air speed, and air direction as described in § 1037.528(e) and (f). Correct air speed and air direction as described in paragraphs (f)(1) and (2) of this section.

(5) You may divide a test segment into multiple passes by suspending and resuming measurements. Stabilize vehicle speed before resuming measurements for each pass as described in paragraph (d)(3) of this section. Analyze the data from multiple passes by combining them into a single sequence of measurements for each test segment.

(6) Divide measured values into even 10 second increments. If the last increment for each test segment is less than 10 seconds, disregard measured values from that increment for all calculations under this section.

(e) *Validation criteria.* Analyze measurements to confirm that the test is valid. Analyze vehicle speed and drive torque by calculating the mean speed and torque values for each successive 1 second increment, for each successive 10 second increment, and for each test segment. The test is valid if the data conform to all the following specifications:

(1) *Vehicle speed.* The mean vehicle speed for the test segment must be within 1.00 mi/hr of the speed setpoint. In addition, for testing at 50 mi/hr and 70 mi/hr, all ten of the 1 second mean vehicle speeds used to calculate a corresponding 10 second mean vehicle speed must be within  $\pm 0.2$  mi/hr of that 10 second mean vehicle speed. Perform

the same data analysis for testing at 10 mi/hr, but apply a validation threshold of  $\pm 0.1$  mi/hr.

(2) *Drive torque.* All ten of the 1 second mean torque values used to calculate a corresponding 10 second mean torque value must be within  $\pm 50\%$  of that 10 second mean torque value.

(3) *Torque drift.* Torque meter drift may not exceed  $\pm 1\%$ . Determine torque meter drift by repeating the procedure

described in paragraph (d)(1) of this section after testing is complete, except that driving the vehicle is necessary only to get the vehicle up to 50 mi/hr as part of coasting to standstill.

(f) *Calculations.* Analyze measured data for each time segment after time-aligning all the data. Use the following calculations to determine  $C_{dA}$ :

(1) *Onboard air speed.* Correct onboard anemometer measurements for

air speed using onboard measurements and measured ambient conditions as described in § 1037.528(f), except that you must first divide the test segment into consecutive 10 second increments. Disregard data from the final increment of the test segment if it is less than 10 seconds. This analysis results in the following equation for correcting air speed measurements:

$$v_{\text{air}} = \alpha_0 + \alpha_1 \cdot v_{\text{air,meas}}$$

Eq. 1037.534-1

(2) *Yaw angle.* Correct the onboard anemometer measurements for air direction for each test segment as follows:

(i) Calculate arithmetic mean values for vehicle speed,  $\bar{v}$ , wind speed,  $\bar{w}$ , and wind direction,  $\bar{\phi}_w$ , over each 10 second increment for each test segment. Disregard data from the final increment

of the test segment if it is less than 10 seconds.

(ii) Calculate the theoretical air direction,  $\bar{\psi}_{\text{air,th}}$ , for each 10 second increment using the following equation:

$$\bar{\psi}_{\text{air,th}} = \arctan \left( \frac{\bar{w} \cdot \sin(\bar{\phi}_w + \phi_{\text{veh}})}{\bar{v} + \bar{w} \cdot \cos(\bar{\phi}_w + \phi_{\text{veh}})} \right)$$

Eq. 1037.534-2

Where:

$\phi_{\text{veh}}$  = the vehicle direction, as described in § 1037.528(f)(2).

*Example:*

$\bar{w} = 7.1$  mi/hr  
 $\bar{v} = 69.9$  mi/hr

$\bar{\phi}_w = 47.0^\circ$   
 $\bar{\phi}_{\text{veh}} = 0^\circ$

$$\bar{\psi}_{\text{air,th}} = \arctan \left( \frac{7.1 \cdot \sin(47.0 + 0)}{69.9 + 7.1 \cdot \cos(47.0 + 0)} \right)$$

$\bar{\psi}_{\text{air,th}} = 3.97^\circ$

(iii) Perform a linear regression using paired values of  $\bar{\psi}_{\text{air,th}}$  and measured air

direction,  $\bar{\psi}_{\text{air,meas}}$ , from each 10 second increment for all 50 mi/hr and 70 mi/hr test segments to determine the air-

direction correction coefficients,  $\beta_0$  and  $\beta_1$ , based on the following equation:

$$\bar{\psi}_{\text{air,th}} = \beta_0 + \beta_1 \cdot \bar{\psi}_{\text{air,meas}}$$

Eq. 1037.534-3

(iv) For all 50 mi/hr and 70 mi/hr test segments, correct each measured value

of air direction using the following equation:

$$\psi_{\text{air}} = \beta_0 + \beta_1 \cdot \psi_{\text{air,meas}}$$

Eq. 1037.534-4

(3) *Road load force.* (i) Average the sum of the corrected torques, the average of the wheel speed

measurements, and the vehicle speed over every 10 second increment to determine,  $\bar{T}_{\text{total}}$ ,  $\bar{f}_{\text{wheel}}$ , and  $\bar{v}$ .

(ii) Calculate a mean road load force,  $\bar{F}_{\text{RL[Speed]}}$ , for each 10 second increment using the following equation:

$$\bar{F}_{RL[\text{speed}]} = \frac{\bar{T}_{\text{total}}}{\bar{v}} \cdot \frac{\bar{f}_{\text{wheel}} \cdot \pi}{30} + M \cdot a_g \cdot \frac{h_{\text{inc,start}} - h_{\text{inc,end}}}{|D_{\text{inc,start}} - D_{\text{inc,end}}|}$$

Eq. 1037.534-5

Where:

$\bar{T}_{\text{total}}$  = mean of all corrected torques at a point in time.

$\bar{v}$  = mean vehicle speed.

$\bar{f}_{\text{wheel}}$  = mean wheel speed.

$M$  = the measured vehicle mass.

$a_g$  = acceleration of Earth's gravity, as described in 40 CFR 1065.630.

$h_{\text{inc}}$  = elevation at the start or end of each 10 second increment expressed to at least two decimal places.

$D_{\text{inc}}$  = distance traveled on the road surface from a fixed reference location along the road to the start or end of each 10 second increment, expressed to at least one decimal place.

*Example:*

$\bar{T}_{\text{total}} = 2264.9 \text{ N}\cdot\text{m}$

$\bar{v} = 31.6 \text{ m/s}$

$\bar{f}_{\text{wheel}} = 598.0 \text{ r/min}$

$M = 16508 \text{ kg}$

$a_g = 9.8061 \text{ m/s}^2$

$h_{\text{inc,start}} = 0.044 \text{ m}$

$h_{\text{inc,end}} = 0.574 \text{ m}$

$D_{\text{inc,start}} = 215.4 \text{ m}$

$D_{\text{inc,end}} = 697.8 \text{ m}$

$$\bar{F}_{RL70} = \frac{2264.9}{31.6} \cdot \frac{598.0 \cdot \pi}{30} + 16508 \cdot 9.8061 \cdot \frac{0.044 - 0.574}{|215.4 - 697.8|}$$

$\bar{F}_{RL70} = 4310.6 \text{ N}$

(4) *Determination of drag area.*

Calculate a vehicle's drag area as follows:

(i) Calculate the mean road load force from all 10 second increments from the 10 mi/hr test segments from the test that was within the wind limits specified in § 1037.528(c),  $\bar{F}_{RL10,\text{test}}$ . This value

represents the mechanical drag force acting on the vehicle.

(ii) Calculate the mean aerodynamic force for each 10 second increment,  $\bar{F}_{\text{aero}[\text{speed}]}$ , from the 50 mi/hr and 70 mi/hr test segments by subtracting  $\bar{F}_{RL10,\text{test}}$  from  $\bar{F}_{RL[\text{speed}]}$ .

(iii) Average the corrected air speed and corrected yaw angle over every 10

second segment from the 50 mi/hr and 70 mi/hr test segments to determine  $\bar{v}_{\text{air}}$  and  $\bar{\psi}_{\text{air}}$ .

(iv) Calculate  $C_d A$  for each 10 second increment from the 50 mi/hr and 70 mi/hr test segments using the following equation:

$$C_d A_{i[\text{speed}]} = \left[ \frac{2 \cdot \bar{F}_{\text{aero}[\text{speed}]}}{\bar{v}_{\text{air}[\text{speed}]}^2} \cdot \frac{R \cdot \bar{T}}{\bar{P}_{\text{act}}} \right]_i$$

Eq. 1037.534-6

Where:

$C_d A_{i[\text{speed}]}$  = the mean drag area for each 10 second increment,  $i$ .

$\bar{F}_{\text{aero}[\text{speed}]}$  = mean aerodynamic force over a given 10 second increment =  $\bar{F}_{RL[\text{speed}]} - \bar{F}_{RL10,\text{test}}$ .

$\bar{v}_{\text{air}[\text{speed}]}$  = mean aerodynamic force over a given 10 second increment.

$R$  = specific gas constant = 287.058 J/(kg·K).

$\bar{T}$  = mean air temperature.

$\bar{P}_{\text{act}}$  = mean absolute air pressure.

*Example:*  
 $\bar{F}_{RL70} = 4310.6 \text{ N}$

$\bar{F}_{RL10,\text{test}} = 900.1 \text{ N}$

$\bar{F}_{\text{aero}70} = 4310.6 - 900.1 = 3410.5 \text{ N}$

$\bar{v}_{\text{air}70}^2 = 1089.5 \text{ m}^2/\text{s}^2$

$R = 287.058 \text{ J}/(\text{kg}\cdot\text{K})$

$\bar{T} = 293.68 \text{ K}$

$\bar{P}_{\text{act}} = 101300 \text{ Pa}$

$$C_d A_{i70} = \left[ \frac{2 \cdot 3410.5}{1089.5} \cdot \frac{287.058 \cdot 293.68}{101300} \right]_i$$

$C_d A_{i70} = 5.210 \text{ m}^2$

(v) Plot all  $C_d A$  values from the 50 mi/hr and 70 mi/hr test segments against

the corresponding values for corrected yaw angle for each 10 second increment. Create a regression based on a fourth-

order polynomial regression equation of the following form:

$$C_d A = C_d A_{\text{ZeroYaw}} + a_1 \cdot \bar{\psi}_{\text{air}} + a_2 \cdot \bar{\psi}_{\text{air}}^2 + a_3 \cdot \bar{\psi}_{\text{air}}^3 + a_4 \cdot \bar{\psi}_{\text{air}}^4$$

Eq. 1037.534-7

(vi) Determine  $C_{dA_{wa-alt}}$  as the average of  $C_{dA}$  values at  $4.5^\circ$  and  $-4.5^\circ$  by applying Eq. 1037.534–7 at those angles.

(g) *Documentation.* Keep the following records related to the constant-speed procedure for calculating drag area:

- (1) The measurement data for calculating  $C_{dA}$  as described in this section.
- (2) A general description and pictures of the vehicle tested.
- (3) The vehicle’s maximum height and width.
- (4) The measured vehicle mass.
- (5) Mileage at the start of the first test segment and at the end of the last test segment.
- (6) The date of the test, the starting time for the first test segment, and the ending time for the last test segment.
- (7) The transmission gear used for each test segment.
- (8) The data describing how the test was valid relative to the specifications and criteria described in paragraphs (b) and (e) of this section.
- (9) A description of any unusual events, such as a vehicle passing the test vehicle, or any technical or human errors that may have affected the  $C_{dA}$  determination without invalidating the test.

**§ 1037.540 Special procedures for testing vehicles with hybrid power take-off.**

This section describes optional procedures for quantifying the reduction in greenhouse gas emissions for vehicles as a result of running power take-off (PTO) devices with a hybrid energy delivery system. See § 1037.550 for powertrain testing requirements that apply for drivetrain hybrid systems. The procedures are written to test the PTO by ensuring that the engine produces all of the energy with no net change in stored energy (charge-sustaining), and for plug-in hybrid vehicles, also allowing for drawing down the stored energy (charge-depleting). The full charge-sustaining test for the hybrid vehicle is from a fully charged renewable energy storage system (RESS) to a depleted RESS and then back to a fully charged RESS. You must include all hardware for the PTO system. You may ask us to modify the provisions of this section to allow testing hybrid vehicles other than electric-battery hybrids, consistent with good engineering judgment. For plug-in hybrids, use a utility factor to properly weight charge-sustaining and charge-depleting operation as described in paragraph (f)(3) of this section.

- (a) Select two vehicles for testing as follows:
  - (1) Select a vehicle with a hybrid energy delivery system to represent the

range of PTO configurations that will be covered by the test data. If your test data will represent more than one PTO configuration, use good engineering judgment to select the configuration with the maximum number of PTO circuits that has the smallest potential reduction in greenhouse gas emissions.

(2) Select an equivalent conventional vehicle as specified in § 1037.615.

(b) Measure PTO emissions from the fully warmed-up conventional vehicle as follows:

- (1) Without adding a restriction, instrument the vehicle with pressure transducers at the outlet of the hydraulic pump for each circuit. Perform pressure measurements with a frequency of at least 1 Hz.

(2) Operate the PTO system with no load for at least 15 seconds. Measure gauge pressure and record the average value over the last 10 seconds ( $\bar{p}_{min}$ ). For hybrid PTO systems the measured pressure with no load is typically zero. Apply maximum operator demand to the PTO system until the pressure relief valve opens and pressure stabilizes; measure gauge pressure and record the average value over the last 10 seconds ( $\bar{p}_{max}$ ).

(3) Denormalize the PTO duty cycle in Appendix II of this part using the following equation:

$$p_{refi} = p_i \cdot (\bar{p}_{max} - \bar{p}_{min}) + \bar{p}_{min}$$

Eq. 1037.540-1

Where:

$p_{refi}$  = the reference pressure at each point  $i$  in the PTO cycle.

$p_i$  = the normalized pressure at each point  $i$  in the PTO cycle (relative to  $\bar{p}_{max}$ ).

$\bar{p}_{max}$  = the mean maximum pressure measured in paragraph (b)(2) of this section.

$\bar{p}_{min}$  = the mean minimum pressure measured in paragraph (b)(2) of this section.

(4) If the PTO system has two circuits, repeat paragraph (b)(2) and (3) of this section for the second PTO circuit.

(5) Install a system to control pressures in the PTO system during the cycle.

(6) Start the engine.

(7) Depending on the number of circuits the PTO system has, operate the vehicle over one or concurrently over both of the denormalized PTO duty cycles in Appendix II of this part. Measure emissions during operation over each duty cycle using the provisions of 40 CFR part 1066.

(8) Measured pressures must meet the cycle-validation specifications in the following table for each test run over the duty cycle:

TABLE 1 OF § 1037.540—STATISTICAL CRITERIA FOR VALIDATING EACH TEST RUN OVER THE DUTY CYCLE

Parameter <sup>1</sup>	Pressure
Slope, $a_1$ .....	$0.950 \leq a_1 \leq 1.030$ .
Absolute value of intercept, $ a_0 $ .	$\leq 2.0\%$ of maximum mapped pressure.
Standard error of estimate, <i>SEE</i> .	$\leq 10\%$ of maximum mapped pressure.
Coefficient of determination, $r^2$ .	$\geq 0.970$ .

<sup>1</sup> Determine values for specified parameters as described in 40 CFR 1065.514(e) by comparing measured values to denormalized pressure values from the duty cycle in Appendix II of this part.

(c) Measure PTO emissions from the fully warmed-up hybrid vehicle as follows:

(1) Perform the steps in paragraphs (b)(1) through (5) of this section.

(2) Prepare the vehicle for testing by operating it as needed to stabilize the RESS at a full state of charge (or equivalent for non-electric RESS).

(i) For plug-in hybrid electric vehicles, we recommend charging the battery with an external electrical source.

(ii) For other vehicles, we recommend running back-to-back PTO tests until engine operation is initiated to charge the RESS. The RESS should be fully charged once engine operation stops. The ignition should remain in the “on” position.

(3) Turn the vehicle and PTO system off while the sampling system is being prepared.

(4) Turn the vehicle and PTO system on such that the PTO system is

functional, whether it draws power from the engine or a battery.

(5) Operate the vehicle over one or both of the denormalized PTO duty cycles without turning the vehicle off, until the engine starts and then shuts down. This may require running multiple repeats of the PTO duty cycles. For non-PHEV systems the test cycle is completed once the engine shuts down. For plug-in hybrid systems, continue running until the PTO hybrid is running in a charge-sustaining mode such that the "End of Test" requirements defined in 40 CFR 1066.501 are met. Measure

emissions as described in paragraph (b)(7) of this section. Use good engineering judgment to minimize the variability in testing between the two types of vehicles.

(6) For plug-in hybrid electric vehicles, follow 40 CFR 1066.501 to divide the test into charge-depleting and charge-sustaining operation.

(7) Apply cycle-validation criteria as described in paragraph (b)(8) of this section to both charge-sustaining and charge-depleting operation.

(d) Calculate the equivalent distance driven based on operating time for each

section of the PTO portion of the test as applicable by determining the time of the test and applying the conversion factor in paragraph (d)(4) of this section. For testing where fractions of a cycle were run (for example, where three cycles are completed and the halfway point of a fourth PTO cycle is reached before the engine starts and shuts down again), calculate the time of the test,  $t_{test}$ , as follows:

(1) Add up the time run for all complete tests.

(2) For fractions of a test, use the following equation to calculate the time:

$$t_{test-partial} = \frac{\sum_{i=1}^N (p_{circuit-1,i} + p_{circuit-2,i}) \cdot \Delta t}{\bar{p}_{circuit-1} + \bar{p}_{circuit-2}}$$

Eq. 1037.540-2

Where:

$i$  = an indexing variable that represents one recorded value.

$N$  = number of measurement intervals.

$p_{circuit-1,i}$  = normalized pressure command from circuit 1 of the PTO cycle for each point,  $i$ , starting from  $i = 1$ .

$p_{circuit-2,i}$  = normalized pressure command from circuit 2 of the PTO cycle for each point,  $i$ , starting from  $i = 1$ . Let  $p_{circuit-2} = 0$  if there is only one circuit.

$\bar{p}_{circuit-1}$  = the mean normalized pressure command from circuit 1 over the entire PTO cycle.

$\bar{p}_{circuit-2}$  = the mean normalized pressure command from circuit 2 over the entire PTO cycle. Let  $\bar{p}_{circuit-2} = 0$  if there is only one circuit.

$\Delta t$  = the time interval between measurements. For example, at 100 Hz,  $\Delta t = 0.0100$  seconds.

(3) Sum the time from the complete cycles and from the partial cycle.

(4) Divide the total PTO operating time from paragraph (d)(3) of this section by a conversion factor of 0.0144 hr/mi for Phase 1 and 0.0217 hr/mi for

Phase 2 to determine the equivalent distance driven. The conversion factors are based on estimates of average vehicle speed and PTO operating time as a percentage of total engine operating time; the Phase 2 conversion factor is calculated from an average speed of 27.1 mi/hr and PTO operation 37% of engine operating time, as follows:

$$Factor = \frac{37\%}{(100\% - 37\%) \cdot 27.1 \text{ mi/hr}} = 0.0217 \text{ hr/mi}$$

(e) For Phase 1, calculate combined cycle-weighted emissions of the four duty cycles for vocational vehicles, for both the conventional and hybrid PTO vehicle tests, as follows:

(1) Calculate the CO<sub>2</sub> emission rates in grams per test without rounding for both the conventional vehicle and the charge-sustaining and charge-depleting portions of the test for the hybrid vehicle as applicable.

(2) Divide the CO<sub>2</sub> mass from the PTO cycle by the distance determined in paragraph (d)(4) of this section and the standard payload to get the CO<sub>2</sub> emission rate in g/ton-mile. For plug-in hybrid electric vehicles follow paragraph (f)(3) of this section to calculate utility factor weighted CO<sub>2</sub> emissions in g/ton-mile.

(3) Calculate the g/ton-mile emission rate for the driving portion of the test specified in § 1037.510 and add this to the CO<sub>2</sub> g/ton-mile emission rate for the PTO portion of the test.

(4) Follow the provisions of § 1037.615 to calculate improvement factors and benefits for advanced technologies.

(f) For Phase 2, calculate the delta PTO fuel results for input into GEM during vehicle certification as follows:

(1) Calculate fuel consumption in grams per test,  $m_{fuelPTO}$ , without rounding, as described in 40 CFR 1036.540(d)(4) and (5) for both the conventional vehicle and the charge-sustaining and charge-depleting portions of the test for the hybrid vehicle as applicable.

(2) Divide the fuel mass by the applicable distance determined in paragraph (d)(4) of this section and the appropriate standard payload to determine the fuel rate in g/ton-mile.

(3) For plug-in hybrid electric vehicles calculate the utility factor weighted fuel consumption in g/ton-mile, as follows:

(i) Determine the utility factor fraction for the PTO system from the table in Appendix V of this part using interpolation based on the total time of the charge-depleting portion of the test as determined in paragraphs (c)(6) and (d)(3) of this section.

(ii) Weight the emissions from the charge-sustaining and charge-depleting portions of the test using the following equation:

$$m_{\text{fuelPTO,plug-in}} = m_{\text{PTO,CD}} \cdot UF_{t_{\text{CD}}} + m_{\text{PTO,CS}} \cdot (1 - UF_{t_{\text{CD}}})$$

Eq. 1037.540-3

Where:

$m_{\text{PTO,CD}}$  = mass of fuel per ton-mile while in charge-depleting mode.  
 $UF_{t_{\text{CD}}}$  = utility factor fraction at time  $t_{\text{CD}}$  as determined in paragraph (f)(3)(i) of this section.  
 $m_{\text{PTO,CS}}$  = mass of fuel per ton-mile while in charge-sustaining mode.

(4) Calculate the difference between the conventional PTO emissions result and the hybrid PTO emissions result for input into GEM.

(g) If the PTO system has more than two circuits, apply the provisions of this section using good engineering judgment.

**§ 1037.550 Powertrain testing.**

(a) This section describes how to determine engine fuel maps using a measurement procedure that involves testing an engine coupled with a powertrain to simulate vehicle operation. Engine fuel maps are part of demonstrating compliance with Phase 2 vehicle standards under this part 1037; this fuel-mapping information may come from different types of testing as described in 40 CFR 1036.510.

(b) Perform powertrain testing to establish measured fuel-consumption rates over applicable duty cycles for several different vehicle configurations. The following general provisions apply:

(1) Measure NO<sub>x</sub> emissions for each sampling period in grams. You may perform these measurements using a NO<sub>x</sub> emission-measurement system that meets the requirements of 40 CFR part 1065, subpart J. Include these measured NO<sub>x</sub> values any time you report to us your greenhouse gas emissions or fuel consumption values from testing under this section. If a system malfunction prevents you from measuring NO<sub>x</sub> emissions during a test under this section but the test otherwise gives valid results, you may consider this a valid test and omit the NO<sub>x</sub> emission measurements; however, we may require you to repeat the test if we determine that you inappropriately voided the test with respect to NO<sub>x</sub> emission measurement.

(2) This section uses engine parameters and variables that are consistent with 40 CFR part 1065.

(3) While this section includes the detailed equations, you need to develop your own driver model and vehicle model; we recommend that you use the MATLAB/Simulink code provided at [www.epa.gov/otaq/climate/gem.htm](http://www.epa.gov/otaq/climate/gem.htm).

(c) Select an engine and powertrain for testing as described in § 1037.231.

(d) Set up the engine according to 40 CFR 1065.110. The default test configuration involves connecting the powertrain's transmission output shaft

directly to the dynamometer. You may instead set up the dynamometer to connect at the wheel hubs if your powertrain configuration requires it, such as for hybrid powertrains, or if you want to represent the axle performance with powertrain test results. If you connect at the wheel hubs, input your test results into GEM to reflect this.

(e) Cool the powertrain during testing so temperatures for intake-air, oil, coolant, block, head, transmission, battery, and power electronics are within their expected ranges for normal operation. You may use auxiliary coolers and fans.

(f) Set the dynamometer to operate in speed-control mode. Record data as described in 40 CFR 1065.202. Command and control dynamometer speed at a minimum of 5 Hz. If you choose to command the dynamometer at a slower rate than the calculated dynamometer speed setpoint, use good engineering judgment to subsample the calculated setpoints for use in commanding the dynamometer speed setpoint. Design a vehicle model to use the measured torque and calculate the dynamometer speed setpoint at a rate of at least 100 Hz, as follows:

(1) Calculate the dynamometer's angular speed target,  $f_{\text{nref,dyno}}$ , based on the simulated linear speed of the tires:

$$f_{\text{nref,dyno}} = \frac{k_{a[\text{speed}]} \cdot v_{\text{refi}}}{2 \cdot \pi \cdot r_{[\text{speed}]}}$$

Eq. 1037.550-1

Where:

$k_{a[\text{speed}]}$  = drive axle ratio as determined in paragraph (h) of this section.

$v_{\text{refi}}$  = simulated vehicle reference speed. Use the unrounded result for calculating  $f_{\text{nref,dyno}}$ .

$r_{[\text{speed}]}$  = tire radius as determined in paragraph (h) of this section.

$$v_{\text{refi}} = \left( \frac{k_a \cdot T_{i-1}}{r} \cdot (Eff_{\text{axle}}) - \left( M \cdot g \cdot C_{rr} \cdot \cos(\text{atan}(G_{i-1})) + \frac{\rho \cdot C_d A}{2} \cdot v_{\text{ref,i-1}}^2 \right) - F_{\text{brake,i-1}} - F_{\text{grade,i-1}} \right) \cdot \frac{\Delta T_{i-1}}{M + M_{\text{rotating}}} + v_{\text{ref,i-1}}$$

Eq. 1037.550-2

Where:

$i$  = a time-based counter corresponding to each measurement during the sampling period. Let  $v_{\text{refi}} = 0$ ; start calculations at

$i = 2$ . A 10-minute sampling period will generally involve 60,000 measurements.  $T$  = instantaneous measured torque.

$Eff_{axle}$  = axle efficiency. Use  $Eff_{axle} = 0.955$  for  $T > 0$ , and use  $Eff_{axle} = 1/0.955$  for  $T < 0$ . To calculate  $f_{nrefi,dyno}$  for a dynamometer connected at the wheel hubs, as described in paragraph (f)(2) of this section, use  $Eff_{axle} = 1.0$ .

$M$  = vehicle mass for a vehicle class as determined in paragraph (h) of this section.  
 $g$  = gravitational constant = 9.81 m/s<sup>2</sup>.  
 $C_{rr}$  = coefficient of rolling resistance for a vehicle class as determined in paragraph (h) of this section.

$G_{i-1}$  = the percent grade interpolated at distance,  $D_{i-1}$ , from the duty cycle in Appendix IV corresponding to measurement ( $i - 1$ ).

$$D_{i-1} = \sum_{i=1}^N (v_{ref,i-1} \cdot \Delta t_{i-1})$$

Eq. 1037.550-3

$\rho$  = air density at reference conditions. Use  $\rho = 1.20 \text{ kg/m}^3$ .

$C_{dA}$  = drag area for a vehicle class as determined in paragraph (h) of this section.

$F_{brake}$  = instantaneous braking force applied by the driver model.

$$F_{grade,i-1} = M \cdot g \cdot \sin(\text{atan}(G_{i-1}))$$

Eq. 1037.550-4

$\Delta t$  = the time interval between measurements. For example, at 100 Hz,  $\Delta t = 0.0100$  seconds.

$M_{rotating}$  = inertial mass of rotating components. Let  $M_{rotating} = 340 \text{ kg}$  for vocational Light HDV or vocational Medium HDV. See paragraph (h) of this

section for tractors and for vocational Heavy HDV.

*Example:*  
 This example is for a vocational Light HDV or vocational Medium HDV with 6 speed automatic transmission at B speed (Test 4 in Table 2 of 40 CFR 1036.540).

$k_{aB} = 4.0$   
 $r_B = 0.399 \text{ m}$   
 $T_{1000-1} = 500.0 \text{ N}\cdot\text{m}$   
 $C_{rr} = 6.9 \text{ kg/tonne} = 6.9 \cdot 10^{-3} \text{ kg/kg}$   
 $M = 11408 \text{ kg}$   
 $C_{dA} = 5.4 \text{ m}^2$   
 $G_{1000-1} = 1.0\% = 0.018$

$$D_{1000-1} = \sum_{i=1}^{1000} (19.99 \cdot 0.01 + 20.0 \cdot 0.01 + \dots + v_{ref,1000-1} \cdot \Delta t_{1000-1}) = 1367 \text{ m}$$

$F_{brake1000-1} = 0 \text{ N}$   
 $v_{ref1000-1} = 20.0 \text{ m/s}$

$F_{grade1001-1} = 11408 \cdot 9.81 \cdot \sin(\text{atan}(0.018))$   
 $= 2014.1 \text{ N}$

$\Delta t = 0.0100 \text{ s}$   
 $M_{rotating} = 340 \text{ kg}$

$$v_{ref1000} = \left( \frac{4.0 \cdot 500.0}{0.399} \cdot (0.955) - \left( (11408 \cdot 9.81 \cdot 6.9 \cdot \cos(\text{atan}(0.018))) + \frac{1.17 \cdot 5.4}{2} \cdot 20.0^2 \right) - 0 - 2014.1 \right) \cdot \frac{0.0100}{11408 + 340} + 20.0$$

$v_{ref1000} = 20.00129 \text{ m/s}$

$$f_{nref1000,dyno} = \frac{4.0 \cdot 20.00129}{2 \cdot 3.14 \cdot 0.399} = 31.9515 \text{ r/s} = 1917.09 \text{ rpm}$$

(2) For testing with the dynamometer connected at the wheel hubs, calculate  $f_{nref,dyno}$  using the following equation:

$$f_{\text{nref,dyno}} = \frac{v_{\text{refi}}}{2 \cdot \pi \cdot r}$$

Eq. 1037.550-5

(g) Design a driver model to simulate a human driver modulating the throttle and brake pedals to follow the test cycle as closely as possible. The driver model must meet the speed requirements for operation over the highway cruise cycles as described in § 1037.510 and for operation over the transient cycle as described in 40 CFR 1066.425(b). The exceptions in 40 CFR 1066.425(b)(4)

apply to the transient cycle and the highway cruise cycles. Design the driver model to meet the following specifications:

- (1) Send a brake signal when throttle position is zero and vehicle speed is greater than the reference vehicle speed from the test cycle. Include a delay before changing the brake signal to

$$t_{\text{cycle}_i} = \sum_{i=1}^N \left( \left( \frac{v_{\text{vehicle},i-1}}{v_{\text{cycle},i-1}} \right) \cdot \Delta t_{i-1} \right)$$

Eq. 1037.550-6

Where:

$v_{\text{vehicle}}$  = measured vehicle speed.

$v_{\text{cycle}}$  = reference speed from the test cycle. If  $v_{\text{cycle},i-1} < 1.0$  m/s, set  $v_{\text{cycle},i-1} = v_{\text{vehicle},i-1}$ .

(h) Configure the vehicle model in the test cell to test the powertrain using at least three equally spaced axle ratios or tire sizes and three different road loads (nine configurations), or at least four equally spaced axle ratios or tire sizes and two different road loads (eight configurations) to cover the range of intended vehicle applications. Select axle ratios to represent the full range of expected vehicle installations.

Determine the vehicle model inputs for vehicle mass,  $C_{dA}$ , and  $C_{tr}$  for a set of vehicle configurations as described in 40 CFR 1036.540(c)(3). You may instead test to simulate eight or nine vehicle configurations from different vehicle categories if you limit your powertrains to a certain range of vehicles. For example, if your powertrain will be installed only in vocational Medium HDV and vocational Heavy HDV, you may perform testing to represent eight or nine vehicle configurations using vehicle masses for Medium HDV and Heavy HDV, the predefined  $C_{dA}$  for those vehicles, and the lowest and highest  $C_{tr}$  of the tires that will be installed on those vehicles. Also, instead of selecting specific axle ratios and tire size as described in this paragraph (h), you may select equally spaced axle ratios and tire sizes that cover the range of minimum and maximum engine speed over vehicle speed when the transmission is in top

gear for the vehicles the powertrain will be installed in.

- (i) Operate the powertrain over each of the duty cycles specified in § 1037.510(a)(2), and for each applicable test configuration identified in 40 CFR 1036.540(c). For each duty cycle, precondition the powertrain using the Test 1 vehicle configuration and test the different configurations in numerical order starting with Test 1. If an infrequent regeneration event occurs during testing, void the test, but continue operating the vehicle to allow the regeneration event to finish, then precondition the engine to the same condition as would apply for normal testing and restart testing at the start of the same duty cycle for that test configuration. For PHEV powertrains, precondition the battery and then complete all back to back tests for each test configuration according to 40 CFR 1066.501 before moving to the next test configuration. You may send signals to the engine controller during the test, such as cycle road grade and vehicle speed, if that allows powertrain operation during the test to better represent real-world operation.

- (j) Collect and measure emissions as described in 40 CFR part 1065. For hybrid powertrains with no plug-in capability, correct for the net energy change of the energy storage device as described in 40 CFR 1066.501. For PHEV powertrains, follow 40 CFR 1066.501 to determine End-of-Test for charge-depleting operation. You must get our approval in advance for your

prevent dithering, consistent with good engineering judgment.

- (2) Allow braking only if throttle position is zero.

- (3) Compensate for the distance driven over the duty cycle over the course of the test. Use the following equation to perform the compensation in real time to determine your time in the cycle:

utility factor curve; we will approve it if you can show that you created it from sufficient in-use data of vehicles in the same application as the vehicles in which the PHEV powertrain will be installed.

- (k) For each test point, validate the measured output speed with the corresponding reference values. If the range of reference speed is less than 10 percent of the mean reference speed, you need to meet only the standard error of estimate in Table 1 of this section. You may delete points when the vehicle is stopped. Apply cycle-validation criteria for each separate transient or highway cruise cycle based on the following parameters:

TABLE 1 OF § 1037.550—STATISTICAL CRITERIA FOR VALIDATING DUTY CYCLES

Parameter <sup>1</sup>	Speed control
Slope, $a_1$ .....	$0.990 \leq a_1 \leq 1.010$ .
Absolute value of intercept, $\sqrt{a_0}$ .	$\leq 2.0\%$ of maximum test speed.
Standard error of estimate, $SEE$ .	$\leq 2.0\%$ of maximum test speed.
Coefficient of determination, $r^2$ .	$\geq 0.990$ .

<sup>1</sup> Determine values for specified parameters as described in 40 CFR 1065.514(e) by comparing measured and reference values for  $f_{\text{nref,dyno}}$ .

- (l) [Reserved]

- (m) Calculate mass of fuel consumed for all duty cycles except idle as described in 40 CFR 1036.540(d)(4).





(p) Correct the measured or calculated fuel mass,  $m_{\text{fuel}}$ , and idle fuel mass flow rate,  $\bar{m}_{\text{fuel, idle}}$  if applicable, for each test result to a mass-specific net energy content of a reference fuel as described in § 1036.535(b)(11), replacing  $\bar{m}_{\text{fuel}}$  with  $m_{\text{fuel}}$  where applicable in Eq. 1036.535–3.

(q) For each test run, record the engine speed and torque as defined in 40 CFR 1065.915(d)(5) with a minimum sampling frequency of 1 Hz. These engine speed and torque values represent a duty cycle that can be used for separate testing with an engine mounted on an engine dynamometer, such as for a selective enforcement audit as described in § 1037.301.

#### § 1037.551 Engine-based simulation of powertrain testing.

Section 1037.550 describes how to measure fuel consumption over specific duty cycles with an engine coupled to a transmission; § 1037.550(q) describes how to create equivalent duty cycles for repeating those same measurements with just the engine. This § 1037.551 describes how to perform this engine testing to simulate the powertrain test. These engine-based measurements may be used for confirmatory testing as described in § 1037.235, or for selective enforcement audits as described in § 1037.301, as long as the test engine's operation represents the engine operation observed in the powertrain test. If we use this approach for confirmatory testing, when making compliance determinations, we will consider the uncertainty associated with this approach relative to full powertrain testing. Use of this approach for engine SEAs is optional for engine manufacturers.

(a) Use the procedures of 40 CFR part 1065 to set up the engine, measure emissions, and record data. Measure

individual parameters and emission constituents as described in this section. Measure NO<sub>x</sub> emissions for each sampling period in grams. You may perform these measurements using a NO<sub>x</sub> emission-measurement system that meets the requirements of 40 CFR part 1065, subpart J. Include these measured NO<sub>x</sub> values any time you report to us your greenhouse gas emissions or fuel consumption values from testing under this section. If a system malfunction prevents you from measuring NO<sub>x</sub> emissions during a test under this section but the test otherwise gives valid results, you may consider this a valid test and omit the NO<sub>x</sub> emission measurements; however, we may require you to repeat the test if we determine that you inappropriately voided the test with respect to NO<sub>x</sub> emission measurement. For hybrid powertrains, correct for the net energy change of the energy storage device as described in 40 CFR 1066.501.

(b) Operate the engine over the applicable engine duty cycles corresponding to the vehicle cycles specified in § 1037.510(a)(2) for powertrain testing over the applicable vehicle simulations described in § 1037.550(h). Warm up the engine to prepare for the transient test or one of the highway cruise cycles by operating it one time over one of the simulations of the corresponding duty cycle. Warm up the engine to prepare for the idle test by operating it over a simulation of the 65-mi/hr highway cruise cycle for 600 seconds. Within 60 seconds after concluding the warm up cycle, start emission sampling while the engine operates over the duty cycle. You may perform any number of test runs directly in succession once the engine is warmed up. Perform cycle validation as described in 40 CFR 1065.514 for engine speed, torque, and power.

(c) Calculate the mass of fuel consumed as described in § 1037.550(m) and (n). Correct each measured value for the test fuel's mass-specific net energy content as described in 40 CFR 1036.530. Use these corrected values to determine whether the engine's emission levels conform to the declared fuel-consumption rates from the powertrain test.

#### § 1037.555 Special procedures for testing Phase 1 hybrid systems.

This section describes the procedure for simulating a chassis test with a pre-transmission or post-transmission hybrid system for A to B testing of Phase 1 vehicles. These procedures may also be used to perform A to B testing with non-hybrid systems. See § 1037.550 for Phase 2 hybrid systems.

(a) Set up the engine according to 40 CFR 1065.110 to account for work inputs and outputs and accessory work.

(b) Collect CO<sub>2</sub> emissions while operating the system over the test cycles specified in § 1037.510(a)(1).

(c) Collect and measure emissions as described in 40 CFR part 1066. Calculate emission rates in grams per ton-mile without rounding. Determine values for *A*, *B*, *C*, and *M* for the vehicle being simulated as specified in 40 CFR part 1066. If you will apply an improvement factor or test results to multiple vehicle configurations, use values of *A*, *B*, *C*, *M*, *k<sub>a</sub>*, and *r* that represent the vehicle configuration with the smallest potential reduction in greenhouse gas emissions as a result of the hybrid capability.

(d) Calculate the transmission output shaft's angular speed target for the driver model,  $f_{\text{ref, driver}}$ , from the linear speed associated with the vehicle cycle using the following equation:

$$f_{\text{ref, driver}} = \frac{v_{\text{cycle}, i} \cdot k_a}{2 \cdot \pi \cdot r}$$

Eq. 1037.555-1

Where:

$v_{\text{cycle}, i}$  = vehicle speed of the test cycle for each point, *i*, starting from *i* = 1.

$k_a$  = drive axle ratio, as declared by the manufacturer.

*r* = radius of the loaded tires, as declared by the manufacturer.

(e) Use speed control with a loop rate of at least 100 Hz to program the dynamometer to follow the test cycle, as follows:

(1) Calculate the transmission output shaft's angular speed target for the dynamometer,  $f_{\text{ref, dyno}}$ , from the measured linear speed at the dynamometer rolls using the following equation:

$$f_{nref_i,dyno} = \frac{v_{ref_i} \cdot k_a}{2 \cdot \pi \cdot r}$$

Eq. 1037.555-2

Where:

$$v_{ref_i} = \left( \frac{k_a \cdot T_{i-1}}{r} - \left( A + B \cdot v_{ref_{i-1}} + C \cdot v_{ref_{i-1}}^2 \right) - F_{brake_{i-1}} \right) \cdot \frac{t_i - t_{i-1}}{M} + v_{ref_{i-1}}$$

Eq. 1037.555-3

$T$  = instantaneous measured torque at the transmission output shaft.

$F_{brake}$  = instantaneous brake force applied by the driver model to add force to slow down the vehicle.

$t$  = elapsed time in the driving schedule as measured by the dynamometer, in seconds.

(2) For each test, validate the measured transmission output shaft's speed with the corresponding reference values according to 40 CFR 1065.514(e). You may delete points when the vehicle is stopped. Perform the validation based on speed values at the transmission output shaft. For steady-state tests (55 mi/hr and 65 mi/hr cruise), apply cycle-validation criteria by treating the sampling periods from the two tests as a continuous sampling period. Perform this validation based on the following parameters:

TABLE 1 OF § 1037.555—STATISTICAL CRITERIA FOR VALIDATING DUTY CYCLES

Parameter	Speed control
Slope, $a_1$ .....	$0.950 \leq a_1 \leq 1.030$ .
Absolute value of intercept, $ a_0 $ .	$\leq 2.0\%$ of maximum test speed.
Standard error of estimate, <i>SEE</i> .	$\leq 5\%$ of maximum test speed.
Coefficient of determination, $r^2$ .	$\geq 0.970$ .

(f) Send a brake signal when throttle position is equal to zero and vehicle speed is greater than the reference vehicle speed from the test cycle. Set a delay before changing the brake state to prevent the brake signal from dithering, consistent with good engineering judgment.

(g) The driver model should be designed to follow the cycle as closely as possible and must meet the requirements of § 1037.510 for steady-state testing and 40 CFR 1066.430(e) for transient testing. The driver model

should be designed so that the brake and throttle are not applied at the same time.

(h) Correct for the net energy change of the energy storage device as described in 40 CFR 1066.501.

(i) Follow the provisions of § 1037.510 to weight the cycle results and § 1037.615 to calculate improvement factors and benefits for advanced technologies for Phase 1 vehicles.

**§ 1037.560 Axle efficiency test.**

This section describes a procedure for mapping axle efficiency through a determination of axle power loss.

(a) You may establish axle power loss maps based on testing any number of axle configurations within an axle family as specified in § 1037.232. You may share data across a family of axle configurations, as long as you test the axle configuration with the lowest efficiency from the axle family; this will generally involve testing the axle with the highest axle ratio. For vehicles with tandem drive axles, always test each drive axle separately. For tandem axles that can be disconnected, test both single-drive and tandem axle configurations. Alternatively, you may ask us to approve power loss maps for untested configurations that are analytically derived from tested configurations within the same family (see § 1037.235(h)).

(b) Prepare an axle assembly for testing as follows:

(1) Select an axle assembly with less than 500 hours of operation before testing. Assemble the axle in its housing, along with wheel ends and bearings.

(2) If you have a family of axle assemblies with different axle ratios, you may test multiple configurations using a common axle housing, wheel ends, and bearings.

(3) Install the axle on the dynamometer with an input shaft angle perpendicular to the axle.

(i) For axle assemblies with or without a locking main differential, test the axle using one of the following methods:

(A) Lock the main differential and test it with one electric motor on the input shaft and a second electric motor on the output side of the output shaft that has the speed-reduction gear attached to it.

(B) Test with the main differential unlocked and with one electric motor on the input shaft and electric motors on the output sides of each of the output shafts.

(ii) For drive-through tandem-axle setups, lock the longitudinal and inter-wheel differentials.

(4) Add gear oil according to the axle manufacturer's instructions. If the axle manufacturer specifies multiple gear oils, select the one with the highest viscosity at operating temperature. You may use a lower-viscosity gear oil if we approve that as critical emission-related maintenance under § 1037.125. Fill the gear oil to a level that represents in-use operation. You may use an external gear oil conditioning system, as long as it does not affect measured values.

(5) Install equipment for measuring the bulk temperature of the gear oil in the oil sump or a similar location.

(6) Break in the axle assembly using good engineering judgment. Maintain gear oil temperature at or below 100 °C throughout the break-in period.

(7) Drain the gear oil following the break-in procedure and repeat the filling procedure described in paragraph (b)(3) of this section.

(c) Measure input and output speed and torque as described in 40 CFR 1065.210(b), except that you may use a magnetic or optical shaft-position detector with only one count per revolution. Use a speed-measurement system that meets an accuracy of

±0.05% of point. Use torque transducers that meet an accuracy requirement of ±0.2% of the maximum axle input torque or output torque tested for loaded test points, and ±1.0 N·m for unloaded test points. Calibrate and verify measurement instruments according to 40 CFR part 1065, subpart C. Command speed and torque at a minimum of 10 Hz, and record all data, including bulk oil temperature, as 1 Hz mean values.

(d) The test matrix consists of output torque and wheel speed values meeting the following specifications:

(1) Output torque includes both loaded and unloaded operation. For measurement involving unloaded output torque, also called spin loss testing, the wheel end is not connected to the dynamometer and is left to rotate freely; in this condition the input torque (to maintain constant wheel speed) equals the power loss. Test axles at a range of output torque values, as follows:

(i) 0, 500, 1000, 2000, 3000, and 4000 N·m for single drive axle applications for tractors and for vocational Heavy HDV with a single drive axle.

(ii) 0, 250, 500, 1000, 1500, and 2000 N·m for tractors, for vocational Heavy HDV with tandem drive axles, and for all vocational Light HDV or vocational Medium HDV.

(iii) You may exclude values that exceed your axle's maximum torque rating.

(2) Determine maximum wheel speed corresponding to a vehicle speed of 65 mi/hr based on the smallest tire (as determined using § 1037.520(c)(1)) that will be used with the axle. If you do not know the smallest tire size, you may use a default size of 650 r/mi. Use wheel rotational speeds for testing that include 50 r/min and speeds in 100 r/min increments that encompass the maximum wheel speed (150, 250, etc.).

(3) You may test the axle at additional speed and torque setpoints.

(e) Determine axle efficiency using the following procedure:

(1) Maintain ambient temperature between (15 and 35) °C throughout testing. Measure ambient temperature within 1.0 m of the axle assembly. Verify that critical axle settings (such as bearing preload, backlash, and oil sump level) are within specifications before and after testing.

(2) Maintain gear oil temperature at (81 to 83) °C. Measure gear oil temperature at the drain of the sump. You may use an external gear oil conditioning system, as long as it does not affect measured values.

(3) Use good engineering judgment to warm up the axle by operating it until the gear oil is within the specified temperature range.

(4) Stabilize operation at each point in the test matrix for at least 10 seconds, then measure the input torque, output torque, and wheel speed for at least 10 seconds, recording the mean values for all three parameters. Calculate power loss as described in paragraph (f) of this section based on torque and speed values at each test point.

(5) Perform the map sequence described in paragraph (e)(4) of this section three times. Remove torque from the input shaft and allow the axle to come to a full stop before each repeat measurement.

(6) You may need to perform additional testing based on a calculation of repeatability at a 95% confidence level. Make a separate repeatability calculation for the three data points at each operating condition in the test matrix. If the confidence limit is greater than 0.10% for loaded tests or greater than 0.05% for unloaded tests, perform another repeat of the axle power loss map and recalculate the repeatability for the whole set of test results. Continue testing until the repeatability is at or below the specified values for all operating conditions.

Calculate a confidence limit representing the repeatability in establishing a 95% confidence level using the following equation:

$$\text{Confidence Limit} = \frac{1.96 \cdot \sigma_{\text{Ploss}}}{\sqrt{N} \cdot P_{\text{max}}} \cdot 100$$

Eq. 1037.560-1

Where:

$\sigma_{\text{Ploss}}$  = standard deviation of power loss values at a given torque-speed setting (see 40 CFR 1065.602(c)).

$N$  = number of repeat tests.

$P_{\text{max}}$  = maximum output torque setting from the test matrix.

Example:

$\sigma_{\text{Ploss}} = 165.0 \text{ W}$

$N = 3$

$P_{\text{max}} = 314200 \text{ W}$

$$\text{Confidence Limit} = \frac{1.96 \cdot 165.0}{\sqrt{3} \cdot 314200} \cdot 100$$

(7) Calculate mean input torque,  $\bar{T}_{\text{in}}$ , mean output torque,  $\bar{T}_{\text{out}}$ , and mean wheel rotational speed,  $\bar{f}_{\text{wheel}}$ , for each

point in the test matrix using the results from all the repeat tests.

(f) Calculate the mean power loss,  $\bar{P}_{\text{loss}}$ , at each operating condition in the test matrix as follows:

(1)  $\bar{\bar{P}}_{\text{loss}}$  is the mean power loss, of all the tests, at each operating condition.

(2) For each test calculate the mean power loss,  $\bar{P}_{\text{loss}}$ , as follows:

$$\bar{P}_{\text{loss}} = \bar{T}_{\text{in}} \cdot \bar{f}_{\text{wheel}} \cdot k_a - \bar{T}_{\text{out}} \cdot \bar{f}_{\text{wheel}}$$

Eq. 1037.560-2

Where:

 $\bar{T}_{\text{in}}$  = mean input torque. $\bar{f}_{\text{wheel}}$  = mean wheel rotational speed. $k_a$  = drive axle ratio, expressed to at least the nearest 0.001. $\bar{T}_{\text{out}}$  = mean output torque. Let  $\bar{T}_{\text{out}} = 0$  for all unloaded tests.*Example:* $\bar{T}_{\text{in}} = 845.1 \text{ N}\cdot\text{m}$ ,  $\bar{f}_{\text{wheel}} = 100 \text{ r/min} = 10.472 \text{ rad/s}$  $k_a = 3.731$  $\bar{T}_{\text{out}} = 3000 \text{ N}\cdot\text{m}$  $\bar{P}_{\text{loss}} = 845.1 \cdot 10.472 \cdot 3.731 - 3000 \cdot 10.472$  $\bar{P}_{\text{loss}} = 1602.9 \text{ W} = 1.6029 \text{ kW}$  $\bar{P}_{\text{loss},2} = 1601.9 \text{ W} = 1.6019 \text{ kW}$  $\bar{P}_{\text{loss},3} = 1603.9 \text{ W} = 1.6039 \text{ kW}$ 

$$\bar{\bar{P}}_{\text{loss}} = \frac{1.6029 + 1.6019 + 1.6039}{3} = 1.6029 \text{ kW}$$

(g) Create a table showing the mean power loss,

$$\bar{\bar{P}}_{\text{loss}},$$

corresponding to each mean output torque and mean wheel speed for input into GEM. Express wheel speed in r/min to one decimal place; express output torque in N·m to two decimal places; express power loss in kW to four decimal places. Select mean power loss values at or above the corresponding value calculated in paragraph (f) of this section. Use good engineering judgment to select values that will be at or above the mean power loss values for your production axles. For vehicles with tandem drive axles, sum the power losses and output torques of the individual axles when creating your table. For tandem axles with a disconnect, input a separate table into GEM for the single and tandem drive axle configurations. Vehicle manufacturers will use these declared mean power loss values for certification.

#### § 1037.565 Transmission efficiency test.

This section describes a procedure for mapping transmission efficiency through a determination of transmission power loss.

(a) You may establish transmission power loss maps based on testing any number of transmission configurations within a transmission family as specified in § 1037.232. You may share data across any configurations within the family, as long as you test the transmission configuration with the lowest efficiency from the emission family. Alternatively, you may ask us to approve power loss maps for untested configurations that are analytically derived from tested configurations within the same family (see § 1037.235(h)).

(b) Prepare a transmission for testing as follows:

(1) Select a transmission with less than 500 hours of operation before testing.

(2) Mount the transmission to the dynamometer such that the geared shaft in the transmission is aligned with the input shaft from the dynamometer.

(3) Add transmission oil according to the transmission manufacturer's instructions. If the transmission manufacturer specifies multiple transmission oils, select the one with the highest viscosity at operating temperature. You may use a lower-viscosity transmission oil if we approve that as critical emission-related maintenance under § 1037.125. Fill the transmission oil to a level that represents in-use operation. You may use an external transmission oil conditioning system, as long as it does not affect measured values.

(4) Include any internal and external pumps for hydraulic fluid and lubricating oil in the test. Determine the work required to drive an external pump according to 40 CFR 1065.210.

(5) Install equipment for measuring the bulk temperature of the transmission oil in the oil sump or a similar location.

(6) If the transmission is equipped with a torque converter, lock it for all testing performed in this section.

(7) Break in the transmission using good engineering judgment. Maintain transmission oil temperature at (87 to 93) °C for automatic transmissions and transmissions having more than two friction clutches, and at (77 to 83) °C for all other transmissions. You may ask us to approve a different range of transmission oil temperatures if you have data showing that it better represents in-use operation.

(c) Measure input and output shaft speed and torque as described in 40 CFR 1065.210(b), except that you may use a magnetic or optical shaft-position detector with only one count per revolution. Use a speed measurement system that meets an accuracy of

±0.05% of point. Use torque transducers that meet an accuracy requirement of ±0.2% of the transmission's maximum rated input torque or output torque for the selected gear ratio, for loaded test points, and ±0.1% of the transmission's maximum rated input torque for unloaded test points. Calibrate and verify measurement instruments according to 40 CFR part 1065, subpart C. Command speed and torque at a minimum of 10 Hz, and record all data, including bulk oil temperature, at a minimum of 1 Hz mean values.

(d) The test matrix consists of transmission input shaft speeds and torque setpoints meeting the following specifications for each gear tested:

(1) Include transmission input shaft speeds at the maximum rated input shaft speed, 600 r/min, and three equally spaced intermediate speeds. The intermediate speed points may be adjusted to the nearest 50 or 100 r/min.

(2) Include one loaded torque setpoint between 75% and 105% of the maximum transmission input torque and one unloaded (zero-torque) setpoint. You may test at any number of additional torque setpoints to improve accuracy. Note that GEM calculates power loss between tested or default values by linear interpolation.

(3) In the case of transmissions that automatically go into neutral when the vehicle is stopped, also perform tests at 600 r/min and 800 r/min with the transmission in neutral and the transmission output fixed at zero speed.

(e) Determine transmission torque loss using the following procedure:

(1) Maintain ambient temperature between (15 and 35) °C throughout testing. Measure ambient temperature within 1.0 m of the transmission.

(2) Maintain transmission oil temperature as described in paragraph (b)(7) of this section. You may use an external transmission oil conditioning system, as long as it does not affect measured values.

(3) Use good engineering judgment to warm up the transmission according to the transmission manufacturer's specifications.

(4) Perform unloaded transmission tests by disconnecting the transmission output shaft from the dynamometer and letting it rotate freely. If the transmission adjusts pump pressure based on whether the vehicle is moving or stopped, set up the transmission for unloaded tests to operate as if the vehicle is moving.

(5) For transmissions that have multiple configurations for a given gear ratio, such as dual-clutch transmissions that can pre-select an upshift or downshift, set the transmission to operate in the configuration with the greatest power loss. Alternatively, test in each configuration and use good engineering judgment to calculate a weighted power loss for each test point under this section based on field data that characterizes the degree of in-use operation in each configuration.

(6) Operate the transmission in the top gear at a selected torque setpoint with the input shaft speed at one of the speed setpoints for at least 10 seconds, then measure the speed and torque of the input and output shafts for at least 10 seconds. You may omit measurement of output shaft speeds if your transmission is configured in a way that does not allow slip. Calculate arithmetic mean values for all speed and torque values over each measurement period. Repeat this stabilization, measurement, and calculation for the other speed and torque setpoints from the test matrix in any sequence. Calculate power loss as described in paragraph (f) of this section based on torque and speed values at each test point.

(7) Repeat the procedure described in paragraph (e) for all gears, or for all gears down to a selected gear. GEM will use default values for any gears not tested.

(8) Perform the test sequence described in paragraphs (d)(6) and (7) of

this section three times. You may do this repeat testing at any given test point before you perform measurements for the whole test matrix. Remove torque from the transmission input shaft and bring the transmission to a complete stop before each repeat measurement.

(9) You may need to perform additional testing based on a calculation of repeatability at a 95% confidence level. Make a separate repeatability calculation for the three data points at each operating condition in the test matrix. If the confidence limit is greater than 0.10% for loaded tests or greater than 0.05% for unloaded tests, perform another repeat of measurements at that operating condition and recalculate the repeatability for the whole set of test results. Continue testing until the repeatability is at or below the specified values for all operating conditions. Calculate a confidence limit representing the repeatability in establishing a 95% confidence level using the following equation:

$$Confidence\ Limit = \frac{1.96 \cdot \sigma_{P_{loss}}}{\sqrt{N} \cdot P_{rated}} \cdot 100$$

Eq. 1037.565-1

Where:

$\sigma_{P_{loss}}$  = standard deviation of power loss values at a given test point (see 40 CFR 1065.602(c)).

$N$  = number of repeat tests.

$P_{rated}$  = the transmission's rated input power for a given gear. For testing in neutral, use the value of  $P_{rated}$  for the top gear.

Example:

$\sigma_{P_{loss}} = 120.0\ W$   
 $N = 3$   
 $P_{rated} = 314200\ W$

$$Confidence\ Limit = \frac{1.96 \cdot 120.0}{\sqrt{3} \cdot 314200} \cdot 100$$

Confidence Limit = 0.0432%

(10) Calculate mean input shaft torque,  $\bar{T}_{in}$ , mean output shaft torque,

$\bar{T}_{out}$ , mean input shaft speed,  $\bar{f}_{nin}$ , and mean output shaft speed,  $\bar{f}_{nout}$ , for each point in the test matrix using the results from all the repeat tests.

(f) Calculate the mean power loss,  $\bar{P}_{loss}$ , at each operating condition in the test matrix as follows:

(1)  $\bar{P}_{loss}$  is the mean power loss, of all the tests, at each operating condition.

(2) For each test calculate the mean power loss,  $\bar{P}_{loss}$ , as follows:

$$\bar{P}_{loss} = \bar{T}_{in} \cdot \bar{f}_{nin} - \bar{T}_{out} \cdot \bar{f}_{nout}$$

Eq. 1037.565-2

Where:

$\bar{T}_{in}$  = mean input shaft torque.  
 $\bar{f}_{nin}$  = mean input shaft speed.

$\bar{T}_{out}$  = mean output shaft torque. Let  $\bar{T}_{out} = 0$  for all unloaded tests.

$\bar{f}_{nout}$  = mean output shaft speed. Let  $\bar{f}_{nout} = 0$  for all tests with the transmission in neutral. See paragraph (f)(3) of this

section for calculating for certain transmission configurations.  
*Example:*

$$\begin{aligned} \bar{T}_{in} &= 1000.0 \text{ N}\cdot\text{m} \\ \bar{f}_{nin} &= 1000 \text{ r/min} = 104.72 \text{ rad/sec} \\ \bar{T}_{out} &= 2654.5 \text{ N}\cdot\text{m} \\ \bar{f}_{nout} &= 361.27 \text{ r/min} = 37.832 \text{ rad/s} \end{aligned}$$

$$\begin{aligned} \bar{P}_{loss,1} &= 1000.0 \cdot 104.72 - 2654.5 \cdot 37.832 \\ \bar{P}_{loss} &= 4295 \text{ W} = 4.295 \text{ kW} \\ \bar{P}_{loss,2} &= 4285 \text{ W} = 4.285 \text{ kW} \\ \bar{P}_{loss,3} &= 4292 \text{ W} = 4.292 \text{ kW} \end{aligned}$$

$$\bar{P}_{loss} = \frac{4.295 + 4.285 + 4.292}{3} = 4.291 \text{ kW}$$

(3) For transmissions that are configured in a way that does not allow

slip, you may calculate  $\bar{f}_{nout}$  based on the gear ratio using the following equation:

$$\bar{f}_{nout} = \frac{\bar{f}_{nin}}{k_g}$$

Eq. 1037.565-3

Where:

$k_g$  = transmission gear ratio, expressed to at least the nearest 0.001.

(g) Create a table showing the mean power loss,

$$\bar{P}_{loss},$$

corresponding to each mean transmission input speed and mean input torque for input into GEM. Also include mean power loss in neutral for each tested engines speed, if applicable. Express transmission input speed in r/min to one decimal place; express input torque in N•m to two decimal places; express power loss in kW to four decimal places. Select mean power loss values at or above the corresponding value calculated in paragraph (f) of this section. Use good engineering judgment to select values that will be at or above the mean power loss values for your production axles. Vehicle manufacturers will use these declared mean power loss values for certification.

**Subpart G—Special Compliance Provisions**

**§ 1037.601 General compliance provisions.**

(a) Engine and vehicle manufacturers, as well as owners and operators of vehicles subject to the requirements of this part, and all other persons, must observe the provisions of this part, the applicable provisions of 40 CFR part 1068, and the applicable provisions of the Clean Air Act. The provisions of 40 CFR part 1068 apply for heavy-duty vehicles as specified in that part, subject to the provisions:

(1) Except as specifically allowed by this part or 40 CFR part 1068, it is a violation of § 1068.101(a)(1) to introduce into U.S. commerce a tractor or vocational vehicle containing an

engine not certified to the applicable requirements of this part and 40 CFR part 86. Further, it is a violation to introduce into U.S. commerce a Phase 1 tractor containing an engine not certified for use in tractors; or to introduce into U.S. commerce a vocational vehicle containing a light heavy-duty or medium heavy-duty engine not certified for use in vocational vehicles. These prohibitions apply especially to the vehicle manufacturer. Note that this paragraph (a)(1) allows the use of Heavy heavy-duty tractor engines in vocational vehicles.

(2) The provisions of 40 CFR 1068.105(a) apply for vehicle manufacturers installing engines certified under 40 CFR part 1036 as further limited by this paragraph (a)(2). If new engine emission standards apply in a given model year, you may install normal inventories of engines from the preceding model year under the provisions of 40 CFR 1068.105(a) through March 31 of that year without our approval; you may not install such engines after March 31 of that year unless we approve it in advance. Installing such engines after March 31 without our prior approval is considered to be prohibited stockpiling of engines. In a written request for our approval, you must describe how your circumstances led you and your engine supplier to have normal inventories of engines that were not used up in the specified time frame. We will approve your request for up to three additional months to install up to 50 engines under this paragraph (a)(2) if we determine that the excess inventory is a result of unforeseeable circumstances and should not be considered circumvention of emission standards. Note that 40 CFR 1068.105(a) allows vehicle manufacturers to use up only normal

inventories of engines meeting less stringent standards; if, for example, a vehicle manufacturer's normal practice is to receive a shipment of engines every two weeks, it will deplete its potential to install previous-tier engines under this paragraph (a)(2) well before March 31 in the year that new standards apply.

(3) The exemption provisions of 40 CFR 1068.201 through 1068.230, 1068.240, and 1068.260 through 265 apply for heavy-duty motor vehicles. Other exemption provisions, which are specific to nonroad engines, do not apply for heavy-duty vehicles or heavy-duty engines.

(4) The tampering prohibition in 40 CFR 1068.101(b)(1) applies for alternative fuel conversions as specified in 40 CFR part 85, subpart F.

(5) The warranty-related prohibitions in section 203(a)(4) of the Act (42 U.S.C. 7522(a)(4)) apply to manufacturers of new heavy-duty highway vehicles in addition to the prohibitions described in 40 CFR 1068.101(b)(6). We may assess a civil penalty up to \$44,539 for each engine or vehicle in violation.

(6) A vehicle manufacturer that completes assembly of a vehicle at two or more facilities may ask to use as the date of manufacture for that vehicle the date on which manufacturing is completed at the place of main assembly, consistent with provisions of 49 CFR 567.4. Note that such staged assembly is subject to the corresponding provisions of 40 CFR 1068.260. Include your request in your application for certification, along with a summary of your staged-assembly process. You may ask to apply this allowance to some or all of the vehicles in your vehicle family. Our approval is effective when we grant your certificate. We will not approve your request if we determine

that you intend to use this allowance to circumvent the intent of this part.

(7) The provisions for selective enforcement audits apply as described in 40 CFR part 1068, subpart E, and subpart D of this part.

(b) Vehicles exempted from the applicable standards of 40 CFR part 86 other than glider vehicles are exempt from the standards of this part without request. Similarly, vehicles other than glider vehicles are exempt without request if the installed engine is exempted from the applicable standards in 40 CFR part 86.

(c) The prohibitions of 40 CFR 1068.101 apply for vehicles subject to the requirements of this part. The actions prohibited under this provision include the introduction into U.S. commerce of a complete or incomplete vehicle subject to the standards of this part where the vehicle is not covered by a valid certificate of conformity or exemption.

(d) The emergency vehicle field modification provisions of 40 CFR 85.1716 apply with respect to the standards of this part.

(e) Under § 1037.801, certain vehicles are considered to be new vehicles when they are imported into the United States, even if they have previously been used outside the country. Independent Commercial Importers may use the provisions of 40 CFR part 85, subpart P, and 40 CFR 85.1706(b) to receive a certificate of conformity for engines and vehicles meeting all the requirements of 40 CFR part 1036 and this part 1037.

(f) Standards apply to multi-fuel vehicles as described for engines in 40 CFR 1036.601(d).

**§ 1037.605 Installing engines certified to alternate standards for specialty vehicles.**

(a) *General provisions.* This section allows vehicle manufacturers to introduce into U.S. commerce certain new motor vehicles using engines certified to alternate emission standards specified in 40 CFR part 86 for motor vehicle engines used in specialty vehicles. You may not install an engine certified to these alternate standards if there is an engine certified to the full set of requirements of 40 CFR part 86 that has the appropriate physical and performance characteristics to power the vehicle. Note that, although these alternate emission standards are mostly equivalent to standards that apply for nonroad engines under 40 CFR part 1039 or 1048, they are specific to motor vehicle engines. The alternate standards for compression-ignition engines at or above 56 kW are described in 40 CFR 86.007–11(g); the alternate standards for

spark-ignition engines are described in 40 CFR 86.008–10(g). The provisions of this section apply for the following types of specialty vehicles:

(1) All-terrain motor vehicles with portal axles (*i.e.*, axles that are offset from the corresponding wheel centerline by a gear assembly) or any axle configuration involving gear reduction such that the wheels rotate more slowly than the axle.

(2) Amphibious vehicles.

(3) Vehicles with maximum speed at or below 45 miles per hour. If your vehicle is speed-limited to meet this specification by reducing maximum speed below what is otherwise possible, this speed limitation must be programmed into the engine or vehicle's electronic control module in a way that is tamper-proof. If your vehicles are not inherently limited to a maximum speed at or below 45 miles per hour, they may qualify under this paragraph (a)(3) only if we approve your design to limit maximum speed as being tamper-proof in advance.

(4) Through model year 2027, vehicles with a hybrid powertrain in which the engine provides energy for the Rechargeable Energy Storage System.

(b) *Notification and reporting requirements.* Send the Designated Compliance Officer written notification describing your plans before using the provisions of this section. In addition, by February 28 of each calendar year (or less often if we tell you), send the Designated Compliance Officer a report with all the following information:

(1) Identify your full corporate name, address, and telephone number.

(2) List the vehicle models for which you used this exemption in the previous year and identify the engine manufacturer and engine model for each vehicle model. Also identify the total number of vehicles produced in the previous year.

(c) *Production limits.* You may produce up to 1,000 hybrid vehicles in a given model year through model year 2027, and up to 200 of each type of vehicle identified in paragraph (a)(1) through (3) of this section in a given model year. This includes vehicles produced by affiliated companies. If you exceed this limit, the number of vehicles that exceed the limit for the model year will not be covered by a valid certificate of conformity. For the purpose of this paragraph (c), we will count all vehicles labeled or otherwise identified as exempt under this section.

(d) *Vehicle standards.* The vehicle standards of this part apply as follows for these vehicles:

(1) Vehicles qualifying under paragraphs (a)(1) through (3) of this

section are subject to evaporative emission standards of § 1037.103, but are exempt from the other requirements of this part, except as specified in this section and in § 1037.601. These vehicles must include a label as specified in § 1037.135(a) with the information from § 1037.135(c)(1) and (2) and the following statement: “THIS VEHICLE IS EXEMPT FROM GREENHOUSE GAS STANDARDS UNDER 40 CFR 1037.605.”

(2) Hybrid vehicles using the provisions of this section remain subject to the vehicle standards and all other requirements of this part 1037. For example, you may need to use GEM in conjunction with powertrain testing to demonstrate compliance with emission standards under subpart B of this part.

**§ 1037.610 Vehicles with off-cycle technologies.**

(a) You may ask us to apply the provisions of this section for CO<sub>2</sub> emission reductions resulting from vehicle technologies that were not in common use with heavy-duty vehicles before model year 2010 that are not reflected in GEM. While you are not required to prove that such technologies were not in common use with heavy-duty vehicles before model year 2010, we will not approve your request if we determine that they do not qualify. These may be described as off-cycle or innovative technologies. You may apply these provisions for CO<sub>2</sub> emission reductions reflected in the specified test procedures if they are not reflected in GEM, except as allowed under paragraph (g) of this section. We will apply these provisions only for technologies that will result in measurable, demonstrable, and verifiable real-world CO<sub>2</sub> emission reductions.

(b) The provisions of this section may be applied as either an improvement factor or as a separate credit, consistent with good engineering judgment. Note that the term “credit” in this section describes an additive adjustment to emission rates and is not equivalent to an emission credit in the ABT program of subpart H of this part. We recommend that you base your credit/adjustment on A to B testing of pairs of vehicles differing only with respect to the technology in question.

(1) Calculate improvement factors as the ratio of in-use emissions with the technology divided by the in-use emissions without the technology. Use the improvement-factor approach where good engineering judgment indicates that the actual benefit will be proportional to emissions measured



over the test procedures specified in this part.

(2) Calculate separate credits (g/ton-mile) based on the difference between the in-use emission rate with the technology and the in-use emission rate without the technology. Subtract this value from your GEM result and use this adjusted value to determine your FEL. Use the separate-credit approach where good engineering judgment indicates that the actual benefit will not be proportional to emissions measured over the test procedures specified in this part.

(3) We may require you to discount or otherwise adjust your improvement factor or credit to account for uncertainty or other relevant factors.

(c) You may perform A to B testing by measuring emissions from the vehicles during chassis testing or from in-use on-road testing. You may also ask to use modified powertrain testing. If you use on-road testing, we recommend that you test according to SAE J1321, Fuel Consumption Test Procedure—Type II, revised February 2012, or SAE J1526, SAE Fuel Consumption Test Procedure (Engineering Method), Revised September 2015 (see § 1037.810 for information on availability of SAE standards), subject to the following provisions:

(1) The minimum route distance is 100 miles.

(2) The route selected must be representative in terms of grade. We will take into account published and relevant research in determining whether the grade is representative.

(3) Control vehicle speed over the route to be representative of the drive-cycle weighting adopted for each regulatory subcategory, as specified in § 1037.510(c), or apply a correction to account for the appropriate weighting. For example, if the route selected for an evaluation of a combination tractor with a sleeper cab contains only interstate driving at 65 mi/hr, the improvement factor would apply only to 86 percent of the weighted result.

(4) The ambient air temperature must be between (5 and 35) °C, unless the technology requires other temperatures for demonstration.

(5) We may allow you to use a Portable Emissions Measurement System (PEMS) device for measuring CO<sub>2</sub> emissions during the on-road testing.

(d) Send your request to the Designated Compliance Officer. We recommend that you do not begin collecting test data (for submission to EPA) before contacting us. For technologies for which the engine manufacturer could also claim credits

(such as transmissions in certain circumstances), we may require you to include a letter from the engine manufacturer stating that it will not seek credits for the same technology. Your request must contain the following items:

(1) A detailed description of the off-cycle technology and how it functions to reduce CO<sub>2</sub> emissions under conditions not represented on the duty cycles required for certification.

(2) A list of the vehicle configurations that will be equipped with the technology.

(3) A detailed description and justification of the selected test vehicles.

(4) All testing and simulation data required under this section, plus any other data you have considered in your analysis. You may ask for our preliminary approval of your test plan under § 1037.210.

(5) A complete description of the methodology used to estimate the off-cycle benefit of the technology and all supporting data, including vehicle testing and in-use activity data. Also include a statement regarding your recommendation for applying the provisions of this section for the given technology as an improvement factor or a credit.

(6) An estimate of the off-cycle benefit by vehicle model, and the fleetwide benefit based on projected sales of vehicle models equipped with the technology.

(7) A demonstration of the in-use durability of the off-cycle technology, based on any available engineering analysis or durability testing data (either by testing components or whole vehicles).

(8) A recommended method for auditing production vehicles consistent with the intent of 40 CFR part 1068, subpart E. We may approve your recommended method or specify a different method.

(e) We may seek public comment on your request, consistent with the provisions of 40 CFR 86.1866. However, we will generally not seek public comment on credits or adjustments based on A to B chassis testing performed according to the duty-cycle testing requirements of this part or in-use testing performed according to paragraph (c) of this section.

(f) We may approve an improvement factor or credit for any configuration that is properly represented by your testing.

(1) For model years before 2021, you may continue to use an approved improvement factor or credit for any appropriate vehicle families in future model years through 2020.

(2) For model years 2021 and later, you may not rely on an approval for model years before 2021. You must separately request our approval before applying an improvement factor or credit under this section for Phase 2 vehicles, even if we approved an improvement factor or credit for similar vehicle models before model year 2021. Note that Phase 2 approval may carry over for multiple years.

(g) You normally may not calculate off-cycle credits or improvement factors under this section for technologies represented by GEM, but we may allow you to do so by averaging multiple GEM runs for special technologies for which a single GEM run cannot accurately reflect in-use performance. For example, if you use an idle-reduction technology that is effective 80 percent of the time, we may allow you to run GEM with the technology active and with it inactive, and then apply an 80% weighting factor to calculate the off-cycle credit or improvement factor. You may need to perform testing to establish proper weighting factors or otherwise quantify the benefits of the special technologies.

#### § 1037.615 Advanced technologies.

(a) This section applies in Phase 1 for hybrid vehicles with regenerative braking, vehicles equipped with Rankine-cycle engines, electric vehicles, and fuel cell vehicles, and in Phase 2 through model year 2027 for plug-in hybrid electric vehicles, electric vehicles, and fuel cell vehicles. You may not generate credits for Phase 1 engine technologies for which the engines generate credits under 40 CFR part 1036.

(b) Generate Phase 1 advanced-technology credits for vehicles other than electric vehicles as follows:

(1) Measure the effectiveness of the advanced system by chassis-testing a vehicle equipped with the advanced system and an equivalent conventional vehicle, or by testing the hybrid systems and the equivalent non-hybrid systems as described in § 1037.555. Test the vehicles as specified in subpart F of this part. For purposes of this paragraph (b), a conventional vehicle is considered to be equivalent if it has the same footprint (as defined in 40 CFR 86.1803), vehicle service class, aerodynamic drag, and other relevant factors not directly related to the hybrid powertrain. If you use § 1037.540 to quantify the benefits of a hybrid system for PTO operation, the conventional vehicle must have the same number of PTO circuits and have equivalent PTO power. If you do not produce an equivalent vehicle, you may create and test a prototype equivalent vehicle. The conventional vehicle is

considered Vehicle A and the advanced vehicle is considered Vehicle B. We may specify an alternate cycle if your vehicle includes a power take-off.

(2) Calculate an improvement factor and g/ton-mile benefit using the following equations and parameters:

(i) Improvement Factor = [(Emission Rate A) – (Emission Rate B)]/(Emission Rate A).

(ii) g/ton-mile benefit = Improvement Factor × (GEM Result B).

(iii) Emission Rates A and B are the g/ton-mile CO<sub>2</sub> emission rates of the conventional and advanced vehicles, respectively, as measured under the test procedures specified in this section. GEM Result B is the g/ton-mile CO<sub>2</sub> emission rate resulting from emission modeling of the advanced vehicle as specified in § 1037.520.

(3) If you apply an improvement factor to multiple vehicle configurations using the same advanced technology, use the vehicle configuration with the smallest potential reduction in greenhouse gas emissions resulting from the hybrid capability.

(4) Use the equations of § 1037.705 to convert the g/ton-mile benefit to emission credits (in Mg). Use the g/ton-mile benefit in place of the (Std-FEL) term.

(c) See § 1037.540 for special testing provisions related to Phase 1 vehicles equipped with hybrid power take-off units.

(d) For Phase 2 plug-in hybrid electric vehicles and for fuel cells powered by any fuel other than hydrogen, calculate CO<sub>2</sub> credits using an FEL based on emission measurements from powertrain testing. Phase 2 advanced-technology credits do not apply for hybrid vehicles that have no plug-in capability.

(e) You may use an engineering analysis to calculate an improvement factor for fuel cell vehicles based on measured emissions from the fuel cell vehicle.

(f) For electric vehicles, calculate CO<sub>2</sub> credits using an FEL of 0 g/ton-mile.

(g) As specified in subpart H of this part, advanced-technology credits generated from Phase 1 vehicles under this section may be used under this part 1037 outside of the averaging set in which they were generated, or they may be used under 40 CFR 86.1819 or 40 CFR part 1036. Advanced-technology credits generated from Phase 2 vehicles are subject to all the averaging-set restrictions that apply to other emission credits.

(h) You may certify using both provisions of this section and the off-cycle technology provisions of

§ 1037.610, provided you do not double count emission benefits.

#### **§ 1037.620 Responsibilities for multiple manufacturers.**

This section describes certain circumstances in which multiple manufacturers share responsibilities for vehicles they produce together. This section does not limit responsibilities that apply under the Act or these regulations for anyone meeting the definition of “manufacturer” in § 1037.801. Note that the definition of manufacturer is broad and can include persons not commercially considered to be manufacturers.

(a) The following provisions apply when there are multiple persons meeting the definition of manufacturer in § 1037.801:

(1) Each person meeting the definition of manufacturer must comply with the requirements of this part that apply to manufacturers. However, if one person complies with a specific requirement for a given vehicle, then all manufacturers are deemed to have complied with that specific requirement.

(2) We will apply the requirements of subparts C and D of this part to the manufacturer that obtains the certificate of conformity for the vehicle. Other manufacturers are required to comply with the requirements of subparts C and D of this part only when notified by us. In our notification, we will specify a reasonable time period in which you need to comply with the requirements identified in the notice. See § 1037.601 for the applicability of 40 CFR part 1068 to these other manufacturers and remanufacturers.

(b) The provisions of § 1037.621, including delegated assembly, apply for certifying manufacturers that rely on other manufacturers to finish assembly in a certified configuration. The provisions of § 1037.622 generally apply for manufacturers that ship vehicles subject to the requirements of this part to a certifying secondary vehicle manufacturer. The provisions of § 1037.622 also apply to the secondary vehicle manufacturer. If you hold the certificate of conformity for a vehicle only with respect to exhaust or evaporative emissions, and a different company holds the other certificate of conformity for that vehicle, the provisions of § 1037.621 apply with respect to the certified configuration as described in your application for certification, and the provisions of § 1037.622 apply with respect to the certified configuration as described in the other manufacturer’s application for certification.

(c) Manufacturers of aerodynamic devices may perform the aerodynamic testing described in § 1037.526 to quantify  $\Delta C_{DA}$  values for trailers and submit that data to EPA verification under § 1037.211. Trailer manufacturers may use such verified data to establish input parameters for certifying their trailers. Both device manufacturers and trailer manufacturers are subject to 40 CFR part 1068, including the recall provisions described in 40 CFR part 1068, subpart F.

(d) Component manufacturers (such as tire manufacturers) providing test data to certifying vehicle manufacturers are responsible as follows for test components and emission test results provided to vehicle manufacturers for the purpose of certification under this part:

(1) Such test results are deemed under § 1037.825 to be submissions to EPA. This means that you may be subject to criminal penalties under 18 U.S.C. 1001 if you knowingly submit false test results to the certifying manufacturer.

(2) You may not cause a vehicle manufacturer to violate the regulations by rendering inaccurate emission test results you provide (or emission test results from testing of test components you provide) to the vehicle manufacturer (see 40 CFR 1068.101(c)).

(3) Your provision of test components and/or emission test results to vehicle manufacturers for the purpose of certifying under this part are deemed to be an agreement to provide components to EPA for confirmatory testing under § 1037.235.

(e) Component manufacturers may contractually agree to process emission warranty claims on behalf of the certifying manufacturer with respect to those components, as follows:

(1) Your fulfillment of the warranty requirements of this part is deemed to fulfill the vehicle manufacturer’s warranty obligations under this part with respect to components covered by your warranty.

(2) You may not cause a vehicle manufacturer to violate the regulations by failing to fulfill the emission warranty requirements that you contractually agreed to fulfill (see 40 CFR 1068.101(c)).

(f) We may require component manufacturers to provide information or take other actions under 42 U.S.C. 7542. For example, we may require component manufacturers to test components they produce.

#### **§ 1037.621 Delegated assembly.**

(a) This section describes provisions that allow certificate holders to sell or ship vehicles that are missing certain

emission-related components if those components will be installed by a secondary vehicle manufacturer. Paragraph (g) of this section similarly describes how dealers and distributors may modify new vehicles with your advance approval. (**Note:** See § 1037.622 for provisions related to manufacturers introducing into U.S. commerce partially complete vehicles for which a secondary vehicle manufacturer holds the certificate of conformity.)

(b) You do not need an exemption to ship a vehicle that does not include installation or assembly of certain emission-related components if those components are shipped along with the vehicle. For example, you may generally ship fuel tanks and aerodynamic devices along with vehicles rather than installing them on the vehicle before shipment. We may require you to describe how you plan to use this provision.

(c) You may ask us at the time of certification for an exemption to allow you to ship your vehicles without emission-related components. If we allow this, you must provide emission-related installation instructions as specified in § 1037.130. You must follow delegated-assembly requirements in 40 CFR 1068.261 if you rely on secondary vehicle manufacturers to install certain technologies or components as specified in paragraph (d) of this section. For other technologies or components, we may specify conditions that we determine are needed to ensure that shipping the vehicle without such components will not result in the vehicle being operated outside of its certified configuration; this may include a requirement to comply with the delegated-assembly provisions in paragraph (d) of this section. We may consider your past performance when we specify the conditions that apply.

(d) Delegated-assembly provisions apply as specified in this paragraph (d) if the certifying vehicle manufacturer relies on a secondary vehicle manufacturer to procure and install auxiliary power units, aerodynamic devices, hybrid components (for powertrain or power take-off), or natural gas fuel tanks. These provisions do not apply for other systems or components, such as air conditioning lines and fittings, except as specified in paragraph (c) of this section. Apply the provisions of 40 CFR 1068.261, with the following exceptions and clarifications:

(1) Understand references to “engines” to refer to vehicles.

(2) Understand references to “aftertreatment components” to refer to

any relevant emission-related components under this paragraph (d).

(3) Understand “equipment manufacturers” to be secondary vehicle manufacturers.

(4) The provisions of 40 CFR 1068.261(b), (c)(7), (d), and (e) do not apply. Accordingly, the provisions of 40 CFR 1068.261(c) apply regardless of pricing arrangements.

(e) Secondary vehicle manufacturers must follow the engine manufacturer’s emission-related installation instructions. Not meeting the manufacturer’s emission-related installation instructions is a violation of one or more of the prohibitions of § 1068.101. We may also require secondary vehicle manufacturers to recall defective vehicles under 40 CFR 1068.505 if we determine that their manufacturing practices caused vehicles to not conform to the regulations. Secondary vehicle manufacturers may be required to meet additional requirements if the certifying vehicle manufacturer delegates final assembly of emission controls as described in paragraph (d) of this section.

(f) Except as allowed by § 1037.622, the provisions of this section apply to manufacturers for glider kits they produce. Note that under § 1037.620, glider kit manufacturers are generally presumed to be responsible (in whole or in part) for compliance with respect to vehicles produced from their glider kits, even if a secondary vehicle manufacturer holds the certificate under § 1037.622.

(g) We may allow certifying vehicle manufacturers to authorize dealers or distributors to reconfigure vehicles after the vehicles have been introduced into commerce if they have not yet been delivered to the ultimate purchaser as follows:

(1) This allowance is limited to changes from one certified configuration to another, as noted in the following examples:

(i) If your vehicle family includes certified configurations with different axle ratios, you may authorize changing from one certified axle ratio to another.

(ii) You may authorize adding a certified APU to a tractor.

(2) Your final ABT report must accurately describe the vehicle’s certified configuration as delivered to the ultimate purchaser. This means that the allowance no longer applies after you submit the final ABT report.

(3) The vehicle label must accurately reflect the final vehicle configuration.

(4) You must keep records to document modifications under this paragraph (g).

(5) Dealers and distributors must keep a record of your authorizing instructions. Dealers and distributors that fail to follow your instructions or otherwise make unauthorized changes may be committing a tampering violation as described in 40 CFR 1068.105(b).

**§ 1037.622 Shipment of partially complete vehicles to secondary vehicle manufacturers.**

This section specifies how manufacturers may introduce partially complete vehicles into U.S. commerce (or in the case of certain custom vehicles, introduce complete vehicles into U.S. commerce for modification by a small manufacturer). The provisions of this section are generally not intended for trailers, but they may apply in unusual circumstances, such as when a secondary vehicle manufacturer will modify a trailer in a way that makes it exempt. The provisions of this section are intended to accommodate normal business practices without compromising the effectiveness of certified emission controls. You may not use the provisions of this section to circumvent the intent of this part. For vehicles subject to both exhaust GHG and evaporative standards, the provisions of this part apply separately for each certificate.

(a) The provisions of this section allow manufacturers to ship partially complete vehicles to secondary vehicle manufacturers or otherwise introduce them into U.S. commerce in the following circumstances:

(1) *Certified vehicles.* Manufacturers may introduce partially complete tractors into U.S. commerce if they are covered by certificates of conformity and are in certified configurations. See § 1037.621 for vehicles not yet in a certified configuration when introduced into U.S. commerce.

(2) *Uncertified vehicles that will be certified by secondary vehicle manufacturers.* Manufacturers may introduce into U.S. commerce partially complete vehicles for which they do not hold the required certificate of conformity only as allowed by paragraph (b) of this section; however, the requirements of this section do not apply for tractors or vocational vehicles with a date of manufacture before January 1, 2022, that are produced by a secondary vehicle manufacturer if they are excluded from the standards of this part under § 1037.150(c).

(3) *Exempted vehicles.* Manufacturers may introduce into U.S. commerce partially complete vehicles without a certificate of conformity if the vehicles are exempt under this part or under 40

CFR part 1068. This may involve the secondary vehicle manufacturer qualifying for the exemption.

(4) *Small manufacturers modifying certified tractors.* Small manufacturers that build custom sleeper cabs or natural gas-fueled tractors may modify complete or incomplete vehicles certified as tractors, as specified by paragraph (d) of this section.

(b) The provisions of this paragraph (b) generally apply where the secondary vehicle manufacturer has substantial control over the design and assembly of emission controls. They also apply where a secondary vehicle manufacturer qualifies for a permanent exemption. In unusual circumstances we may allow other secondary vehicle manufacturers to use these provisions. In determining whether a manufacturer has substantial control over the design and assembly of emission controls, we would consider the degree to which the secondary vehicle manufacturer would be able to ensure that the engine and vehicle will conform to the regulations in their final configurations.

(1) A secondary vehicle manufacturer may finish assembly of partially complete vehicles in the following cases:

(i) It obtains a vehicle that is not fully assembled with the intent to manufacture a complete vehicle in a certified or exempted configuration. For example, this would apply where a glider vehicle assembler holds a certificate that allows the assembler to produce certified glider vehicles from glider kits.

(ii) It obtains a vehicle with the intent to modify it to a certified configuration before it reaches the ultimate purchaser. For example, this may apply for converting a gasoline-fueled vehicle to operate on natural gas under the terms of a valid certificate.

(2) Manufacturers may introduce partially complete vehicles into U.S. commerce as described in this paragraph (b) if they have a written request for such vehicles from a secondary vehicle manufacturer that will finish the vehicle assembly and has certified the vehicle (or the vehicle has been exempted or excluded from the requirements of this part). The written request must include a statement that the secondary vehicle manufacturer has a certificate of conformity (or exemption/exclusion) for the vehicle and identify a valid vehicle family name associated with each vehicle model ordered (or the basis for an exemption/exclusion). The original vehicle manufacturer must apply a removable label meeting the requirements of 40 CFR 1068.45(b) that identifies the

corporate name of the original manufacturer and states that the vehicle is exempt under the provisions of § 1037.622. The name of the certifying manufacturer must also be on the label or, alternatively, on the bill of lading that accompanies the vehicles during shipment. The original manufacturer may not apply a permanent emission control information label identifying the vehicle's eventual status as a certified vehicle. Note that an exemption allowing a glider assembler to install an exempt engine does not necessarily exempt the vehicle from the requirements of this part.

(3) If you are the secondary vehicle manufacturer and you will hold the certificate, you must include the following information in your application for certification:

(i) Identify the original manufacturer of the partially complete vehicle or of the complete vehicle you will modify.

(ii) Describe briefly how and where final assembly will be completed. Specify how you have the ability to ensure that the vehicles will conform to the regulations in their final configuration. (**Note:** This section prohibits using the provisions of this paragraph (b) unless you have substantial control over the design and assembly of emission controls.)

(iii) State unconditionally that you will not distribute the vehicles without conforming to all applicable regulations.

(4) If you are a secondary vehicle manufacturer and you are already a certificate holder for other families, you may receive shipment of partially complete vehicles after you apply for a certificate of conformity but before the certificate's effective date. This exemption allows the original manufacturer to ship vehicles after you have applied for a certificate of conformity. Manufacturers may introduce partially complete vehicles into U.S. commerce as described in this paragraph (b)(4) if they have a written request for such vehicles from a secondary vehicle manufacturer stating that the application for certification has been submitted (instead of the information we specify in paragraph (b)(2) of this section). We may set additional conditions under this paragraph (b)(4) to prevent circumvention of regulatory requirements.

(5) The provisions of this section also apply for shipping partially complete vehicles if the vehicle is covered by a valid exemption and there is no valid family name that could be used to represent the vehicle model. Unless we approve otherwise in advance, you may do this only when shipping engines to

secondary vehicle manufacturers that are certificate holders. In this case, the secondary vehicle manufacturer must identify the regulatory cite identifying the applicable exemption instead of a valid family name when ordering engines from the original vehicle manufacturer.

(6) Both original and secondary vehicle manufacturers must keep the records described in this section for at least five years, including the written request for exempted vehicles and the bill of lading for each shipment (if applicable). The written request is deemed to be a submission to EPA.

(7) These provisions are intended only to allow secondary vehicle manufacturers to obtain or transport vehicles in the specific circumstances identified in this section so any exemption under this section expires when the vehicle reaches the point of final assembly identified in paragraph (b)(3)(ii) of this section.

(8) For purposes of this section, an allowance to introduce partially complete vehicles into U.S. commerce includes a conditional allowance to sell, introduce, or deliver such vehicles into commerce in the United States or import them into the United States. It does not include a general allowance to offer such vehicles for sale because this exemption is intended to apply only for cases in which the certificate holder already has an arrangement to purchase the vehicles from the original manufacturer. This exemption does not allow the original manufacturer to subsequently offer the vehicles for sale to a different manufacturer who will hold the certificate unless that second manufacturer has also complied with the requirements of this part. The exemption does not apply for any individual vehicles that are not labeled as specified in this section or which are shipped to someone who is not a certificate holder.

(9) We may suspend, revoke, or void an exemption under this section, as follows:

(i) We may suspend or revoke your exemption if you fail to meet the requirements of this section. We may suspend or revoke an exemption related to a specific secondary vehicle manufacturer if that manufacturer sells vehicles that are in not in a certified configuration in violation of the regulations. We may disallow this exemption for future shipments to the affected secondary vehicle manufacturer or set additional conditions to ensure that vehicles will be assembled in the certified configuration.

(ii) We may void an exemption for all the affected vehicles if you intentionally

submit false or incomplete information or fail to keep and provide to EPA the records required by this section.

(iii) The exemption is void for a vehicle that is shipped to a company that is not a certificate holder or for a vehicle that is shipped to a secondary vehicle manufacturer that is not in compliance with the requirements of this section.

(iv) The secondary vehicle manufacturer may be liable for penalties for causing a prohibited act where the exemption is voided due to actions on the part of the secondary vehicle manufacturer.

(c) Provide instructions along with partially complete vehicles including all information necessary to ensure that an engine will be installed in its certified configuration.

(d) Small manufacturers that build custom sleeper cabs or natural gas-fueled tractors may modify complete or incomplete vehicles certified as tractors, subject to the provisions of this paragraph (d). Such businesses are secondary vehicle manufacturers.

(1) Secondary vehicle manufacturers may not modify the vehicle body in front of the b-pillar or increase the effective frontal area of the certified configuration including consideration of the frontal area of the standard trailer. For high-roof custom sleeper tractors, this would generally mean that no part of the added sleeper compartment may extend beyond 102 inches wide or 162 inches high (measured from the ground), which are the dimensions of the standard trailer for high-roof tractors under this part. Note that these dimensions have a tolerance of  $\pm 2$  inches.

(2) The certifying manufacturer may have responsibilities for the vehicle under this section, as follows:

(i) If the vehicle being modified is a complete tractor in a certified configuration, the certifying manufacturer has no additional responsibilities for the vehicle under this section.

(ii) If the vehicle being modified is partially complete only because it lacks body components to the rear of the b-pillar (but is otherwise a complete tractor in a certified configuration), the certifying manufacturer has no additional responsibilities for the vehicle under this section.

(iii) If the vehicle being modified is an incomplete tractor not in a certified configuration, the certifying manufacturer must comply with the provisions of § 1037.621 for the vehicle.

(3) The secondary vehicle manufacturer must add a permanent supplemental label to the vehicle near

the original manufacturer's emission control information label. On the label identify your corporate name and include the statement: "THIS TRACTOR WAS MODIFIED UNDER 40 CFR 1037.622."

(4) See § 1037.150 for additional interim options that may apply.

(5) The provisions of this paragraph (d) may apply separately for vehicle GHG and evaporative emission standards.

(6) Modifications under this paragraph (d) do not violate 40 CFR 1068.101(b)(1).

#### § 1037.630 Special purpose tractors.

(a) *General provisions.* This section allows a vehicle manufacturer to reclassify certain tractors as vocational tractors. Vocational tractors are treated as vocational vehicles and are exempt from the standards of § 1037.106. Note that references to "tractors" outside of this section mean non-vocational tractors.

(1) This allowance is intended only for vehicles that do not typically operate at highway speeds, or would otherwise not benefit from efficiency improvements designed for line-haul tractors. This allowance is limited to the following vehicle and application types:

(i) Low-roof tractors intended for intra-city pickup and delivery, such as those that deliver bottled beverages to retail stores.

(ii) Tractors intended for off-road operation (including mixed service operation that does not qualify for an exemption under § 1037.631), such as those with reinforced frames and increased ground clearance. This includes drayage tractors.

(iii) Model year 2020 and earlier tractors with a gross combination weight rating (GCWR) at or above 120,000 pounds. Note that Phase 2 tractors meeting the definition of "heavy-haul" in § 1037.801 must be certified to the heavy-haul standards in §§ 1037.106 or 1037.670.

(2) Where we determine that a manufacturer is not applying this allowance in good faith, we may require the manufacturer to obtain preliminary approval before using this allowance.

(b) *Requirements.* The following requirements apply with respect to tractors reclassified under this section:

(1) The vehicle must fully conform to all requirements applicable to vocational vehicles under this part.

(2) Vehicles reclassified under this section must be certified as a separate vehicle family. However, they remain part of the vocational regulatory subcategory and averaging set that applies for their service class.

(3) You must include the following additional statement on the vehicle's emission control information label under § 1037.135: "THIS VEHICLE WAS CERTIFIED AS A VOCATIONAL TRACTOR UNDER 40 CFR 1037.630."

(4) You must keep records for three years to document your basis for believing the vehicles will be used as described in paragraph (a)(1) of this section. Include in your application for certification a brief description of your basis.

(c) *Production limit.* No manufacturer may produce more than 21,000 Phase 1 vehicles under this section in any consecutive three model year period. This means you may not exceed 6,000 in a given model year if the combined total for the previous two years was 15,000. The production limit applies with respect to all Class 7 and Class 8 Phase 1 tractors certified or exempted as vocational tractors. No production limit applies for tractors subject to Phase 2 standards.

(d) *Off-road exemption.* All the provisions of this section apply for vocational tractors exempted under § 1037.631, except as follows:

(1) The vehicles are required to comply with the requirements of § 1037.631 instead of the requirements that would otherwise apply to vocational vehicles. Vehicles complying with the requirements of § 1037.631 and using an engine certified to the standards of 40 CFR part 1036 are deemed to fully conform to all requirements applicable to vocational vehicles under this part.

(2) The vehicles must be labeled as specified under § 1037.631 instead of as specified in paragraph (b)(3) of this section.

#### § 1037.631 Exemption for vocational vehicles intended for off-road use.

This section provides an exemption from the greenhouse gas standards of this part for certain vocational vehicles (including certain vocational tractors) that are intended to be used extensively in off-road environments such as forests, oil fields, and construction sites. This section does not exempt engines used in vocational vehicles from the standards of 40 CFR part 86 or part 1036. Note that you may not include these exempted vehicles in any credit calculations under this part.

(a) *Qualifying criteria.* Vocational vehicles intended for off-road use are exempt without request, subject to the provisions of this section, if they are primarily designed to perform work off-road (such as in oil fields, mining, forests, or construction sites), and they meet at least one of the criteria of

paragraph (a)(1) of this section and at least one of the criteria of paragraph (a)(2) of this section. See § 1037.105(h) for alternate Phase 2 standards that apply for vehicles meeting only one of these sets of criteria.

(1) The vehicle must have affixed components designed to work inherently in an off-road environment (such as hazardous material equipment or off-road drill equipment) or be designed to operate at low speeds such that it is unsuitable for normal highway operation.

(2) The vehicle must meet one of the following criteria:

(i) Have an axle that has a gross axle weight rating (GAWR) at or above 29,000 pounds.

(ii) Have a speed attainable in 2.0 miles of not more than 33 mi/hr.

(iii) Have a speed attainable in 2.0 miles of not more than 45 mi/hr, an unloaded vehicle weight that is not less than 95 percent of its gross vehicle weight rating, and no capacity to carry occupants other than the driver and operating crew.

(iv) Have a maximum speed at or below 54 mi/hr. You may consider the vehicle to be appropriately speed-limited if engine speed at 54 mi/hr is at or above 95 percent of the engine's maximum test speed in the highest available gear. You may alternatively limit vehicle speed by programming the engine or vehicle's electronic control module in a way that is tamper-proof.

(b) *Tractors.* The provisions of this section may apply for tractors only if each tractor qualifies as a vocational tractor under § 1037.630.

(c) *Recordkeeping and reporting.* (1) You must keep records to document that your exempted vehicle configurations meet all applicable requirements of this section. Keep these records for at least eight years after you stop producing the exempted vehicle model. We may review these records at any time.

(2) You must also keep records of the individual exempted vehicles you produce, including the vehicle identification number and a description of the vehicle configuration.

(3) Within 90 days after the end of each model year, you must send to the Designated Compliance Officer a report with the following information:

(i) A description of each exempted vehicle configuration, including an explanation of why it qualifies for this exemption.

(ii) The number of vehicles exempted for each vehicle configuration.

(d) *Labeling.* You must include the following additional statement on the vehicle's emission control information label under § 1037.135: "THIS VEHICLE

WAS EXEMPTED UNDER 40 CFR 1037.631."

#### § 1037.635 Glider kits and glider vehicles.

Except as specified in § 1037.150, the requirements of this section apply beginning January 1, 2017.

(a) Vehicles produced from glider kits and other glider vehicles are subject to the same standards as other new vehicles, including the applicable vehicle standards described in Subpart B of this part. Note that this requirement for the vehicle generally applies even if the engine meets the criteria of paragraph (c)(1) of this section. For engines originally produced before 2017, if you are unable to obtain a fuel map for an engine you may ask to use a default map, consistent with good engineering judgment.

(b) Section 1037.601(a)(1) disallows the introduction into U.S. commerce of a new tractor or vocational vehicle (including a vehicle assembled from a glider kit) unless it has an engine that is certified to the applicable standards in 40 CFR parts 86 and 1036. Except as specified otherwise in this part, the standards apply for engines used in glider vehicles as follows:

(1) The engine must meet the GHG standards of 40 CFR part 1036 that apply for the engine model year corresponding to the vehicle's date of manufacture. For example, for a vehicle with a 2024 date of manufacture, the engine must meet the GHG standards that apply for model year 2024.

(2) The engine must meet the criteria pollutant standards of 40 CFR part 86 that apply for the engine model year corresponding to the vehicle's date of manufacture.

(3) The engine may be from an earlier model year if the standards were identical to the currently applicable engine standards.

(4) Note that alternate standards or requirements may apply under § 1037.150.

(c) The engine standards identified in paragraph (b) of this section do not apply for certain engines when used in glider kits. These engines remain subject to the standards to which they were previously certified.

(1) The allowance in this paragraph (c) applies only for following engines:

(i) Certified engines still within their original useful life in terms of both miles and years. Glider vehicles produced using engines meeting this criterion are exempt from the requirements of paragraph (a) of this section if the glider vehicle configuration is identical to a configuration previously certified to the requirements of this part 1037 for a

model year the same as or later than the model year of the engine.

(ii) Certified engines of any age with less than 100,000 miles of engine operation. This is intended for specialty vehicles (such as fire trucks) that have very low usage rates. These vehicles are exempt from the requirements of paragraph (a) of this section, provided the completed vehicle is returned to the owner of the engine in a configuration equivalent to that of the donor vehicle.

(iii) Certified engines less than three years old with any number of accumulated miles of engine operation. Vehicles using these engines must comply with the requirements of paragraph (a) of this section.

(2) For remanufactured engines, these eligibility criteria apply based on the original date of manufacture rather than the date of remanufacture. For example, an engine originally manufactured in 2003 that is remanufactured in 2012 after 350,000 miles, then accumulates an additional 150,000 miles before being installed in a model year 2020 glider would be considered to be 17 years old and to have accumulated 500,000 miles.

(3) The provisions of this paragraph (c) apply only where you can show that one or more criteria have been met. For example, to apply the criterion of paragraph (c)(1)(i) or (ii), you must be able to prove the number of miles the engine has accumulated.

(d) All engines used in glider vehicles (including remanufactured engines) must be in a certified configuration and properly labeled. This requirement applies equally to any engine covered by this section. Depending on the model year of the engine (and other applicable provisions of this section), it may be permissible for the engine to remain in its original certified configuration or another configuration of the same original model year. However, it may be necessary to modify the engine to a newer certified configuration.

(e) The following additional provisions apply:

(1) The Clean Air Act definition of "manufacturer" includes anyone who assembles motor vehicles, including entities that install engines in or otherwise complete assembly of glider kits.

(2) Vehicle manufacturers (including assemblers) producing glider vehicles must comply with the reporting and recordkeeping requirements in § 1037.250.

(3) Manufacturers of glider kits providing glider kits for the purpose of allowing another manufacturer to assemble vehicles under this section are subject to the provisions of §§ 1037.620 through 1037.622, as applicable. For

example, introducing an uncertified glider kit into U.S. commerce may subject you to penalties under 40 CFR 1068.101 if the completed glider vehicle does not conform fully with the regulations of the part at any point before being placed into service.

**§ 1037.640 Variable vehicle speed limiters.**

This section specifies provisions that apply for vehicle speed limiters (VSLs) that you model under § 1037.520. This does not apply for VSLs that you do not model under § 1037.520. (e) This section is written to apply for tractors; however, you may use good engineering judgment to apply equivalent adjustments for Phase 2 vocational vehicles with vehicle speed limiters.

(a) *General.* The regulations of this part do not constrain how you may design VSLs for your vehicles. For example, you may design your VSL to have a single fixed speed limit or a soft-top speed limit. You may also design your VSL to expire after accumulation of a predetermined number of miles. However, designs with soft tops or expiration features are subject to proration provisions under this section that do not apply to fixed VSLs that do not expire.

(b) *Definitions.* The following definitions apply for purposes of this section:

(1) Default speed limit means the speed limit that normally applies for the vehicle, except as follows:

(i) The default speed limit for adjustable VSLs must represent the speed limit that applies when the VSL is adjusted to its highest setting under paragraph (c) of this section.

(ii) For VSLs with soft tops, the default speed does not include speeds possible only during soft-top operation.

(iii) For expiring VSLs, the default does not include speeds that are possible only after expiration.

(2) Soft-top speed limit means the highest speed limit that applies during soft-top operation.

(3) Maximum soft-top duration means the maximum amount of time that a vehicle could operate above the default speed limit.

(4) Certified VSL means a VSL configuration that applies when a vehicle is new and until it expires.

(5) Expiration point means the mileage at which a vehicle's certified VSL expires (or the point at which tamper protections expire).

(6) Effective speed limit has the meaning given in paragraph (d) of this section.

(c) *Adjustments.* You may design your VSL to be adjustable; however, this may affect the value you use in GEM.

(1) Except as specified in paragraph (c)(2) of this section, any adjustments that can be made to the engine, vehicle,

or their controls that change the VSL's actual speed limit are considered to be adjustable operating parameters. Compliance is based on the vehicle being adjusted to the highest speed limit within this range.

(2) The following adjustments are not adjustable parameters:

(i) Adjustments made only to account for changing tire size or final drive ratio.

(ii) Adjustments protected by encrypted controls or passwords.

(iii) Adjustments possible only after the VSL's expiration point.

(d) *Effective speed limit.* (1) For VSLs without soft tops or expiration points that expire before 1,259,000 miles, the effective speed limit is the highest speed limit that results by adjusting the VSL or other vehicle parameters consistent with the provisions of paragraph (c) of this section.

(2) For VSLs with soft tops and/or expiration points, the effective speed limit is calculated as specified in this paragraph (d)(2), which is based on 10 hours of operation per day (394 miles per day for day cabs and 551 miles per day for sleeper cabs). Note that this calculation assumes that a fraction of this operation is speed-limited (3.9 hours and 252 miles for day cabs, and 7.3 hours and 474 miles for sleeper cabs). Use the following equation to calculate the effective speed limit, rounded to the nearest 0.1 mi/hr:

$$\text{Effective speed} = \text{ExF} \cdot [\text{STF} \cdot \text{STSL} + (1 - \text{STF}) \cdot \text{DSL}] + (1 - \text{ExF}) \cdot 65 \text{ mi/hr}$$

Eq. 1037.640-1

Where:

ExF = expiration point miles/1,259,000 miles.

STF = the maximum number of allowable soft top operation hours per day/3.9 hours for day cabs (or maximum miles per day/252), or the maximum number of allowable soft top operation hours per day/7.3 hours for sleeper cabs (or maximum miles per day/474).

STSL = the soft-top speed limit.

DSL = the default speed limit.

**§ 1037.645 In-use compliance with family emission limits (FELs).**

Section 1037.225 describes how to change the FEL for a vehicle family during the model year. This section, which describes how you may ask us to increase a vehicle family's FEL after the end of the model year, is intended to address circumstances in which it is in the public interest to apply a higher in-use FEL based on forfeiting an appropriate number of emission credits. For example, this may be appropriate

where we determine that recalling vehicles would not significantly reduce in-use emissions. We will generally not allow this option where we determine the credits being forfeited would likely have expired.

(a) You may ask us to increase a vehicle family's FEL after the end of the model year if you believe some of your in-use vehicles exceed the CO<sub>2</sub> FEL that applied during the model year (or the CO<sub>2</sub> emission standard if the family did not generate or use emission credits). We may consider any available information in making our decision to approve or deny your request.

(b) If we approve your request under this section, you must apply emission credits to cover the increased FEL for all affected vehicles. Apply the emission credits as part of your credit demonstration for the current production year. Include the appropriate calculations in your final report under § 1037.730.

(c) Submit your request to the Designated Compliance Officer. Include the following in your request:

(1) Identify the names of each vehicle family that is the subject of your request. Include separate family names for different model years

(2) Describe why your request does not apply for similar vehicle models or additional model years, as applicable.

(3) Identify the FEL that applied during the model year for each configuration and recommend replacement FELs for in-use vehicles; include a supporting rationale to describe how you determined the recommended replacement FELs.

(4) Describe whether the needed emission credits will come from averaging, banking, or trading.

(d) If we approve your request, we will identify one or more replacement FELs, as follows:

(1) Where your vehicle family includes more than one sub-family with



different FELs, we may apply a higher FEL within the family than was applied to the vehicle's configuration in your final ABT report. For example, if your vehicle family included three sub-families, with FELs of 200 g/ton-mile, 210 g/ton-mile, and 220 g/ton-mile, we may apply a 220 g/ton-mile in-use FEL to vehicles that were originally designated as part of the 200 g/ton-mile or 210 g/ton-mile sub-families.

(2) Without regard to the number of sub-families in your certified vehicle family, we may specify one or more new sub-families with higher FELs than you included in your final ABT report. We may apply these higher FELs as in-use FELs for your vehicles. For example, if your vehicle family included three sub-families, with FELs of 200 g/ton-mile, 210 g/ton-mile, and 220 g/ton-mile, we may specify a new 230 g/ton-mile sub-family.

(3) Our selected values for the replacement FEL will reflect our best judgment to accurately reflect the actual in-use performance of your vehicles, consistent with the testing provisions specified in this part.

(4) We may apply the higher FELs to other vehicle families from the same or different model years to the extent they used equivalent emission controls. We may include any appropriate conditions with our approval.

(e) If we order a recall for a vehicle family under 40 CFR 1068.505, we will no longer approve a replacement FEL under this section for any of your vehicles from that vehicle family, or from any other vehicle family that relies on equivalent emission controls.

#### **§ 1037.655 Post-useful life vehicle modifications.**

(a) *General.* Vehicle modifications during and after the useful life are presumed to violate 42 U.S.C. 7522(a)(3)(A) if they involve removing or rendering inoperative any emission control device installed to comply with the requirements of this part 1037. This section specifies vehicle modifications that may occur in certain circumstances after a vehicle reaches the end of its regulatory useful life. EPA may require a higher burden of proof with respect to modifications that occur within the useful life period, and the specific examples presented here do not necessarily apply within the useful life. This section also does not apply with respect to engine modifications or recalibrations.

(b) *Allowable modifications.* You may modify a vehicle for the purpose of reducing emissions, provided you have a reasonable technical basis for knowing that such modification will not increase

emissions of any other pollutant. "Reasonable technical basis" has the meaning given in 40 CFR 1068.30. This generally requires you to have information that would lead an engineer or other person familiar with engine and vehicle design and function to reasonably believe that the modifications will not increase emissions of any regulated pollutant.

(c) *Examples of allowable modifications.* The following are examples of allowable modifications:

(1) It is generally allowable to remove tractor roof fairings after the end of the vehicle's useful life if the vehicle will no longer be used primarily to pull box vans.

(2) Other fairings may be removed after the end of the vehicle's useful life if the vehicle will no longer be used significantly on highways with a vehicle speed of 55 miles per hour or higher.

(d) *Examples of prohibited modifications.* The following are examples of modifications that are not allowable:

(1) No person may disable a vehicle speed limiter prior to its expiration point.

(2) No person may remove aerodynamic fairings from tractors that are used primarily to pull box vans on highways.

#### **§ 1037.660 Idle-reduction technologies.**

This section specifies requirements that apply for idle-reduction technologies modeled under § 1037.520. It does not apply for idle-reduction technologies you do not model under § 1037.520.

(a) *Minimum requirements.* Idle-reduction technologies must meet all the following requirements to be modeled under § 1037.520 except as specified in paragraphs (b) and (c) of this section:

(1) *Automatic engine shutdown (AES) systems.* The system must shut down the engine within a threshold inactivity period of 60 seconds or less for vocational vehicles and 300 seconds or less for tractors when all the following conditions are met:

(i) The transmission is set to park, or the transmission is in neutral with the parking brake engaged. This is "parked idle."

(ii) The operator has not reset the system timer within the specified threshold inactivity period by changing the position of the accelerator, brake, or clutch pedal; or by resetting the system timer with some other mechanism we approve.

(iii) You may identify systems as "tamper-resistant" if you make no provision for vehicle owners, dealers, or

other service outlets to adjust the threshold inactivity period.

(iv) For Phase 2 tractors, you may identify AES systems as "adjustable" if, before delivering to the ultimate purchaser, you enable authorized dealers to modify the vehicle in a way that disables the AES system or makes the threshold inactivity period longer than 300 seconds. However, the vehicle may not be delivered to the ultimate purchaser with the AES system disabled or the threshold inactivity period set longer than 300 seconds. You may allow dealers or repair facilities to make such modifications; this might involve password protection for electronic controls, or special tools that only you provide. Any dealers making any modifications before delivery to the ultimate purchaser must notify you, and you must account for such modifications in your production and ABT reports after the end of the model year. Dealers failing to provide prompt notification are in violation of the tampering prohibition of 40 CFR 1068.101(b)(1). Dealer notifications are deemed to be submissions to EPA. Note that these adjustments may not be made if the AES system was not "adjustable" when first delivered to the ultimate purchaser.

(v) For vocational vehicles, you may use the provisions of § 1037.610 to apply for an appropriate partial emission reduction for AES systems you identify as "adjustable."

(2) *Neutral idle.* Phase 2 vehicles with hydrokinetic torque converters paired with automatic transmissions qualify for neutral-idle credit in GEM modeling if the transmission reduces torque equivalent to shifting into neutral throughout the interval during which the vehicle's brake pedal is depressed and the vehicle is at a zero-speed condition. If a vehicle reduces torque partially but not enough to be equivalent to shifting to neutral, you may use the provisions of § 1037.610(g) to apply for an appropriate partial emission reduction; this may involve A to B testing with the powertrain test procedure in § 1037.550 or the spin-loss portion of the transmission efficiency test in § 1037.565.

(3) *Stop-start.* Phase 2 vocational vehicles qualify for stop-start reduction in GEM modeling if the engine shuts down no more than 5 seconds after the vehicle's brake pedal is depressed when the vehicle is at a zero-speed condition.

(b) *Override conditions.* The system may limit activation of the idle-reduction technology while any of the conditions of this paragraph (b) apply. These conditions allow the system to delay engine shutdown, adjust engine



restarting, or delay disengaging transmissions, but do not allow for resetting timers. Engines may restart and transmissions may re-engage during override conditions if the vehicle is set up to do this automatically. We may approve additional override criteria as needed to protect the engine and vehicle from damage and to ensure safe vehicle operation.

(1) For AES systems on tractors, the system may delay shutdown—

(i) While an exhaust emission control device is regenerating. The period considered to be regeneration for purposes of this allowance must be consistent with good engineering judgment and may differ in length from the period considered to be regeneration for other purposes. For example, in some cases it may be appropriate to include a cool down period for this purpose but not for infrequent regeneration adjustment factors.

(ii) If necessary while servicing the vehicle, provided the deactivation of the AES system is accomplished using a diagnostic scan tool. The system must be automatically reactivated when the engine is shut down for more than 60 minutes.

(iii) If the vehicle's main battery state-of-charge is not sufficient to allow the main engine to be restarted.

(iv) If the vehicle's transmission, fuel, oil, or engine coolant temperature is too low or too high according to the manufacturer's specifications for protecting against system damage. This allows the engine to continue operating until it is in a predefined temperature range, within which the shutdown sequence of paragraph (a) of this section would resume.

(v) While the vehicle's main engine is operating in power take-off (PTO) mode. For purposes of this paragraph (b), an engine is considered to be in PTO mode when a switch or setting designating PTO mode is enabled.

(vi) If external ambient conditions prevent managing cabin temperatures for the driver's safety.

(2) For AES systems on vocational vehicles, the system may limit activation—

(i) If any condition specified in paragraphs (b)(1)(i) through (vi) of this section applies.

(ii) If internal cab temperatures are too hot or too cold for the driver's safety.

(3) For neutral idle, the system may delay shifting the transmission to neutral—

(i) For the PTO conditions specified in paragraph (b)(1)(v) of this section.

(ii) [Reserved]

(4) For stop-start, the system may limit activation—

(i) For any of the conditions specified in paragraphs (b)(2) or (b)(3)(i) of this section.

(ii) When air brake pressure is too low according to the manufacturer's specifications for maintaining vehicle-braking capability.

(iii) When the transmission is in reverse gear.

(iv) When recent vehicle speeds indicate an abnormally high shutdown and restart frequency, such as with congested driving. For example, a vehicle not exceeding 10 mi/hr for the previous 300 seconds or since the most recent engine start would be a proper basis for overriding engine shutdown. You may also design this override to protect against system damage or malfunction of safety systems.

(v) When the vehicle detects that a system or component is worn or malfunctioning in a way that could reasonably prevent the engine from restarting, such as low battery voltage.

(c) *Adjustments to AES systems for Phase 1.* (1) The AES system may include an expiration point (in miles) after which the AES system may be disabled. If your vehicle is equipped with an AES system that expires before 1,259,000 miles, adjust the model input as follows, rounded to the nearest 0.1 g/ton-mile: AES Input = 5 g CO<sub>2</sub>/ton-mile × (miles at expiration/1,259,000 miles).

(2) For AES systems designed to limit idling to a specific number of hours less than 1,800 hours over any 12-month period, calculate an adjusted AES input using the following equation, rounded to the nearest 0.1 g/ton-mile: AES Input = 5 g CO<sub>2</sub>/ton-mile × (1—(maximum allowable number of idling hours per year/1,800 hours)). This is an annual allowance that starts when the vehicle is new and resets every 12 months after that. Manufacturers may propose an alternate method based on operating hours or miles instead of years.

(d) *Adjustable parameters.* Provisions that apply generally with respect to adjustable parameters also apply to the AES system operating parameters, except the following are not considered to be adjustable parameters:

(1) Accelerator, brake, and clutch pedals, with respect to resetting the idle timer. Parameters associated with other timer reset mechanisms we approve are also not adjustable parameters.

(2) Bypass parameters allowed for vehicle service under paragraph (b)(1)(ii) of this section.

(3) Parameters that are adjustable only after the expiration point.

(e) *PM limit for diesel APU.* For model year 2020 and earlier tractors with a date of manufacture on or after January 1, 2018, the GEM credit for AES systems

with OEM-installed diesel APUs is valid only if the engine is certified under 40 CFR part 1039 with a deteriorated emission level for particulate matter at or below 0.15 g/kW-hr, or if the engine or APU is certified to the standards specified in § 1037.106(g).

#### § 1037.665 Production and in-use tractor testing.

Manufacturers with annual U.S.-directed production volumes of greater than 20,000 tractors must perform testing as described in this section. Tractors may be new or used.

(a) The following test requirements apply for model years 2021 and later:

(1) Each calendar year, select for testing three sleeper cabs and two day cabs certified to Phase 1 or Phase 2 standards. If we do not identify certain vehicle configurations for your testing, select models that you project to be among your 12 highest-selling vehicle configurations for the given year.

(2) Set up the tractors on a chassis dynamometer and operate them over all applicable duty cycles from § 1037.510(a). You may use emission-measurement systems meeting the specifications of 40 CFR part 1065, subpart J. Calculate coefficients for the road-load force equation as described in Section 10 of SAE J1263 or Section 11 of SAE J2263 (both incorporated by reference in § 1037.810). Use standard payload. Measure emissions of NO<sub>x</sub>, PM, CO, NMHC, CO<sub>2</sub>, CH<sub>4</sub>, and N<sub>2</sub>O. Determine emission levels in g/hour for the idle test and g/ton-mile for other duty cycles.

(b) Send us an annual report with your test results for each duty cycle and the corresponding GEM results. Send the report by the next October 1 after the year we select the vehicles for testing, or a later date that we approve. We may make your test data publicly available.

(c) We may approve your request to perform alternative testing that will provide equivalent or better information compared to the specified testing. We may also direct you to do less testing than we specify in this section.

(d) GHG standards do not apply with respect to testing under this section. Note however that NTE standards apply for any qualifying operation that occurs during the testing in the same way that it would during any other in-use testing.

#### § 1037.670 Optional CO<sub>2</sub> emission standards for tractors at or above 120,000 pounds GCWR.

(a) You may certify tractors at or above 120,000 pounds GCWR to the following CO<sub>2</sub> standards instead of the CO<sub>2</sub> standards of § 1037.106:

TABLE 1 OF § 1037.670—OPTIONAL CO<sub>2</sub> STANDARDS FOR TRACTORS ABOVE 120,000 POUNDS GCWR BY MODEL YEAR

[g/ton-mile]

Subcategory	Phase 2 standards for model years 2021 and later
Heavy Class 8 Low-Roof Day Cab .....	51.8
Heavy Class 8 Low-Roof Sleeper Cab .....	45.3
Heavy Class 8 Mid-Roof Day Cab .....	54.1
Heavy Class 8 Mid-Roof Sleeper Cab .....	47.9
Heavy Class 8 High-Roof Day Cab .....	54.1
Heavy Class 8 High-Roof Sleeper Cab .....	46.9

(b) Determine subcategories as described in § 1037.230 for tractors that are not heavy-haul tractors. For example, the subcategory for tractors that would otherwise be considered Class 8 low-roof day cabs would be Heavy Class 8 Low-Roof Day Cabs.

(c) Except for the CO<sub>2</sub> standards of § 1037.106, all provisions applicable to tractors under this part continue to apply to tractors certified to the standards of this section. Include the following compliance statement on your label instead of the statement specified in § 1037.135(c)(8): “THIS VEHICLE COMPLIES WITH U.S. EPA REGULATIONS FOR [MODEL YEAR] HEAVY-DUTY VEHICLES UNDER 40 CFR 1037.670.”

(d) The optional emission standards in this section are intended primarily for tractors that will be exported; however, you may include any tractors certified under this section in your emission credit calculation under § 1037.705 if they are part of your U.S.-directed production volume.

**Subpart H—Averaging, Banking, and Trading for Certification**

**§ 1037.701 General provisions.**

(a) You may average, bank, and trade emission credits for purposes of certification as described in this subpart and in subpart B of this part to show compliance with the standards of §§ 1037.105 through 1037.107. Note that §§ 1037.105(h) and 1037.107 specify standards involving limited or no use of emission credits under this subpart. Participation in this program is voluntary.

(b) The definitions of subpart I of this part apply to this subpart in addition to the following definitions:

(1) *Actual emission credits* means emission credits you have generated that we have verified by reviewing your final report.

(2) *Averaging set* means a set of vehicles in which emission credits may be exchanged. Note that an averaging set may comprise more than one regulatory subcategory. See § 1037.740.

(3) *Broker* means any entity that facilitates a trade of emission credits between a buyer and seller.

(4) *Buyer* means the entity that receives emission credits as a result of a trade.

(5) *Reserved emission credits* means emission credits you have generated that we have not yet verified by reviewing your final report.

(6) *Seller* means the entity that provides emission credits during a trade.

(7) *Standard* means the emission standard that applies under subpart B of this part for vehicles not participating in the ABT program of this subpart.

(8) *Trade* means to exchange emission credits, either as a buyer or seller.

(c) Emission credits may be exchanged only within an averaging set, except as specified in § 1037.740.

(d) You may not use emission credits generated under this subpart to offset any emissions that exceed an FEL or standard, except as allowed by § 1037.645.

(e) You may use either of the following approaches to retire or forego emission credits:

(1) You may trade emission credits generated from any number of your vehicles to the vehicle purchasers or other parties to retire the credits.

Identify any such credits in the reports described in § 1037.730. Vehicles must comply with the applicable FELs even if you donate or sell the corresponding emission credits under this paragraph

(e). Those credits may no longer be used by anyone to demonstrate compliance with any EPA emission standards.

(2) You may certify a family using an FEL below the emission standard as described in this part and choose not to generate emission credits for that family. If you do this, you do not need to calculate emission credits for those families and you do not need to submit or keep the associated records described in this subpart for that family.

(f) Emission credits may be used in the model year they are generated. Where we allow it, surplus emission credits may be banked for future model years. Surplus emission credits may sometimes be used for past model years, as described in § 1037.745.

(g) You may increase or decrease an FEL during the model year by amending

your application for certification under § 1037.225. The new FEL may apply only to vehicles you have not already introduced into commerce.

(h) See § 1037.740 for special credit provisions that apply for credits generated under 40 CFR 86.1819(k)(7), 40 CFR 1036.615, or § 1037.615.

(i) Unless the regulations explicitly allow it, you may not calculate credits more than once for any emission reduction. For example, if you generate CO<sub>2</sub> emission credits for a given hybrid vehicle under this part, no one may generate CO<sub>2</sub> emission credits for the hybrid engine under 40 CFR part 1036. However, credits could be generated for identical engine used in vehicles that did not generate credits under this part.

(j) You may use emission credits generated under the Phase 1 standards when certifying vehicles to Phase 2 standards. No credit adjustments are required other than corrections for different useful lives.

**§ 1037.705 Generating and calculating emission credits.**

(a) The provisions of this section apply separately for calculating emission credits for each pollutant.

(b) For each participating family or subfamily, calculate positive or negative emission credits relative to the otherwise applicable emission standard. Calculate positive emission credits for a family or subfamily that has an FEL below the standard. Calculate negative emission credits for a family or subfamily that has an FEL above the standard. Sum your positive and negative credits for the model year before rounding. Round the sum of emission credits to the nearest megagram (Mg), using consistent units with the following equation:

$$Emission\ credits\ (Mg) = (Std - FEL) \cdot (PL) \cdot (Volume) \cdot (UL) \cdot (10^{-6})$$

Where:

*Std* = the emission standard associated with the specific regulatory subcategory (g/ton-mile).

*FEL* = the family emission limit for the vehicle subfamily (g/ton-mile).

*PL* = standard payload, in tons.

*Volume* = U.S.-directed production volume of the vehicle subfamily. For example, if you produce three configurations with the same FEL, the subfamily production volume would be the sum of the production volumes for these three configurations.

*UL* = useful life of the vehicle, in miles, as described in § 1037.105 and § 1037.106. Use 250,000 miles for trailers.

(c) As described in § 1037.730, compliance with the requirements of this subpart is determined at the end of the model year based on actual U.S.-

directed production volumes. Keep appropriate records to document these production volumes. Do not include any of the following vehicles to calculate emission credits:

(1) Vehicles that you do not certify to the CO<sub>2</sub> standards of this part because they are permanently exempted under subpart G of this part or under 40 CFR part 1068.

(2) Exported vehicles.

(3) Vehicles not subject to the requirements of this part, such as those excluded under § 1037.5.

(4) Any other vehicles, where we indicate elsewhere in this part 1037 that they are not to be included in the calculations of this subpart.

#### § 1037.710 Averaging.

(a) Averaging is the exchange of emission credits among your vehicle families. You may average emission credits only within the same averaging set, except as specified in § 1037.740.

(b) You may certify one or more vehicle families (or subfamilies) to an FEL above the applicable standard, subject to any applicable FEL caps and other provisions in subpart B of this part, if you show in your application for certification that your projected balance of all emission-credit transactions in that model year is greater than or equal to zero or that a negative balance is allowed under § 1037.745.

(c) If you certify a vehicle family to an FEL that exceeds the otherwise applicable standard, you must obtain enough emission credits to offset the vehicle family's deficit by the due date for the final report required in § 1037.730. The emission credits used to address the deficit may come from your other vehicle families that generate emission credits in the same model year (or from later model years as specified in § 1037.745), from emission credits you have banked from previous model years, or from emission credits generated in the same or previous model years that you obtained through trading. Note that the option for using banked or traded credits does not apply for trailers.

#### § 1037.715 Banking.

(a) Banking is the retention of surplus emission credits by the manufacturer generating the emission credits for use in future model years for averaging or trading. Note that § 1037.107 does not allow banking for trailers.

(b) You may designate any emission credits you plan to bank in the reports you submit under § 1037.730 as reserved credits. During the model year and before the due date for the final report, you may designate your reserved

emission credits for averaging or trading.

(c) Reserved credits become actual emission credits when you submit your final report. However, we may revoke these emission credits if we are unable to verify them after reviewing your reports or auditing your records.

(d) Banked credits retain the designation of the averaging set in which they were generated.

#### § 1037.720 Trading.

(a) Trading is the exchange of emission credits between manufacturers, or the transfer of credits to another party to retire them. You may use traded emission credits for averaging, banking, or further trading transactions. Traded emission credits remain subject to the averaging-set restrictions based on the averaging set in which they were generated. Note that § 1037.107 does not allow trading for trailers.

(b) You may trade actual emission credits as described in this subpart. You may also trade reserved emission credits, but we may revoke these emission credits based on our review of your records or reports or those of the company with which you traded emission credits. You may trade banked credits within an averaging set to any certifying manufacturer.

(c) If a negative emission credit balance results from a transaction, both the buyer and seller are liable, except in cases we deem to involve fraud. See § 1037.255(e) for cases involving fraud. We may void the certificates of all vehicle families participating in a trade that results in a manufacturer having a negative balance of emission credits. See § 1037.745.

#### § 1037.725 What must I include in my application for certification?

(a) You must declare in your application for certification your intent to use the provisions of this subpart for each vehicle family that will be certified using the ABT program. You must also declare the FELs you select for the vehicle family or subfamily for each pollutant for which you are using the ABT program. Your FELs must comply with the specifications of subpart B of this part, including the FEL caps. FELs must be expressed to the same number of decimal places as the applicable standards.

(b) Include the following in your application for certification:

(1) A statement that, to the best of your belief, you will not have a negative balance of emission credits for any averaging set when all emission credits are calculated at the end of the year; or

a statement that you will have a negative balance of emission credits for one or more averaging sets but that it is allowed under § 1037.745.

(2) Calculations of projected emission credits (positive or negative) based on projected U.S.-directed production volumes. We may require you to include similar calculations from your other vehicle families to project your net credit balances for the model year. If you project negative emission credits for a family or subfamily, state the source of positive emission credits you expect to use to offset the negative emission credits.

#### § 1037.730 ABT reports.

(a) If any of your engine families are certified using the ABT provisions of this subpart, you must send an end-of-year report by March 31 following the end of the model year and a final report by September 30 following the end of the model year. We may waive the requirement to send an end-of-year report.

(b) Your end-of-year and final reports must include the following information for each vehicle family participating in the ABT program:

(1) Vehicle-family and subfamily designations, and averaging set.

(2) The regulatory subcategory and emission standards that would otherwise apply to the vehicle family.

(3) The FEL for each pollutant. If you change the FEL after the start of production, identify the date that you started using the new FEL and/or give the vehicle identification number for the first vehicle covered by the new FEL. In this case, identify each applicable FEL and calculate the positive or negative emission credits as specified in § 1037.225.

(4) The projected and actual U.S.-directed production volumes for the model year. If you changed an FEL during the model year, identify the actual U.S.-directed production volume associated with each FEL.

(5) Useful life.

(6) Calculated positive or negative emission credits for the whole vehicle family. Identify any emission credits that you traded, as described in paragraph (d)(1) of this section.

(7) If you have a negative credit balance for the averaging set in the given model year, specify whether the vehicle family (or certain subfamilies with the vehicle family) have a credit deficit for the year. Consider for example, a manufacturer with three vehicle families ("A", "B", and "C") in a given averaging set. If family A generates enough credits to offset the negative credits of family B but not

enough to also offset the negative credits of family C (and the manufacturer has no banked credits in the averaging set), the manufacturer may designate families A and B as having no deficit for the model year, provided it designates family C as having a deficit for the model year.

(c) Your end-of-year and final reports must include the following additional information:

(1) Show that your net balance of emission credits from all your participating vehicle families in each averaging set in the applicable model year is not negative, except as allowed under § 1037.745. Your credit tracking must account for the limitation on credit life under § 1037.740(c).

(2) State whether you will retain any emission credits for banking. If you choose to retire emission credits that would otherwise be eligible for banking, identify the families that generated the emission credits, including the number of emission credits from each family.

(3) State that the report's contents are accurate.

(4) Identify the technologies that make up the certified configuration associated with each vehicle identification number. You may identify this as a range of identification numbers for vehicles involving a single, identical certified configuration.

(d) If you trade emission credits, you must send us a report within 90 days after the transaction, as follows:

(1) As the seller, you must include the following information in your report:

(i) The corporate names of the buyer and any brokers.

(ii) A copy of any contracts related to the trade.

(iii) The averaging set corresponding to the vehicle families that generated emission credits for the trade, including the number of emission credits from each averaging set.

(2) As the buyer, you must include the following information in your report:

(i) The corporate names of the seller and any brokers.

(ii) A copy of any contracts related to the trade.

(iii) How you intend to use the emission credits, including the number of emission credits you intend to apply for each averaging set.

(e) Send your reports electronically to the Designated Compliance Officer using an approved information format. If you want to use a different format, send us a written request with justification for a waiver.

(f) Correct errors in your end-of-year or final report as follows:

(1) You may correct any errors in your end-of-year report when you prepare the

final report, as long as you send us the final report by the time it is due.

(2) If you or we determine within 270 days after the end of the model year that errors mistakenly decreased your balance of emission credits, you may correct the errors and recalculate the balance of emission credits. You may not make these corrections for errors that are determined more than 270 days after the end of the model year. If you report a negative balance of emission credits, we may disallow corrections under this paragraph (f)(2).

(3) If you or we determine any time that errors mistakenly increased your balance of emission credits, you must correct the errors and recalculate the balance of emission credits.

#### § 1037.735 Recordkeeping.

(a) You must organize and maintain your records as described in this section.

(b) Keep the records required by this section for at least eight years after the due date for the end-of-year report. You may not use emission credits for any vehicles if you do not keep all the records required under this section. You must therefore keep these records to continue to bank valid credits.

(c) Keep a copy of the reports we require in §§ 1037.725 and 1037.730.

(d) Keep records of the vehicle identification number for each vehicle you produce. You may identify these numbers as a range. If you change the FEL after the start of production, identify the date you started using each FEL and the range of vehicle identification numbers associated with each FEL. You must also identify the purchaser and destination for each vehicle you produce to the extent this information is available.

(e) We may require you to keep additional records or to send us relevant information not required by this section in accordance with the Clean Air Act.

#### § 1037.740 Restrictions for using emission credits.

The following restrictions apply for using emission credits:

(a) *Averaging sets.* Except as specified in paragraph (b) of this section, emission credits may be exchanged only within an averaging set. The following principal averaging sets apply for vehicles certified to the standards of this part involving emission credits as described in this subpart:

(1) Light HDV.

(2) Medium HDV.

(3) Heavy HDV.

(4) Long trailers.

(5) Short trailers.

(6) Note that other separate averaging sets also apply for emission credits not

related to this part. For example, vehicles certified to the greenhouse gas standards of 40 CFR 86.1819 comprise a single averaging set. Separate averaging sets also apply for engines under 40 CFR part 1036, including engines used in vehicles subject to this subpart.

(b) *Credits from hybrid vehicles and other advanced technologies.* Credits you generate under § 1037.615 from Phase 1 vehicles may be used for any of the averaging sets identified in paragraph (a) of this section; you may also use those credits to demonstrate compliance with the CO<sub>2</sub> emission standards in 40 CFR 86.1819 and 40 CFR part 1036. Similarly, you may use advanced-technology credits generated under 40 CFR 86.1819–14(k)(7) or 40 CFR 1036.615 to demonstrate compliance with the CO<sub>2</sub> standards in this part. Credits generated from Phase 2 vehicles are subject to all the averaging-set restrictions that apply to other emission credits.

(1) The maximum amount of credits you may bring into the following service class groups is 60,000 Mg per model year:

(i) Spark-ignition engines, light heavy-duty compression-ignition engines, and light heavy-duty vehicles. This group comprises the averaging set listed in paragraphs (a)(1) of this section and the averaging set listed in 40 CFR 1036.740(a)(1) and (2).

(ii) Medium heavy-duty compression-ignition engines and medium heavy-duty vehicles. This group comprises the averaging sets listed in paragraph (a)(2) of this section and 40 CFR 1036.740(a)(3).

(iii) Heavy heavy-duty compression-ignition engines and heavy heavy-duty vehicles. This group comprises the averaging sets listed in paragraph (a)(3) of this section and 40 CFR 1036.740(a)(4).

(2) Paragraph (b)(1) of this section does not limit the advanced-technology credits that can be used within a service class group if they were generated in that same service class group.

(c) *Credit life.* Banked credits may be used only for five model years after the year in which they are generated. For example, credits you generate in model year 2018 may be used to demonstrate compliance with emission standards only through model year 2023.

(d) *Other restrictions.* Other sections of this part specify additional restrictions for using emission credits under certain special provisions.

#### § 1037.745 End-of-year CO<sub>2</sub> credit deficits.

Except as allowed by this section, we may void the certificate of any vehicle

family certified to an FEL above the applicable standard for which you do not have sufficient credits by the deadline for submitting the final report.

(a) Your certificate for a vehicle family for which you do not have sufficient CO<sub>2</sub> credits will not be void if you remedy the deficit with surplus credits within three model years (this applies equally for tractors, trailers, and vocational vehicles). For example, if you have a credit deficit of 500 Mg for a vehicle family at the end of model year 2015, you must generate (or otherwise obtain) a surplus of at least 500 Mg in that same averaging set by the end of model year 2018.

(b) You may not bank or trade away CO<sub>2</sub> credits in the averaging set in any model year in which you have a deficit.

(c) You may apply only surplus credits to your deficit. You may not apply credits to a deficit from an earlier model year if they were generated in a model year for which any of your vehicle families for that averaging set had an end-of-year credit deficit.

(d) You must notify us in writing how you plan to eliminate the credit deficit within the specified time frame. If we determine that your plan is unreasonable or unrealistic, we may deny an application for certification for a vehicle family if its FEL would increase your credit deficit. We may determine that your plan is unreasonable or unrealistic based on a consideration of past and projected use of specific technologies, the historical sales mix of your vehicle models, your commitment to limit production of higher-emission vehicles, and expected access to traded credits. We may also consider your plan unreasonable if your credit deficit increases from one model year to the next. We may require that you send us interim reports describing your progress toward resolving your credit deficit over the course of a model year.

(e) If you do not remedy the deficit with surplus credits within three model years, we may void your certificate for that vehicle family. Note that voiding a certificate applies *ab initio*. Where the net deficit is less than the total amount of negative credits originally generated by the family, we will void the certificate only with respect to the number of vehicles needed to reach the amount of the net deficit. For example, if the original vehicle family generated 500 Mg of negative credits, and the manufacturer's net deficit after three years was 250 Mg, we would void the certificate with respect to half of the vehicles in the family.

(f) For purposes of calculating the statute of limitations, the following

actions are all considered to occur at the expiration of the deadline for offsetting a deficit as specified in paragraph (a) of this section:

(1) Failing to meet the requirements of paragraph (a) of this section.

(2) Failing to satisfy the conditions upon which a certificate was issued relative to offsetting a deficit.

(3) Selling, offering for sale, introducing or delivering into U.S. commerce, or importing vehicles that are found not to be covered by a certificate as a result of failing to offset a deficit.

#### **§ 1037.750 What can happen if I do not comply with the provisions of this subpart?**

(a) For each vehicle family participating in the ABT program, the certificate of conformity is conditioned upon full compliance with the provisions of this subpart during and after the model year. You are responsible to establish to our satisfaction that you fully comply with applicable requirements. We may void the certificate of conformity for a vehicle family if you fail to comply with any provisions of this subpart.

(b) You may certify your vehicle family or subfamily to an FEL above an applicable standard based on a projection that you will have enough emission credits to offset the deficit for the vehicle family. See § 1037.745 for provisions specifying what happens if you cannot show in your final report that you have enough actual emission credits to offset a deficit for any pollutant in a vehicle family.

(c) We may void the certificate of conformity for a vehicle family if you fail to keep records, send reports, or give us information we request. Note that failing to keep records, send reports, or give us information we request is also a violation of 42 U.S.C. 7522(a)(2).

(d) You may ask for a hearing if we void your certificate under this section (see § 1037.820).

#### **§ 1037.755 Information provided to the Department of Transportation.**

After receipt of each manufacturer's final report as specified in § 1037.730 and completion of any verification testing required to validate the manufacturer's submitted final data, we will issue a report to the Department of Transportation with CO<sub>2</sub> emission information and will verify the accuracy of each manufacturer's equivalent fuel consumption data required by NHTSA under 49 CFR 535.8. We will send a report to DOT for each vehicle manufacturer based on each regulatory category and subcategory, including sufficient information for NHTSA to

determine fuel consumption and associated credit values. See 49 CFR 535.8 to determine if NHTSA deems submission of this information to EPA to also be a submission to NHTSA.

### **Subpart I—Definitions and Other Reference Information**

#### **§ 1037.801 Definitions.**

The following definitions apply to this part. The definitions apply to all subparts unless we note otherwise. All undefined terms have the meaning the Act gives to them. The definitions follow:

*Act* means the Clean Air Act, as amended, 42 U.S.C. 7401–7671q.

*Adjustable parameter* means any device, system, or element of design that someone can adjust (including those which are difficult to access) and that, if adjusted, may affect measured or modeled emissions (as applicable). You may ask us to exclude a parameter that is difficult to access if it cannot be adjusted to affect emissions without significantly degrading vehicle performance, or if you otherwise show us that it will not be adjusted in a way that affects emissions during in-use operation.

*Adjusted Loaded Vehicle Weight* means the numerical average of vehicle curb weight and GVWR.

*Advanced technology* means vehicle technology certified under 40 CFR 86.1819–14(k)(7), 40 CFR 1036.615, or § 1037.615.

*Aftertreatment* means relating to a catalytic converter, particulate filter, or any other system, component, or technology mounted downstream of the exhaust valve (or exhaust port) whose design function is to decrease emissions in the vehicle exhaust before it is exhausted to the environment. Exhaust gas recirculation (EGR) and turbochargers are not aftertreatment.

*Aircraft* means any vehicle capable of sustained air travel more than 100 feet off the ground.

*Alcohol-fueled vehicle* means a vehicle that is designed to run using an alcohol fuel. For purposes of this definition, alcohol fuels do not include fuels with a nominal alcohol content below 25 percent by volume.

*Alternative fuel conversion* has the meaning given for clean alternative fuel conversion in 40 CFR 85.502.

*Ambulance* has the meaning given in 40 CFR 86.1803.

*Amphibious vehicle* means a motor vehicle that is also designed for operation on water. Note that high ground clearance that enables a vehicle to drive through water rather than floating on the water does not make a vehicle amphibious.

*A to B testing* means testing performed in pairs to allow comparison of two vehicles or other test articles. Back-to-back tests are performed on Article A and Article B, changing only the variable(s) of interest for the two tests.

*Automated manual transmission (AMT)* means a transmission that operates mechanically similar to a manual transmission, except that an automated clutch actuator controlled by the onboard computer disengages and engages the drivetrain instead of a human driver. An automated manual transmission does not include a torque converter or a clutch pedal controllable by the driver.

*Automatic tire inflation system* means a pneumatically or electronically activated system installed on a vehicle to maintain tire pressure at a preset level. These systems eliminate the need to manually inflate tires. Note that this is different than a “*tire pressure monitoring system*,” which we define separately in this section.

*Automatic transmission (AT)* means a transmission with a torque converter (or equivalent) that uses computerize or other internal controls to shift gears in response to a single driver input for controlling vehicle speed. Note that automatic manual transmissions are not automatic transmissions because they do not include torque converters.

*Auxiliary emission control device* means any element of design that senses temperature, motive speed, engine rpm, transmission gear, or any other parameter for the purpose of activating, modulating, delaying, or deactivating the operation of any part of the emission control system.

*Auxiliary power unit* means a device installed on a vehicle that uses an engine to provide power for purposes other than to (directly or indirectly) propel the vehicle.

*Averaging set* has the meaning given in § 1037.701.

*Axle ratio or Drive axle ratio,  $k_a$* , means the dimensionless number representing the angular speed of the transmission output shaft divided by the angular speed of the drive axle.

*Basic vehicle frontal area* means the area enclosed by the geometric projection of the basic vehicle along the longitudinal axis onto a plane perpendicular to the longitudinal axis of the vehicle, including tires but excluding mirrors and air deflectors. Note that in certain cases, this may refer to the combined area of a tractor and trailer.

*Box van* has the meaning given in the definition for “trailer” in this section.

*Bus* means a heavy-duty vehicle designed to carry more than 15 passengers. Buses may include coach buses, school buses, and urban transit buses.

*Calibration* means the set of specifications and tolerances specific to a particular design, version, or application of a component or assembly capable of functionally describing its operation over its working range.

*Carryover* means relating to certification based on emission data generated from an earlier model year.

*Coach bus* means a bus designed for inter-city passenger transport. Buses with features to accommodate standing passengers are not coach buses.

*Concrete mixer* means a heavy-duty vehicle designed to mix and transport concrete in a permanently mounted revolving drum.

*Certification* means relating to the process of obtaining a certificate of conformity for a vehicle family that complies with the emission standards and requirements in this part.

*Certified emission level* means the highest deteriorated emission level in a vehicle subfamily for a given pollutant from either transient or steady-state testing.

*Class* means relating to GVWR classes for vehicles other than trailers, as follows:

(1) *Class 2b* means relating to heavy-duty motor vehicles at or below 10,000 pounds GVWR.

(2) *Class 3* means relating to heavy-duty motor vehicles above 10,000 pounds GVWR but at or below 14,000 pounds GVWR.

(3) *Class 4* means relating to heavy-duty motor vehicles above 14,000 pounds GVWR but at or below 16,000 pounds GVWR.

(4) *Class 5* means relating to heavy-duty motor vehicles above 16,000 pounds GVWR but at or below 19,500 pounds GVWR.

(5) *Class 6* means relating to heavy-duty motor vehicles above 19,500 pounds GVWR but at or below 26,000 pounds GVWR.

(6) *Class 7* means relating to heavy-duty motor vehicles above 26,000 pounds GVWR but at or below 33,000 pounds GVWR.

(7) *Class 8* means relating to heavy-duty motor vehicles above 33,000 pounds GVWR.

*Complete vehicle* has the meaning given in the definition for *vehicle* in this section.

*Compression-ignition* has the meaning given in § 1037.101

*Container chassis* means a trailer designed for carrying temporarily mounted shipping containers.

*Date of manufacture* means the date on which the certifying vehicle manufacturer completes its manufacturing operations, except as follows:

(1) Where the certificate holder is an engine manufacturer that does not manufacture the chassis, the date of manufacture of the vehicle is based on the date assembly of the vehicle is completed.

(2) We may approve an alternate date of manufacture based on the date on which the certifying (or primary) manufacturer completes assembly at the place of main assembly, consistent with the provisions of § 1037.601 and 49 CFR 567.4.

*Day cab* means a type of tractor cab that is not a sleeper cab or a heavy-haul tractor cab.

*Designated Compliance Officer* means one of the following:

(1) For compression-ignition engines, *Designated Compliance Officer* means Director, Diesel Engine Compliance Center, U.S. Environmental Protection Agency, 2000 Traverwood Drive, Ann Arbor, MI 48105; *complianceinfo@epa.gov*; *epa.gov/otaq/verify*.

(2) For spark-ignition engines, *Designated Compliance Officer* means Director, Gasoline Engine Compliance Center, U.S. Environmental Protection Agency, 2000 Traverwood Drive, Ann Arbor, MI 48105; *nonroad-si-cert@epa.gov*.

*Deteriorated emission level* means the emission level that results from applying the appropriate deterioration factor to the official emission result of the emission-data vehicle. Note that where no deterioration factor applies, references in this part to the *deteriorated emission level* mean the official emission result.

*Deterioration factor* means the relationship between the highest emissions during the useful life and emissions at the low-hour test point, expressed in one of the following ways:

(1) For multiplicative deterioration factors, the ratio of the highest emissions to emissions at the low-hour test point.

(2) For additive deterioration factors, the difference between the highest emissions and emissions at the low-hour test point.

*Diesel exhaust fluid (DEF)* means a liquid reducing agent (other than the engine fuel) used in conjunction with selective catalytic reduction to reduce NO<sub>x</sub> emissions. *Diesel exhaust fluid* is generally understood to be an aqueous solution of urea conforming to the specifications of ISO 22241.

*Drayage tractor* means a tractor that is intended for service in a port or

intermodal railyard, with multiple design features consistent with that intent, such as a cab with only a single seat, rear cab entry, a raisable fifth wheel, a solid-mounted rear suspension, and a maximum speed at or below 54 mi/hr.

*Drive idle* means idle operation during which the vehicle operator remains in the vehicle cab, as evidenced by engaging the brake or clutch pedals, or by other indicators we approve.

*Driver model* means an automated controller that simulates a person driving a vehicle.

*Dual-clutch transmission (DCT)* means a transmission that operates similar to an automated manual transmission, but with two clutches that allow the transmission to maintain positive torque to the drive axle during a shift.

*Dual-fuel* means relating to a vehicle or engine designed for operation on two different fuels but not on a continuous mixture of those fuels. For purposes of this part, such a vehicle or engine remains a dual-fuel vehicle or engine even if it is designed for operation on three or more different fuels.

*Electric vehicle* means a vehicle that does not include an engine, and is powered solely by an external source of electricity and/or solar power. Note that this does not include hybrid electric vehicles or fuel-cell vehicles that use a chemical fuel such as gasoline, diesel fuel, or hydrogen. Electric vehicles may also be referred to as all-electric vehicles to distinguish them from hybrid vehicles.

*Emergency vehicle* means a vehicle that is an ambulance or a fire truck.

*Emission control system* means any device, system, or element of design that controls or reduces the emissions of regulated pollutants from a vehicle.

*Emission-data component* means a vehicle component that is tested for certification. This includes vehicle components tested to establish deterioration factors.

*Emission-data vehicle* means a vehicle (or vehicle component) that is tested for certification. This includes vehicles tested to establish deterioration factors.

*Emission-related maintenance* means maintenance that substantially affects emissions or is likely to substantially affect emission deterioration.

*Excluded* means relating to vehicles that are not subject to some or all of the requirements of this part as follows:

(1) A vehicle that has been determined not to be a "motor vehicle" is excluded from this part.

(2) Certain vehicles are excluded from the requirements of this part under § 1037.5.

(3) Specific regulatory provisions of this part may exclude a vehicle generally subject to this part from one or more specific standards or requirements of this part.

*Exempted* has the meaning given in 40 CFR 1068.30. Note that exempted vehicles are not considered to be excluded.

*Extended idle* means tractor idle operation during which the engine is operating to power accessories for a sleeper compartment or other passenger compartment. Although the vehicle is generally parked during extended idle, the term "parked idle" generally refers to something different than extended idle.

*Family emission limit (FEL)* means an emission level declared by the manufacturer to serve in place of an otherwise applicable emission standard under the ABT program in subpart H of this part. The family emission limit must be expressed to the same number of decimal places as the emission standard it replaces. Note that an FEL may apply as a "subfamily" emission limit.

*Final drive ratio,  $k_d$* , means the dimensionless number representing the angular speed of the transmission input shaft divided by the angular speed of the drive axle when the vehicle is operating in its highest available gear. The final drive ratio is the transmission gear ratio (in the highest available gear) multiplied by the drive axle ratio.

*Fire truck* has the meaning given in 40 CFR 86.1803.

*Flatbed trailer* means a trailer designed to accommodate side-loading cargo onto a single, continuous load-bearing surface that runs from the rear of the trailer to at least the trailer's kingpin. This includes trailers that use curtains, straps, or other devices to restrain or protect cargo while underway. It also may include similar trailers that have one or more side walls without completely enclosing the cargo space. For purposes of this definition, disregard any ramps, moveable platforms, or other rear-mounted equipment or devices designed to assist with loading the trailer.

*Flexible-fuel* means relating to an engine designed for operation on any mixture of two or more different fuels.

*Fuel system* means all components involved in transporting, metering, and mixing the fuel from the fuel tank to the combustion chamber(s), including the fuel tank, fuel pump, fuel filters, fuel lines, carburetor or fuel-injection components, and all fuel-system vents.

It also includes components for controlling evaporative emissions, such as fuel caps, purge valves, and carbon canisters.

*Fuel type* means a general category of fuels such as diesel fuel or natural gas. There can be multiple grades within a single fuel type, such as high-sulfur or low-sulfur diesel fuel.

*Gaseous fuel* means a fuel that has a boiling point below 20 °C.

*Gear ratio or Transmission gear ratio,  $k_g$* , means the dimensionless number representing the angular velocity of the transmission's input shaft divided by the angular velocity of the transmission's output shaft when the transmission is operating in a specific gear.

*Glider kit* means either of the following:

(1) A new vehicle that is incomplete because it lacks an engine, transmission, and/or axle(s).

(2) Any other new equipment that is substantially similar to a complete motor vehicle and is intended to become a complete motor vehicle with a previously used engine (including a rebuilt or remanufactured engine). For example, incomplete heavy-duty tractor assemblies that are produced on the same assembly lines as complete tractors and that are made available to secondary vehicle manufacturers to complete assembly by installing used/remanufactured engines, transmissions and axles are glider kits.

*Glider vehicle* means a new motor vehicle produced from a glider kit, or otherwise produced as a new motor vehicle with a used/remanufactured engine.

*Good engineering judgment* has the meaning given in 40 CFR 1068.30. See 40 CFR 1068.5 for the administrative process we use to evaluate good engineering judgment.

*Greenhouse gas Emissions Model (GEM)* means the GEM simulation tool described in § 1037.520 (incorporated by reference in § 1037.810). Note that an updated version of GEM applies starting in model year 2021.

*Gross axle weight rating (GAWR)* means the value specified by the vehicle manufacturer as the maximum weight of a loaded axle or set of axles, consistent with good engineering judgment.

*Gross combination weight rating (GCWR)* means the value specified by the vehicle manufacturer as the maximum weight of a loaded vehicle and trailer, consistent with good engineering judgment. For example, compliance with SAE J2807 is generally considered to be consistent with good engineering judgment, especially for Class 3 and smaller vehicles.



*Gross vehicle weight rating (GVWR)* means the value specified by the vehicle manufacturer as the maximum design loaded weight of a single vehicle, consistent with good engineering judgment.

*Heavy-duty engine* means any engine used for (or for which the engine manufacturer could reasonably expect to be used for) motive power in a heavy-duty vehicle.

*Heavy-duty vehicle* means any trailer and any other motor vehicle that has a GVWR above 8,500 pounds, a curb weight above 6,000 pounds, or a basic vehicle frontal area greater than 45 square feet.

*Heavy-haul tractor* means a tractor with GCWR greater than or equal to 120,000 pounds. A heavy-haul tractor is not a vocational tractor in Phase 2.

*Hybrid engine or hybrid powertrain* means an engine or powertrain that includes energy storage features other than a conventional battery system or conventional flywheel. Supplemental electrical batteries and hydraulic accumulators are examples of hybrid energy storage systems. Note that certain provisions in this part treat hybrid engines and powertrains intended for vehicles that include regenerative braking different than those intended for vehicles that do not include regenerative braking.

*Hybrid vehicle* means a vehicle that includes energy storage features (other than a conventional battery system or conventional flywheel) in addition to an internal combustion engine or other engine using consumable chemical fuel. Supplemental electrical batteries and hydraulic accumulators are examples of hybrid energy storage systems. Note that certain provisions in this part treat hybrid vehicles that include regenerative braking different than those that do not include regenerative braking.

*Hydrocarbon (HC)* means the hydrocarbon group on which the emission standards are based for each fuel type. For alcohol-fueled vehicles, HC means nonmethane hydrocarbon equivalent (NMHCE) for exhaust emissions and total hydrocarbon equivalent (THCE) for evaporative emissions. For all other vehicles, HC means nonmethane hydrocarbon (NMHC) for exhaust emissions and total hydrocarbon (THC) for evaporative emissions.

*Identification number* means a unique specification (for example, a model number/serial number combination) that allows someone to distinguish a particular vehicle from other similar vehicles.

*Idle operation* means any operation other than PTO operation during which

the vehicle speed is zero. Idle operation may be "Drive idle" or "Parked idle" (as defined in this section).

*Incomplete vehicle* has the meaning given in the definition of *vehicle* in this section.

*Innovative technology* means technology certified under § 1037.610 (also described as "off-cycle technology").

*Light-duty truck* means any motor vehicle rated at or below 8,500 pounds GVWR with a curb weight at or below 6,000 pounds and basic vehicle frontal area at or below 45 square feet, which is:

(1) Designed primarily for purposes of transportation of property or is a derivation of such a vehicle; or

(2) Designed primarily for transportation of persons and has a capacity of more than 12 persons; or

(3) Available with special features enabling off-street or off-highway operation and use.

*Light-duty vehicle* means a passenger car or passenger car derivative capable of seating 12 or fewer passengers.

*Low-mileage* means relating to a vehicle with stabilized emissions and represents the undeteriorated emission level. This would generally involve approximately 4000 miles of operation.

*Low rolling resistance tire* means a tire on a vocational vehicle with a TRRL at or below of 7.7 kg/tonne, a steer tire on a tractor with a TRRL at or below 7.7 kg/tonne, a drive tire on a tractor with a TRRL at or below 8.1 kg/tonne, a tire on a non-box trailer with a TRRL at or below of 6.5 kg/tonne, or a tire on a box van with a TRRL at or below of 6.0 kg/tonne.

*Manual transmission (MT)* means a transmission that requires the driver to shift the gears and manually engage and disengage the clutch.

*Manufacture* means the physical and engineering process of designing, constructing, and/or assembling a vehicle.

*Manufacturer* has the meaning given in section 216(1) of the Act. In general, this term includes any person who manufactures or assembles a vehicle (including a trailer or another incomplete vehicle) for sale in the United States or otherwise introduces a new motor vehicle into commerce in the United States. This includes importers who import vehicles for resale, entities that manufacture glider kits, and entities that assemble glider vehicles.

*Medium-duty passenger vehicle (MDPV)* has the meaning given in 40 CFR 86.1803.

*Model year* means one of the following for compliance with this part 1037. Note that manufacturers may have

other model year designations for the same vehicle for compliance with other requirements or for other purposes:

(1) For tractors and vocational vehicles with a date of manufacture on or after January 1, 2021, the vehicle's *model year* is the calendar year corresponding to the date of manufacture; however, the vehicle's model year may be designated to be the year before the calendar year corresponding to the date of manufacture if the engine's model year is also from an earlier year. Note that § 1037.601(a)(2) limits the extent to which vehicle manufacturers may install engines built in earlier calendar years.

(2) For trailers and for Phase 1 tractors and vocational vehicles with a date of manufacture before January 1, 2021, *model year* means the manufacturer's annual new model production period, except as restricted under this definition and 40 CFR part 85, subpart X. It must include January 1 of the calendar year for which the model year is named, may not begin before January 2 of the previous calendar year, and it must end by December 31 of the named calendar year. The model year may be set to match the calendar year corresponding to the date of manufacture.

(i) The manufacturer who holds the certificate of conformity for the vehicle must assign the model year based on the date when its manufacturing operations are completed relative to its annual model year period. In unusual circumstances where completion of your assembly is delayed, we may allow you to assign a model year one year earlier, provided it does not affect which regulatory requirements will apply.

(ii) Unless a vehicle is being shipped to a secondary vehicle manufacturer that will hold the certificate of conformity, the model year must be assigned prior to introduction of the vehicle into U.S. commerce. The certifying manufacturer must redesignate the model year if it does not complete its manufacturing operations within the originally identified model year. A vehicle introduced into U.S. commerce without a model year is deemed to have a model year equal to the calendar year of its introduction into U.S. commerce unless the certifying manufacturer assigns a later date.

*Motor home* has the meaning given in 49 CFR 571.3.

*Motor vehicle* has the meaning given in 40 CFR 85.1703.

*Multi-Purpose* means relating to the Multi-Purpose duty cycle as specified in § 1037.510.



*Neutral coasting* means a vehicle technology that automatically puts the transmission in neutral when the vehicle has minimal power demand, such as driving downhill.

*Neutral idle* means a vehicle technology that automatically puts the transmission in neutral when the vehicle is stopped, as described in § 1037.660(a).

*New motor vehicle* has the meaning given in the Act. It generally means a motor vehicle meeting the criteria of either paragraph (1) or (2) of this definition. *New motor vehicles* may be complete or incomplete.

(1) A motor vehicle for which the ultimate purchaser has never received the equitable or legal title is a *new motor vehicle*. This kind of vehicle might commonly be thought of as “brand new” although a *new motor vehicle* may include previously used parts. For example, vehicles commonly known as “glider kits,” “glider vehicles,” or “gliders” are new motor vehicles. Under this definition, the vehicle is new from the time it is produced until the ultimate purchaser receives the title or places it into service, whichever comes first.

(2) An imported heavy-duty motor vehicle originally produced after the 1969 model year is a *new motor vehicle*.

*Noncompliant vehicle* means a vehicle that was originally covered by a certificate of conformity, but is not in the certified configuration or otherwise does not comply with the conditions of the certificate.

*Nonconforming vehicle* means a vehicle not covered by a certificate of conformity that would otherwise be subject to emission standards.

*Nonmethane hydrocarbon (NMHC)* means the sum of all hydrocarbon species except methane, as measured according to 40 CFR part 1065.

*Nonmethane hydrocarbon equivalent (NMHCE)* has the meaning given in 40 CFR 1065.1001.

*Off-cycle technology* means technology certified under § 1037.610 (also described as “innovative technology”).

*Official emission result* means the measured emission rate for an emission-data vehicle on a given duty cycle before the application of any required deterioration factor, but after the applicability of regeneration adjustment factors.

*Owners manual* means a document or collection of documents prepared by the vehicle manufacturer for the owners or operators to describe appropriate vehicle maintenance, applicable warranties, and any other information related to operating or keeping the

vehicle. The owners manual is typically provided to the ultimate purchaser at the time of sale. The owners manual may be in paper or electronic format.

*Oxides of nitrogen* has the meaning given in 40 CFR 1065.1001.

*Parked idle* means idle operation during which the transmission is set to park, or the transmission is in neutral with the parking brake engaged. Although this idle may occur for extended periods, the term “extended idle” refers to tractor operation in which the engine is operating to power accessories for a sleeper compartment or other passenger compartment.

*Particulate trap* means a filtering device that is designed to physically trap all particulate matter above a certain size.

*Percent (%)* has the meaning given in 40 CFR 1065.1001. Note that this means percentages identified in this part are assumed to be infinitely precise without regard to the number of significant figures. For example, one percent of 1,493 is 14.93.

*Petroleum* means gasoline or diesel fuel or other fuels normally derived from crude oil. This does not include methane or liquefied petroleum gas.

*Phase 1* means relating to the Phase 1 standards specified in §§ 1037.105 and 1037.106. For example, a vehicle subject to the Phase 1 standards is a Phase 1 vehicle. Note that there are no Phase 1 standards for trailers.

*Phase 2* means relating to the Phase 2 standards specified in §§ 1037.105 through 1037.107.

*Placed into service* means put into initial use for its intended purpose, excluding incidental use by the manufacturer or a dealer.

*Power take-off (PTO)* means a secondary engine shaft (or equivalent) that provides substantial auxiliary power for purposes unrelated to vehicle propulsion or normal vehicle accessories such as air conditioning, power steering, and basic electrical accessories. A typical PTO uses a secondary shaft on the engine to transmit power to a hydraulic pump that powers auxiliary equipment, such as a boom on a bucket truck. You may ask us to consider other equivalent auxiliary power configurations (such as those with hybrid vehicles) as power take-off systems.

*Preliminary approval* means approval granted by an authorized EPA representative prior to submission of an application for certification, consistent with the provisions of § 1037.210 or 1037.211.

*Rechargeable Energy Storage System (RESS)* means the component(s) of a hybrid engine or vehicle that store

recovered energy for later use, such as the battery system in an electric hybrid vehicle.

*Refuse hauler* means a heavy-duty vehicle whose primary purpose is to collect, compact, and transport solid waste, including recycled solid waste.

*Regional* means relating to the Regional duty cycle as specified in § 1037.510.

*Regulatory subcategory* has the meaning given in § 1037.230.

*Relating to* as used in this section means relating to something in a specific, direct manner. This expression is used in this section only to define terms as adjectives and not to broaden the meaning of the terms.

*Revoke* has the meaning given in 40 CFR 1068.30.

*Roof height* means the maximum height of a vehicle (rounded to the nearest inch), excluding narrow accessories such as exhaust pipes and antennas, but including any wide accessories such as roof fairings. Measure roof height of the vehicle configured to have its maximum height that will occur during actual use, with properly inflated tires and no driver, passengers, or cargo onboard. *Roof height* may also refer to the following categories:

(1) Low-roof means relating to a vehicle with a roof height of 120 inches or less.

(2) Mid-roof means relating to a vehicle with a roof height of 121 to 147 inches.

(3) High-roof means relating to a vehicle with a roof height of 148 inches or more.

*Round* has the meaning given in 40 CFR 1065.1001.

*Scheduled maintenance* means adjusting, repairing, removing, disassembling, cleaning, or replacing components or systems periodically to keep a part or system from failing, malfunctioning, or wearing prematurely. It also may mean actions you expect are necessary to correct an overt indication of failure or malfunction for which periodic maintenance is not appropriate.

*School bus* has the meaning given in 49 CFR 571.3.

*Secondary vehicle manufacturer* anyone that produces a vehicle by modifying a complete vehicle or completing the assembly of a partially complete vehicle. For the purpose of this definition, “modifying” generally does not include making changes that do not remove a vehicle from its original certified configuration. However, custom sleeper modifications and alternative fuel conversions that change actual vehicle aerodynamics are

considered to be modifications, even if they are permitted without recertification. This definition applies whether the production involves a complete or partially complete vehicle and whether the vehicle was previously certified to emission standards or not. Manufacturers controlled by the manufacturer of the base vehicle (or by an entity that also controls the manufacturer of the base vehicle) are not secondary vehicle manufacturers; rather, both entities are considered to be one manufacturer for purposes of this part.

*Sleeper cab* means a type of tractor cab that has a compartment behind the driver's seat intended to be used by the driver for sleeping, and is not a heavy-haul tractor cab. This includes cabs accessible from the driver's compartment and those accessible from outside the vehicle.

*Small manufacturer* means a manufacturer meeting the criteria specified in 13 CFR 121.201. The employee and revenue limits apply to the total number employees and total revenue together for affiliated companies.

*Spark-ignition* has the meaning given in § 1037.101.

*Standard payload* means the payload assumed for each vehicle, in tons, for modeling and calculating emission credits, as follows:

(1) For vocational vehicles:

- (i) 2.85 tons for Light HDV.
- (ii) 5.6 tons for Medium HDV.
- (iii) 7.5 tons for Heavy HDV.

(2) For tractors:

- (i) 12.5 tons for Class 7.
- (ii) 19 tons for Class 8, other than

heavy-haul tractors.

- (iii) 43 tons for heavy-haul tractors.

(3) For trailers:

- (i) 10 tons for short box vans.
- (ii) 19 tons for other trailers.

*Standard tractor* has the meaning given in § 1037.501.

*Standard trailer* has the meaning given in § 1037.501.

*Stop-start* means a vehicle technology that automatically turns the engine off when the vehicle is stopped, as described in § 1037.660(a).

*Suspend* has the meaning given in 40 CFR 1068.30.

*Tank trailer* means a trailer designed to transport liquids or gases.

*Test sample* means the collection of vehicles or components selected from the population of a vehicle family for emission testing. This may include testing for certification, production-line testing, or in-use testing.

*Test vehicle* means a vehicle in a test sample.

*Test weight* means the vehicle weight used or represented during testing.

*Tire pressure monitoring system (TPMS)* is a vehicle system that monitors air pressure in each tire and alerts the operator when tire pressure falls below a specified value.

*Tire rolling resistance level (TRRL)* means a value with units of kg/tonne that represents the rolling resistance of a tire configuration. TRRLs are used as modeling inputs under §§ 1037.515 and 1037.520. Note that a manufacturer may use the measured value for a tire configuration's coefficient of rolling resistance, or assign some higher value.

*Total hydrocarbon* has the meaning given in 40 CFR 1065.1001. This generally means the combined mass of organic compounds measured by the specified procedure for measuring total hydrocarbon, expressed as a hydrocarbon with an atomic hydrogen-to-carbon ratio of 1.85:1.

*Total hydrocarbon equivalent* has the meaning given in 40 CFR 1065.1001. This generally means the sum of the carbon mass contributions of non-oxygenated hydrocarbon, alcohols and aldehydes, or other organic compounds that are measured separately as contained in a gas sample, expressed as exhaust hydrocarbon from petroleum-fueled vehicles. The atomic hydrogen-to-carbon ratio of the equivalent hydrocarbon is 1.85:1.

*Tractor* has the meaning given for "truck tractor" in 49 CFR 571.3. This includes most heavy-duty vehicles specifically designed for the primary purpose of pulling trailers, but does not include vehicles designed to carry other loads. For purposes of this definition "other loads" would not include loads carried in the cab, sleeper compartment, or toolboxes. Examples of vehicles that are similar to tractors but that are not tractors under this part include dromedary tractors, automobile haulers, straight trucks with trailers hitches, and tow trucks. Note that the provisions of this part that apply for tractors do not apply for tractors that are classified as vocational tractors under § 1037.630.

*Trailer* means a piece of equipment designed for carrying cargo and for being drawn by a tractor when coupled to the tractor's fifth wheel. These trailers may be known commercially as semi-trailers or truck trailers. This definition excludes equipment that serve similar purposes but are not intended to be pulled by a tractor, whether or not they are known commercially as trailers. Trailers may be divided into different types and categories as described in paragraphs (1) through (4) of this definition. The types of equipment identified in paragraph (5) of this definition are not trailers for purposes of this part.

(1) Box vans are trailers with enclosed cargo space that is permanently attached to the chassis, with fixed sides, nose, and roof. Tank trailers are not box vans.

(2) Box vans with self-contained HVAC systems are refrigerated vans. Note that this includes systems that provide cooling, heating, or both. All other box vans are dry vans.

(3) Trailers that are not box vans are non-box trailers. Note that the standards for non-box trailers in this part 1037 apply only to flatbed trailers, tank trailers, and container chassis.

(4) Box vans with length at or below 50.0 feet are short box vans. Other box vans are long box vans.

(5) The following types of equipment are not trailers for purposes of this part 1037:

(i) Containers that are not permanently mounted on chassis.

(ii) Dollies used to connect tandem trailers.

*Ultimate purchaser* means, with respect to any new vehicle, the first person who in good faith purchases such new vehicle for purposes other than resale.

*United States* has the meaning given in 40 CFR 1068.30.

*Upcoming model year* means for a vehicle family the model year after the one currently in production.

*Urban* means relating to the Urban duty cycle as specified in § 1037.510.

*U.S.-directed production volume* means the number of vehicle units, subject to the requirements of this part, produced by a manufacturer for which the manufacturer has a reasonable assurance that sale was or will be made to ultimate purchasers in the United States. This does not include vehicles certified to state emission standards that are different than the emission standards in this part.

*Useful life* means the period during which a vehicle is required to comply with all applicable emission standards.

*Vehicle* means equipment intended for use on highways that meets at least one of the criteria of paragraph (1) of this definition, as follows:

(1) The following equipment are vehicles:

(i) A piece of equipment that is intended for self-propelled use on highways becomes a vehicle when it includes at least an engine, a transmission, and a frame. (Note: For purposes of this definition, any electrical, mechanical, and/or hydraulic devices attached to engines for the purpose of powering wheels are considered to be transmissions.)

(ii) A piece of equipment that is intended for self-propelled use on highways becomes a vehicle when it

includes a passenger compartment attached to a frame with one or more axles.

(iii) Trailers. A trailer becomes a vehicle when it has a frame with one or more axles attached.

(2) Vehicles other than trailers may be complete or incomplete vehicles as follows:

(i) A *complete vehicle* is a functioning vehicle that has the primary load carrying device or container (or equivalent equipment) attached. Examples of equivalent equipment would include fifth wheel trailer hitches, firefighting equipment, and utility booms.

(ii) An *incomplete vehicle* is a vehicle that is not a complete vehicle. Incomplete vehicles may also be cab-complete vehicles. This may include vehicles sold to secondary vehicle manufacturers.

(iii) The primary use of the terms “complete vehicle” and “incomplete vehicle” are to distinguish whether a vehicle is complete when it is first sold as a vehicle.

(iv) You may ask us to allow you to certify a vehicle as incomplete if you manufacture the engines and sell the unassembled chassis components, as long as you do not produce and sell the body components necessary to complete the vehicle.

*Vehicle configuration* means a unique combination of vehicle hardware and calibration (related to measured or modeled emissions) within a vehicle family. Vehicles with hardware or

software differences, but that have no hardware or software differences related to measured or modeled emissions may be included in the same vehicle configuration. Note that vehicles with hardware or software differences related to measured or modeled emissions are considered to be different configurations even if they have the same GEM inputs and FEL. Vehicles within a vehicle configuration differ only with respect to normal production variability or factors unrelated to measured or modeled emissions.

*Vehicle family* has the meaning given in § 1037.230.

*Vehicle service class* has the meaning given in § 1037.140. The different vehicle service classes are Light HDV, Medium HDV, and Heavy HDV.

*Vehicle subfamily* or *subfamily* means a subset of a vehicle family including vehicles subject to the same FEL(s).

*Vocational tractor* means a vehicle classified as a vocational tractor under § 1037.630.

*Vocational vehicle* means relating to a vehicle subject to the standards of § 1037.105 (including vocational tractors).

*Void* has the meaning given in 40 CFR 1068.30.

*Volatile liquid fuel* means any fuel other than diesel or biodiesel that is a liquid at atmospheric pressure and has a Reid Vapor Pressure higher than 2.0 pounds per square inch.

*We (us, our)* means the Administrator of the Environmental Protection Agency and any authorized representatives.

**§ 1037.805 Symbols, abbreviations, and acronyms.**

The procedures in this part generally follow either the International System of Units (SI) or the United States customary units, as detailed in NIST Special Publication 811 (incorporated by reference in § 1037.810). See 40 CFR 1065.20 for specific provisions related to these conventions. This section summarizes the way we use symbols, units of measure, and other abbreviations.

(a) *Symbols for chemical species.* This part uses the following symbols for chemical species and exhaust constituents:

Symbol	Species
C	carbon.
CH <sub>4</sub>	methane.
CO	carbon monoxide.
CO <sub>2</sub>	carbon dioxide.
H <sub>2</sub> O	water.
HC	hydrocarbon.
NMHC	nonmethane hydrocarbon.
NMHCE	nonmethane hydrocarbon equivalent.
NO	nitric oxide.
NO <sub>2</sub>	nitrogen dioxide.
NO <sub>x</sub>	oxides of nitrogen.
N <sub>2</sub> O	nitrous oxide.
PM	particulate matter.
THC	total hydrocarbon.
THCE	total hydrocarbon equivalent.

(b) *Symbols for quantities.* This part uses the following symbols and units of measure for various quantities:

Symbol	Quantity	Unit	Unit symbol	Unit in terms of SI base units
A	vehicle frictional load	pound force or newton	lbf or N	kg·m·s <sup>-2</sup> .
a	axle position regression coefficient.			
α	atomic hydrogen-to-carbon ratio	mole per mole	mol/mol	1.
α	axle position regression coefficient.			
α <sub>0</sub>	intercept of air speed correction.			
α <sub>1</sub>	slope of air speed correction.			
a <sub>g</sub>	acceleration of Earth's gravity	meters per second squared	m/s <sup>2</sup>	m·s <sup>-2</sup> .
a <sub>0</sub>	intercept of least squares regression.			
a <sub>1</sub>	slope of least squares regression.			
B	vehicle load from drag and rolling resistance.	pound force per mile per hour or newton second per meter.	lbf/(mi/hr) or N·s/m	kg·s <sup>-1</sup> .
b	axle position regression coefficient.			
β	atomic oxygen-to-carbon ratio	mole per mole	mol/mol	1.
β	axle position regression coefficient.			
β <sub>0</sub>	intercept of air direction correction.			
β <sub>1</sub>	slope of air direction correction.			
C	vehicle-specific aerodynamic effects	pound force per mile per hour squared or newton-second squared per meter squared.	lbf/mph <sup>2</sup> or N·s <sup>2</sup> /m <sup>1</sup>	kg·m <sup>-1</sup> .
c	axle position regression coefficient.			
c <sub>i</sub>	axle test regression coefficients.			
C <sub>i</sub>	constant.			
ΔC <sub>d</sub> A	differential drag area	meter squared	m <sup>2</sup>	m <sup>2</sup> .
C <sub>d</sub> A	drag area	meter squared	m <sup>2</sup>	m <sup>2</sup> .
C <sub>d</sub>	drag coefficient.			
CF	correction factor.			
C <sub>rr</sub>	coefficient of rolling resistance	kilogram per metric ton	kg/tonne	10 <sup>-2</sup> .
D	distance	miles or meters	mi or m	m.

Symbol	Quantity	Unit	Unit symbol	Unit in terms of SI base units
<i>e</i> .....	mass-weighted emission result .....	grams/ton-mile .....	g/ton-mi .....	g/kg-km.
<i>Eff</i> .....	efficiency.			
<i>F</i> .....	adjustment factor.			
<i>F</i> .....	force .....	pound force or newton .....	lbf or N .....	kg·m·s <sup>-2</sup> .
<i>f<sub>n</sub></i> .....	angular speed (shaft) .....	revolutions per minute .....	r/min .....	π·30·s <sup>-1</sup> .
<i>G</i> .....	road grade .....	percent .....	% .....	10 <sup>-2</sup> .
<i>g</i> .....	gravitational acceleration .....	meters per second squared .....	m/s <sup>2</sup> .....	m·s <sup>-2</sup> .
<i>h</i> .....	elevation or height .....	meters .....	m .....	m.
<i>i</i> .....	indexing variable.			
<i>k<sub>a</sub></i> .....	drive axle ratio .....			1
<i>k<sub>d</sub></i> .....	transmission gear ratio.			
<i>k<sub>topgear</sub></i> .....	highest available transmission gear.			
<i>L</i> .....	load over axle .....	pound force or newton .....	lbf or N .....	kg·m·s <sup>-2</sup> .
<i>m</i> .....	mass .....	pound mass or kilogram .....	lbm or kg .....	kg.
<i>M</i> .....	molar mass .....	gram per mole .....	g/mol .....	10 <sup>-3</sup> ·kg·mol <sup>-1</sup> .
<i>M</i> .....	vehicle mass .....	kilogram .....	kg .....	kg.
<i>M<sub>e</sub></i> .....	vehicle effective mass .....	kilogram .....	kg .....	kg.
<i>M<sub>rotating</sub></i> .....	inertial mass of rotating components .....	kilogram .....	kg .....	kg.
<i>N</i> .....	total number in series.			
<i>n</i> .....	number of tires.			
<i>ṅ</i> .....	amount of substance rate .....	mole per second .....	mol/s .....	mol·s <sup>-1</sup> .
<i>P</i> .....	power .....	kilowatt .....	kW .....	10 <sup>3</sup> ·m <sup>2</sup> ·kg·s <sup>-3</sup> .
<i>P</i> .....	tire inflation pressure .....	pascal .....	Pa .....	kg·m <sup>-1</sup> ·s <sup>-2</sup> .
<i>p</i> .....	pressure .....	pascal .....	Pa .....	kg·m <sup>-1</sup> ·s <sup>-2</sup> .
<i>ρ</i> .....	mass density .....	kilogram per cubic meter .....	kg/m <sup>3</sup> .....	kg·m <sup>-3</sup> .
<i>PL</i> .....	payload .....	tons .....	ton .....	kg.
<i>φ</i> .....	direction .....	degrees .....	° .....	°.
<i>∠</i> .....	direction .....	degrees .....	° .....	°.
<i>r</i> .....	tire radius .....	meter .....	m .....	m.
<i>r<sup>2</sup></i> .....	coefficient of determination.			
<i>Re<sup>#</sup></i> .....	Reynolds number.			
<i>SEE</i> .....	standard estimate of error.			
<i>σ</i> .....	standard deviation.			
<i>TRPM</i> .....	tire revolutions per mile .....	revolutions per mile .....	r/mi.	
<i>TRRL</i> .....	tire rolling resistance level .....	kilogram per metric ton .....	kg/tonne .....	10 <sup>-3</sup> .
<i>T</i> .....	absolute temperature .....	kelvin .....	K .....	K.
<i>T</i> .....	Celsius temperature .....	degree Celsius .....	°C .....	K - 273.15.
<i>T</i> .....	torque (moment of force) .....	newton meter .....	N·m .....	m <sup>2</sup> ·kg·s <sup>-2</sup> .
<i>t</i> .....	time .....	hour or second .....	hr or s .....	s.
<i>Δt</i> .....	time interval, period, 1/frequency .....	second .....	s .....	s.
<i>UF</i> .....	utility factor.			
<i>v</i> .....	speed .....	miles per hour or meters per second .....	mi/hr or m/s .....	m·s <sup>-1</sup> .
<i>w</i> .....	weighting factor.			
<i>w</i> .....	wind speed .....	miles per hour .....	mi/hr .....	m·s <sup>-1</sup> .
<i>W</i> .....	work .....	kilowatt-hour .....	kW·hr .....	3.6·m <sup>2</sup> ·kg·s <sup>-1</sup> .
<i>w<sub>C</sub></i> .....	carbon mass fraction .....	gram/gram .....	g/g .....	1.
<i>WR</i> .....	weight reduction .....	pound mass .....	lbm .....	kg.
<i>x</i> .....	amount of substance mole fraction .....	mole per mole .....	mol/mol .....	1.

(c) *Superscripts.* This part uses the following superscripts to define a quantity:

Superscript	Quantity
overbar (such as $\bar{y}$ ) ...	arithmetic mean.
Double overbar (such as $\bar{\bar{y}}$ ).	arithmetic mean of arithmetic mean.
overdot (such as $\dot{y}$ ) ...	quantity per unit time.

(d) *Subscripts.* This part uses the following subscripts to define a quantity:

Subscript	Quantity
±6 .....	±6° yaw angle sweep.
A .....	A speed.
air .....	air.
aero .....	aerodynamic.

Subscript	Quantity
alt .....	alternative.
act .....	actual or measured condition.
air .....	air.
axle .....	axle.
B .....	B speed.
brake .....	brake.
C .....	C speed.
Ccombdry .....	carbon from fuel per mole of dry exhaust.
CD .....	charge-depleting.
circuit .....	circuit.
CO <sub>2</sub> DEF .....	CO <sub>2</sub> resulting from diesel exhaust fluid decomposition.
CO <sub>2</sub> PTO .....	CO <sub>2</sub> emissions for PTO cycle.
coastdown .....	coastdown.
comp .....	composite.
CS .....	charge-sustaining.
cycle .....	test cycle.

Subscript	Quantity
drive .....	drive axle.
drive-idle .....	idle with the transmission in drive.
driver .....	driver.
dyno .....	dynamometer.
effective .....	effective.
end .....	end.
eng .....	engine.
event .....	event.
fuel .....	fuel.
full .....	full.
grade .....	grade.
H <sub>2</sub> O <sub>exhaustdry</sub> .....	H <sub>2</sub> O in exhaust per mole of exhaust.
hi .....	high.
i .....	an individual of a series.
idle .....	idle.
in .....	inlet.
inc .....	increment.
lo .....	low.

Subscript	Quantity	Subscript	Quantity
loss .....	loss.	trac .....	traction.
max .....	maximum.	trac10 .....	traction force at 10 mi/hr.
meas .....	measured quantity.	trailer .....	trailer axle.
med .....	median.	transient .....	transient.
min .....	minimum.	TRR .....	tire rolling resistance.
moving .....	moving.	urea .....	urea.
out .....	outlet.	veh .....	vehicle.
P .....	power.	w .....	wind.
pair .....	pair of speed segments.	wa .....	wind average.
parked-idle .....	idle with the transmission in park.	yaw .....	yaw angle.
partial .....	partial.	ys .....	yaw sweep.
ploss .....	power loss.	zero .....	zero quantity.
plug-in .....	plug-in hybrid electric vehicle.		
powertrain .....	powertrain.		
PTO .....	power take-off.		
rated .....	rated speed.		
record .....	record.		
ref .....	reference quantity.		
RL .....	road load.		
rotating .....	rotating.		
seg .....	segment.		
speed .....	speed.		
spin .....	axle spin loss.		
start .....	start.		
steer .....	steer axle.		
t .....	tire.		
test .....	test.		
th .....	theoretical.		
total .....	total.		

(e) *Other acronyms and abbreviations.* This part uses the following additional abbreviations and acronyms:

ABT .....	averaging, banking, and trading.
AECD .....	auxiliary emission control device.
AES .....	automatic engine shutdown.
APU .....	auxiliary power unit.
CD .....	charge-depleting.
CFD .....	computational fluid dynamics.
CFR .....	Code of Federal Regulations.
CITT .....	curb idle transmission torque.
CS .....	charge-sustaining.
DOT .....	Department of Transportation.
EPA .....	Environmental Protection Agency.
FE .....	fuel economy.
FEL .....	Family Emission Limit.

GAWR .....	gross axle weight rating.
GCWR .....	gross combination weight rating.
GEM .....	greenhouse gas emission model.
GVWR .....	gross vehicle weight rating.
Heavy HDV .....	Heavy heavy-duty vehicle (see § 1037.140).
HVAC .....	heating, ventilating, and air conditioning.
ISO .....	International Organization for Standardization.
Light HDV .....	Light heavy-duty vehicle (see § 1037.140).
Medium HDV .....	Medium heavy-duty vehicle (see § 1037.140).
NARA .....	National Archives and Records Administration.
NHTSA .....	National Highway Transportation Safety Administration.
PHEV .....	plug-in hybrid electric vehicle.
PTO .....	power take-off.
RESS .....	rechargeable energy storage system.
rpm .....	revolutions per minute.
SAE .....	Society of Automotive Engineers.
SEE .....	standard error of estimate.
SKU .....	stock-keeping unit.
TRPM .....	tire revolutions per mile.
TRRL .....	tire rolling resistance level.
U.S.C. ....	United States Code.
VSL .....	vehicle speed limiter.

(f) *Constants.* This part uses the following constants:

Symbol	Quantity	Value
<i>g</i> .....	gravitational constant .....	9.81 m·s <sup>-2</sup> .
<i>R</i> .....	specific gas constant .....	287.058 J/(kg·K).

(g) *Prefixes.* This part uses the following prefixes to define a quantity:

Symbol	Quantity	Value
$\mu$ .....	micro .....	10 <sup>-6</sup>
m .....	milli .....	10 <sup>-3</sup>
c .....	centi .....	10 <sup>-2</sup>
k .....	kilo .....	10 <sup>3</sup>
M .....	mega .....	10 <sup>6</sup>

**§ 1037.810 Incorporation by reference.**

(a) Certain material is incorporated by reference into this part with the approval of the Director of the Federal Register under 5 U.S.C. 552(a) and 1 CFR part 51. To enforce any edition other than that specified in this section, the Environmental Protection Agency must publish a document in the **Federal Register** and the material must be available to the public. All approved material is available for inspection at U.S. EPA, Air and Radiation Docket and Information Center, 1301 Constitution Ave. NW., Room B102, EPA West Building, Washington, DC 20460, (202) 202-1744, and is available from the sources listed below. It is also available for inspection at the National Archives and Records Administration (NARA).

For information on the availability of this material at NARA, call 202-741-6030, or go to [http://www.archives.gov/federal\\_register/code\\_of\\_federal\\_regulations/ibr\\_locations.html](http://www.archives.gov/federal_register/code_of_federal_regulations/ibr_locations.html).

(b) International Organization for Standardization, Case Postale 56, CH-1211 Geneva 20, Switzerland, (41) 22749 0111, [www.iso.org](http://www.iso.org), or [central@iso.org](mailto:central@iso.org).

(1) ISO 28580:2009(E) “Passenger car, truck and bus tyres—Methods of measuring rolling resistance—Single point test and correlation of measurement results”, First Edition, July 1, 2009, (“ISO 28580”), IBR approved for § 1037.520(c).

(2) [Reserved]

(c) U.S. EPA, Office of Air and Radiation, 2565 Plymouth Road, Ann Arbor, MI 48105, [www.epa.gov](http://www.epa.gov).

(1) Greenhouse gas Emissions Model (GEM), Version 2.0.1, September 2012 (“GEM version 2.0.1”), IBR approved for § 1037.520. The computer code for this model is available as noted in paragraph (a) of this section. A working version of this software is also available for download at <http://www.epa.gov/otaq/climate/gem.htm>.

(2) Greenhouse gas Emissions Model (GEM) Phase 2, Version 3.0, July 2016; IBR approved for § 1037.520. The computer code for this model is available as noted in paragraph (a) of this section. A working version of this software is also available for download

at <http://www.epa.gov/otaq/climate/gem.htm>.

(d) National Institute of Standards and Technology, 100 Bureau Drive, Stop 1070, Gaithersburg, MD 20899–1070, (301) 975–6478, or [www.nist.gov](http://www.nist.gov).

(1) NIST Special Publication 811, Guide for the Use of the International System of Units (SI), 2008 Edition, March 2008, IBR approved for § 1037.805.

(2) [Reserved]

(e) SAE International, 400 Commonwealth Dr., Warrendale, PA 15096–0001, (877) 606–7323 (U.S. and Canada) or (724) 776–4970 (outside the U.S. and Canada), <http://www.sae.org>.

(1) SAE J1025, Test Procedures for Measuring Truck Tire Revolutions Per Kilometer/Mile, Stabilized August 2012, (“SAE J1025”), IBR approved for § 1037.520(c).

(2) SAE J1252, SAE Wind Tunnel Test Procedure for Trucks and Buses, Revised July 2012, (“SAE J1252”), IBR approved for §§ 1037.525(b) and 1037.530(a).

(3) SAE J1263, Road Load Measurement and Dynamometer Simulation Using Coastdown Techniques, revised March 2010, (“SAE J1263”), IBR approved for §§ 1037.528 introductory text, (a), (b), (c), (e), and (h) and 1037.665(a).

(4) SAE J1594, Vehicle Aerodynamics Terminology, Revised July 2010, (“SAE J1594”), IBR approved for § 1037.530(d).

(5) SAE J2071, Aerodynamic Testing of Road Vehicles—Open Throat Wind Tunnel Adjustment, Revised June 1994, (“SAE J2071”), IBR approved for § 1037.530(b).

(6) SAE J2263, Road Load Measurement Using Onboard Anemometry and Coastdown Techniques, Revised December 2008, (“SAE J2263”), IBR approved for §§ 1037.528 introductory text, (a), (b), (d), and (f) and 1037.665(a).

(7) SAE J2343, Recommended Practice for LNG Medium and Heavy-Duty Powered Vehicles, Revised July 2008, (“SAE J2343”), IBR approved for § 1037.103(e).

(8) SAE J2452, Stepwise Coastdown Methodology for Measuring Tire Rolling Resistance, Revised June 1999, (“SAE J2452”), IBR approved for § 1037.528(h).

(9) SAE J2966, Guidelines for Aerodynamic Assessment of Medium and Heavy Commercial Ground Vehicles Using Computational Fluid Dynamics, Issued September 2013, (“SAE J2966”), IBR approved for § 1037.532(a).

#### § 1037.815 Confidential information.

The provisions of 40 CFR 1068.10 apply for information you consider confidential.

#### § 1037.820 Requesting a hearing.

(a) You may request a hearing under certain circumstances, as described elsewhere in this part. To do this, you must file a written request, including a description of your objection and any supporting data, within 30 days after we make a decision.

(b) For a hearing you request under the provisions of this part, we will approve your request if we find that your request raises a substantial factual issue.

(c) If we agree to hold a hearing, we will use the procedures specified in 40 CFR part 1068, subpart G.

#### § 1037.825 Reporting and recordkeeping requirements.

(a) This part includes various requirements to submit and record data or other information. Unless we specify otherwise, store required records in any format and on any media and keep them readily available for eight years after you send an associated application for certification, or eight years after you generate the data if they do not support an application for certification. You may not rely on anyone else to meet recordkeeping requirements on your behalf unless we specifically authorize it. We may review these records at any time. You must promptly send us organized, written records in English if we ask for them. We may require you to submit written records in an electronic format.

(b) The regulations in § 1037.255 and 40 CFR 1068.25 and 1068.101 describe your obligation to report truthful and complete information. This includes information not related to certification. Failing to properly report information and keep the records we specify violates 40 CFR 1068.101(a)(2), which may involve civil or criminal penalties.

(c) Send all reports and requests for approval to the Designated Compliance Officer (see § 1037.801).

(d) Any written information we require you to send to or receive from another company is deemed to be a required record under this section. Such records are also deemed to be submissions to EPA. Keep these records for eight years unless the regulations specify a different period. We may require you to send us these records whether or not you are a certificate holder.

(e) Under the Paperwork Reduction Act (44 U.S.C. 3501 et seq), the Office of Management and Budget approves the reporting and recordkeeping specified in the applicable regulations. The following items illustrate the kind of reporting and recordkeeping we

require for vehicles regulated under this part:

(1) We specify the following requirements related to vehicle certification in this part 1037:

(i) In § 1036.150 we include various reporting and recordkeeping requirements related to interim provisions.

(ii) In subpart C of this part we identify a wide range of information required to certify vehicles.

(iii) In subpart G of this part we identify several reporting and recordkeeping items for making demonstrations and getting approval related to various special compliance provisions.

(iv) In § 1037.725, 1037.730, and 1037.735 we specify certain records related to averaging, banking, and trading.

(2) We specify the following requirements related to testing in 40 CFR part 1066:

(i) In 40 CFR 1066.2 we give an overview of principles for reporting information.

(ii) In 40 CFR 1066.25 we establish basic guidelines for storing test information.

(iii) In 40 CFR 1066.695 we identify the specific information and data items to record when measuring emissions.

(3) We specify the following requirements related to the general compliance provisions in 40 CFR part 1068:

(i) In 40 CFR 1068.5 we establish a process for evaluating good engineering judgment related to testing and certification.

(ii) In 40 CFR 1068.25 we describe general provisions related to sending and keeping information.

(iii) In 40 CFR 1068.27 we require manufacturers to make engines and vehicles available for our testing or inspection if we make such a request.

(iv) In 40 CFR 1068.105 we require vehicle manufacturers to keep certain records related to duplicate labels from engine manufacturers.

(v) In 40 CFR 1068.120 we specify recordkeeping related to rebuilding engines.

(vi) In 40 CFR part 1068, subpart C, we identify several reporting and recordkeeping items for making demonstrations and getting approval related to various exemptions.

(vii) In 40 CFR part 1068, subpart D, we identify several reporting and recordkeeping items for making demonstrations and getting approval related to importing engines and vehicles.

(viii) In 40 CFR 1068.450 and 1068.455 we specify certain records

related to testing production-line engines and vehicles in a selective enforcement audit.

(ix) In 40 CFR 1068.501 we specify certain records related to investigating and reporting emission-related defects.

(x) In 40 CFR 1068.525 and 1068.530 we specify certain records related to recalling nonconforming engines and vehicles.

(xi) In 40 CFR part 1068, subpart G, we specify certain records for requesting a hearing.

**Appendix I to Part 1037 — Heavy-Duty Transient Test Cycle**

	Time (sec)	Speed (mi/hr)	Time (sec)	Speed (mi/hr)
	56	7.59	129	6.52
	57	7.99	130	5.53
	58	8.32	131	4.36
	59	8.64	132	3.30
	60	8.91	133	2.50
	61	9.13	134	1.94
	62	9.29	135	1.56
	63	9.40	136	0.95
	64	9.39	137	0.42
	65	9.20	138	0.00
	66	8.84	139	0.00
	67	8.35	140	0.00
	68	7.81	141	0.00
	69	7.22	142	0.00
	70	6.65	143	0.00
	71	6.13	144	0.00
	72	5.75	145	0.00
	73	5.61	146	0.00
	74	5.65	147	0.00
	75	5.80	148	0.00
	76	5.95	149	0.00
	77	6.09	150	0.00
	78	6.21	151	0.00
	79	6.31	152	0.00
	80	6.34	153	0.00
	81	6.47	154	0.00
	82	6.65	155	0.00
	83	6.88	156	0.00
	84	7.04	157	0.00
	85	7.05	158	0.00
	86	7.01	159	0.00
	87	6.90	160	0.00
	88	6.88	161	0.00
	89	6.89	162	0.00
	90	6.96	163	0.00
	91	7.04	164	0.00
	92	7.17	165	0.00
	93	7.29	166	0.00
	94	7.39	167	0.00
	95	7.48	168	0.00
	96	7.57	169	0.00
	97	7.61	170	0.00
	98	7.59	171	0.00
	99	7.53	172	1.11
	100	7.46	173	2.65
	101	7.40	174	4.45
	102	7.39	175	5.68
	103	7.38	176	6.75
	104	7.37	177	7.59
	105	7.37	178	7.75
	106	7.39	179	7.63
	107	7.42	180	7.67
	108	7.43	181	8.70
	109	7.40	182	10.20
	110	7.39	183	11.92
	111	7.42	184	12.84
	112	7.50	185	13.27
	113	7.57	186	13.38
	114	7.60	187	13.61
	115	7.60	188	14.15
	116	7.61	189	14.84
	117	7.64	190	16.49
	118	7.68	191	18.33
	119	7.74	192	20.36
	120	7.82	193	21.47
	121	7.90	194	22.35
	122	7.96	195	22.96
	123	7.99	196	23.46
	124	8.02	197	23.92
	125	8.01	198	24.42
	126	7.87	199	24.99
	127	7.59	200	25.91
	128	7.20	201	26.26

Time (sec)	Speed (mi/hr)	Time (sec)	Speed (mi/hr)	Time (sec)	Speed (mi/hr)
202	26.38	275	18.90	348	18.25
203	26.26	276	19.44	349	18.17
204	26.49	277	20.09	350	18.40
205	26.76	278	21.89	351	19.63
206	27.07	279	24.15	352	20.32
207	26.64	280	26.26	353	21.43
208	25.99	281	26.95	354	21.47
209	24.77	282	27.03	355	21.97
210	24.04	283	27.30	356	22.27
211	23.39	284	28.10	357	22.69
212	22.73	285	29.44	358	23.15
213	22.16	286	30.78	359	23.69
214	21.66	287	32.09	360	23.96
215	21.39	288	33.24	361	24.27
216	21.43	289	34.46	362	24.34
217	20.67	290	35.42	363	24.50
218	17.98	291	35.88	364	24.42
219	13.15	292	36.03	365	24.38
220	7.71	293	35.84	366	24.31
221	3.30	294	35.65	367	24.23
222	0.88	295	35.31	368	24.69
223	0.00	296	35.19	369	25.11
224	0.00	297	35.12	370	25.53
225	0.00	298	35.12	371	25.38
226	0.00	299	35.04	372	24.58
227	0.00	300	35.08	373	23.77
228	0.00	301	35.04	374	23.54
229	0.00	302	35.34	375	23.50
230	0.00	303	35.50	376	24.15
231	0.00	304	35.77	377	24.30
232	0.00	305	35.81	378	24.15
233	0.00	306	35.92	379	23.19
234	0.00	307	36.23	380	22.50
235	0.00	308	36.42	381	21.93
236	0.00	309	36.65	382	21.85
237	0.00	310	36.26	383	21.55
238	0.00	311	36.07	384	21.89
239	0.00	312	35.84	385	21.97
240	0.00	313	35.96	386	21.97
241	0.00	314	36.00	387	22.01
242	0.00	315	35.57	388	21.85
243	0.00	316	35.00	389	21.62
244	0.00	317	34.08	390	21.62
245	0.00	318	33.39	391	22.01
246	0.00	319	32.20	392	22.81
247	0.00	320	30.32	393	23.54
248	0.00	321	28.48	394	24.38
249	0.00	322	26.95	395	24.80
250	0.00	323	26.18	396	24.61
251	0.00	324	25.38	397	23.12
252	0.00	325	24.77	398	21.62
253	0.00	326	23.46	399	19.90
254	0.00	327	22.39	400	18.86
255	0.00	328	20.97	401	17.79
256	0.00	329	20.09	402	17.25
257	0.00	330	18.90	403	16.91
258	0.00	331	18.17	404	16.75
259	0.50	332	16.48	405	16.75
260	1.57	333	15.07	406	16.87
261	3.07	334	12.23	407	16.37
262	4.57	335	10.08	408	16.37
263	5.65	336	7.71	409	16.49
264	6.95	337	7.32	410	17.21
265	8.05	338	8.63	411	17.41
266	9.13	339	10.77	412	17.37
267	10.05	340	12.65	413	16.87
268	11.62	341	13.88	414	16.72
269	12.92	342	15.03	415	16.22
270	13.84	343	15.64	416	15.76
271	14.38	344	16.99	417	14.72
272	15.64	345	17.98	418	13.69
273	17.14	346	19.13	419	12.00
274	18.21	347	18.67	420	10.43



Time (sec)	Speed (mi/hr)	Time (sec)	Speed (mi/hr)	Time (sec)	Speed (mi/hr)
421	8.71	494	7.82	567	11.12
422	7.44	495	5.70	568	12.46
423	5.71	496	3.57	569	13.00
424	4.22	497	0.92	570	14.26
425	2.30	498	0.00	571	15.37
426	1.00	499	0.00	572	17.02
427	0.00	500	0.00	573	18.17
428	0.61	501	0.00	574	19.21
429	1.19	502	0.00	575	20.17
430	1.61	503	0.00	576	20.66
431	1.53	504	0.00	577	21.12
432	2.34	505	0.00	578	21.43
433	4.29	506	0.00	579	22.66
434	7.25	507	0.00	580	23.92
435	10.20	508	0.00	581	25.42
436	12.46	509	0.00	582	25.53
437	14.53	510	0.00	583	26.68
438	16.22	511	0.00	584	28.14
439	17.87	512	0.00	585	30.06
440	19.74	513	0.00	586	30.94
441	21.01	514	0.00	587	31.63
442	22.23	515	0.00	588	32.36
443	22.62	516	0.00	589	33.24
444	23.61	517	0.00	590	33.66
445	24.88	518	0.00	591	34.12
446	26.15	519	0.00	592	35.92
447	26.99	520	0.00	593	37.72
448	27.56	521	0.00	594	39.26
449	28.18	522	0.50	595	39.45
450	28.94	523	1.50	596	39.83
451	29.83	524	3.00	597	40.18
452	30.78	525	4.50	598	40.48
453	31.82	526	5.80	599	40.75
454	32.78	527	6.52	600	41.02
455	33.24	528	6.75	601	41.36
456	33.47	529	6.44	602	41.79
457	33.31	530	6.17	603	42.40
458	33.08	531	6.33	604	42.82
459	32.78	532	6.71	605	43.05
460	32.39	533	7.40	606	43.09
461	32.13	534	7.67	607	43.24
462	31.82	535	7.33	608	43.59
463	31.55	536	6.71	609	44.01
464	31.25	537	6.41	610	44.35
465	30.94	538	6.60	611	44.55
466	30.71	539	6.56	612	44.82
467	30.56	540	5.94	613	45.05
468	30.79	541	5.45	614	45.31
469	31.13	542	5.87	615	45.58
470	31.55	543	6.71	616	46.00
471	31.51	544	7.56	617	46.31
472	31.47	545	7.59	618	46.54
473	31.44	546	7.63	619	46.61
474	31.51	547	7.67	620	46.92
475	31.59	548	7.67	621	47.19
476	31.67	549	7.48	622	47.46
477	32.01	550	7.29	623	47.54
478	32.63	551	7.29	624	47.54
479	33.39	552	7.40	625	47.54
480	34.31	553	7.48	626	47.50
481	34.81	554	7.52	627	47.50
482	34.20	555	7.52	628	47.50
483	32.39	556	7.48	629	47.31
484	30.29	557	7.44	630	47.04
485	28.56	558	7.28	631	46.77
486	26.45	559	7.21	632	45.54
487	24.79	560	7.09	633	43.24
488	23.12	561	7.06	634	41.52
489	20.73	562	7.29	635	39.79
490	18.33	563	7.75	636	38.07
491	15.72	564	8.55	637	36.34
492	13.11	565	9.09	638	34.04
493	10.47	566	10.04	639	32.45

Time (sec)	Speed (mi/hr)	Time (sec)	Speed (mi/hr)	Time (sec)	Speed (mi/hr)
640	30.86	651	5.56	662	0.00
641	28.83	652	3.72	663	0.00
642	26.45	653	3.38	664	0.00
643	24.27	654	3.11	665	0.00
644	22.04	655	2.58	666	0.00
645	19.82	656	1.66	667	0.00
646	17.04	657	0.67	668	0.00
647	14.26	658	0.00		
648	11.52	659	0.00		
649	8.78	660	0.00		
650	7.17	661	0.00		

**Appendix II to Part 1037—Power Take-Off Test Cycle**

Cycle simulation	Mode	Start time of mode	Normalized pressure, circuit 1 (%)	Normalized pressure, circuit 2 (%)
Utility	0	0	0.0	0.0
Utility	1	33	80.5	0.0
Utility	2	40	0.0	0.0
Utility	3	145	83.5	0.0
Utility	4	289	0.0	0.0
Refuse	5	361	0.0	13.0
Refuse	6	363	0.0	38.0
Refuse	7	373	0.0	53.0
Refuse	8	384	0.0	73.0
Refuse	9	388	0.0	0.0
Refuse	10	401	0.0	13.0
Refuse	11	403	0.0	38.0
Refuse	12	413	0.0	53.0
Refuse	13	424	0.0	73.0
Refuse	14	442	11.2	0.0
Refuse	15	468	29.3	0.0
Refuse	16	473	0.0	0.0
Refuse	17	486	11.2	0.0
Refuse	18	512	29.3	0.0
Refuse	19	517	0.0	0.0
Refuse	20	530	12.8	11.1
Refuse	21	532	12.8	38.2
Refuse	22	541	12.8	53.4
Refuse	23	550	12.8	73.5
Refuse	24	553	0.0	0.0
Refuse	25	566	12.8	11.1
Refuse	26	568	12.8	38.2
Refuse	27	577	12.8	53.4
Refuse	28	586	12.8	73.5
Refuse	29	589	0.0	0.0
Refuse	30	600	0.0	0.0

**Appendix III to Part 1037—Emission Control Identifiers**

This appendix identifies abbreviations for emission control information labels, as required under § 1037.135.

**Vehicle Speed Limiters**

- VSL—Vehicle speed limiter
- VSLs—“Soft-top” vehicle speed limiter
- VSL—Expiring vehicle speed limiter
- VSLD—Vehicle speed limiter with both “soft-top” and expiration

**Idle Reduction Technology**

- IRT5—Engine shutoff after 5 minutes or less of idling
- IRTE—Expiring engine shutoff

**Tires**

- LRR—Low rolling resistance tires (all, including trailers)
- LRRD—Low rolling resistance tires (drive)
- LRRS—Low rolling resistance tires (steer)

**Aerodynamic Components**

- ATS—Aerodynamic side skirt and/or fuel tank fairing
- ARF—Aerodynamic roof fairing
- ARFR—Adjustable height aerodynamic roof fairing
- TGR—Gap reducing tractor fairing (tractor to trailer gap)
- TGRT—Gap reducing trailer fairing (tractor to trailer gap)
- TATS—Trailer aerodynamic side skirt
- TARF—Trailer aerodynamic rear fairing
- TAUD—Trailer aerodynamic underbody device

**Other Components**

- ADVH—Vehicle includes advanced hybrid technology components
- ADVO—Vehicle includes other advanced-technology components (*i.e.*, non-hybrid system)
- INV—Vehicle includes innovative (off-cycle) technology components

- ATI—Automatic tire inflation system
- TPMS—Tire pressure monitoring system
- WRTW—Weight-reducing trailer wheels
- WRTC—Weight-reducing trailer upper coupler plate
- WRTS—Weight-reducing trailer axle sub-frames
- WBSW—Wide-base single trailer tires with steel wheel
- WBAW—Wide-base single trailer tires with aluminum wheel
- WBLW—Wide-base single trailer tires with light-weight aluminum alloy wheel
- DWSW—Dual-wide trailer tires with steel wheel
- DWAW—Dual-wide trailer tires with aluminum wheel
- DWLW—Dual-wide trailer tires with light-weight aluminum alloy wheel

**Appendix IV to Part 1037—Heavy-Duty Grade Profile for Phase 2 Steady-State Test Cycles**

The following table identifies a grade profile for operating vehicles over the highway cruise cycles specified in subpart F of this part. Determine intermediate values by linear interpolation.

Distance (m)	Grade (%)	Distance (m)	Grade (%)
0	0	6710	3
808	0	6762	3.27
820	-0.1	6800	3.69
832	0	6890	5.01
842	0	6980	3.69
892	0.36	7018	3.27
942	0	7070	3
952	0	7142	2.57
1006	-0.28	7218	2.14
1102	-1.04	7344	1.66
1198	-0.28	7468	1.29
1252	0	7554	1.09
1264	0	7728	0.77
1390	0.39	7868	0.58
1458	0.66	8060	0.38
1534	1.15	8282	0.17
1696	2.44	8374	0.1
1858	1.15	8458	0
1934	0.66	8502	0
2002	0.39	8608	-0.38
2128	0	8668	-0.69
2146	0	8852	-2.13
2330	-0.46	9036	-0.69
2398	-0.69	9096	-0.38
2478	-1.08	9202	0
2546	-1.53	9214	0
2698	-2.75	9262	0.26
2850	-1.53	9316	0.7
2918	-1.08	9370	0.26
2998	-0.69	9418	0
3066	-0.46	9428	0
3250	0	9496	-0.34
3264	0	9622	-1.33
3340	0.35	9748	-0.34
3416	0.9	9816	0
3502	1.59	9826	0
3588	0.9	9914	0.37
3664	0.35	9968	0.7
3740	0	10112	1.85
3756	0	10256	0.7
3822	-0.1	10310	0.37
4094	-0.69	10398	0
4176	-0.97	10410	0
4262	-1.36	10498	-0.37
4330	-1.78	10552	-0.7
4514	-3.23	10696	-1.85
4698	-1.78	10840	-0.7
4766	-1.36	10894	-0.37
4852	-0.97	10982	0
4934	-0.69	10992	0
5206	-0.1	11060	0.34
5272	0	11186	1.33
5322	0	11312	0.34
5406	0.1	11380	0
5498	0.17	11390	0
5720	0.38	11438	-0.26
5912	0.58	11492	-0.7
6052	0.77	11546	-0.26
6226	1.09	11594	0
6312	1.29	11606	0
6436	1.66	11712	0.38
6562	2.14	11772	0.69
6638	2.57	11956	2.13
		12140	0.69
		12200	0.38
		12306	0
		12350	0
		12434	-0.1
		12526	-0.17
		12748	-0.38
		12940	-0.58
		13080	-0.77
		13254	-1.09
		13340	3
		13464	3.27
		13590	3.69
		13666	5.01
		13738	3.69
		13790	3.27
		13828	3
		13918	2.57
		14008	2.14
		14046	1.66
		14098	1.29
		14170	1.09
		14246	0.77
		14372	0.58
		14496	0.38
		14582	0.17
		14756	0.1
		14896	0
		15088	0
		15310	-0.38
		15402	-0.69
		15486	-2.13
		15536	-0.69
		15602	-0.38
		15874	0
		15956	0
		16042	0.26
		16110	0.7
		16294	0.26
		16478	0
		16546	0
		16632	-0.34
		16714	-1.33
		16986	-0.34
		17052	0
		17068	0
		17144	0.37
		17220	0.7
		17306	1.85
		17392	0.7
		17468	0.37
		17544	0
		17558	0
		17742	-0.37
		17810	-0.7
		17890	-1.85
		17958	-0.7
		18110	-0.37
		18262	0
		18330	0
		18410	0.34
		18478	1.33
		18662	0.34
		18680	0
		18806	0
		18874	-0.26
		18950	-0.7
		19112	-0.26
		19274	0
		19350	0
		19418	0.38
		19544	0.69
		19556	2.13
		19610	0.69
		19706	0.38
		19802	0
		19856	0
		19866	-0.1
		19916	-0.17
		19966	-0.38
		19976	-0.58
		19988	-0.77
		20000	-1.09

Distance (m)	Grade (%)
20808 .....	0

**Appendix V to Part 1037—Power Take-Off Utility Factors**

Time (min)	Utility factor fraction
0 .....	0
10 .....	0.1
20 .....	0.18
30 .....	0.24
40 .....	0.31
50 .....	0.36
60 .....	0.4
70 .....	0.44
80 .....	0.47
90 .....	0.51
100 .....	0.54
110 .....	0.57
120 .....	0.6
130 .....	0.64
140 .....	0.66
150 .....	0.69
160 .....	0.71
170 .....	0.74
180 .....	0.76
190 .....	0.77
200 .....	0.79
210 .....	0.8
220 .....	0.82
230 .....	0.83
240 .....	0.85
250 .....	0.86
260 .....	0.87
270 .....	0.88
280 .....	0.88
290 .....	0.89
300 .....	0.9
310 .....	0.9
320 .....	0.91
330 .....	0.92
340 .....	0.93
350 .....	0.93
360 .....	0.94
370 .....	0.95
380 .....	0.95
390 .....	0.96
420 .....	0.96
430 .....	0.97
460 .....	0.97
470 .....	0.98
520 .....	0.98
530 .....	0.99
580 .....	0.99
590 .....	1

**PART 1039—CONTROL OF EMISSIONS FROM NEW AND IN-USE NONROAD COMPRESSION-IGNITION ENGINES**

■ 139. The authority citation for part 1039 continues to read as follows:

Authority: 42 U.S.C. 7401–7671q.

**Subpart A—Overview and Applicability**

■ 140. Section 1039.2 is revised to read as follows:

**§ 1039.2 Who is responsible for compliance?**

The regulations in this part 1039 contain provisions that affect both manufacturers and others. However, the requirements of this part are generally addressed to the manufacturer. The term “you” generally means the manufacturer, as defined in § 1039.801, especially for issues related to certification. Note that for engines that become new after being placed into service (such as engines converted from highway or stationary use), the requirements that normally apply for manufacturers of freshly manufactured engines apply to the importer or any other entity we allow to obtain a certificate of conformity.

■ 141. Section 1039.5 is amended by revising the introductory text, adding paragraph (a)(2)(iii), and revising paragraph (e) to read as follows:

**§ 1039.5 Which engines are excluded from this part’s requirements?**

This part does not apply to certain nonroad engines, as follows:

(a) \* \* \*

(2) \* \* \*

(iii) Locomotive engines produced under the provisions of 40 CFR 1033.625.

\* \* \* \* \*

(e) *Engines used in recreational vehicles.* Engines certified to meet the requirements of 40 CFR part 1051 are not subject to the provisions of this part 1039.

■ 142. Section 1039.30 is revised to read as follows:

**§ 1039.30 Submission of information.**

Unless we specify otherwise, send all reports and requests for approval to the Designated Compliance Officer (see § 1039.801). See § 1039.825 for additional reporting and recordkeeping provisions.

**Subpart B—Emission Standards and Related Requirements**

■ 143. Section 1039.101 is amended by revising paragraph (f) to read as follows:

**§ 1039.101 What exhaust emission standards must my engines meet after the 2014 model year?**

\* \* \* \* \*

(f) *Fuel types.* The exhaust emission standards in this section apply for engines using the fuel type on which the engines in the engine family are designed to operate, except for engines certified under § 1039.615. For engines certified under § 1039.615, the standards of this section apply to emissions measured using the specified

test fuel. You must meet the numerical emission standards for NMHC in this section based on the following types of hydrocarbon emissions for engines powered by the following fuels:

(1) Alcohol-fueled engines: THCE emissions.

(2) Gaseous-fueled engines: Nonmethane-nonethane hydrocarbon emissions.

(3) Other engines: NMHC emissions.

\* \* \* \* \*

■ 144. Section 1039.102 is amended by revising paragraph (e)(3) to read as follows:

**§ 1039.102 What exhaust emission standards and phase-in allowances apply for my engines in model year 2014 and earlier?**

\* \* \* \* \*

(e) \* \* \*

(3) You may use NO<sub>x</sub> +NMHC emission credits to certify an engine family to the alternate NO<sub>x</sub> +NMHC standards in this paragraph (e)(3) instead of the otherwise applicable alternate NO<sub>x</sub> and NMHC standards. Calculate the alternate NO<sub>x</sub> +NMHC standard by adding 0.1 g/kW-hr to the numerical value of the applicable alternate NO<sub>x</sub> standard of paragraph (e)(1) or (2) of this section. Engines certified to the NO<sub>x</sub> +NMHC standards of this paragraph (e)(3) may not generate emission credits. The FEL caps for engine families certified under this paragraph (e)(3) are the previously applicable NO<sub>x</sub> +NMHC standards of 40 CFR 89.112 (generally the Tier 3 standards).

\* \* \* \* \*

■ 145. Section 1039.104 is amended by revising paragraph (g)(5) and adding paragraph (i) to read as follows:

**§ 1039.104 Are there interim provisions that apply only for a limited time?**

\* \* \* \* \*

(g) \* \* \*

(5) You may certify engines under this paragraph (g) in any model year provided for in Table 1 of this section without regard to whether or not the engine family’s FEL is at or below the otherwise applicable FEL cap. For example, a 200 kW engine certified to the NO<sub>x</sub> + NMHC standard of § 1039.102(e)(3) with an FEL equal to the FEL cap of 4.0 g/kW-hr may nevertheless be certified under this paragraph (g).

\* \* \* \* \*

(i) *Lead time for diagnostic controls.* Model year 2017 and earlier engines are not subject to the requirements for diagnostic controls as specified in § 1039.110.

■ 146. Section 1039.107 is amended by revising paragraph (b)(2) to read as follows:

§ 1039.107 What evaporative emission standards and requirements apply?

\* \* \* \* \*

(b) \* \* \*

(2) Present test data to show that equipment using your engines meets the evaporative emission standards we specify in this section if you do not use design-based certification under 40 CFR 1048.245.

■ 147. Section 1039.110 is added to subpart B to read as follows:

§ 1039.110 Recording reductant use and other diagnostic functions.

(a) Engines equipped with SCR systems using a reductant other than the engine's fuel must have a diagnostic system that monitors reductant quality and tank levels and alert operators to the need to refill the reductant tank before it is empty, or to replace the reductant if it does not meet your concentration specifications. Unless we approve other alerts, use a warning lamp or an audible alarm. You do not need to separately monitor reductant quality if your system uses input from an exhaust NOx sensor (or other sensor) to alert operators when reductant quality is inadequate. However, tank level must be monitored in all cases.

(b) You may equip your engine with other diagnostic features. If you do, they must be designed to allow us to read and interpret the codes. Note that § 1039.205 requires you to provide us any information needed to read, record, and interpret all the information broadcast by an engine's onboard computers and electronic control units.

■ 148. Section 1039.120 is amended by revising paragraph (b) introductory text to read as follows:

§ 1039.120 What emission-related warranty requirements apply to me?

\* \* \* \* \*

(b) *Warranty period.* Your emission-related warranty must be valid for at least as long as the minimum warranty periods listed in this paragraph (b) in hours of operation and years, whichever comes first. You may offer an emission-related warranty more generous than we require. The emission-related warranty for the engine may not be shorter than any basic mechanical warranty you provide without charge for the engine. Similarly, the emission-related warranty for any component may not be shorter than any warranty you provide without charge for that component. This means that your warranty may not treat emission-related and nonemission-

related defects differently for any component. If an engine has no hour meter, we base the warranty periods in this paragraph (b) only on the engine's age (in years). The warranty period begins when the engine is placed into service. The minimum warranty periods are shown in the following table:

\* \* \* \* \*

■ 149. Section 1039.125 is amended by revising paragraphs (a)(2)(i), (a)(3)(i), (a)(4), (c), (e), and (f) introductory text to read as follows:

§ 1039.125 What maintenance instructions must I give to buyers?

\* \* \* \* \*

(a) \* \* \*

(2) \* \* \*

(i) For EGR-related filters and coolers, DEF filters, crankcase ventilation valves and filters, and fuel injector tips (cleaning only), the minimum interval is 1,500 hours.

\* \* \* \* \*

(3) \* \* \*

(i) For EGR-related filters and coolers, DEF filters, crankcase ventilation valves and filters, and fuel injector tips (cleaning only), the minimum interval is 1,500 hours.

\* \* \* \* \*

(4) For particulate traps, trap oxidizers, and components related to either of these, scheduled maintenance may include cleaning or repair at the intervals specified in paragraph (a)(2)(ii) or (a)(3)(ii) of this section, as applicable. Scheduled maintenance may include a shorter interval for cleaning or repair and may also include adjustment or replacement, but only if we approve it. We will approve your request if you provide the maintenance free of charge and clearly state this in your maintenance instructions, and you provide us additional information as needed to convince us that the maintenance will occur.

\* \* \* \* \*

(c) *Special maintenance.* You may specify more frequent maintenance to address problems related to special situations, such as atypical engine operation. You must clearly state that this additional maintenance is associated with the special situation you are addressing. You may also address maintenance of low-use engines (such as recreational or stand-by engines) by specifying the maintenance interval in terms of calendar months or years in addition to your specifications in terms of engine operating hours. All special maintenance instructions must be consistent with good engineering judgment. We may disapprove your maintenance instructions if we

determine that you have specified special maintenance steps to address maintenance that is unlikely to occur in use, or engine operation that is not atypical. For example, this paragraph (c) does not allow you to design engines that require special maintenance for a certain type of expected operation. If we determine that certain maintenance items do not qualify as special maintenance under this paragraph (c), you may identify this as recommended additional maintenance under paragraph (b) of this section.

\* \* \* \* \*

(e) *Maintenance that is not emission-related.* For maintenance unrelated to emission controls, you may schedule any amount of inspection or maintenance. You may also take these inspection or maintenance steps during service accumulation on your emission-data engines, as long as they are reasonable and technologically necessary. This might include adding engine oil, changing air, fuel, or oil filters, servicing engine-cooling systems or fuel-water separator cartridges or elements, and adjusting idle speed, governor, engine bolt torque, valve lash, or injector lash. You may not perform this nonemission-related maintenance on emission-data engines more often than the least frequent intervals that you recommend to the ultimate purchaser.

(f) *Source of parts and repairs.* State clearly in your written maintenance instructions that a repair shop or person of the owner's choosing may maintain, replace, or repair emission-control devices and systems. Your instructions may not require components or service identified by brand, trade, or corporate name. Also, do not directly or indirectly condition your warranty on a requirement that the engine be serviced by your franchised dealers or any other service establishments with which you have a commercial relationship. You may disregard the requirements in this paragraph (f) if you do one of two things:

\* \* \* \* \*

■ 150. Section 1039.130 is amended by adding paragraph (b)(4) and revising paragraph (b)(5) to read as follows:

§ 1039.130 What installation instructions must I give to equipment manufacturers?

\* \* \* \* \*

(b) \* \* \*

(4) Describe any necessary steps for installing the diagnostic system described in § 1039.110.

(5) Describe how your certification is limited for any type of application. For example, if your engines are certified only for constant-speed operation, tell

equipment manufacturers not to install the engines in variable-speed applications.

\* \* \* \* \*

■ 151. Section 1039.135 is amended by revising paragraphs (b), (c)(2), and (d) to read as follows:

**§ 1039.135 How must I label and identify the engines I produce?**

\* \* \* \* \*

(b) At the time of manufacture, affix a permanent and legible label identifying each engine. The label must meet the requirements of 40 CFR 1068.45.

(c) \* \* \*

(2) Include your full corporate name and trademark. You may identify another company and use its trademark instead of yours if you comply with the branding provisions of 40 CFR 1068.45.

\* \* \* \* \*

(d) You may add information to the emission control information label as follows:

(1) You may identify other emission standards that the engine meets or does not meet (such as international standards), as long as this does not cause you to omit any of the information described in paragraphs (c)(5) through (10) of this section. You may add the information about the other emission standards to the statement we specify, or you may include it in a separate statement.

(2) You may add other information to ensure that the engine will be properly maintained and used.

(3) You may add appropriate features to prevent counterfeit labels. For example, you may include the engine's unique identification number on the label.

\* \* \* \* \*

**Subpart C—Certifying Engine Families**

■ 152. Section 1039.201 is amended by revising paragraphs (a) and (g) to read as follows:

**§ 1039.201 What are the general requirements for obtaining a certificate of conformity?**

(a) You must send us a separate application for a certificate of conformity for each engine family. A certificate of conformity is valid for new production from the indicated effective date until the end of the model year for which it is issued, which may not extend beyond December 31 of that year. No new certificate will be issued after December 31 of the model year. You may amend your application for certification after the end of the model year in certain circumstances as

described in §§ 1039.220 and 1039.225. You must renew your certification annually for any engines you continue to produce.

\* \* \* \* \*

(g) We may require you to deliver your test engines to a facility we designate for our testing (see § 1039.235(c)). Alternatively, you may choose to deliver another engine that is identical in all material respects to the test engine, or another engine that we determine can appropriately serve as an emission-data engine for the engine family.

\* \* \* \* \*

■ 153. Section 1039.205 is amended by revising paragraph (r)(1) and adding paragraph (bb) to read as follows:

**§ 1039.205 What must I include in my application?**

\* \* \* \* \*

(r) \* \* \*

(1) Report all valid test results involving measurement of pollutants for which emission standards apply. Also indicate whether there are test results from invalid tests or from any other tests of the emission-data engine, whether or not they were conducted according to the test procedures of subpart F of this part. We may require you to report these additional test results. We may ask you to send other information to confirm that your tests were valid under the requirements of this part and 40 CFR part 1065.

\* \* \* \* \*

(bb) For imported engines or equipment, identify the following:

(1) Describe your normal practice for importing engines. For example, this may include identifying the names and addresses of any agents you have authorized to import your engines.

(2) For engines below 560 kW, identify a test facility in the United States where you can test your engines if we select them for testing under a selective enforcement audit, as specified in 40 CFR part 1068, subpart E.

■ 154. Section 1039.220 is amended by revising the section heading as to read as follows:

**§ 1039.220 How do I amend my maintenance instructions?**

\* \* \* \* \*

■ 155. Section 1039.225 is amended by adding paragraphs (b)(4) and (g) to read as follows:

**§ 1039.225 How do I amend my application for certification?**

\* \* \* \* \*

(b) \* \* \*

(4) Include any other information needed to make your application correct and complete.

\* \* \* \* \*

(g) You may produce engines as described in your amended application for certification and consider those engines to be in a certified configuration if we approve a new or modified engine configuration during the model year under paragraph (d) of this section. Similarly, you may modify in-use engines as described in your amended application for certification and consider those engines to be in a certified configuration if we approve a new or modified engine configuration at any time under paragraph (d) of this section. Modifying a new or in-use engine to be in a certified configuration does not violate the tampering prohibition of 40 CFR 1068.101(b)(1), as long as this does not involve changing to a certified configuration with a higher family emission limit.

■ 156. Section 1039.230 is amended by revising paragraph (b)(1) to read as follows:

**§ 1039.230 How do I select engine families?**

\* \* \* \* \*

(b) \* \* \*

(1) The combustion cycle and fuel. However, you do not need to separate dual-fuel and flexible-fuel engines into separate engine families.

\* \* \* \* \*

■ 157. Section 1039.235 is amended by revising paragraphs (a), (b), (c) introductory text, (c)(4), and (d)(1) to read as follows:

**§ 1039.235 What testing requirements apply for certification?**

\* \* \* \* \*

(a) Select an emission-data engine from each engine family for testing. Select the engine configuration with the highest volume of fuel injected per cylinder per combustion cycle at the point of maximum torque—unless good engineering judgment indicates that a different engine configuration is more likely to exceed (or have emissions nearer to) an applicable emission standard or FEL. If two or more engines have the same fueling rate at maximum torque, select the one with the highest fueling rate at rated speed. In making this selection, consider all factors expected to affect emission-control performance and compliance with the standards, including emission levels of all exhaust constituents, especially NO<sub>x</sub> and PM.

(b) Test your emission-data engines using the procedures and equipment

specified in subpart F of this part. In the case of dual-fuel engines, measure emissions when operating with each type of fuel for which you intend to certify the engine. In the case of flexible-fuel engines, measure emissions when operating with the fuel mixture that best represents in-use operation or is most likely to have the highest NO<sub>x</sub> emissions (or NO<sub>x</sub>+NMHC emissions for engines subject to NO<sub>x</sub>+NMHC standards), though you may ask us instead to perform tests with both fuels separately if you can show that intermediate mixtures are not likely to occur in use.

(c) We may perform confirmatory testing by measuring emissions from any of your emission-data engines or other engines from the engine family, as follows:

\* \* \* \* \*

(4) Before we test one of your engines, we may calibrate it within normal production tolerances for anything we do not consider an adjustable parameter. For example, this would apply for an engine parameter that is subject to production variability because it is adjustable during production, but is not considered an adjustable parameter (as defined in § 1039.801) because it is permanently sealed. For parameters that relate to a level of performance that is itself subject to a specified range (such as maximum power output), we will generally perform any calibration under this paragraph (c)(4) in a way that keeps performance within the specified range.

(d) \* \* \*

(1) The engine family from the previous model year differs from the current engine family only with respect to model year, items identified in § 1039.225(a), or other characteristics unrelated to emissions. We may waive this criterion for differences we determine not to be relevant.

\* \* \* \* \*

■ 158. Section 1039.240 is amended by revising paragraphs (c) and (d) and removing paragraph (e).

The revisions read as follows:

**§ 1039.240 How do I demonstrate that my engine family complies with exhaust emission standards?**

\* \* \* \* \*

(c) To compare emission levels from the emission-data engine with the applicable emission standards, apply deterioration factors to the measured emission levels for each pollutant. Section 1039.245 specifies how to test your engine to develop deterioration factors that represent the deterioration expected in emissions over your engines' full useful life. Your

deterioration factors must take into account any available data from in-use testing with similar engines. Small-volume engine manufacturers may use assigned deterioration factors that we establish. Apply deterioration factors as follows:

(1) *Additive deterioration factor for exhaust emissions.* Except as specified in paragraph (c)(2) of this section, use an additive deterioration factor for exhaust emissions. An additive deterioration factor is the difference between exhaust emissions at the end of the useful life and exhaust emissions at the low-hour test point. In these cases, adjust the official emission results for each tested engine at the selected test point by adding the factor to the measured emissions. If the factor is less than zero, use zero. Additive deterioration factors must be specified to one more decimal place than the applicable standard.

(2) *Multiplicative deterioration factor for exhaust emissions.* Use a multiplicative deterioration factor if good engineering judgment calls for the deterioration factor for a pollutant to be the ratio of exhaust emissions at the end of the useful life to exhaust emissions at the low-hour test point. For example, if you use aftertreatment technology that controls emissions of a pollutant proportionally to engine-out emissions, it is often appropriate to use a multiplicative deterioration factor. Adjust the official emission results for each tested engine at the selected test point by multiplying the measured emissions by the deterioration factor. If the factor is less than one, use one. A multiplicative deterioration factor may not be appropriate in cases where testing variability is significantly greater than engine-to-engine variability. Multiplicative deterioration factors must be specified to one more significant figure than the applicable standard.

(3) *Sawtooth and other nonlinear deterioration patterns.* The deterioration factors described in paragraphs (c)(1) and (2) of this section assume that the highest useful life emissions occur either at the end of useful life or at the low-hour test point. The provisions of this paragraph (c)(3) apply where good engineering judgment indicates that the highest emissions over the useful life will occur between these two points. For example, emissions may increase with service accumulation until a certain maintenance step is performed, then return to the low-hour emission levels and begin increasing again. Base deterioration factors for engines with such emission patterns on the difference between (or ratio of) the point at which the highest emissions occur and the

low-hour test point. Note that this applies for maintenance-related deterioration only where we allow such critical emission-related maintenance.

(4) *Deterioration factor for smoke.* Deterioration factors for smoke are always additive, as described in paragraph (c)(1) of this section.

(5) *Deterioration factor for crankcase emissions.* If your engine vents crankcase emissions to the exhaust or to the atmosphere, you must account for crankcase emission deterioration, using good engineering judgment. You may use separate deterioration factors for crankcase emissions of each pollutant (either multiplicative or additive) or include the effects in combined deterioration factors that include exhaust and crankcase emissions together for each pollutant.

(6) *Dual-fuel and flexible-fuel engines.* In the case of dual-fuel and flexible-fuel engines, apply deterioration factors separately for each fuel type. You may accumulate service hours on a single emission-data engine using the type of fuel or the fuel mixture expected to have the highest combustion and exhaust temperatures; you may ask us to approve a different fuel mixture if you demonstrate that a different criterion is more appropriate.

(d) Determine the official emission result for each pollutant to at least one more decimal place than the applicable standard. Apply the deterioration factor to the official emission result, as described in paragraph (c) of this section, then round the adjusted figure to the same number of decimal places as the emission standard. Compare the rounded emission levels to the emission standard for each emission-data engine. In the case of NO<sub>x</sub>+NMHC standards, apply the deterioration factor to each pollutant and then add the results before rounding.

■ 159. Section 1039.250 is amended by revising paragraphs (b)(3)(iv) and (c) to read as follows:

**§ 1039.250 What records must I keep and what reports must I send to EPA?**

\* \* \* \* \*

(b) \* \* \*

(3) \* \* \*

(iv) All your emission tests, including the date and purpose of each test and documentation of test parameters as specified in part 40 CFR part 1065.

\* \* \* \* \*

(c) Keep required data from emission tests and all other information specified in this section for eight years after we issue your certificate. If you use the same emission data or other information for a later model year, the eight-year

period restarts with each year that you continue to rely on the information.

\* \* \* \* \*

■ 160. Section 1039.255 is amended by revising paragraphs (c)(2) and (4), (d), and (e) to read as follows:

**§ 1039.255 What decisions may EPA make regarding my certificate of conformity?**

\* \* \* \* \*

(c) \* \* \*

(2) Submit false or incomplete information (paragraph (e) of this section applies if this is fraudulent). This includes doing anything after submission of your application to render any of the submitted information false or incomplete.

\* \* \* \* \*

(4) Deny us from completing authorized activities (see 40 CFR 1068.20). This includes a failure to provide reasonable assistance.

\* \* \* \* \*

(d) We may void the certificate of conformity for an engine family if you fail to keep records, send reports, or give us information as required under this part or the Act. Note that these are also violations of 40 CFR 1068.101(a)(2).

(e) We may void your certificate if we find that you intentionally submitted false or incomplete information. This includes rendering submitted information false or incomplete after submission.

\* \* \* \* \*

**Subpart F—Test Procedures**

■ 161. Section 1039.501 is amended by revising paragraphs (a), (e), (f), and (g) and adding paragraph (h) to read as follows:

**§ 1039.501 How do I run a valid emission test?**

(a) Use the equipment and procedures for compression-ignition engines in 40 CFR part 1065 to determine whether engines meet the duty-cycle emission standards in subpart B of this part. Measure the emissions of all the exhaust constituents subject to emission standards as specified in 40 CFR part 1065. Measure CO<sub>2</sub>, N<sub>2</sub>O, and CH<sub>4</sub> as described in § 1039.235. Use the applicable duty cycles specified in §§ 1039.505 and 1039.510.

\* \* \* \* \*

(e) The following provisions apply for engines using aftertreatment technology with infrequent regeneration events that may occur during testing:

(1) Adjust measured emissions to account for aftertreatment technology with infrequent regeneration as described in § 1039.525.

(2) If your engine family includes engines with one or more emergency AECs approved under § 1039.115(g)(4) or (5), do not consider additional regenerations resulting from those AECs when developing adjustments to measured values under this paragraph (e).

(3) Invalidate a smoke test if active regeneration starts to occur during the test.

(f) You may disable any AECs that have been approved solely for emergency equipment applications under § 1039.115(g)(4). Note that the emission standards do not apply when any of these AECs are active.

(g) You may use special or alternate procedures to the extent we allow them under 40 CFR 1065.10.

(h) This subpart is addressed to you as a manufacturer, but it applies equally to anyone who does testing for you, and to us when we perform testing to determine if your engines meet emission standards.

■ 162. Section 1039.505 is amended by revising paragraph (b)(2) to read as follows:

**§ 1039.505 How do I test engines using steady-state duty cycles, including ramped-modal testing?**

\* \* \* \* \*

(b) \* \* \*

(2) Use the 6-mode duty cycle or the corresponding ramped-modal cycle described in paragraph (b) of Appendix II of this part for variable-speed engines below 19 kW. You may instead use the 8-mode duty cycle or the corresponding ramped-modal cycle described in paragraph (c) of Appendix II of this part if some engines from your engine family will be used in applications that do not involve governing to maintain engine operation around rated speed.

\* \* \* \* \*

■ 163. Section 1039.515 is amended by revising paragraph (a) to read as follows:

**§ 1039.515 What are the test procedures related to not-to-exceed standards?**

(a) *General provisions.* The provisions in 40 CFR 86.1370 apply for determining whether an engine meets the not-to-exceed emission standards in § 1039.101(e), except as noted in this section. Interpret references to vehicles and vehicle operation to mean equipment and equipment operation.

\* \* \* \* \*

■ 164. Section 1039.525 is revised to read as follows:

**§ 1039.525 How do I adjust emission levels to account for infrequent regenerating aftertreatment devices?**

For engines using aftertreatment technology with infrequent regeneration events that may occur during testing, take one of the following approaches to account for the emission impact of regeneration:

(a) You may use the calculation methodology described in 40 CFR 1065.680 to adjust measured emission results. Do this by developing an upward adjustment factor and a downward adjustment factor for each pollutant based on measured emission data and observed regeneration frequency as follows:

(1) Adjustment factors should generally apply to an entire engine family, but you may develop separate adjustment factors for different configurations within an engine family. Use the adjustment factors from this section for all testing for the engine family.

(2) You may use carryover or carry-across data to establish adjustment factors for an engine family as described in § 1039.235, consistent with good engineering judgment.

(3) For engines that are required to certify to both transient and steady-state duty cycles, calculate a separate adjustment factor for steady-state and transient operation.

(b) You may ask us to approve an alternate methodology to account for regeneration events. We will generally limit approval to cases where your engines use aftertreatment technology with extremely infrequent regeneration and you are unable to apply the provisions of this section.

(c) You may choose to make no adjustments to measured emission results if you determine that regeneration does not significantly affect emission levels for an engine family (or configuration) or if it is not practical to identify when regeneration occurs. If you choose not to make adjustments under paragraph (a) or (b) of this section, your engines must meet emission standards for all testing, without regard to regeneration.

**Subpart G—Special Compliance Provisions**

■ 165. Section 1039.601 is revised to read as follows:

**§ 1039.601 What compliance provisions apply?**

(a) Engine and equipment manufacturers, as well as owners, operators, and rebuilders of engines subject to the requirements of this part,



and all other persons, must observe the provisions of this part, the requirements and prohibitions in 40 CFR part 1068, and the provisions of the Act.

(b) Subpart C of this part describes how to test and certify dual-fuel and flexible-fuel engines. Some multi-fuel engines may not fit either of those defined terms. For such engines, we will determine whether it is most appropriate to treat them as single-fuel engines, dual-fuel engines, or flexible-fuel engines based on the range of possible and expected fuel mixtures. For example, an engine might burn natural gas but initiate combustion with a pilot injection of diesel fuel. If the engine is designed to operate with a single fueling algorithm (i.e., fueling rates are fixed at a given engine speed and load condition), we would generally treat it as a single-fuel engine. In this context, the combination of diesel fuel and natural gas would be its own fuel type. If the engine is designed to also operate on diesel fuel alone, we would generally treat it as a dual-fuel engine. If the engine is designed to operate on varying mixtures of the two fuels, we would generally treat it as a flexible-fuel engine. To the extent that requirements vary for the different fuels or fuel mixtures, we may apply the more stringent requirements.

■ 166. Section 1039.605 is amended by revising paragraphs (b), (d)(5), and (d)(8) to read as follows:

§ 1039.605 What provisions apply to engines certified under the motor-vehicle program?

\* \* \* \* \*

(b) *Equipment-manufacturer provisions.* If you are not an engine manufacturer, you may install motor-vehicle engines certified for the appropriate model year under 40 CFR part 86 in nonroad equipment as long as you meet all the requirements and conditions specified in paragraph (d) of this section. You must also add the fuel-inlet label we specify in § 1039.135(e). If you modify the motor-vehicle engine in any of the ways described in paragraph (d)(2) of this section, we will consider you a manufacturer of a new nonroad engine. Such engine modifications prevent you from using the provisions of this section.

\* \* \* \* \*

(d) \* \* \*

(5) You must add a permanent supplemental label to the engine in a position where it will remain clearly visible after installation in the equipment. In the supplemental label, do the following:

(i) Include the heading: “NONROAD ENGINE EMISSION CONTROL INFORMATION”.

(ii) Include your full corporate name and trademark. You may identify another company and use its trademark instead of yours if you comply with the branding provisions of 40 CFR 1068.45.

(iii) State: “THIS ENGINE WAS ADAPTED FOR NONROAD USE WITHOUT AFFECTING ITS EMISSION CONTROLS. THE EMISSION-CONTROL SYSTEM DEPENDS ON THE USE OF FUEL MEETING SPECIFICATIONS THAT APPLY FOR MOTOR-VEHICLE APPLICATIONS. OPERATING THE ENGINE ON OTHER FUELS MAY BE A VIOLATION OF FEDERAL LAW.”

(iv) State the date you finished modifying the engine (month and year), if applicable.

\* \* \* \* \*

(8) Send the Designated Compliance Officer written notification describing your plans before using the provisions of this section. In addition, by February 28 of each calendar year (or less often if we tell you), send the Designated Compliance Officer a signed letter with all the following information:

(i) Identify your full corporate name, address, and telephone number.

(ii) List the engine or equipment models for which you used this exemption in the previous year and describe your basis for meeting the sales restrictions of paragraph (d)(3) of this section.

(iii) State: “We prepared each listed [engine or equipment] model for nonroad application without making any changes that could increase its certified emission levels, as described in 40 CFR 1039.605.”

\* \* \* \* \*

■ 167. Section 1039.610 is amended by revising paragraphs (d)(5)(ii) and (d)(7) to read as follows:

§ 1039.610 What provisions apply to vehicles certified under the motor-vehicle program?

\* \* \* \* \*

(d) \* \* \*

(5) \* \* \*

(ii) Include your full corporate name and trademark. You may identify another company and use its trademark instead of yours if you comply with the branding provisions of 40 CFR 1068.45.

\* \* \* \* \*

(7) Send the Designated Compliance Officer written notification describing your plans before using the provisions of this section. In addition, by February 28 of each calendar year (or less often if we tell you), send the Designated

Compliance Officer a signed letter with all the following information:

(i) Identify your full corporate name, address, and telephone number.

(ii) List the equipment models for which you used this exemption in the previous year and describe your basis for meeting the sales restrictions of paragraph (d)(3) of this section.

(iii) State: “We prepared each listed engine or equipment model for nonroad application without making any changes that could increase its certified emission levels, as described in 40 CFR 1039.610.”

\* \* \* \* \*

§§ 1039.640 and 1039.660 [Removed]

■ 168. Sections 1039.640 and 1039.660 are removed.

■ 169. A new § 1039.699 is added to subpart G to read as follows:

§ 1039.699 Emission standards and certification requirements for auxiliary power units for highway tractors.

(a) This section describes emission standards and certification requirements for auxiliary power units (APU) installed on highway tractors subject to standards under 40 CFR 1037.106 starting in model year 2024.

(b) You may apply for a certificate of conformity under this section if you manufacture APUs, or if you install emission control hardware to meet the standard in this section.

(c) Exhaust emissions may not exceed a PM standard of 0.02 g/kW-hr when tested using the steady-state test procedures described in subpart F of this part for the duty cycles specified in § 1039.505(b)(1). Your APUs must meet the exhaust emission standards of this section over the engine’s useful life as specified in § 1039.101(g). These emission standards also apply for testing with production and in-use APUs.

(d) The APU is deemed to have a valid certificate of conformity under this section if the engine manufacturer certifies the engine under 40 CFR part 1039 with a family emission limit of 0.02 g/kW-hr or less.

(e) The APU may draw power from the installed engine to regenerate a particulate filter, but you must not make any other changes to the certified engine that could reasonably be expected to increase its emissions of any pollutant.

(f) Sections 1039.115, 1039.120, 1039.125, and 1039.130 apply for APUs as written. You must exercise due diligence in ensuring that your system will not adversely affect safety or otherwise violate the prohibition of § 1039.115(f).

(g) All your APUs are considered to be part of a single emission family; however, you may subdivide your APUs into multiple emission families if you show the expected emission characteristics are different during the useful life.

(h) Testing requirements apply for certification as follows:

(1) Select an emission-data APU representing a worst-case condition for PM emissions. Measure emissions from the test engine with the APU installed according to your specifications.

(2) We may require you to provide an engineering analysis showing that the performance of your emission controls will not deteriorate during the useful life with proper maintenance. If we determine that your emission controls are likely to deteriorate during the useful life, we may require you to develop and apply deterioration factors consistent with good engineering judgment.

(3) Collect emission data and round to the nearest 0.01 g/kW-hr for comparing to the standard. Calculate full-life emissions as described in § 1039.240(d) if you need to apply a deterioration factor.

(4) You may ask to use emission data from a previous production period instead of doing new tests as described in § 1039.235(d).

(5) Additional testing provisions apply as described in § 1039.235(c), (e), and (f).

(i) Your APU certificate is valid for any engine certified under this part 1039, as long as the engine has a maximum engine power no more than 10 percent greater than the maximum engine power of the engine used for certification testing under this section.

(j) The following provisions apply for determining whether your APU complies with the requirements of this section:

(1) For purposes of certification, your emission family is considered in compliance with the emission standards of this section if all emission-data APUs representing that family have test results showing compliance with the standards.

(2) Your engine family is deemed not to comply if any emission-data APU representing that family for certification has test results showing a full-life emission level above the PM standard.

(k) At the time of manufacture, affix a permanent and legible label identifying each APU. This applies even if the engine manufacturer certifies a compliant engine as described in paragraph (d) of this section. The label must meet the specifications described in 40 CFR 1068.45(a). The label must—

(1) Include the heading “EMISSION CONTROL INFORMATION”.

(2) Include your full corporate name and trademark.

(3) State: “THIS APU ENGINE COMPLIES WITH 40 CFR 1039.699.”

(l) [Reserved]

(m) See §§ 1039.201, 1039.210, 1039.220, 1039.225, 1039.250, and 1039.255 for general requirements related to obtaining a certificate of conformity. A certificate issued under this section may apply for a production period lasting up to five years. Include the following information in your application for certification, unless we ask you to include less information:

(1) Describe the emission family's specifications and other basic parameters of the APU's design and emission controls. List each distinguishable configuration in the emission family. For each APU configuration, list the maximum engine power for which the APU is designed to operate.

(2) Explain how the emission control system operates. Identify the part number of each component you describe.

(3) Describe the engines you selected for testing and the reasons for selecting them.

(4) Describe the test equipment and procedures that you used. Also describe any special or alternate test procedures you used.

(5) Describe how you operated the emission-data APU before testing, including any operation to break in the APU or otherwise stabilize emission levels. Describe any scheduled maintenance you did.

(6) List the specifications of the test fuel to show that it falls within the required ranges we specify in 40 CFR part 1065.

(7) Include the maintenance and warranty instructions you will provide (see §§ 1039.120 and 1039.125).

(8) Describe your emission control information label.

(9) Identify the emission family's deterioration factors and describe how you developed them, or summarize your analysis describing why you don't expect performance of emission controls to deteriorate. Present any emission test data you used for this.

(10) State that you operated your emission-data APU as described in the application (including the test procedures, test parameters, and test fuels) to show you meet the requirements of this part.

(11) Present emission data for PM.

(12) Report all test results, including those from invalid tests, whether or not they were conducted according to the

test procedures of subpart F of this part. We may ask you to send other information to confirm that your tests were valid under the requirements of this part and 40 CFR part 1065.

(13) Describe any adjustable operating parameters as described in § 1039.205(s).

(14) Unconditionally certify that all the APUs in the emission family comply with the requirements of this part, other referenced parts of the CFR, and the Clean Air Act.

(15) Provide additional information if we say we need it to evaluate your application.

(16) Name an agent for service located in the United States. Service on this agent constitutes service on you or any of your officers or employees for any action by EPA or otherwise by the United States related to the requirements of this part.

(n) If a highway tractor manufacturer violates 40 CFR 1037.106(g) by installing an APU from you that is not properly certified and labeled, you are presumed to have caused the violation (see 40 CFR 1068.101(c)).

#### Subpart H—Averaging, Banking, and Trading for Certification

■ 170. Section 1039.701 is amended by adding paragraph (h) to read as follows:

##### § 1039.701 General provisions.

\* \* \* \* \*

(h) You may use either of the following approaches to retire or forego emission credits:

(1) You may retire emission credits generated from any number of your engines. This may be considered donating emission credits to the environment. Identify any such credits in the reports described in § 1039.730. Engines must comply with the applicable FELs even if you donate or sell the corresponding emission credits under this paragraph (h). Those credits may no longer be used by anyone to demonstrate compliance with any EPA emission standards.

(2) You may certify a family using an FEL below the emission standard as described in this part and choose not to generate emission credits for that family. If you do this, you do not need to calculate emission credits for those families and you do not need to submit or keep the associated records described in this subpart for that family.

■ 171. Section 1039.705 is amended by revising paragraphs (b), (c) introductory text, and (c)(1) to read as follows:

##### § 1039.705 How do I generate and calculate emission credits?

\* \* \* \* \*

(b) For each participating family, calculate positive or negative emission credits relative to the otherwise applicable emission standard. Calculate positive emission credits for a family that has an FEL below the standard. Calculate negative emission credits for a family that has an FEL above the standard. Sum your positive and negative credits for the model year before rounding. Round the sum of emission credits to the nearest kilogram (kg), using consistent units throughout the following equation:

Emission credits (kg) = (Std - FEL) < (Volume) < (AvgPR) < (UL) < (10^-3)

Where:

Std = the emission standard, in grams per kilowatt-hour, that applies under subpart B of this part for engines not participating in the ABT program of this subpart (the "otherwise applicable standard").

FEL = the family emission limit for the engine family, in grams per kilowatt-hour.

Volume = the number of engines eligible to participate in the averaging, banking, and trading program within the given engine family during the model year, as described in paragraph (c) of this section.

AvgPR = the average value of maximum engine power values for the engine configurations within an engine family, calculated on a sales-weighted basis, in kilowatts.

UL = the useful life for the given engine family, in hours.

(c) As described in § 1039.730, compliance with the requirements of this subpart is determined at the end of the model year based on actual U.S.-directed production volumes. Do not include any of the following engines to calculate emission credits:

(1) Engines with a permanent exemption under subpart G of this part or under 40 CFR part 1068.

\* \* \* \* \*

■ 172. Section 1039.710 is amended by revising paragraph (c) to read as follows:

§ 1039.710 How do I average emission credits?

\* \* \* \* \*

(c) If you certify an engine family to an FEL that exceeds the otherwise applicable standard, you must obtain enough emission credits to offset the engine family's deficit by the due date for the final report required in § 1039.730. The emission credits used to address the deficit may come from your other engine families that generate emission credits in the same model year, from emission credits you have banked from previous model years, or from emission credits generated in the

same or previous model years that you obtained through trading.

■ 173. Section 1039.725 is amended by revising paragraph (b)(2) to read as follows:

§ 1039.725 What must I include in my application for certification?

\* \* \* \* \*

(b) \* \* \*

(2) Detailed calculations of projected emission credits (positive or negative) based on projected production volumes. We may require you to include similar calculations from your other engine families to demonstrate that you will be able to avoid negative credit balances for the model year. If you project negative emission credits for a family, state the source of positive emission credits you expect to use to offset the negative emission credits.

■ 174. Section 1039.730 is amended by revising paragraphs (b)(1), (b)(4), (c)(2), and (d) to read as follows:

§ 1039.730 What ABT reports must I send to EPA?

\* \* \* \* \*

(b) \* \* \*

(1) Engine-family designation and averaging set.

\* \* \* \* \*

(4) The projected and actual U.S.-directed production volumes for the model year. If you changed an FEL during the model year, identify the actual U.S.-directed production volume associated with each FEL.

\* \* \* \* \*

(c) \* \* \*

(2) State whether you will retain any emission credits for banking. If you choose to retire emission credits that would otherwise be eligible for banking, identify the engine families that generated the emission credits, including the number of emission credits from each family.

\* \* \* \* \*

(d) If you trade emission credits, you must send us a report within 90 days after the transaction, as follows:

(1) As the seller, you must include the following information in your report:

(i) The corporate names of the buyer and any brokers.

(ii) A copy of any contracts related to the trade.

(iii) The averaging set corresponding to the engine families that generated emission credits for the trade, including the number of emission credits from each averaging set.

(2) As the buyer, you must include the following information in your report:

(i) The corporate names of the seller and any brokers.

(ii) A copy of any contracts related to the trade.

(iii) How you intend to use the emission credits, including the number of emission credits you intend to apply for each averaging set.

\* \* \* \* \*

■ 175. Section 1039.735 is amended by revising paragraphs (a) and (b) to read as follows:

§ 1039.735 What records must I keep?

(a) You must organize and maintain your records as described in this section.

(b) Keep the records required by this section for at least eight years after the due date for the end-of-year report. You may not use emission credits for any engines if you do not keep all the records required under this section. You must therefore keep these records to continue to bank valid credits.

\* \* \* \* \*

■ 176. Section 1039.740 is amended by revising paragraph (a) to read as follows:

§ 1039.740 What restrictions apply for using emission credits?

\* \* \* \* \*

(a) Averaging sets. Emission credits may be exchanged only within an averaging set. For emission credits generated by Tier 4 engines, there are two averaging sets—one for engines at or below 560 kW and another for engines above 560 kW.

\* \* \* \* \*

Subpart I—Definitions and Other Reference Information

■ 177. Section 1039.801 is amended as follows:

■ a. By revising the definitions of "Aircraft" and "Designated Compliance Officer".

■ b. By removing the definition for "Designated Enforcement Officer".

■ c. By adding definitions for "Dual-fuel" and "Flexible-fuel" in alphabetical order.

■ d. By revising paragraph (1)(i) of the definition of "Model year" and the definitions of "Owners manual" and "Placed into service".

■ e. By removing the definition for "Point of first retail sale".

■ f. By revising the definition for "Sulfur-sensitive technology".

The revisions and additions read as follows:

§ 1039.801 What definitions apply to this part?

\* \* \* \* \*

*Aircraft* means any vehicle capable of sustained air travel more than 100 feet above the ground.

\* \* \* \* \*

*Designated Compliance Officer* means the Director, Diesel Engine Compliance Center, U.S. Environmental Protection Agency, 2000 Traverwood Drive, Ann Arbor, MI 48105; *complianceinfo@epa.gov*; *epa.gov/otaq/verify*.

\* \* \* \* \*

*Dual-fuel* means relating to an engine designed for operation on two different fuels but not on a continuous mixture of those fuels (see § 1039.601(b)). For purposes of this part, such an engine remains a dual-fuel engine even if it is designed for operation on three or more different fuels.

\* \* \* \* \*

*Flexible-fuel* means relating to an engine designed for operation on any mixture of two or more different fuels (see § 1039.601(b)).

\* \* \* \* \*

*Model year* means one of the following things:

(1) \* \* \*

(i) Calendar year of production.

\* \* \* \* \*

*Owners manual* means a document or collection of documents prepared by the engine manufacturer for the owner or operator to describe appropriate engine maintenance, applicable warranties, and any other information related to operating or keeping the engine. The owners manual is typically provided to the ultimate purchaser at the time of sale. The owners manual may be in paper or electronic format.

\* \* \* \* \*

*Placed into service* means put into initial use for its intended purpose. Engines and equipment do not qualify as being "placed into service" based on incidental use by a manufacturer or dealer.

\* \* \* \* \*

*Sulfur-sensitive technology* means an emission control technology that experiences a significant drop in emission control performance or emission-system durability when an engine is operated on low-sulfur diesel fuel (*i.e.*, fuel with a sulfur concentration of 300 to 500 ppm) as compared to when it is operated on ultra-low sulfur diesel fuel (*i.e.*, fuel with a sulfur concentration less than 15 ppm). Exhaust gas recirculation is not a sulfur-sensitive technology.

\* \* \* \* \*

■ 178. Section 1039.815 is revised to read as follows:

**§ 1039.815 What provisions apply to confidential information?**

The provisions of 40 CFR 1068.10 apply for information you consider confidential.

■ 179. Section 1039.825 is revised to read as follows:

**§ 1039.825 What reporting and recordkeeping requirements apply under this part?**

(a) This part includes various requirements to submit and record data or other information. Unless we specify otherwise, store required records in any format and on any media and keep them readily available for eight years after you send an associated application for certification, or eight years after you generate the data if they do not support an application for certification. You are expected to keep your own copy of required records rather than relying on someone else to keep records on your behalf. We may review these records at any time. You must promptly send us organized, written records in English if we ask for them. We may require you to submit written records in an electronic format.

(b) The regulations in § 1039.255, 40 CFR 1068.25, and 40 CFR 1068.101 describe your obligation to report truthful and complete information. This includes information not related to certification. Failing to properly report information and keep the records we specify violates 40 CFR 1068.101(a)(2), which may involve civil or criminal penalties.

(c) Send all reports and requests for approval to the Designated Compliance Officer (see § 1039.801).

(d) Any written information we require you to send to or receive from another company is deemed to be a required record under this section. Such records are also deemed to be submissions to EPA. We may require you to send us these records whether or not you are a certificate holder.

(e) Under the Paperwork Reduction Act (44 U.S.C. 3501 et seq), the Office of Management and Budget approves the reporting and recordkeeping specified in the applicable regulations. The following items illustrate the kind of reporting and recordkeeping we require for engines and equipment regulated under this part:

(1) We specify the following requirements related to engine certification in this part 1039:

(i) In § 1039.20 we require engine manufacturers to label stationary engines that do not meet the standards in this part.

(ii) In § 1039.135 we require engine manufacturers to keep certain records

related to duplicate labels sent to equipment manufacturers.

(iii) [Reserved]

(iv) In subpart C of this part we identify a wide range of information required to certify engines.

(v) [Reserved]

(vi) In subpart G of this part we identify several reporting and recordkeeping items for making demonstrations and getting approval related to various special compliance provisions. For example, equipment manufacturers must submit reports and keep records related to the flexibility provisions in § 1039.625.

(vii) In § 1039.725, 1039.730, and 1039.735 we specify certain records related to averaging, banking, and trading.

(2) We specify the following requirements related to testing in 40 CFR part 1065:

(i) In 40 CFR 1065.2 we give an overview of principles for reporting information.

(ii) In 40 CFR 1065.10 and 1065.12 we specify information needs for establishing various changes to published test procedures.

(iii) In 40 CFR 1065.25 we establish basic guidelines for storing test information.

(iv) In 40 CFR 1065.695 we identify the specific information and data items to record when measuring emissions.

(3) We specify the following requirements related to the general compliance provisions in 40 CFR part 1068:

(i) In 40 CFR 1068.5 we establish a process for evaluating good engineering judgment related to testing and certification.

(ii) In 40 CFR 1068.25 we describe general provisions related to sending and keeping information.

(iii) In 40 CFR 1068.27 we require manufacturers to make engines available for our testing or inspection if we make such a request.

(iv) In 40 CFR 1068.105 we require equipment manufacturers to keep certain records related to duplicate labels from engine manufacturers.

(v) In 40 CFR 1068.120 we specify recordkeeping related to rebuilding engines.

(vi) In 40 CFR part 1068, subpart C, we identify several reporting and recordkeeping items for making demonstrations and getting approval related to various exemptions.

(vii) In 40 CFR part 1068, subpart D, we identify several reporting and recordkeeping items for making demonstrations and getting approval related to importing engines.

(viii) In 40 CFR 1068.450 and 1068.455 we specify certain records

related to testing production-line engines in a selective enforcement audit.

(ix) In 40 CFR 1068.501 we specify certain records related to investigating and reporting emission-related defects.

(x) In 40 CFR 1068.525 and 1068.530 we specify certain records related to recalling nonconforming engines.

(xi) In 40 CFR part 1068, subpart G, we specify certain records for requesting a hearing.

**PART 1042—CONTROL OF EMISSIONS FROM NEW AND IN-USE MARINE COMPRESSION-IGNITION ENGINES AND VESSELS**

■ 180. The authority citation for part 1042 continues to read as follows:

Authority: 42 U.S.C. 7401–7671q.

**Subpart A—Overview and Applicability**

■ 181. Section 1042.1 is amended by revising paragraphs (a) and (c) introductory text to read as follows:

**§ 1042.1 Applicability.**

\* \* \* \* \*

(a) The emission standards of this part 1042 for freshly manufactured engines apply for new marine engines starting with the model years noted in the following table:

TABLE 1 TO § 1042.1—PART 1042 APPLICABILITY BY MODEL YEAR

Engine category	Maximum engine power <sup>a</sup>	Displacement (L/cyl) or application	Model year
Category 1	kW < 75	disp.< 0.9	<sup>b</sup> 2009
		75 ≤ kW ≤ 3700	2012
	kW > 3700	0.9 ≤ disp. < 1.2	2013
		1.2 ≤ disp. < 2.5	2014
		2.5 ≤ disp. < 3.5	2013
		3.5 ≤ disp. < 7.0	2012
Category 2	kW ≤ 3700	All	2014
		7.0 ≤ disp. < 15.0	2013
	kW > 3700	7.0 ≤ disp. < 15.0	2014
		15 ≤ disp. < 30	2014
Category 3	All	disp. ≥ 30	2011

<sup>a</sup> See § 1042.140, which describes how to determine maximum engine power.

<sup>b</sup> See Table 1 of § 1042.101 for the first model year in which this part 1042 applies for engines with maximum engine power below 75 kW and displacement at or above 0.9 L/cyl.

\* \* \* \* \*

(c) Freshly manufactured engines with maximum engine power at or above 37 kW and originally manufactured and certified before the model years identified in Table 1 to this section are subject to emission standards and requirements of 40 CFR part 94. The provisions of this part 1042 do not apply for such engines certified under 40 CFR part 94, except as follows beginning June 29, 2010:

\* \* \* \* \*

■ 182. Section 1042.2 is revised to read as follows:

**§ 1042.2 Who is responsible for compliance?**

The regulations in this part 1042 contain provisions that affect both engine manufacturers and others. However, the requirements of this part, other than those of subpart I of this part, are generally addressed to the engine manufacturer for freshly manufactured marine engines or other certificate holders. The term “you” generally means the engine manufacturer, as

defined in § 1042.901, especially for issues related to certification (including production-line testing, reporting, etc.). Note that for engines that become new after being placed into service (such as engines converted from highway or stationary use, or engines installed on vessels that are reflagged to become U.S. vessels), the requirements that normally apply for manufacturers of freshly manufactured engines apply to the importer or any other entity we allow to obtain a certificate of conformity.

■ 183. Section 1042.30 is revised to read as follows:

**§ 1042.30 Submission of information.**

Unless we specify otherwise, send all reports and requests for approval to the Designated Compliance Officer (see § 1042.901). See § 1042.925 for additional reporting and recordkeeping provisions.

**Subpart B—Emission Standards and Related Requirements**

■ 184. Section 1042.101 is amended by revising the section heading and

paragraphs (a), (b), (c), and (d)(1)(ii) to read as follows:

**§ 1042.101 Exhaust emission standards for Category 1 and Category 2 engines.**

(a) *Duty-cycle standards.* Exhaust emissions from your engines may not exceed emission standards, as follows:

(1) Measure emissions using the test procedures described in subpart F of this part.

(2) The following CO emission standards in this paragraph (a)(2) apply starting with the applicable model year identified in § 1042.1:

(i) 8.0 g/kW-hr for engines below 8 kW.

(ii) 6.6 g/kW-hr for engines at or above 8 kW and below 19 kW.

(iii) 5.5 g/kW-hr for engines at or above 19 kW and below 37 kW.

(iv) 5.0 g/kW-hr for engines at or above 37 kW.

(3) Except as described in paragraphs (a)(4) and (5) of this section, the Tier 3 standards for PM and NO<sub>x</sub>+HC emissions are described in the following tables:

TABLE 1 TO § 1042.101—TIER 3 STANDARDS FOR CATEGORY 1 ENGINES BELOW 3700 kW<sup>a</sup>

Power density and application	Displacement (L/cyl)	Maximum engine power	Model year	PM (g/kW-hr)	NO <sub>x</sub> +HC (g/kW-hr) <sup>b</sup>
All	disp. < 0.9	kW < 19	2009+	0.40	7.5
		19 ≤ kW < 75	2009–2013	0.30	7.5
			2014+	° 0.30	° 4.7

TABLE 1 TO § 1042.101—TIER 3 STANDARDS FOR CATEGORY 1 ENGINES BELOW 3700 kW<sup>a</sup>—Continued

Power density and application	Displacement (L/cyl)	Maximum engine power	Model year	PM (g/kW-hr)	NO <sub>x</sub> +HC (g/kW-hr) <sup>b</sup>
Commercial engines with kW/L ≤ 35	disp. < 0.9	kW ≥ 75	2012+	0.14	5.4
		all	2013+	0.12	5.4
	0.9 ≤ disp. < 1.2	kW < 600	2014–2017	0.11	5.6
			2018+	0.10	5.6
	1.2 ≤ disp. < 2.5	kW ≥ 600	2014+	0.11	5.6
			2013–2017	0.11	5.6
	2.5 ≤ disp. < 3.5	kW < 600	2018+	0.10	5.6
			2013+	0.11	5.6
	3.5 ≤ disp. < 7.0	kW < 600	2012–2017	0.11	5.8
			2018+	0.10	5.8
Commercial engines with kW/L > 35, and all recreational engines ≥ 75 kW.	disp. < 0.9	kW ≥ 600	2012+	0.11	5.8
		kW ≥ 75	2012+	0.15	5.8
	0.9 ≤ disp. < 1.2	all	2013+	0.14	5.8
			2014+	0.12	5.8
	2.5 ≤ disp. < 3.5	2013+	0.12	5.8	
3.5 ≤ disp. < 7.0	2012+	0.11	5.8		

<sup>a</sup>No Tier 3 standards apply for commercial Category 1 engines at or above 3700 kW. See § 1042.1(c) and paragraph (a)(7) of this section for the standards that apply for these engines.

<sup>b</sup>The applicable NO<sub>x</sub>+HC standards specified for Tier 2 engines in Appendix I of this part continue to apply instead of the values noted in the table for commercial engines at or above 2000 kW. FELs for these engines may not be higher than the Tier 1 NO<sub>x</sub> standard specified in Appendix I of this part.

<sup>c</sup>See paragraph (a)(4) of this section for alternative PM and NO<sub>x</sub>+HC standards for engines at or above 19 kW and below 75 kW with displacement below 0.9 L/cyl.

TABLE 2 TO § 1042.101— TIER 3 STANDARDS FOR CATEGORY 2 ENGINES BELOW 3700 kW<sup>a</sup>

Displacement (L/cyl)	Maximum engine power	Model year	PM (g/kW-hr)	NO <sub>x</sub> +HC (g/kW-hr)
7.0 ≤ disp. < 15.0	kW < 2000	2013+	0.14	6.2
	2000 ≤ kW ≤ 3700	2013+	0.14	<sup>b</sup> 7.8
15.0 ≤ disp. < 20.0 <sup>c</sup>	kW < 2000	2014+	0.34	7.0
20.0 ≤ disp. < 25.0 <sup>c</sup>	kW < 2000	2014+	0.27	9.8
25.0 ≤ disp. < 30.0 <sup>c</sup>	kW < 2000	2014+	0.27	11.0

<sup>a</sup>The Tier 3 standards in this table do not apply for Category 2 engines at or above 2000 kW with per-cylinder displacement at or above 15.0 liters, or for any Category 2 engines at or above 3700 kW. See § 1042.1(c) and paragraphs (a)(6) through (8) of this section for the standards that apply for these engines.

<sup>b</sup>For engines subject to the 7.8 g/kW-hr NO<sub>x</sub>+HC standard, FELs may not be higher than the Tier 1 NO<sub>x</sub> standards specified in Appendix I of this part.

<sup>c</sup>There are no Tier 3 standards for Category 2 engines with per-cylinder displacement at or above 15 and 20 liters with maximum engine power at or above 2000 kW. See paragraphs (a)(6) and (7) of this section for the Tier 4 standards that apply for these engines starting with the 2014 model year.

(4) For Tier 3 engines at or above 19 kW and below 75 kW with displacement below 0.9 L/cyl, you may alternatively certify some or all of your engine families to a PM emission standard of 0.20 g/kW-hr and a NO<sub>x</sub>+HC emission standard of 5.8 g/kW-hr for 2014 and later model years.

(5) Starting with the 2014 model year, recreational marine engines at or above 3700 kW (with any displacement) must be certified under this part 1042 to the Tier 3 standards specified in this section for 3.5 to 7.0 L/cyl recreational marine engines.

(6) Interim Tier 4 p.m. standards apply for 2014 and 2015 model year engines between 2000 and 3700 kW as specified in this paragraph (a)(6). These engines are considered to be Tier 4 engines.

(i) For Category 1 engines, the Tier 3 p.m. standards from Table 1 to this section continue to apply. PM FELs for these engines may not be higher than the applicable Tier 2 p.m. standards specified in Appendix I of this part.

(ii) For Category 2 engines with per-cylinder displacement below 15.0 liters, the Tier 3 p.m. standards from Table 2 to this section continue to apply. PM

FELs for these engines may not be higher than 0.27 g/kW-hr.

(iii) For Category 2 engines with per-cylinder displacement at or above 15.0 liters, the PM standard is 0.34 g/kW-hr for engines at or above 2000 kW and below 3300 kW, and 0.27 g/kW-hr for engines at or above 3300 kW and below 3700 kW. PM FELs for these engines may not be higher than 0.50 g/kW-hr.

(7) Except as described in paragraph (a)(8) of this section, the Tier 4 standards for PM, NO<sub>x</sub>, and HC emissions are described in the following table:

TABLE 3 TO § 1042.101—TIER 4 STANDARDS FOR CATEGORY 2 AND COMMERCIAL CATEGORY 1 ENGINES AT OR ABOVE 600 kW

Maximum engine power	Displacement (L/cyl)	Model year	PM (g/kW-hr)	NO <sub>x</sub> (g/kW-hr)	HC (g/kW-hr)
600 ≤ kW < 1400	all	2017+	0.04	1.8	0.19

TABLE 3 TO § 1042.101—TIER 4 STANDARDS FOR CATEGORY 2 AND COMMERCIAL CATEGORY 1 ENGINES AT OR ABOVE 600 kW—Continued

Maximum engine power	Displacement (L/cyl)	Model year	PM (g/kW-hr)	NO <sub>x</sub> (g/kW-hr)	HC (g/kW-hr)
1400 ≤ kW < 2000	all	2016+	0.04	1.8	0.19
2000 ≤ kW ≤ 3700 <sup>a</sup>	all	2014+	0.04	1.8	0.19
kW > 3700	disp. < 15.0	2014–2015	0.12	1.8	0.19
	15.0 ≤ disp. < 30.0	2014–2015	0.25	1.8	0.19
	all	2016+	0.06	1.8	0.19

<sup>a</sup>See paragraph (a)(6) of this section for interim PM standards that apply for model years 2014 and 2015 for engines between 2000 and 3700 kW. The Tier 4 NO<sub>x</sub> FEL cap for engines at or above 2000 kW and below 3700 kW is 7.0 g/kW-hr. Starting in the 2016 model year, the Tier 4 PM FEL cap for engines at or above 2000 kW and below 3700 kW is 0.34 g/kW-hr.

(8) The following optional provisions apply for complying with the Tier 3 and Tier 4 standards specified in paragraphs (a)(3) through (7) of this section:

(i) You may use NO<sub>x</sub> credits accumulated through the ABT program to certify Tier 4 engines to a NO<sub>x</sub>+HC emission standard of 1.9 g/kW-hr instead of the NO<sub>x</sub> and HC standards that would otherwise apply by certifying your family to a NO<sub>x</sub>+HC FEL. Calculate the NO<sub>x</sub> credits needed as specified in subpart H of this part using the NO<sub>x</sub>+HC emission standard and FEL in the calculation instead of the otherwise applicable NO<sub>x</sub> standard and

FEL. You may not generate credits relative to the alternate standard or certify to the standard without using credits.

(ii) For engines below 1000 kW, you may delay complying with the Tier 4 standards in the 2017 model year for up to nine months, but you must comply no later than October 1, 2017.

(iii) For engines at or above 3700 kW, you may delay complying with the Tier 4 standards in the 2016 model year for up to twelve months, but you must comply no later than December 31, 2016.

(iv) For Category 2 engines at or above 1400 kW, you may alternatively comply with the Tier 3 and Tier 4 standards specified in Table 4 of this section instead of the NO<sub>x</sub>, HC, NO<sub>x</sub>+HC, and PM standards specified in paragraphs (a)(3) through (7) of this section. The CO standards specified in paragraph (a)(2) of this section apply without regard to whether you choose this option. If you choose this option, you must do so for all engines at or above 1400 kW in the same displacement category (that is, 7–15, 15–20, 20–25, or 25–30 liters per cylinder) in model years 2012 through 2015.

TABLE 4 TO § 1042.101—OPTIONAL TIER 3 AND TIER 4 STANDARDS FOR CATEGORY 2 ENGINES AT OR ABOVE 1400 kW

Tier	Maximum engine power	Model year	PM (g/kW-hr)	NO <sub>x</sub> (g/kW-hr)	HC (g/kW-hr)
Tier 3	kW ≥ 1400	2012–2014	0.14	7.8 NO <sub>x</sub> +HC	.....
Tier 4	1400 ≤ kW ≤ 3700	2015	0.04	1.8	0.19
	kW > 3700	2015	0.06	1.8	0.19

(b) *Averaging, banking, and trading.* You may generate or use emission credits under the averaging, banking, and trading (ABT) program as described in subpart H of this part for demonstrating compliance with NO<sub>x</sub>, NO<sub>x</sub>+HC, and PM emission standards for Category 1 and Category 2 engines. You may also use NO<sub>x</sub> or NO<sub>x</sub>+HC emission credits to comply with the alternate NO<sub>x</sub>+HC standard in paragraph (a)(8)(i) of this section. Generating or using emission credits requires that you specify a family emission limit (FEL) for each pollutant you include in the ABT program for each engine family. These FELs serve as the emission standards for the engine family with respect to all required testing instead of the standards specified in paragraph (a) of this section. The FELs determine the not-to-exceed standards for your engine family, as specified in paragraph (c) of this section. Unless otherwise specified, the following FEL caps apply:

(1) FELs for Tier 3 engines may not be higher than the applicable Tier 2 standards specified in Appendix I of this part.

(2) FELs for Tier 4 engines may not be higher than the applicable Tier 3 standards specified in paragraph (a)(3) of this section.

(3) The following FEL caps apply for engines at or above 3700 kW that are not subject to Tier 3 standards under paragraph (a)(3) of this section:

(i) FELs may not be higher than the applicable Tier 1 NO<sub>x</sub> standards specified in Appendix I of this part before the Tier 4 standards start to apply.

(ii) FELs may not be higher than the applicable Tier 2 NO<sub>x</sub>+THC standards specified in Appendix I of this part after the Tier 4 standards start to apply.

(c) *Not-to-exceed standards.* Except as noted in § 1042.145(e), exhaust emissions from all engines subject to the requirements of this part may not exceed the not-to-exceed (NTE) standards as follows:

(1) Use the following equation to determine the NTE standards:

(i) NTE standard for each pollutant = STD × M.

Where:

STD = The standard specified for that pollutant in this section if you certify without using ABT for that pollutant; or the FEL for that pollutant if you certify using ABT.

M = The NTE multiplier for that pollutant.

(ii) Round each NTE standard to the same number of decimal places as the emission standard.

(2) Determine the applicable NTE zone and subzones as described in § 1042.515. Determine NTE multipliers for specific zones and subzones and pollutants as follows:

(i) For marine engines certified using the duty cycle specified in § 1042.505(b)(1), except for variable-speed propulsion marine engines used with controllable-pitch propellers or with electrically coupled propellers, apply the following NTE multipliers:

(A) Subzone 1: 1.2 for Tier 3 NO<sub>x</sub>+HC standards.

(B) Subzone 1: 1.5 for Tier 4 standards and Tier 3 p.m. and CO standards.

(C) Subzone 2: 1.5 for Tier 4 NO<sub>x</sub> and HC standards and for Tier 3 NO<sub>x</sub>+HC standards.

(D) Subzone 2: 1.9 for PM and CO standards.

(ii) For recreational marine engines certified using the duty cycle specified in § 1042.505(b)(2), except for variable-speed marine engines used with controllable-pitch propellers or with electrically coupled propellers, apply the following NTE multipliers:

(A) Subzone 1: 1.2 for Tier 3 NO<sub>x</sub>+HC standards.

(B) Subzone 1: 1.5 for Tier 3 p.m. and CO standards.

(C) Subzones 2 and 3: 1.5 for Tier 3 NO<sub>x</sub>+HC standards.

(D) Subzones 2 and 3: 1.9 for PM and CO standards.

(iii) For variable-speed marine engines used with controllable-pitch propellers or with electrically coupled propellers that are certified using the duty cycle specified in § 1042.505(b)(1), (2), or (3), apply the following NTE multipliers:

(A) Subzone 1: 1.2 for Tier 3 NO<sub>x</sub>+HC standards.

(B) Subzone 1: 1.5 for Tier 4 standards and Tier 3 p.m. and CO standards.

(C) Subzone 2: 1.5 for Tier 4 NO<sub>x</sub> and HC standards and for Tier 3 NO<sub>x</sub>+HC standards.

(D) Subzone 2: 1.9 for PM and CO standards. However, there is no NTE standard in Subzone 2b for PM emissions if the engine family's applicable standard for PM is at or above 0.07 g/kW-hr.

(iv) For constant-speed engines certified using a duty cycle specified in § 1042.505(b)(3) or (4), apply the following NTE multipliers:

(A) Subzone 1: 1.2 for Tier 3 NO<sub>x</sub>+HC standards.

(B) Subzone 1: 1.5 for Tier 4 standards and Tier 3 p.m. and CO standards.

(C) Subzone 2: 1.5 for Tier 4 NO<sub>x</sub> and HC standards and for Tier 3 NO<sub>x</sub>+HC standards.

(D) Subzone 2: 1.9 for PM and CO standards. However, there is no NTE standard for PM emissions if the engine family's applicable standard for PM is at or above 0.07 g/kW-hr.

(v) For variable-speed auxiliary marine engines certified using the duty cycle specified in § 1042.505(b)(5)(ii) or (iii):

(A) Subzone 1: 1.2 for Tier 3 NO<sub>x</sub>+HC standards.

(B) Subzone 1: 1.5 for Tier 4 standards and Tier 3 p.m. and CO standards.

(C) Subzone 2: 1.2 for Tier 3 NO<sub>x</sub>+HC standards.

(D) Subzone 2: 1.5 for Tier 4 standards and Tier 3 p.m. and CO standards. However, there is no NTE standard for PM emissions if the engine family's applicable standard for PM is at or above 0.07 g/kW-hr.

(3) The NTE standards apply to your engines whenever they operate within the NTE zone for an NTE sampling period of at least thirty seconds, during which only a single operator demand set point may be selected. Engine operation during a change in operator demand is excluded from any NTE sampling period. There is no maximum NTE sampling period.

(4) Collect emission data for determining compliance with the NTE standards using the procedures described in subpart F of this part.

(5) You may ask us to accept as compliant an engine that does not fully meet specific requirements under the applicable NTE standards where such deficiencies are necessary for safety.

(d) \* \* \*

(1) \* \* \*

(ii) Gaseous-fueled engines must comply with HC standards based on nonmethane-nonethane hydrocarbon emissions.

\* \* \* \* \*

■ 185. Section 1042.104 is amended by revising paragraph (a)(2) to read as follows:

**§ 1042.104 Exhaust emission standards for Category 3 engines.**

(a) \* \* \*

(2) NO<sub>x</sub> standards apply based on the engine's model year and maximum in-use engine speed as shown in the following table:

TABLE 1 TO § 1042.104—NO<sub>x</sub> EMISSION STANDARDS FOR CATEGORY 3 ENGINES (G/KW-HR)

Emission standards	Model year	Maximum in-use engine speed		
		Less than 130 RPM	130–2000 RPM <sup>a</sup>	Over 2000 RPM
Tier 1 .....	2004–2010 <sup>b</sup> .....	17.0	45.0 · n <sup>(-0.20)</sup> ...	9.8
Tier 2 .....	2011–2015 .....	14.4	44.0 · n <sup>(-0.23)</sup> ...	7.7
Tier 3 <sup>c</sup> .....	2016 and later .....	3.4	9.0 · n <sup>(-0.20)</sup> .....	2.0

<sup>a</sup> Applicable standards are calculated from n (maximum in-use engine speed, in RPM, as specified in § 1042.140). Round the standards to one decimal place.

<sup>b</sup> Tier 1 NO<sub>x</sub> standards apply as specified in 40 CFR part 94 for engines originally manufactured in model years 2004 through 2010. They are shown here only for reference.

<sup>c</sup> For engines designed with on-off controls as specified in § 1042.115(g), the Tier 2 standards continue to apply any time the engine has disabled its Tier 3 NO<sub>x</sub> emission controls.

\* \* \* \* \*

■ 186. Section 1042.110 is amended by revising paragraphs (a)(1) and (d) and removing and reserving paragraph (b). The revisions read as follows:

**§ 1042.110 Recording reductant use and other diagnostic functions.**

(a) \* \* \*

(1) The diagnostic system must monitor reductant quality and tank levels and alert operators to the need to refill the reductant tank before it is empty, or to replace the reductant if it

does not meet your concentration specifications. Unless we approve other alerts, use a malfunction-indicator light (MIL) and an audible alarm. You do not need to separately monitor reductant quality if your system uses input from an exhaust NO<sub>x</sub> sensor (or other sensor) to alert operators when reductant quality is inadequate. However, tank level must be monitored in all cases.

\* \* \* \* \*

(d) For Category 3 engines equipped with on-off NO<sub>x</sub> controls (as allowed by

§ 1042.115(g)), you must also equip your engine to continuously monitor NO<sub>x</sub> concentrations in the exhaust. See § 1042.650 to determine if this requirement applies for a given Category 1 or Category 2 engine. For measurement technologies involving discrete sampling events, measurements are considered continuous if they repeat at least once every 60 seconds; we may approve a longer sampling period if it is necessary or appropriate for sufficiently accurate measurements. Describe your



system for onboard NO<sub>x</sub> measurements in your application for certification. Use good engineering judgment to alert operators if measured NO<sub>x</sub> concentrations indicate malfunctioning emission controls. Record any such operation in nonvolatile computer memory. You are not required to monitor NO<sub>x</sub> concentrations during operation for which the emission controls may be disabled under § 1042.115(g). For the purpose of this paragraph (d), "malfunctioning emission controls" means any condition in which the measured NO<sub>x</sub> concentration exceeds the highest value expected when the engine is in compliance with the installed engine standard of § 1042.104(g). Use good engineering judgment to determine these expected values during production-line testing of the engine using linear interpolation between test points and accounting for the degree to which the cycle-weighted emissions of the engine are below the standard. You may also use additional intermediate test points measured during the production-line test. Note that the provisions of paragraph (a) of this section also apply for SCR systems covered by this paragraph (d). For engines subject to both the provisions of paragraph (a) of this section and this paragraph (d), use good engineering judgment to integrate diagnostic features to comply with both paragraphs. For example, engines may use on-off NO<sub>x</sub> controls to disable certain emission control functions only if the diagnostic system indicates that the monitoring described in this paragraph (d) is active.

■ 187. Section 1042.120 is amended by revising paragraph (b) introductory text to read as follows:

**§ 1042.120 Emission-related warranty requirements.**

(b) *Warranty period.* Your emission-related warranty must be valid for at least as long as the minimum warranty periods listed in this paragraph (b) in hours of operation and years, whichever comes first. You may offer an emission-related warranty more generous than we require. The emission-related warranty for the engine may not be shorter than any basic mechanical warranty you provide without charge for the engine. Similarly, the emission-related warranty for any component may not be shorter than any warranty you provide without charge for that component. This means that your warranty may not treat emission-related and nonemission-related defects differently for any component. If an engine has no hour meter, we base the warranty periods in

this paragraph (b) only on the engine's age (in years). The warranty period begins when the engine is placed into service. The following minimum warranty periods apply:

\* \* \* \* \*

■ 188. Section 1042.125 is amended by revising paragraphs (a)(2)(i), (a)(3)(i), (c), (e), and (f) introductory text to read as follows:

**§ 1042.125 Maintenance instructions.**

\* \* \* \* \*

(a) \* \* \*

(2) \* \* \*

(i) For EGR-related filters and coolers, DEF filters, crankcase ventilation valves and filters, and fuel injector tips (cleaning only), the minimum interval is 1,500 hours.

\* \* \* \* \*

(3) \* \* \*

(i) For EGR-related filters and coolers, DEF filters, crankcase ventilation valves and filters, and fuel injector tips (cleaning only), the minimum interval is 1,500 hours.

\* \* \* \* \*

(c) *Special maintenance.* You may specify more frequent maintenance to address problems related to special situations, such as atypical engine operation. You must clearly state that this additional maintenance is associated with the special situation you are addressing. You may also address maintenance of low-use engines (such as recreational or stand-by engines) by specifying the maintenance interval in terms of calendar months or years in addition to your specifications in terms of engine operating hours. All special maintenance instructions must be consistent with good engineering judgment. We may disapprove your maintenance instructions if we determine that you have specified special maintenance steps to address maintenance that is unlikely to occur in use, or engine operation that is not atypical. For example, this paragraph (c) does not allow you to design engines that require special maintenance for a certain type of expected operation. If we determine that certain maintenance items do not qualify as special maintenance under this paragraph (c), you may identify this as recommended additional maintenance under paragraph (b) of this section.

\* \* \* \* \*

(e) *Maintenance that is not emission-related.* For maintenance unrelated to emission controls, you may schedule any amount of inspection or maintenance. You may also take these inspection or maintenance steps during service accumulation on your emission-

data engines, as long as they are reasonable and technologically necessary. This might include adding engine oil, changing air, fuel, or oil filters, servicing engine-cooling systems, and adjusting idle speed, governor, engine bolt torque, valve lash, or injector lash. You may not perform this nonemission-related maintenance on emission-data engines more often than the least frequent intervals that you recommend to the ultimate purchaser.

(f) *Source of parts and repairs.* State clearly in your written maintenance instructions that a repair shop or person of the owner's choosing may maintain, replace, or repair emission control devices and systems. Your instructions may not require components or service identified by brand, trade, or corporate name. Also, do not directly or indirectly condition your warranty on a requirement that the engine be serviced by your franchised dealers or any other service establishments with which you have a commercial relationship. You may disregard the requirements in this paragraph (f) if you do one of two things:

\* \* \* \* \*

■ 189. Section 1042.130 is amended by revising paragraph (b) to read as follows:

**§ 1042.130 Installation instructions for vessel manufacturers.**

\* \* \* \* \*

(b) Make sure these instructions have the following information:

(1) Include the heading: "Emission-related installation instructions".

(2) State: "Failing to follow these instructions when installing a certified engine in a vessel violates federal law (40 CFR 1068.105(b)), subject to fines or other penalties as described in the Clean Air Act."

(3) Describe the instructions needed to properly install the exhaust system and any other components. Include instructions consistent with the requirements of § 1042.205(u).

(4) Describe any necessary steps for installing the diagnostic system described in § 1042.110.

(5) Describe how your certification is limited for any type of application. . For example, if your engines are certified only for constant-speed operation, tell vessel manufacturers not to install the engines in variable-speed applications or modify the governor.

(6) Describe any other instructions to make sure the installed engine will operate according to design specifications in your application for certification. This may include, for example, instructions for installing aftertreatment devices when installing the engines.

(7) State: "If you install the engine in a way that makes the engine's emission control information label hard to read during normal engine maintenance, you must place a duplicate label on the vessel, as described in 40 CFR 1068.105."

(8) Describe any vessel labeling requirements specified in § 1042.135.

\* \* \* \* \*

■ 190. Section 1042.135 is amended by revising paragraphs (b), (c), (d)(1), and (e) introductory text to read as follows:

**§ 1042.135 Labeling.**

\* \* \* \* \*

(b) At the time of manufacture, affix a permanent and legible label identifying each engine. The label must meet the requirements of 40 CFR 1068.45.

(c) The label must—

(1) Include the heading "EMISSION CONTROL INFORMATION".

(2) Include your full corporate name and trademark. You may identify another company and use its trademark instead of yours if you comply with the branding provisions of 40 CFR 1068.45.

(3) Include EPA's standardized designation for the engine family (and subfamily, where applicable).

(4) Identify all the emission standards that apply to the engine (or FELs, if applicable). If you do not declare an FEL under subpart H of this part, you may alternatively state the engine's category, displacement (in liters or L/cyl), maximum engine power (in kW), and power density (in kW/L) as needed to determine the emission standards for the engine family. You may specify displacement, maximum engine power, or power density as a range consistent with the ranges listed in § 1042.101. See § 1042.140 for descriptions of how to specify per-cylinder displacement, maximum engine power, and power density.

(5) State the date of manufacture [DAY (optional), MONTH, and YEAR]; however, you may omit this from the label if you stamp, engrave, or otherwise permanently identify it elsewhere on the engine, in which case you must also describe in your application for certification where you will identify the date on the engine.

(6) Identify the application(s) for which the engine family is certified (such as constant-speed auxiliary, variable-speed propulsion engines used with fixed-pitch propellers, etc.). If the engine is certified as a recreational engine, state: "INSTALLING THIS RECREATIONAL ENGINE IN A COMMERCIAL VESSEL OR USING THE VESSEL FOR COMMERCIAL

PURPOSES MAY VIOLATE FEDERAL LAW SUBJECT TO CIVIL PENALTY (40 CFR 1042.601)."

(7) For engines using sulfur-sensitive technologies, state: "ULTRA LOW SULFUR DIESEL FUEL ONLY".

(8) State the useful life for your engine family if the applicable useful life is based on the provisions of § 1042.101(e)(2) or (3), or § 1042.104(d)(2).

(9) Identify the emission control system. Use terms and abbreviations as described in 40 CFR 1068.45. You may omit this information from the label if there is not enough room for it and you put it in the owners manual instead.

(10) State: "THIS MARINE ENGINE COMPLIES WITH U.S. EPA REGULATIONS FOR [MODEL YEAR]."

(11) For a Category 1 or Category 2 engine that can be modified to operate on residual fuel, but has not been certified to meet the standards on such a fuel, include the statement: "THIS ENGINE IS CERTIFIED FOR OPERATION ONLY WITH DIESEL FUEL. MODIFYING THE ENGINE TO OPERATE ON RESIDUAL OR INTERMEDIATE FUEL MAY BE A VIOLATION OF FEDERAL LAW SUBJECT TO CIVIL PENALTIES."

(12) For an engine equipped with on-off emission controls as allowed by § 1042.115, include the statement: "THIS ENGINE IS CERTIFIED WITH ON-OFF EMISSION CONTROLS. OPERATION OF THE ENGINE CONTRARY TO 40 CFR 1042.115(g) IS A VIOLATION OF FEDERAL LAW SUBJECT TO CIVIL PENALTIES."

(13) For engines intended for installation on domestic or public vessels, include the following statement: "THIS ENGINE DOES NOT COMPLY WITH INTERNATIONAL MARINE REGULATIONS FOR COMMERCIAL VESSELS UNLESS IT IS ALSO COVERED BY AN EIAPP CERTIFICATE."

(d) \* \* \*

(1) You may identify other emission standards that the engine meets or does not meet (such as international standards), as long as this does not cause you to omit any of the information described in paragraphs (c)(5) through (9) of this section. You may add the information about the other emission standards to the statement we specify, or you may include it in a separate statement.

\* \* \* \* \*

(e) For engines using sulfur-sensitive technologies, create a separate label with the statement: "ULTRA LOW SULFUR DIESEL FUEL ONLY". Permanently attach this label to the

vessel near the fuel inlet or, if you do not manufacture the vessel, take one of the following steps to ensure that the vessel will be properly labeled:

\* \* \* \* \*

■ 191. Section 1042.140 is amended by revising paragraph (e) to read as follows:

**§ 1042.140 Maximum engine power, displacement, power density, and maximum in-use engine speed.**

\* \* \* \* \*

(e) Throughout this part, references to a specific power value for an engine are based on maximum engine power. For example, the group of engines with maximum engine power below 600 kW may be referred to as engines below 600 kW.

\* \* \* \* \*

**Subpart C—Certifying Engine Families**

■ 192. Section 1042.201 is amended by revising paragraphs (a) and (g) to read as follows:

**§ 1042.201 General requirements for obtaining a certificate of conformity.**

(a) You must send us a separate application for a certificate of conformity for each engine family. A certificate of conformity is valid for new production from the indicated effective date until the end of the model year for which it is issued, which may not extend beyond December 31 of that year. No certificate will be issued after December 31 of the model year. You may amend your application for certification after the end of the model year in certain circumstances as described in §§ 1042.220 and 1042.225. You must renew your certification annually for any engines you continue to produce.

\* \* \* \* \*

(g) We may require you to deliver your test engines to a facility we designate for our testing (see § 1042.235(c)). Alternatively, you may choose to deliver another engine that is identical in all material respects to the test engine, or another engine that we determine can appropriately serve as an emission-data engine for the engine family.

\* \* \* \* \*

■ 193. Section 1042.205 is amended by revising paragraphs (g), (o), (r)(1), and (bb)(1) to read as follows:

**§ 1042.205 Application requirements.**

\* \* \* \* \*

(g) List the specifications of the test fuel (or mixture of test fuels) to show that they fall within the required ranges we specify in 40 CFR part 1065.

\* \* \* \* \*

(o) Present emission data for HC, NO<sub>x</sub>, PM, and CO on an emission-data engine to show your engines meet emission standards as specified in §§ 1042.101 or 1042.104. Note that you must submit PM data for all engines, whether or not a PM standard applies. Show emission figures before and after applying adjustment factors for regeneration and deterioration factors for each pollutant and for each engine. If we specify more than one grade of any fuel type (for example, high-sulfur and low-sulfur diesel fuel), you need to submit test data only for one grade, unless the regulations of this part specify otherwise for your engine. Include emission results for each mode for Category 3 engines or for other engines if you do discrete-mode testing under § 1042.505. For engines using on-off controls as described in § 1042.115(g), include emission data demonstrating compliance with the Tier 2 standards when the engines Tier 3 NO<sub>x</sub> emission controls are disabled. Note that §§ 1042.235 and 1042.245 allows you to submit an application in certain cases without new emission data.

\* \* \* \* \*

(r) \* \* \*

(1) Report all valid test results involving measurement of pollutants for which emission standards apply. Also indicate whether there are test results from invalid tests or from any other tests of the emission-data engine, whether or not they were conducted according to the test procedures of subpart F of this part. We may require you to report these additional test results. We may ask you to send other information to confirm that your tests were valid under the requirements of this part and 40 CFR part 1065.

\* \* \* \* \*

(bb) \* \* \*

(1) Describe your normal practice for importing engines. For example, this may include identifying the names and addresses of any agents you have authorized to import your engines.

\* \* \* \* \*

■ 194. Section 1042.225 is amended by adding paragraphs (b)(4) and (g) to read as follows:

**§ 1042.225 Amending applications for certification.**

\* \* \* \* \*

(b) \* \* \*

(4) Include any other information needed to make your application correct and complete.

\* \* \* \* \*

(g) You may produce engines as described in your amended application

for certification and consider those engines to be in a certified configuration if we approve a new or modified engine configuration during the model year under paragraph (d) of this section. Similarly, you may modify in-use engines as described in your amended application for certification and consider those engines to be in a certified configuration if we approve a new or modified engine configuration at any time under paragraph (d) of this section. Modifying a new or in-use engine to be in a certified configuration does not violate the tampering prohibition of 40 CFR 1068.101(b)(1), as long as this does not involve changing to a certified configuration with a higher family emission limit.

■ 195. Section 1042.235 is amended by revising paragraphs (b), (c) introductory text, (c)(4), and (d)(1) to read as follows:

**§ 1042.235 Emission testing related to certification.**

\* \* \* \* \*

(b) Test your emission-data engines using the procedures and equipment specified in subpart F of this part. In the case of dual-fuel engines, measure emissions when operating with each type of fuel for which you intend to certify the engine. In the case of flexible-fuel engines, measure emissions when operating with the fuel mixture that best represents in-use operation or is most likely to have the highest NO<sub>x</sub> emissions (or NO<sub>x</sub>+HC emissions for engines subject to NO<sub>x</sub>+HC standards), though you may ask us to instead to perform tests with both fuels separately if you can show that intermediate mixtures are not likely to occur in use.

\* \* \* \* \*

(c) We may perform confirmatory testing by measuring emissions from any of your emission-data engines or other engines from the engine family, as follows:

\* \* \* \* \*

(4) Before we test one of your engines, we may calibrate it within normal production tolerances for anything we do not consider an adjustable parameter. For example, this would apply for an engine parameter that is subject to production variability because it is adjustable during production, but is not considered an adjustable parameter (as defined in § 1042.901) because it is permanently sealed. For parameters that relate to a level of performance that is itself subject to a specified range (such as maximum power output), we will generally perform any calibration under this paragraph (c)(4) in a way that keeps performance within the specified range.

(d) \* \* \*

(1) The engine family from the previous model year differs from the current engine family only with respect to model year, items identified in § 1042.225(a), or other characteristics unrelated to emissions. We may waive this criterion for differences we determine not to be relevant.

\* \* \* \* \*

■ 196. Section 1042.240 is amended by revising paragraph (c)(3), adding paragraphs (c)(4) and (5), and revising paragraph (d) to read as follows:

**§ 1042.240 Demonstrating compliance with exhaust emission standards.**

\* \* \* \* \*

(c) \* \* \*

(3) *Sawtooth and other nonlinear deterioration patterns.* The deterioration factors described in paragraphs (c)(1) and (2) of this section assume that the highest useful life emissions occur either at the end of useful life or at the low-hour test point. The provisions of this paragraph (c)(3) apply where good engineering judgment indicates that the highest emissions over the useful life will occur between these two points. For example, emissions may increase with service accumulation until a certain maintenance step is performed, then return to the low-hour emission levels and begin increasing again. Base deterioration factors for engines with such emission patterns on the difference between (or ratio of) the point at which the highest emissions occur and the low-hour test point. Note that this applies for maintenance-related deterioration only where we allow such critical emission-related maintenance.

(4) *Deterioration factor for crankcase emissions.* If your engine vents crankcase emissions to the exhaust or to the atmosphere, you must account for crankcase emission deterioration, using good engineering judgment. You may use separate deterioration factors for crankcase emissions of each pollutant (either multiplicative or additive) or include the effects in combined deterioration factors that include exhaust and crankcase emissions together for each pollutant.

(5) *Dual-fuel and flexible-fuel engines.* In the case of dual-fuel and flexible-fuel engines, apply deterioration factors separately for each fuel type. You may accumulate service hours on a single emission-data engine using the type of fuel or the fuel mixture expected to have the highest combustion and exhaust temperatures; you may ask us to approve a different fuel mixture if you demonstrate that a different criterion is more appropriate.

(d) Determine the official emission result for each pollutant to at least one

more decimal place than the applicable standard. Apply the deterioration factor to the official emission result, as described in paragraph (c) of this section, then round the adjusted figure to the same number of decimal places as the emission standard. Compare the rounded emission levels to the emission standard for each emission-data engine. In the case of NO<sub>x</sub>+HC standards, apply the deterioration factor to each pollutant and then add the results before rounding.

\* \* \* \* \*

■ 197. Section 1042.250 is amended by revising paragraphs (b)(3)(iv) and (c) to read as follows:

**§ 1042.250 Recordkeeping and reporting.**

\* \* \* \* \*

(b) \* \* \*

(3) \* \* \*

(iv) All your emission tests, including the date and purpose of each test and documentation of test parameters as specified in part 40 CFR part 1065.

\* \* \* \* \*

(c) Keep required data from emission tests and all other information specified in this section for eight years after we issue your certificate. If you use the same emission data or other information for a later model year, the eight-year period restarts with each year that you continue to rely on the information.

\* \* \* \* \*

■ 198. Section 1042.255 is amended by revising paragraphs (c)(2), (d), and (e) to read as follows:

**§ 1042.255 EPA decisions.**

\* \* \* \* \*

(c) \* \* \*

(2) Submit false or incomplete information (paragraph (e) of this section applies if this is fraudulent). This includes doing anything after submission of your application to render any of the submitted information false or incomplete.

\* \* \* \* \*

(d) We may void the certificate of conformity for an engine family if you fail to keep records, send reports, or give us information as required under this part or the Clean Air Act. Note that these are also violations of 40 CFR 1068.101(a)(2).

(e) We may void your certificate if we find that you intentionally submitted false or incomplete information. This includes rendering submitted information false or incomplete after submission.

\* \* \* \* \*

**Subpart D—Testing Production-Line Engines**

■ 199. Section 1042.301 is amended by revising paragraph (a) introductory text to read as follows:

**§ 1042.301 General provisions.**

(a) If you produce freshly manufactured marine engines that are subject to the requirements of this part, you must test them as described in this subpart, except as follows:

\* \* \* \* \*

■ 200. Section 1042.302 is amended by revising paragraph (a) to read as follows:

**§ 1042.302 Applicability of this subpart for Category 3 engines.**

\* \* \* \* \*

(a) You must test each Category 3 engine at the sea trial of the vessel in which it is installed or within the first 300 hours of operation, whichever occurs first. This may involve testing a fully assembled production engine before it is installed in the vessel. Since you must test each engine, the provisions of §§ 1042.310 and 1042.315(b) do not apply for Category 3 engines. If we determine that an engine failure under this subpart is caused by defective components or design deficiencies, we may revoke or suspend your certificate for the engine family as described in § 1042.340. If we determine that an engine failure under this subpart is caused only by incorrect assembly, we may suspend your certificate for the engine family as described in § 1042.325. If the engine fails, you may continue operating only to complete the sea trial and return to port. It is a violation of 40 CFR 1068.101(b)(1) to operate the vessel further until you remedy the cause of failure. Each two-hour period of such operation constitutes a separate offense. A violation lasting less than two hours constitutes a single offense.

\* \* \* \* \*

**Subpart F—Test Procedures**

■ 201. Section 1042.501 is amended by revising paragraphs (a), (d), (e), and (f) and adding paragraph (h) to read as follows:

**§ 1042.501 How do I run a valid emission test?**

\* \* \* \* \*

(a) Use the equipment and procedures for compression-ignition engines in 40 CFR part 1065 to determine whether engines meet the duty-cycle emission standards in §§ 1042.101 or 1042.104. Measure the emissions of all regulated pollutants as specified in 40 CFR part

1065. Use the applicable duty cycles specified in § 1042.505. The following exceptions from the 40 CFR part 1065 procedures apply:

(1) If you perform discrete-mode testing and use only one batch fuel measurement to determine your mean raw exhaust flow rate, you must target a constant sample flow rate over the mode. Verify proportional sampling as described in 40 CFR 1065.545 using the mean raw exhaust molar flow rate paired with each recorded sample flow rate.

(2) If you perform discrete-mode testing, you may verify proportional sampling over the whole duty cycle instead of verifying proportional sampling for each discrete mode.

\* \* \* \* \*

(d) Adjust measured emissions to account for aftertreatment technology with infrequent regeneration as described in § 1042.525.

(e) Duty-cycle testing is limited to atmospheric pressures between 91.000 and 103.325 kPa.

(f) You may use special or alternate procedures to the extent we allow them under 40 CFR 1065.10.

\* \* \* \* \*

(h) This subpart is addressed to you as a manufacturer, but it applies equally to anyone who does testing for you, and to us when we perform testing to determine if your engines meet emission standards.

■ 202. Section 1042.505 is amended by revising paragraph (b)(5)(iii) to read as follows:

**§ 1042.505 Testing engines using discrete-mode or ramped-modal duty cycles.**

\* \* \* \* \*

(b) \* \* \*

(5) \* \* \*

(iii) Use the 8-mode duty cycle or the corresponding ramped-modal cycle described in 40 CFR part 1039, Appendix II, paragraph (c) for variable-speed auxiliary engines with maximum engine power at or above 19 kW that are not propeller-law engines.

\* \* \* \* \*

■ 203. Section 1042.515 is amended by revising paragraphs (f)(2), (f)(4), and (g) to read as follows:

**§ 1042.515 Test procedures related to not-to-exceed standards.**

\* \* \* \* \*

(f) \* \* \*

(2) You may ask us to approve a Limited Testing Region (LTR). An LTR is a region of engine operation, within the applicable NTE zone, where you have demonstrated that your engine family operates for no more than 5.0

percent of its normal in-use operation, on a time-weighted basis. You must specify an LTR using boundaries based on engine speed and power (or torque), where the LTR boundaries must coincide with some portion of the boundary defining the overall NTE zone. Any emission data collected within an LTR for a time duration that exceeds 5.0 percent of the duration of its respective NTE sampling period will be excluded when determining compliance with the applicable NTE standards. Any emission data collected within an LTR for a time duration of 5.0 percent or less of the duration of the respective NTE sampling period will be included when determining compliance with the NTE standards.

\* \* \* \* \*

(4) You may exclude emission data based on catalytic aftertreatment temperatures as follows:

(i) For an engine equipped with a catalytic NO<sub>x</sub> aftertreatment system, exclude NO<sub>x</sub> emission data that is collected when the exhaust temperature at any time during the NTE event is less than 250 °C.

(ii) For an engine equipped with an oxidizing catalytic aftertreatment system, exclude HC and CO emission data that is collected when the exhaust temperature at any time during the NTE event is less than 250 °C. Similarly, exclude PM emission data during operation involving exhaust temperature below 250 °C for an engine equipped with an oxidizing flow-through catalyst.

(iii) Measure exhaust temperature within 30 cm downstream of the last applicable catalytic aftertreatment device. Where there are parallel paths, use good engineering judgment to measure the temperature within 30 cm downstream of the last applicable catalytic aftertreatment device in the path with the greatest exhaust flow.

(g) Emission sampling is not valid for NTE testing if it includes any active regeneration, unless the emission averaging period includes the complete regeneration event(s) and the full period of engine operation until the start of the next regeneration event. This provision applies only for engines that send an electronic signal indicating the start of the regeneration event.

■ 204. Section 1042.525 is revised to read as follows:

**§ 1042.525 How do I adjust emission levels to account for infrequently regenerating aftertreatment devices?**

For engines using aftertreatment technology with infrequent regeneration events that may occur during testing, take one of the following approaches to

account for the emission impact of regeneration, or use an alternate methodology that we approve for Category 3 engines:

(a) You may use the calculation methodology described in 40 CFR 1065.680 to adjust measured emission results. Do this by developing an upward adjustment factor and a downward adjustment factor for each pollutant based on measured emission data and observed regeneration frequency as follows:

(1) Adjustment factors should generally apply to an entire engine family, but you may develop separate adjustment factors for different configurations within an engine family. Use the adjustment factors from this section in all testing for the engine family.

(2) You may use carryover or carry-across data to establish adjustment factors for an engine family as described in § 1042.235, consistent with good engineering judgment.

(3) Determine the frequency of regeneration, *F*, as described in 40 CFR 1065.680 from in-use operating data or from running repetitive tests in a laboratory. If the engine is designed for regeneration at fixed time intervals, you may apply good engineering judgment to determine *F* based on those design parameters.

(4) Identify the value of *F* in each application for certification for which it applies.

(b) You may ask us to approve an alternate methodology to account for regeneration events. We will generally limit approval to cases where your engines use aftertreatment technology with extremely infrequent regeneration and you are unable to apply the provisions of this section.

(c) You may choose to make no adjustments to measured emission results if you determine that regeneration does not significantly affect emission levels for an engine family (or configuration) or if it is not practical to identify when regeneration occurs. If you choose not to make adjustments under paragraph (a) or (b) of this section, your engines must meet emission standards for all testing, without regard to regeneration.

**Subpart G—Special Compliance Provisions**

■ 205. Section 1042.601 is amended by revising paragraph (d) and adding paragraph (j) to read as follows:

**§ 1042.601 General compliance provisions for marine engines and vessels.**

\* \* \* \* \*

(d) The provisions of § 1042.635 for the national security exemption apply in addition to the provisions of 40 CFR 1068.225.

\* \* \* \* \*

(j) Subpart C of this part describes how to test and certify dual-fuel and flexible-fuel engines. Some multi-fuel engines may not fit either of those defined terms. For such engines, we will determine whether it is most appropriate to treat them as single-fuel engines, dual-fuel engines, or flexible-fuel engines based on the range of possible and expected fuel mixtures. For example, an engine might burn natural gas but initiate combustion with a pilot injection of diesel fuel. If the engine is designed to operate with a single fueling algorithm (*i.e.*, fueling rates are fixed at a given engine speed and load condition), we would generally treat it as a single-fuel engine. In this context, the combination of diesel fuel and natural gas would be its own fuel type. If the engine is designed to also operate on diesel fuel alone, we would generally treat it as a dual-fuel engine. If the engine is designed to operate on varying mixtures of the two fuels, we would generally treat it as a flexible-fuel engine. To the extent that requirements vary for the different fuels or fuel mixtures, we may apply the more stringent requirements.

■ 206. Section 1042.605 is amended by revising paragraph (e)(3) to read as follows:

**§ 1042.605 Dressing engines already certified to other standards for nonroad or heavy-duty highway engines for marine use.**

\* \* \* \* \*

(e) \* \* \*

(3) Send the Designated Compliance Officer written notification describing your plans before using the provisions of this section. In addition, by February 28 of each calendar year (or less often if we tell you), send the Designated Compliance Officer a signed letter with all the following information:

(i) Identify your full corporate name, address, and telephone number.

(ii) List the engine models for which you used this exemption in the previous year and describe your basis for meeting the sales restrictions of paragraph (d)(4) of this section.

(iii) State: “We prepared each listed engine model for marine application without making any changes that could increase its certified emission levels, as described in 40 CFR 1042.605.”

\* \* \* \* \*

■ 207. Section 1042.610 is amended by revising paragraph (e)(2) to read as follows:

**§ 1042.610 Certifying auxiliary marine engines to land-based standards.**

\* \* \* \* \*

(e) \* \* \*

(2) Send the Designated Compliance Officer written notification describing your plans before using the provisions of this section. In addition, by February 28 of each calendar year (or less often if we tell you), send the Designated Compliance Officer a signed letter with all the following information:

(i) Identify your full corporate name, address, and telephone number.

(ii) List the engine models for which you used this exemption in the previous year and describe your basis for meeting the sales restrictions of paragraph (d)(3) of this section.

(iii) State: "We prepared each listed engine model for marine application without making any changes that could increase its certified emission levels, as described in 40 CFR 1042.610."

\* \* \* \* \*

■ 208. Section 1042.630 is amended by revising paragraph (f) to read as follows:

**§ 1042.630 Personal-use exemption.**

\* \* \* \* \*

(f) The vessel must be a vessel that is not classed or subject to Coast Guard inspections or surveys. Note that dockside examinations performed by the Coast Guard are not considered inspections (see 46 U.S.C. 3301 and 46 U.S.C. 4502).

■ 209. Section 1042.635 is revised to read as follows:

**§ 1042.635 National security exemption.**

Engines qualify for a national security exemption as described in 40 CFR 1068.225. This applies to both freshly manufactured and remanufactured engines.

**§ 1042.640 [Removed]**

■ 210. Section 1042.640 is removed.

■ 211. Section 1042.650 is amended by revising paragraphs (a) and (d) to read as follows:

**§ 1042.650 Exemptions for migratory vessels and auxiliary engines on Category 3 vessels.**

\* \* \* \* \*

(a) *Temporary exemption.* A vessel owner may ask us for a temporary exemption from the tampering prohibition in 40 CFR 1068.101(b)(1) for a vessel if it will operate for an extended period outside the United States where ULSD is not available. In your request, describe where the vessel will operate, how long it will operate there, why ULSD will be unavailable, and how you will modify the engine, including its emission controls. If we approve your

request, you may modify the engine, but only as needed to disable or remove the emission controls needed for meeting the Tier 4 standards. You must return the engine to its original certified configuration before the vessel returns to the United States to avoid violating the tampering prohibition in 40 CFR 1068.101(b)(1). We may set additional conditions to prevent circumvention of the provisions of this part.

\* \* \* \* \*

(d) *Auxiliary engines on Category 3 vessels.* Auxiliary engines that will be installed on vessels with Category 3 propulsion engines qualify for an exemption from the standards of this part provided all the following conditions are met:

(1) To be eligible for this exemption, the engine must meet all the following criteria.

(i) The engine must have an EIAPP certificate demonstrating compliance with the applicable NO<sub>x</sub> standards of Annex VI and meet all other applicable requirements of 40 CFR part 1043. Engines installed on vessels constructed on or after January 1, 2016 must conform fully to the Annex VI Tier III NO<sub>x</sub> standards as described in 40 CFR part 1043 and meet all other applicable requirements in 40 CFR part 1043. Engines that would otherwise be subject to the Tier 4 standards of this part must also conform fully to the Annex VI Tier III NO<sub>x</sub> standards as described in 40 CFR part 1043.

(ii) The engine may not be used for propulsion (except for emergency engines).

(iii) Engines certified to the Annex VI Tier III standards may be equipped with on-off NO<sub>x</sub> controls, as long as they conform to the requirements of §§ 1042.110(d) and 1042.115(g); however, the engines must comply fully with the Annex VI Tier II standards when the emission controls are disabled, and meet any other requirements that apply under Annex VI.

(2) You must notify the Designated Compliance Officer of your intent to use this exemption before you introduce engines into U.S. commerce, not later than the time that you apply for an EIAPP certificate for the engine under 40 CFR part 1043.

(3) The remanufactured engine requirements of subpart I of this part do not apply.

(4) If you introduce an engine into U.S. commerce under this paragraph (d), you must meet the labeling requirements in § 1042.135, but add the following statement instead of the compliance statement in § 1042.135(c)(10):

THIS ENGINE DOES NOT COMPLY WITH CURRENT U.S. EPA EMISSION STANDARDS UNDER 40 CFR 1042.650 AND IS FOR USE SOLELY IN VESSELS WITH CATEGORY 3 PROPULSION ENGINES. INSTALLATION OR USE OF THIS ENGINE IN ANY OTHER APPLICATION MAY BE A VIOLATION OF FEDERAL LAW SUBJECT TO CIVIL PENALTY.

(5) The reporting requirements of § 1042.660 apply for engines exempted under this paragraph (d).

■ 212. Section 1042.655 is amended by revising the section heading and paragraph (b) to read as follows:

**§ 1042.655 Special certification provisions for Category 3 engines with aftertreatment.**

\* \* \* \* \*

(b) *Required testing.* The emission-data engine must be tested as specified in subpart F of this part to verify that the engine-out emissions comply with the Tier 2 standards. The catalyst material or other aftertreatment device must be tested under conditions that accurately represent actual engine conditions for the test points. This catalyst or aftertreatment testing may be performed on a bench scale.

\* \* \* \* \*

■ 213. Section 1042.660 is amended by revising paragraphs (b) and (c)(1) to read as follows:

**§ 1042.660 Requirements for vessel manufacturers, owners, and operators.**

\* \* \* \* \*

(b) For vessels equipped with SCR systems requiring the use of urea or other reductants, owners and operators must report to the Designated Enforcement Officer within 30 days any operation of such vessels without the appropriate reductant. This includes vessels with auxiliary engines certified to Annex VI standards under § 1042.650(d). Failure to comply with the requirements of this paragraph is a violation of 40 CFR 1068.101(a)(2). Note that such operation is a violation of 40 CFR 1068.101(b)(1).

(c) \* \* \*

(1) The requirements of this paragraph (c)(1) apply only for Category 3 engines. All maintenance, repair, adjustment, and alteration of Category 3 engines subject to the provisions of this part performed by any owner, operator or other maintenance provider must be performed using good engineering judgment, in such a manner that the engine continues (after the maintenance, repair, adjustment or alteration) to meet the emission standards it was certified as meeting prior to the need for service. This includes but is not limited to complying with the maintenance

instructions described in § 1042.125. Adjustments are limited to the range specified by the engine manufacturer in the approved application for certification. Note that where a repair (or other maintenance) cannot be completed while at sea, it is not a violation to continue operating the engine to reach your destination.

■ 214. Section 1042.670 is amended by revising paragraph (d) to read as follows:

§ 1042.670 Special provisions for gas turbine engines.

(d) Equivalent displacement. Apply displacement-based provisions of this part by calculating an equivalent displacement from maximum engine power. The equivalent per-cylinder displacement (in liters) equals maximum engine power in kW multiplied by 0.00311, except that all gas turbines with maximum engine power above 9,300 kW are considered to have an equivalent per-cylinder displacement of 29.0 liters. Also, determine the appropriate Tier 3 standards for Category 1 engines based on the engine having an equivalent power density below 35 kW per liter.

Subpart H—Averaging, Banking, and Trading for Certification

■ 215. Section 1042.701 is amended by adding paragraphs (j) and (k) to read as follows:

§ 1042.701 General provisions.

(j) NOx+HC and PM credits generated under 40 CFR part 94 may be used under this part in the same manner as NOx+HC and PM credits generated under this part.

(k) You may use either of the following approaches to retire or forego emission credits:

(1) You may retire emission credits generated from any number of your engines. This may be considered donating emission credits to the environment. Identify any such credits in the reports described in § 1042.730. Engines must comply with the applicable FELs even if you donate or sell the corresponding emission credits under this paragraph (k). Those credits may no longer be used by anyone to demonstrate compliance with any EPA emission standards.

(2) You may certify a family using an FEL below the emission standard as described in this part and choose not to generate emission credits for that

family. If you do this, you do not need to calculate emission credits for those families and you do not need to submit or keep the associated records described in this subpart for that family.

■ 216. Section 1042.705 is amended by revising paragraph (c) to read as follows:

§ 1042.705 Generating and calculating emission credits.

(c) As described in § 1042.730, compliance with the requirements of this subpart is determined at the end of the model year based on actual U.S.-directed production volumes. Do not include any of the following engines to calculate emission credits:

- (1) Engines with a permanent exemption under subpart G of this part or under 40 CFR part 1068.
(2) Exported engines.
(3) Engines not subject to the requirements of this part, such as those excluded under § 1042.5.
(4) [Reserved]
(5) Any other engines, where we indicate elsewhere in this part 1042 that they are not to be included in the calculations of this subpart.

■ 217. Section 1042.710 is amended by revising paragraph (c) to read as follows:

§ 1042.710 Averaging emission credits.

(c) If you certify an engine family to an FEL that exceeds the otherwise applicable emission standard, you must obtain enough emission credits to offset the engine family's deficit by the due date for the final report required in § 1042.730. The emission credits used to address the deficit may come from your other engine families that generate emission credits in the same model year, from emission credits you have banked from previous model years, or from emission credits generated in the same or previous model years that you obtained through trading.

■ 218. Section 1042.725 is amended by revising paragraph (b)(2) to read as follows:

§ 1042.725 Information required for the application for certification.

(2) Detailed calculations of projected emission credits (positive or negative) based on projected production volumes. We may require you to include similar calculations from your other engine families to demonstrate that you will be able to avoid negative credit balances for the model year. If you project negative emission credits for a family, state the source of positive emission

credits you expect to use to offset the negative emission credits.

■ 219. Section 1042.730 is amended by revising paragraphs (b), (c)(2), and (d) to read as follows:

§ 1042.730 ABT reports.

(b) Your end-of-year and final reports must include the following information for each engine family participating in the ABT program:

- (1) Engine-family designation and averaging set.
(2) The emission standards that would otherwise apply to the engine family.
(3) The FEL for each pollutant. If you change the FEL after the start of production, identify the date that you started using the new FEL and/or give the engine identification number for the first engine covered by the new FEL. In this case, identify each applicable FEL and calculate the positive or negative emission credits as specified in § 1042.225.
(4) The projected and actual U.S.-directed production volumes for the model year, as described in § 1042.705(c). If you changed an FEL during the model year, identify the actual U.S.-directed production volume associated with each FEL.
(5) Maximum engine power for each engine configuration, and the average engine power weighted by U.S.-directed production volumes for the engine family.
(6) Useful life.
(7) Calculated positive or negative emission credits for the whole engine family. Identify any emission credits that you traded, as described in paragraph (d)(1) of this section.

(c) State whether you will retain any emission credits for banking. If you choose to retire emission credits that would otherwise be eligible for banking, identify the engine families that generated the emission credits, including the number of emission credits from each family.

(d) If you trade emission credits, you must send us a report within 90 days after the transaction, as follows:

- (1) As the seller, you must include the following information in your report:
(i) The corporate names of the buyer and any brokers.
(ii) A copy of any contracts related to the trade.
(iii) The averaging set corresponding to the engine families that generated emission credits for the trade, including the number of emission credits from each averaging set.



(2) As the buyer, you must include the following information in your report:

(i) The corporate names of the seller and any brokers.

(ii) A copy of any contracts related to the trade.

(iii) How you intend to use the emission credits, including the number of emission credits you intend to apply for each averaging set.

\* \* \* \* \*

■ 220. Section 1042.735 is amended by revising paragraphs (a) and (b) to read as follows:

**§ 1042.735 Recordkeeping.**

(a) You must organize and maintain your records as described in this section.

(b) Keep the records required by this section for at least eight years after the due date for the end-of-year report. You may not use emission credits for any engines if you do not keep all the records required under this section. You must therefore keep these records to continue to bank valid credits.

\* \* \* \* \*

**Subpart I—Special Provisions for Remanufactured Marine Engines**

■ 221. Section 1042.810 is amended by revising paragraph (c) to read as follows:

**§ 1042.810 Requirements for owner/operators and installers during remanufacture.**

\* \* \* \* \*

(c) Your engine is not subject to the standards of this subpart if we determine that no certified remanufacturing system is available for your engine as described in § 1042.815. For engines that are remanufactured during multiple events within a five-year period, you are not required to use a certified system until all of your engine's cylinders have been replaced after the system became available. For example, if you remanufacture your 16-cylinder engine by replacing four cylinders each January and a system becomes available for your engine June 1, 2010, your engine must be in a certified configuration when you replace four cylinders in January of 2014. At that point, all 16 cylinders would have been replaced after June 1, 2010.

\* \* \* \* \*

■ 222. Section 1042.830 is revised to read as follows:

**§ 1042.830 Labeling.**

(a) The labeling requirements of this paragraph (a) apply for remanufacturing that is subject to the standards of this subpart. At the time of remanufacture,

affix a permanent and legible label identifying each engine. The label must be—

(1) Attached in one piece so it is not removable without being destroyed or defaced.

(2) Secured to a part of the engine needed for normal operation and not normally requiring replacement.

(3) Durable and readable for the engine's entire useful life.

(4) Written in English.

(b) The label required under paragraph (a) of this section must—

(1) Include the heading "EMISSION CONTROL INFORMATION".

(2) Include your full corporate name and trademark.

(3) Include EPA's standardized designation for the engine family.

(4) State the engine's category, displacement (in liters or L/cyl), maximum engine power (in kW), and power density (in kW/L) as needed to determine the emission standards for the engine family. You may specify displacement, maximum engine power, and power density as ranges consistent with the ranges listed in § 1042.101. See § 1042.140 for descriptions of how to specify per-cylinder displacement, maximum engine power, and power density.

(5) State: "THIS MARINE ENGINE MEETS THE STANDARDS OF 40 CFR PART 1042, SUBPART I, FOR [CALENDAR YEAR OF REMANUFACTURE]."

(c) For remanufactured engines that are subject to this subpart as described in § 1042.801(a), but are not subject to remanufacturing standards as allowed by § 1042.810 or § 1042.815, you may voluntarily add a label as specified in paragraphs (a) and (b) of this section, except that the label must omit the standardized designation for the engine family and include the following alternative compliance statement: "THIS MARINE ENGINE IS NOT SUBJECT TO REMANUFACTURING STANDARDS UNDER 40 CFR PART 1042, SUBPART I, FOR [CALENDAR YEAR OF REMANUFACTURE]."

(d) You may add information to the emission control information label to identify other emission standards that the engine meets or does not meet (such as international standards). You may also add other information to ensure that the engine will be properly maintained and used.

(e) You may ask us to approve modified labeling requirements in this section if you show that it is necessary or appropriate. We will approve your request if your alternate label is consistent with the intent of the labeling requirements of this section.

■ 223. Section 1042.836 is amended by revising paragraph (c)(1) to read as follows:

**§ 1042.836 Marine certification of locomotive remanufacturing systems.**

\* \* \* \* \*

(c) \* \* \*

(1) Tier 0 locomotive systems may not be used for any Category 1 engines or Tier 1 or later Category 2 engines.

\* \* \* \* \*

■ 224. Section 1042.840 is amended by revising paragraphs (c) and (o) to read as follows:

**§ 1042.840 Application requirements for remanufactured engines.**

\* \* \* \* \*

(c) Summarize the cost effectiveness analysis used to demonstrate your system will meet the availability criteria of § 1042.815. Identify the maximum allowable costs for vessel modifications to meet these criteria.

\* \* \* \* \*

(o) Report all valid test results. Also indicate whether there are test results from invalid tests or from any other tests of the emission-data engine, whether or not they were conducted according to the test procedures of subpart F of this part. If you measure CO<sub>2</sub>, report those emission levels. We may require you to report these additional test results. We may ask you to send other information to confirm that your tests were valid under the requirements of this part and 40 CFR part 1065.

\* \* \* \* \*

■ 225. Section 1042.850 is amended by revising the introductory text to read as follows:

**§ 1042.850 Exemptions and hardship relief.**

This section describes exemption and hardship provisions that are available for owner/operators of engines subject to the provisions of this subpart.

\* \* \* \* \*

**Subpart J—Definitions and Other Reference Information**

■ 226. Section 1042.901 is amended as follows:

■ a. By revising the definition of "Designated Compliance Officer".

■ b. By adding definitions for "Designated Enforcement Officer", "Dual-fuel", and "Flexible-fuel" in alphabetical order.

■ c. By revising the definitions for "Low-sulfur diesel fuel", "Model year", and "Placed into service".

■ d. By removing the definition for "Point of first retail sale".



■ e. By revising the definition of “Sulfur-sensitive technology”.

The revisions and additions read as follows:

**§ 1042.901 Definitions.**

\* \* \* \* \*

*Designated Compliance Officer* means the Director, Diesel Engine Compliance Center, U.S. Environmental Protection Agency, 2000 Traverwood Drive, Ann Arbor, MI 48105; *complianceinfo@epa.gov*; *epa.gov/otaq/verify*.

*Designated Enforcement Officer* means the Director, Air Enforcement Division (2242A), U.S. Environmental Protection Agency, 1200 Pennsylvania Ave. NW., Washington, DC 20460.

\* \* \* \* \*

*Dual-fuel* means relating to an engine designed for operation on two different fuels but not on a continuous mixture of those fuels (see § 1042.601(j)). For purposes of this part, such an engine remains a dual-fuel engine even if it is designed for operation on three or more different fuels. Note that this definition differs from MARPOL Annex VI.

\* \* \* \* \*

*Flexible-fuel* means relating to an engine designed for operation on any mixture of two or more different fuels (see § 1042.601(j)).

\* \* \* \* \*

*Low-sulfur diesel fuel* means one of the following:

(1) For in-use fuels, *low-sulfur diesel fuel* means a diesel fuel marketed as low-sulfur diesel fuel having a maximum sulfur concentration of 500 parts per million.

(2) For testing, *low-sulfur diesel fuel* has the meaning given in 40 CFR part 1065.

\* \* \* \* \*

*Model year* means any of the following:

(1) For freshly manufactured marine engines (see definition of “new marine engine,” paragraph (1)), model year means one of the following:

(i) Calendar year of production.

(ii) Your annual new model production period if it is different than the calendar year. This must include January 1 of the calendar year for which the model year is named. It may not begin before January 2 of the previous calendar year and it must end by December 31 of the named calendar year. For seasonal production periods not including January 1, model year means the calendar year in which the production occurs, unless you choose to certify the applicable engine family with the following model year. For example, if your production period is June 1, 2010 through November 30, 2010, your

model year would be 2010 unless you choose to certify the engine family for model year 2011.

(2) For an engine that is converted to a marine engine after being certified and placed into service as a motor vehicle engine, a nonroad engine that is not a marine engine, or a stationary engine, model year means the calendar year in which the engine was originally produced. For an engine that is converted to a marine engine after being placed into service as a motor vehicle engine, a nonroad engine that is not a marine engine, or a stationary engine without having been certified, model year means the calendar year in which the engine becomes a new marine engine. (See definition of “new marine engine,” paragraph (2)).

(3) For an uncertified marine engine excluded under § 1042.5 that is later subject to this part 1042 as a result of being installed in a different vessel, model year means the calendar year in which the engine was installed in the non-excluded vessel. For a marine engine excluded under § 1042.5 that is later subject to this part 1042 as a result of reflagging the vessel, model year means the calendar year in which the engine was originally manufactured. For a marine engine that become new under paragraph (7) of the definition of “new marine engine,” model year means the calendar year in which the engine was originally manufactured. (See definition of “new marine engine,” paragraphs (3) and (7).)

(4) For engines that do not meet the definition of “freshly manufactured” but are installed in new vessels, model year means the calendar year in which the engine is installed in the new vessel (see definition of “new marine engine,” paragraph (4)).

(5) For remanufactured engines, model year means the calendar year in which the remanufacture takes place.

(6) For imported engines:

(i) For imported engines described in paragraph (6)(i) of the definition of “new marine engine,” *model year* has the meaning given in paragraphs (1) through (4) of this definition.

(ii) For imported engines described in paragraph (6)(ii) of the definition of “new marine engine,” *model year* means the calendar year in which the engine is remanufactured.

(iii) For imported engines described in paragraph (6)(iii) of the definition of “new marine engine,” *model year* means the calendar year in which the engine is first assembled in its imported configuration, unless specified otherwise in this part or in 40 CFR part 1068.

(iv) For imported engines described in paragraph (6)(iv) of the definition of “new marine engine,” *model year* means the calendar year in which the engine is imported.

(7) [Reserved]

(8) For freshly manufactured vessels, model year means the calendar year in which the keel is laid or the vessel is at a similar stage of construction. For vessels that become new under paragraph (2) or (3) of the definition of “new vessel” (as a result of modifications), model year means the calendar year in which the modifications physically begin.

\* \* \* \* \*

*Placed into service* means put into initial use for its intended purpose. Engines and vessels do not qualify as being “placed into service” based on incidental use by a manufacturer or dealer.

\* \* \* \* \*

*Sulfur-sensitive technology* means an emission control technology that experiences a significant drop in emission control performance or emission-system durability when an engine is operated on low-sulfur diesel fuel (*i.e.*, fuel with a sulfur concentration of 300 to 500 ppm) as compared to when it is operated on ultra-low sulfur diesel fuel (*i.e.*, fuel with a sulfur concentration less than 15 ppm). Exhaust gas recirculation is not a sulfur-sensitive technology.

\* \* \* \* \*

■ 227. Section 1042.905 is revised to read as follows:

**§ 1042.905 Symbols, acronyms, and abbreviations.**

The following symbols, acronyms, and abbreviations apply to this part:

ABT Averaging, banking, and trading.  
 AECD auxiliary emission control device.  
 CFR Code of Federal Regulations.  
 CH<sub>4</sub> methane.  
 CO carbon monoxide.  
 CO<sub>2</sub> carbon dioxide.  
 cyl cylinder.  
 disp. displacement.  
 ECA Emission Control Area.  
 EEZ Exclusive Economic Zone.  
 EPA Environmental Protection Agency.  
 FEL Family Emission Limit.  
 g grams.  
 HC hydrocarbon.  
 hr hours.  
 IMO International Maritime Organization.  
 kPa kilopascals.  
 kW kilowatts.  
 L liters.  
 LTR Limited Testing Region.

N<sub>2</sub>O nitrous oxide.  
 NARA National Archives and Records Administration.  
 NMHC nonmethane hydrocarbon.  
 NO<sub>x</sub> oxides of nitrogen (NO and NO<sub>2</sub>).  
 NTE not-to-exceed.  
 PM particulate matter.  
 RPM revolutions per minute.  
 SAE Society of Automotive Engineers.  
 SCR selective catalytic reduction.  
 THC total hydrocarbon.  
 THCE total hydrocarbon equivalent.  
 ULSD ultra low-sulfur diesel fuel.  
 U.S.C. United States Code.

■ 228. Section 1042.910 is revised to read as follows:

**§ 1042.910 Incorporation by reference.**

(a) Certain material is incorporated by reference into this part with the approval of the Director of the Federal Register under 5 U.S.C. 552(a) and 1 CFR part 51. To enforce any edition other than that specified in this section, the Environmental Protection Agency must publish a document in the **Federal Register** and the material must be available to the public. All approved material is available for inspection at U.S. EPA, Air and Radiation Docket and Information Center, 1301 Constitution Ave. NW., Room B102, EPA West Building, Washington, DC 20460, (202) 202-1744, and is available from the sources listed below. It is also available for inspection at the National Archives and Records Administration (NARA). For information on the availability of this material at NARA, call 202-741-6030, or go to: <http://www.archives.gov/federal-register/code-of-federal-regulations/ibr-locations.html>.

(b) The International Maritime Organization, 4 Albert Embankment, London SE1 7SR, United Kingdom, or [www.imo.org](http://www.imo.org), or 44-(0)20-7735-7611.

(1) MARPOL Annex VI, Regulations for the Prevention of Air Pollution from Ships, Third Edition, 2013, and NO<sub>x</sub> Technical Code 2008.

(i) Revised MARPOL Annex VI, Regulations for the Prevention of Pollution from Ships, Third Edition, 2013 (“2008 Annex VI”); IBR approved for § 1042.901.

(ii) NO<sub>x</sub> Technical Code 2008, Technical Code on Control of Emission of Nitrogen Oxides from Marine Diesel Engines, 2013 Edition, (“NO<sub>x</sub> Technical Code”); IBR approved for §§ 1042.104(g), 1042.230(d), 1042.302(c) and (e), 1042.501(g), and 1042.901.

(iii) Annex 12, Resolution MEPC.251(66) from the Report of the Marine Environment Protection Committee on its Sixty-Sixth Session, April 25, 2014. This document describes new and revised provisions that are

considered to be part of Annex VI and NO<sub>x</sub> Technical Code 2008 as referenced in paragraphs (b)(1)(i) and (ii) of this section. IBR approved for §§ 1042.104(g), 1042.230(d), 1042.302(c) and (e), 1042.501(g), and 1042.901.  
 (2) [Reserved]

■ 229. Section 1042.915 is revised to read as follows:

**§ 1042.915 Confidential information.**

The provisions of 40 CFR 1068.10 apply for information you consider confidential.

■ 230. Section 1042.925 is revised to read as follows:

**§ 1042.925 Reporting and recordkeeping requirements.**

(a) This part includes various requirements to submit and record data or other information. Unless we specify otherwise, store required records in any format and on any media and keep them readily available for eight years after you send an associated application for certification, or eight years after you generate the data if they do not support an application for certification. You are expected to keep your own copy of required records rather than relying on someone else to keep records on your behalf. We may review these records at any time. You must promptly send us organized, written records in English if we ask for them. We may require you to submit written records in an electronic format.

(b) The regulations in § 1042.255, 40 CFR 1068.25, and 40 CFR 1068.101 describe your obligation to report truthful and complete information. This includes information not related to certification. Failing to properly report information and keep the records we specify violates 40 CFR 1068.101(a)(2), which may involve civil or criminal penalties.

(c) Send all reports and requests for approval to the Designated Compliance Officer (see § 1042.801).

(d) Any written information we require you to send to or receive from another company is deemed to be a required record under this section. Such records are also deemed to be submissions to EPA. We may require you to send us these records whether or not you are a certificate holder.

(e) Under the Paperwork Reduction Act (44 U.S.C. 3501 et seq), the Office of Management and Budget approves the reporting and recordkeeping specified in the applicable regulations. The following items illustrate the kind of reporting and recordkeeping we require for engines and vessels regulated under this part:

(1) We specify the following requirements related to engine certification in this part 1042:

(i) In § 1042.135 we require engine manufacturers to keep certain records related to duplicate labels sent to vessel manufacturers.

(ii) In § 1042.145 we include various reporting and recordkeeping requirements related to interim provisions.

(iii) In subpart C of this part we identify a wide range of information required to certify engines.

(iv) In §§ 1042.345 and 1042.350 we specify certain records related to production-line testing.

(v) In subpart G of this part we identify several reporting and recordkeeping items for making demonstrations and getting approval related to various special compliance provisions.

(vi) In §§ 1042.725, 1042.730, and 1042.735 we specify certain records related to averaging, banking, and trading.

(vii) In subpart I of this part we specify certain records related to meeting requirements for remanufactured engines.

(2) We specify the following requirements related to testing in 40 CFR part 1065:

(i) In 40 CFR 1065.2 we give an overview of principles for reporting information.

(ii) In 40 CFR 1065.10 and 1065.12 we specify information needs for establishing various changes to published test procedures.

(iii) In 40 CFR 1065.25 we establish basic guidelines for storing test information.

(iv) In 40 CFR 1065.695 we identify the specific information and data items to record when measuring emissions.

(3) We specify the following requirements related to the general compliance provisions in 40 CFR part 1068:

(i) In 40 CFR 1068.5 we establish a process for evaluating good engineering judgment related to testing and certification.

(ii) In 40 CFR 1068.25 we describe general provisions related to sending and keeping information.

(iii) In 40 CFR 1068.27 we require manufacturers to make engines available for our testing or inspection if we make such a request.

(iv) In 40 CFR 1068.105 we require vessel manufacturers to keep certain records related to duplicate labels from engine manufacturers.

(v) In 40 CFR 1068.120 we specify recordkeeping related to rebuilding engines.

(vi) In 40 CFR part 1068, subpart C, we identify several reporting and recordkeeping items for making demonstrations and getting approval related to various exemptions.

(vii) In 40 CFR part 1068, subpart D, we identify several reporting and recordkeeping items for making demonstrations and getting approval related to importing engines.

(viii) In 40 CFR 1068.450 and 1068.455 we specify certain records

related to testing production-line engines in a selective enforcement audit.

(ix) In 40 CFR 1068.501 we specify certain records related to investigating and reporting emission-related defects.

(x) In 40 CFR 1068.525 and 1068.530 we specify certain records related to recalling nonconforming engines.

(xi) In 40 CFR part 1068, subpart G, we specify certain records for requesting a hearing.

■ 231. Appendix II to Part 1042 is revised to read as follows:

**Appendix II to Part 1042—Steady-State Duty Cycles**

(a) The following duty cycles apply as specified in § 1042.505(b)(1):

(1) The following duty cycle applies for discrete-mode testing:

E3 mode No.	Engine speed <sup>1</sup>	Percent of maximum test power	Weighting factors
1 .....	Maximum test speed .....	100	0.2
2 .....	91% .....	75	0.5
3 .....	80% .....	50	0.15
4 .....	63% .....	25	0.15

<sup>1</sup> Maximum test speed is defined in 40 CFR part 1065. Percent speed values are relative to maximum test speed.

(2) The following duty cycle applies for ramped-modal testing:

RMC mode	Time in mode (seconds)	Engine speed <sup>1 3</sup>	Power (percent) <sup>2 3</sup>
1a Steady-state .....	229	Maximum test speed .....	100%.
1b Transition .....	20	Linear transition .....	Linear transition in torque.
2a Steady-state .....	166	63% .....	25%.
2b Transition .....	20	Linear transition .....	Linear transition in torque.
3a Steady-state .....	570	91% .....	75%.
3b Transition .....	20	Linear transition .....	Linear transition in torque.
4a Steady-state .....	175	80% .....	50%.

<sup>1</sup> Maximum test speed is defined in 40 CFR part 1065. Percent speed is relative to maximum test speed.

<sup>2</sup> The percent power is relative to the maximum test power.

<sup>3</sup> Advance from one mode to the next within a 20 second transition phase. During the transition phase, command a linear progression from the torque setting of the current mode to the torque setting of the next mode, and simultaneously command a similar linear progression for engine speed if there is a change in speed setting.

(b) The following duty cycles apply as specified in § 1042.505(b)(2):

(1) The following duty cycle applies for discrete-mode testing:

E5 mode No.	Engine speed <sup>1</sup>	Percent of maximum test power	Weighting factors
1 .....	Maximum test speed .....	100	0.08
2 .....	91% .....	75	0.13
3 .....	80% .....	50	0.17
4 .....	63% .....	25	0.32
5 .....	Warm idle .....	0	0.3

<sup>1</sup> Maximum test speed is defined in 40 CFR part 1065. Percent speed values are relative to maximum test speed.

(2) The following duty cycle applies for ramped-modal testing:

RMC mode	Time in mode (seconds)	Engine speed <sup>1 3</sup>	Power (percent) <sup>2 3</sup>
1a Steady-state .....	167	Warm idle .....	0.
1b Transition .....	20	Linear transition .....	Linear transition in torque.
2a Steady-state .....	85	Maximum test speed .....	100%.
2b Transition .....	20	Linear transition .....	Linear transition in torque.
3a Steady-state .....	354	63% .....	25%.
3b Transition .....	20	Linear transition .....	Linear transition in torque.
4a Steady-state .....	141	91% .....	75%.
4b Transition .....	20	Linear transition .....	Linear transition in torque.
5a Steady-state .....	182	80% .....	50%.

RMC mode	Time in mode (seconds)	Engine speed <sup>1 3</sup>	Power (percent) <sup>2 3</sup>
5b Transition .....	20	Linear transition .....	Linear transition in torque.
6 Steady-state .....	171	Warm idle .....	0.

<sup>1</sup> Maximum test speed is defined in 40 CFR part 1065. Percent speed is relative to maximum test speed.

<sup>2</sup> The percent power is relative to the maximum test power.

<sup>3</sup> Advance from one mode to the next within a 20 second transition phase. During the transition phase, command a linear progression from the torque setting of the current mode to the torque setting of the next mode, and simultaneously command a similar linear progression for engine speed if there is a change in speed setting.

(c) The following duty cycles apply as specified in § 1042.505(b)(3):

(1) The following duty cycle applies for discrete-mode testing:

E2 mode No.	Engine speed <sup>1</sup>	Torque (percent) <sup>2</sup>	Weighting factors
1 .....	Engine Governed .....	100	0.2
2 .....	Engine Governed .....	75	0.5
3 .....	Engine Governed .....	50	0.15
4 .....	Engine Governed .....	25	0.15

<sup>1</sup> Speed terms are defined in 40 CFR part 1065.

<sup>2</sup> The percent torque is relative to the maximum test torque as defined in 40 CFR part 1065.

(2) The following duty cycle applies for ramped-modal testing:

RMC mode	Time in mode (seconds)	Engine speed	Torque (percent) <sup>1 2</sup>
1a Steady-state .....	229	Engine Governed .....	100%.
1b Transition .....	20	Engine Governed .....	Linear transition.
2a Steady-state .....	166	Engine Governed .....	25%.
2b Transition .....	20	Engine Governed .....	Linear transition.
3a Steady-state .....	570	Engine Governed .....	75%.
3b Transition .....	20	Engine Governed .....	Linear transition.
4a Steady-state .....	175	Engine Governed .....	50%.

<sup>1</sup> The percent torque is relative to the maximum test torque as defined in 40 CFR part 1065.

<sup>2</sup> Advance from one mode to the next within a 20 second transition phase. During the transition phase, command a linear progression from the torque setting of the current mode to the torque setting of the next mode.

■ 232. Appendix III to Part 1042 is revised to read as follows:

**Appendix III to Part 1042—Not-to-Exceed Zones**

(a) The following definitions apply for this Appendix III:

(1) *Percent power* means the percentage of the maximum power achieved at Maximum Test Speed (or at Maximum Test Torque for constant-speed engines).

(2) *Percent speed* means the percentage of Maximum Test Speed.

(b) Figure 1 of this Appendix illustrates the default NTE zone for marine engines certified

using the duty cycle specified in § 1042.505(b)(1), except for variable-speed propulsion marine engines used with controllable-pitch propellers or with electrically coupled propellers, as follows:

(1) Subzone 1 is defined by the following boundaries:

(i)  $\text{Percent power} + 100 > 0.7 \cdot (\text{percent speed} + 100)^{2.5}$ .

(ii)  $\text{Percent power} + 100 \leq (\text{percent speed} + 90)^{3.5}$ .

(iii)  $\text{Percent power} + 100 \geq 3.0 \cdot (1 - \text{percent speed} + 100)$ .

(2) Subzone 2 is defined by the following boundaries:

(i)  $\text{Percent power} + 100 \geq 0.7 \cdot (\text{percent speed} + 100)^{2.5}$ .

(ii)  $\text{Percent power} + 100 \leq (\text{percent speed} + 90)^{3.5}$ .

(iii)  $\text{Percent power} + 100 < 3.0 \cdot (1 - \text{percent speed} + 100)$ .

(iv)  $\text{Percent speed} + 100 \geq 0.7$ .

(3) Note that the line separating Subzone 1 and Subzone 2 includes the following endpoints:

(i) Percent speed = 78.9 percent; Percent power = 63.2 percent.

(ii) Percent speed = 84.6 percent; Percent power = 46.1 percent.

Figure 1 of Appendix III — NTE Zone and Subzones for Propeller-Law Marine Engines

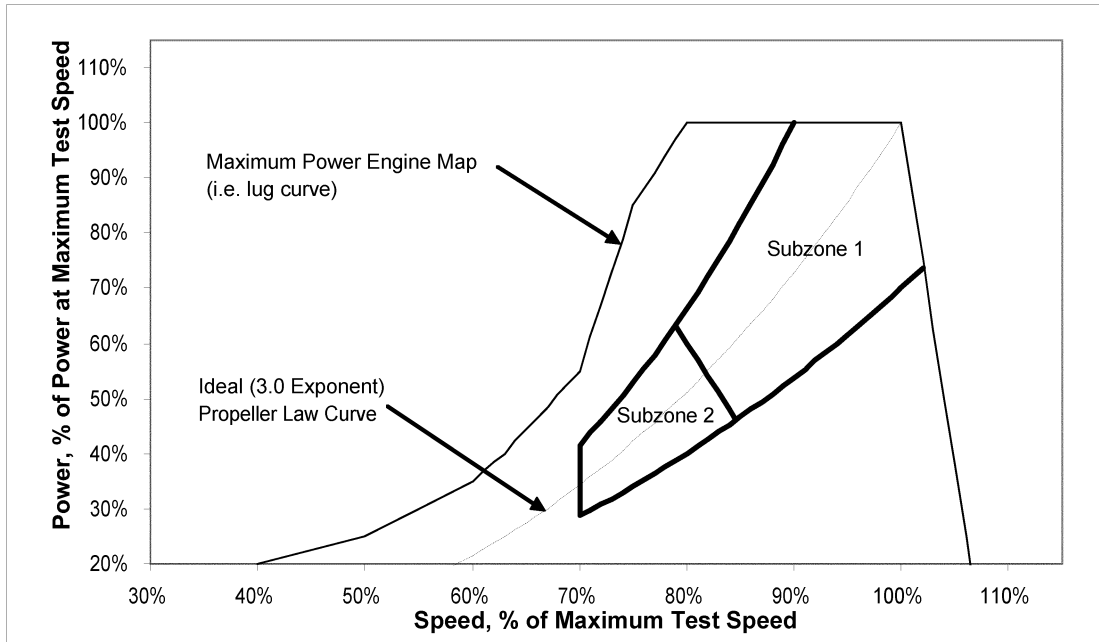

(c) Figure 2 of this Appendix illustrates the default NTE zone for recreational marine engines certified using the duty cycle specified in § 1042.505(b)(2), except for variable-speed marine engines used with controllable-pitch propellers or with electrically coupled propellers, as follows:

- (1) Subzone 1 is defined by the following boundaries:
- (i) Percent power + 100  $\geq 0.7 \cdot (\text{percent speed} + 100)^{2.5}$ .
  - (ii) Percent power + 100  $\leq (\text{percent speed} + 90)^{3.5}$ .

- (iii) Percent power + 100  $\geq 3.0 \cdot (1 - \text{percent speed} + 100)$ .
- (iv) Percent power  $\leq 95$  percent.

(2) Subzone 2 is defined by the following boundaries:

- (i) Percent power + 100  $\geq 0.7 \cdot (\text{percent speed} + 100)^{2.5}$ .
- (ii) Percent power + 100  $\leq (\text{percent speed} + 90)^{3.5}$ .
- (iii) Percent power + 100  $< 3.0 \cdot (1 - \text{percent speed} + 100)$ .
- (iv) Percent speed  $\geq 70$  percent.

(3) Subzone 3 is defined by the following boundaries:

- (i) Percent power + 100  $\leq (\text{percent speed} + 90)^{3.5}$ .
  - (ii) Percent power  $> 95$  percent.
- (4) Note that the line separating Subzone 1 and Subzone 3 includes a point at Percent speed = 88.7 percent and Percent power = 95.0 percent. See paragraph (b)(3) of this appendix regarding the line separating Subzone 1 and Subzone 2.

Figure 2 of Appendix III — NTE Zone and Subzones for Propeller-Law Recreational Marine Engines

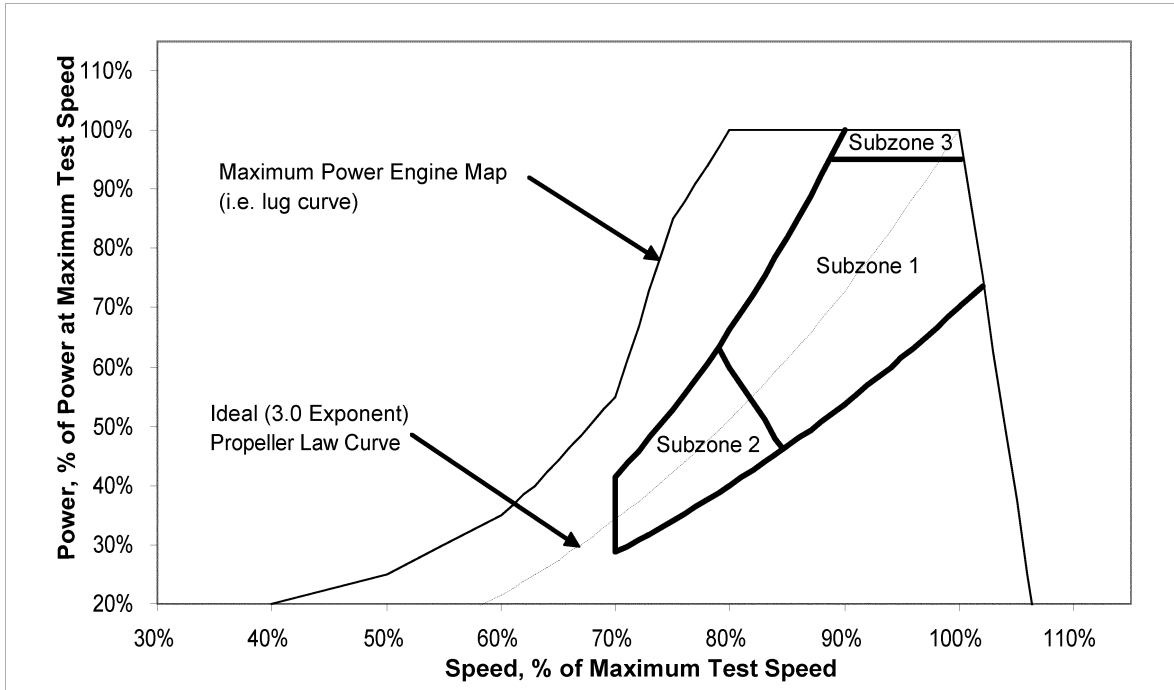

(d) Figure 3 of this Appendix illustrates the default NTE zone for variable-speed marine engines used with controllably-pitch propellers or with electrically coupled propellers that are certified using the duty cycle specified in § 1042.505(b)(1), (2), or (3), as follows:

- (1) Subzone 1 is defined by the following boundaries:
  - (i)  $\text{Percent power} + 100 \geq 0.7 \cdot (\text{percent speed} + 100)^{2.5}$ .
  - (ii)  $\text{Percent power} + 100 \geq 3.0 \cdot (1 - \text{percent speed} + 100)$ .
  - (iii)  $\text{Percent speed} \geq 78.9$  percent.

(2) Subzone 2a is defined by the following boundaries:

- (i)  $\text{Percent power} + 100 \geq 0.7 \cdot (\text{percent speed} + 100)^{2.5}$ .
- (ii)  $\text{Percent speed} \geq 70$  percent.
- (iii)  $\text{Percent speed} < 78.9$  percent, for  $\text{Percent power} > 63.3$  percent.
- (iv)  $\text{Percent power} + 100 < 3.0 \cdot (1 - \text{percent speed} + 100)$ , for  $\text{Percent speed} \geq 78.9$  percent.

(3) Subzone 2b is defined by the following boundaries:

- (i) The line formed by connecting the following two points on a plot of speed-vs.-power:

(A)  $\text{Percent speed} = 70$  percent;  $\text{Percent power} = 28.7$  percent.

(B)  $\text{Percent power} = 40$  percent;  $\text{Speed} =$  governed speed.

(ii)  $\text{Percent power} + 100 < 0.7 \cdot (\text{percent speed} + 100)^{2.5}$ .

(4) Note that the line separating Subzone 1 and Subzone 2a includes the following endpoints:

(i)  $\text{Percent speed} = 78.9$  percent;  $\text{Percent power} = 63.3$  percent.

(ii)  $\text{Percent speed} = 84.6$  percent;  $\text{Percent power} = 46.1$  percent.

Figure 3 of Appendix III — NTE Zone and Subzones for Variable-Pitch or Electronically Coupled Engines\*

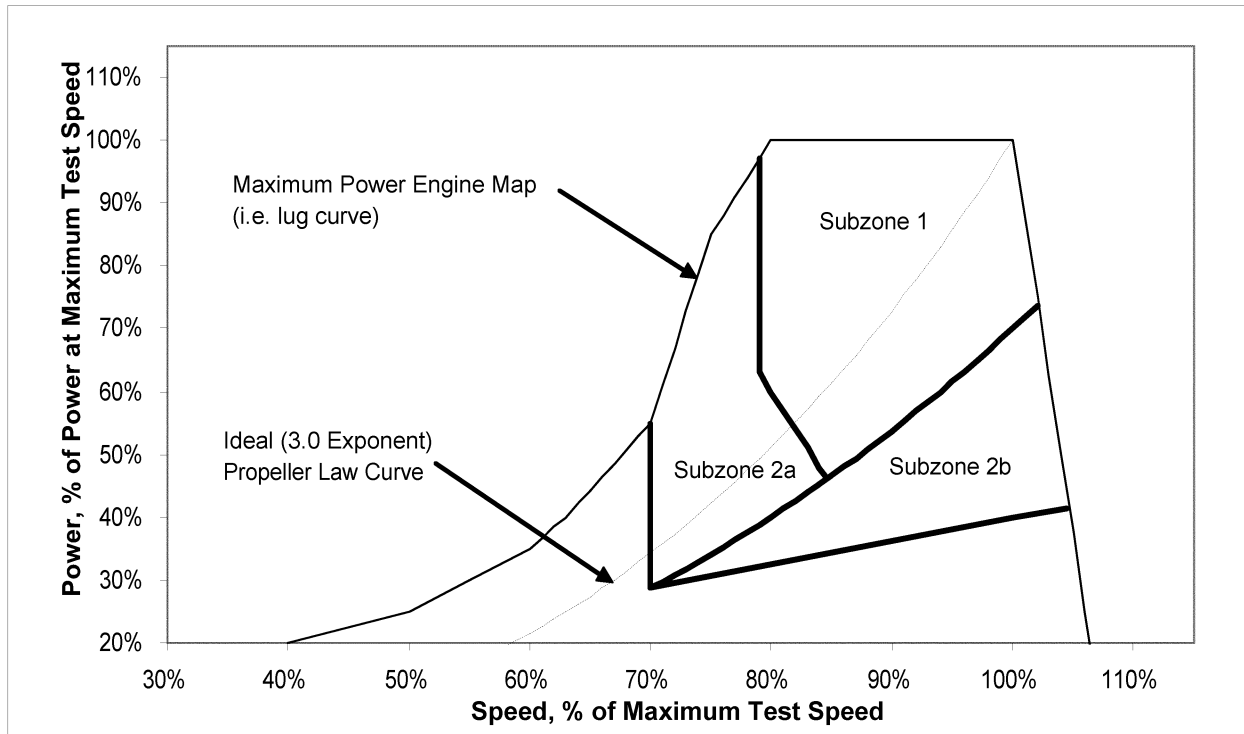

\*Shown for engines capable of operating on the E3 Duty Cycle.

(e) Figure 4 of this Appendix illustrates the default NTE zone for constant-speed engines certified using a duty cycle specified in § 1042.505(b)(3) or (4), as follows:

(1) Subzone 1 is defined by the following boundaries:  
 (i) Percent power  $\geq 70$  percent.  
 (ii) [Reserved]

(2) Subzone 2 is defined by the following boundaries:  
 (i) Percent power  $< 70$  percent.  
 (ii) Percent power  $\geq 40$  percent.

Figure 4 of Appendix III — NTE Zone and Subzones for Constant-Speed Marine Engines

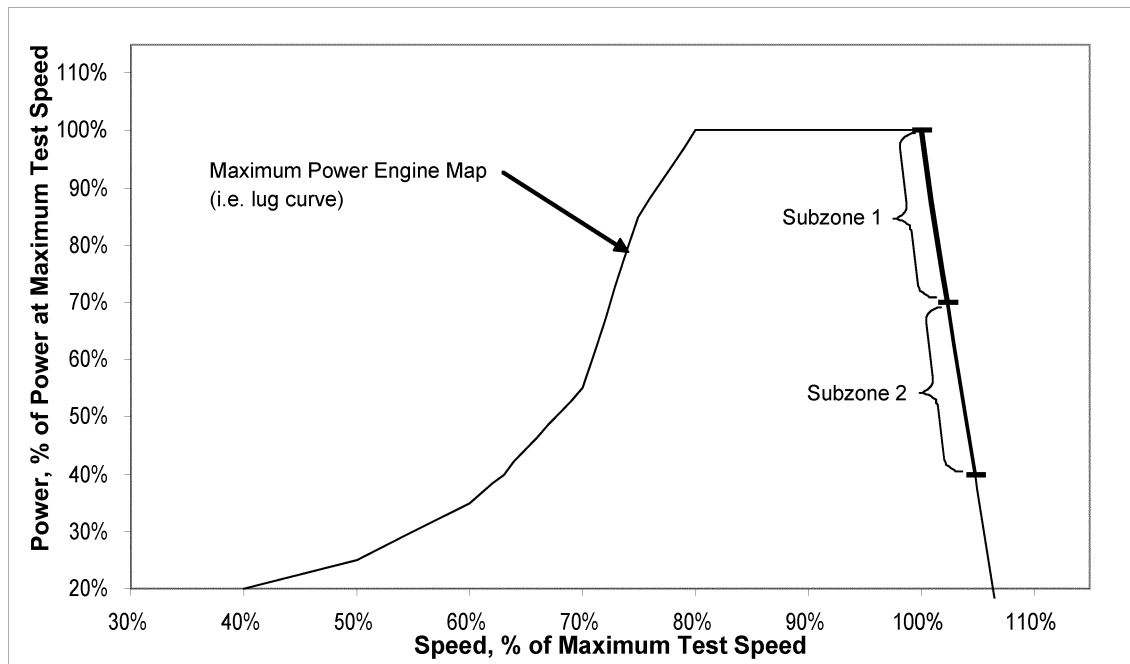

(f) Figure 5 of this Appendix illustrates the default NTE zone for variable-speed auxiliary marine engines certified using the duty cycle specified in § 1042.505(b)5(ii) or (iii), as follows:

- (1) The default NTE zone is defined by the boundaries specified in 40 CFR 86.1370(b)(1), (2), and (4).
- (2) A special PM subzone is defined in 40 CFR 1039.515(b).

Figure 5 of Appendix III — NTE Zone and Subzones for Variable-Speed Auxiliary Marine Engines (nonpropeller-law)

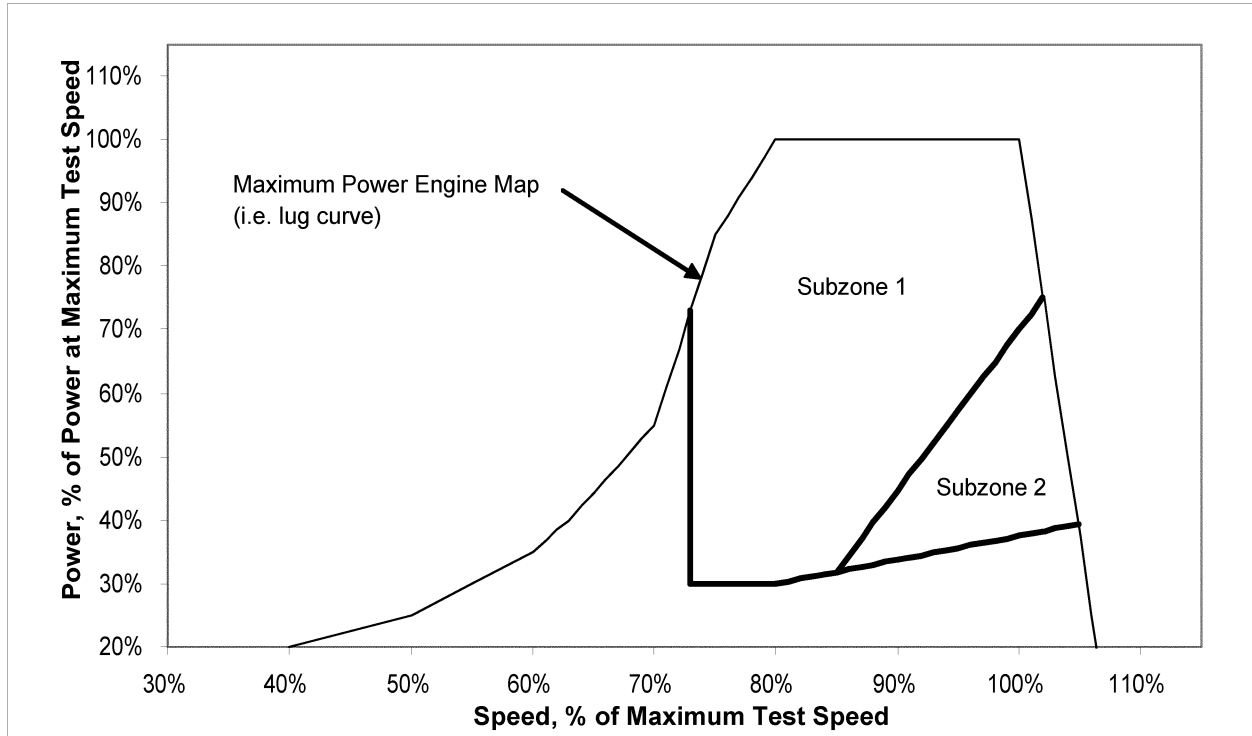

**PART 1043—CONTROL OF NO<sub>x</sub>, SO<sub>x</sub>, AND PM EMISSIONS FROM MARINE ENGINES AND VESSELS SUBJECT TO THE MARPOL PROTOCOL**

■ 233. The authority citation for part 1043 continues to read as follows:

**Authority:** 33 U.S.C. 1901–1912.

■ 234. Section 1043.60 is amended by revising paragraph (a) introductory text to read as follows:

**§ 1043.60 Operating requirements for engines and vessels subject to this part.**

\* \* \* \* \*

(a) Except as specified otherwise in this part, NO<sub>x</sub> emission limits apply to all engines with power output of more than 130 kW that will be installed on vessels subject to this part as specified in the following table:

\* \* \* \* \*

■ 235. Section 1043.100 is revised to read as follows:

**§ 1043.100 Incorporation by reference.**

(a) Certain material is incorporated by reference into this part with the approval of the Director of the Federal

Register under 5 U.S.C. 552(a) and 1 CFR part 51. To enforce any edition other than that specified in this section, the Environmental Protection Agency must publish a document in the **Federal Register** and the material must be available to the public. All approved material is available for inspection at U.S. EPA, Air and Radiation Docket and Information Center, 1301 Constitution Ave. NW., Room B102, EPA West Building, Washington, DC 20460, (202) 202–1744, and is available from the sources listed below. It is also available for inspection at the National Archives and Records Administration (NARA). For information on the availability of this material at NARA, call 202–741–6030, or go to: [http://www.archives.gov/federal\\_register/code\\_of\\_federal\\_regulations/ibr\\_locations.html](http://www.archives.gov/federal_register/code_of_federal_regulations/ibr_locations.html).

(b) The International Maritime Organization, 4 Albert Embankment, London SE1 7SR, United Kingdom, or [www.imo.org](http://www.imo.org), or 44-(0)20–7735–7611.

(1) MARPOL Annex VI, Regulations for the Prevention of Air Pollution from Ships, Third Edition, 2013, and NO<sub>x</sub> Technical Code 2008.

(i) Revised MARPOL Annex VI, Regulations for the Prevention of Pollution from Ships, Third Edition, 2013 (“2008 Annex VI”); IBR approved for §§ 1043.1 introductory text, 1043.20, 1043.30(f), 1043.60(c), and 1043.70(a).

(ii) NO<sub>x</sub> Technical Code 2008, Technical Code on Control of Emission of Nitrogen Oxides from Marine Diesel Engines, 2013 Edition, (“NO<sub>x</sub> Technical Code”); IBR approved for §§ 1043.20, 1043.41(b) and (h), and 1043.70(a).

(iii) Annex 12, Resolution MEPC.251(66) from the Report of the Marine Environment Protection Committee on its Sixty-Sixth Session, April 25, 2014. This document describes new and revised provisions that are considered to be part of Annex VI and NO<sub>x</sub> Technical Code 2008 as referenced in paragraphs (b)(1)(i) and (ii) of this section. IBR approved for §§ 1043.1 introductory text, 1043.20, 1043.30(f), 1043.41(b) and (h), 1043.60(c), and 1043.70(a).

(2) [Reserved]



**PART 1065—ENGINE-TESTING PROCEDURES**

■ 236. The authority citation for part 1065 continues to read as follows:

Authority: 42 U.S.C. 7401–7671q.

**Subpart A—Applicability and General Provisions**

■ 237. Section 1065.10 is amended by revising paragraph (c)(1)(ii) to read as follows:

**§ 1065.10 Other procedures.**

\* \* \* \* \*

(c) \* \* \*  
(1) \* \* \*

(ii) Whether the unrepresentative aspect of the procedures affects your ability to show compliance with the applicable emission standards.

\* \* \* \* \*

■ 238. Section 1065.15 is amended by revising paragraph (a)(2) to read as follows:

**§ 1065.15 Overview of procedures for laboratory and field testing.**

\* \* \* \* \*

(a) \* \* \*

(2) Hydrocarbon, HC, which may be expressed in the following ways:

(i) Total hydrocarbon, THC.

(ii) Nonmethane hydrocarbon, NMHC, which results from subtracting methane, CH<sub>4</sub>, from THC.

(iii) Nonmethane-nonethane hydrocarbon, NMNEHC, which results from subtracting methane, CH<sub>4</sub>, and ethane, C<sub>2</sub>H<sub>6</sub>, from THC.

(iv) Total hydrocarbon-equivalent, THCE, which results from adjusting THC mathematically to be equivalent on a carbon-mass basis.

(v) Nonmethane hydrocarbon-equivalent, NMHCE, which results from adjusting NMHC mathematically to be equivalent on a carbon-mass basis.

\* \* \* \* \*

**Subpart B—Equipment Specifications**

■ 239. Section 1065.140 is amended by revising paragraphs (d)(2) introductory text and (d)(3) introductory text to read as follows:

**§ 1065.140 Dilution for gaseous and PM constituents.**

\* \* \* \* \*

(d) \* \* \*

(2) *Constant dilution-ratio PFD.* Do one of the following for constant dilution-ratio PFD:

\* \* \* \* \*

(3) *Varying dilution-ratio PFD.* All the following provisions apply for varying dilution-ratio PFD:

\* \* \* \* \*

■ 240. Section 1065.170 is amended by revising Figure 1 as follows:

**§ 1065.170 Batch sampling for gaseous and PM constituents.**

\* \* \* \* \*

Figure 1 of § 1065.170—PM filter cassette specifications.

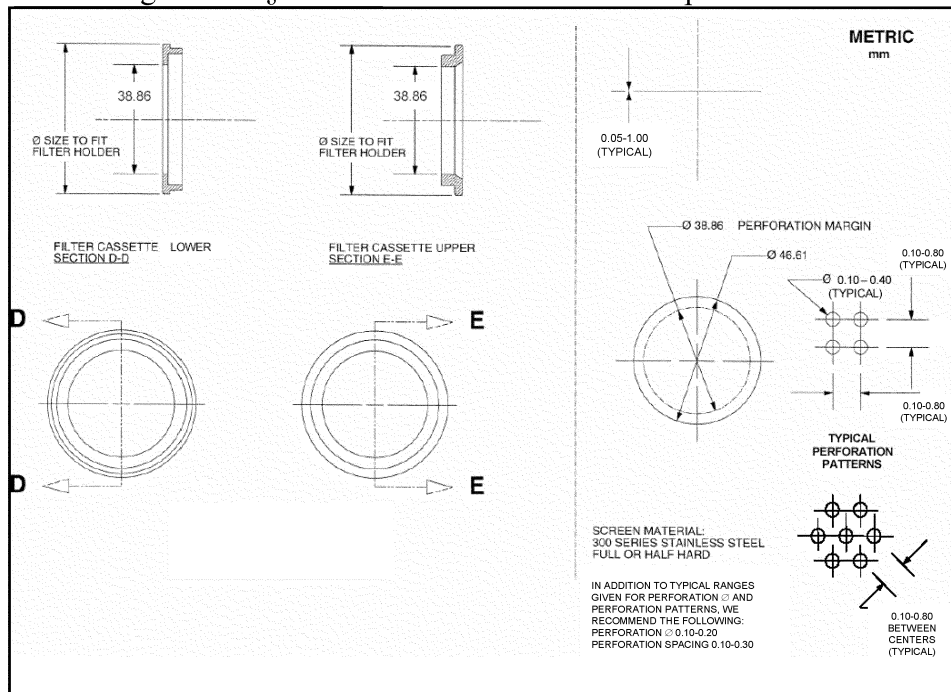

**Subpart C—Measurement Instruments**

■ 241. Section 1065.202 is amended by revising the introductory text to read as follows:

**§ 1065.202 Data updating, recording, and control.**

Your test system must be able to update data, record data and control systems related to operator demand, the dynamometer, sampling equipment, and

measurement instruments. Set up the measurement and recording equipment to avoid aliasing by ensuring that the sampling frequency is at least double that of the signal you are measuring, consistent with good engineering judgment; this may require increasing the sampling rate or filtering the signal. Use data acquisition and control systems that can record at the specified minimum frequencies, as follows:

\* \* \* \* \*

■ 242. Section 1065.220 is amended by revising paragraph (a) introductory text to read as follows:

**§ 1065.220 Fuel flow meter.**

(a) *Application.* You may use fuel flow in combination with a chemical balance of fuel, inlet air, and raw exhaust to calculate raw exhaust flow as described in § 1065.655(f), as follows:

\* \* \* \* \*

■ 243. Section 1065.225 is amended by revising paragraph (a) introductory text to read as follows:

**§ 1065.225 Intake-air flow meter.**

(a) *Application.* You may use an intake-air flow meter in combination with a chemical balance of fuel, inlet air, and exhaust to calculate raw exhaust flow as described in § 1065.655(f) and (g), as follows:

\* \* \* \* \*

■ 244. Add § 1065.247 to read as follows:

**§ 1065.247 Diesel exhaust fluid flow rate.**

(a) *Application.* Determine diesel exhaust fluid flow rate over a test interval for batch or continuous emission sampling using one of the three methods described in this section.

(b) *ECM.* Use the ECM signal directly to determine diesel exhaust fluid flow rate. You may combine this with a gravimetric scale if that improves measurement quality. Prior to testing, you may characterize the ECM signal using a laboratory measurement and adjust the ECM signal, consistent with good engineering judgment.

(c) *Flow meter.* Measure diesel exhaust fluid flow rate with a flow meter. We recommend that the flow meter that meets the specifications in Table 1 of § 1065.205. Note that your overall system for measuring diesel exhaust fluid flow must meet the linearity verification in § 1065.307. Measure using the following procedure:

(1) Condition the flow of diesel exhaust fluid as needed to prevent wakes, eddies, circulating flows, or flow pulsations from affecting the accuracy or repeatability of the meter. You may accomplish this by using a sufficient length of straight tubing (such as a length equal to at least 10 pipe diameters) or by using specially designed tubing bends, straightening fins, or pneumatic pulsation dampeners to establish a steady and predictable velocity profile upstream of the meter. Condition the flow as needed to prevent any gas bubbles in the fluid from affecting the flow meter.

(2) Account for any fluid that bypasses the engine or returns from the engine to the fluid storage tank.

(d) *Gravimetric scale.* Use a gravimetric scale to determine the mass of diesel exhaust fluid the engine uses over a discrete-mode test interval and divide by the time of the test interval.

■ 245. Section 1065.260 is amended by revising paragraphs (e) and (f) and adding paragraph (g) to read as follows:

**§ 1065.260 Flame-ionization detector.**

\* \* \* \* \*

(e) *NMHC and NMOG.* For demonstrating compliance with NMHC standards, you may either measure THC or determine NMHC mass as described in § 1065.660(b)(1), or you may measure THC and CH<sub>4</sub> and determine NMHC as described in § 1065.660(b)(2) or (3). For gaseous-fueled engines, you may also use the additive method in § 1065.660(b)(4). See 40 CFR 1066.635 for methods to demonstrate compliance with NMOG standards for vehicle testing.

(f) *NMNEHC.* For demonstrating compliance with NMNEHC standards, you may either measure NMHC or determine NMNEHC mass as described in § 1065.660(c)(1), you may measure THC, CH<sub>4</sub>, and C<sub>2</sub>H<sub>6</sub> and determine NMNEHC as described in § 1065.660(c)(2), or you may use the additive method in § 1065.660(c)(3).

(g) *CH<sub>4</sub>.* For reporting CH<sub>4</sub> or for demonstrating compliance with CH<sub>4</sub> standards, you may use a FID analyzer with a nonmethane cutter as described in § 1065.265 or you may use a GC-FID as described in § 1065.267. Determine CH<sub>4</sub> as described in § 1065.660(d).

■ 246. Add § 1065.266 to subpart C to read as follows:

**§ 1065.266 Fourier transform infrared analyzer.**

(a) *Application.* For engines that run only on natural gas, you may use a Fourier transform infrared (FTIR) analyzer to measure nonmethane hydrocarbon (NMHC) and nonmethane-nonethane hydrocarbon (NMNEHC) for continuous sampling. You may use an FTIR analyzer with any gaseous-fueled engine, including dual-fuel engines, to measure CH<sub>4</sub> and C<sub>2</sub>H<sub>6</sub>, for either batch or continuous sampling (for subtraction from THC).

(b) *Component requirements.* We recommend that you use an FTIR analyzer that meets the specifications in Table 1 of § 1065.205. Note that your FTIR-based system must meet the linearity verification in § 1065.307. Use appropriate analytical procedures for interpretation of infrared spectra. For example, EPA Test Method 320 (see <https://www3.epa.gov/ttn/emc/promgate/m-320.pdf>) and ASTM D6348 (incorporated by reference in § 1065.1010) are considered valid methods for spectral interpretation. You must use heated FTIR analyzers that maintain all surfaces that are exposed to emissions at a temperature of (110 to 202) °C.

(c) *Hydrocarbon species for NMHC and NMNEHC additive determination.* To determine NMNEHC, measure ethene, ethyne, propane, propene, butane, formaldehyde, acetaldehyde,

formic acid, and methanol. To determine NMHC, measure ethane in addition to those same hydrocarbon species. Determine NMHC and NMNEHC as described in § 1065.660(b)(4) and § 1065.660(c)(3).

(d) *NMHC and NMNEHC CH<sub>4</sub> and C<sub>2</sub>H<sub>6</sub> determination from subtraction of CH<sub>4</sub> and C<sub>2</sub>H<sub>6</sub> from THC.* Determine CH<sub>4</sub> as described in § 1065.660(d)(2) and C<sub>2</sub>H<sub>6</sub> as described § 1065.660(e).

Determine NMHC from subtraction of CH<sub>4</sub> from THC as described in § 1065.660(b)(3) and NMNEHC from subtraction of CH<sub>4</sub> and C<sub>2</sub>H<sub>6</sub> as described § 1065.660(c)(2). Determine CH<sub>4</sub> as described in § 1065.660(d)(2) and C<sub>2</sub>H<sub>6</sub> as described § 1065.660(e).

(e) *Interference verification.* Perform interference verification for FTIR analyzers using the procedures of § 1065.366. Certain interference gases can interfere with FTIR analyzers by causing a response similar to the hydrocarbon species of interest. When running the interference verification for these analyzers, use interference gases as follows:

(1) The interference gases for CH<sub>4</sub> are CO<sub>2</sub>, H<sub>2</sub>O, and C<sub>2</sub>H<sub>6</sub>.

(2) The interference gases for C<sub>2</sub>H<sub>6</sub> are CO<sub>2</sub>, H<sub>2</sub>O, and CH<sub>4</sub>.

(3) The interference gases for other measured hydrocarbon species are CO<sub>2</sub>, H<sub>2</sub>O, CH<sub>4</sub>, and C<sub>2</sub>H<sub>6</sub>.

■ 247. Section 1065.267 is amended by revising paragraph (a) to read as follows:

**§ 1065.267 Gas chromatograph with a flame ionization detector.**

(a) *Application.* You may use a gas chromatograph with a flame ionization detector (GC-FID) to measure CH<sub>4</sub> and C<sub>2</sub>H<sub>6</sub> concentrations of diluted exhaust for batch sampling. While you may also use a nonmethane cutter to measure CH<sub>4</sub>, as described in § 1065.265, use a reference procedure based on a gas chromatograph for comparison with any proposed alternate measurement procedure under § 1065.10.

\* \* \* \* \*

■ 248. Section 1065.275 is amended by revising paragraph (b)(2) to read as follows:

**§ 1065.275 N<sub>2</sub>O measurement devices.**

\* \* \* \* \*

(b) \* \* \* \* \*  
(2) Fourier transform infrared (FTIR) analyzer. Use appropriate analytical procedures for interpretation of infrared spectra. For example, EPA Test Method 320 (see <https://www3.epa.gov/ttn/emc/promgate/m-320.pdf>) and ASTM D6348 (incorporated by reference in § 1065.1010) are considered valid methods for spectral interpretation.

\* \* \* \* \*

**Subpart D—Calibrations and Verifications**

**§ 1065.303 Summary of required calibration and verifications.**

subpart and indicates when these have to be performed:

■ 249. Section 1065.303 is revised to read as follows:

The following table summarizes the required and recommended calibrations and verifications described in this

**TABLE 1 OF § 1065.303—SUMMARY OF REQUIRED CALIBRATION AND VERIFICATIONS**

Type of calibration or verification	Minimum frequency <sup>1</sup>
§ 1065.305: Accuracy, repeatability and noise .....	Accuracy: Not required, but recommended for initial installation. Repeatability: Not required, but recommended for initial installation. Noise: Not required, but recommended for initial installation.
§ 1065.307: Linearity verification .....	Speed: Upon initial installation, within 370 days before testing and after major maintenance. Torque: Upon initial installation, within 370 days before testing and after major maintenance. Electrical power, current, and voltage: Upon initial installation, within 370 days before testing and after major maintenance. <sup>2</sup> Fuel flow rate: Upon initial installation, within 370 days before testing, and after major maintenance. DEF flow: Upon initial installation, within 370 days before testing, and after major maintenance. Intake-air, dilution air, diluted exhaust, and batch sampler flow rates: Upon initial installation, within 370 days before testing and after major maintenance, unless flow is verified by propane check or by carbon or oxygen balance. Raw exhaust flow rate: Upon initial installation, within 185 days before testing and after major maintenance, unless flow is verified by propane check or by carbon or oxygen balance. Gas dividers: Upon initial installation, within 370 days before testing, and after major maintenance. Gas analyzers (unless otherwise noted): Upon initial installation, within 35 days before testing and after major maintenance. FTIR and photoacoustic analyzers: Upon initial installation, within 370 days before testing and after major maintenance. GC-ECD: Upon initial installation and after major maintenance. PM balance: Upon initial installation, within 370 days before testing and after major maintenance. Pressure, temperature, and dewpoint: Upon initial installation, within 370 days before testing and after major maintenance.
§ 1065.308: Continuous gas analyzer system response and updating-recording verification—for gas analyzers not continuously compensated for other gas species.	Upon initial installation or after system modification that would affect response.
§ 1065.309: Continuous gas analyzer system-response and updating-recording verification—for gas analyzers continuously compensated for other gas species.	Upon initial installation or after system modification that would affect response.
§ 1065.310: Torque .....	Upon initial installation and after major maintenance.
§ 1065.315: Pressure, temperature, dewpoint .....	Upon initial installation and after major maintenance.
§ 1065.320: Fuel flow .....	Upon initial installation and after major maintenance.
§ 1065.325: Intake flow .....	Upon initial installation and after major maintenance.
§ 1065.330: Exhaust flow .....	Upon initial installation and after major maintenance.
§ 1065.340: Diluted exhaust flow (CVS) .....	Upon initial installation and after major maintenance.
§ 1065.341: CVS and batch sampler verification <sup>3</sup> .....	Upon initial installation, within 35 days before testing, and after major maintenance.
§ 1065.342 Sample dryer verification .....	For thermal chillers: Upon installation and after major maintenance. For osmotic membranes; Upon installation, within 35 days of testing, and after major maintenance.
§ 1065.345: Vacuum leak .....	For laboratory testing: Upon initial installation of the sampling system, within 8 hours before the start of the first test interval of each duty-cycle sequence, and after maintenance such as pre-filter changes. For field testing: After each installation of the sampling system on the vehicle, prior to the start of the field test, and after maintenance such as pre-filter changes.
§ 1065.350: CO <sub>2</sub> NDIR H <sub>2</sub> O interference .....	Upon initial installation and after major maintenance.
§ 1065.355: CO NDIR CO <sub>2</sub> and H <sub>2</sub> O interference .....	Upon initial installation and after major maintenance.
§ 1065.360: FID calibration THC FID optimization, and THC FID verification.	Calibrate all FID analyzers: Upon initial installation and after major maintenance. Optimize and determine CH <sub>4</sub> response for THC FID analyzers: Upon initial installation and after major maintenance. Verify CH <sub>4</sub> response for THC FID analyzers: Upon initial installation, within 185 days before testing, and after major maintenance. Verify C <sub>2</sub> H <sub>6</sub> response for THC FID analyzers if used for NMNEHC determination: Upon initial installation, within 185 days before testing, and after major maintenance.
§ 1065.362: Raw exhaust FID O <sub>2</sub> interference .....	For all FID analyzers: Upon initial installation, and after major maintenance. For THC FID analyzers: Upon initial installation, after major maintenance, and after FID optimization according to § 1065.360.

TABLE 1 OF § 1065.303—SUMMARY OF REQUIRED CALIBRATION AND VERIFICATIONS—Continued

Type of calibration or verification	Minimum frequency <sup>1</sup>
§ 1065.365: Nonmethane cutter penetration .....	Upon initial installation, within 185 days before testing, and after major maintenance.
§ 1065.366: Interference verification for FTIR analyzers.	Upon initial installation and after major maintenance.
§ 1065.369: H <sub>2</sub> O, CO, and CO <sub>2</sub> interference verification for ethanol photoacoustic analyzers.	Upon initial installation and after major maintenance.
§ 1065.370: CLD CO <sub>2</sub> and H <sub>2</sub> O quench .....	Upon initial installation and after major maintenance.
§ 1065.372: NDUV HC and H <sub>2</sub> O interference .....	Upon initial installation and after major maintenance.
§ 1065.375: N <sub>2</sub> O analyzer interference .....	Upon initial installation and after major maintenance.
§ 1065.376: Chiller NO <sub>2</sub> penetration .....	Upon initial installation and after major maintenance.
§ 1065.378: NO <sub>2</sub> -to-NO converter conversion .....	Upon initial installation, within 35 days before testing, and after major maintenance.
§ 1065.390: PM balance and weighing .....	Independent verification: Upon initial installation, within 370 days before testing, and after major maintenance. Zero, span, and reference sample verifications: Within 12 hours of weighing, and after major maintenance.
§ 1065.395: Inertial PM balance and weighing .....	Independent verification: Upon initial installation, within 370 days before testing, and after major maintenance. Other verifications: Upon initial installation and after major maintenance.

<sup>1</sup> Perform calibrations and verifications more frequently than we specify, according to measurement system manufacturer instructions and good engineering judgment.

<sup>2</sup> Perform linearity verification either for electrical power or for current and voltage.

<sup>3</sup> The CVS verification described in § 1065.341 is not required for systems that agree within ±2% based on a chemical balance of carbon or oxygen of the intake air, fuel, and diluted exhaust.

■ 250. Section 1065.340 is amended by revising paragraphs (e), (f)(8), (f)(13), (g), (h), and Figure 1 to read as follows:

**§ 1065.340 Diluted exhaust flow (CVS) calibration.**

\* \* \* \* \*

(e) *Configuration.* Calibrate the system with any upstream screens or other restrictions that will be used during testing and that could affect the flow ahead of the CVS flow meter, using good engineering judgment to minimize the effect on the flow distribution. You may not use any upstream screen or other restriction that could affect the flow ahead of the reference flow meter, unless the flow meter has been calibrated with such a restriction. In the case of a free standing SSV reference flow meter, you may not have any upstream screens.

(f) \* \* \*

(8) Repeat the steps in paragraphs (e)(6) and (7) of this section to record data at a minimum of six restrictor positions ranging from the wide open restrictor position to the minimum expected pressure at the PDP inlet or the maximum expected differential (outlet minus inlet) pressure across the PDP during testing.

\* \* \* \* \*

(13) During emission testing ensure that the PDP is not operated either below the lowest inlet pressure point or above the highest differential pressure point in the calibration data.

(g) *SSV calibration.* Calibrate a subsonic venturi (SSV) to determine its calibration coefficient,  $C_d$ , for the expected range of inlet pressures. Calibrate an SSV flow meter as follows:

(1) Connect the system as shown in Figure 1 of this section.

(2) Verify that any leaks between the calibration flow meter and the SSV are less than 0.3% of the total flow at the highest restriction.

(3) Start the blower downstream of the SSV.

(4) While the SSV operates, maintain a constant temperature at the SSV inlet within ±2% of the mean absolute inlet temperature,

$$\bar{T}_{in.}$$

(5) Set the variable restrictor or variable-speed blower to a flow rate greater than the greatest flow rate expected during testing. You may not extrapolate flow rates beyond calibrated values, so we recommend that you make sure the Reynolds number,  $Re^\#$ , at the SSV throat at the greatest calibrated flow rate is greater than the maximum  $Re^\#$  expected during testing.

(6) Operate the SSV for at least 3 min to stabilize the system. Continue operating the SSV and record the mean of at least 30 seconds of sampled data of each of the following quantities:

(i) The mean flow rate of the reference flow meter  $\bar{n}_{ref}$ . This may include several measurements of different quantities for calculating  $\bar{n}_{ref}$ , such as reference meter pressures and temperatures.

(ii) Optionally, the mean dewpoint of the calibration air,  $\bar{T}_{dew}$ . See § 1065.640 for permissible assumptions.

(iii) The mean temperature at the venturi inlet,  $\bar{T}_{in.}$

(iv) The mean static absolute pressure at the venturi inlet,  $\bar{P}_{in.}$

(v) The mean static differential pressure between the static pressure at

the venturi inlet and the static pressure at the venturi throat,  $\Delta\bar{P}_{SSV}$ .

(7) Incrementally close the restrictor valve or decrease the blower speed to decrease the flow rate.

(8) Repeat the steps in paragraphs (g)(6) and (7) of this section to record data at a minimum of ten flow rates.

(9) Determine an equation to quantify  $C_d$  as a function of  $Re^\#$  by using the collected data and the equations in § 1065.640. Section 1065.640 also includes statistical criteria for validating the  $C_d$  versus  $Re^\#$  equation.

(10) Verify the calibration by performing a CVS verification (*i.e.*, propane check) as described in § 1065.341 using the new  $C_d$  versus  $Re^\#$  equation.

(11) Use the SSV only between the minimum and maximum calibrated  $Re^\#$ . If you want to use the SSV at a lower or higher  $Re^\#$ , you must recalibrate the SSV.

(12) Use the equations in § 1065.642 to determine SSV flow during a test.

(h) *CFV calibration.* Calibrate a critical-flow venturi (CFV) to verify its discharge coefficient,  $C_d$ , up to the highest expected pressure ratio,  $r$ , according to § 1065.640. Calibrate a CFV flow meter as follows:

(1) Connect the system as shown in Figure 1 of this section.

(2) Verify that any leaks between the calibration flow meter and the CFV are less than 0.3% of the total flow at the highest restriction.

(3) Start the blower downstream of the CFV.

(4) While the CFV operates, maintain a constant temperature at the CFV inlet

within  $\pm 2\%$  of the mean absolute inlet temperature,  $\bar{T}_{in}$ .

(5) Set the variable restrictor to its wide-open position. Instead of a variable restrictor, you may alternately vary the pressure downstream of the CFV by varying blower speed or by introducing a controlled leak. Note that some blowers have limitations on nonloaded conditions.

(6) Operate the CFV for at least 3 min to stabilize the system. Continue operating the CFV and record the mean values of at least 30 seconds of sampled data of each of the following quantities:

(i) The mean flow rate of the reference flow meter,  $\bar{n}_{ref}$ . This may include several measurements of different quantities, such as reference meter pressures and temperatures, for calculating  $\bar{n}_{ref}$ .

(ii) The mean dewpoint of the calibration air,  $\bar{T}_{dew}$ . See § 1065.640 for permissible assumptions during emission measurements.

(iii) The mean temperature at the venturi inlet,  $\bar{T}_{in}$ .

(iv) The mean static absolute pressure at the venturi inlet,  $\bar{P}_{in}$ .

(v) The mean static differential pressure between the CFV inlet and the CFV outlet,  $\Delta\bar{P}_{CFV}$ .

(7) Incrementally close the restrictor valve or decrease the downstream pressure to decrease the differential pressure across the CFV,  $\Delta p_{CFV}$ .

(8) Repeat the steps in paragraphs (f)(6) and (7) of this section to record mean data at a minimum of ten restrictor positions, such that you test the fullest practical range of  $\Delta\bar{P}_{CFV}$  expected during testing. We do not require that you remove calibration components or CVS components to calibrate at the lowest possible restrictions.

(9) Determine  $C_d$  and the highest allowable pressure ratio,  $r$ , according to § 1065.640.

(10) Use  $C_d$  to determine CFV flow during an emission test. Do not use the CFV above the highest allowed  $r$ , as determined in § 1065.640.

(11) Verify the calibration by performing a CVS verification (*i.e.*, propane check) as described in § 1065.341.

(12) If your CVS is configured to operate more than one CFV at a time in parallel, calibrate your CVS by one of the following:

(i) Calibrate every combination of CFVs according to this section and § 1065.640. Refer to § 1065.642 for instructions on calculating flow rates for this option.

(ii) Calibrate each CFV according to this section and § 1065.640. Refer to § 1065.642 for instructions on calculating flow rates for this option.

\* \* \* \* \*

Figure 1 of § 1065.340—CVS calibration configurations.

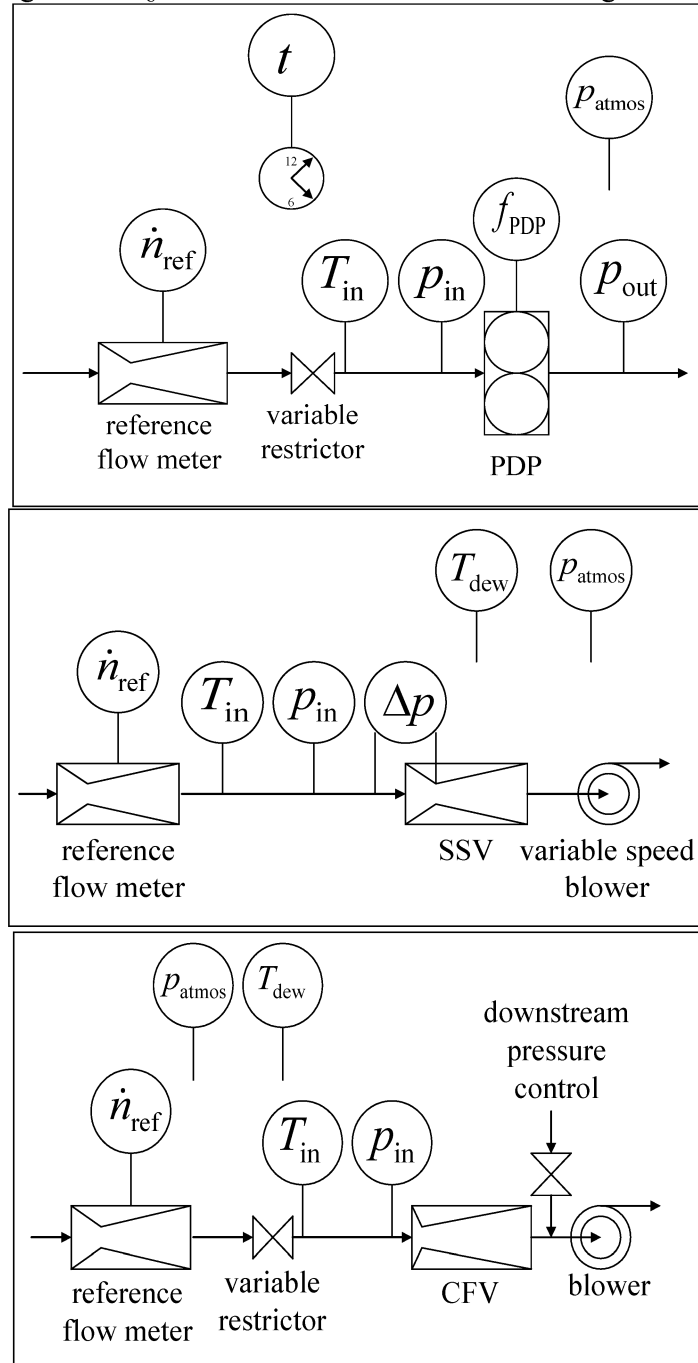

**BILLING CODE 6550-50-C**

■ 251. Section 1065.341 is amended by revising paragraph (c)(3) to read as follows:

**§ 1065.341 CVS, PFD, and batch sampler verification (propane check).**

\* \* \* \* \*

(c) \* \* \*

(3) Select a C<sub>3</sub>H<sub>8</sub> injection port in the CVS. Select the port location to be as close as practical to the location where you introduce engine exhaust into the CVS, or at some point in the laboratory

exhaust tubing upstream of this location. Connect the C<sub>3</sub>H<sub>8</sub> cylinder to the injection system.

\* \* \* \* \*

■ 252. Section 1065.345 is amended by revising paragraphs (d)(2), (d)(4), (e)(3), and (e)(4) to read as follows:

**§ 1065.345 Vacuum-side leak verification.**

\* \* \* \* \*

(d) \* \* \*

(2) Supply span gas to the analyzer span port and record the measured value.

\* \* \* \* \*

(4) Verify that the measured overflow span gas concentration is within ±0.5% of the concentration measured in paragraph (d)(2) of this section. A measured value lower than expected indicates a leak, but a value higher than expected may indicate a problem with the span gas or the analyzer itself. A measured value higher than expected does not indicate a leak.

(e) \* \* \*

(3) Turn off the sample pumps and seal the system. Measure and record the absolute pressure of the trapped gas and optionally the system absolute temperature. Wait long enough for any transients to settle and long enough for a leak at 0.5% to have caused a pressure change of at least 10 times the resolution of the pressure transducer, then again record the pressure and optionally temperature.

(4) Calculate the leak flow rate based on an assumed value of zero for pumped-down bag volumes and based on known values for the sample system volume, the initial and final pressures, optional temperatures, and elapsed time. Using the calculations specified in § 1065.644, verify that the vacuum-decay leak flow rate is less than 0.5% of the system's normal in-use flow rate.

■ 253. Section 1065.360 is amended by revising paragraphs (a)(3), (d) introductory text, and (d)(7) and adding paragraph (f) to read as follows:

**§ 1065.360 FID optimization and verification.**

(a) \* \* \*

(3) If you determine NMNEHC by subtracting from measured THC, determine the ethane (C<sub>2</sub>H<sub>6</sub>) response factor after initial analyzer installation and after major maintenance as described in paragraph (f) of this section. Verify the C<sub>2</sub>H<sub>6</sub> response within 185 days before testing as described in paragraph (f) of this section.

\* \* \* \* \*

(d) *THC FID CH<sub>4</sub> response factor determination.* This procedure is only for FID analyzers that measure THC. Since FID analyzers generally have a different response to CH<sub>4</sub> versus C<sub>3</sub>H<sub>8</sub>, determine the THC-FID analyzer's CH<sub>4</sub> response factor,  $RF_{CH_4[THC-FID]}$ , after FID optimization. Use the most recent  $RF_{CH_4[THC-FID]}$  measured according to this section in the calculations for HC determination described in § 1065.660 to compensate for CH<sub>4</sub> response. Determine  $RF_{CH_4[THC-FID]}$  as follows, noting that you do not determine  $RF_{CH_4[THC-FID]}$  for FIDs that are calibrated and spanned using CH<sub>4</sub> with a nonmethane cutter:

\* \* \* \* \*

(7) Introduce the CH<sub>4</sub> span gas that you selected under paragraph (d)(2) of this section into the FID analyzer.

\* \* \* \* \*

(f) *THC FID C<sub>2</sub>H<sub>6</sub> response factor determination.* This procedure is only for FID analyzers that measure THC. Since FID analyzers generally have a different response to C<sub>2</sub>H<sub>6</sub> than C<sub>3</sub>H<sub>8</sub>, determine the THC-FID analyzer's C<sub>2</sub>H<sub>6</sub>

response factor,  $RF_{C_2H_6[THC-FID]}$ , after FID optimization using the procedure described in paragraph (d) of this section, replacing CH<sub>4</sub> with C<sub>2</sub>H<sub>6</sub>. Use the most recent  $RF_{C_2H_6[THC-FID]}$  measured according to this section in the calculations for HC determination described in § 1065.660 to compensate for C<sub>2</sub>H<sub>6</sub> response.

■ 254. Section 1065.365 is amended by revising paragraphs (d)(9), (e)(10), (f)(9), and (f)(14) to read as follows:

**§ 1065.365 Nonmethane cutter penetration fractions.**

\* \* \* \* \*

(d) \* \* \*

(9) Divide the mean C<sub>2</sub>H<sub>6</sub> concentration by the reference concentration of C<sub>2</sub>H<sub>6</sub>, converted to a C<sub>1</sub> basis. The result is the C<sub>2</sub>H<sub>6</sub> combined response factor and penetration fraction,  $RF_{PF_{C_2H_6[NMC-FID]}}$ . Use this combined response factor and penetration fraction and the product of the CH<sub>4</sub> response factor and CH<sub>4</sub> penetration fraction,  $RF_{PF_{CH_4[NMC-FID]}}$ , set to 1.0 in emission calculations according to § 1065.660(b)(2)(i), § 1065.660(d)(1)(i), or § 1065.665, as applicable.

(e) \* \* \*

(10) Divide the mean C<sub>2</sub>H<sub>6</sub> concentration measured through the nonmethane cutter by the mean C<sub>2</sub>H<sub>6</sub> concentration measured after bypassing the nonmethane cutter. The result is the C<sub>2</sub>H<sub>6</sub> penetration fraction,  $PF_{C_2H_6[NMC-FID]}$ . Use this penetration fraction according to § 1065.660(b)(2)(ii), § 1065.660(d)(1)(ii), or § 1065.665, as applicable.

\* \* \* \* \*

(f) \* \* \*

(9) Divide the mean C<sub>2</sub>H<sub>6</sub> concentration by the reference concentration of C<sub>2</sub>H<sub>6</sub>, converted to a C<sub>1</sub> basis. The result is the C<sub>2</sub>H<sub>6</sub> combined response factor and penetration fraction,  $RF_{PF_{C_2H_6[NMC-FID]}}$ . Use this combined response factor and penetration fraction according to § 1065.660(b)(2)(iii), § 1065.660(d)(1)(iii), or § 1065.665, as applicable.

\* \* \* \* \*

(14) Divide the mean CH<sub>4</sub> concentration measured through the nonmethane cutter by the mean CH<sub>4</sub> concentration measured after bypassing the nonmethane cutter. The result is the CH<sub>4</sub> penetration fraction,  $PF_{CH_4[NMC-FID]}$ . Use this penetration fraction according to § 1065.660(b)(2)(iii), § 1065.660(d)(1)(iii), or § 1065.665, as applicable.

■ 255. Section 1065.366 is added to subpart D to read as follows:

**§ 1065.366 Interference verification for FTIR analyzers.**

(a) *Scope and frequency.* If you measure CH<sub>4</sub>, C<sub>2</sub>H<sub>6</sub>, NMHC, or NMNEHC using an FTIR analyzer, verify the amount of interference after initial analyzer installation and after major maintenance.

(b) *Measurement principles.* Interference gases can interfere with certain analyzers by causing a response similar to the target analyte. If the analyzer uses compensation algorithms that utilize measurements of other gases to meet this interference verification, simultaneously conduct these other measurements to test the compensation algorithms during the analyzer interference verification.

(c) *System requirements.* An FTIR analyzer must have combined interference that is within ±2% of the flow-weighted mean concentration of CH<sub>4</sub>, NMHC, or NMNEHC expected at the standard, though we strongly recommend a lower interference that is within ±1%.

(d) *Procedure.* Perform the interference verification for an FTIR analyzer using the same procedure that applies for N<sub>2</sub>O analyzers in § 1065.375(d).

■ 256. Section 1065.370 is amended by revising paragraph (d)(11) to read as follows:

**§ 1065.370 CLD CO<sub>2</sub> and H<sub>2</sub>O quench verification.**

\* \* \* \* \*

(d) \* \* \*

(11) Calculate the actual NO concentration at the gas divider's outlet,  $X_{NOact}$ , based on the span gas concentrations and  $X_{CO_2act}$  according to Eq. 1065.675-2. Use the calculated value in the quench verification calculations in Eq. 1065.675-1.

\* \* \* \* \*

■ 257. Section 1065.375 is amended by revising paragraph (b) to read as follows:

**§ 1065.375 Interference verification for N<sub>2</sub>O analyzers.**

\* \* \* \* \*

(b) *Measurement principles.* Interference gases can positively interfere with certain analyzers by causing a response similar to N<sub>2</sub>O. If the analyzer uses compensation algorithms that utilize measurements of other gases to meet this interference verification, simultaneously conduct these other measurements to test the compensation algorithms during the analyzer interference verification.

\* \* \* \* \*

■ 258. Section 1065.390 is amended by revising paragraphs (b), (c) introductory text, and (c)(2) to read as follows:

**§ 1065.390 PM balance verifications and weighing process verification.**

\* \* \* \* \*

(b) *Independent verification.* Have the balance manufacturer (or a representative approved by the balance manufacturer) verify the balance performance within 370 days of testing. Balances have internal weights that compensate for drift due to environmental changes. These internal weights must be verified as part of this independent verification with external, certified calibration weights that meet the specifications in § 1065.790.

(c) *Zeroing and spanning.* You must verify balance performance by zeroing and spanning it with at least one calibration weight. Also, any external weights you use must meet the specifications in § 1065.790. Any weights internal to the PM balance used for this verification must be verified as described in paragraph (b) of this section.

\* \* \* \* \*

(2) You may use an automated procedure to verify balance performance. For example most balances have internal weights for automatically verifying balance performance.

\* \* \* \* \*

**Subpart F—Performing an Emission Test in the Laboratory**

■ 259. Section 1065.510 is amended by revising paragraphs (c) introductory text, (c)(4), and (d)(5)(i) and (iii) to read as follows:

**§ 1065.510 Engine mapping.**

\* \* \* \* \*

(c) *Negative torque mapping.* If your engine is subject to a reference duty cycle that specifies negative torque values (*i.e.*, engine motoring), generate a motoring torque curve by any of the following procedures:

\* \* \* \* \*

(4) For engines with an electric hybrid system, map the negative torque required to motor the engine and absorb any power delivered from the RESS by repeating paragraph (g)(2) of this section with minimum operator demand, stopping the sweep to discharge the RESS when the absolute instantaneous power measured from the RESS drops below the expected maximum absolute power from the RESS by more than 2% of total system maximum power (including engine motoring and RESS power) as determined from mapping the negative torque.

(d) \* \* \*

(5) \* \* \*

(i) For constant-speed engines subject only to steady-state testing, you may perform an engine map by using a series of discrete torques. Select at least five evenly spaced torque setpoints from no-load to 80% of the manufacturer-declared test torque or to a torque derived from your published maximum power level if the declared test torque is unavailable. Starting at the 80% torque point, select setpoints in 2.5% or smaller intervals, stopping at the endpoint torque. The endpoint torque is defined as the first discrete mapped torque value greater than the torque at maximum observed power where the engine outputs 90% of the maximum observed power; or the torque when engine stall has been determined using good engineering judgment (*i.e.* sudden deceleration of engine speed while adding torque). You may continue mapping at higher torque setpoints. At each setpoint, allow torque and speed to stabilize. Record the mean feedback speed and torque at each setpoint. From this series of mean feedback speed and torque values, use linear interpolation to determine intermediate values. Use this series of mean feedback speeds and torques to generate the power map as described in paragraph (e) of this section.

\* \* \* \* \*

(iii) For any isochronous governed (0% speed droop) constant-speed engine, you may map the engine with two points as described in this paragraph (d)(5)(iii). After stabilizing at the no-load governed speed in paragraph (d)(4) of this section, record the mean feedback speed and torque. Continue to operate the engine with the governor or simulated governor controlling engine speed using operator demand, and control the dynamometer to target a speed of 99.5% of the recorded mean no-load governed speed. Allow speed and torque to stabilize. Record the mean feedback speed and torque. Record the target speed. The absolute value of the speed error (the mean feedback speed minus the target speed) must be no greater than 0.1% of the recorded mean no-load governed speed. From this series of two mean feedback speed and torque values, use linear interpolation to determine intermediate values. Use this series of two mean feedback speeds and torques to generate a power map as described in paragraph (e) of this section. Note that the measured maximum test torque as determined in § 1065.610 (b)(1) will be the mean feedback torque recorded on the second point.

\* \* \* \* \*

■ 260. Section 1065.546 is amended by revising paragraph (a) to read as follows:

**§ 1065.546 Verification of minimum dilution ratio for PM batch sampling.**

\* \* \* \* \*

(a) Determine minimum dilution ratio based on molar flow data. This involves determination of at least two of the following three quantities: raw exhaust flow (or previously diluted flow), dilution air flow, and dilute exhaust flow. You may determine the raw exhaust flow rate based on the measured intake air or fuel flow rate and the raw exhaust chemical balance terms as given in § 1065.655(f). You may determine the raw exhaust flow rate based on the measured intake air and dilute exhaust molar flow rates and the dilute exhaust chemical balance terms as given in § 1065.655(g). You may alternatively estimate the molar raw exhaust flow rate based on intake air, fuel rate measurements, and fuel properties, consistent with good engineering judgment.

\* \* \* \* \*

■ 261. Section 1065.590 is amended by revising paragraphs (f)(2), (j) introductory text, and (j)(3) through (7) to read as follows:

**§ 1065.590 PM sampling media (e.g., filters) preconditioning and tare weighing.**

\* \* \* \* \*

(f) \* \* \*

(2) Use good engineering judgment to determine if substitution weighing is necessary to show that an engine meets the applicable standard. You may follow the substitution weighing procedure in paragraph (j) of this section, or you may develop your own procedure.

\* \* \* \* \*

(j) Substitution weighing involves measurement of a reference weight before and after each weighing of the PM sampling medium (*e.g.*, the filter). While substitution weighing requires more measurements, it corrects for a balance's zero-drift and it relies on balance linearity only over a small range. This is most advantageous when quantifying net PM masses that are less than 0.1% of the sample medium's mass. However, it may not be advantageous when net PM masses exceed 1% of the sample medium's mass. If you utilize substitution weighing, it must be used for both pre-test and post-test weighing. The same substitution weight must be used for both pre-test and post-test weighing. Correct the mass of the substitution weight for buoyancy if the density of the substitution weight is less than 2.0 g/



cm<sup>3</sup>. The following steps are an example of substitution weighing:

- (3) Select and weigh a substitution weight that meets the requirements for calibration weights found in § 1065.790. The substitution weight must also have the same density as the weight you use to span the microbalance, and be similar in mass to an unused sample medium (e.g., filter). A 47 mm PTFE membrane filter will typically have a mass in the range of 80 to 100 mg.
- (4) Record the stable balance reading, then remove the substitution weight.
- (5) Weigh an unused sample medium (e.g., a new filter), record the stable balance reading and record the balance environment's dewpoint, ambient temperature, and atmospheric pressure.

- (6) Reweigh the substitution weight and record the stable balance reading.
- (7) Calculate the arithmetic mean of the two substitution-weight readings that you recorded immediately before and after weighing the unused sample. Subtract that mean value from the unused sample reading, then add the true mass of the substitution weight as stated on the substitution-weight certificate. Record this result. This is the unused sample's tare weight without correcting for buoyancy.

**Subpart G—Calculations and Data Requirements**

■ 262. Section 1065.602 is amended by revising paragraphs (f)(1) introductory

text, (f)(2) introductory text, and (j) to read as follows:

**§ 1065.602 Statistics.**

- (f) \* \* \*
- (1) For an unpaired *t*-test, calculate the *t* statistic and its number of degrees of freedom, *v*, as follows:
  - (2) For a paired *t*-test, calculate the *t* statistic and its number of degrees of freedom, *v*, as follows, noting that the  $\epsilon_i$  are the errors (e.g., differences) between each pair of  $y_{refi}$  and  $y_i$ :
- (j) *Standard estimate of error.* Calculate a standard estimate of error, *SEE*, as follows:

$$SEE_y = \sqrt{\frac{\sum_{i=1}^N [y_i - a_{0y} - (a_{1y} \cdot y_{refi})]^2}{N - 2}}$$

Eq. 1065.602-11

Eq. 1065.602-11  
Example:

$N = 6000$   
 $y_i = 2045.8$   
 $a_{0y} = -16.8083$   
 $a_{1y} = 1.0110$   
 $y_{ref1} = 2045.0$

$$SEE_y = \sqrt{\frac{[2045.8 - (-16.8083) - (1.0110 \cdot 2045.0)]^2 + \dots + [y_{6000} - (-16.8083) - (1.0110 \cdot y_{ref6000})]^2}{6000 - 2}}$$

$SEE_y = 5.348$

■ 263. Section 1065.610 is amended by revising paragraphs (a)(1)(ii), (a)(1)(iii), (a)(1)(vi), (a)(2), (b), and (c)(1) and (2) to read as follows:

**§ 1065.610 Duty-cycle generation.**

- (a) \* \* \*
- (1) \* \* \*
- (ii) Determine the lowest and highest engine speeds corresponding to 98% of  $P_{max}$ , using linear interpolation, and no extrapolation, as appropriate.
- (iii) Determine the engine speed corresponding to maximum power,  $f_{nPmax}$ , by calculating the average of the two speed values from paragraph

(a)(1)(ii) of this section. If there is only one speed where power is equal to 98% of  $P_{max}$ , take  $f_{nPmax}$  as the speed at which  $P_{max}$  occurs.

(vi) Determine the lowest and highest engine speeds corresponding to the value calculated in paragraph (a)(1)(v) of this section, using linear interpolation as appropriate. Calculate  $f_{ntest}$  as the average of these two speed values. If there is only one speed corresponding to the value calculated in paragraph (a)(1)(v) of this section, take  $f_{ntest}$  as the speed where the maximum of the sum of the squares occurs.

(2) For engines with a high-speed governor that will be subject to a reference duty cycle that specifies normalized speeds greater than 100%, calculate an alternate maximum test speed,  $f_{ntest,alt}$ , as specified in this paragraph (a)(2). If  $f_{ntest,alt}$  is less than the measured maximum test speed,  $f_{ntest}$ , determined in paragraph (a)(1) of this section, replace  $f_{ntest}$  with  $f_{ntest,alt}$ . In this case,  $f_{ntest,alt}$  becomes the "maximum test speed" for that engine. Note that § 1065.510 allows you to apply an optional declared maximum test speed to the final measured maximum test speed determined as an outcome of the comparison between  $f_{ntest}$ , and  $f_{ntest,alt}$  in this paragraph (a)(2). Determine  $f_{ntest,alt}$  as follows:

$$f_{ntest,alt} = \frac{f_{nhi,idle} - f_{nidle}}{\%speed_{max}} + f_{nidle}$$

Eq. 1065.610-2

Where:

$f_{ntest,alt}$  = alternate maximum test speed  
 $f_{nhi,idle}$  = warm high-idle speed

$f_{nidle}$  = warm idle speed  
 $\% speed_{max}$  = maximum normalized speed from duty cycle

*Example:*  
 $f_{nhi,idle}$  = 2200 r/min  
 $f_{nidle}$  = 800 r/min

$$f_{ntest,alt} = \frac{2200 - 800}{1.05} + 800$$

$f_{ntest,alt} = 2133$  r/min  
 \* \* \* \* \*

(b) *Maximum test torque,  $T_{test}$ .* For constant-speed engines, determine the measured  $T_{test}$  from the torque and power-versus-speed maps, generated according to § 1065.510, as follows:

(1) For constant speed engines mapped using the methods in § 1065.510(d)(5)(i) or (ii), determine  $T_{test}$  as follows:

(i) Determine maximum power,  $P_{max}$ , from the engine map generated according to § 1065.510 and calculate the value for power equal to 98% of  $P_{max}$ .

(ii) Determine the lowest and highest engine speeds corresponding to 98% of  $P_{max}$ , using linear interpolation, and no extrapolation, as appropriate.

(iii) Determine the engine speed corresponding to maximum power,  $f_{nPmax}$ , by calculating the average of the two speed values from paragraph (a)(1)(ii) of this section. If there is only

one speed where power is equal to 98% of  $P_{max}$ , take  $f_{nPmax}$  as the speed at which  $P_{max}$  occurs.

(iv) Transform the map into a normalized power-versus-speed map by dividing power terms by  $P_{max}$  and dividing speed terms by  $f_{nPmax}$ . Use Eq. 1065.610-1 to calculate a quantity representing the sum of squares from the normalized map.

(v) Determine the maximum value for the sum of the squares from the map and multiply that value by 0.98.

(vi) Determine the lowest and highest engine speeds corresponding to the value calculated in paragraph (a)(1)(v) of this section, using linear interpolation as appropriate. Calculate  $f_{ntest}$  as the average of these two speed values. If there is only one speed corresponding to the value calculated in paragraph (a)(1)(v) of this section, take  $f_{ntest}$  as the speed where the maximum of the sum of the squares occurs.

(vii) The measured  $T_{test}$  is the mapped torque at  $f_{ntest}$ .

(2) For constant-speed engines using the two-point mapping method in § 1065.510(d)(5)(iii), you may follow paragraph (a)(1) of this section to determine the measured  $T_{test}$ , or you may use the measured torque of the second point as the measured  $T_{test}$  directly.

(3) Transform normalized torques to reference torques according to paragraph (d) of this section by using the measured maximum test torque determined according to paragraph (b)(1) of this section—or use your declared maximum test torque, as allowed in § 1065.510.

(c) \* \* \*

(1) *% speed.* If your normalized duty cycle specifies % speed values, use your warm idle speed and your maximum test speed to transform the duty cycle, as follows:

$$f_{nref} = \% speed \cdot (f_{ntest} - f_{nidle}) + f_{nidle}$$

Eq. 1065.610-3

*Example:*

$\% speed = 85\% = 0.85$   
 $f_{ntest} = 2364$  r/min  
 $f_{nidle} = 650$  r/min  
 $f_{nref} = 0.85 \cdot (2364 - 650) + 650$   
 $f_{nref} = 2107$  r/min

(2) *A, B, and C speeds.* If your normalized duty cycle specifies speeds as A, B, or C values, use your power-versus-speed curve to determine the

lowest speed below maximum power at which 50% of maximum power occurs. Denote this value as  $n_{lo}$ . Take  $n_{lo}$  to be warm idle speed if all power points at speeds below the maximum power speed are higher than 50% of maximum power. Also determine the highest speed above maximum power at which 70% of maximum power occurs. Denote

this value as  $n_{hi}$ . If all power points at speeds above the maximum power speed are higher than 70% of maximum power, take  $n_{hi}$  to be the declared maximum safe engine speed or the declared maximum representative engine speed, whichever is lower. Use  $n_{hi}$  and  $n_{lo}$  to calculate reference values for A, B, or C speeds as follows:

$$f_{nrefA} = 0.25 \cdot (n_{hi} - n_{lo}) + n_{lo}$$

Eq. 1065.610-4

$$f_{nrefB} = 0.50 \cdot (n_{hi} - n_{lo}) + n_{lo}$$

Eq. 1065.610-5

$$f_{\text{refC}} = 0.75 \cdot (n_{\text{hi}} - n_{\text{lo}}) + n_{\text{lo}}$$

Eq. 1065.610-6

**Example:**

$$\begin{aligned} n_{\text{lo}} &= 1005 \text{ r/min} \\ n_{\text{hi}} &= 2385 \text{ r/min} \\ f_{\text{refA}} &= 0.25 \cdot (2385 - 1005) + 1005 \\ f_{\text{refB}} &= 0.50 \cdot (2385 - 1005) + 1005 \\ f_{\text{refC}} &= 0.75 \cdot (2385 - 1005) + 1005 \\ f_{\text{refA}} &= 1350 \text{ r/min} \\ f_{\text{refB}} &= 1695 \text{ r/min} \\ f_{\text{refC}} &= 2040 \text{ r/min} \\ * & \quad * \quad * \quad * \quad * \end{aligned}$$

■ 264. Section 1065.640 is amended by revising paragraphs (a), (b), (c), (d), and (e)(3) to read as follows:

**§ 1065.640 Flow meter calibration calculations.**

\* \* \* \* \*

(a) *Reference meter conversions.* The calibration equations in this section use molar flow rate,  $\dot{n}_{\text{ref}}$ , as a reference quantity. If your reference meter outputs a flow rate in a different quantity, such

as standard volume rate,  $\dot{V}_{\text{stdref}}$ , actual volume rate,  $\dot{V}_{\text{actref}}$ , or mass rate,  $\dot{m}_{\text{ref}}$ , convert your reference meter output to a molar flow rate using the following equations, noting that while values for volume rate, mass rate, pressure, temperature, and molar mass may change during an emission test, you should ensure that they are as constant as practical for each individual set point during a flow meter calibration:

$$\dot{n}_{\text{ref}} = \frac{\dot{V}_{\text{stdref}} \cdot p_{\text{std}}}{T_{\text{std}} \cdot R} = \frac{\dot{V}_{\text{actref}} \cdot p_{\text{act}}}{T_{\text{act}} \cdot R} = \frac{\dot{m}_{\text{ref}}}{M_{\text{mix}}}$$

Eq. 1065.640-1

**Where:**

$\dot{n}_{\text{ref}}$  = reference molar flow rate.  
 $\dot{V}_{\text{stdref}}$  = reference volume flow rate, corrected to a standard pressure and a standard temperature.  
 $\dot{V}_{\text{actref}}$  = reference volume flow rate at the actual pressure and temperature of the flow rate.

$\dot{m}_{\text{ref}}$  = reference mass flow.  
 $p_{\text{std}}$  = standard pressure.  
 $p_{\text{act}}$  = actual pressure of the flow rate.  
 $T_{\text{std}}$  = standard temperature.  
 $T_{\text{act}}$  = actual temperature of the flow rate.  
 $R$  = molar gas constant.  
 $M_{\text{mix}}$  = molar mass of the flow rate.  
*Example 1:*

$\dot{V}_{\text{stdref}} = 1000.00 \text{ ft}^3/\text{min} = 0.471948 \text{ m}^3/\text{s}$   
 $p_{\text{std}} = 29.9213 \text{ in Hg @32 }^\circ\text{F} = 101.325 \text{ kPa} = 101325 \text{ Pa} = 101325 \text{ kg}/(\text{m}\cdot\text{s}^2)$   
 $T_{\text{std}} = 68.0 \text{ }^\circ\text{F} = 293.15 \text{ K}$   
 $R = 8.314472 \text{ J}/(\text{mol}\cdot\text{K}) = 8.314472 \text{ (m}^2\cdot\text{kg)}/(\text{s}^2\cdot\text{mol}\cdot\text{K})$

$$\dot{n}_{\text{ref}} = \frac{0.471948 \cdot 101325}{293.15 \cdot 8.314472}$$

$$\dot{n}_{\text{ref}} = 19.619 \text{ mol/s}$$

**Example 2:**

$$\begin{aligned} \dot{m}_{\text{ref}} &= 17.2683 \text{ kg/min} = 287.805 \text{ g/s} \\ M_{\text{mix}} &= 28.7805 \text{ g/mol} \end{aligned}$$

$$\dot{n}_{\text{ref}} = \frac{287.805}{28.7805}$$

$$\dot{n}_{\text{ref}} = 10.0000 \text{ mol/s}$$

(b) *PDP calibration calculations.* Perform the following steps to calibrate a PDP flow meter:

(1) Calculate PDP volume pumped per revolution,  $V_{\text{rev}}$ , for each restrictor position from the mean values determined in § 1065.340 as follows:

$$V_{\text{rev}} = \frac{\bar{\dot{n}}_{\text{ref}} \cdot R \cdot \bar{T}_{\text{in}}}{\bar{P}_{\text{in}} \cdot \bar{f}_{\text{nPDP}}}$$

Eq. 1065.640-2

**Where:**

$\dot{n}_{\text{ref}}$  = mean reference molar flow rate.  
 $R$  = molar gas constant.  
 $\bar{T}_{\text{in}}$  = mean temperature at the PDP inlet.

$\bar{P}_{\text{in}}$  = mean static absolute pressure at the PDP inlet.  
 $\bar{f}_{\text{nPDP}}$  = mean PDP speed.  
*Example:*  
 $\dot{n}_{\text{ref}} = 25.096 \text{ mol/s}$

$R = 8.314472 \text{ J}/(\text{mol}\cdot\text{K}) = 8.314472 \text{ (m}^2\cdot\text{kg)}/(\text{s}^2\cdot\text{mol}\cdot\text{K})$   
 $\bar{T}_{\text{in}} = 299.5 \text{ K}$   
 $\bar{P}_{\text{in}} = 98.290 \text{ kPa} = 98290 \text{ Pa} = 98290 \text{ kg}/(\text{m}\cdot\text{s}^2)$   
 $\bar{f}_{\text{nPDP}} = 1205.1 \text{ r/min} = 20.085 \text{ r/s}$

$$V_{rev} = \frac{25.096 \cdot 8.314472 \cdot 299.5}{98290 \cdot 20.085}$$

$V_{rev} = 0.03166 \text{ m}^3/\text{r}$

(2) Calculate a PDP slip correction factor,  $K_s$ , for each restrictor position

from the mean values determined in § 1065.340 as follows:

$$K_s = \frac{1}{\bar{f}_{nPDP}} \cdot \sqrt{\frac{\bar{P}_{out} - \bar{P}_{in}}{\bar{P}_{out}}}$$

Eq. 1065.640-3

Where:

$\bar{f}_{nPDP}$  = mean PDP speed.

$\bar{P}_{out}$  = mean static absolute pressure at the PDP outlet.

$\bar{P}_{in}$  = mean static absolute pressure at the PDP inlet.

$\bar{P}_{out} = 100.103 \text{ kPa}$

$\bar{P}_{in} = 98.290 \text{ kPa}$

Example:

$\bar{f}_{nPDP} = 1205.1 \text{ r/min} = 20.085 \text{ r/s}$

$$K_s = \frac{1}{20.085} \cdot \sqrt{\frac{100.103 - 98.290}{100.103}}$$

$K_s = 0.006700 \text{ s/r}$

(3) Perform a least-squares regression of  $V_{rev}$ , versus  $K_s$ , by calculating slope,

$a_1$ , and intercept,  $a_0$ , as described in § 1065.602.

(4) Repeat the procedure in paragraphs (b)(1) through (3) of this

section for every speed that you run your PDP.

(5) The following table illustrates a range of typical values for different PDP speeds:

TABLE 1 OF § 1065.640—EXAMPLE OF PDP CALIBRATION DATA

$\bar{f}_{nPDP}$ (revolution/s)	$a_1$ (m <sup>3</sup> /s)	$a_0$ (m <sup>3</sup> /revolution)
12.6 .....	0.841	0.056
16.5 .....	0.831	-0.013
20.9 .....	0.809	0.028
23.4 .....	0.788	-0.061

(6) For each speed at which you operate the PDP, use the appropriate regression equation from this paragraph (b) to calculate flow rate during emission testing as described in § 1065.642.

(c) *Venturi governing equations and permissible assumptions.* This section describes the governing equations and permissible assumptions for calibrating a venturi and calculating flow using a venturi. Because a subsonic venturi (SSV) and a critical-flow venturi (CFV) both operate similarly, their governing equations are nearly the same, except

for the equation describing their pressure ratio,  $r$  (i.e.,  $r_{SSV}$  versus  $r_{CFV}$ ). These governing equations assume one-dimensional isentropic inviscid flow of an ideal gas. Paragraph (c)(5) of this section describes other assumptions that may apply. If good engineering judgment dictates that you account for gas compressibility, you may either use an appropriate equation of state to determine values of  $Z$  as a function of measured pressure and temperature, or you may develop your own calibration equations based on good engineering judgment. Note that the equation for the

flow coefficient,  $C_f$ , is based on the ideal gas assumption that the isentropic exponent,  $\gamma$ , is equal to the ratio of specific heats,  $C_p/C_v$ . If good engineering judgment dictates using a real gas isentropic exponent, you may either use an appropriate equation of state to determine values of  $\gamma$  as a function of measured pressures and temperatures, or you may develop your own calibration equations based on good engineering judgment.

(1) Calculate molar flow rate,  $\dot{n}$ , as follows:

$$\dot{n} = C_d \cdot C_f \cdot \frac{A_t \cdot P_{in}}{\sqrt{Z \cdot M_{mix} \cdot R \cdot T_{in}}}$$

Eq. 1065.640-4

Where:

$C_d$  = discharge coefficient, as determined in paragraph (c)(2) of this section.  
 $C_f$  = flow coefficient, as determined in paragraph (c)(3) of this section.

$A_t$  = venturi throat cross-sectional area.  
 $p_{in}$  = venturi inlet absolute static pressure.  
 $Z$  = compressibility factor.  
 $M_{mix}$  = molar mass of gas mixture.  
 $R$  = molar gas constant.

$T_{in}$  = venturi inlet absolute temperature.

(2) Using the data collected in § 1065.340, calculate  $C_d$  for each flow rate using the following equation:

$$C_d = \dot{n}_{ref} \cdot \frac{\sqrt{Z \cdot M_{mix} \cdot R \cdot T_{in}}}{C_f \cdot A_t \cdot p_{in}}$$

Eq. 1065.640-5

Where:

$\dot{n}_{ref}$  = a reference molar flow rate.

(3) Determine  $C_f$  using one of the following methods:

(i) For CFV flow meters only, determine  $C_{fCFV}$  from the following table based on your values for  $\beta$  and  $\gamma$ , using linear interpolation to find intermediate values:

TABLE 2 OF § 1065.640— $C_{fCFV}$  VERSUS  $\beta$  AND  $\gamma$  FOR CFV FLOW METERS

$C_{fCFV}$		
$\beta$	$\gamma_{exh} = 385$	$\gamma_{dexh} = \gamma_{air} = 399$
0.000	0.6822	0.6846

TABLE 2 OF § 1065.640— $C_{fCFV}$  VERSUS  $\beta$  AND  $\gamma$  FOR CFV FLOW METERS—Continued

$C_{fCFV}$		
$\beta$	$\gamma_{exh} = 385$	$\gamma_{dexh} = \gamma_{air} = 399$
0.400	0.6857	0.6881
0.500	0.6910	0.6934
0.550	0.6953	0.6977
0.600	0.7011	0.7036
0.625	0.7047	0.7072
0.650	0.7089	0.7114
0.675	0.7137	0.7163
0.700	0.7193	0.7219
0.720	0.7245	0.7271
0.740	0.7303	0.7329
0.760	0.7368	0.7395
0.770	0.7404	0.7431

TABLE 2 OF § 1065.640— $C_{fCFV}$  VERSUS  $\beta$  AND  $\gamma$  FOR CFV FLOW METERS—Continued

$C_{fCFV}$		
$\beta$	$\gamma_{exh} = 385$	$\gamma_{dexh} = \gamma_{air} = 399$
0.780	0.7442	0.7470
0.790	0.7483	0.7511
0.800	0.7527	0.7555
0.810	0.7573	0.7602
0.820	0.7624	0.7652
0.830	0.7677	0.7707
0.840	0.7735	0.7765
0.850	0.7798	0.7828

(ii) For any CFV or SSV flow meter, you may use the following equation to calculate  $C_f$  for each flow rate:

$$C_f = \left[ \frac{2 \cdot \gamma \cdot \left( r^{\frac{\gamma-1}{\gamma}} - 1 \right)}{(\gamma - 1) \cdot \left( \beta^4 - r^{\frac{2}{\gamma}} \right)} \right]^{\frac{1}{2}}$$

Eq. 1065.640-6

Where:

$\gamma$  = isentropic exponent. For an ideal gas, this is the ratio of specific heats of the gas mixture,  $C_p/C_v$ .

$r$  = pressure ratio, as determined in paragraph (c)(4) of this section.

$\beta$  = ratio of venturi throat to inlet diameters.

(4) Calculate  $r$  as follows:

(i) For SSV systems only, calculate  $r_{SSV}$  using the following equation:

$$r_{SSV} = 1 - \frac{\Delta p_{SSV}}{p_{in}}$$

Eq. 1065.640-7

Where:

$\Delta p_{SSV}$  = Differential static pressure; venturi inlet minus venturi throat.

(ii) For CFV systems only, calculate  $r_{CFV}$  iteratively using the following equation:

$$r_{CFV}^{\frac{1-\gamma}{\gamma}} + \left(\frac{\gamma-1}{2}\right) \cdot \beta^4 \cdot r_{CFV}^{\frac{2}{\gamma}} = \frac{\gamma+1}{2}$$

Eq. 1065.640-8

(5) You may apply any of the following simplifying assumptions or develop other values as appropriate for your test configuration, consistent with good engineering judgment:

(i) For raw exhaust, diluted exhaust, and dilution air, you may assume that

the gas mixture behaves as an ideal gas:  $Z = 1$ .

(ii) For raw exhaust, you may assume  $\gamma = 1.385$ .

(iii) For diluted exhaust and dilution air, you may assume  $\gamma = 1.399$ .

(iv) For diluted exhaust and dilution air, you may assume the molar mass of the mixture,  $M_{mix}$ , is a function only of the amount of water in the dilution air or calibration air, as follows:

$$M_{mix} = M_{air} \cdot (1 - x_{H2O}) + M_{H2O} \cdot x_{H2O}$$

Eq. 1065.640-9

Where:

$M_{air}$  = molar mass of dry air.

$x_{H2O}$  = amount of H<sub>2</sub>O in the dilution air or calibration air, determined as described in § 1065.645.

$M_{H2O}$  = molar mass of water.

*Example:*

$M_{air} = 28.96559$  g/mol

$x_{H2O} = 0.0169$  mol/mol

$M_{H2O} = 18.01528$  g/mol

$$M_{mix} = 28.96559 \cdot (1 - 0.0169) + 18.01528 \cdot 0.0169$$

$$M_{mix} = 28.7805$$
 g/mol

(v) For diluted exhaust and dilution air, you may assume a constant molar mass of the mixture,  $M_{mix}$ , for all calibration and all testing as long as your assumed molar mass differs no more than ±1% from the estimated minimum and maximum molar mass during calibration and testing.

You may assume this, using good engineering judgment, if you sufficiently control the amount of water in calibration air and in dilution air or if you remove sufficient water from both calibration air and dilution air. The following table gives examples of permissible ranges of dilution air dewpoint versus calibration air dewpoint:

TABLE 3 OF § 1065.640—EXAMPLES OF DILUTION AIR AND CALIBRATION AIR DEWPOINTS AT WHICH YOU MAY ASSUME A CONSTANT  $M_{mix}$

If calibration $T_{dew}$ (°C) is . . .	assume the following constant $M_{mix}$ (g/mol) . . .	for the following ranges of $T_{dew}$ (°C) during emission tests <sup>a</sup>
dry	28.96559	dry to 18
0	28.89263	dry to 21
5	28.86148	dry to 22
10	28.81911	dry to 24
15	28.76224	dry to 26
20	28.68685	-8 to 28
25	28.58806	12 to 31
30	28.46005	23 to 34

<sup>a</sup> Range valid for all calibration and emission testing over the atmospheric pressure range (80.000 to 103.325) kPa.

(6) The following example illustrates the use of the governing equations to calculate  $C_d$  of an SSV flow meter at one reference flow meter value. Note that calculating  $C_d$  for a CFV flow meter would be similar, except that  $C_f$  would be determined from Table 2 of this section or calculated iteratively using

values of  $\beta$  and  $\gamma$  as described in paragraph (c)(2) of this section.

*Example:*

$$\dot{n}_{ref} = 57.625$$
 mol/s

$$Z = 1$$

$$M_{mix} = 28.7805$$
 g/mol = 0.0287805 kg/mol

$$R = 8.314472$$
 J/(mol · K) = 8.314472 (m<sup>2</sup> · kg)/(s<sup>2</sup> · mol · K)

$$T_{in} = 298.15$$
 K

$$A_t = 0.01824$$
 m<sup>2</sup>

$$p_{in} = 99.132$$
 kPa = 99132.0 Pa = 99132 kg/(m · s<sup>2</sup>)

$$\gamma = 1.399$$

$$\beta = 0.8$$

$$\Delta p = 2.312$$
 kPa

$$r_{SSV} = 1 - \frac{2.312}{99.132} = 0.977$$

$$C_f = \left[ \frac{2 \cdot 1.399 \cdot \left( 0.977^{\frac{1.399-1}{1.399}} - 1 \right)}{(1.399-1) \cdot \left( 0.8^4 - 0.977^{\frac{-2}{1.399}} \right)} \right]^{\frac{1}{2}}$$

$C_f = 0.274$

$$C_d = 57.625 \cdot \frac{\sqrt{1 \cdot 0.0287805 \cdot 8.314472 \cdot 298.15}}{0.274 \cdot 0.01824 \cdot 99132.0}$$

$C_d = 0.982$

(d) *SSV calibration.* Perform the following steps to calibrate an SSV flow meter:

(1) Calculate the Reynolds number,  $Re^\#$ , for each reference molar flow rate,

$\dot{n}_{ref}$ , using the throat diameter of the venturi,  $d_t$ . Because the dynamic viscosity,  $\mu$ , is needed to compute  $Re^\#$ , you may use your own fluid viscosity model to determine  $\mu$  for your calibration gas (usually air), using good

engineering judgment. Alternatively, you may use the Sutherland three-coefficient viscosity model to approximate  $\mu$ , as shown in the following sample calculation for  $Re^\#$ :

$$Re^\# = \frac{4 \cdot M_{mix} \cdot \dot{n}_{ref}}{\pi \cdot d_t \cdot \mu}$$

Eq. 1065.640-10

Where, using the Sutherland three-coefficient viscosity model:

$$\mu = \mu_0 \cdot \left( \frac{T_{in}}{T_0} \right)^{\frac{3}{2}} \cdot \left( \frac{T_0 + S}{T_{in} + S} \right)$$

Eq. 1065.640-11

Where:

$\mu_0$  = Sutherland reference viscosity.

$T_0$  = Sutherland reference temperature.

$S$  = Sutherland constant.

TABLE 4 OF § 1065.640—SUTHERLAND THREE-COEFFICIENT VISCOSITY MODEL PARAMETERS

Gas <sup>a</sup>	$\mu_0$	$T_0$	$S$	Temperature range within $\pm 2\%$ error <sup>b</sup>	Pressure limit <sup>b</sup>
	kg/(m·s)	K	K	K	kPa
Air .....	$1.716 \cdot 10^{-5}$	273	111	170 to 1900 .....	$\leq 1800$
CO <sub>2</sub> .....	$1.370 \cdot 10^{-5}$	273	222	190 to 1700 .....	$\leq 3600$
H <sub>2</sub> .....	$1.12 \cdot 10^{-5}$	350	1064	360 to 1500 .....	$\leq 10000$
O <sub>2</sub> .....	$1.919 \cdot 10^{-5}$	273	139	190 to 2000 .....	$\leq 2500$
N <sub>2</sub> .....	$1.663 \cdot 10^{-5}$	273	107	100 to 1500 .....	$\leq 1600$

<sup>a</sup> Use tabulated parameters only for the pure gases, as listed. Do not combine parameters in calculations to calculate viscosities of gas mixtures.

<sup>b</sup> The model results are valid only for ambient conditions in the specified ranges.

Example:

$S = 111$  K

$\mu_0 = 1.716 \cdot 10^{-5}$  kg/(m·s)

$T_0 = 273$  K

$$\mu = 1.716 \cdot 10^{-5} \cdot \left( \frac{298.15}{273} \right)^{\frac{3}{2}} \cdot \left( \frac{273 + 111}{298.15 + 111} \right)$$

$\mu = 1.838 \cdot 10^{-5} \text{ kg/(m}\cdot\text{s)}$   
 $M_{\text{mix}} = 28.7805 \text{ g/mol}$

$\dot{n}_{\text{ref}} = 57.625 \text{ mol/s}$   
 $d_i = 152.4 \text{ mm} = 0.1524 \text{ m}$

$T_{\text{in}} = 298.15 \text{ K}$

$$Re^{\#} = \frac{4 \cdot 28.7805 \cdot 57.625}{3.14159 \cdot 0.1524 \cdot 1.838 \cdot 10^{-5}}$$

$Re^{\#} = 7.538 \cdot 10^8$

(2) Create an equation for  $C_d$  as a function of  $Re^{\#}$ , using paired values of

the two quantities. The equation may involve any mathematical expression, including a polynomial or a power series. The following equation is an

example of a commonly used mathematical expression for relating  $C_d$  and  $Re^{\#}$ :

$$C_d = a_0 - a_1 \cdot \sqrt{\frac{10^6}{Re^{\#}}}$$

Eq. 1065.640-12

(3) Perform a least-squares regression analysis to determine the best-fit coefficients for the equation and calculate *SEE* as described in § 1065.602.

(4) If the equation meets the criterion of  $SEE \leq 0.5\% \cdot C_{d\text{max}}$ , you may use the equation for the corresponding range of  $Re^{\#}$ , as described in § 1065.642.

(5) If the equation does not meet the specified statistical criterion, you may use good engineering judgment to omit calibration data points; however you must use at least seven calibration data

points to demonstrate that you meet the criterion. For example, this may involve narrowing the range of flow rates for a better curve fit.

(6) Take corrective action if the equation does not meet the specified statistical criterion even after omitting calibration data points. For example, select another mathematical expression for the  $C_d$  versus  $Re^{\#}$  equation, check for leaks, or repeat the calibration process. If you must repeat the calibration process, we recommend applying tighter tolerances to measurements and

allowing more time for flows to stabilize.

(7) Once you have an equation that meets the specified statistical criterion, you may use the equation only for the corresponding range of  $Re^{\#}$ .

(e) \* \* \*

(3) If the standard deviation of all the  $C_d$  values is less than or equal to 0.3% of the mean  $C_d$ , use the mean  $C_d$  in Eq. 1065.642-4, and use the CFV only up to the highest venturi pressure ratio,  $r$ , measured during calibration using the following equation:

$$r = 1 - \frac{\Delta p_{\text{CFV}}}{P_{\text{in}}}$$

Eq. 1065.640-13

Where:

$\Delta p_{\text{CFV}}$  = Differential static pressure; venturi inlet minus venturi outlet.

\* \* \* \* \*

■ 265. Section 1065.642 is revised to read as follows:

**§ 1065.642 PDP, SSV, and CFV molar flow rate calculations.**

This section describes the equations for calculating molar flow rates from various flow meters. After you calibrate a flow meter according to § 1065.640, use the calculations described in this section to calculate flow during an emission test.

(a) *PDP molar flow rate.* (1) Based on the speed at which you operate the PDP for a test interval, select the corresponding slope,  $a_1$ , and intercept,  $a_0$ , as calculated in § 1065.640, to calculate PDP molar flow rate., as follows:

$$\dot{n} = f_{\text{nPDP}} \cdot \frac{V_{\text{rev}} \cdot P_{\text{in}}}{R \cdot T_{\text{in}}}$$

Eq. 1065.642-1



Where:  
 $f_{nPDP}$  = pump speed.

$V_{rev}$  = PDP volume pumped per revolution,  
 as determined in paragraph (a)(2) of this  
 section.  
 $p_{in}$  = static absolute pressure at the PDP inlet.

$R$  = molar gas constant.  
 $T_{in}$  = absolute temperature at the PDP inlet.  
 (2) Calculate  $V_{rev}$  using the following  
 equation:

$$V_{rev} = \frac{a_1}{f_{nPDP}} \cdot \sqrt{\frac{p_{out} - p_{in}}{p_{out}}} + a_0$$

Eq. 1065.642-2

$p_{out}$  = static absolute pressure at the PDP  
 outlet.

Example:  
 $a_1 = 0.8405$  (m<sup>3</sup>/s)

$f_{nPDP} = 12.58$  r/s  
 $p_{out} = 99.950$  kPa  
 $p_{in} = 98.575$  kPa = 98575 Pa = 98575 kg/  
 (m·s<sup>2</sup>)

$a_0 = 0.056$  (m<sup>3</sup>/r)  
 $R = 8.314472$  J/(mol·K) = 8.314472 (m<sup>2</sup>·kg)/  
 (s<sup>2</sup>·mol·K)  
 $T_{in} = 323.5$  K

$$V_{rev} = \frac{0.8405}{12.58} \cdot \sqrt{\frac{99.950 - 98.575}{99.950}} + 0.056$$

$$\dot{n} = 12.58 \cdot \frac{98575 \cdot 0.06383}{8.314472 \cdot 323.5}$$

$\dot{n} = 29.428$  mol/s

(b) *SSV molar flow rate.* Calculate  
 SSV molar flow rate,  $\dot{n}$ , as follows:

$$\dot{n} = C_d \cdot C_f \cdot \frac{A_t \cdot p_{in}}{\sqrt{Z \cdot M_{mix} \cdot R \cdot T_{in}}}$$

Eq. 1065.642-3

Where:

$C_d$  = discharge coefficient, as determined  
 based on the  $C_d$  versus  $Re^{\#}$  equation in  
 § 1065.640(d)(2).

$C_f$  = flow coefficient, as determined in  
 § 1065.640(c)(2)(ii).

$A_t$  = venturi throat cross-sectional area.

$p_{in}$  = static absolute pressure at the venturi  
 inlet.

$Z$  = compressibility factor.

$M_{mix}$  = molar mass of gas mixture.

$R$  = molar gas constant.

$T_{in}$  = absolute temperature at the venturi  
 inlet.

Example:

$A_t = 0.01824$  m<sup>2</sup>

$p_{in} = 99.132$  kPa = 99132 Pa = 99132 kg/  
 (m·s<sup>2</sup>)

$Z = 1$

$M_{mix} = 28.7805$  g/mol = 0.0287805 kg/mol

$R = 8.314472$  J/(mol·K) = 8.314472 (m<sup>2</sup>·kg)/  
 (s<sup>2</sup>·mol·K)

$T_{in} = 298.15$  K

$Re^{\#} = 7.232 \cdot 10^5$

$\gamma = 1.399$

$\beta = 0.8$

$\Delta p = 2.312$  kPa

Using Eq. 1065.640-7,  $r_{ssv} = 0.997$

Using Eq. 1065.640-6,  $C_f = 0.274$

Using Eq. 1065.640-5,  $C_d = 0.990$

$$\dot{n} = 0.990 \cdot 0.274 \cdot \frac{0.01824 \cdot 99132}{\sqrt{1 \cdot 0.0287805 \cdot 8.314472 \cdot 298.15}}$$

$\dot{n} = 58.173$  mol/s

(c) *CFV molar flow rate.* If you use  
 multiple venturis and you calibrate each  
 venturi independently to determine a  
 separate discharge coefficient,  $C_d$  (or  
 calibration coefficient,  $K_v$ ), for each  
 venturi, calculate the individual molar  
 flow rates through each venturi and sum

all their flow rates to determine CFV  
 flow rate,  $\dot{n}$ . If you use multiple venturis  
 and you calibrated venturis in  
 combination, calculate  $\dot{n}$  using the sum  
 of the active venturi throat areas as  $A_t$ ,  
 the square root of the sum of the squares  
 of the active venturi throat diameters as  
 $d_t$ , and the ratio of the venturi throat to  
 inlet diameters as the ratio of the square

root of the sum of the active venturi  
 throat diameters ( $d_t$ ) to the diameter of  
 the common entrance to all the venturis  
 ( $D$ ).

(1) To calculate  $\dot{n}$  through one venturi  
 or one combination of venturis, use its  
 respective mean  $C_d$  and other constants  
 you determined according to § 1065.640  
 and calculate  $\dot{n}$  as follows:

$$\dot{n} = C_d \cdot C_f \cdot \frac{A_t \cdot p_{in}}{\sqrt{Z \cdot M_{mix} \cdot R \cdot T_{in}}}$$

Eq. 1065.642-4

*Example:*  
 $C_d = 0.985$   
 $C_f = 0.7219$   
 $A_t = 0.00456 \text{ m}^2$

$p_{in} = 98.836 \text{ kPa} = 98836 \text{ Pa} = 98836 \text{ kg}/(\text{m} \cdot \text{s}^2)$   
 $Z = 1$   
 $M_{mix} = 28.7805 \text{ g/mol} = 0.0287805 \text{ kg/mol}$

$R = 8.314472 \text{ J}/(\text{mol} \cdot \text{K}) = 8.314472 \text{ (m}^2 \cdot \text{kg})/(\text{s}^2 \cdot \text{mol} \cdot \text{K})$   
 $T_{in} = 378.15 \text{ K}$

$$\dot{n} = 0.985 \cdot 0.7219 \cdot \frac{0.00456 \cdot 98836}{\sqrt{1 \cdot 0.0287805 \cdot 8.314472 \cdot 378.15}}$$

$\dot{n} = 33.690 \text{ mol/s}$

(2) To calculate the molar flow rate through one venturi or a combination of venturis, you may use its respective

mean,  $K_v$ , and other constants you determined according to § 1065.640 and calculate its molar flow rate  $\dot{n}$  during an emission test. Note that if you follow the permissible ranges of dilution air

dewpoint versus calibration air dewpoint in Table 3 of § 1065.640, you may set  $M_{mix-cal}$  and  $M_{mix}$  equal to 1. Calculate  $\dot{n}$  as follows:

$$\dot{n} = \frac{K_v \cdot p_{in}}{\sqrt{T_{in}}} \cdot \frac{p_{std}}{T_{std} \cdot R} \cdot \frac{\sqrt{M_{mix-cal}}}{\sqrt{M_{mix}}}$$

Eq. 1065.642-5

Where:

$$K_v = \frac{V_{stdref} \cdot \sqrt{T_{in-cal}}}{p_{in-cal}}$$

Eq. 1065.642-6

$V_{stdref}$  = volume flow rate of the standard at reference conditions of 293.15 K and 101.325 kPa.

$T_{in-cal}$  = venturi inlet temperature during calibration.

$p_{in-cal}$  = venturi inlet pressure during calibration.

$M_{mix-cal}$  = molar mass of gas mixture used during calibration.

$M_{mix}$  = molar mass of gas mixture during the emission test calculated using Eq. 1065.640-9.

*Example:*  
 $V_{stdref} = 0.4895 \text{ m}^3$   
 $T_{in-cal} = 302.52 \text{ K}$   
 $p_{in-cal} = 99.654 \text{ kPa} = 99654 \text{ Pa} = 99654 \text{ kg}/(\text{m} \cdot \text{s}^2)$   
 $p_{in} = 98.836 \text{ kPa} = 98836 \text{ Pa} = 98836 \text{ kg}/(\text{m} \cdot \text{s}^2)$

$p_{std} = 101.325 \text{ kPa} = 101325 \text{ Pa} = 101325 \text{ kg}/(\text{m} \cdot \text{s}^2)$

$M_{mix-cal} = 28.9656 \text{ g/mol} = 0.0289656 \text{ kg/mol}$

$M_{mix} = 28.7805 \text{ g/mol} = 0.0287805 \text{ kg/mol}$

$T_{in} = 353.15 \text{ K}$

$T_{std} = 293.15 \text{ K}$

$R = 8.314472 \text{ J}/(\text{mol} \cdot \text{K}) = 8.314472 \text{ (m}^2 \cdot \text{kg})/(\text{s}^2 \cdot \text{mol} \cdot \text{K})$

$$K_v = \frac{0.4895 \cdot \sqrt{302.52}}{99654} = 0.000074954 \text{ m}^4 \cdot \text{s} \cdot \text{K}^{0.5} / \text{kg}$$

$$\dot{n} = \frac{0.000074954 \cdot 98936}{\sqrt{353.15}} \cdot \frac{101325}{293.15 \cdot 8.314472} \cdot \frac{\sqrt{0.0289656}}{\sqrt{0.0287805}}$$

$\dot{n} = 16.457 \text{ mol/s}$

■ 266. Section 1065.645 is amended by revising paragraphs (c) and (d) to read as follows:

**§ 1065.645 Amount of water in an ideal gas.**  
 \* \* \* \* \*

(c) *Relative humidity.* If you measure humidity as a relative humidity, *RH*, determine the amount of water in an ideal gas,  $x_{H_2O}$ , as follows:

$$x_{\text{H}_2\text{O}} = \frac{RH \cdot p_{\text{H}_2\text{O}}}{P_{\text{abs}}}$$

Eq. 1065.645-4

Where:

 $x_{\text{H}_2\text{O}}$  = amount of water in an ideal gas. $RH$  = relative humidity. $p_{\text{H}_2\text{O}}$  = water vapor pressure at 100% relative humidity at the location of your relative humidity measurement,  $T_{\text{sat}} = T_{\text{amb}}$ . $p_{\text{abs}}$  = wet static absolute pressure at the location of your relative humidity measurement.*Example:* $RH = 50.77\% = 0.5077$  $p_{\text{abs}} = 99.980 \text{ kPa}$  $T_{\text{sat}} = T_{\text{amb}} = 20 \text{ }^\circ\text{C}$ 

Using Eq. 1065.645-1,

 $p_{\text{H}_2\text{O}} = 2.3371 \text{ kPa}$  $x_{\text{H}_2\text{O}} = (0.5077 \cdot 2.3371)/99.980$  $x_{\text{H}_2\text{O}} = 0.011868 \text{ mol/mol}$ 

(d) *Dewpoint determination from relative humidity and dry bulb temperature.* This paragraph (d) describes how to calculate dewpoint temperature from relative humidity,  $RH$ . This is based on "ITS-90 Formulations for Vapor Pressure, Frostpoint

Temperature, Dewpoint Temperature, and Enhancement Factors in the Range -100 to +100 °C" (Hardy, B., The Proceedings of the Third International Symposium on Humidity & Moisture, Teddington, London, England, April 1998). Calculate  $p_{\text{H}_2\text{Osat}}$  as described in paragraph (a) of this section based on setting  $T_{\text{sat}}$  equal to  $T_{\text{amb}}$ . Calculate  $p_{\text{H}_2\text{Oscaled}}$  by multiplying  $p_{\text{H}_2\text{Osat}}$  by  $RH$ . Calculate the dewpoint,  $T_{\text{dew}}$ , from  $p_{\text{H}_2\text{O}}$  using the following equation:

$$T_{\text{dew}} = \frac{2.0798233 \cdot 10^2 - 2.0156028 \cdot 10^1 \cdot \ln(p_{\text{H}_2\text{O}}) + 4.6778925 \cdot 10^{-1} \cdot \ln(p_{\text{H}_2\text{O}})^2 - 9.2288067 \cdot 10^{-6} \cdot \ln(p_{\text{H}_2\text{O}})^3}{1 - 1.3319669 \cdot 10^{-1} \cdot \ln(p_{\text{H}_2\text{O}}) + 5.6577518 \cdot 10^{-3} \cdot \ln(p_{\text{H}_2\text{O}})^2 - 7.5172865 \cdot 10^{-5} \cdot \ln(p_{\text{H}_2\text{O}})^3}$$

Eq. 1065.645-5

Where:

$\ln(p_{\text{H}_2\text{O}})$  = the natural log of  $p_{\text{H}_2\text{Oscaled}}$ , which is the water vapor pressure scaled to the relative humidity at the location of the

relative humidity measurement,  $T_{\text{sat}} = T_{\text{amb}}$

*Example:*  
 $RH = 39.61\% = 0.3961$

 $T_{\text{sat}} = T_{\text{amb}} = 20.00 \text{ }^\circ\text{C} = 293.15\text{K}$ 

Using Eq. 1065.645-1,

 $p_{\text{H}_2\text{Osat}} = 2.3371 \text{ kPa}$  $p_{\text{H}_2\text{Oscaled}} = (0.3961 \cdot 2.3371) = 0.925717 \text{ kPa}$   
 $= 925.717 \text{ Pa}$ 

$$T_{\text{dew}} = \frac{2.0798233 \cdot 10^2 - 2.0156028 \cdot 10^1 \cdot \ln(925.717) + 4.6778925 \cdot 10^{-1} \cdot \ln(925.717)^2 - 9.2288067 \cdot 10^{-6} \cdot \ln(925.717)^3}{1 - 1.3319669 \cdot 10^{-1} \cdot \ln(925.717) + 5.6577518 \cdot 10^{-3} \cdot \ln(925.717)^2 - 7.5172865 \cdot 10^{-5} \cdot \ln(925.717)^3}$$

■ 267. Section 1065.650 is amended by adding paragraph (c)(6) and revising paragraphs (e)(2), (f)(2), (f)(4), and (g)(2)(ii) to read as follows:

**§ 1065.650 Emission calculations.**

\* \* \* \* \*

(c) \* \* \*

(6) *Mass of NMNEHC.* If the test fuel has less than 0.010 mol/mol of ethane and you omit the NMNEHC calculations as described in § 1065.660(c)(1), take the corrected mass of NMNEHC to be 0.95 times the corrected mass of NMHC.

\* \* \* \* \*

(e) \* \* \*

(2) To calculate an engine's mean steady-state total power,  $\bar{P}$ , add the mean steady-state power from all the work paths described in § 1065.210 that cross the system boundary including electrical power, mechanical shaft

power, and fluid pumping power. For all work paths, except the engine's primary output shaft (crankshaft), the mean steady-state power over the test interval is the integration of the net work flow rate (power) out of the system boundary divided by the period of the test interval. When power flows into the system boundary, the power/work flow rate signal becomes negative; in this case, include these negative power/work rate values in the integration to calculate the mean power from that work path. Some work paths may result in a negative mean power. Include negative mean power values from any work path in the mean total power from the engine rather than setting these values to zero. The rest of this paragraph (e)(2) describes how to calculate the mean power from the engine's primary output shaft. Calculate  $\bar{P}$  using Eq.

1065.650-13, noting that  $\bar{P}$ ,  $\bar{f}_n$ , and  $\bar{T}$  refer to mean power, mean rotational shaft frequency, and mean torque from the primary output shaft. Account for the power of simulated accessories according to § 1065.110 (reducing the mean primary output shaft power or torque by the accessory power or torque). Set the power to zero during actual motoring operation (negative feedback torques), unless the engine was connected to one or more energy storage devices. Examples of such energy storage devices include hybrid powertrain batteries and hydraulic accumulators, like the ones illustrated in Figure 1 of § 1065.210. Set the power to zero for modes with a zero reference load (0 N·m reference torque or 0 kW reference power). Include power during idle modes with simulated minimum torque or power.

$$\bar{P} = \bar{f}_n \cdot \bar{T}$$

Eq. 1065.650-13

\* \* \* \* \*

(f) *Total work.* To calculate a value proportional to total work over a test interval, integrate a value that is proportional to power. Use information about the brake-specific fuel consumption of your engine,  $e_{fuel}$ , to convert a signal proportional to fuel flow rate to a signal proportional to

power. To determine a signal proportional to fuel flow rate, divide a signal that is proportional to the mass rate of carbon products by the fraction of carbon in your fuel,  $w_C$ . You may use a measured  $w_C$  or you may use default values for a given fuel as described in § 1065.655(e). Calculate the mass rate of carbon from the amount of carbon and water in the exhaust, which you

determine with a chemical balance of fuel, intake air, and exhaust as described in § 1065.655. In the chemical balance, you must use concentrations from the flow that generated the signal proportional to molar flow rate,  $\tilde{n}$ , in paragraph (e)(1) of this section. Calculate a value proportional to total work as follows:

$$W = \sum_{i=1}^N \tilde{P}_i \cdot \Delta t$$

Eq. 1065.650-15

Where:

$$\tilde{P}_i = \frac{\tilde{m}_{fueli}}{e_{fuel}}$$

Eq. 1065.650-16

\* \* \* \* \*

(4) *Example:* The following example shows how to calculate mass of emissions using proportional values:

$N = 3000$   
 $f_{record} = 5 \text{ Hz}$   
 $e_{fuel} = 285 \text{ g/(kW}\cdot\text{hr)}$   
 $w_{fuel} = 0.869 \text{ g/g}$   
 $M_C = 12.0107 \text{ g/mol}$   
 $\tilde{n}_1 = 3.922 \text{ mol/s} = 14119.2 \text{ mol/hr}$

$\chi_{Ccombdry1} = 91.634 \text{ mmol/mol} = 0.091634 \text{ mol/mol}$   
 $\chi_{H2Oexh1} = 27.21 \text{ mmol/mol} = 0.02721 \text{ mol/mol}$   
 Using Eq. 1065.650-5,  
 $\Delta t = 0.2 \text{ s}$

$$\tilde{W} = \frac{12.0107 \left( \frac{3.922 \cdot 0.091634}{1 + 0.02721} + \frac{\tilde{n}_2 \cdot \chi_{Ccombdry2}}{1 + \chi_{H2Oexh2}} + \dots + \frac{\tilde{n}_{3000} \cdot \chi_{Ccombdry3000}}{1 + \chi_{H2Oexh3000}} \right) \cdot 0.2}{285 \cdot 0.869}$$

$\tilde{W} = 5.09 \text{ (kW}\cdot\text{hr)}$

(g) \* \* \*

(2) \* \* \*  
 (ii) Use the following equation if you calculate brake-specific emissions over

test intervals based on the ratio of mass rate to power as described in paragraph (b)(2) of this section:

$$e_{composite} = \frac{\sum_{i=1}^N WF_i \cdot \bar{m}_i}{\sum_{i=1}^N WF_i \cdot \bar{P}_i}$$

Eq. 1065.650-19

Where:  
 $i$  = test interval number.

$N$  = number of test intervals.

$WF$  = weighting factor for the test interval as defined in the standard-setting part.

$\bar{m}$  = mean steady-state mass rate of emissions over the test interval as determined in paragraph (e) of this section.  
 $\bar{P}$  = mean steady-state power over the test interval as described in paragraph (e) of this section.

*Example:*  
 $N = 2$   
 $WF_1 = 0.85$   
 $WF_2 = 0.15$   
 $\bar{m}_1 = 2.25842 \text{ g/hr}$   
 $\bar{m}_2 = 0.063443 \text{ g/hr}$

$\bar{P}_1 = 4.5383 \text{ kW}$   
 $\bar{P}_2 = 0.0 \text{ kW}$

$$e_{\text{NO}_x, \text{composite}} = \frac{(0.85 \cdot 2.25842) + (0.15 \cdot 0.063443)}{(0.85 \cdot 4.5383) + (0.15 \cdot 0.0)}$$

$e_{\text{NO}_x, \text{composite}} = 0.5001 \text{ g/kW-hr}$   
 \* \* \* \* \*

■ 268. Section 1065.655 is amended as follows:

- a. By revising paragraphs (a), (b), (c) introductory text, (c)(3), and (d).
- b. By redesignating paragraphs (e) and (f) as paragraphs (f) and (g), respectively.
- c. By adding a new paragraph (e).
- d. By revising the newly redesignated paragraph (f)(3).

The revisions and additions read as follows:

**§ 1065.655 Chemical balances of fuel, intake air, and exhaust.**

(a) *General.* Chemical balances of fuel, intake air, and exhaust may be used to calculate flows, the amount of water in their flows, and the wet concentration of constituents in their flows. With one flow rate of either fuel, intake air, or exhaust, you may use chemical balances to determine the flows of the other two. For example, you may use chemical balances along with either intake air or fuel flow to determine raw exhaust flow. Note that chemical balance calculations require measured values for the flow rate of diesel exhaust fluid, if applicable.

(b) *Procedures that require chemical balances.* We require chemical balances when you determine the following:

(1) A value proportional to total work,  $\bar{W}$ , when you choose to determine brake-specific emissions as described in § 1065.650(f).

(2) Raw exhaust molar flow rate either from measured intake air molar flow rate or from fuel mass flow rate as described in paragraph (f) of this section.

(3) Raw exhaust molar flow rate from measured intake air molar flow rate and dilute exhaust molar flow rate, as described in paragraph (g) of this section.

(4) The amount of water in a raw or diluted exhaust flow,  $\chi_{\text{H}_2\text{Oexh}}$ , when you do not measure the amount of water to correct for the amount of water removed by a sampling system. Correct for removed water according to § 1065.659.

(5) The calculated total dilution air flow when you do not measure dilution

air flow to correct for background emissions as described in § 1065.667(c) and (d).

(c) *Chemical balance procedure.* The calculations for a chemical balance involve a system of equations that require iteration. We recommend using a computer to solve this system of equations. You must guess the initial values of up to three quantities: The amount of water in the measured flow,  $\chi_{\text{H}_2\text{Oexh}}$ , fraction of dilution air in diluted exhaust,  $\chi_{\text{dil/exh}}$ , and the amount of products on a  $C_1$  basis per dry mole of dry measured flow,  $\chi_{\text{Ccombdry}}$ . You may use time-weighted mean values of combustion air humidity and dilution air humidity in the chemical balance; as long as your combustion air and dilution air humidities remain within tolerances of  $\pm 0.0025 \text{ mol/mol}$  of their respective mean values over the test interval. For each emission concentration,  $\chi$ , and amount of water,  $\chi_{\text{H}_2\text{Oexh}}$ , you must determine their completely dry concentrations,  $\chi_{\text{dry}}$  and  $\chi_{\text{H}_2\text{Oexhdry}}$ . You must also use your fuel mixture's atomic hydrogen-to-carbon ratio,  $\alpha$ , oxygen-to-carbon ratio,  $\beta$ , sulfur-to-carbon ratio,  $\gamma$ , and nitrogen-to-carbon ratio,  $\delta$ , you may optionally account for diesel exhaust fluid (or other fluids injected into the exhaust), if applicable. You may calculate  $\alpha$ ,  $\beta$ ,  $\gamma$ , and  $\delta$  based on measured fuel and diesel exhaust fluid composition or you may use default values as described in paragraph (e) of this section. Use the following steps to complete a chemical balance:

\* \* \* \* \*  
 (3) Use the following symbols and subscripts in the equations for performing the chemical balance calculations in this paragraph (c):

$\chi_{\text{dil/exh}}$  = amount of dilution gas or excess air per mole of exhaust.

$\chi_{\text{H}_2\text{Oexh}}$  = amount of  $\text{H}_2\text{O}$  in exhaust per mole of exhaust.

$\chi_{\text{Ccombdry}}$  = amount of carbon from fuel in the exhaust per mole of dry exhaust.

$\chi_{\text{H}_2\text{dry}}$  = amount of  $\text{H}_2$  in exhaust per amount of dry exhaust.

$K_{\text{H}_2\text{Ogas}}$  = water-gas reaction equilibrium coefficient. You may use 3.5 or calculate your own value using good engineering judgment.

$\chi_{\text{H}_2\text{Oexhdry}}$  = amount of  $\text{H}_2\text{O}$  in exhaust per dry mole of dry exhaust.

$\chi_{\text{prod/intdry}}$  = amount of dry stoichiometric products per dry mole of intake air.

$\chi_{\text{dil/exhdry}}$  = amount of dilution gas and/or excess air per mole of dry exhaust.

$\chi_{\text{int/exhdry}}$  = amount of intake air required to produce actual combustion products per mole of dry (raw or diluted) exhaust.

$\chi_{\text{raw/exhdry}}$  = amount of undiluted exhaust, without excess air, per mole of dry (raw or diluted) exhaust.

$\chi_{\text{O}_2\text{int}}$  = amount of intake air  $\text{O}_2$  per mole of intake air.

$\chi_{\text{CO}_2\text{intdry}}$  = amount of intake air  $\text{CO}_2$  per mole of dry intake air. You may use  $\chi_{\text{CO}_2\text{intdry}} = 375 \text{ } \mu\text{mol/mol}$ , but we recommend measuring the actual concentration in the intake air.

$\chi_{\text{H}_2\text{Ointdry}}$  = amount of intake air  $\text{H}_2\text{O}$  per mole of dry intake air.

$\chi_{\text{CO}_2\text{int}}$  = amount of intake air  $\text{CO}_2$  per mole of intake air.

$\chi_{\text{CO}_2\text{dil}}$  = amount of dilution gas  $\text{CO}_2$  per mole of dilution gas.

$\chi_{\text{CO}_2\text{dildry}}$  = amount of dilution gas  $\text{CO}_2$  per mole of dry dilution gas. If you use air as diluent, you may use  $\chi_{\text{CO}_2\text{dildry}} = 375 \text{ } \mu\text{mol/mol}$ , but we recommend measuring the actual concentration in the intake air.

$\chi_{\text{H}_2\text{Odildry}}$  = amount of dilution gas  $\text{H}_2\text{O}$  per mole of dry dilution gas.

$\chi_{\text{H}_2\text{Odil}}$  = amount of dilution gas  $\text{H}_2\text{O}$  per mole of dilution gas.

$\chi_{[\text{emission}]_{\text{meas}}}$  = amount of measured emission in the sample at the respective gas analyzer.

$\chi_{[\text{emission}]_{\text{dry}}}$  = amount of emission per dry mole of dry sample.

$\chi_{\text{H}_2\text{O}[\text{emission}]_{\text{meas}}}$  = amount of  $\text{H}_2\text{O}$  in sample at emission-detection location. Measure or estimate these values according to § 1065.145(e)(2).

$\chi_{\text{H}_2\text{Oint}}$  = amount of  $\text{H}_2\text{O}$  in the intake air, based on a humidity measurement of intake air.

$\alpha$  = atomic hydrogen-to-carbon ratio of the fuel (or mixture of test fuels) and any injected fluids.

$\beta$  = atomic oxygen-to-carbon ratio of the fuel (or mixture of test fuels) and any injected fluids.

$\gamma$  = atomic sulfur-to-carbon ratio of the fuel (or mixture of test fuels) and any injected fluids.

$\delta$  = atomic nitrogen-to-carbon ratio of the fuel (or mixture of test fuels) and any injected fluids.

\* \* \* \* \*

(d) *Carbon mass fraction of fuel.* Determine carbon mass fraction of fuel,

$w_C$ , based on the fuel properties as determined in paragraph (e) of this section, accounting for diesel exhaust

fluid's contribution to  $\alpha$ ,  $\beta$ ,  $\gamma$ , and  $\delta$ , or that of any other fluid injected into the

exhaust, if applicable. Calculate  $w_C$  using the following equation:

$$w_C = \frac{1 \cdot M_C}{1 \cdot M_C + \alpha \cdot M_H + \beta \cdot M_O + \gamma \cdot M_S + \delta \cdot M_N}$$

Eq. 1065.655-19

Where:

$w_C$  = carbon mass fraction of the fuel (or mixture of test fuels) and any injected fluids.

$M_C$  = molar mass of carbon.

$\alpha$  = atomic hydrogen-to-carbon ratio of the fuel (or mixture of test fuels) and any injected fluids.

$M_H$  = molar mass of hydrogen.

$\beta$  = atomic oxygen-to-carbon ratio of the fuel (or mixture of test fuels) and any injected fluids.

$M_O$  = molar mass of oxygen.

$\gamma$  = atomic sulfur-to-carbon ratio of the fuel (or mixture of test fuels) and any injected fluids.

$M_S$  = molar mass of sulfur.

$\delta$  = atomic nitrogen-to-carbon ratio of the fuel (or mixture of test fuels) and any injected fluids.

$M_N$  = molar mass of nitrogen.

Example:

$\alpha = 1.8$

$\beta = 0.05$

$\gamma = 0.0003$

$\delta = 0.0001$

$M_C = 12.0107$

$M_H = 1.00794$

$M_O = 15.9994$

$M_S = 32.065$

$M_N = 14.0067$

$$w_C = \frac{1 \cdot 12.0107}{1 \cdot 12.0107 + 1.8 \cdot 1.00794 + 0.05 \cdot 15.9994 + 0.0003 \cdot 32.065 + 0.0001 \cdot 14.0067}$$

$w_C = 0.8206$

(e) *Fuel and diesel exhaust fluid composition.* Determine fuel and diesel exhaust fluid composition represented by  $\alpha$ ,  $\beta$ ,  $\gamma$ , and  $\delta$  as described in this paragraph (e). When using measured fuel or diesel exhaust fluid properties, you must determine values for  $\alpha$  and  $\beta$  in all cases. If you determine compositions based on measured values and the default value listed in Table 1 of this section is zero, you may set  $\gamma$  and  $\delta$  to zero; otherwise determine  $\gamma$  and  $\delta$  (along with  $\alpha$  and  $\beta$ ) based on measured values. Determine elemental mass fractions and values for  $\alpha$ ,  $\beta$ ,  $\gamma$ , and  $\delta$  as follows:

(1) For liquid fuels, use the default values for  $\alpha$ ,  $\beta$ ,  $\gamma$ , and  $\delta$  in Table 1 of this section or determine mass fractions of liquid fuels for calculation of  $\alpha$ ,  $\beta$ ,  $\gamma$ , and  $\delta$  as follows:

(i) Determine the carbon and hydrogen mass fractions according to ASTM D5291 (incorporated by reference in § 1065.1010). When using ASTM D5291 to determine carbon and hydrogen mass fractions of gasoline (with or without blended ethanol), use good engineering judgment to adapt the method as appropriate. This may include consulting with the instrument manufacturer on how to test high-volatility fuels. Allow the weight of volatile fuel samples to stabilize for 20 minutes before starting the analysis; if the weight still drifts after 20 minutes, prepare a new sample. Retest the sample if the carbon, hydrogen, and oxygen mass fractions do not add up to a total

mass of 100 ±0.5%; if you do not measure oxygen, you may assume it has a zero concentration for this specification.

(ii) Determine oxygen mass fraction of gasoline (with or without blended ethanol) according to ASTM D5599 (incorporated by reference in § 1065.1010). For all other liquid fuels, determine the oxygen mass fraction using good engineering judgment.

(iii) Determine the nitrogen mass fraction according to ASTM D4629 or ASTM D5762 (incorporated by reference in § 1065.1010) for all liquid fuels. Select the correct method based on the expected nitrogen content.

(iv) Determine the sulfur mass fraction according to subpart H of this part.

(2) For gaseous fuels and diesel exhaust fluid, use the default values for  $\alpha$ ,  $\beta$ ,  $\gamma$ , and  $\delta$  in Table 1 of this section, or use good engineering judgment to determine those values based on measurement.

(3) For nonconstant fuel mixtures, you must account for the varying proportions of the different fuels. This generally applies for dual-fuel engines, but it also applies if diesel exhaust fluid is injected in a way that is not strictly proportional to fuel flow. Account for these varying concentrations either with a batch measurement that provides averaged values to represent the test interval, or by analyzing data from continuous mass rate measurements. Application of average values from a batch measurement generally applies to

situations where one fluid is a minor component of the total fuel mixture, for example dual-fuel engines with diesel pilot injection, where the diesel pilot fuel mass is less than 5% of the total fuel mass and diesel exhaust fluid injection; consistent with good engineering judgment.

(4) Calculate  $\alpha$ ,  $\beta$ ,  $\gamma$ , and  $\delta$  using the following equations:

$$\alpha = \frac{M_C}{M_H} \cdot \frac{\sum_{j=1}^M \dot{m}_j \cdot w_{Hj}}{\sum_{j=1}^M \dot{m}_j \cdot w_{Cj}}$$

Eq. 1065.655-20

$$\beta = \frac{M_C}{M_O} \cdot \frac{\sum_{j=1}^M \dot{m}_j \cdot w_{Oj}}{\sum_{j=1}^M \dot{m}_j \cdot w_{Cj}}$$

Eq. 1065.655-21

$$\gamma = \frac{M_C \cdot \sum_{j=1}^M \dot{m}_j \cdot w_{Sj}}{M_S \cdot \sum_{j=1}^M \dot{m}_j \cdot w_{Cj}}$$

Eq. 1065.655-22

$$\delta = \frac{M_C \cdot \sum_{j=1}^M \dot{m}_j \cdot w_{Nj}}{M_N \cdot \sum_{j=1}^M \dot{m}_j \cdot w_{Cj}}$$

Eq. 1065.655-23

Where:

M = total number of fuels and injected fluids over the duty cycle.  
 j = an indexing variable that represents one fuel or injected fluid, starting with j = 1.

$\dot{m}_j$  = the mass flow rate of the fuel or any injected fluid j. For applications using a single fuel and no DEF fluid, set this value to 1. For batch measurements, divide the total mass of fuel over the test interval duration to determine a mass rate.

$W_{Hj}$  = hydrogen mass fraction of fuel or any injected fluid j.

$W_{Cj}$  = carbon mass fraction of fuel or any injected fluid j.

$W_{Oj}$  = oxygen mass fraction of fuel or any injected fluid j.

$W_{Sj}$  = sulfur mass fraction of fuel or any injected fluid j.

$W_{Nj}$  = nitrogen mass fraction of fuel or any injected fluid j.

Example:

N = 1  
 j = 1  
 $\dot{m}_j = 1$   
 $W_{Hj} = 0.1239$   
 $W_{Cj} = 0.8206$   
 $W_{Oj} = 0.0547$   
 $W_{Sj} = 0.00066$   
 $W_{Nj} = 0.000095$   
 $M_C = 12.0107$   
 $M_H = 1.00794$

$M_O = 15.9994$   
 $M_S = 32.065$   
 $M_N = 14.0067$

$$\alpha = \frac{12.0107 \cdot 1 \cdot 0.1239}{1.00794 \cdot 1 \cdot 0.8206}$$

$$\beta = \frac{12.0107 \cdot 1 \cdot 0.0547}{15.9994 \cdot 1 \cdot 0.8206}$$

$$\gamma = \frac{12.0107 \cdot 1 \cdot 0.00066}{32.065 \cdot 1 \cdot 0.8206}$$

$$\delta = \frac{12.0107 \cdot 1 \cdot 0.000095}{14.0067 \cdot 1 \cdot 0.8206}$$

$\alpha = 1.799$   
 $\beta = 0.05004$   
 $\gamma = 0.0003012$   
 $\delta = 0.0001003$

TABLE 1 OF § 1065.655—DEFAULT VALUES OF  $\alpha$ ,  $\beta$ ,  $\gamma$ ,  $\delta$ , AND  $W_C$

Fuel or injected fluid	Atomic hydrogen, oxygen, sulfur, and nitrogen-to-carbon ratios CH $\alpha$ O $\beta$ S $\gamma$ N $\delta$	Carbon mass fraction, $W_C$ g/g
Gasoline .....	CH <sub>1.85</sub> O <sub>0</sub> S <sub>0</sub> N <sub>0</sub> .....	0.866
E10 Gasoline .....	CH <sub>1.92</sub> O <sub>0.03</sub> S <sub>0</sub> N <sub>0</sub> .....	0.833
E15 Gasoline .....	CH <sub>1.95</sub> O <sub>0.05</sub> S <sub>0</sub> N <sub>0</sub> .....	0.817
E85 Gasoline .....	CH <sub>2.73</sub> O <sub>0.38</sub> S <sub>0</sub> N <sub>0</sub> .....	0.576
E100 Ethanol .....	CH <sub>3</sub> O <sub>0.5</sub> S <sub>0</sub> N <sub>0</sub> .....	0.521
M100 Methanol .....	CH <sub>4</sub> O <sub>1</sub> S <sub>0</sub> N <sub>0</sub> .....	0.375
#1 Diesel .....	CH <sub>1.93</sub> O <sub>0</sub> S <sub>0</sub> N <sub>0</sub> .....	0.861
#2 Diesel .....	CH <sub>1.80</sub> O <sub>0</sub> S <sub>0</sub> N <sub>0</sub> .....	0.869
Liquefied petroleum gas .....	CH <sub>2.64</sub> O <sub>0</sub> S <sub>0</sub> N <sub>0</sub> .....	0.819
Natural gas .....	CH <sub>3.78</sub> O <sub>0.016</sub> S <sub>0</sub> N <sub>0</sub> .....	0.747
Residual fuel blends .....	Must be determined by measured fuel properties as described in paragraph (d)(1) of this section.	
Diesel exhaust fluid .....	CH <sub>17.85</sub> O <sub>7.92</sub> S <sub>0</sub> N <sub>2</sub> .....	0.065

(f) \* \* \*

(3) Fluid mass flow rate calculation. This calculation may be used only for steady-state laboratory testing. See § 1065.915(d)(5)(iv) for application to field testing. Calculate  $\dot{n}_{exh}$  based on using the following equation:

$$\dot{n}_{exh} = \sum_{j=1}^N \dot{m}_j \cdot \frac{w_C \cdot (1 + x_{H_2Oexhdry})}{M_C \cdot x_{Ccombdry}}$$

Eq. 1065.655-25

Where:

$\dot{n}_{exh}$  = raw exhaust molar flow rate from which you measured emissions.  
 N = total number of fuels and injected fluids over the duty cycle.  
 j = an indexing variable that represents one fuel or injected fluid, starting with j = 1.

$\dot{m}_j$  = the mass flow rate of the fuel or any injected fluid j.

Example:

N = 1  
 j = 1  
 $\dot{m}_j = 7.559$  g/s  
 $w_C = 0.869$  g/g  
 $M_C = 12.0107$  g/mol  
 $X_{Ccombdry} = 99.87$  mmol/mol = 0.09987 mol/mol  
 $X_{H_2Oexhdry} = 107.64$  mmol/mol = 0.10764 mol/mol

$$\dot{n}_{exh} = 7.559 \cdot \frac{0.869 \cdot (1 + 0.10764)}{12.0107 \cdot 0.09987}$$

$\dot{n}_{exh} = 6.066$  mol/s

\* \* \* \* \*

■ 269. Section 1065.660 is amended as follows:

■ a. By revising the section heading.

■ b. By revising paragraphs (a)(2) and (3).

■ c. By adding paragraph (a)(4).

■ d. By revising paragraph (b)(3).

■ e. By adding paragraph (b)(4).

■ f. By redesignating paragraph (c) as paragraph (d).

■ g. By adding a new paragraph (c).

■ h. By revising newly redesignated paragraph (d).

■ i. By adding paragraph (e).

The revisions and additions read as follows:

**§ 1065.660 THC, NMHC, NMNEHC, CH<sub>4</sub>, and C<sub>2</sub>H<sub>6</sub> determination.**

\* \* \* \* \*

(a) \* \* \*

(2) For the NMHC determination described in paragraph (b) of this section, correct  $x_{THC[THC-FID]}$  for initial THC contamination using Eq. 1065.660–

1. You may correct  $x_{\text{THC}[\text{NMC-FID}]}$  for initial contamination of the  $\text{CH}_4$  sample train using Eq. 1065.660-1, substituting in  $\text{CH}_4$  concentrations for THC.

(3) For the NMNEHC determination described in paragraph (c) of this section, correct  $x_{\text{THC}[\text{THC-FID}]}$  for initial THC contamination using Eq. 1065.660-1. You may correct  $x_{\text{THC}[\text{NMC-FID}]}$  for initial contamination of the  $\text{CH}_4$  sample

train using Eq. 1065.660-1, substituting in  $\text{CH}_4$  concentrations for THC.

(4) For the  $\text{CH}_4$  determination described in paragraph (d) of this section, you may correct  $x_{\text{THC}[\text{NMC-FID}]}$  for initial THC contamination of the  $\text{CH}_4$  sample train using Eq. 1065.660-1, substituting in  $\text{CH}_4$  concentrations for THC.

(b) \* \* \*

(3) For a GC-FID or FTIR, calculate  $x_{\text{NMHC}}$  using the THC analyzer's response factor ( $RF$ ) for  $\text{CH}_4$ , from § 1065.360, and the initial THC contamination and dry-to-wet corrected THC concentration  $x_{\text{THC}[\text{THC-FID}]_{\text{cor}}}$  as determined in paragraph (a) of this section as follows:

$$x_{\text{NMHC}} = x_{\text{THC}[\text{THC-FID}]_{\text{cor}}} - RF_{\text{CH}_4[\text{THC-FID}]} \cdot x_{\text{CH}_4}$$

Eq. 1065.660-5

Where:

$x_{\text{NMHC}}$  = concentration of NMHC.

$x_{\text{THC}[\text{THC-FID}]_{\text{cor}}}$  = concentration of THC, initial THC contamination and dry-to-wet corrected, as measured by the THC FID.

$RF_{\text{CH}_4[\text{THC-FID}]}$  = response factor of THC-FID to  $\text{CH}_4$ .

$x_{\text{CH}_4}$  = concentration of  $\text{CH}_4$ , dry-to-wet corrected, as measured by the GC-FID or FTIR.

Example:

$x_{\text{THC}[\text{THC-FID}]_{\text{cor}}} = 145.6 \mu\text{mol/mol}$

$RF_{\text{CH}_4[\text{THC-FID}]} = 0.970$

$x_{\text{CH}_4} = 18.9 \mu\text{mol/mol}$

$x_{\text{NMHC}} = 145.6 - 0.970 \cdot 18.9$

$x_{\text{NMHC}} = 127.3 \mu\text{mol/mol}$

(4) For an FTIR, calculate  $x_{\text{NMHC}}$  by summing the hydrocarbon species listed in § 1065.266(c) as follows:

$$x_{\text{NMHC}} = \sum_{i=1}^N (x_{\text{HC}_i} - x_{\text{HC}_i\text{-init}})$$

Eq. 1065.660-6

Where:

$x_{\text{NMHC}}$  = concentration of NMHC.

$x_{\text{HC}_i}$  = the  $\text{C}_1$ -equivalent concentration of hydrocarbon species  $i$  as measured by the FTIR, not corrected for initial contamination.

$x_{\text{HC}_i\text{-init}}$  = the  $\text{C}_1$ -equivalent concentration of the initial system contamination (optional) of hydrocarbon species  $i$ , dry-to-wet corrected, as measured by the FTIR.

Example:

$x_{\text{C}_2\text{H}_6} = 4.9 \mu\text{mol/mol}$

$x_{\text{C}_2\text{H}_4} = 0.9 \mu\text{mol/mol}$

$x_{\text{C}_2\text{H}_2} = 0.8 \mu\text{mol/mol}$

$x_{\text{C}_3\text{H}_8} = 0.4 \mu\text{mol/mol}$

$x_{\text{C}_3\text{H}_6} = 0.5 \mu\text{mol/mol}$

$x_{\text{C}_4\text{H}_{10}} = 0.3 \mu\text{mol/mol}$

$x_{\text{CH}_2\text{O}} = 0.8 \mu\text{mol/mol}$

$x_{\text{C}_2\text{H}_4\text{O}} = 0.3 \mu\text{mol/mol}$

$x_{\text{C}_2\text{H}_2\text{O}_2} = 0.1 \mu\text{mol/mol}$

$x_{\text{CH}_4\text{O}} = 0.1 \mu\text{mol/mol}$

$x_{\text{NMHC}} = 4.9 + 0.9 + 0.8 + 0.4 + 0.5 + 0.3 + 0.8 + 0.3 + 0.1 + 0.1$

$x_{\text{NMHC}} = 9.1 \mu\text{mol/mol}$

(c) *NMNEHC determination.* Use one of the following methods to determine NMNEHC concentration,  $x_{\text{NMNEHC}}$ :

(1) If the content of your test fuel contains less than 0.010 mol/mol of

ethane, you may omit the calculation of NMNEHC concentrations and calculate the mass of NMNEHC as described in § 1065.650(c)(6).

(2) For a GC-FID or FTIR, calculate  $x_{\text{NMNEHC}}$  using the THC analyzer's response factors ( $RF$ ) for  $\text{CH}_4$  and  $\text{C}_2\text{H}_6$ , from § 1065.360, and the initial contamination and dry-to-wet corrected THC concentration  $x_{\text{THC}[\text{THC-FID}]_{\text{cor}}}$  as determined in paragraph (a) of this section as follows:

$$x_{\text{NMNEHC}} = x_{\text{THC}[\text{THC-FID}]_{\text{cor}}} - RF_{\text{CH}_4[\text{THC-FID}]} \cdot x_{\text{CH}_4} - RF_{\text{C}_2\text{H}_6[\text{THC-FID}]} \cdot x_{\text{C}_2\text{H}_6}$$

Eq. 1065.660-7

Where:

$x_{\text{NMNEHC}}$  = concentration of NMNEHC.

$x_{\text{THC}[\text{THC-FID}]_{\text{cor}}}$  = concentration of THC, initial THC contamination and dry-to-wet corrected, as measured by the THC FID.

$RF_{\text{CH}_4[\text{THC-FID}]}$  = response factor of THC-FID to  $\text{CH}_4$ .

$x_{\text{CH}_4}$  = concentration of  $\text{CH}_4$ , dry-to-wet corrected, as measured by the GC-FID or FTIR.

$RF_{\text{C}_2\text{H}_6[\text{THC-FID}]}$  = response factor of THC-FID to  $\text{C}_2\text{H}_6$ .

$x_{\text{C}_2\text{H}_6}$  = the  $\text{C}_1$ -equivalent concentration of  $\text{C}_2\text{H}_6$ , dry-to-wet corrected, as measured by the GC-FID or FTIR.

Example:

$x_{\text{THC}[\text{THC-FID}]_{\text{cor}}} = 145.6 \mu\text{mol/mol}$

$RF_{\text{CH}_4[\text{THC-FID}]} = 0.970$

$x_{\text{CH}_4} = 18.9 \mu\text{mol/mol}$

$RF_{\text{C}_2\text{H}_6[\text{THC-FID}]} = 1.02$

$x_{\text{C}_2\text{H}_6} = 10.6 \mu\text{mol/mol}$

$x_{\text{NMHC}} = 145.6 - 0.970 \cdot 18.9 - 1.02 \cdot 10.6$

$x_{\text{NMHC}} = 116.5 \mu\text{mol/mol}$

(3) For an FTIR, calculate  $x_{\text{NMNEHC}}$  by summing the hydrocarbon species listed in § 1065.266(c) as follows:



$$x_{\text{NMNEHC}} = \sum_{i=1}^N (x_{\text{HC}i} - x_{\text{HC}i\text{-init}})$$

Eq. 1065.660-8

Where:

 $x_{\text{NMNEHC}}$  = concentration of NMNEHC. $x_{\text{HC}i}$  = the  $C_1$ -equivalent concentration of hydrocarbon species  $i$  as measured by the FTIR, not corrected for initial contamination. $x_{\text{HC}i\text{-init}}$  = the  $C_1$ -equivalent concentration of the initial system contamination (optional) of hydrocarbon species  $i$ , dry-to-wet corrected, as measured by the FTIR.*Example:* $x_{\text{C}_2\text{H}_4}$  = 0.9  $\mu\text{mol/mol}$  $x_{\text{C}_2\text{H}_2}$  = 0.8  $\mu\text{mol/mol}$  $x_{\text{C}_3\text{H}_8}$  = 0.4  $\mu\text{mol/mol}$  $x_{\text{C}_3\text{H}_6}$  = 0.5  $\mu\text{mol/mol}$  $x_{\text{C}_4\text{H}_{10}}$  = 0.3  $\mu\text{mol/mol}$  $x_{\text{CH}_2\text{O}}$  = 0.8  $\mu\text{mol/mol}$  $x_{\text{C}_2\text{H}_4\text{O}}$  = 0.3  $\mu\text{mol/mol}$  $x_{\text{C}_2\text{H}_2\text{O}_2}$  = 0.1  $\mu\text{mol/mol}$  $x_{\text{CH}_4\text{O}}$  = 0.1  $\mu\text{mol/mol}$  $x_{\text{NMNEHC}}$  = 0.9 + 0.8 + 0.4 + 0.5 + 0.3 + 0.8 + 0.3 + 0.1 + 0.1 $x_{\text{NMNEHC}}$  = 4.2  $\mu\text{mol/mol}$ (d)  $\text{CH}_4$  determination. Use one of the following methods to determine  $\text{CH}_4$  concentration,  $x_{\text{CH}_4}$ :(1) For nonmethane cutters, calculate  $x_{\text{CH}_4}$  using the nonmethane cutter's penetration fraction ( $PF$ ) of  $\text{CH}_4$  and the response factor penetration fraction(RFPF) of  $\text{C}_2\text{H}_6$  from § 1065.365, the response factor ( $RF$ ) of the THC FID to  $\text{CH}_4$  from § 1065.360, the initial THC contamination and dry-to-wet corrected THC concentration  $x_{\text{THC}[\text{THC-FID}]_{\text{cor}}}$  as determined in paragraph (a) of this section, and the dry-to-wet corrected  $\text{CH}_4$  concentration  $x_{\text{THC}[\text{NMC-FID}]_{\text{cor}}}$  optionally corrected for initial THC contamination as determined in paragraph (a) of this section.

(i) Use the following equation for penetration fractions determined using an NMC configuration as outlined in § 1065.365(d):

$$x_{\text{CH}_4} = \frac{x_{\text{THC}[\text{NMC-FID}]_{\text{cor}}} - x_{\text{THC}[\text{THC-FID}]_{\text{cor}}} \cdot RFPF_{\text{C}_2\text{H}_6[\text{NMC-FID}]}}{1 - RFPF_{\text{C}_2\text{H}_6[\text{NMC-FID}]} \cdot RF_{\text{CH}_4[\text{THC-FID}]}}$$

Eq. 1065.660-9

Where:

 $x_{\text{CH}_4}$  = concentration of  $\text{CH}_4$ . $x_{\text{THC}[\text{NMC-FID}]_{\text{cor}}}$  = concentration of THC, initial THC contamination (optional) and dry-to-wet corrected, as measured by the NMC FID during sampling through the NMC. $x_{\text{THC}[\text{THC-FID}]_{\text{cor}}}$  = concentration of THC, initial THC contamination and dry-to-wet corrected, as measured by the THC FID during sampling while bypassing the NMC. $RFPF_{\text{C}_2\text{H}_6[\text{NMC-FID}]}$  = the combined ethane response factor and penetration fraction of the nonmethane cutter, according to § 1065.365(d). $RF_{\text{CH}_4[\text{THC-FID}]}$  = response factor of THC FID to  $\text{CH}_4$ , according to § 1065.360(d).*Example:* $x_{\text{THC}[\text{NMC-FID}]_{\text{cor}}}$  = 10.4  $\mu\text{mol/mol}$  $x_{\text{THC}[\text{THC-FID}]_{\text{cor}}}$  = 150.3  $\mu\text{mol/mol}$  $RFPF_{\text{C}_2\text{H}_6[\text{NMC-FID}]}$  = 0.019 $RF_{\text{CH}_4[\text{THC-FID}]}$  = 1.05

$$x_{\text{CH}_4} = \frac{10.4 - 150.3 \cdot 0.019}{1 - 0.019 \cdot 1.05}$$

 $x_{\text{CH}_4}$  = 7.69  $\mu\text{mol/mol}$ 

(ii) For penetration fractions determined using an NMC configuration

as outlined in § 1065.365(e), use the following equation:

$$x_{\text{CH}_4} = \frac{x_{\text{THC}[\text{NMC-FID}]_{\text{cor}}} - x_{\text{THC}[\text{THC-FID}]_{\text{cor}}} \cdot PF_{\text{C}_2\text{H}_6[\text{NMC-FID}]}}{RF_{\text{CH}_4[\text{THC-FID}]} \cdot (PF_{\text{CH}_4[\text{NMC-FID}]} - PF_{\text{C}_2\text{H}_6[\text{NMC-FID}]})}$$

Eq. 1065.660-10

Where:

 $x_{\text{CH}_4}$  = concentration of  $\text{CH}_4$ . $x_{\text{THC}[\text{NMC-FID}]_{\text{cor}}}$  = concentration of THC, initial THC contamination (optional) and dry-to-wet corrected, as measured by the NMC FID during sampling through the NMC. $x_{\text{THC}[\text{THC-FID}]_{\text{cor}}}$  = concentration of THC, initial THC contamination and dry-to-

wet corrected, as measured by the THC FID during sampling while bypassing the NMC.

 $PF_{\text{C}_2\text{H}_6[\text{NMC-FID}]}$  = nonmethane cutter ethane penetration fraction, according to § 1065.365(e). $RF_{\text{CH}_4[\text{THC-FID}]}$  = response factor of THC FID to  $\text{CH}_4$ , according to § 1065.360(d). $PF_{\text{CH}_4[\text{NMC-FID}]}$  = nonmethane cutter  $\text{CH}_4$  penetration fraction, according to § 1065.365(e).*Example:* $x_{\text{THC}[\text{NMC-FID}]_{\text{cor}}}$  = 10.4  $\mu\text{mol/mol}$  $x_{\text{THC}[\text{THC-FID}]_{\text{cor}}}$  = 150.3  $\mu\text{mol/mol}$  $PF_{\text{C}_2\text{H}_6[\text{NMC-FID}]}$  = 0.020 $RF_{\text{CH}_4[\text{THC-FID}]}$  = 1.05 $PF_{\text{CH}_4[\text{NMC-FID}]}$  = 0.990

$$x_{\text{CH}_4} = \frac{10.4 - 150.3 \cdot 0.020}{1.05 \cdot (0.990 - 0.020)}$$

$x_{\text{CH}_4} = 7.25 \mu\text{mol/mol}$

(iii) For penetration fractions determined using an NMC configuration as outlined in § 1065.365(f), use the following equation:

$$x_{\text{CH}_4} = \frac{x_{\text{THC}[\text{NMC-FID}]_{\text{cor}}} - x_{\text{THC}[\text{THC-FID}]_{\text{cor}}} \cdot RFPF_{\text{C}_2\text{H}_6[\text{NMC-FID}]}}{PF_{\text{CH}_4[\text{NMC-FID}]} - RFPF_{\text{C}_2\text{H}_6[\text{NMC-FID}]} \cdot RF_{\text{CH}_4[\text{THC-FID}]}}$$

Eq. 1065.660-11

Where:

$x_{\text{CH}_4}$  = concentration of  $\text{CH}_4$ .

$x_{\text{THC}[\text{NMC-FID}]_{\text{cor}}}$  = concentration of THC, initial THC contamination (optional) and dry-to-wet corrected, as measured by the NMC FID during sampling through the NMC.

$x_{\text{THC}[\text{THC-FID}]_{\text{cor}}}$  = concentration of THC, initial THC contamination and dry-to-

wet corrected, as measured by the THC FID during sampling while bypassing the NMC.

$RFPF_{\text{C}_2\text{H}_6[\text{NMC-FID}]}$  = the combined ethane response factor and penetration fraction of the nonmethane cutter, according to § 1065.365(f).

$PF_{\text{CH}_4[\text{NMC-FID}]}$  = nonmethane cutter  $\text{CH}_4$  penetration fraction, according to § 1065.365(f).

$RF_{\text{CH}_4[\text{THC-FID}]}$  = response factor of THC FID to  $\text{CH}_4$ , according to § 1065.360(d).

Example:

$x_{\text{THC}[\text{NMC-FID}]_{\text{cor}}} = 10.4 \mu\text{mol/mol}$

$x_{\text{THC}[\text{THC-FID}]_{\text{cor}}} = 150.3 \mu\text{mol/mol}$

$RFPF_{\text{C}_2\text{H}_6[\text{NMC-FID}]} = 0.019$

$PF_{\text{CH}_4[\text{NMC-FID}]} = 0.990$

$RF_{\text{CH}_4[\text{THC-FID}]} = 1.05$

$$x_{\text{CH}_4} = \frac{10.4 - 150.3 \cdot 0.019}{0.990 - 0.019 \cdot 1.05}$$

$x_{\text{CH}_4} = 7.78 \mu\text{mol/mol}$

(2) For a GC-FID or FTIR,  $x_{\text{CH}_4}$  is the actual dry-to-wet corrected  $\text{CH}_4$  concentration as measured by the analyzer.

(e)  $\text{C}_2\text{H}_6$  determination. For a GC-FID or FTIR,  $x_{\text{C}_2\text{H}_6}$  is the  $\text{C}_1$ -equivalent, dry-to-wet corrected  $\text{C}_2\text{H}_6$  concentration as measured by the analyzer.

■ 270. Section 1065.665 is amended by revising paragraphs (a) and (b) to read as follows:

**§ 1065.665 THCE and NMHCE determination.**

(a) If you measured an oxygenated hydrocarbon's mass concentration, first calculate its molar concentration in the exhaust sample stream from which the sample was taken (raw or diluted exhaust), and convert this into a  $\text{C}_1$ -equivalent molar concentration. Add these  $\text{C}_1$ -equivalent molar concentrations to the molar concentration of non-oxygenated total

hydrocarbon (NOTHC). The result is the molar concentration of total hydrocarbon equivalent (THCE). Calculate THCE concentration using the following equations, noting that Eq. 1065.665-3 is required only if you need to convert your oxygenated hydrocarbon (OHC) concentration from mass to moles:

$$x_{\text{THCE}} = x_{\text{NOTHC}} + \sum_{i=1}^N (x_{\text{OHC}_i} - x_{\text{OHC}_i\text{-init}})$$

Eq. 1065.665-1

$$x_{\text{NOTHC}} = x_{\text{THC}[\text{THC-FID}]_{\text{cor}}} - \sum_{i=1}^N ((x_{\text{OHC}_i} - x_{\text{OHC}_i\text{-init}}) \cdot RF_{\text{OHC}_i[\text{THC-FID}]})$$

Eq. 1065.665-2

$$x_{\text{OHCi}} = \frac{\frac{m_{\text{dexhOHCi}}}{M_{\text{OHCi}}}}{\frac{m_{\text{dexh}}}{M_{\text{dexh}}}} = \frac{n_{\text{dexhOHCi}}}{n_{\text{dexh}}}$$

Eq. 1065.665-3

Where:

- $x_{\text{THCE}}$  = the sum of the C<sub>1</sub>-equivalent concentrations of non-oxygenated hydrocarbon, alcohols, and aldehydes.
- $x_{\text{NOTHC}}$  = the sum of the C<sub>1</sub>-equivalent concentrations of NOTHC.
- $x_{\text{OHCi}}$  = the C<sub>1</sub>-equivalent concentration of oxygenated species *i* in diluted exhaust, not corrected for initial contamination.
- $x_{\text{OHCi-init}}$  = the C<sub>1</sub>-equivalent concentration of the initial system contamination (optional) of oxygenated species *i*, dry-to-wet corrected.

- $x_{\text{THC[THC-FID]cor}}$  = the C<sub>1</sub>-equivalent response to NOTHC and all OHC in diluted exhaust, HC contamination and dry-to-wet corrected, as measured by the THC-FID.
- $RF_{\text{OHCi[THC-FID]}}$  = the response factor of the FID to species *i* relative to propane on a C<sub>1</sub>-equivalent basis.
- $C^\#$  = the mean number of carbon atoms in the particular compound.
- $M_{\text{dexh}}$  = the molar mass of diluted exhaust as determined in § 1065.340.

- $m_{\text{dexhOHCi}}$  = the mass of oxygenated species *i* in dilute exhaust.
- $M_{\text{OHCi}}$  = the C<sub>1</sub>-equivalent molecular weight of oxygenated species *i*.
- $m_{\text{dexh}}$  = the mass of diluted exhaust
- $n_{\text{dexhOHCi}}$  = the number of moles of oxygenated species *i* in total diluted exhaust flow.
- $n_{\text{dexh}}$  = the total diluted exhaust flow.

(b) If we require you to determine nonmethane hydrocarbon equivalent (NMHCE), use the following equation:

$$x_{\text{NMHCE}} = x_{\text{THCE}} - RF_{\text{CH4[THC-FID]}} \cdot x_{\text{CH4}}$$

Eq. 1065.665-4

Where:

- $x_{\text{NMHCE}}$  = the sum of the C<sub>1</sub>-equivalent concentrations of nonoxygenated nonmethane hydrocarbon (NONMHC), alcohols, and aldehydes.
- $RF_{\text{CH4[THC-FID]}}$  = the response factor of THC-FID to CH<sub>4</sub>.
- $x_{\text{CH4}}$  = concentration of CH<sub>4</sub>, HC contamination (optional) and dry-to-wet corrected, as measured by the gas chromatograph FID.

- 271. Section 1065.667 is amended by revising paragraph (c) to read as follows:
- § 1065.667 Dilution air background emission correction.**
- (c) You may determine the total flow of dilution air by subtracting the calculated raw exhaust molar flow as described in § 1065.655(g) from the measured dilute exhaust flow. This may

- be done by totaling continuous calculations or by using batch results.
- 272. Section 1065.675 is amended by revising paragraph (d) to read as follows:
- § 1065.675 CLD quench verification calculations.**
- (d) Calculate quench as follows:

$$quench = \left( \left( \frac{x_{\text{NOwet}}}{1 - x_{\text{H2Omeas}} - 1} \right) \cdot \frac{x_{\text{H2Oexp}}}{x_{\text{H2Omeas}}} + \left( \frac{x_{\text{NOmeas}}}{x_{\text{NOact}}} - 1 \right) \cdot \frac{x_{\text{CO2exp}}}{x_{\text{CO2act}}} \right) \cdot 100 \%$$

Eq. 1065.675-1

Where:

- quench* = amount of CLD quench.
- $x_{\text{NOdry}}$  = concentration of NO upstream of a bubbler, according to § 1065.370(e)(4).
- $x_{\text{NOwet}}$  = measured concentration of NO downstream of a bubbler, according to § 1065.370(e)(9).
- $x_{\text{H2Oexp}}$  = maximum expected mole fraction of water during emission testing, according to paragraph (b) of this section.

- $x_{\text{H2Omeas}}$  = measured mole fraction of water during the quench verification, according to § 1065.370(e)(7).
- $x_{\text{NOmeas}}$  = measured concentration of NO when NO span gas is blended with CO<sub>2</sub> span gas, according to § 1065.370(d)(10).
- $x_{\text{NOact}}$  = actual concentration of NO when NO span gas is blended with CO<sub>2</sub> span gas, according to § 1065.370(d)(11) and calculated according to Eq. 1065.675-2.

- $x_{\text{CO2exp}}$  = maximum expected concentration of CO<sub>2</sub> during emission testing, according to paragraph (c) of this section.
- $x_{\text{CO2act}}$  = actual concentration of CO<sub>2</sub> when NO span gas is blended with CO<sub>2</sub> span gas, according to § 1065.370(d)(9).

$$x_{\text{NOact}} = \left( 1 - \frac{x_{\text{CO2act}}}{x_{\text{CO2span}}} \right) \cdot x_{\text{NOspan}}$$

Eq. 1065.675-2

Where:

$x_{\text{NOspan}}$  = The NO span gas concentration input to the gas divider, according to § 1065.370(d)(5).  
 $x_{\text{CO2span}}$  = the CO<sub>2</sub> span gas concentration input to the gas divider, according to § 1065.370(d)(4).

Example:

$x_{\text{NOdry}} = 1800.0 \mu\text{mol/mol}$   
 $x_{\text{NOWet}} = 1739.6 \mu\text{mol/mol}$   
 $x_{\text{H2Oexp}} = 0.030 \text{ mol/mol}$   
 $x_{\text{H2Omeas}} = 0.030 \text{ mol/mol}$   
 $x_{\text{NOmeas}} = 1515.2 \mu\text{mol/mol}$   
 $x_{\text{NOspan}} = 3001.6 \mu\text{mol/mol}$

$x_{\text{CO2exp}} = 3.2\%$   
 $x_{\text{CO2span}} = 6.1\%$   
 $x_{\text{CO2act}} = 2.98\%$

$$x_{\text{NOact}} = \left( 1 - \frac{2.98}{6.1} \right) \cdot 3001.6 = 1535.24459 \mu\text{mol/mol}$$

$$\text{quench} = \left( \left( \frac{1739.6}{1800.0} - 1 \right) \cdot \frac{0.030}{0.030} + \left( \frac{1515.2}{1535.24459} - 1 \right) \cdot \frac{3.2}{2.98} \right) \cdot 100\%$$

$\text{quench} = (-0.0036655 - 0.014020171) \cdot 100\%$   
 $= -1.7685671\%$

\* \* \* \* \*

■ 273. Section 1065.680 is added to subpart G to read as follows:

**§ 1065.680 Adjusting emission levels to account for infrequently regenerating aftertreatment devices.**

This section describes how to calculate and apply emission adjustment factors for engines using aftertreatment technology with infrequent regeneration events that may occur during testing. These adjustment factors are typically calculated based on measurements conducted for the purposes of engine certification, and then used to adjust the results of testing

related to demonstrating compliance with emission standards. For this section, “regeneration” means an intended event during which emission levels change while the system restores aftertreatment performance. For example, exhaust gas temperatures may increase temporarily to remove sulfur from adsorbers or to oxidize accumulated particulate matter in a trap. Also, “infrequent” refers to regeneration events that are expected to occur on average less than once over a transient or ramped-modal duty cycle, or on average less than once per mode in a discrete-mode test.

(a) Apply adjustment factors based on whether there is active regeneration

during a test segment. The test segment may be a test interval or a full duty cycle, as described in paragraph (b) of this section. For engines subject to standards over more than one duty cycle, you must develop adjustment factors under this section for each separate duty cycle. You must be able to identify active regeneration in a way that is readily apparent during all testing. All adjustment factors for regeneration are additive.

(1) If active regeneration does not occur during a test segment, apply an upward adjustment factor, *UAF*, that will be added to the measured emission rate for that test segment. Use the following equation to calculate *UAF*:

$$UAF_{[\text{cycle}]} = EF_{A[\text{cycle}]} - EF_{L[\text{cycle}]}$$

Eq. 1065.680-1

Where:

$EF_{A[\text{cycle}]}$  = the average emission factor over the test segment as determined in paragraph (a)(4) of this section.  
 $EF_{L[\text{cycle}]}$  = measured emissions over a complete test segment in which active regeneration does not occur.

Example:

$EF_{\text{ARMC}} = 0.15 \text{ g/kW}\cdot\text{hr}$   
 $EF_{\text{LRMC}} = 0.11 \text{ g/kW}\cdot\text{hr}$   
 $UAF_{\text{RMC}} = 0.15 - 0.11 = 0.04 \text{ g/kW}\cdot\text{hr}$

(2) If active regeneration occurs or starts to occur during a test segment,

apply a downward adjustment factor, *DAF*, that will be subtracted from the measured emission rate for that test segment. Use the following equation to calculate *DAF*:

$$DAF_{[\text{cycle}]} = EF_{H[\text{cycle}]} - EF_{A[\text{cycle}]}$$

Eq. 1065.680-2

Where:

$EF_{H[\text{cycle}]}$  = measured emissions over the test segment from a complete regeneration event, or the average emission rate over multiple complete test segments with regeneration if the complete regeneration event lasts longer than one test segment.

Example:

$$\begin{aligned} EF_{ARMC} &= 0.15 \text{ g/kW}\cdot\text{hr} \\ EF_{HRMC} &= 0.50 \text{ g/kW}\cdot\text{hr} \\ DAF_{RMC} &= 0.50 - 0.15 = 0.35 \text{ g/kW}\cdot\text{hr} \end{aligned}$$

(3) Note that emissions for a given pollutant may be lower during

regeneration, in which case  $EF_L$  would be greater than  $EF_H$ , and both  $UAF$  and  $DAF$  would be negative.

(4) Calculate the average emission factor,  $EF_A$ , as follows:

$$EF_{A[\text{cycle}]} = F_{[\text{cycle}]} \cdot EF_{H[\text{cycle}]} + (1.00 - F_{[\text{cycle}]}) \cdot EF_{L[\text{cycle}]}$$

Eq. 1065.680-3

Where:

$F_{[\text{cycle}]}$  = the frequency of the regeneration event during the test segment, expressed in terms of the fraction of equivalent test segments during which active regeneration occurs, as described in paragraph (a)(5) of this section.

Example:

$$\begin{aligned} F_{RMC} &= 0.10 \\ EF_{ARMC} &= 0.10 \cdot 0.50 + (1.00 - 0.10) \cdot 0.11 \\ &= 0.15 \text{ g/kW}\cdot\text{hr} \end{aligned}$$

(5) The frequency of regeneration,  $F$ , generally characterizes how often a

regeneration event occurs within a series of test segments. Determine  $F$  using the following equation, subject to the provisions of paragraph (a)(6) of this section:

$$F_{[\text{cycle}]} = \frac{i_{r[\text{cycle}]}}{i_{r[\text{cycle}]} + i_{t[\text{cycle}]}}$$

Eq. 1065.680-4

Where:

$i_{r[\text{cycle}]}$  = the number of successive test segments required to complete an active regeneration, rounded up to the next whole number.

$i_{t[\text{cycle}]}$  = the number of test segments from the end of one complete regeneration event to the start of the next active regeneration, without rounding.

$i_{rRMC} = 2$

$i_{tRMC} = 17.86$

Example:

$$F_{RMC} = \frac{2}{17.86 + 2} = 0.10$$

(6) Use good engineering judgment to determine  $i_r$  and  $i_t$ , as follows:

(i) For engines that are programmed to regenerate after a specific time interval, you may determine the duration of a regeneration event and the time between regeneration events based on the engine's design parameters. For other engines, determine these values based on measurements from in-use operation or from running repetitive duty cycles in a laboratory.

(ii) For engines subject to standards over multiple duty cycles, such as for transient and steady-state testing, apply this same calculation to determine a value of  $F$  for each duty cycle.

(iii) Consider an example for an engine that is designed to regenerate its PM filter 500 minutes after the end of the last regeneration event, with the

regeneration event lasting 30 minutes. If the RMC takes 28 minutes,  $i_{rRMC} = 2$  ( $30 \div 28 = 1.07$ , which rounds up to 2), and  $i_{tRMC} = 500 \div 28 = 17.86$ .

(b) Develop adjustment factors for different types of testing as follows:

(1) *Discrete-mode testing.* Develop separate adjustment factors for each test mode (test interval) of a discrete-mode test. When measuring  $EF_H$ , if a regeneration event has started but is not complete when you reach the end of the sampling time for a test interval, extend the sampling period for that test interval until the regeneration event is complete.

(2) *Ramped-modal and transient testing.* Develop a separate set of adjustment factors for an entire ramped-modal cycle or transient duty cycle. When measuring  $EF_H$ , if a regeneration event has started but is not complete

when you reach the end of the duty cycle, start the next repeat test as soon as possible, allowing for the time needed to complete emission measurement and installation of new filters for PM measurement; in that case  $EF_H$  is the average emission level for the test segments that included regeneration.

(3) *Accounting for cold-start measurements.* For engines subject to cold-start testing requirements, incorporate cold-start operation into your analysis as follows:

(i) Determine the frequency of regeneration,  $F$ , in a way that incorporates the impact of cold-start operation in proportion to the cold-start weighting factor specified in the standard-setting part. You may use good engineering judgment to determine the

effect of cold-start operation analytically.

(ii) Treat cold-start testing and hot-start testing together as a single test segment for adjusting measured emission results under this section. Apply the adjustment factor to the composite emission result.

(iii) You may apply the adjustment factor only to the hot-start test result if your aftertreatment technology does not regenerate during cold operation as represented by the cold-start transient duty cycle. If we ask for it, you must demonstrate this by engineering analysis or by test data.

(c) If an engine has multiple regeneration strategies, determine and apply adjustment factors under this section separately for each type of regeneration.

■ 274. Section 1065.690 is amended by revising paragraph (c) to read as follows:

**§ 1065.690 Buoyancy correction for PM sample media.**

\* \* \* \* \*

(c) *Air density*. Because a PM balance environment must be tightly controlled to an ambient temperature of (22 ±1) °C and humidity has an insignificant effect on buoyancy correction, air density is primarily a function of atmospheric pressure. Therefore you may use nominal constant values for temperature and humidity when determining the air density of the balance environment in Eq. 1065.690–2.

\* \* \* \* \*

**Subpart H—Engine Fluids, Test Fuels, Analytical Gases and Other Calibration Standards**

■ 275. A new § 1065.735 is added to subpart H to read as follows:

**§ 1065.735 Diesel exhaust fluid.**

(a) Use commercially available diesel exhaust fluid that represents the product that will be used in your in-use engines.

(b) Diesel exhaust fluid for testing must generally conform to the specifications referenced in the definition of “diesel exhaust fluid” in § 1065.1001. Use marine-grade diesel exhaust fluid only for marine engines.

■ 276. Section 1065.750 is amended by adding new paragraphs (a)(3)(xii) and (xiii) to read as follows:

**§ 1065.750 Analytical gases.**

\* \* \* \* \*

(a) \* \* \*

(3) \* \* \*

(xii) CH<sub>4</sub>, C<sub>2</sub>H<sub>6</sub>, balance purified air and/or N<sub>2</sub> (as applicable).

(xiii) CH<sub>4</sub>, CH<sub>2</sub>O, CH<sub>2</sub>O<sub>2</sub>, C<sub>2</sub>H<sub>2</sub>, C<sub>2</sub>H<sub>4</sub>, C<sub>2</sub>H<sub>4</sub>O, C<sub>2</sub>H<sub>6</sub>, C<sub>3</sub>H<sub>8</sub>, C<sub>3</sub>H<sub>6</sub>, CH<sub>4</sub>O, and C<sub>4</sub>H<sub>10</sub>. You may omit individual gas constituents from this gas mixture. If your gas mixture contains oxygenated hydrocarbon, your gas mixture must be in balance purified N<sub>2</sub>, otherwise you may use balance purified air.

\* \* \* \* \*

**Subpart K—Definitions and Other Reference Information**

■ 277. Section 1065.1001 is amended as follows:

■ a. By adding definitions for “Average” and “C<sub>1</sub>-equivalent” in alphabetical order.

■ b. By removing the definition for “C<sub>1</sub> equivalent (or basis)”.

■ c. By adding a definition for “Diesel exhaust fluid (DEF)” in alphabetical order.

■ d. By revising the definitions for “Hydrocarbon (HC)” and “Linearity”.

■ e. By adding a definition for “Nonmethane nonethane hydrocarbon (NMNEHC)” in alphabetical order.

The added and revised definitions read as follows:

**§ 1065.1001 Definitions.**

\* \* \* \* \*

*Average* means the arithmetic mean of a sample.

\* \* \* \* \*

*C<sub>1</sub>-equivalent* means a convention of expressing HC concentrations based on the total number of carbon atoms present, such that the C<sub>1</sub>-equivalent of a molar HC concentration equals the molar concentration multiplied by the mean number of carbon atoms in each HC molecule. For example, the C<sub>1</sub>-equivalent of 10 μmol/mol of propane (C<sub>3</sub>H<sub>8</sub>) is 30 μmol/mol. C<sub>1</sub>-equivalent molar values may be denoted as “ppmC” in the standard-setting part. Molar mass may also be expressed on a C<sub>1</sub> basis. Note that calculating HC

masses from molar concentrations and molar masses is only valid where they are each expressed on the same carbon basis.

\* \* \* \* \*

*Diesel exhaust fluid (DEF)* means a liquid reducing agent (other than the engine fuel) used in conjunction with selective catalytic reduction to reduce NO<sub>x</sub> emissions. *Diesel exhaust fluid* is generally understood to be an aqueous solution of urea conforming to the specifications of ISO 18611 or ISO 22241.

\* \* \* \* \*

*Hydrocarbon (HC)* means THC, THCE, NMHC, NMNEHC, NMOG, or NMHCE, as applicable. Hydrocarbon generally means the hydrocarbon group on which the emission standards are based for each type of fuel and engine.

\* \* \* \* \*

*Linearity* means the degree to which measured values agree with respective reference values. Linearity is quantified using a linear regression of pairs of measured values and reference values over a range of values expected or observed during testing. Perfect linearity would result in an intercept, *a*<sub>0</sub>, equal to zero, a slope, *a*<sub>1</sub>, of one, a coefficient of determination, *r*<sup>2</sup>, of one, and a standard error of the estimate, *SEE*, of zero. The term “linearity” is not used in this part to refer to the shape of a measurement instrument’s unprocessed response curve, such as a curve relating emission concentration to voltage output. A properly performing instrument with a nonlinear response curve will meet linearity specifications.

\* \* \* \* \*

*Nonmethane nonethane hydrocarbon (NMNEHC)* means the sum of all hydrocarbon species except methane and ethane. Refer to § 1065.660 for NMNEHC determination.

\* \* \* \* \*

■ 278. Section 1065.1005 is amended by revising paragraphs (a), (b), and (f)(2) to read as follows:

**§ 1065.1005 Symbols, abbreviations, acronyms, and units of measure.**

\* \* \* \* \*

(a) *Symbols for quantities*. This part uses the following symbols and units of measure for various quantities:

Symbol	Quantity	Unit	Unit symbol	Units in terms of SI base units
α	atomic hydrogen-to-carbon ratio	mole per mole	mol/mol	1.
A	area	square meter	m <sup>2</sup>	m <sup>2</sup> .
a <sub>0</sub>	intercept of least squares regression.			
a <sub>1</sub>	slope of least squares regression.			
a <sub>g</sub>	acceleration of Earth’s gravity	meter per square second	m/s <sup>2</sup>	m·s <sup>−2</sup> .
β	ratio of diameters	meter per meter	m/m	1.

Symbol	Quantity	Unit	Unit symbol	Units in terms of SI base units
$\beta$ .....	atomic oxygen-to-carbon ratio .....	mole per mole .....	mol/mol .....	1.
$C_{\#}$ .....	number of carbon atoms in a molecule.			
$C_d$ .....	discharge coefficient.			
$C_f$ .....	flow coefficient.			
$\delta$ .....	atomic nitrogen-to-carbon ratio .....	mole per mole .....	mol/mol .....	1.
$d$ .....	Diameter .....	meter .....	m .....	m.
$DR$ .....	dilution ratio .....	mole per mole .....	mol/mol .....	1.
$\epsilon$ .....	error between a quantity and its reference.			
$e$ .....	brake-specific emission or fuel consumption	gram per kilowatt hour .....	g/(kW-hr) .....	$g \cdot 3.6 \cdot 10^{-3} \cdot kg^{-1} \cdot s^2$ .
$F$ .....	F-test statistic.			
$f$ .....	frequency .....	hertz .....	Hz .....	$s^{-1}$ .
$f_n$ .....	angular speed (shaft) .....	revolutions per minute .....	r/min .....	$\pi \cdot 30^{-1} \cdot s^{-1}$ .
$\gamma$ .....	ratio of specific heats .....	(joule per kilogram kelvin) per (joule per kilogram kelvin).	$(J/(kg \cdot K))/(J/(kg \cdot K))$	1.
$\gamma$ .....	atomic sulfur-to-carbon ratio .....	mole per mole .....	mol/mol .....	1.
$K$ .....	correction factor .....			1.
$K_v$ .....	calibration coefficient .....		$m^4 \cdot s^{-0.5} / kg$	$m^4 \cdot kg^{-1} \cdot s \cdot K^{0.5}$ .
$l$ .....	length .....	meter .....	m .....	m.
$\mu$ .....	viscosity, dynamic .....	pascal second .....	Pa-s .....	$m^{-1} \cdot kg \cdot s^{-1}$ .
$M$ .....	molar mass <sup>1</sup> .....	gram per mole .....	g/mol .....	$10^{-3} \cdot kg \cdot mol^{-1}$ .
$m$ .....	mass .....	kilogram .....	kg .....	kg.
$\dot{m}$ .....	mass rate .....	kilogram per second .....	kg/s .....	$kg \cdot s^{-1}$ .
$\nu$ .....	viscosity, kinematic .....	meter squared per second .....	$m^2/s$ .....	$m^2 \cdot s^{-1}$ .
$N$ .....	total number in series.			
$n$ .....	amount of substance .....	mole .....	mol .....	mol. ROW $\leq$
$\dot{n}$ .....	amount of substance rate .....	mole per second .....	mol/s .....	$mol \cdot s^{-1}$ .
$P$ .....	power .....	kilowatt .....	kW .....	$10^3 \cdot m$
$PF$ .....	penetration fraction.			
$p$ .....	pressure .....	pascal .....	Pa .....	$m^{-1} \cdot kg \cdot s^{-2}$ .
$\rho$ .....	mass density .....	kilogram per cubic meter .....	$kg/m^3$ .....	$m^{-3} \cdot kg$ .
$\Delta p$ .....	differential static pressure .....	pascal .....	Pa .....	$m^{-1} \cdot kg \cdot s^{-2}$ .
$r$ .....	ratio of pressures .....	pascal per pascal .....	Pa/Pa .....	1.
$r^2$ .....	coefficient of determination.			
$Ra$ .....	average surface roughness .....	micrometer .....	$\mu m$ .....	$10^{-6} \cdot m$ .
$Re^{\#}$ .....	Reynolds number.			
$RF$ .....	response factor.			
$RH$ .....	relative humidity.			
$\sigma$ .....	non-biased standard deviation.			
$S$ .....	Sutherland constant .....	kelvin .....	K .....	K.
$SEE$ .....	standard estimate of error.			
$T$ .....	absolute temperature .....	kelvin .....	K .....	K.
$T$ .....	Celsius temperature .....	degree Celsius .....	$^{\circ}C$ .....	$K - 273.15$ .
$T$ .....	torque (moment of force) .....	newton meter .....	N-m .....	$m^2 \cdot kg \cdot s^{-2}$ .
$\theta$ .....	plane angle .....	degrees .....	$^{\circ}$ .....	rad.
$t$ .....	time .....	second .....	s .....	s.
$\Delta t$ .....	time interval, period, 1/frequency .....	second .....	s .....	s.
$V$ .....	volume .....	cubic meter .....	$m^3$ .....	$m^3$ .
$\dot{V}$ .....	volume rate .....	cubic meter per second .....	$m^3/s$ .....	$m^3 \cdot s^{-1}$ .
$W$ .....	work .....	kilowatt-hour .....	kW-hr .....	$3.6^{-1} \cdot 10^6 \cdot m^2 \cdot kg \cdot s^{-2}$ .
$w_C$ .....	carbon mass fraction .....	gram per gram .....	g/g .....	1.
$x$ .....	amount of substance mole fraction <sup>2</sup> .....	mole per mole .....	mol/mol .....	1.
$\bar{x}$ .....	flow-weighted mean concentration .....	mole per mole .....	mol/mol .....	1.
$y$ .....	generic variable.			
$Z$ .....	compressibility factor.			

<sup>1</sup> See paragraph (f)(2) of this section for the values to use for molar masses. Note that in the cases of NO<sub>x</sub> and HC, the regulations specify effective molar masses based on assumed speciation rather than actual speciation.

<sup>2</sup> Note that mole fractions for THC, THCE, NMHC, NMHCE, and NOTHC are expressed on a C<sub>1</sub>-equivalent basis.

(b) *Symbols for chemical species.* This part uses the following symbols for chemical species and exhaust constituents:

Symbol	Species
Ar .....	argon.
C .....	carbon.
CH <sub>2</sub> O .....	formaldehyde.

Symbol	Species
CH <sub>2</sub> O <sub>2</sub> .....	formic acid.
CH <sub>3</sub> OH .....	methanol.
CH <sub>4</sub> .....	methane.
C <sub>2</sub> H <sub>4</sub> O .....	acetaldehyde.
C <sub>2</sub> H <sub>5</sub> OH .....	ethanol.
C <sub>2</sub> H <sub>6</sub> .....	ethane.
C <sub>3</sub> H <sub>7</sub> OH .....	propanol.
C <sub>3</sub> H <sub>8</sub> .....	propane.
C <sub>4</sub> H <sub>10</sub> .....	butane.

Symbol	Species
C <sub>5</sub> H <sub>12</sub> .....	pentane.
CO .....	carbon monoxide.
CO <sub>2</sub> .....	carbon dioxide.
H .....	atomic hydrogen.
H <sub>2</sub> .....	molecular hydrogen.
H <sub>2</sub> O .....	water.
H <sub>2</sub> SO <sub>4</sub> .....	sulfuric acid.
HC .....	hydrocarbon.
He .....	helium.

Symbol	Species	Symbol	Species	Symbol	Species
<sup>85</sup> Kr	krypton 85.	N <sub>2</sub> O	nitrous oxide.	SVOC	semi-volatile organic compound.
N <sub>2</sub>	molecular nitrogen.	NMOG	nonmethane organic gases.	THC	total hydrocarbon.
NH <sub>3</sub>	ammonia.	NONMHC	non-oxygenated nonmethane hydrocarbon.	THCE	total hydrocarbon equivalent.
NMHC	nonmethane hydrocarbon.	NOTHC	non-oxygenated total hydrocarbon.	ZrO <sub>2</sub>	zirconium dioxide.
NMHCE	nonmethane hydrocarbon equivalent.	O <sub>2</sub>	molecular oxygen.	* * * * *	
NMNEHC	nonmethane-nonethane hydrocarbon.	OHC	oxygenated hydrocarbon.	(f) * * *	
NO	nitric oxide.	<sup>210</sup> Po	polonium 210.	(2) This part uses the following molar masses or effective molar masses of chemical species:	
NO <sub>2</sub>	nitrogen dioxide.	PM	particulate matter.		
NO <sub>x</sub>	oxides of nitrogen.	S	sulfur.		

Symbol	Quantity	g/mol (10 <sup>-3</sup> .kg.mol <sup>-1</sup> )
M <sub>air</sub>	molar mass of dry air <sup>1</sup>	28.96559
M <sub>Ar</sub>	molar mass of argon	39.948
M <sub>C</sub>	molar mass of carbon	12.0107
M <sub>CH<sub>3</sub>OH</sub>	molar mass of methanol	32.04186
M <sub>C<sub>2</sub>H<sub>5</sub>OH</sub>	molar mass of ethanol	46.06844
M <sub>C<sub>2</sub>H<sub>4</sub>O</sub>	molar mass of acetaldehyde	44.05256
M <sub>CH<sub>4</sub>N<sub>2</sub>O</sub>	molar mass of urea	60.05526
M <sub>C<sub>3</sub>H<sub>8</sub></sub>	molar mass of propane	44.09562
M <sub>C<sub>3</sub>H<sub>7</sub>OH</sub>	molar mass of propanol	60.09502
M <sub>CO</sub>	molar mass of carbon monoxide	28.0101
M <sub>CH<sub>4</sub></sub>	molar mass of methane	16.0425
M <sub>CO<sub>2</sub></sub>	molar mass of carbon dioxide	44.0095
M <sub>H</sub>	molar mass of atomic hydrogen	1.00794
M <sub>H<sub>2</sub></sub>	molar mass of molecular hydrogen	2.01588
M <sub>H<sub>2</sub>O</sub>	molar mass of water	18.01528
M <sub>CH<sub>2</sub>O</sub>	molar mass of formaldehyde	30.02598
M <sub>He</sub>	molar mass of helium	4.002602
M <sub>N</sub>	molar mass of atomic nitrogen	14.0067
M <sub>N<sub>2</sub></sub>	molar mass of molecular nitrogen	28.0134
M <sub>NH<sub>3</sub></sub>	molar mass of ammonia	17.03052
M <sub>NMHC</sub>	effective C <sub>1</sub> molar mass of nonmethane hydrocarbon <sup>2</sup>	13.875389
M <sub>NMHCE</sub>	effective C <sub>1</sub> molar mass of nonmethane hydrocarbon equivalent <sup>2</sup>	13.875389
M <sub>NMNEHC</sub>	effective C <sub>1</sub> molar mass of nonmethane-nonethane hydrocarbon <sup>2</sup>	13.875389
M <sub>NO<sub>x</sub></sub>	effective molar mass of oxides of nitrogen <sup>3</sup>	46.0055
M <sub>N<sub>2</sub>O</sub>	molar mass of nitrous oxide	44.0128
M <sub>O</sub>	molar mass of atomic oxygen	15.9994
M <sub>O<sub>2</sub></sub>	molar mass of molecular oxygen	31.9988
M <sub>S</sub>	molar mass of sulfur	32.065
M <sub>THC</sub>	effective C <sub>1</sub> molar mass of total hydrocarbon <sup>2</sup>	13.875389
M <sub>THCE</sub>	effective C <sub>1</sub> molar mass of total hydrocarbon equivalent <sup>2</sup>	13.875389

<sup>1</sup> See paragraph (f)(1) of this section for the composition of dry air.

<sup>2</sup> The effective molar masses of THC, THCE, NMHC, NMHCE, and NMNEHC are defined on a C<sub>1</sub> basis and are based on an atomic hydrogen-to-carbon ratio, α, of 1.85 (with β, γ, and δ equal to zero).

<sup>3</sup> The effective molar mass of NO<sub>x</sub> is defined by the molar mass of nitrogen dioxide, NO<sub>2</sub>.

\* \* \* \* \*

■ 279. Section 1065.1010 is amended by revising paragraphs (b) and (e) to read as follows:

**§ 1065.1010 Incorporation by reference.**

\* \* \* \* \*

(b) *ASTM material.* The following standards are available from ASTM International, 100 Barr Harbor Dr., P.O. Box C700, West Conshohocken, PA 19428–2959, (877) 909–2786, or <http://www.astm.org>:

(1) ASTM D86–12, Standard Test Method for Distillation of Petroleum Products at Atmospheric Pressure, approved December 1, 2012 (“ASTM D86”), IBR approved for §§ 1065.703(b) and 1065.710(b) and (c).

(2) ASTM D93–13, Standard Test Methods for Flash Point by Pensky-Martens Closed

Cup Tester, approved July 15, 2013 (“ASTM D93”), IBR approved for § 1065.703(b).

(3) ASTM D130–12, Standard Test Method for Corrosiveness to Copper from Petroleum Products by Copper Strip Test, approved November 1, 2012 (“ASTM D130”), IBR approved for § 1065.710(b).

(4) ASTM D381–12, Standard Test Method for Gum Content in Fuels by Jet Evaporation, approved April 15, 2012 (“ASTM D381”), IBR approved for § 1065.710(b).

(5) ASTM D445–12, Standard Test Method for Kinematic Viscosity of Transparent and Opaque Liquids (and Calculation of Dynamic Viscosity), approved April 15, 2012 (“ASTM D445”), IBR approved for § 1065.703(b).

(6) ASTM D525–12a, Standard Test Method for Oxidation Stability of Gasoline (Induction Period Method), approved September 1, 2012 (“ASTM D525”), IBR approved for § 1065.710(b).

(7) ASTM D613–13, Standard Test Method for Cetane Number of Diesel Fuel Oil, approved December 1, 2013 (“ASTM D613”), IBR approved for § 1065.703(b).

(8) ASTM D910–13a, Standard Specification for Aviation Gasolines, approved December 1, 2013 (“ASTM D910”), IBR approved for § 1065.701(f).

(9) ASTM D975–13a, Standard Specification for Diesel Fuel Oils, approved December 1, 2013 (“ASTM D975”), IBR approved for § 1065.701(f).

(10) ASTM D1267–12, Standard Test Method for Gage Vapor Pressure of Liquefied Petroleum (LP) Gases (LP-Gas Method), approved November 1, 2012 (“ASTM D1267”), IBR approved for § 1065.720(a).

(11) ASTM D1319–13, Standard Test Method for Hydrocarbon Types in Liquid Petroleum Products by Fluorescent Indicator Adsorption, approved May 1, 2013 (“ASTM D1319”), IBR approved for § 1065.710(c).



(12) ASTM D1655–13a, Standard Specification for Aviation Turbine Fuels, approved December 1, 2013 (“ASTM D1655”), IBR approved for § 1065.701(f).

(13) ASTM D1837–11, Standard Test Method for Volatility of Liquefied Petroleum (LP) Gases, approved October 1, 2011 (“ASTM D1837”), IBR approved for § 1065.720(a).

(14) ASTM D1838–12a, Standard Test Method for Copper Strip Corrosion by Liquefied Petroleum (LP) Gases, approved December 1, 2012 (“ASTM D1838”), IBR approved for § 1065.720(a).

(15) ASTM D1945–03 (Reapproved 2010), Standard Test Method for Analysis of Natural Gas by Gas Chromatography, approved January 1, 2010 (“ASTM D1945”), IBR approved for § 1065.715(a).

(16) ASTM D2158–11, Standard Test Method for Residues in Liquefied Petroleum (LP) Gases, approved January 1, 2011 (“ASTM D2158”), IBR approved for § 1065.720(a).

(17) ASTM D2163–07, Standard Test Method for Determination of Hydrocarbons in Liquefied Petroleum (LP) Gases and Propane/Propene Mixtures by Gas Chromatography, approved December 1, 2007 (“ASTM D2163”), IBR approved for § 1065.720(a).

(18) ASTM D2598–12, Standard Practice for Calculation of Certain Physical Properties of Liquefied Petroleum (LP) Gases from Compositional Analysis, approved November 1, 2012 (“ASTM D2598”), IBR approved for § 1065.720(a).

(19) ASTM D2622–10, Standard Test Method for Sulfur in Petroleum Products by Wavelength Dispersive X-ray Fluorescence Spectrometry, approved February 15, 2010 (“ASTM D2622”), IBR approved for §§ 1065.703(b) and 1065.710(b) and (c).

(20) ASTM D2699–13b, Standard Test Method for Research Octane Number of Spark-Ignition Engine Fuel, approved October 1, 2013 (“ASTM D2699”), IBR approved for § 1065.710(b).

(21) ASTM D2700–13b, Standard Test Method for Motor Octane Number of Spark-Ignition Engine Fuel, approved October 1, 2013 (“ASTM D2700”), IBR approved for § 1065.710(b).

(22) ASTM D2713–13, Standard Test Method for Dryness of Propane (Valve Freeze Method), approved October 1, 2013 (“ASTM D2713”), IBR approved for § 1065.720(a).

(23) ASTM D2784–11, Standard Test Method for Sulfur in Liquefied Petroleum Gases (Oxy-Hydrogen Burner or Lamp), approved January 1, 2011 (“ASTM D2784”), IBR approved for § 1065.720(a).

(24) ASTM D2880–13b, Standard Specification for Gas Turbine Fuel Oils, approved November 15, 2013 (“ASTM D2880”), IBR approved for § 1065.701(f).

(25) ASTM D2986–95a, Standard Practice for Evaluation of Air Assay Media by the Monodisperse DOP (Diocetyl Phthalate) Smoke Test, approved September 10, 1995 (“ASTM D2986”), IBR approved for § 1065.170(c). (Note: This standard was withdrawn by ASTM.)

(26) ASTM D3231–13, Standard Test Method for Phosphorus in Gasoline, approved June 15, 2013 (“ASTM D3231”), IBR approved for § 1065.710(b) and (c).

(27) ASTM D3237–12, Standard Test Method for Lead in Gasoline By Atomic Absorption Spectroscopy, approved June 1, 2012 (“ASTM D3237”), IBR approved for § 1065.710(b) and (c).

(28) ASTM D4052–11, Standard Test Method for Density, Relative Density, and API Gravity of Liquids by Digital Density Meter, approved October 15, 2011 (“ASTM D4052”), IBR approved for § 1065.703(b).

(29) ASTM D4629–12, Standard Test Method for Trace Nitrogen in Liquid Petroleum Hydrocarbons by Syringe/Inlet Oxidative Combustion and Chemiluminescence Detection, approved April 15, 2012 (“ASTM D4629”), IBR approved for § 1065.655(e).

(30) ASTM D4814–13b, Standard Specification for Automotive Spark-Ignition Engine Fuel, approved December 1, 2013 (“ASTM D4814”), IBR approved for § 1065.701(f).

(31) ASTM D4815–13, Standard Test Method for Determination of MTBE, ETBE, TAME, DIPE, tertiary-Amyl Alcohol and C<sub>1</sub> to C<sub>4</sub> Alcohols in Gasoline by Gas Chromatography, approved October 1, 2013 (“ASTM D4815”), IBR approved for § 1065.710(b).

(32) ASTM D5186–03 (Reapproved 2009), Standard Test Method for Determination of the Aromatic Content and Polynuclear Aromatic Content of Diesel Fuels and Aviation Turbine Fuels By Supercritical Fluid Chromatography, approved April 15, 2009 (“ASTM D5186”), IBR approved for § 1065.703(b).

(33) ASTM D5191–13, Standard Test Method for Vapor Pressure of Petroleum Products (Mini Method), approved December 1, 2013 (“ASTM D5191”), IBR approved for § 1065.710(b) and (c).

(34) ASTM D5291–10, Standard Test Methods for Instrumental Determination of Carbon, Hydrogen, and Nitrogen in Petroleum Products and Lubricants, approved May 1, 2010 (“ASTM D5291”), IBR approved for § 1065.655(e).

(35) ASTM D5453–12, Standard Test Method for Determination of Total Sulfur in Light Hydrocarbons, Spark Ignition Engine Fuel, Diesel Engine Fuel, and Engine Oil by Ultraviolet Fluorescence, approved November 1, 2012 (“ASTM D5453”), IBR approved for § 1065.710(b).

(36) ASTM D5599–00 (Reapproved 2010), Standard Test Method for Determination of Oxygenates in Gasoline by Gas Chromatography and Oxygen Selective Flame Ionization Detection, approved October 1, 2010 (“ASTM D5599”), IBR approved for §§ 1065.655(e) and 1065.710(b).

(37) ASTM D5762–12 Standard Test Method for Nitrogen in Petroleum and Petroleum Products by Boat-Inlet Chemiluminescence, approved April 15, 2012 (“ASTM D5762”), IBR approved for § 1065.655(e).

(38) ASTM D5769–10, Standard Test Method for Determination of Benzene, Toluene, and Total Aromatics in Finished Gasolines by Gas Chromatography/Mass Spectrometry, approved May 1, 2010 (“ASTM D5769”), IBR approved for § 1065.710(b).

(39) ASTM D5797–13, Standard Specification for Fuel Methanol (M70- M85)

for Automotive Spark-Ignition Engines, approved June 15, 2013 (“ASTM D5797”), IBR approved for § 1065.701(f).

(40) ASTM D5798–13a, Standard Specification for Ethanol Fuel Blends for Flexible Fuel Automotive Spark-Ignition Engines, approved June 15, 2013 (“ASTM D5798”), IBR approved for § 1065.701(f).

(41) ASTM D6348–12<sup>e1</sup>, Standard Test Method for Determination of Gaseous Compounds by Extractive Direct Interface Fourier Transform Infrared (FTIR) Spectroscopy, approved February 1, 2012 (“ASTM D6348”), IBR approved for §§ 1065.266(b) and 1065.275(b).

(42) ASTM D6550–10, Standard Test Method for Determination of Olefin Content of Gasolines by Supercritical-Fluid Chromatography, approved October 1, 2010 (“ASTM D6550”), IBR approved for § 1065.710(b).

(43) ASTM D6615–11a, Standard Specification for Jet B Wide-Cut Aviation Turbine Fuel, approved October 1, 2011 (“ASTM D6615”), IBR approved for § 1065.701(f).

(44) ASTM D6751–12, Standard Specification for Biodiesel Fuel Blend Stock (B100) for Middle Distillate Fuels, approved August 1, 2012 (“ASTM D6751”), IBR approved for § 1065.701(f).

(45) ASTM D6985–04a, Standard Specification for Middle Distillate Fuel Oil—Military Marine Applications, approved November 1, 2004 (“ASTM D6985”), IBR approved for § 1065.701(f). (Note: This standard was withdrawn by ASTM.)

(46) ASTM D7039–13, Standard Test Method for Sulfur in Gasoline, Diesel Fuel, Jet Fuel, Kerosine, Biodiesel, Biodiesel Blends, and Gasoline-Ethanol Blends by Monochromatic Wavelength Dispersive X-ray Fluorescence Spectrometry, approved September 15, 2013 (“ASTM D7039”), IBR approved for § 1065.710(b).

(47) ASTM F1471–09, Standard Test Method for Air Cleaning Performance of a High-Efficiency Particulate Air Filter System, approved March 1, 2009 (“ASTM F1471”), IBR approved for § 1065.1001.

\* \* \* \* \*

(e) *ISO material.* The following standards are available from the International Organization for Standardization, 1, ch. de la Voie-Creuse, CP 56, CH–1211 Geneva 20, Switzerland, 41–22–749–01–11, or <http://www.iso.org>:

(1) ISO 2719:2002, Determination of flash point—Pensky-Martens closed cup method (“ISO 2719”), IBR approved for § 1065.705(c).

(2) ISO 3016:1994, Petroleum products—Determination of pour point (“ISO 3016”), IBR approved for § 1065.705(c).

(3) ISO 3104:1994/Cor 1:1997, Petroleum products—Transparent and opaque liquids—Determination of kinematic viscosity and calculation of dynamic viscosity (“ISO 3104”), IBR approved for § 1065.705(c).

(4) ISO 3675:1998, Crude petroleum and liquid petroleum products—Laboratory determination of density—Hydrometer method (“ISO 3675”), IBR approved for § 1065.705(c).

(5) ISO 3733:1999, Petroleum products and bituminous materials—Determination of water—Distillation method (“ISO 3733”), IBR approved for § 1065.705(c).

(6) ISO 6245:2001, Petroleum products—Determination of ash (“ISO 6245”), IBR approved for § 1065.705(c).

(7) ISO 8217:2012(E), Petroleum products—Fuels (class F)—Specifications of marine fuels, Fifth edition, August 15, 2012 (“ISO 8217”), IBR approved for § 1065.705(b) and (c).

(8) ISO 8754:2003, Petroleum products—Determination of sulfur content—Energy-dispersive X-ray Fluorescence spectrometry (“ISO 8754”), IBR approved for § 1065.705(c).

(9) ISO 10307-2(E):2009, Petroleum products—Total sediment in residual fuel oils—Part 2: Determination using standard procedures for ageing, Second Ed., February 1, 2009 (“ISO 10307”), as modified by ISO 10307-2:2009/Cor.1:2010(E), Technical Corrigendum 1, published May 15, 2010, IBR approved for § 1065.705(c).

(10) ISO 10370:1993/Cor 1:1996, Petroleum products—Determination of carbon residue—Micro method (“ISO 10370”), IBR approved for § 1065.705(c).

(11) ISO 10478:1994, Petroleum products—Determination of aluminium and silicon in fuel oils—Inductively coupled plasma emission and atomic absorption spectroscopy methods (“ISO 10478”), IBR approved for § 1065.705(c).

(12) ISO 12185:1996/Cor 1:2001, Crude petroleum and petroleum products—Determination of density—Oscillating U-tube method (“ISO 12185”), IBR approved for § 1065.705(c).

(13) ISO 14596:2007, Petroleum products—Determination of sulfur content—Wavelength-dispersive X-ray fluorescence spectrometry (“ISO 14596”), IBR approved for § 1065.705(c).

(14) ISO 14597:1997, Petroleum products—Determination of vanadium and nickel content—Wavelength dispersive X-ray fluorescence spectrometry (“ISO 14597”), IBR approved for § 1065.705(c).

(15) ISO 14644-1:1999, Cleanrooms and associated controlled environments (“ISO 14644”), IBR approved for § 1065.190(b).

\* \* \* \* \*

#### Subpart L—Methods for Unregulated and Special Pollutants

■ 280. Section 1065.1105 is amended by revising paragraphs (a) and (c)(4) to read as follows:

##### § 1065.1105 Sampling system design.

(a) *General.* We recommend that you design your SVOC batch sampler to extract sample from undiluted emissions to maximize the sampled SVOC quantity. If you dilute your sample, we recommend using annular dilution. If you dilute your sample, but do not use annular dilution, you must precondition your sampling system to reach equilibrium with respect to loss and re-entrainment of SVOCs to the walls of the sampling system. To the

extent practical, adjust sampling times based on the emission rate of target analytes from the engine to obtain analyte concentrations above the detection limit. In some instances you may need to run repeat test cycles without replacing the sample media or disassembling the batch sampler.

\* \* \* \* \*

(c) \* \* \*

(4) Use a hydrophobic sorbent in a sealed sorbent module. Note that this sorbent module is intended to be the final stage for collecting the SVOC sample and should be sized accordingly. We recommend sizing the module to hold 40 g of XAD-2 along with PUF plugs at either end of the module, noting that you may vary the mass of XAD used for testing based on the anticipated SVOC emission concentration and sample flow rate.

\* \* \* \* \*

■ 281. Section 1065.1107 is amended by revising paragraphs (a)(1), (a)(2), and (b) introductory text to read as follows:

##### § 1065.1107 Sample media and sample system preparation; sample system assembly.

\* \* \* \* \*

(a) \* \* \*

(1) For capturing PM, we recommend using pure quartz filters with no binder if you are not analyzing separately for SVOCs in gas and particle phases. If you are analyzing separately, you must use polytetrafluoroethylene (PTFE) filters with PTFE support. Select the filter diameter to minimize filter change intervals, accounting for the expected PM emission rate, sample flow rate. Note that when repeating test cycles to increase sample mass, you may replace the filter without replacing the sorbent or otherwise disassembling the batch sampler. In those cases, include all filters in the extraction.

(2) For capturing gaseous SVOCs, utilize XAD-2 resin with or without PUF plugs. Note that two PUF plugs are typically used to contain the XAD-2 resin in the sorbent module.

(b) *Sample media and sampler preparation.* Prepare pre-cleaned PM filters and pre-cleaned PUF plugs/XAD-2 as needed. Store sample media in containers protected from light and ambient air if you do not use them immediately after cleaning. Use the following preparation procedure, or an analogous procedure with different solvents and extraction times:

\* \* \* \* \*

■ 282. Section 1065.1109 is amended by revising paragraphs (a)(1) and (b)(4) introductory text to read as follows:

##### § 1065.1109 Post-test sampler disassembly and sample extraction.

\* \* \* \* \*

(a) \* \* \*

(1) Remove the PM filter, PUF plugs, and all the XAD-2 from the sampling system and store them at or below 5 °C until analysis.

\* \* \* \* \*

(b) \* \* \*

(4) After completing the initial extraction, remove the solvent and concentrate it to (4.0 ± 0.5) ml using a Kuderna-Danish concentrator that includes a condenser such as a three-ball Snyder column with venting dimples and a graduated collection tube. Hold the water bath temperature at (75 to 80) °C. Using this concentrator will minimize evaporative loss of analytes with lower molecular weight.

\* \* \* \* \*

#### PART 1066—VEHICLE-TESTING PROCEDURES

■ 283. The authority citation for part 1066 continues to read as follows:

Authority: 42 U.S.C. 7401–7671q.

#### Subpart B— Equipment, Measurement Instruments, Fuel, and Analytical Gas Specifications

■ 284. Section 1066.105 is amended by revising paragraphs (c)(2) introductory text, (c)(2)(i), (c)(2)(iv), (c)(2)(v), (c)(5)(i), (c)(5)(iii), and (d) to read as follows:

##### § 1066.105 Ambient controls and vehicle cooling fans.

\* \* \* \* \*

(c) \* \* \*

(2) You may use a road-speed modulated fan system meeting the specifications of this paragraph (c)(2) for anything other than SC03 and AC17 testing. Use a road-speed modulated fan that achieves a linear speed of cooling air at the blower outlet that is within ±3.0 mi/hr (±1.3 m/s) of the corresponding roll speed when vehicle speeds are between 5 and 30 mi/hr, and within ±6.5 mi/hr (±2.9 m/s) of the corresponding roll speed at higher vehicle speeds; however you may limit the fan's maximum linear speed to 70 mi/hr. We recommend that the cooling fan have a minimum opening of 0.2 m<sup>2</sup> and a minimum width of 0.8 m.

(i) Verify the air flow velocity for fan speeds corresponding to vehicle speeds of 20 and 40 mi/hr using an instrument that has an accuracy of ±2% of the measured air flow speed.

\* \* \* \* \*

(iv) Verify that the uniformity of the fan's axial flow is constant across the discharge area within a tolerance of ±4.0

mi/hr of the vehicle's speed at fan speeds corresponding to 20 mi/hr, and within ±8.0 mi/hr at fan speeds corresponding to 40 mi/hr. For example, at a vehicle speed of 20.2 mi/hr, axial flow at all locations denoted by the "+" across the discharge nozzle must be between 16.2 and 24.2 mi/hr. When measuring the axial air flow velocity, use good engineering judgment to determine the distance from the nozzle outlet at each point of the fan outlet grid. Use these values to calculate a mean air flow velocity across the discharge area at each speed setting. The instrument used to verify the air velocity must have an accuracy of ±2% of the measured air flow velocity.

(v) Use a multi-axis flow meter or another method to verify that the fan's air flow perpendicular to the axial air flow is less than 15% of the axial air flow, consistent with good engineering judgment. Demonstrate this by comparing the perpendicular air flow velocity to the mean air flow velocities determined in paragraph (c)(2)(iv) of this section at vehicle speeds of 20 and 40 mi/hr.

\* \* \* \* \*

(5) \* \* \*

(i) Air flow volumes must be proportional to vehicle speed. Select a fan size that will produce a flow volume of approximately 45 m<sup>3</sup>/s at 60 mi/hr. If this fan is also the only source of test cell air circulation or if fan operational mechanics make the 0 mi/hr air flow requirement impractical, air flow of 2 mi/hr or less at 0 mi/hr vehicle speed is allowed.

\* \* \* \* \*

(iii) Use a multi-axis flow meter or another method to verify that the fan's air flow perpendicular to the axial air flow is less than 10% of the axial air flow, consistent with good engineering judgment. Demonstrate this by comparing the perpendicular air flow velocity to the mean air flow velocities determined in paragraph (c)(2)(iv) of this section at vehicle speeds of 20 and 40 mi/hr.

\* \* \* \* \*

(d) *Allowable cooling fans for vehicles above 14,000 pounds GVWR.* For all testing, use a road-speed modulated fan system that achieves a linear speed of cooling air at the blower outlet that is within ±3.0 mi/hr (±1.3 m/s) of the corresponding roll speed when vehicle speeds are between 5 and 30 mi/hr, and within ±10 mi/hr (±4.5 m/s) of the corresponding roll speed at higher vehicle speeds. For vehicles above 19,500 pounds GVWR, we recommend that the cooling fan have a minimum opening of 2.75 m<sup>2</sup>, a minimum flow rate of 60 m<sup>3</sup>/s at a fan speed of 50 mi/hr, and a minimum speed profile in the free stream flow, across the duct that is ±15% of the target flow rate.

■ 285. Section 1066.110 is amended as follows:

- a. By revising paragraph (b)(1)(i).
- b. By redesignating paragraphs (b)(1)(ii) through (vii) as paragraphs (b)(1)(iii) through (viii), respectively.
- c. By adding a new paragraph (b)(1)(ii).
- d. By revising newly redesignated paragraph (b)(1)(vii).
- e. By revising paragraph (b)(2)(i)(B).
- f. By adding paragraph (b)(2)(iii)(C).
- g. By revising paragraph (c).

The additions and revisions read as follows:

**§ 1066.110 Equipment specifications for emission sampling systems.**

\* \* \* \* \*

(b) \* \* \*

(1) \* \* \*

(i) Minimize lengths of laboratory exhaust tubing. You may use a total length of laboratory exhaust tubing up to 4 m without needing to heat or insulate the tubing. However, you may use a total length of laboratory exhaust tubing up to 10 m, or up to 15 m for samples not involving PM measurement, if you insulate and/or heat the tubing to minimize the temperature difference between the exhaust gas and the whole tubing wall over the course of the emission test. The laboratory exhaust tubing starts at the end of the vehicle's tailpipe and ends at the first sample point or the first

dilution point. The laboratory exhaust tubing may include flexible sections, but we recommend that you limit the amount of flexible tubing to the extent practicable. For multiple-tailpipe configurations where the tailpipes combine into a single flow path for emission sampling, the start of the laboratory exhaust tubing may be taken at the last joint where the exhaust flow first becomes a single, combined flow.

(ii) For vehicles above 14,000 pounds GVWR, you may shorten the tailpipe up to the outlet of the last aftertreatment device or silencer, whichever is furthest downstream.

\* \* \* \* \*

(vii) Electrically ground the entire exhaust system, with the exception of nonconductive flexible tubing, as allowed under paragraph (b)(1)(iv) of this section.

(2) \* \* \*

(i) \* \* \*

(B) You may sample background PM from the dilution tunnel at any time before or after an emission test using the same sampling system used during the emission test. For this background sampling, the dilution tunnel blower must be turned on, the vehicle must be disconnected from the laboratory exhaust tubing, and the laboratory exhaust tubing must be capped. You may run this PM blank test in combination with the dilute exhaust flow verification (propane check) in 40 CFR 1065.341, as long as the exhaust tubing inlet to the CVS has a filter meeting the requirements of 40 CFR 1065.140(b)(3).

\* \* \* \* \*

(iii) \* \* \*

(C) You may use a higher target filter face velocity as specified in 40 CFR 1065.170(c)(1)(vi), up to 140 cm/s, if you need to increase filter loading for PM measurement.

\* \* \* \* \*

(c) The following table summarizes the requirements of paragraph (b)(2) of this section:

TABLE 1 OF § 1066.110—SUMMARY OF EQUIPMENT SPECIFICATIONS FROM 40 CFR PART 1065, SUBPART B, THAT APPLY FOR CHASSIS TESTING

40 CFR part 1065 references	Applicability for chassis testing under this part
40 CFR 1065.140 .....	Use all except as noted: 40 CFR 1065.140(b) applies as described in this section. Use 40 CFR 1065.140(c)(6), with the additional allowance described in this section. Do not use 40 CFR 1065.140(d)(2)(iv). Use 40 CFR 1065.140(e)(1) as described in this section. Do not use 40 CFR 1065.140(e)(2).
40 CFR 1065.145 .....	Use all except 40 CFR 1065.145(b).
40 CFR 1065.150 .....	Use all.

TABLE 1 OF § 1066.110—SUMMARY OF EQUIPMENT SPECIFICATIONS FROM 40 CFR PART 1065, SUBPART B, THAT APPLY FOR CHASSIS TESTING—Continued

40 CFR part 1065 references	Applicability for chassis testing under this part
40 CFR 1065.170 .....	Use all except as noted: Use 40 CFR 1065.170(c)(1)(vi) as described in this section.
40 CFR 1065.190 .....	Use all.

■ 286. Section 1066.135 is amended by revising paragraph (d)(1) to read as follows:

**§ 1066.135 Linearity verification.**

\* \* \* \* \*

(d) \* \* \*

(1) Raw exhaust static pressure control.

\* \* \* \* \*

■ 287. Section 1066.140 is amended as follows:

■ a. By revising paragraphs (e), (f)(6)(i), (f)(8), (f)(13), (g)(6)(i), (g)(11), (h) introductory text, (h)(6)(i), (h)(7), (h)(9), and (h)(10).

■ b. By redesignating paragraph (j) as paragraph (i).

■ c. By revising Figure 1.

The revisions read as follows:

**§ 1066.140 Diluted exhaust flow calibration.**

\* \* \* \* \*

(e) *Configuration*. Calibrate the system with any upstream screens or other restrictions that will be used during testing and that could affect the flow ahead of the flow meter. You may not use any upstream screen or other restriction that could affect the flow ahead of the reference flow meter, unless the flow meter has been calibrated with such a restriction.

(f) \* \* \*

(6) \* \* \*

(i) The mean flow rate of the reference flow meter,  $\bar{V}_{ref}$ . This may include several measurements of different quantities, such as reference meter pressures and temperatures, for calculating  $\bar{V}_{ref}$ .

\* \* \* \* \*

(8) Repeat the steps in paragraphs (f)(6) and (7) of this section to record data at a minimum of six restrictor positions ranging from the wide-open restrictor position to the minimum expected pressure at the PDP inlet or the maximum expected differential (outlet minus inlet) pressure across the PDP during testing.

\* \* \* \* \*

(13) During emission testing ensure that the PDP is not operated either below the lowest inlet pressure point or above the highest differential pressure point in the calibration data.

(g) \* \* \*

(6) \* \* \*

(i) The mean flow rate of the reference flow meter,  $\bar{V}_{ref}$ . This may include several measurements of different quantities for calculating  $\bar{V}_{ref}$ , such as reference meter pressures and temperatures.

\* \* \* \* \*

(11) Use the SSV only between the minimum and maximum calibrated  $Re^{\#}$ . If you want to use the SSV at a lower

or higher  $Re^{\#}$ , you must recalibrate the SSV.

\* \* \* \* \*

(h) *CFV calibration*. The calibration procedure described in this paragraph (h) establishes the value of the calibration coefficient,  $K_v$ , at measured values of pressure, temperature and air flow. Calibrate the CFV up to the highest expected pressure ratio,  $r$ , according to § 1066.625. Calibrate the CFV as follows:

(6) \* \* \*

(i) The mean flow rate of the reference flow meter,  $\bar{V}_{ref}$ . This may include several measurements of different quantities, such as reference meter pressures and temperatures, for calculating  $\bar{V}_{ref}$ .

\* \* \* \* \*

(7) Incrementally close the restrictor valve or decrease the downstream pressure to decrease the differential pressure across the CFV,  $\Delta p_{CFV}$ .

\* \* \* \* \*

(9) Determine  $K_v$  and the highest allowable pressure ratio,  $r$ , according to § 1066.625.

(10) Use  $K_v$  to determine CFV flow during an emission test. Do not use the CFV above the highest allowed  $r$ , as determined in § 1066.625.

\* \* \* \* \*

Figure 1 of § 1066.140—CVS calibration configurations

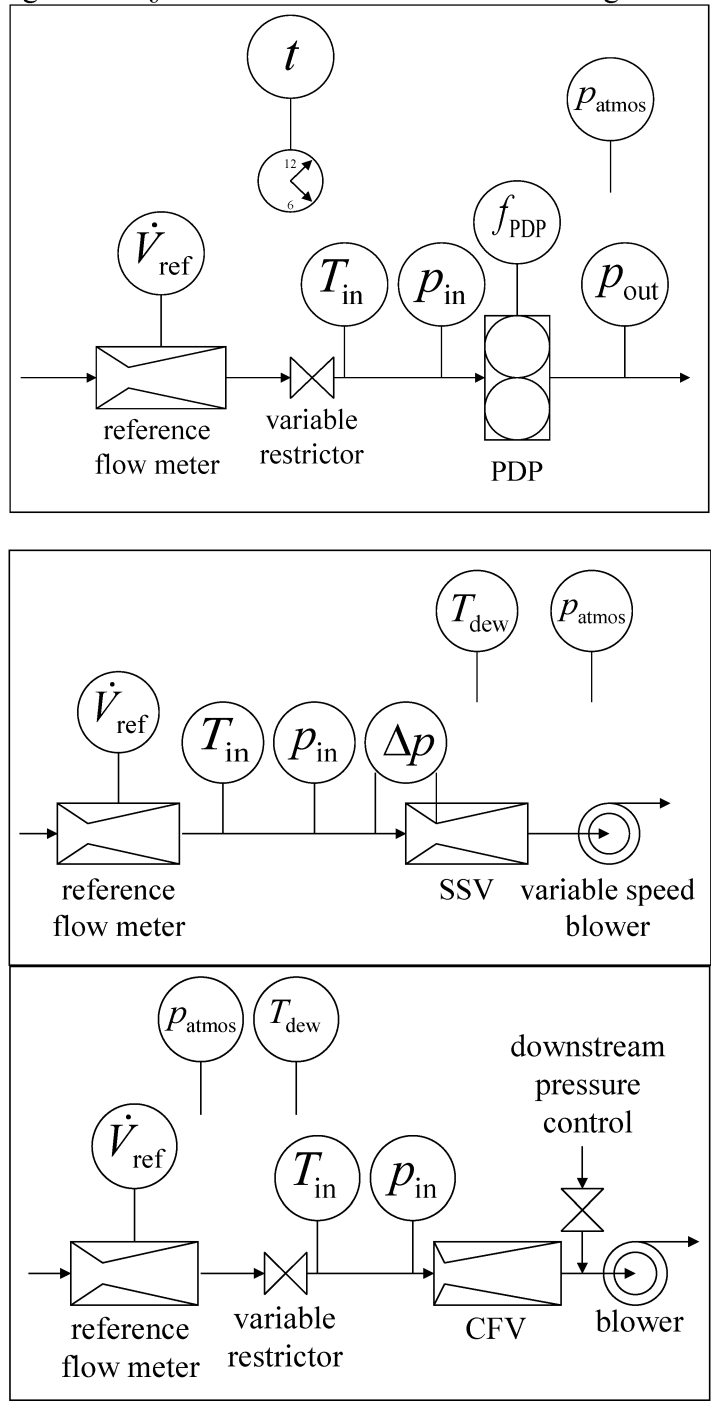

**Subpart C—Dynamometer Specifications**

■ 288. Section 1066.210 is amended by revising paragraph (d)(3) to read as follows:

**§ 1066.210 Dynamometers.**

\* \* \* \* \*

(d) \* \* \*

(3) The load applied by the dynamometer simulates forces acting on

the vehicle during normal driving according to the following equation:

$$FR_i = A \cdot \frac{100}{\sqrt{100^2 + G_i^2}} + B \cdot v_i + C \cdot v_i^2 + M_e \cdot \frac{v_i - v_{i-1}}{t_i - t_{i-1}} + M \cdot a_g \cdot \frac{G_i}{\sqrt{100^2 + G_i^2}}$$

Eq. 1066.210-1

Where:

*FR* = total road-load force to be applied at the surface of the roll. The total force is the sum of the individual tractive forces applied at each roll surface.

*i* = a counter to indicate a point in time over the driving schedule. For a dynamometer operating at 10 Hz intervals over a 600 second driving schedule, the maximum value of *i* should be 6,000.

*A* = a vehicle-specific constant value representing the vehicle's frictional load in lbf or newtons. See subpart D of this part.

*G<sub>i</sub>* = instantaneous road grade, in percent. If your duty cycle is not subject to road grade, set this value to 0.

*B* = a vehicle-specific coefficient representing load from drag and rolling resistance, which are a function of vehicle speed, in

lbf/(mi/hr) or N·s/m. See subpart D of this part.

*v* = instantaneous linear speed at the roll surfaces as measured by the dynamometer, in mi/hr or m/s. Let *v<sub>i-1</sub>* = 0 for *i* = 0.

*C* = a vehicle-specific coefficient representing aerodynamic effects, which are a function of vehicle speed squared, in lbf/(mi/hr)<sup>2</sup> or N·s<sup>2</sup>/m<sup>2</sup>. See subpart D of this part.

*M<sub>e</sub>* = the vehicle's effective mass in lbm or kg, including the effect of rotating axles as specified in § 1066.310(b)(7).

*t* = elapsed time in the driving schedule as measured by the dynamometer, in seconds. Let *t<sub>i-1</sub>* = 0 for *i* = 0.

*M* = the measured vehicle mass, in lbm or kg.

*a<sub>g</sub>* = acceleration of Earth's gravity, as described in 40 CFR 1065.630.

■ 289. Section 1066.235 is amended by revising paragraphs (c)(1)(i) and (c)(2)(i) to read as follows:

**§ 1066.235 Speed verification procedure.**

\* \* \* \* \*

(c) \* \* \*

(1) \* \* \*

(i) Set the dynamometer to speed-control mode. Set the dynamometer speed to a value of approximately 4.5 m/s (10 mi/hr); record the output of the frequency counter after 10 seconds. Determine the roll speed, *v<sub>act</sub>*, using the following equation:

$$v_{act} = \frac{f \cdot d_{roll} \cdot \pi}{n}$$

Eq. 1066.235-1

Where:

*f* = frequency of the dynamometer speed sensing device, accurate to at least four significant figures.

*d<sub>roll</sub>* = nominal roll diameter, accurate to the nearest 1.0 mm, consistent with § 1066.225(d).

*n* = the number of pulses per revolution from the dynamometer roll speed sensor.

Example:

*f* = 2.9231 Hz = 2.9231 s<sup>-1</sup>

*d<sub>roll</sub>* = 904.40 mm = 0.90440 m

$$v_{act} = \frac{2.9231 \cdot 0.90440 \cdot \pi}{1}$$

*v<sub>act</sub>* = 8.3053 m/s

\* \* \* \* \*

(2) \* \* \*

(i) Set the dynamometer to speed-control mode. Set the dynamometer speed to a speed value of approximately 4.5 m/s (10 mi/hr). Tune the stroboscope or photo tachometer until the signal matches the dynamometer roll speed. Record the frequency. Determine the roll speed, *v<sub>act</sub>*, using Eq. 1066.235-1, using the stroboscope or photo tachometer's frequency for *f*.

\* \* \* \* \*

■ 290. Section 1066.245 is amended by revising paragraph (c) introductory text to read as follows:

**§ 1066.245 Response time verification.**

\* \* \* \* \*

(c) *Procedure.* Use the dynamometer's automated process to verify response time. You may perform this test either

at two different inertia settings corresponding approximately to the minimum and maximum vehicle weights you expect to test or using base inertia and two acceleration rates that cover the range of acceleration rates experienced during testing (such as 0.5 and 8 (mi/hr)/s). Use good engineering judgment to select road-load coefficients representing vehicles of the appropriate weight. Determine the dynamometer's settling response time, *t<sub>s</sub>*, based on the point at which there are no measured results more than 10% above or below the final equilibrium value, as illustrated in Figure 1 of this section. The observed settling response time must be less than 100 milliseconds for each inertia setting. Figure 1 follows:

\* \* \* \* \*

■ 291. Section 1066.250 is amended by revising paragraphs (c)(1), (c)(2), and (c)(5) to read as follows:

**§ 1066.250 Base inertia verification.**

\* \* \* \* \*

(c) \* \* \*

(1) Warm up the dynamometer according to the dynamometer manufacturer's instructions. Set the dynamometer's road-load inertia to zero, turning off any electrical simulation of road load and inertia so that the base inertia of the dynamometer is the only inertia present. Motor the rolls to 5 mi/hr. Apply a constant force to accelerate the roll at a nominal rate of 1 (mi/hr)/s. Measure the elapsed time to accelerate from 10 to 40 mi/hr, noting the corresponding speed and time points to the nearest 0.01 mi/hr and 0.01 s. Also determine mean force over the measurement interval.

(2) Starting from a steady roll speed of 45 mi/hr, apply a constant force to the roll to decelerate the roll at a nominal rate of 1 mi/hr/s. Measure the elapsed time to decelerate from 40 to 10 mi/hr, noting the corresponding speed and time points to the nearest 0.01 mi/hr and 0.01 s. Also determine mean force over the measurement interval.

\* \* \* \* \*

(5) Determine the base inertia,  $I_b$ , for each measurement interval using the following equation:

$$I_b = \frac{\bar{F}}{\left| \frac{v_{\text{final}} - v_{\text{init}}}{\Delta t} \right|}$$

Eq. 1066.250-1

Where:

$\bar{F}$  = mean dynamometer force over the measurement interval as measured by the dynamometer.

$v_{\text{final}}$  = roll surface speed at the end of the measurement interval to the nearest 0.01 mi/hr.

$v_{\text{init}}$  = roll surface speed at the start of the measurement interval to the nearest 0.01 mi/hr.

$\Delta t$  = elapsed time during the measurement interval to the nearest 0.01 s.

Example:

$\bar{F}$  = 1.500 lbf = 48.26 ft·lbf/s<sup>2</sup>  
 $v_{\text{final}}$  = 40.00 mi/hr = 58.67 ft/s  
 $v_{\text{init}}$  = 10.00 mi/hr = 14.67 ft/s  
 $\Delta t$  = 30.00 s

$$I_b = \frac{48.26}{\left| \frac{58.67 - 14.67}{30.00} \right|}$$

$I_b$  = 32.90 lbfm

\* \* \* \* \*

■ 292. Section 1066.260 is amended by revising paragraphs (c)(3) and (4) to read as follows:

**§ 1066.260 Parasitic friction compensation evaluation.**

\* \* \* \* \*

(c) \* \* \*

(3) Set the dynamometer inertia to the base inertia with the road-load coefficients A, B, and C set to 0. Set the dynamometer to speed-control mode with a target speed of 50 mi/hr or a higher speed recommended by the dynamometer manufacturer. Once the speed stabilizes at the target speed, switch the dynamometer from speed-control to torque-control and allow the roll to coast for 60 seconds. Record the initial and final speeds and the corresponding start and stop times. If friction compensation is executed

perfectly, there will be no change in speed during the measurement interval.

(4) Calculate the power equivalent of friction compensation error,  $FC_{\text{error}}$ , using the following equation:

$$FC_{\text{error}} = \frac{I}{2 \cdot t} \cdot (v_{\text{init}}^2 - v_{\text{final}}^2)$$

Eq. 1066.260-1

Where:

$I$  = dynamometer inertia setting.

$t$  = duration of the measurement interval, accurate to at least 0.01 s.

$v_{\text{init}}$  = the roll speed corresponding to the start of the measurement interval, accurate to at least 0.05 mi/hr.

$v_{\text{final}}$  = the roll speed corresponding to the end of the measurement interval, accurate to at least 0.05 mi/hr.

Example:

$I$  = 2000 lbfm = 62.16 lbf·s<sup>2</sup>/ft  
 $t$  = 60.0 s  
 $v_{\text{init}}$  = 9.2 mi/hr = 13.5 ft/s  
 $v_{\text{final}}$  = 10.0 mi/hr = 14.7 ft/s

$$FC_{\text{error}} = \frac{62.16}{2 \cdot 60.00} \cdot (13.5^2 - 14.7^2)$$

$FC_{\text{error}}$  = -16.5 ft·lbf/s = -0.031 hp

\* \* \* \* \*

■ 293. Section 1066.265 is amended by revising paragraphs (c) and (d) to read as follows:

**§ 1066.265 Acceleration and deceleration verification.**

\* \* \* \* \*

(c) *Verification of acceleration and deceleration rates.* Activate the dynamometer's function generator for measuring roll revolution frequency. If the dynamometer has no such function generator, set up a properly calibrated external function generator consistent with the verification described in this paragraph (c). Use the function generator to determine actual acceleration and deceleration rates as the dynamometer traverses speeds between 10 and 40 mi/hr at various nominal acceleration and deceleration rates. Verify the dynamometer's acceleration and deceleration rates as follows:

(1) Set up start and stop frequencies specific to your dynamometer by identifying the roll-revolution frequency,  $f$ , in revolutions per second (or Hz) corresponding to 10 mi/hr and 40 mi/hr vehicle speeds, accurate to at least four significant figures, using the following equation:

$$f = \frac{v \cdot n}{d_{\text{roll}} \cdot \pi}$$

Eq. 1066.265-1

Where:

$v$  = the target roll speed, in inches per second (corresponding to drive speeds of 10 mi/hr or 40 mi/hr).

$n$  = the number of pulses from the dynamometer's roll-speed sensor per roll revolution.

$d_{\text{roll}}$  = roll diameter, in inches.

(2) Program the dynamometer to accelerate the roll at a nominal rate of 1 mi/hr/s from 10 mi/hr to 40 mi/hr. Measure the elapsed time to reach the target speed, to the nearest 0.01 s. Repeat this measurement for a total of five runs. Determine the actual acceleration rate for each run,  $a_{\text{act}}$ , using the following equation:

$$a_{\text{act}} = \frac{v_{\text{final}} - v_{\text{init}}}{t}$$

Eq. 1066.265-2

Where:

$a_{\text{act}}$  = acceleration rate (decelerations have negative values).

$v_{\text{final}}$  = the target value for the final roll speed.

$v_{\text{init}}$  = the setpoint value for the initial roll speed.

$t$  = time to accelerate from  $v_{\text{init}}$  to  $v_{\text{final}}$ .

Example:

$v_{\text{final}}$  = 40 mi/hr  
 $v_{\text{init}}$  = 10 mi/hr  
 $t$  = 30.003 s

$$a_{\text{act}} = \frac{40.00 - 10.00}{30.03}$$

$a_{\text{act}}$  = 0.999 (mi/hr)/s

(3) Program the dynamometer to decelerate the roll at a nominal rate of 1 (mi/hr)/s from 40 mi/hr to 10 mi/hr. Measure the elapsed time to reach the target speed, to the nearest 0.01 s. Repeat this measurement for a total of five runs. Determine the actual acceleration rate,  $a_{\text{act}}$ , using Eq. 1066.265-2.

(4) Repeat the steps in paragraphs (c)(2) and (3) of this section for additional acceleration and deceleration rates in 1 (mi/hr)/s increments up to and including one increment above the maximum acceleration rate expected during testing. Average the five repeat runs to calculate a mean acceleration rate,  $\bar{a}_{\text{act}}$ , at each setting.

(5) Compare each mean acceleration rate,  $\bar{a}_{\text{act}}$ , to the corresponding nominal acceleration rate,  $a_{\text{ref}}$ , to determine values for acceleration error,  $a_{\text{error}}$ , using the following equation:

$$a_{\text{error}} = \frac{\bar{a}_{\text{act}} - a_{\text{ref}}}{a_{\text{ref}}} \cdot 100 \%$$

Eq. 1066.265-3

Example:

$$\bar{a}_{act} = 0.999 \text{ (mi/hr)/s}$$

$$a_{ref} = 1 \text{ (mi/hr)/s}$$

$$a_{error} = \frac{0.999 - 1}{1} \cdot 100 \%$$

$$a_{error} = -0.100 \%$$

(d) *Verification of forces for controlling acceleration and deceleration.* Program the dynamometer with a calculated force value and determine actual acceleration and deceleration rates as the dynamometer traverses speeds between 10 and 40 mi/hr at various nominal acceleration and deceleration rates. Verify the dynamometer's ability to achieve certain acceleration and deceleration rates with a given force as follows:

(1) Calculate the force setting,  $F$ , using the following equation:

$$F = I_b \cdot |a|$$

Eq. 1066.265-4

Where:

$I_b$  = the dynamometer manufacturer's stated base inertia, in lbf·s<sup>2</sup>/ft.

$a$  = nominal acceleration rate, in ft/s<sup>2</sup>.

*Example:*

$$I_b = 2967 \text{ lbf} = 92.217 \text{ lbf} \cdot \text{s}^2/\text{ft}$$

$$a = 1 \text{ (mi/hr)/s} = 1.4667 \text{ ft/s}^2$$

$$F = 92.217 \cdot 1.4667$$

$$F = 135.25 \text{ lbf}$$

(2) Set the dynamometer to road-load mode and program it with a calculated force to accelerate the roll at a nominal rate of 1 (mi/hr)/s from 10 mi/hr to 40 mi/hr. Measure the elapsed time to reach the target speed, to the nearest 0.01 s. Repeat this measurement for a total of five runs. Determine the actual acceleration rate,  $a_{act}$ , for each run using Eq. 1066.265-2. Repeat this step to determine measured "negative acceleration" rates using a calculated force to decelerate the roll at a nominal rate of 1 (mi/hr)/s from 40 mi/hr to 10 mi/hr. Average the five repeat runs to calculate a mean acceleration rate,  $\bar{a}_{act}$ , at each setting.

(3) Repeat the steps in paragraph (d)(2) of this section for additional acceleration and deceleration rates as specified in paragraph (c)(4) of this section.

(4) Compare each mean acceleration rate,  $\bar{a}_{act}$ , to the corresponding nominal acceleration rate,  $\bar{a}_{ref}$ , to determine values for acceleration error,  $\bar{a}_{error}$ , using Eq. 1066.265-3.

\* \* \* \* \*

■ 294. Section 1066.270 is amended by revising paragraphs (c)(2), (c)(4), (c)(6) and (d)(1) to read as follows:

**§ 1066.270 Unloaded coastdown verification.**

\* \* \* \* \*

(c) \* \* \*

(2) With the dynamometer in coastdown mode, set the dynamometer inertia for the smallest vehicle weight that you expect to test and set A, B, and C road-load coefficients to values typical of those used during testing. Program the dynamometer to coast down over the dynamometer operational speed range (typically from a speed of 80 mi/hr through a minimum speed at or below 10 mi/hr). Perform at least one coastdown run over this speed range, collecting data over each 10 mi/hr interval.

\* \* \* \* \*

(4) Determine the average coastdown force,  $\bar{F}$ , for each speed and inertia setting for each of the coastdowns performed using the following equation:

$$\bar{F} = \frac{I \cdot (v_{init} - v_{final})}{t}$$

Eq. 1066.270-1

Where:

$\bar{F}$  = the mean force measured during the coastdown for each speed interval and inertia setting, expressed in lbf·s<sup>2</sup>/ft and rounded to four significant figures.

$I$  = the dynamometer's inertia setting, in lbf·s<sup>2</sup>/ft.

$v_{init}$  = the speed at the start of the coastdown interval, expressed in ft/s to at least four significant figures.

$v_{final}$  = the speed at the end of the coastdown interval, expressed in ft/s to at least four significant figures.

$t$  = coastdown time for each speed interval and inertia setting, accurate to at least 0.01 s.

*Example:*

$$I = 2000 \text{ lbf} = 62.16 \text{ lbf} \cdot \text{s}^2/\text{ft}$$

$$v_{init} = 25 \text{ mi/hr} = 36.66 \text{ ft/s}$$

$$v_{final} = 15 \text{ mi/hr} = 22.0 \text{ ft/s}$$

$$t = 5.00 \text{ s}$$

$$\bar{F} = \frac{62.16 \cdot (36.66 - 22.0)}{5.00}$$

$$\bar{F} = 182.2 \text{ lbf}$$

\* \* \* \* \*

(6) Compare the mean value of the coastdown force measured for each speed interval and inertia setting,  $\bar{F}_{act}$ , to the corresponding  $F_{ref}$  to determine values for coastdown force error,  $F_{error}$ , using the following equation:

$$F_{error} = \left| \frac{\bar{F}_{act} - F_{ref}}{F_{ref}} \right| \cdot 100$$

Eq. 1066.270-2

*Example:*

$$F_{ref} = 192 \text{ lbf}$$

$$\bar{F}_{act} = 191 \text{ lbf}$$

$$F_{error} = \left| \frac{191 - 192}{192} \right| \cdot 100$$

$$F_{error} = 0.5 \%$$

(d) \* \* \*

(1) For vehicles at or below 20,000 pounds GVWR, the maximum allowable error,  $F_{errormax}$ , for all speed intervals and inertia settings is 1.0% or the value determined from Eq. 1066.270-3, whichever is greater.

$$F_{errormax} = \frac{2.2 \text{ lbf}}{F_{ref}} \cdot 100$$

Eq. 1066.270-3

*Example:*

$$F_{ref} = 192 \text{ lbf}$$

$$F_{errormax} = \frac{2.2 \text{ lbf}}{192} \cdot 100$$

$$F_{errormax} = 1.14 \%$$

\* \* \* \* \*

■ 295. Section 1066.275 is amended by revising paragraph (c)(1) to read as follows:

**§ 1066.275 Daily dynamometer readiness verification.**

\* \* \* \* \*

(c) \* \* \*

(1) With the dynamometer in coastdown mode, set the dynamometer inertia to the base inertia with the road-load coefficient A set to 20 lbf (or a force that results in a coastdown time of less than 10 minutes) and coefficients B and C set to 0. Program the dynamometer to coast down for one 10 mi/hr interval from 55 mi/hr down to 45 mi/hr. If your dynamometer is not capable of performing one discrete coastdown, then coast down with preset 10 mi/hr intervals that include a 55 mi/hr to 45 mi/hr interval.

\* \* \* \* \*

**Subpart D—Coastdown**

■ 296. Section 1066.301 is amended by adding introductory text to read as follows:

**§ 1066.301 Overview of road-load determination procedures.**

Vehicle testing on a chassis dynamometer involves simulating the road-load force, which is the sum of forces acting on a vehicle from aerodynamic drag, tire rolling resistance, driveline losses, and other effects of friction. Determine dynamometer settings to simulate road-



load force in two stages. First, perform a road-load force specification by characterizing on-road operation. Second, perform a road-load derivation to determine the appropriate dynamometer load settings to simulate the road-load force specification from the on-road test.

\* \* \* \* \*

■ 297. Section 1066.305 is amended by revising paragraph (a) to read as follows:

**§ 1066.305 Procedures for specifying road-load forces for motor vehicles at or below 14,000 pounds GVWR.**

(a) For motor vehicles at or below 14,000 pounds GVWR, develop representative road-load coefficients to characterize each vehicle covered by a certificate of conformity. Calculate road-load coefficients by performing coastdown tests using the provisions of SAE J1263 and SAE J2263 (incorporated by reference in § 1066.1010). This protocol establishes a procedure for determination of vehicle road load force for speeds between 115 and 15 km/hr (71.5 and 9.3 mi/hr); the final result is a model of road-load force (as a function of speed) during operation on a dry, level road under reference conditions of 20 °C, 98.21 kPa, no wind, no precipitation, and the transmission in neutral. You may use other methods that are equivalent to SAE J2263, such as equivalent test procedures or analytical modeling, to characterize road load using good engineering judgment. Determine dynamometer settings to simulate the road-load profile represented by these road-load target coefficients as described in § 1066.315. Supply representative road-load forces for each vehicle at speeds above 15 km/hr (9.3 mi/hr), and up to 115 km/hr (71.5 mi/hr), or the highest speed from the range of applicable duty cycles.

\* \* \* \* \*

■ 298. Section 1066.310 is amended by revising the introductory text and paragraphs (b)(1)(i), (b)(2), (b)(6), (b)(7)(ii) introductory text, (b)(7)(ii)(A), (b)(7)(ii)(B), (b)(7)(ii)(D), and (b)(7)(ii)(E) to read as follows:

**§ 1066.310 Coastdown procedures for vehicles above 14,000 pounds GVWR.**

This section describes coastdown procedures that are unique to vehicles above 14,000 pounds GVWR. These procedures are valid for calculating road-load coefficients for chassis and post-transmission powerpack testing. These procedures are also valid for calculating drag area ( $C_dA$ ) to demonstrate compliance with Phase 1

greenhouse gas emission standards under 40 CFR part 1037.

\* \* \* \* \*

(b) \* \* \*

(1) \* \* \*

(i) We recommend that you do not perform coastdown testing on days for which winds are forecast to exceed 6.0 mi/hr.

\* \* \* \* \*

(2) Operate the vehicle at a top speed above 70 mi/hr, or at its maximum achievable speed if it cannot reach 70 mi/hr. If a vehicle is equipped with a vehicle speed limiter that is set for a maximum speed below 70 mi/hr, you must disable the vehicle speed limiter. Start the test at or above 70 mi/hr, or at the vehicle's maximum achievable speed if it cannot reach 70 mi/hr. Collect data through a minimum speed at or below 15 mi/hr. Data analysis for valid coastdown runs must include the range of vehicle speeds specified in this paragraph (b)(2).

\* \* \* \* \*

(6) All valid coastdown run times in each direction must be within 2.0 standard deviations of the mean of the valid coastdown run times (from the specified maximum speed down to 15 mi/hr) in that direction. Eliminate runs outside this range. After eliminating these runs you must have at least eight valid runs in each direction. You may use coastdown run times that do not meet these standard deviation requirements if we approve it in advance. In your request, describe why the vehicle is not able to meet the specified standard deviation requirements and propose an alternative set of requirements.

(7) \* \* \*

(ii) Determine drag area,  $C_dA$ , as follows instead of using the procedure specified in Section 10 of SAE J1263:

(A) Measure vehicle speed at fixed intervals over the coastdown run (generally at 10 Hz), including speeds at or above 15 mi/hr and at or below the specified maximum speed. Establish the elevation corresponding to each interval as described in SAE J2263 if you need to incorporate the effects of road grade.

(B) Calculate the vehicle's effective mass,  $M_e$ , in kg by adding 56.7 kg to the measured vehicle mass,  $M$ , for each tire making road contact. This accounts for the rotational inertia of the wheels and tires.

\* \* \* \* \*

(D) Plot the data from all the coastdown runs on a single plot of  $F_i$  vs.  $v_i^2$  to determine the slope correlation,  $D$ , based on the following equation:

$$F_i - M \cdot a_g \cdot \frac{\Delta h}{\Delta s} = A_m + D \cdot v_i^2$$

Eq. 1066.310-2

Where:

$M$  = the measured vehicle mass, expressed to at least the nearest 0.1 kg.

$a_g$  = acceleration of Earth's gravity, as described in 40 CFR 1065.630.

$\Delta h$  = change in elevation over the measurement interval, in m. Assume  $\Delta h = 0$  if you are not correcting for grade.

$\Delta s$  = distance the vehicle travels down the road during the measurement interval, in m.

$A_m$  = the calculated value of the y-intercept based on the curve-fit.

(E) Calculate drag area,  $C_dA$ , in  $m^2$  using the following equation:

$$C_dA = \frac{2 \cdot D_{adj}}{\rho}$$

Eq. 1066.310-3

Where:

$\rho$  = air density at reference conditions = 1.17  $kg/m^3$ .

$$D_{adj} = D \cdot \left( \frac{\bar{T}}{293} \right) \cdot \left( \frac{98.21}{\bar{P}_{act}} \right)$$

Eq. 1066.310-4

$\bar{T}$  = mean ambient absolute temperature during testing, in K.

$\bar{P}_{act}$  = mean ambient pressuring during the test, in kPa.

\* \* \* \* \*

**Subpart E—Preparing Vehicles and Running an Exhaust Emission Test**

■ 299. Section 1066.410 is amended by revising paragraphs (c) and (h) introductory text to read as follows:

**§ 1066.410 Dynamometer test procedure.**

\* \* \* \* \*

(c) Record the vehicle's speed trace based on the time and speed data from the dynamometer at the recording frequencies given in Table 1 of § 1066.125. Record speed to at least the nearest 0.01 mi/hr and time to at least the nearest 0.1 s.

\* \* \* \* \*

(h) Determine equivalent test weight as follows:

\* \* \* \* \*

■ 300. Section 1066.415 is amended by revising paragraph (e)(6)(ii) to read as follows:

**§ 1066.415 Vehicle operation.**

- \* \* \* \*
- (e) \* \* \*
- (6) \* \* \*

(ii) For vehicles with manual transmission, shift gears in a way that represents reasonable shift patterns for in-use operation, considering vehicle speed, engine speed, and any other relevant variables. Disengage the clutch when the speed drops below 15 mi/hr, when engine roughness is evident, or when good engineering judgment indicates the engine is likely to stall. Manufacturers may recommend shift guidance in the owners manual that differs from the shift schedule used during testing, as long as both shift schedules are described in the application for certification; in this case, we may shift during testing as described in the owners manual.

■ 301. Section 1066.425 is amended by revising paragraphs (b)(1), (2), and (3) to read as follows:

**§ 1066.425 Performing emission tests.**

- \* \* \* \*
- (b) \* \* \*

(1) The upper limit is 2.0 mi/hr higher than the highest point on the trace within 1.0 s of the given point in time.

(2) The lower limit is 2.0 mi/hr lower than the lowest point on the trace within 1.0 s of the given time.

(3) The same limits apply for vehicle operation without exhaust measurements, such as vehicle preconditioning and warm-up, except that the upper and lower limits for speed values are ±4.0 mi/hr. In addition, up to three occurrences of speed variations greater than the tolerance are

acceptable for vehicle operation in which no exhaust emission standards apply, as long as they occur for less than 15 seconds on any occasion and are clearly documented as to the time and speed at that point of the driving schedule.

\* \* \* \*

**Subpart G—Calculations**

■ 302. Section 1066.605 is amended by revising paragraphs (c) introductory text and (d) through (g) and adding paragraph (h) to read as follows:

**§ 1066.605 Mass-based and molar-based exhaust emission calculations.**

\* \* \* \*

(c) Perform the following sequence of preliminary calculations to correct recorded concentration measurements before calculating mass emissions in paragraphs (e) and (f) of this section:

\* \* \* \*

(d) Calculate g/mile emission rates using the following equation unless the standard-setting part specifies otherwise:

$$e_{[emission]} = \frac{m_{[emission]}}{D}$$

Eq. 1066.605-1

Where:

$e_{[emission]}$  = emission rate over the test interval.

$m_{[emission]}$  = emission mass over the test interval.

$D$  = the measured driving distance over the test interval.

Example:  
 $m_{NOx} = 0.3177$  g

$D_{HFET} = 10.19$  miles

$$e_{NOx} = \frac{0.3177}{10.19} = 0.0312 \text{ g/mi}$$

(e) Calculate the emission mass of each gaseous pollutant using the following equation:

$$m_{[emission]} = V_{mix} \cdot \rho_{[emission]} \cdot X_{[emission]} \cdot c$$

Eq. 1066.605-2

Where:

$m_{[emission]}$  = emission mass over the test interval.

$V_{mix}$  = total dilute exhaust volume over the test interval, corrected to standard reference conditions, and corrected for any volume removed for emission sampling and for any volume change from adding secondary dilution air.

$\rho_{[emission]}$  = density of the appropriate chemical species as given in § 1066.1005(f).

$X_{[emission]}$  = measured emission concentration in the sample, after dry-to-wet and background corrections.

$c = 10^{-2}$  for emission concentrations in %, and  $10^{-6}$  for emission concentrations in ppm.

Example:

$V_{mix} = 170.878$  m<sup>3</sup> (from paragraph (f) of this section)

$\rho_{NOx} = 1913$  g/m<sup>3</sup>

$X_{NOx} = 0.9721$  ppm

$c = 10^{-6}$

$m_{NOx} = 170.878 \cdot 1913 \cdot 0.9721 \cdot 10^{-6} = 0.3177$  g

(f) Calculation of the emission mass of PM,  $m_{PM}$ , is dependent on how many PM filters you use, as follows:

(1) Except as otherwise specified in this paragraph (f), calculate  $m_{PM}$  using the following equation:

$$m_{PM} = \left( \frac{V_{mix}}{V_{PMstd} - V_{sdastd}} \right) \cdot (m_{PMfil} - m_{PMbknd})$$

Eq. 1066.605-3

Where:

$m_{PM}$  = mass of particulate matter emissions over the test interval, as described in § 1066.815(b)(1), (2), and (3).

$V_{mix}$  = total dilute exhaust volume over the test interval, corrected to standard reference conditions, and corrected for any volume removed for emission sampling and for any volume change from adding secondary dilution air. For partial-flow dilution systems, set  $V_{mix}$  equal to the total exhaust volume over

the test interval, corrected to standard reference conditions.

$V_{PMstd}$  = total volume of dilute exhaust sampled through the filter over the test interval, corrected to standard reference conditions.

$V_{sdastd}$  = total volume of secondary dilution air sampled through the filter over the test interval, corrected to standard reference conditions. For partial-flow dilution systems, set  $V_{sdastd}$  equal to total dilution air volume over the test interval, corrected to standard reference conditions.

$m_{PMfil}$  = mass of particulate matter emissions on the filter over the test interval.

$m_{PMbknd}$  = mass of particulate matter on the background filter.

Example:

$V_{mix} = 170.878$  m<sup>3</sup> (from paragraph (g) of this section)

$V_{PMstd} = 0.925$  m<sup>3</sup> (from paragraph (g) of this section)

$V_{sdastd} = 0.527$  m<sup>3</sup> (from paragraph (g) of this section)

$m_{PMfil} = 0.0000045$  g

$m_{PMbknd} = 0.0000014$  g

$$m_{PM} = \left( \frac{170.878}{0.925 - 0.527} \right) \cdot (0.0000045 - 0.0000014) = 0.00133 \text{ g}$$

(2) If you sample PM onto a single filter as described in § 1066.815(b)(4)(i) or (b)(4)(ii) (for constant volume

samplers), calculate  $m_{PM}$  using the following equation:

$$m_{PM} = \left( \frac{V_{mix}}{\left( \frac{V_{ct-PMstd} - V_{ct-sdastd}}{0.43} \right) + (V_{s-PMstd} - V_{s-sdastd}) + \left( \frac{V_{ht-PMstd} - V_{ht-sdastd}}{0.57} \right)} \right) \cdot (m_{PMfil} - m_{PMbkgnd})$$

Eq. 1066.605-4

Where:

$m_{PM}$  = mass of particulate matter emissions over the entire FTP.

$V_{mix}$  = total dilute exhaust volume over the test interval, corrected to standard reference conditions, and corrected for any volume removed for emission sampling and for any volume change from adding secondary dilution air.

$V_{[interval]-PMstd}$  = total volume of dilute exhaust sampled through the filter over the test interval (ct = cold transient, s =

stabilized, ht = hot transient), corrected to standard reference conditions.

$V_{[interval]-sdastd}$  = total volume of secondary dilution air sampled through the filter over the test interval (ct = cold transient, s = stabilized, ht = hot transient), corrected to standard reference conditions.

$m_{PMfil}$  = mass of particulate matter emissions on the filter over the test interval.

$m_{PMbkgnd}$  = mass of particulate matter on the background filter over the test interval.

*Example:*

$V_{mix} = 633.691 \text{ m}^3$

$V_{ct-PMstd} = 0.925 \text{ m}^3$

$V_{ct-sdastd} = 0.527 \text{ m}^3$

$V_{s-PMstd} = 1.967 \text{ m}^3$

$V_{s-sdastd} = 1.121 \text{ m}^3$

$V_{ht-PMstd} = 1.122 \text{ m}^3$

$V_{ht-sdastd} = 0.639 \text{ m}^3$

$m_{PMfil} = 0.0000106 \text{ g}$

$m_{PMbkgnd} = 0.0000014 \text{ g}$

$$m_{PM} = \left( \frac{633.691}{\left( \frac{0.925 - 0.527}{0.43} \right) + (1.967 - 1.121) + \left( \frac{1.122 - 0.639}{0.57} \right)} \right) \cdot (0.0000106 - 0.0000014)$$

$m_{PM} = 0.00222 \text{ g}$

(3) If you sample PM onto a single filter as described in § 1066.815(b)(4)(ii) (for partial flow dilution systems),

calculate  $m_{PM}$  using the following equation:

$$m_{PM} = \left( \frac{\frac{0.43 \cdot V_{ct-exhstd}}{V_{ct-PMstd} - V_{ct-dilstd}} + \frac{V_{s-exhstd}}{V_{s-PMstd} - V_{s-dilstd}} + \frac{0.57 \cdot V_{ht-exhstd}}{V_{ht-PMstd} - V_{ht-dilstd}}}{3} \right) \cdot (m_{PMfil} - m_{PMbkgnd})$$

Eq. 1066.605-5

Where:

$m_{PM}$  = mass of particulate matter emissions over the entire FTP.

$V_{[interval]-exhstd}$  = total engine exhaust volume over the test interval (ct = cold transient, s = stabilized, ht = hot transient), corrected to standard reference conditions, and corrected for any volume removed for emission sampling.

$V_{[interval]-PMstd}$  = total volume of dilute exhaust sampled through the filter over the test interval (ct = cold transient, s =

stabilized, ht = hot transient), corrected to standard reference conditions.

$V_{[interval]-dilstd}$  = total volume of dilution air over the test interval (ct = cold transient, s = stabilized, ht = hot transient), corrected to standard reference conditions and for any volume removed for emission sampling.

$m_{PMfil}$  = mass of particulate matter emissions on the filter over the test interval.

$m_{PMbkgnd}$  = mass of particulate matter on the background filter over the test interval.

*Example:*

$V_{ct-exhstd} = 5.55 \text{ m}^3$

$V_{ct-PMstd} = 0.526 \text{ m}^3$

$V_{ct-dilstd} = 0.481 \text{ m}^3$

$V_{s-exhstd} = 9.53 \text{ m}^3$

$V_{s-PMstd} = 0.903 \text{ m}^3$

$V_{s-dilstd} = 0.857 \text{ m}^3$

$V_{ht-exhstd} = 5.54 \text{ m}^3$

$V_{ht-PMstd} = 0.527 \text{ m}^3$

$V_{ht-dilstd} = 0.489 \text{ m}^3$

$m_{PMfil} = 0.0000106 \text{ g}$

$m_{PMbkgnd} = 0.0000014 \text{ g}$

$$m_{PM} = \left( \frac{\frac{0.43 \cdot 5.55}{0.526 - 0.481} + \frac{9.53}{0.903 - 0.857} + \frac{0.57 \cdot 5.54}{0.527 - 0.489}}{3} \right) \cdot (0.0000106 - 0.0000014)$$

$m_{PM} = 0.00269 \text{ g}$

(4) If you sample PM onto a single filter as described in § 1066.815(b)(5)(i) or (b)(5)(ii) (for constant volume

samplers), calculate  $m_{PM}$  using the following equation:

$$m_{PM} = \left( \frac{\frac{V_{mix}}{\left(\frac{V_{ct-PMstd} - V_{ct-sdstd}}{0.43}\right) + \left(\frac{V_{cs-PMstd} - V_{cs-sdstd}}{0.57}\right) + \left(\frac{V_{ht-PMstd} - V_{ht-sdstd}}{0.57}\right) + \left(\frac{V_{hs-PMstd} - V_{hs-sdstd}}{0.57}\right)}}{\left(m_{PMfil} - m_{PMbkngnd}\right)} \right)$$

Eq. 1066.605-6

Where:

$m_{PM}$  = mass of particulate matter emissions over the entire FTP.

$V_{mix}$  = total dilute exhaust volume over the test interval, corrected to standard reference conditions, and corrected for any volume removed for emission sampling and for any volume change from secondary dilution air.

$V_{[interval]-PMstd}$  = total volume of dilute exhaust sampled through the filter over the test interval (ct = cold transient, cs = cold

stabilized, ht = hot transient, hs = hot stabilized), corrected to standard reference conditions.

$V_{[interval]-sdstd}$  = total volume of secondary dilution air sampled through the filter over the test interval (ct = cold transient, cs = cold stabilized, ht = hot transient, hs = hot stabilized), corrected to standard reference conditions.

$m_{PMfil}$  = mass of particulate matter emissions on the filter over the test interval.

$m_{PMbkngnd}$  = mass of particulate matter on the background filter over the test interval.

Example:

$V_{mix} = 972.121 \text{ m}^3$

$V_{ct-PMstd} = 0.925 \text{ m}^3$

$V_{ct-sdstd} = 0.529 \text{ m}^3$

$V_{cs-PMstd} = 1.968 \text{ m}^3$

$V_{cs-sdstd} = 1.123 \text{ m}^3$

$V_{ht-PMstd} = 1.122 \text{ m}^3$

$V_{ht-sdstd} = 0.641 \text{ m}^3$

$V_{hs-PMstd} = 1.967 \text{ m}^3$

$V_{hs-sdstd} = 1.121 \text{ m}^3$

$m_{PMfil} = 0.0000229 \text{ g}$

$m_{PMbkngnd} = 0.0000014 \text{ g}$

$$m_{PM} = \left( \frac{\frac{972.121}{\left(\frac{0.925 - 0.529}{0.43}\right) + \left(\frac{1.968 - 1.123}{0.57}\right) + \left(\frac{1.122 - 0.641}{0.57}\right) + \left(\frac{1.967 - 1.121}{0.57}\right)}}{\left(0.0000229 - 0.0000014\right)} \right)$$

$m_{PM} = 0.00401 \text{ g}$

(5) If you sample PM onto a single filter as described in § 1066.815(b)(5)(ii) (for partial flow dilution systems),

calculate  $m_{PM}$  using the following equation:

$$m_{PM} = \left( \frac{0.43 \cdot \left( \frac{V_{ct-exhstd} + V_{cs-exhstd}}{V_{ct-PMstd} - V_{ct-dilstd} + V_{cs-PMstd} - V_{cs-dilstd}} \right) + 0.57 \cdot \left( \frac{V_{ht-exhstd} + V_{hs-exhstd}}{V_{ht-PMstd} - V_{ht-dilstd} + V_{hs-PMstd} - V_{hs-dilstd}} \right)}{2} \right) \cdot (m_{PMfil} - m_{PMbkngnd})$$

Eq. 1066.605-7

Where:

$m_{PM}$  = mass of particulate matter emissions over the entire FTP.

$V_{[interval]-exhstd}$  = total engine exhaust volume over the test interval (ct = cold transient,

cs = cold stabilized, ht = hot transient, hs = hot stabilized), corrected to standard reference conditions, and corrected for any volume removed for emission sampling.

$V_{[interval]-PMstd}$  = total volume of dilute exhaust sampled through the filter over the test interval (ct = cold transient, cs = cold stabilized, ht = hot transient, hs = hot stabilized), corrected to standard reference conditions.

$V_{[\text{interval}]\text{-dilstd}}$  = total volume of dilution air over the test interval (ct = cold transient, cs = cold stabilized, ht = hot transient, hs = hot stabilized), corrected to standard reference conditions and for any volume removed for emission sampling.

$m_{\text{PMfil}}$  = mass of particulate matter emissions on the filter over the test interval.

$m_{\text{PMbkgnd}}$  = mass of particulate matter on the background filter over the test interval.

*Example:*

$V_{\text{ct-exhstd}} = 5.55 \text{ m}^3$   
 $V_{\text{ct-PMstd}} = 0.526 \text{ m}^3$   
 $V_{\text{ct-dilstd}} = 0.481 \text{ m}^3$   
 $V_{\text{cs-exhstd}} = 9.53 \text{ m}^3$   
 $V_{\text{cs-PMstd}} = 0.903 \text{ m}^3$

$V_{\text{cs-dilstd}} = 0.857 \text{ m}^3$

$V_{\text{ht-exhstd}} = 5.54 \text{ m}^3$

$V_{\text{ht-PMstd}} = 0.527 \text{ m}^3$

$V_{\text{ht-dilstd}} = 0.489 \text{ m}^3$

$V_{\text{hs-exhstd}} = 9.54 \text{ m}^3$

$V_{\text{hs-PMstd}} = 0.902 \text{ m}^3$

$V_{\text{hs-dilstd}} = 0.856 \text{ m}^3$

$m_{\text{PMfil}} = 0.0000229 \text{ g}$

$m_{\text{PMbkgnd}} = 0.0000014 \text{ g}$

$$m_{\text{PM}} = \left( \frac{0.43 \cdot \left( \frac{5.55 + 9.53}{0.526 - 0.481 + 0.903 - 0.857} \right) + 0.57 \cdot \left( \frac{5.54 + 9.54}{0.527 - 0.489 + 0.902 - 0.856} \right)}{2} \right) \cdot (0.0000229 - 0.0000014)$$

$m_{\text{PM}} = 0.00266 \text{ g}$

(g) This paragraph (g) describes how to correct flow and flow rates to standard reference conditions and

provides an example for determining  $V_{\text{mix}}$  based on CVS total flow and the removal of sample flow from the dilute exhaust gas. You may use predetermined nominal values for

removed sample volumes, except for flows used for batch sampling.

(1) Correct flow and flow rates to standard reference conditions as needed using the following equation:

$$V_{[\text{flow}]\text{std}} = \frac{V_{[\text{flow}]\text{act}} \cdot p_{\text{in}} \cdot T_{\text{std}}}{p_{\text{std}} \cdot T_{\text{in}}}$$

Eq. 1066.605-8

Where:

$V_{[\text{flow}]\text{std}}$  = total flow volume at the flow meter, corrected to standard reference conditions.

$V_{[\text{flow}]\text{act}}$  = total flow volume at the flow meter at test conditions.

$p_{\text{in}}$  = absolute static pressure at the flow meter inlet, measured directly or

calculated as the sum of atmospheric pressure plus a differential pressure referred to atmospheric pressure.

$T_{\text{std}}$  = standard temperature.

$p_{\text{std}}$  = standard pressure.

$T_{\text{in}}$  = temperature of the dilute exhaust sample at the flow meter inlet.

*Example:*

$V_{\text{PMact}} = 1.071 \text{ m}^3$

$p_{\text{in}} = 101.7 \text{ kPa}$

$T_{\text{std}} = 293.15 \text{ K}$

$p_{\text{std}} = 101.325 \text{ kPa}$

$T_{\text{in}} = 340.5 \text{ K}$

$$V_{\text{PMstd}} = \frac{1.071 \cdot 101.7 \cdot 293.15}{101.325 \cdot 340.5} = 0.925 \text{ m}^3$$

(2) The following example provides a determination of  $V_{\text{mix}}$  based on CVS total flow and the removal of sample flow from one dilute exhaust gas analyzer and one PM sampling system

that is utilizing secondary dilution. Note that your  $V_{\text{mix}}$  determination may vary from Eq. 1066.605-7 based on the number of flows that are removed from your dilute exhaust gas and whether

your PM sampling system is using secondary dilution. For this example,  $V_{\text{mix}}$  is governed by the following equation:

$$V_{\text{mix}} = V_{\text{CVSstd}} + V_{\text{gasstd}} + V_{\text{PMstd}} - V_{\text{sdastd}}$$

Eq. 1066.605-9

Where:

$V_{\text{CVSstd}}$  = total dilute exhaust volume over the test interval at the flow meter, corrected to standard reference conditions.

$V_{\text{gasstd}}$  = total volume of sample flow through the gaseous emission bench over the test interval, corrected to standard reference conditions.

$V_{\text{PMstd}}$  = total volume of dilute exhaust sampled through the filter over the test

interval, corrected to standard reference conditions.

$V_{\text{sdastd}}$  = total volume of secondary dilution air flow sampled through the filter over the test interval, corrected to standard reference conditions.

*Example:*

Using Eq. 1066.605-8:

$V_{\text{CVSstd}} = 170.451 \text{ m}^3$ , where  $V_{\text{CVSact}} = 170.721 \text{ m}^3$ ,  $p_{\text{in}} = 101.7 \text{ kPa}$ , and  $T_{\text{in}} = 294.7 \text{ K}$

Using Eq. 1066.605-8:

$V_{\text{gasstd}} = 0.028 \text{ m}^3$ , where  $V_{\text{gasact}} = 0.033 \text{ m}^3$ ,  $p_{\text{in}} = 101.7 \text{ kPa}$ , and  $T_{\text{in}} = 340.5 \text{ K}$

Using Eq. 1066.605-8:

$V_{\text{PMstd}} = 0.925 \text{ m}^3$ , where  $V_{\text{PMact}} = 1.071 \text{ m}^3$ ,  $p_{\text{in}} = 101.7 \text{ kPa}$ , and  $T_{\text{in}} = 340.5 \text{ K}$

Using Eq. 1066.605-8:

$V_{sdastd} = 0.527 \text{ m}^3$ , where  $V_{sdaact} = 0.531 \text{ m}^3$ ,  
 $p_{in} = 101.7 \text{ kPa}$ , and  $T_{in} = 296.3 \text{ K}$   
 $V_{mix} = 170.451 + 0.028 + 0.925 - 0.527 =$   
 $170.878 \text{ m}^3$

(h) Calculate total flow volume over a test interval,  $V_{[flow]}$ , for a CVS or exhaust gas sampler as follows:

(1) *Varying versus constant flow rates.* The calculation methods depend on differentiating varying and constant flow, as follows:

(i) We consider the following to be examples of varying flows that require

a continuous multiplication of concentration times flow rate: raw exhaust, exhaust diluted with a constant flow rate of dilution air, and CVS dilution with a CVS flow meter that does not have an upstream heat exchanger or electronic flow control.

(ii) We consider the following to be examples of constant exhaust flows: CVS diluted exhaust with a CVS flow meter that has an upstream heat

exchanger, an electronic flow control, or both.

(2) *Continuous sampling.* For continuous sampling, you must frequently record a continuously updated flow signal. This recording requirement applies for both varying and constant flow rates.

(i) *Varying flow rate.* If you continuously sample from a varying exhaust flow rate, calculate  $V_{[flow]}$  using the following equation:

$$V_{[flow]} = \sum_{i=1}^N \dot{Q}_i \cdot \Delta t$$

Eq. 1066.605-10

Where:

$$\Delta t = 1/f_{record}$$

Eq. 1066.605-11

*Example:*

$N = 505$   
 $\dot{Q}_{CVS1} = 0.276 \text{ m}^3/\text{s}$   
 $\dot{Q}_{CVS2} = 0.294 \text{ m}^3/\text{s}$   
 $f_{record} = 1 \text{ Hz}$   
 Using Eq. 1066.605-11,  
 $\Delta t = 1/1 = 1 \text{ s}$   
 $V_{CVS} = (0.276 + 0.294 + \dots + \dot{Q}_{CVSsos}) \cdot 1$   
 $V_{CVS} = 170.721 \text{ m}^3$

(ii) *Constant flow rate.* If you continuously sample from a constant exhaust flow rate, use the same calculation described in paragraph

(h)(2)(i) of this section or calculate the mean flow recorded over the test interval and treat the mean as a batch sample, as described in paragraph (h)(3)(ii) of this section.

(3) *Batch sampling.* For batch sampling, calculate total flow by integrating a varying flow rate or by determining the mean of a constant flow rate, as follows:

(i) *Varying flow rate.* If you proportionally collect a batch sample from a varying exhaust flow rate,

integrate the flow rate over the test interval to determine the total flow from which you extracted the proportional sample, as described in paragraph (h)(2)(i) of this section.

(ii) *Constant flow rate.* If you batch sample from a constant exhaust flow rate, extract a sample at a proportional or constant flow rate and calculate  $V_{[flow]}$  from the flow from which you extract the sample by multiplying the mean flow rate by the time of the test interval using the following equation:

$$V_{[flow]} = \bar{Q} \cdot \Delta t$$

Eq. 1066.605-12

*Example:*

$\bar{Q}_{CVS} = 0.338 \text{ m}^3/\text{s}$   
 $\Delta t = 505 \text{ s}$   
 $V_{CVS} = 0.338 \cdot 505$   
 $V_{CVS} = 170.69 \text{ m}^3$

■ 303. Section 1066.615 is amended by revising paragraph (a)(1) to read as follows:

**§ 1066.615 NO<sub>x</sub> intake-air humidity correction.**

\* \* \* \* \*

(a) \* \* \*

(1) Calculate a humidity correction using a time-weighted mean value for ambient humidity over the test interval. Calculate absolute ambient humidity,  $H$ , using the following equation:

$$H = \frac{1000 \cdot M_{H_2O} \cdot p_d \cdot RH}{M_{air} \cdot (p_{atmos} - p_d \cdot RH)}$$

Eq. 1066.615-1

Where:  
 $M_{H_2O}$  = molar mass of H<sub>2</sub>O.  
 $p_d$  = saturated vapor pressure at the ambient dry bulb temperature.

$RH$  = relative humidity of ambient air  
 $M_{air}$  = molar mass of air.  
 $p_{atmos}$  = atmospheric pressure.  
*Example:*

$M_{H_2O}$  = 18.01528 g/mol  
 $p_d$  = 2.93 kPa  
 $RH$  = 37.5% = 0.375  
 $M_{air}$  = 28.96559 g/mol  
 $p_{atmos}$  = 96.71 kPa

$$H = \frac{1000 \cdot 18.01528 \cdot 2.93 \cdot 0.375}{28.96559 \cdot (96.71 - 2.93 \cdot 0.375)} = 7.14741 \text{ g H}_2\text{O vapor/kg dry air}$$

\* \* \* \* \*  
 ■ 304. Section 1066.625 is amended by revising the introductory text and paragraphs (a)(1), (b) introductory text, (b)(1), (b)(2)(i), (b)(2)(iv)(A) and (D), (b)(2)(v), (vi), and (vii), (b)(2)(xiii), and (c)(1)(i), (ii), and (iii) to read as follows:

**§ 1066.625 Flow meter calibration calculations.**  
 This section describes the calculations for calibrating various flow meters based on mass flow rates. Calibrate your flow meter according to 40 CFR 1065.640 instead if you

calculate emissions based on molar flow rates.  
 (a) \* \* \*  
 (1) Calculate PDP volume pumped per revolution,  $V_{rev}$ , for each restrictor position from the mean values determined in § 1066.140:

$$V_{rev} = \frac{\bar{V}_{ref} \cdot \bar{T}_{in} \cdot P_{std}}{\bar{f}_{nPDP} \cdot \bar{P}_{in} \cdot T_{std}}$$

Eq. 1066.625-1

Where:  
 $\bar{V}_{ref}$  = mean flow rate of the reference flow meter.  
 $\bar{T}_{in}$  = mean temperature at the PDP inlet.  
 $P_{std}$  = standard pressure = 101.325 kPa.  
 $\bar{f}_{nPDP}$  = mean PDP speed.

$\bar{P}_{in}$  = mean static absolute pressure at the PDP inlet.  
 $T_{std}$  = standard temperature = 293.15 K.  
*Example:*  
 $\bar{V}_{ref}$  = 0.1651 m<sup>3</sup>/s  
 $\bar{T}_{in}$  = 299.5 K

$P_{std}$  = 101.325 kPa  
 $\bar{f}_{nPDP}$  = 1205.1 r/min = 20.085 r/s  
 $\bar{P}_{in}$  = 98.290 kPa  
 $T_{std}$  = 293.15 K

$$V_{rev} = \frac{0.1651 \cdot 299.5 \cdot 101.3}{20.085 \cdot 98.290 \cdot 293.15}$$

$V_{rev} = 0.00866 \text{ m}^3/\text{r}$   
 \* \* \* \* \*  
 (b) *SSV calibration.* The equations governing SSV flow assume one-dimensional isentropic inviscid flow of an ideal gas. Paragraph (b)(2)(iv) of this section describes other assumptions that may apply. If good engineering judgment dictates that you account for gas compressibility, you may either use an appropriate equation of state to

determine values of  $Z$  as a function of measured pressure and temperature, or you may develop your own calibration equations based on good engineering judgment. Note that the equation for the flow coefficient,  $C_f$ , is based on the ideal gas assumption that the isentropic exponent,  $\gamma$ , is equal to the ratio of specific heats,  $C_p/C_v$ . If good engineering judgment dictates using a real gas isentropic exponent, you may either use

an appropriate equation of state to determine values of  $\gamma$  as a function of measured pressure and temperature, or you may develop your own calibration equations based on good engineering judgment.  
 (1) Calculate volume flow rate at standard reference conditions,  $\dot{V}_{std}$ , as follows

$$\dot{V}_{std} = C_d \cdot C_f \cdot \frac{A_t \cdot R \cdot p_{in} \cdot T_{std}}{p_{std} \cdot \sqrt{Z \cdot M_{mix} \cdot R \cdot T_{in}}}$$

Eq. 1066.625-3

Where:  
 $C_d$  = discharge coefficient, as determined in paragraph (b)(2)(i) of this section.  
 $C_f$  = flow coefficient, as determined in paragraph (b)(2)(ii) of this section.  
 $A_t$  = cross-sectional area at the venturi throat.

$R$  = molar gas constant.  
 $p_{in}$  = static absolute pressure at the venturi inlet.  
 $T_{std}$  = standard temperature.  
 $p_{std}$  = standard pressure.  
 $Z$  = compressibility factor.  
 $M_{mix}$  = molar mass of gas mixture.

$T_{in}$  = absolute temperature at the venturi inlet.  
 (2) \* \* \*  
 (i) Using the data collected in § 1066.140, calculate  $C_d$  for each flow rate using the following equation:

$$C_d = \dot{V}_{ref} \cdot \frac{p_{std} \cdot \sqrt{Z \cdot M_{mix} \cdot R \cdot T_{in}}}{C_f \cdot A_t \cdot R \cdot p_{in} \cdot T_{std}}$$

Eq. 1066.625-4

Where:

$\dot{V}_{ref}$  = measured volume flow rate from the reference flow meter.

\* \* \* \* \*

(iv) \* \* \*

(A) For raw exhaust, diluted exhaust, and dilution air, you may assume that the gas mixture behaves as an ideal gas ( $Z = 1$ ).

\* \* \* \* \*

(D) For diluted exhaust and dilution air, you may assume the molar mass of the mixture,  $M_{mix}$ , is a function only of the amount of water in the dilution air or calibration air, as follows:

$$M_{mix} = M_{air} \cdot (1 - x_{H2O}) + M_{H2O} \cdot x_{H2O}$$

Eq. 1066.625-7

Where:

$M_{air}$  = molar mass of dry air.  $x_{H2O}$  = amount of H<sub>2</sub>O in the dilution air or calibration air, determined as described in 40 CFR 1065.645.

$M_{H2O}$  = molar mass of water.

Example:

$M_{air}$  = 28.96559 g/mol

$x_{H2O}$  = 0.0169 mol/mol

$M_{H2O}$  = 18.01528 g/mol

$$M_{mix} = 28.96559 \cdot (1 - 0.0169) + 18.01528 \cdot 0.0169$$

$$M_{mix} = 28.7805 \text{ g/mol}$$

\* \* \* \* \*

(v) The following example illustrates the use of the governing equations to calculate  $C_d$  of an SSV flow meter at one reference flow meter value:

$$\dot{V}_{ref} = 2.395 \text{ m}^3/\text{s}$$

$$Z = 1$$

$$M_{mix} = 28.7805 \text{ g/mol} = 0.0287805 \text{ kg/mol}$$

$$R = 8.314472 \text{ J}/(\text{mol}\cdot\text{K}) = 8.314472 \text{ (m}^2\cdot\text{kg)} / (\text{s}^2\cdot\text{mol}\cdot\text{K})$$

$$T_{in} = 298.15 \text{ K}$$

$$A_t = 0.01824 \text{ m}^2$$

$$p_{in} = 99.132 \text{ kPa} = 99132 \text{ Pa} = 99132 \text{ kg}/(\text{m}\cdot\text{s}^2)$$

$$\gamma = 1.399$$

$$\beta = 0.8$$

$$\Delta p = 7.653 \text{ kPa}$$

$$r = 1 - \frac{2.312}{99.132} = 0.922$$

$$C_f = \left[ \frac{2 \cdot 1.399 \cdot \left( 0.922^{\frac{1.399-1}{1.399}} - 1 \right)}{(1.399-1) \cdot \left( 0.8^4 - 0.922^{\frac{-2}{1.399}} \right)} \right]^{\frac{1}{2}}$$

$$C_f = 0.472$$

$$C_d = 2.395 \cdot \frac{101325 \cdot \sqrt{1 \cdot 0.0287805 \cdot 8.314472 \cdot 298.15}}{0.472 \cdot 0.01824 \cdot 8.314472 \cdot 99132 \cdot 293.15}$$

$$C_d = 0.985$$

(vi) Calculate the Reynolds number,  $Re^\#$ , for each reference flow rate at standard conditions,  $\dot{V}_{refstd}$ , using the throat diameter of the venturi,  $d_t$ , and

the air density at standard conditions,  $\rho_{std}$ . Because the dynamic viscosity,  $\mu$ , is needed to compute  $Re^\#$ , you may use your own fluid viscosity model to determine  $\mu$  for your calibration gas (usually air), using good engineering

judgment. Alternatively, you may use the Sutherland three-coefficient viscosity model to approximate  $\mu$ , as shown in the following sample calculation for  $Re^\#$ :

$$Re^\# = \frac{4 \cdot \rho_{std} \cdot \dot{V}_{refstd}}{\pi \cdot d_t \cdot \mu}$$

Eq. 1066.625-8



Where, using the Sutherland three-coefficient viscosity model:

$$\mu = \mu_0 \cdot \left(\frac{T_{in}}{T_0}\right)^{\frac{3}{2}} \cdot \left(\frac{T_0 + S}{T_{in} + S}\right)$$

Eq. 1066.625-9

Where:  $T_0$  = Sutherland reference temperature.  
 $\mu_0$  = Sutherland reference viscosity.  $S$  = Sutherland constant.

TABLE 3 OF § 1066.625—SUTHERLAND THREE-COEFFICIENT VISCOSITY MODEL PARAMETERS

Gas <sup>1</sup>	$\mu_0$	$T_0$	$S$	Temperature range within $\pm 2\%$ error <sup>2</sup>	Pressure limit <sup>2</sup>
	kg/(m·s)	K	K	K	kPa
Air .....	$1.716 \cdot 10^{-5}$ .....	273 .....	111 .....	170 to 1900 .....	$\leq 1800$ .
CO <sub>2</sub> .....	$1.370 \cdot 10^{-5}$ .....	273 .....	222 .....	190 to 1700 .....	$\leq 3600$ .
H <sub>2</sub> O .....	$1.12 \cdot 10^{-5}$ .....	350 .....	1064 .....	360 to 1500 .....	$\leq 10000$ .
O <sub>2</sub> .....	$1.919 \cdot 10^{-5}$ .....	273 .....	139 .....	190 to 2000 .....	$\leq 2500$ .
N <sub>2</sub> .....	$1.663 \cdot 10^{-5}$ .....	273 .....	107 .....	100 to 1500 .....	$\leq 1600$ .

<sup>1</sup> Use tabulated parameters only for the pure gases, as listed. Do not combine parameters in calculations to calculate viscosities of gas mixtures.

<sup>2</sup> The model results are valid only for ambient conditions in the specified ranges.

Example:  
 $\mu_0 = 1.716 \cdot 10^{-5}$  kg/(m·s)  
 $T_0 = 273$  K

$S = 111$  K

$$\mu = 1.716 \cdot 10^{-5} \cdot \left(\frac{298.15}{273}\right)^{\frac{3}{2}} \cdot \left(\frac{273 + 111}{298.15 + 111}\right) \mu = 1.838 \cdot 10^{-5} \text{ kg/(m·s)}$$

$T_{in} = 298.15$  K  
 $d_t = 152.4$  mm = 0.1524 m

$\rho_{std} = 1.1509$  kg/m<sup>3</sup>

$$Re^{\#} = \frac{4 \cdot 1.1964 \cdot 2.395}{3.14159 \cdot 0.1524 \cdot 1.838 \cdot 10^{-5}}$$

$Re^{\#} = 1.3027 \cdot 10^6$

(vii) Calculate  $\rho$  using the following equation:

$$\rho_{std} = \frac{p_{std} \cdot MW_{mix}}{R \cdot T_{std}}$$

Eq. 1066.625-10

Example:

$$\rho_{std} = \frac{101325 \cdot 0.0287805}{8.314472 \cdot 293.15}$$

$\rho_{std} = 1.1964 \text{ kg/m}^3$

\* \* \* \* \*

(xiii) Once you have an equation that meets the specified statistical criterion,

you may use the equation only for the corresponding range of  $Re^\#$ .

\* \* \* \* \*

(c) \* \* \*

(1) \* \* \*

(i) Calculate an individual  $K_v$  for each calibration set point for each restrictor position using the following equation:

$$K_v = \frac{\bar{V}_{refstd} \cdot \sqrt{\bar{T}_{in}}}{\bar{P}_{in}}$$

Eq. 1066.625-12

Where:

$\bar{V}_{refstd}$  = mean flow rate from the reference flow meter, corrected to standard reference conditions.

$\bar{T}_{in}$  = mean temperature at the venturi inlet.

$\bar{P}_{in}$  = mean static absolute pressure at the venturi inlet.

(ii) Calculate the mean and standard deviation of all the  $K_v$  values (see 40 CFR

1065.602). Verify choked flow by plotting  $K_v$  as a function of  $p_{in}$ .  $K_v$  will have a relatively constant value for choked flow; as vacuum pressure increases, the venturi will become unchoked and  $K_v$  will decrease. Paragraphs (c)(1)(iii) through (viii) of this section describe how to verify your range of choked flow.

(iii) If the standard deviation of all the  $K_v$  values is less than or equal to 0.3% of the mean  $K_v$ , use the mean  $K_v$  in Eq. 1066.630-7, and use the CFV only up to the highest venturi pressure ratio,  $r$ , measured during calibration using the following equation:

$$r = 1 - \frac{\Delta p_{CFV}}{P_{in}}$$

Eq. 1066.625-13

Where:

$\Delta p_{CFV}$  = differential static pressure; venturi inlet minus venturi outlet.

$p_{in}$  = mean static absolute pressure at the venturi inlet.

\* \* \* \* \*

■ 305. Section 1066.630 is revised to read as follows:

**§ 1066.630 PDP, SSV, and CFV flow rate calculations.**

This section describes the equations for calculating flow rates from various flow meters. After you calibrate a flow meter according to § 1066.625, use the calculations described in this section to calculate flow during an emission test. Calculate flow according to 40 CFR

1065.642 instead if you calculate emissions based on molar flow rates.

(a) *PDP*. (1) Based on the speed at which you operate the PDP for a test interval, select the corresponding slope,  $a_1$ , and intercept,  $a_0$ , as determined in § 1066.625(a), to calculate PDP flow rate,  $\dot{v}$ , as follows:

$$\dot{V} = f_{nPDP} \cdot \frac{V_{rev} \cdot T_{std} \cdot p_{in}}{T_{in} \cdot p_{std}}$$

Eq. 1066.630-1

Where:

$f_{nPDP}$  = pump speed.

$V_{rev}$  = PDP volume pumped per revolution, as determined in paragraph (a)(2) of this section.

$T_{std}$  = standard temperature = 293.15 K.

$p_{in}$  = static absolute pressure at the PDP inlet.

$T_{in}$  = absolute temperature at the PDP inlet.

$p_{std}$  = standard pressure = 101.325 kPa.

(2) Calculate  $V_{rev}$  using the following equation:

$$V_{rev} = \frac{a_1}{f_{nPDP}} \cdot \sqrt{\frac{p_{out} - p_{in}}{p_{out}}} + a_0$$

Eq. 1066.630-2

$p_{out}$  = static absolute pressure at the PDP outlet.

*Example:*

$a_1 = 0.8405 \text{ m}^3/\text{s}$

$f_{nPDP} = 12.58 \text{ r/s}$

$p_{out} = 99.950 \text{ kPa}$

$p_{in} = 98.575 \text{ kPa}$

$a_0 = 0.056 \text{ m}^3/\text{r}$

$T_{in} = 323.5 \text{ K}$

$$V_{rev} = \frac{0.8405}{12.58} \cdot \sqrt{\frac{99,950 - 98.575}{99.950}} + 0.056$$

$V_{rev} = 0.063 \text{ m}^3/\text{r}$

$$\dot{V} = 12.58 \cdot \frac{0.06383 \cdot 293.15 \cdot 98.575}{323.5 \cdot 101.3}$$

$\dot{v} = 0.7079 \text{ m}^3/\text{s}$

(b) SSV. Calculate SSV flow rate,  $\dot{v}$ , as follows:

$$\dot{V} = C_d \cdot C_f \cdot \frac{A_t \cdot R \cdot p_{in} \cdot T_{std}}{p_{std} \cdot \sqrt{Z \cdot M_{mix} \cdot R \cdot T_{in}}}$$

Eq. 1066.630-3

Where:

$C_d$  = discharge coefficient, as determined based on the  $C_d$  versus  $Re^{\#}$  equation in § 1066.625(b)(2)(viii).  
 $C_f$  = flow coefficient, as determined in § 1066.625(b)(2)(ii).  
 $A_t$  = venturi throat cross-sectional area.  
 $R$  = molar gas constant.  
 $p_{in}$  = static absolute pressure at the venturi inlet.

$T_{std}$  = standard temperature.  
 $p_{std}$  = standard pressure.  
 $Z$  = compressibility factor.  
 $M_{mix}$  = molar mass of gas mixture.  
 $T_{in}$  = absolute temperature at the venturi inlet.  
*Example:*  
 $C_d = 0.890$   
 $C_f = 0.472$   
 $A_t = 0.01824 \text{ m}^2$

$R = 8.314472 \text{ J}/(\text{mol}\cdot\text{K}) = 8.314472 (\text{m}^2\cdot\text{kg})/(\text{s}^2\cdot\text{mol}\cdot\text{K})$   
 $p_{in} = 98.496 \text{ kPa}$   
 $T_{std} = 293.15 \text{ K}$   
 $p_{std} = 101.325 \text{ kPa}$   
 $Z = 1$   
 $M_{mix} = 28.7789 \text{ g}/\text{mol} = 0.0287789 \text{ kg}/\text{mol}$   
 $T_{in} = 296.85 \text{ K}$

$$\dot{V} = 0.89 \cdot 0.472 \cdot \frac{0.01824 \cdot 8.314472 \cdot 98.496 \cdot 293.15}{101.325 \cdot \sqrt{1 \cdot 0.0287805 \cdot 8.314472 \cdot 296.85}}$$

$\dot{V} = 2.155 \text{ m}^3/\text{s}$

(c) CFV. If you use multiple venturis and you calibrated each venturi independently to determine a separate calibration coefficient,  $K_v$ , for each venturi, calculate the individual volume

flow rates through each venturi and sum all their flow rates to determine CFV flow rate,  $\dot{V}$ . If you use multiple venturis and you calibrated venturis in combination, calculate  $\dot{V}$  using the  $K_v$

that was determined for that combination of venturis.

(1) To calculate  $\dot{V}$  through one venturi or a combination of venturis, use the mean  $K_v$  you determined in § 1066.625(c) and calculate  $\dot{V}$  as follows:

$$\dot{V} = \frac{K_v \cdot p_{in}}{\sqrt{T_{in}}}$$

Eq. 1066.630-4

Where:

$K_v$  = flow meter calibration coefficient.  
 $T_{in}$  = temperature at the venturi inlet.

$p_{in}$  = absolute static pressure at the venturi inlet.  
*Example:*

$K_v = 0.074954 \text{ m}^3\cdot\text{K}^{0.5}/(\text{kPa}\cdot\text{s})$   
 $p_{in} = 99.654 \text{ kPa}$   
 $T_{in} = 353.15 \text{ K}$

$$\dot{V} = \frac{0.074954 \cdot 99.654}{\sqrt{353.15}}$$

$\dot{V} = 0.39748 \text{ m}^3/\text{s}$

(2) [Reserved]

■ 306. Section 1066.635 is amended by revising paragraphs (a) and (c) introductory text to read as follows:

§ 1066.635 NMOG determination.  
 \* \* \* \* \*

(a) Determine NMOG by independently measuring alcohols and carbonyls as described in 40 CFR 1065.805 and 1065.845. Use good engineering judgment to determine

which alcohols and carbonyls you need to measure. This would typically require you to measure all alcohols and carbonyls that you expect to contribute 1% or more of total NMOG. Calculate

the mass of NMOG in the exhaust,  $m_{\text{NMOG}}$ , with the following equation, using density values specified in § 1066.1005(f):

$$m_{\text{NMOG}} = m_{\text{NMHC}} - \rho_{\text{NMHC}} \cdot \sum_{i=1}^N \frac{m_{\text{OHC}_i}}{\rho_{\text{OHC}_i}} \cdot RF_{\text{OHC}_i[\text{THC-FID}]} + \sum_{i=1}^N m_{\text{OHC}_i}$$

Eq. 1066.635-1

Where:

- $m_{\text{NMHC}}$  = the mass of NMHC and all oxygenated hydrocarbon (OHC) in the exhaust, as determined using Eq. 1066.605-2. Calculate NMHC mass based on  $\rho_{\text{NMHC}}$ .
- $\rho_{\text{NMHC}}$  = the effective C<sub>1</sub>-equivalent density of NMHC as specified in § 1066.1005(f).
- $m_{\text{OHC}_i}$  = the mass of oxygenated species  $i$  in the exhaust calculated using Eq. 1066.605-2.
- $\rho_{\text{OHC}_i}$  = the C<sub>1</sub>-equivalent density of oxygenated species  $i$ .
- $RF_{\text{OHC}_i[\text{THC-FID}]}$  = the response factor of a THC-FID to oxygenated species  $i$  relative to propane on a C<sub>1</sub>-equivalent basis as determined in 40 CFR 1065.845.

(c) For gasoline containing less than 25% ethanol by volume, you may calculate NMOG from measured NMHC emissions as follows:

■ 307. Section 1066.695 is amended by revising paragraph (f) to read as follows:

**§ 1066.695 Data requirements.**

(f) Vehicle information as applicable, including identification number, model year, applicable emission standards (including bin standards or family emission limits, as applicable), vehicle model, vehicle class, test group, durability group, engine family, evaporative/refueling emission family, basic engine description (including displacement, number of cylinders, turbocharger/supercharger used, and catalyst type), fuel system (type of fuel injection and fuel tank capacity and location), engine code, GVWR, applicable test weight, inertia weight class, actual curb weight at zero miles, actual road load at 50 mi/hr, transmission class and configuration, axle ratio, odometer reading, idle rpm, and measured drive wheel tire pressure.

**Subpart H—Cold Temperature Test Procedures**

■ 308. Section 1066.710 is amended by revising paragraphs (a)(5) and (d)(3) introductory text to read as follows:

**§ 1066.710 Cold temperature testing procedures for measuring CO and NMHC emissions and determining fuel economy.**

- (a) \* \* \*
- (5) Adjust the dynamometer to simulate vehicle operation on the road at -7 °C as described in § 1066.305(b).
- (d) \* \* \*
- (3) You may start the preconditioning drive once the fuel in the fuel tank reaches (-12.6 to -1.4) °C. Precondition the vehicle as follows:

**Subpart I—Exhaust Emission Test Procedures for Motor Vehicles**

■ 309. Section 1066.801 is amended by revising paragraphs (c)(2) and (3) to read as follows:

**§ 1066.801 Applicability and general provisions.**

- (c) \* \* \*
- (2) The Supplemental Federal Test Procedure (SFTP) measures the emission effects from aggressive driving and operation with the vehicle's air conditioner. The SFTP is based on a composite of three different test elements. In addition to the FTP, vehicles generally operate over the US06 and SC03 driving schedules as specified in paragraphs (g) and (h) of Appendix I of 40 CFR part 86, respectively. In the case of heavy-duty vehicles above 10,000 pounds GVWR and at or below 14,000 pounds GVWR, SFTP testing involves additional driving over the Hot LA-92 driving schedule as specified in paragraph (c) of 40 CFR part 86, Appendix I, instead of the US06 driving schedule. Note that the US06 driving schedule represents about 8.0 miles of relatively aggressive driving; the SC03 driving schedule represents about 3.6 miles of urban driving with the air conditioner operating; and the hot portion of the LA-92 driving schedule represents about 9.8 miles of relatively aggressive driving for commercial trucks. See § 1066.830.

(3) The Highway Fuel Economy Test (HFET) is specified in Appendix I of 40 CFR part 600. Note that the HFET represents about 10.2 miles of rural and freeway driving with an average speed of 48.6 mi/hr and a maximum speed of 60.0 mi/hr. See § 1066.840.

■ 310. Section 1066.805 is amended by revising paragraph (c) to read as follows:

**§ 1066.805 Road-load power, test weight, and inertia weight class determination.**

- (c) For FTP, SFTP, New York City Cycle, HFET, and LA-92 testing, determine road-load forces for each test vehicle at speeds between 9.3 and 71.5 miles per hour. The road-load force must represent vehicle operation on a smooth, level road with no wind or calm winds, no precipitation, an ambient temperature of approximately 20 °C, and atmospheric pressure of 98.21 kPa. You may extrapolate road-load force for speeds below 9.3 mi/hr.

■ 311. Section 1066.815 is amended by revising paragraphs (b) introductory text and (b)(4) and (5) to read as follows:

**§ 1066.815 Exhaust emission test procedures for FTP testing.**

- (b) *PM sampling options.* Collect PM using any of the procedures specified in paragraphs (b)(1) through (5) of this section and use the corresponding equation in § 1066.820 to calculate FTP composite emissions. Testing must meet the requirements related to filter face velocity as described in § 1066.110(b)(2)(iii)(C), except as specified in paragraphs (b)(4) and (5) of this section. For procedures involving flow weighting, set the filter face velocity to a weighting target of 1.0 to meet the requirements of § 1066.110(b)(2)(iii)(C). Allow filter face velocity to decrease as a percentage of the weighting factor if the weighting factor is less than 1.0 and do not change the nominal CVS flowrates or secondary dilution ratios between FTP or UDDS test intervals. Use the appropriate

equations in § 1066.610 to show that you meet the dilution factor requirements of § 1066.110(b)(2)(iii)(B). If you collect PM using the procedures specified in paragraph (b)(4) or (5) of this section, the residence time requirements in 40 CFR 1065.140(e)(3) apply, except that you may exceed an overall residence time of 5.5 s for sample flow rates below the highest expected sample flow rate.

\* \* \* \* \*

(4) You may collect PM on a single filter over the cold-start UDDS and the first 505 seconds of the hot-start UDDS using one of the following methods:

(i) Adjust your sampling system flow rate over the filter to weight the filter face velocity over the three intervals of the FTP based on weighting targets of 0.43 for bag 1, 1.0 for bag 2, and 0.57 for bag 3.

(ii) Maintain a constant sampling system flow rate over the filter for all

three intervals of the FTP by increasing overall dilution ratios for bag 1 and bag 3. To do this, reduce the sample flow rate from the exhaust (or diluted exhaust) such that the value is reduced to 43% and 57%, respectively, of the bag 2 values. For constant-volume samplers, this requires that you decrease the dilute exhaust sampling rate from the CVS and compensate for that by increasing the amount of secondary dilution air.

(5) You may collect PM on a single filter over the cold-start UDDS and the full hot-start UDDS using one of the following methods:

(i) Adjust your sampling system flow rate over the filter to weight the filter face velocity based on weighting targets of 0.75 for the cold-start UDDS and 1.0 for the hot-start UDDS.

(ii) Maintain a constant sampling system flow rate over the filter for both the cold-start and hot-start UDDS by increasing the overall dilution ratio for

the cold-start UDDS. To do this, reduce the sample flow rate from the exhaust (or diluted exhaust) such that the value is reduced to 75% of the hot-start UDDS value. For constant-volume samplers, this requires that you decrease the dilute exhaust sampling rate from the CVS and compensate for that by increasing the amount of secondary dilution air.

\* \* \* \* \*

■ 312. Section 1066.820 is amended by revising paragraph (c) to read as follows:

**§ 1066.820 Composite calculations for FTP exhaust emissions.**

\* \* \* \* \*

(c) Calculate the final composite PM test results as a mass-weighted value,  $e_{PM-FTPcomp}$ , in grams per mile as follows:

(1) Use the following equation for PM measured as described in § 1066.815(b)(1), (2), or (3):

$$e_{PM-FTPcomp} = 0.43 \cdot \left( \frac{m_{PM-cUDDS}}{D_{ct} + D_{cs}} \right) + 0.57 \cdot \left( \frac{m_{PM-hUDDS}}{D_{ht} + D_{hs}} \right)$$

Eq. 1066.820-2

Where:

$m_{PM-cUDDS}$  = the combined PM mass emissions determined from the cold-start UDDS test interval (bag 1 and bag 2), in grams, as calculated using Eq. 1066.605-3.

$m_{PM-hUDDS}$  = the combined PM mass emissions determined from the hot-start UDDS test interval (bag 3 and bag 4), in grams, as calculated using Eq. 1066.605-3. This is the hot-stabilized portion from either the first or second UDDS (bag 2,

unless you measure bag 4), in addition to the hot transient portion (bag 3).

(2) Use the following equation for PM measured as described in § 1066.815(b)(4):

$$e_{PM-FTPcomp} = \frac{m_{PM}}{(0.43 \cdot D_{ct}) + D_{cs} + (0.57 \cdot D_{ht})}$$

Eq. 1066.820-3

Where:

$m_{PM}$  = the combined PM mass emissions determined from the cold-start UDDS

test interval and the first 505 seconds of the hot-start UDDS test interval (bag 1, bag 2, and bag 3), in grams, as calculated using Eqs. 1066.605-4 and 1066.605-5.

(3) Use the following equation for PM measured as described in § 1066.815(b)(5):

$$e_{PM-FTPcomp} = \frac{m_{PM}}{0.43 \cdot (D_{ct} + D_{cs}) + 0.57 \cdot (D_{ht} + D_{hs})}$$

Eq. 1066.820-4

Where:

$m_{PM}$  = the combined PM mass emissions determined from the cold-start UDDS test interval and the hot-start UDDS test interval (bag 1, bag 2, bag 3, and bag 4),

in grams, as calculated using Eqs. 1066.605-6 and 1066.605-7.

**§ 1066.835 Exhaust emission test procedure for SC03 emissions.**

\* \* \* \* \*

■ 313. Section 1066.835 is amended by revising paragraph (f)(3)(iv) to read as follows:

(f) \* \* \*

(3) \* \* \*

(iv) Check the uniformity of radiant energy intensity at least every 500 hours of emitter usage or every 6 months, whichever is sooner, and after any major modifications affecting the solar simulation. Determine uniformity by measuring radiant energy intensity using instruments that meet the specifications described in paragraph (f)(3)(iii) of this section at each point of a 0.5 m grid over the vehicle's full

footprint, including the edges of the footprint, at an elevation 1 m above the floor. Measured values of radiant energy intensity must be between (722 and 978) W/m<sup>2</sup> at all points.

**Subpart J—Evaporative Emission Test Procedures**

■ 314. Section 1066.985 is amended by revising paragraph (d)(8) to read as follows:

**§ 1066.985 Fuel storage system leak test procedure.**

\* \* \* \* \*  
(d) \* \* \*

(8) Use the following equation, or a different equation you develop based on good engineering judgment, to calculate the effective leak diameter,  $d_{\text{eff}}$ :

$$d_{\text{eff}} = 7.844 \cdot \left( \frac{\dot{Q}_{\text{N}_2}}{\sqrt{(p_{\text{in}} - p_{\text{atmos}}) \cdot (p_{\text{in}} + p_{\text{atmos}})} \cdot SG_{\text{N}_2} \cdot T}} \right)^{0.5057}$$

Eq. 1066.985-1

Where:

$d_{\text{eff}}$  = effective leak diameter, in inches, expressed to at least two decimal places.  
 $\dot{Q}_{\text{N}_2}$  = volumetric flow of nitrogen, in m<sup>3</sup>/s.  
 $p_{\text{in}}$  = inlet pressure to orifice, in kPa.

$p_{\text{atmos}}$  = atmospheric pressure, in kPa.  
 $SG_{\text{N}_2}$  = specific gravity of N<sub>2</sub> relative to air at 101.325 kPa and 15.5 °C = 0.967.  
 $T$  = temperature of flowing medium, in K.

Example:

$\dot{Q}_{\text{N}_2}$  = 0.8 · 10<sup>-5</sup> m<sup>3</sup>/s  
 $p_{\text{in}}$  = 104.294 kPa  
 $p_{\text{atmos}}$  = 101.332 kPa  
 $SG_{\text{N}_2}$  = 0.967  
 $T$  = 298.15 K

$$d_{\text{eff}} = 7.844 \cdot \left( \frac{0.8 \cdot 10^{-5}}{\sqrt{(104.294 - 101.332) \cdot (104.294 + 101.332)} \cdot 0.967 \cdot 298.15}} \right)^{0.5057}$$

$d_{\text{eff}} = 0.017$  inches

\* \* \* \* \*

**Subpart K—Definitions and Other Reference Material**

■ 315. Section 1066.1005 is amended by revising paragraph (a) to read as follows:

**§ 1066.1005 Symbols, abbreviations, acronyms, and units of measure.**

\* \* \* \* \*

(a) *Symbols for quantities.* This part uses the following symbols and units of measure for various quantities:

Symbol	Quantity	Unit	Unit symbol	Unit in terms of SI base units
$\alpha$ .....	atomic hydrogen to carbon ratio ....	mole per mole .....	mol/mol .....	1.
$A$ .....	area .....	square meter .....	m <sup>2</sup> .....	m <sup>2</sup> .
$A$ .....	vehicle frictional load .....	pound force or newton .....	lbf or N .....	m · kg · s <sup>-2</sup> .
$a_g$ .....	acceleration of Earth's gravity .....	meters per second squared .....	m/s <sup>2</sup> .....	m · s <sup>-2</sup> .
$A_m$ .....	calculated vehicle frictional load ....	pound force or newton .....	lbf or N .....	m · kg · s <sup>-2</sup> .
$a_0$ .....	intercept of least squares regression.			
$a_1$ .....	slope of least squares regression ..			
$a$ .....	acceleration .....	feet per second squared or meters per second squared.	ft/s <sup>2</sup> or m/s <sup>2</sup> .....	m · s <sup>-2</sup> .
$B$ .....	vehicle load from drag and rolling resistance.	pound force per mile per hour or newton second per meter.	lbf/(mi/hr) or N · s/m.	kg · s <sup>-1</sup> .
$\beta$ .....	ratio of diameters .....	meter per meter .....	m/m .....	1.
$\beta$ .....	atomic oxygen to carbon ratio .....	mole per mole .....	mol/mol .....	1.
$c$ .....	conversion factor .....			
$C$ .....	vehicle-specific aerodynamic effects.	pound force per mile per hour squared or newton-second squared per meter squared.	lbf/(mi/hr) <sup>2</sup> or N · s <sup>2</sup> /m <sup>2</sup> .	m <sup>-1</sup> · kg.

Symbol	Quantity	Unit	Unit symbol	Unit in terms of SI base units
$C_{\#}$	number of carbon atoms in a molecule.	$C_{\#}$	number of carbon atoms in a molecule.	$C_{\#}$ .
$C_d$	discharge coefficient			
$C_d A$	drag area	meter squared	$m^2$	$m^2$ .
$C_f$	flow coefficient			
$C_p$	heat capacity at constant pressure	joule per kelvin	J/K	$m^2 \cdot kg \cdot s^{-2} \cdot K^{-1}$ .
$C_v$	heat capacity at constant volume	joule per kelvin	J/K	$m^2 \cdot kg \cdot s^{-2} \cdot K^{-1}$ .
$d$	diameter	meters	m	m.
$D$	distance	miles or meters	mi or m	m.
$D$	slope correlation	pound force per mile per hour squared or newton second squared per meter squared.	lbf/(mi/hr) <sup>2</sup> or N·s <sup>2</sup> /m <sup>2</sup> .	$m^{-2} \cdot kg$ .
$DF$	dilution factor			1.
$e$	mass weighted emission result	grams/mile	g/mi	
$F$	force	pound force or newton	lbf or N	$kg \cdot s^{-2}$ .
$f$	frequency	hertz	Hz	$s^{-1}$ .
$f_n$	angular speed (shaft)	revolutions per minute	r/min	$\pi \cdot 30 \cdot s^{-1}$ .
$FC$	friction compensation error	horsepower or watt	W	$m^2 \cdot kg \cdot s^{-3}$ .
$FR$	road-load force	pound force or newton	lbf or N	$kg \cdot s^{-2}$ .
$\gamma$	ratio of specific heats	(joule per kilogram kelvin) per (joule per kilogram kelvin).	(J/(kg·K))/(J/(kg·K)).	1.
$H$	ambient humidity	grams water vapor per kilogram dry air.	g H <sub>2</sub> O vapor/kg dry air.	g H <sub>2</sub> O vapor/kg dry air.
$\Delta h$	change in height	meters	m	m.
$I$	inertia	pound mass or kilogram	lbm or kg	kg.
$I$	current	ampere	A	A.
$i$	indexing variable			
$IR$	inertia work rating			1.
$K$	correction factor			1.
$K_c$	calibration coefficient		$m^4 \cdot s \cdot K^{0.5} / kg$	$m^4 \cdot kg^{-1} \cdot s \cdot K^{0.5}$ .
$\mu$	viscosity, dynamic	pascal second	Pa·s	$m^{-1} \cdot kg \cdot s^{-1}$ .
$M$	molar mass	gram per mole	g/mol	$10^{-3} \cdot kg \cdot mol^{-1}$ .
$M_e$	effective mass	kilogram	kg	kg.
$m$	mass	pound mass or kilogram	lbm or kg	kg.
$N$	total number in series			
$n$	total number of pulses in a series			
$p$	pressure	pascal	Pa	$m^{-1} \cdot kg \cdot s^{-2}$ .
$\Delta p$	differential static pressure	pascal	Pa	$m^{-1} \cdot kg \cdot s^{-2}$ .
$p_a$	saturated vapor pressure at ambient dry bulb temperature.	kilopascal	kPa	$m^{-1} \cdot kg \cdot s^{-2}$ .
$PF$	penetration fraction			
$\rho$	mass density	kilogram per cubic meter	kg/m <sup>3</sup>	$m^{-3} \cdot kg$ .
$R$	dynamometer roll revolutions	revolutions per minute	rpm	$\pi \cdot 30^{-1} \cdot s^{-1}$ .
$r$	ratio of pressures	pascal per pascal	Pa/Pa	1.
$r^2$	coefficient of determination			
$Re^{\#}$	Reynolds number			
$RF$	response factor			
$RH$	relative humidity			
$S$	Sutherland constant	kelvin	K	K.
$SEE$	standard estimate of error			
$SG$	specific gravity			
$\Delta s$	distance traveled during measurement interval.	meters	m	m.
$T$	absolute temperature	kelvin	K	K.
$T$	Celsius temperature	degree Celsius	°C	$K - 273.15$ .
$T$	torque (moment of force)	newton meter	N·m	$m^2 \cdot kg \cdot s^{-2}$ .
$t$	time	hour or second	hr or s	s.
$\Delta t$	time interval, period, 1/frequency	second	s	s.
$U$	voltage	volt	V	$m^2 \cdot kg \cdot s^{-3} \cdot A^{-1}$ .
$v$	speed	miles per hour or meters per second.	mi/hr or m/s	$m \cdot s^{-1}$ .
$V$	volume	cubic meter	m <sup>3</sup>	m <sup>3</sup> .
$\dot{V}$	flow volume rate	cubic feet per minute or cubic meter per second.	ft <sup>3</sup> /min or m <sup>3</sup> /s	$m^3 \cdot s^{-1}$ .
$VP$	volume percent			
$x$	concentration of emission over a test interval.	part per million	ppm	
$y$	generic variable			
$Z$	compressibility factor			

\* \* \* \* \*

■ 316. Section 1066.1010 is amended by removing the undesignated paragraph after paragraph (a) introductory text and revising paragraph (b)(1) to read as follows:

**§ 1066.1010 Incorporation by reference.**

\* \* \* \* \*

(b) \* \* \*

(1) SAE J1263, Road Load Measurement and Dynamometer Simulation Using Coastdown Techniques, revised March 2010, IBR approved for §§ 1066.301(b), 1066.305(a), and 1066.310(b).

\* \* \* \* \*

**PART 1068—GENERAL COMPLIANCE PROVISIONS FOR HIGHWAY, STATIONARY, AND NONROAD PROGRAMS**

■ 317. The authority citation for part 1068 continues to read as follows:

*Authority:* 42 U.S.C. 7401–7671q.

**Subpart A—Applicability and Miscellaneous Provisions**

■ 318. Section 1068.1 is revised to read as follows:

**§ 1068.1 Does this part apply to me?**

(a) The provisions of this part apply to everyone with respect to the engine and equipment categories as described in this paragraph (a). They apply to everyone, including owners, operators, parts manufacturers, and persons performing maintenance. Where we identify an engine category, the provisions of this part also apply with respect to the equipment using such engines. This part 1068 applies to different engine and equipment categories as follows:

(1) This part 1068 applies to motor vehicles we regulate under 40 CFR part 86, subpart S, to the extent and in the manner specified in 40 CFR parts 85 and 86.

(2) This part 1068 applies for heavy-duty motor vehicles we regulate under 40 CFR part 1037, subject to the provisions of 40 CFR parts 85 and 1037. This includes trailers. This part 1068 applies to other heavy-duty motor vehicles and motor vehicle engines to the extent and in the manner specified in 40 CFR parts 85, 86, and 1036.

(3) This part 1068 applies to highway motorcycles we regulate under 40 CFR part 86, subparts E and F, to the extent and in the manner specified in 40 CFR parts 85 and 86.

(4) This part 1068 applies to aircraft we regulate under 40 CFR part 87 to the extent and in the manner specified in 40 CFR part 87.

(5) This part 1068 applies for locomotives that are subject to the provisions of 40 CFR part 1033. This part 1068 does not apply for locomotives or locomotive engines that were originally manufactured before July 7, 2008, and that have not been remanufactured on or after July 7, 2008.

(6) This part 1068 applies for land-based nonroad compression-ignition engines that are subject to the provisions of 40 CFR part 1039. This part 1068 does not apply for engines certified under 40 CFR part 89.

(7) This part 1068 applies for stationary compression-ignition engines certified using the provisions of 40 CFR parts 89, 94, 1039, and 1042 as described in 40 CFR part 60, subpart IIII.

(8) This part 1068 applies for marine compression-ignition engines that are subject to the provisions of 40 CFR part 1042. This part 1068 does not apply for marine compression-ignition engines certified under 40 CFR part 94.

(9) This part 1068 applies for marine spark-ignition engines that are subject to the provisions of 40 CFR part 1045. This part 1068 does not apply for marine spark-ignition engines certified under 40 CFR part 91.

(10) This part 1068 applies for large nonroad spark-ignition engines that are subject to the provisions of 40 CFR part 1048.

(11) This part 1068 applies for stationary spark-ignition engines certified using the provisions of 40 CFR part 1048 or part 1054, as described in 40 CFR part 60, subpart JJJJ.

(12) This part 1068 applies for recreational engines and vehicles, including snowmobiles, off-highway motorcycles, and all-terrain vehicles that are subject to the provisions of 40 CFR part 1051.

(13) This part applies for small nonroad spark-ignition engines that are subject to the provisions of 40 CFR part 1054. This part 1068 does not apply for nonroad spark-ignition engines certified under 40 CFR part 90.

(14) This part applies for fuel-system components installed in nonroad equipment powered by volatile liquid fuels that are subject to the provisions of 40 CFR part 1060.

(b) [Reserved]

(c) Paragraph (a) of this section identifies the parts of the CFR that define emission standards and other requirements for particular types of engines and equipment. This part 1068 refers to each of these other parts generically as the “standard-setting part.” For example, 40 CFR part 1051 is always the standard-setting part for snowmobiles. Follow the provisions of the standard-setting part if they are

different than any of the provisions in this part.

(d) Specific provisions in this part 1068 start to apply separate from the schedule for certifying engines/equipment to new emission standards, as follows:

(1) The provisions of §§ 1068.30 and 1068.310 apply for stationary spark-ignition engines built on or after January 1, 2004, and for stationary compression-ignition engines built on or after January 1, 2006.

(2) The provisions of §§ 1068.30 and 1068.235 apply for the types of nonroad engines/equipment listed in paragraph (a) of this section beginning January 1, 2004, if they are used solely for competition.

(3) The standard-setting part may specify how the provisions of this part 1068 apply for uncertified engines/equipment.

■ 319. Section 1068.10 is amended by revising the section heading to read as follows:

**§ 1068.10 Confidential information.**

\* \* \* \* \*

■ 320. Section 1068.15 is amended by revising the section heading and paragraph (a) to read as follows:

**§ 1068.15 General provisions for EPA decision-making.**

(a) Not all EPA employees may represent the Agency with respect to EPA decisions under this part or the standard-setting part. Only the Administrator of the Environmental Protection Agency or an official to whom the Administrator has delegated specific authority may represent the Agency. For more information, ask for a copy of the relevant sections of the EPA Delegations Manual from the Designated Compliance Officer.

\* \* \* \* \*

**§ 1068.20 [Amended]**

■ 321. Section 1068.20 is amended by removing paragraphs (b) and (c) and redesignating paragraphs (d) through (f) as paragraphs (b) through (d), respectively.

■ 322. Section 1068.27 is revised to read as follows:

**§ 1068.27 May EPA conduct testing with my engines/equipment?**

(a) As described in the standard-setting part, we may perform testing on your engines/equipment before we issue a certificate of conformity. This is generally known as confirmatory testing.

(b) If we request it, you must make a reasonable number of production-line engines or pieces of production-line



equipment available for a reasonable time so we can test or inspect them for compliance with the requirements of this chapter.

(c) If your emission-data engine/equipment or production engine/equipment requires special components for proper testing, you must promptly provide any such components to us if we ask for them.

■ 323. Section 1068.30 is revised to read as follows:

**§ 1068.30 Definitions.**

The following definitions apply to this part. The definitions apply to all subparts unless we note otherwise. All undefined terms have the meaning the Clean Air Act gives to them. The definitions follow:

*Affiliated companies or affiliates* means one of the following:

(1) For determinations related to small manufacturer allowances or other small business provisions, these terms mean all entities considered to be affiliates with your entity under the Small Business Administration's regulations in 13 CFR 121.103.

(2) For all other provisions, these terms mean all of the following:

(i) Parent companies (as defined in this section).

(ii) Subsidiaries (as defined in this section).

(iii) Subsidiaries of your parent company.

*Aftertreatment* means relating to a catalytic converter, particulate filter, or any other system, component, or technology mounted downstream of the exhaust valve (or exhaust port) whose design function is to reduce emissions in the engine exhaust before it is exhausted to the environment. Exhaust gas recirculation (EGR) is not aftertreatment.

*Aircraft* means any vehicle capable of sustained air travel more than 100 feet above the ground.

*Certificate holder* means a manufacturer (including importers) with a valid certificate of conformity for at least one family in a given model year, or the preceding model year. Note that only manufacturers may hold certificates. Your applying for or accepting a certificate is deemed to be your agreement that you are a manufacturer.

*Clean Air Act* means the Clean Air Act, as amended, 42 U.S.C. 7401–7671q.

*Date of manufacture* means one of the following:

(1) For engines, the date on which the crankshaft is installed in an engine block, with the following exceptions:

(i) For engines produced by secondary engine manufacturers under § 1068.262,

date of manufacture means the date the engine is received from the original engine manufacturer. You may assign an earlier date up to 30 days before you received the engine, but not before the crankshaft was installed. You may not assign an earlier date if you cannot demonstrate the date the crankshaft was installed.

(ii) Manufacturers may assign a date of manufacture at a point in the assembly process later than the date otherwise specified under this definition. For example, a manufacturer may use the build date printed on the label or stamped on the engine as the date of manufacture.

(2) For equipment, the date on which the engine is installed, unless otherwise specified in the standard-setting part. Manufacturers may alternatively assign a date of manufacture later in the assembly process.

*Days* means calendar days, including weekends and holidays.

*Defeat device* has the meaning given in the standard-setting part.

*Designated Compliance Officer* means one of the following:

(1) For motor vehicles regulated under 40 CFR part 86, subpart S: Director, Light-Duty Vehicle Center, U.S. Environmental Protection Agency, 2000 Traverwood Drive, Ann Arbor, MI 48105; *complianceinfo@epa.gov*; *epa.gov/otaq/verify*.

(2) For compression-ignition engines used in heavy-duty highway vehicles regulated under 40 CFR part 86, subpart A, and 40 CFR parts 1036 and 1037, and for nonroad and stationary compression-ignition engines or equipment regulated under 40 CFR parts 60, 1033, 1039, and 1042: Director, Diesel Engine Compliance Center, U.S. Environmental Protection Agency, 2000 Traverwood Drive, Ann Arbor, MI 48105; *complianceinfo@epa.gov*; *epa.gov/otaq/verify*.

(3) Director, Gasoline Engine Compliance Center, U.S. Environmental Protection Agency, 2000 Traverwood Drive, Ann Arbor, MI 48105; *nonroad-si-cert@epa.gov*; *epa.gov/otaq/verify*, for all the following engines and vehicles:

(i) For spark-ignition engines used in heavy-duty highway vehicles regulated under 40 CFR part 86, subpart A, and 40 CFR parts 1036 and 1037,

(ii) For highway motorcycles regulated under 40 CFR part 86, subpart E.

(iii) For nonroad and stationary spark-ignition engines or equipment regulated under 40 CFR parts 60, 1045, 1048, 1051, 1054, and 1060.

*Engine* means an engine block with an installed crankshaft, or a gas turbine engine. The term engine does not

include engine blocks without an installed crankshaft, nor does it include any assembly of reciprocating engine components that does not include the engine block. (**Note:** For purposes of this definition, any component that is the primary means of converting an engine's energy into usable work is considered a crankshaft, whether or not it is known commercially as a crankshaft.) This includes complete and partially complete engines as follows:

(1) A complete engine is a fully assembled engine in its final configuration. In the case of equipment-based standards, an engine is not considered complete until it is installed in the equipment, even if the engine itself is fully assembled.

(2) A partially complete engine is an engine that is not fully assembled or is not in its final configuration. Except where we specify otherwise in this part or the standard-setting part, partially complete engines are subject to the same standards and requirements as complete engines. The following would be considered examples of partially complete engines:

(i) An engine that is missing certain emission-related components.

(ii) A new engine that was originally assembled as a motor-vehicle engine that will be recalibrated for use as a nonroad engine.

(iii) A new engine that was originally assembled as a land-based engine that will be modified for use as a marine propulsion engine.

(iv) A short block consisting of a crankshaft and other engine components connected to the engine block, but missing the head assembly.

(v) A long block consisting of all engine components except the fuel system and an intake manifold.

(vi) In the case of equipment-based standards, a fully functioning engine that is not yet installed in the equipment. For example, a fully functioning engine that will be installed in an off-highway motorcycle or a locomotive is considered partially complete until it is installed in the equipment.

*Engine-based standard* means an emission standard expressed in units of grams of pollutant per kilowatt-hour (or grams of pollutant per horsepower-hour) that applies to the engine. Emission standards are either engine-based or equipment-based. Note that engines may be subject to additional standards such as smoke standards.

*Engine-based test* means an emission test intended to measure emissions in units of grams of pollutant per kilowatt-hour (or grams of pollutant per horsepower-hour), without regard to

whether the standard applies to the engine or equipment. Note that some products that are subject to engine-based testing are subject to additional test requirements such as for smoke.

*Engine configuration* means a unique combination of engine hardware and calibration within an engine family. Engines within a single engine configuration differ only with respect to normal production variability or factors unrelated to emissions.

*Engine/equipment* and *engines/equipment* mean engine(s) and/or equipment depending on the context. Specifically these terms mean the following:

- (1) Engine(s) when only engine-based standards apply.
- (2) Engine(s) for testing issues when engine-based testing applies.
- (3) Engine(s) and equipment when both engine-based and equipment-based standards apply.
- (4) Equipment when only equipment-based standards apply.
- (5) Equipment for testing issues when equipment-based testing applies.

*Equipment* means one of the following things:

- (1) Any vehicle, vessel, or other type of equipment that is subject to the requirements of this part or that uses an engine that is subject to the requirements of this part. An installed engine is part of the equipment. Motor vehicle trailers are a type of equipment that is subject to the requirements of this part.
- (2) Fuel-system components that are subject to an equipment-based standard under this chapter. Installed fuel-system components are also considered part of the engine/equipment to which they are attached.

*Equipment-based standard* means an emission standard that applies to the equipment in which an engine is used or to fuel-system components associated with an engine, without regard to how the emissions are measured. If equipment-based standards apply, we require that the equipment or fuel-system components be certified rather than just the engine. Emission standards are either engine-based or equipment-based. For example, recreational vehicles we regulate under 40 CFR part 1051 are subject to equipment-based standards even if emission measurements are based on engine operation alone.

*Excluded* means relating to engines/equipment that are not subject to emission standards or other requirements because they do not meet the definitions or other regulatory provisions that define applicability. For example, a non-stationary engine that is

used solely for off-highway competition is excluded from the requirements of this part because it meets neither the definition of "motor vehicle engine" nor "nonroad engine" under section 216 of the Clean Air Act.

*Exempted* means relating to engines/equipment that are subject to certain standards or other requirements, but are not required to meet those standards or requirements, subject to one or more qualifying conditions. Exempted engines/equipment must conform to regulatory conditions specified for an exemption in this part 1068 or in the standard-setting part. Engines/equipment exempted with respect to a certain tier of standards may be required to comply with an earlier tier of standards as a condition of the exemption; for example, engines exempted with respect to Tier 3 standards may be required to comply with Tier 1 or Tier 2 standards.

*Family* means engine family or emission family, as applicable, under the standard-setting part.

*Final deteriorated test result* has the meaning given in the standard-setting part. If it is not defined in the standard-setting part, it means the emission level that results from applying all appropriate adjustments (such as deterioration factors) to the measured emission result of the emission-data engine.

*Gas turbine engine* means anything commercially known as a gas turbine engine or any collection of assembled engine components that is substantially similar to engines commercially known as gas turbine engines. For example, a jet engine is a gas turbine engine. Gas turbine engines may be complete or partially complete. Turbines that rely on external combustion such as steam engines are not gas turbine engines.

*Good engineering judgment* means judgments made consistent with generally accepted scientific and engineering principles and all available relevant information. See § 1068.5.

*Manufacturer* has the meaning given in section 216(1) of the Clean Air Act (42 U.S.C. 7550(1)). In general, this term includes any person who manufactures or assembles an engine or piece of equipment for sale in the United States or otherwise introduces a new engine or piece of equipment into U.S. commerce. This includes importers that import new engines or new equipment into the United States for resale. It also includes secondary engine manufacturers.

*Model year* has the meaning given in the standard-setting part. Unless the standard-setting part specifies otherwise, model year for individual engines/equipment is based on the date

of manufacture or a later stage in the assembly process determined by the manufacturer, subject to the limitations described in §§ 1068.103 and 1068.360. The model year of a new engine that is neither certified nor exempt is deemed to be the calendar year in which it is sold, offered for sale, imported, or delivered or otherwise introduced into U.S. commerce.

*Motor vehicle* has the meaning given in 40 CFR 85.1703.

*New* has the meaning we give it in the standard-setting part. Note that in certain cases, used and remanufactured engines/equipment may be "new" engines/equipment.

*Nonroad engine* means:

- (1) Except as discussed in paragraph (2) of this definition, a nonroad engine is an internal combustion engine that meets any of the following criteria:
  - (i) It is (or will be) used in or on a piece of equipment that is self-propelled or serves a dual purpose by both propelling itself and performing another function (such as garden tractors, off-highway mobile cranes and bulldozers).
  - (ii) It is (or will be) used in or on a piece of equipment that is intended to be propelled while performing its function (such as lawnmowers and string trimmers).

(iii) By itself or in or on a piece of equipment, it is portable or transportable, meaning designed to be and capable of being carried or moved from one location to another. Indicia of transportability include, but are not limited to, wheels, skids, carrying handles, dolly, trailer, or platform.

(2) An internal combustion engine is not a nonroad engine if it meets any of the following criteria:

(i) The engine is used to propel a motor vehicle, an aircraft, or equipment used solely for competition.

(ii) The engine is regulated under 40 CFR part 60, (or otherwise regulated by a federal New Source Performance Standard promulgated under section 111 of the Clean Air Act (42 U.S.C. 7411)). Note that this criterion does not apply for engines meeting any of the criteria of paragraph (1) of this definition that are voluntarily certified under 40 CFR part 60.

(iii) The engine otherwise included in paragraph (1)(iii) of this definition remains or will remain at a location for more than 12 consecutive months or a shorter period of time for an engine located at a seasonal source. A location is any single site at a building, structure, facility, or installation. For any engine (or engines) that replaces an engine at a location and that is intended to perform the same or similar function as the engine replaced, include the time period

of both engines in calculating the consecutive time period. An engine located at a seasonal source is an engine that remains at a seasonal source during the full annual operating period of the seasonal source. A seasonal source is a stationary source that remains in a single location on a permanent basis (*i.e.*, at least two years) and that operates at that single location approximately three months (or more) each year. See § 1068.31 for provisions that apply if the engine is removed from the location.

*Operating hours* means:

(1) For engine and equipment storage areas or facilities, times during which people other than custodians and security personnel are at work near, and can access, a storage area or facility.

(2) For other areas or facilities, times during which an assembly line operates or any of the following activities occurs:

(i) Testing, maintenance, or service accumulation.

(ii) Production or compilation of records.

(iii) Certification testing.

(iv) Translation of designs from the test stage to the production stage.

(v) Engine or equipment manufacture or assembly.

*Parent company* means any entity that has a controlling ownership of another company. Note that the standard-setting part may treat a partial owner as a parent company even if it does not have controlling ownership of a company.

*Piece of equipment* means any vehicle, vessel, locomotive, aircraft, or other type of equipment equipped with engines to which this part applies.

*Placed into service* means used for its intended purpose. Engines/equipment do not qualify as being “placed into service” based on incidental use by a manufacturer or dealer.

*Reasonable technical basis* means information that would lead a person familiar with engine design and function to reasonably believe a conclusion related to compliance with the requirements of this part. For example, it would be reasonable to believe that parts performing the same function as the original parts (and to the same degree) would control emissions to the same degree as the original parts. Note that what is a reasonable basis for a person without technical training might not qualify as a reasonable technical basis.

*Relating to* as used in this section means relating to something in a specific, direct manner. This expression is used in this section only to define terms as adjectives and not to broaden the meaning of the terms. Note that “relating to” is used in the same manner as in the standard-setting parts.

*Replacement engine* means an engine exempted as a replacement engine under § 1068.240.

*Revoke* means to terminate the certificate or an exemption for a family. If we revoke a certificate or exemption, you must apply for a new certificate or exemption before continuing to introduce the affected engines/equipment into U.S. commerce. This does not apply to engines/equipment you no longer possess.

*Secondary engine manufacturer* means anyone who produces a new engine by modifying a complete or partially complete engine that was made by a different company. For the purpose of this definition, “modifying” does not include making changes that do not remove an engine from its original certified configuration. Secondary engine manufacturing includes, for example, converting automotive engines for use in industrial applications, or land-based engines for use in marine applications. This applies whether it involves a complete or partially complete engine and whether the engine was previously certified to emission standards or not.

(1) Manufacturers controlled by the manufacturer of the base engine (or by an entity that also controls the manufacturer of the base engine) are not secondary engine manufacturers; rather, both entities are considered to be one manufacturer for purposes of this part.

(2) This definition applies equally to equipment manufacturers that modify engines. Also, equipment manufacturers that certify to equipment-based standards using engines produced by another company are deemed to be secondary engine manufacturers.

(3) Except as specified in paragraph (2) of this definition, companies importing complete engines into the United States are not secondary engine manufacturers regardless of the procedures and relationships between companies for assembling the engines.

*Small business* means either of the following:

(1) A company that qualifies under the standard-setting part for special provisions for small businesses or small-volume manufacturers.

(2) A company that qualifies as a small business under the regulations adopted by the Small Business Administration at 13 CFR 121.201 if the standard-setting part does not establish such qualifying criteria.

*Standard-setting part* means a part in the Code of Federal Regulations that defines emission standards for a particular engine and/or piece of equipment (see § 1068.1(a)). For example, the standard-setting part for

marine spark-ignition engines is 40 CFR part 1045. For provisions related to evaporative emissions, the standard-setting part may be 40 CFR part 1060, as specified in 40 CFR 1060.1.

*Subsidiary* means an entity that is owned or controlled by a parent company.

*Sulfur-sensitive technology* means an emission control technology that experiences a significant drop in emission control performance or emission-system durability when an engine is operated on low-sulfur diesel fuel (*i.e.*, fuel with a sulfur concentration of 300 to 500 ppm) as compared to when it is operated on ultra low-sulfur diesel fuel (*i.e.*, fuel with a sulfur concentration less than 15 ppm). Exhaust gas recirculation is not a sulfur-sensitive technology.

*Suspend* means to temporarily discontinue the certificate or an exemption for a family. If we suspend a certificate, you may not sell, offer for sale, or introduce or deliver into commerce in the United States or import into the United States engines/equipment from that family unless we reinstate the certificate or approve a new one. This also applies if we suspend an exemption, unless we reinstate the exemption.

*Ultimate purchaser* means the first person who in good faith purchases a new engine or new piece of equipment for purposes other than resale.

*United States*, in a geographic sense, means the States, the District of Columbia, the Commonwealth of Puerto Rico, the Commonwealth of the Northern Mariana Islands, Guam, American Samoa, and the U.S. Virgin Islands.

*U.S.-directed production volume* has the meaning given in the standard-setting part.

*Void* means to invalidate a certificate or an exemption *ab initio* (“from the beginning”). If we void a certificate, all the engines/equipment introduced into U.S. commerce under that family for that model year are considered uncertified (or nonconforming) and are therefore not covered by a certificate of conformity, and you are liable for all engines/equipment introduced into U.S. commerce under the certificate and may face civil or criminal penalties or both. This applies equally to all engines/equipment in the family, including engines/equipment introduced into U.S. commerce before we voided the certificate. If we void an exemption, all the engines/equipment introduced into U.S. commerce under that exemption are considered uncertified (or nonconforming), and you are liable for engines/equipment introduced into U.S.

commerce under the exemption and may face civil or criminal penalties or both. You may not sell, offer for sale, or introduce or deliver into commerce in the United States or import into the United States any additional engines/equipment using the voided exemption.

*Voluntary emission recall* means a repair, adjustment, or modification program voluntarily initiated and conducted by a manufacturer to remedy any emission-related defect for which engine owners have been notified.

*We (us, our)* means the Administrator of the Environmental Protection Agency and any authorized representatives.

■ 324. Section 1068.31 is amended by revising the section heading, the introductory text, and paragraph (c) to read as follows:

**§ 1068.31 Changing the status of nonroad or stationary engines under the definition of “nonroad engine”.**

This section specifies the provisions that apply when an engine previously used in a nonroad application is subsequently used in an application other than a nonroad application, or when an engine previously used in a stationary application (*i.e.*, an engine that was not used as a nonroad engine and that was not used to propel a motor vehicle, an aircraft, or equipment used solely for competition) is moved.

\* \* \* \* \*

(c) A stationary engine does not become a new nonroad engine if it is moved but continues to meet the criteria specified in paragraph (2)(iii) in the definition of “nonroad engine” in § 1068.30 in its new location. For example, a transportable engine that is used in a single specific location for 18 months and is later moved to a second specific location where it will remain for at least 12 months is considered to be a stationary engine in both locations. Note that for stationary engines that are neither portable nor transportable in actual use, the residence-time restrictions in the definition of “nonroad engine” generally do not apply.

\* \* \* \* \*

■ 325. Section 1068.32 is added to read as follows:

**§ 1068.32 Explanatory terms.**

This section explains how certain phrases and terms are used in 40 CFR parts 1000 through 1099, especially those used to clarify and explain regulatory provisions.

(a) *Types of provisions.* The term “provision” includes all aspects of the regulations in this subchapter U. As described in this section, regulatory

provisions include standards, requirements, prohibitions, and allowances, along with a variety of other types of provisions. In certain cases, we may use these terms to apply to some but not all of the provisions of a part or section. For example, we may apply the allowances of a section for certain engines, but not the requirements. We may also apply all provisions except the requirements and prohibitions.

(1) A standard is a requirement established by regulation that limits the emissions of air pollutants. Examples of standards include numerical emission standards (such as 0.01 g/kW-hr) and design standards (such as a closed crankcase standard). Compliance with or conformance to a standard is a specific type of requirement, and in some cases a standard may be discussed as a requirement. Thus, a statement about the requirements of a part or section also applies with respect to the standards of the part or section.

(2) The regulations in subchapter U of this chapter apply other requirements in addition to standards. For example, manufacturers are required to keep records and provide reports to EPA.

(3) While requirements state what someone must do, prohibitions state what someone may not do. Prohibitions are often referred to as prohibited acts or prohibited actions. Most penalties apply for violations of prohibitions. A list of prohibitions may therefore include the failure to meet a requirement as a prohibited action.

(4) Allowances provide some form of relief from requirements. This may include provisions delaying implementation, establishing exemptions or test waivers, or creating alternative compliance options. Allowances may be conditional. For example, we may exempt you from certain requirements on the condition that you meet certain other requirements.

(5) The regulations in subchapter U of this chapter also include important provisions that are not standards, requirements, prohibitions, or allowances, such as definitions.

(6) Engines/equipment are generally considered “*subject to*” a specific provision if that provision applies, or if it does not apply because of an exemption authorized under the regulation. For example, locomotives are subject to the provisions of 40 CFR part 1033 even if they are exempted from the standards of part 1033.

(b) *Singular and plural.* Unless stated otherwise or unless it is clear from the regulatory context, provisions written in singular form include the plural form and provisions written in plural form

include the singular form. For example, the statement “The manufacturer must keep this report for three years” is equivalent to “The manufacturers must keep these reports for three years.”

(c) *Inclusive lists.* Lists in the regulations in subchapter U of this chapter prefaced by “including” or “this includes” are not exhaustive. The terms “including” and “this includes” should be read to mean “including but not limited to” and “this includes but is not limited to”. For example, the phrase “including small manufacturers” does not exclude large manufacturers. However, prescriptive statements to “include” specific items (such as those related to recordkeeping and reporting requirements) may be exhaustive.

(d) *Notes.* Statements that begin with “Note:” or “Note that” are intended to clarify specific regulatory provisions stated elsewhere in the regulations in subchapter U of this chapter. By themselves, such statements are not intended to specify regulatory requirements. Such statements are typically used for regulatory text that, while legally sufficient to specify a requirement, may be misunderstood by some readers. For example, the regulations might note that a word is defined elsewhere in the regulations to have a specific meaning that may be either narrower or broader than some readers might assume.

(e) *Examples.* Examples provided in the regulations in subchapter U of this chapter are typically introduced by either “for example” or “such as”. Specific examples given in the regulations do not necessarily represent the most common examples. The regulations may specify examples conditionally (that is, specifying that they are applicable only if certain criteria or conditions are met). Lists of examples cannot be presumed to be exhaustive lists.

(f) *Generally and typically.* Statements that begin with “generally”, “in general”, or “typically” should not be read to apply universally or absolutely. Rather they are intended to apply for the most common circumstances.

“Generally” and “typically” statements may be identified as notes as described in paragraph (d) of this section.

(g) *Unusual circumstances.* The regulations in subchapter U of this chapter specify certain allowances that apply “in unusual circumstances”. While it is difficult to precisely define what “unusual circumstances” means, this generally refers to specific circumstances that are both rare and unforeseeable. For example, a severe hurricane in the northeastern United States may be considered to be an

unusual circumstance, while a less severe hurricane in the southeastern United States may not be. Where the regulations limit an allowance to unusual circumstances, manufacturers and others should not presume that such an allowance will be available to them. Provisions related to unusual circumstances may be described using the phrase "normal circumstances", which are those circumstances that are not unusual circumstances.

(h) *Exceptions and other specifications.* Regulatory provisions may be expressed as a general prohibition, requirement, or allowance that is modified by other regulatory text. Such provisions may include phrases such as "unless specified otherwise", "except as specified", or "as specified in this section". It is important that the exceptions and the more general statement be considered together. This regulatory construct is intended to allow the core requirement or allowance to be stated in simple, clear sentences, rather than more precise and comprehensive sentences that may be misread. For example, where an action is prohibited in most but not all circumstances, the provision may state that you may not take the action, "except as specified in this section." The exceptions could then be stated in subsequent regulatory text.

■ 326. Revise the section heading for § 1068.35 to read as follows:

**§ 1068.35 Symbols, acronyms, and abbreviations.**

\* \* \* \* \*

■ 327. Section 1068.40 is amended by revising the section heading and paragraph (a) and removing paragraph (c).

The revisions read as follows:

**§ 1068.40 Special provisions for implementing changes in the regulations in this part.**

(a) During the 12 months following the effective date of any change in the provisions of this part, you may ask to apply the previously applicable provisions. Note that the effective date is generally 30 or 60 days after publication in the **Federal Register**, as noted in the final rule. We will generally approve your request if you can demonstrate that it would be impractical to comply with the new requirements. We may consider the potential for adverse environmental impacts in our decision. Similarly, in unusual circumstances, you may ask for relief under this paragraph (a) from new requirements that apply under the standard-setting part.

\* \* \* \* \*

■ 328. Section 1068.45 is amended by revising paragraph (e) and adding paragraphs (g) and (h) to read as follows:

**§ 1068.45 General labeling provisions.**

\* \* \* \* \*

(e) *Prohibitions against removing labels.* As specified in § 1068.101(b)(7), removing permanent labels is prohibited except for certain circumstances. Removing temporary or removable labels prematurely is also prohibited by § 1068.101(b)(7).

\* \* \* \* \*

(g) *Date format.* If you use a coded approach to identify the engine/equipment's date of manufacture, describe or interpret the code in your application for certification.

(h) *Branding.* The following provisions apply if you identify the name and trademark of another company instead of your own on your emission control information label, as provided in the standard-setting part:

(1) You must have a contractual agreement with the other company that obligates that company to take the following steps:

(i) Meet the emission warranty requirements that apply under the standard-setting part. This may involve a separate agreement involving reimbursement of warranty-related expenses.

(ii) Report all warranty-related information to the certificate holder.

(2) In your application for certification, identify the company whose trademark you will use.

(3) You remain responsible for meeting all the requirements of this chapter, including warranty and defect-reporting provisions.

■ 329. Section 1068.95 is revised to read as follows:

**§ 1068.95 Incorporation by reference.**

(a) Certain material is incorporated by reference into this part with the approval of the Director of the Federal Register under 5 U.S.C. 552(a) and 1 CFR part 51. To enforce any edition other than that specified in this section, the Environmental Protection Agency must publish a document in the **Federal Register** and the material must be available to the public. All approved materials are available for inspection at the Air and Radiation Docket and Information Center (Air Docket) in the EPA Docket Center (EPA/DC) at Rm. 3334, EPA West Bldg., 1301 Constitution Ave. NW., Washington, DC. The EPA/DC Public Reading Room hours of operation are 8:30 a.m. to 4:30 p.m., Monday through Friday, excluding legal holidays. The telephone number of the EPA/DC Public Reading Room is

(202) 566-1744, and the telephone number for the Air Docket is (202) 566-1742. These approved materials are also available for inspection at the National Archives and Records Administration (NARA). For information on the availability of this material at NARA, call (202) 741-6030 or go to [http://www.archives.gov/federal\\_register/code\\_of\\_federal\\_regulations/ibr\\_locations.html](http://www.archives.gov/federal_register/code_of_federal_regulations/ibr_locations.html). In addition, these materials are available from the sources listed below.

(b) SAE International, 400 Commonwealth Dr., Warrendale, PA 15096-0001, (724) 776-4841, or <http://www.sae.org>;

(1) SAE J1930, Electrical/Electronic Systems Diagnostic Terms, Definitions, Abbreviations, and Acronyms, revised October 2008 ("SAE J1930"), IBR approved for § 1068.45(f).

(2) [Reserved]

**Subpart B—Prohibited Actions and Related Requirements**

■ 330. Section 1068.101 is amended by revising the introductory text and paragraphs (a)(1) through (3), (b)(1) introductory text, (b)(2), (b)(3), (b)(4), (b)(5) introductory text, (b)(6), and (h) introductory text to read as follows:

**§ 1068.101 What general actions does this regulation prohibit?**

This section specifies actions that are prohibited and the maximum civil penalties that we can assess for each violation in accordance with 42 U.S.C. 7522 and 7524. The maximum penalty values listed in paragraphs (a) and (b) of this section and in § 1068.125 apply as of August 1, 2016. As described in paragraph (h) of this section, these maximum penalty limits are different for earlier violations and they may be adjusted as set forth in 40 CFR part 19.

(a) \* \* \*

(1) *Introduction into commerce.* You may not sell, offer for sale, or introduce or deliver into commerce in the United States or import into the United States any new engine/equipment after emission standards take effect for the engine/equipment, unless it is covered by a valid certificate of conformity for its model year and has the required label or tag. You also may not take any of the actions listed in the previous sentence with respect to any equipment containing an engine subject to this part's provisions unless the engine is covered by a valid certificate of conformity for its model year and has the required engine label or tag. We may assess a civil penalty up to \$44,539 for each engine or piece of equipment in violation.

(i) For purposes of this paragraph (a)(1), a valid certificate of conformity is one that applies for the same model year as the model year of the equipment (except as allowed by § 1068.105(a)), covers the appropriate category or subcategory of engines/equipment (such as locomotive or sterndrive/inboard Marine SI or nonhandheld Small SI), and conforms to all requirements specified for equipment in the standard-setting part. Engines/equipment are considered not covered by a certificate unless they are in a configuration described in the application for certification.

(ii) The prohibitions of this paragraph (a)(1) also apply for new engines you produce to replace an older engine in a piece of equipment, except that the engines may qualify for the replacement-engine exemption in § 1068.240.

(iii) The prohibitions of this paragraph (a)(1) also apply for new engines that will be installed in equipment subject to equipment-based standards, except that the engines may qualify for an exemption under § 1068.260(c) or § 1068.262.

(iv) Where the regulations specify that you are allowed to introduce engines/equipment into U.S. commerce without a certificate of conformity, you may take any of the otherwise prohibited actions specified in this paragraph (a)(1) with respect to those engines/equipment.

(2) *Reporting and recordkeeping.* This chapter requires you to record certain types of information to show that you meet our standards. You must comply with these requirements to make and maintain required records (including those described in § 1068.501). You may not deny us access to your records or the ability to copy your records if we have the authority to see or copy them. Also, you must give us complete and accurate reports and information without delay as required under this chapter. Failure to comply with the requirements of this paragraph is prohibited. We may assess a civil penalty up to \$44,539 for each day you are in violation. In addition, knowingly submitting false information is a violation of 18 U.S.C. 1001, which may involve criminal penalties and up to five years imprisonment.

(3) *Testing and access to facilities.* You may not keep us from entering your facility to test engines/equipment or inspect if we are authorized to do so. Also, you must perform the tests we require (or have the tests done for you). Failure to perform this testing is prohibited. We may assess a civil penalty up to \$44,539 for each day you are in violation.

(b) \* \* \*

(1) *Tampering.* You may not remove or render inoperative any device or element of design installed on or in engines/equipment in compliance with the regulations prior to its sale and delivery to the ultimate purchaser. You also may not knowingly remove or render inoperative any such device or element of design after such sale and delivery to the ultimate purchaser. This includes, for example, operating an engine without a supply of appropriate quality urea if the emission control system relies on urea to reduce NO<sub>x</sub> emissions or the use of incorrect fuel or engine oil that renders the emission control system inoperative. Section 1068.120 describes how this applies to rebuilding engines. See the standard-setting part, which may include additional provisions regarding actions prohibited by this requirement. For a manufacturer or dealer, we may assess a civil penalty up to \$44,539 for each engine or piece of equipment in violation. For anyone else, we may assess a civil penalty up to \$4,454 for each engine or piece of equipment in violation. This prohibition does not apply in any of the following situations:

\* \* \* \* \*

(2) *Defeat devices.* You may not knowingly manufacture, sell, offer to sell, or install, any component that bypasses, impairs, defeats, or disables the control of emissions of any regulated pollutant, except as explicitly allowed by the standard-setting part. We may assess a civil penalty up to \$4,454 for each component in violation.

(3) *Stationary engines.* For an engine that is excluded from any requirements of this chapter because it is a stationary engine, you may not move it or install it in any mobile equipment except as allowed by the provisions of this chapter. You may not circumvent or attempt to circumvent the residence-time requirements of paragraph (2)(iii) of the nonroad engine definition in § 1068.30. Anyone violating this paragraph (b)(3) is deemed to be a manufacturer in violation of paragraph (a)(1) of this section. We may assess a civil penalty up to \$44,539 for each engine or piece of equipment in violation.

(4) *Competition engines/equipment.* (i) For uncertified engines/equipment that are excluded or exempted as new engines/equipment from any requirements of this chapter because they are to be used solely for competition, you may not use any of them in a manner that is inconsistent with use solely for competition. Anyone violating this paragraph (b)(4)(i) is

deemed to be a manufacturer in violation of paragraph (a)(1) of this section. We may assess a civil penalty up to \$44,539 for each engine or piece of equipment in violation. (ii) For certified nonroad engines/equipment that qualify for exemption from the tampering prohibition as described in § 1068.235 because they are to be used solely for competition, you may not use any of them in a manner that is inconsistent with use solely for competition. Anyone violating this paragraph (b)(4)(ii) is in violation of paragraph (b)(1) or (2) of this section.

(5) *Importation.* You may not import an uncertified engine or piece of equipment if it is defined to be new in the standard-setting part with a model year for which emission standards applied. Anyone violating this paragraph (b)(5) is deemed to be a manufacturer in violation of paragraph (a)(1) of this section. We may assess a civil penalty up to \$44,539 for each engine or piece of equipment in violation. Note the following:

\* \* \* \* \*

(6) *Warranty, recall, and maintenance instructions.* You must meet your obligation to honor your emission-related warranty under § 1068.115, including any commitments you identify in your application for certification. You must also fulfill all applicable requirements under subpart F of this part related to emission-related defects and recalls. You must also provide emission-related installation and maintenance instructions as described in the standard-setting part. Failure to meet these obligations is prohibited. Also, except as specifically provided by regulation, you are prohibited from directly or indirectly communicating to the ultimate purchaser or a later purchaser that the emission-related warranty is valid only if the owner has service performed at authorized facilities or only if the owner uses authorized parts, components, or systems. We may assess a civil penalty up to \$44,539 for each engine or piece of equipment in violation.

\* \* \* \* \*

(h) The maximum penalty values listed in paragraphs (a) and (b) of this section and in § 1068.125 apply as of August 1, 2016. Maximum penalty values for earlier violations are published in 40 CFR part 19. Maximum penalty limits may be adjusted after August 1, 2016 based on the Consumer Price Index. The specific regulatory provisions for changing the maximum penalties, published in 40 CFR part 19, reference the applicable U.S. Code citation on which the prohibited action

is based. The following table is shown here for informational purposes:

\* \* \* \* \*

■ 331. Section 1068.103 is revised to read as follows:

**§ 1068.103 Provisions related to the duration and applicability of certificates of conformity.**

(a) Engines/equipment covered by a certificate of conformity are limited to those that are produced during the period specified in the certificate and conform to the specifications described in the certificate and the associated application for certification. For the purposes of this paragraph (a), “specifications” includes the emission control information label and any conditions or limitations identified by the manufacturer or EPA. For example, if the application for certification specifies certain engine configurations, the certificate does not cover any configurations that are not specified. We may ignore any information provided in the application that we determine is not relevant to a demonstration of compliance with applicable regulations, such as your projected production volumes in many cases.

(b) Unless the standard-setting part specifies otherwise, determine the production period corresponding to each certificate of conformity as specified in this paragraph (b). In general, the production period is the manufacturer’s annual production period identified as a model year.

(1) For engines/equipment subject to emission standards based on model years, the first day of the annual production period can be no earlier than January 2 of the calendar year preceding the year for which the model year is named, or the earliest date of manufacture for any engine/equipment in the engine family, whichever is later. The last day of the annual production period can be no later than December 31 of the calendar year for which the model year is named or the latest date of manufacture for any engine/equipment in the engine family, whichever is sooner. Note that this approach limits how you can designate a model year for your engines/equipment; however, it does not limit your ability to meet more stringent emission standards early where this is permitted in the regulation.

(2) For fuel-system components certified to evaporative emission standards based on production periods rather than model years, the production period is either the calendar year or a longer period we specify consistent with the manufacturer’s normal production practices.

(c) A certificate of conformity will not cover engines/equipment you produce with a date of manufacture earlier than the date you submit the application for certification for the family. You may start to produce engines/equipment after you submit an application for certification and before the effective date of a certificate of conformity, subject to the following conditions:

(1) The engines/equipment must conform in all material respects to the engines/equipment described in your application. Note that if we require you to modify your application, you must ensure that all engines/equipment conform to the specifications of the modified application.

(2) The engines/equipment may not be sold, offered for sale, introduced into U.S. commerce, or delivered for introduction into U.S. commerce before the effective date of the certificate of conformity.

(3) You must notify us in your application for certification that you plan to use the provisions of this paragraph (c) and when you intend to start production. If the standard-setting part specifies mandatory testing for production-line engines, you must start testing as directed in the standard-setting part based on your actual start of production, even if that occurs before we approve your certification. You must also agree to give us full opportunity to inspect and/or test the engines/equipment during and after production. For example, we must have the opportunity to specify selective enforcement audits as allowed by the standard-setting part and the Clean Air Act as if the engines/equipment were produced after the effective date of the certificate.

(4) See § 1068.262 for special provisions that apply for secondary engine manufacturers receiving shipment of partially complete engines before the effective date of a certificate.

(d) The prohibition in § 1068.101(a)(1) against offering to sell engines/equipment without a valid certificate of conformity generally does not apply for engines/equipment that have not yet been produced. You may contractually agree to produce engines/equipment before obtaining the required certificate of conformity. This is intended to allow manufacturers of low-volume products to establish a sufficient market for engines/equipment before going through the effort to certify.

(e) Engines/equipment with a date of manufacture after December 31 of the calendar year for which a model year is named are not covered by the certificate of conformity for that model year. You must submit an application for a new

certificate of conformity demonstrating compliance with applicable standards even if the engines/equipment are identical to those with a date of manufacture before December 31.

(f) The flexible approach to naming the annual production period described in paragraph (b)(1) of this section is intended to allow you to introduce new products at any point during the year. This is based on the expectation that production periods generally run on consistent schedules from year to year. You may not use this flexibility to arrange your production periods such that you can avoid annual certification.

(g) An engine is generally assigned a model year based on its date of manufacture, which is typically based on the date the crankshaft is installed in the engine (see § 1068.30). You may not circumvent the provisions of § 1068.101(a)(1) by stockpiling engines with a date of manufacture before new or changed emission standards take effect by deviating from your normal production and inventory practices. (For purposes of this paragraph (g), normal production and inventory practices means those practices you typically use for similar families in years in which emission standards do not change. We may require you to provide us routine production and inventory records that document your normal practices for the preceding eight years.) For most engines you should plan to complete the assembly of an engine of a given model year into its certified configuration within the first week after the end of the model year if new emission standards start to apply in that model year. For special circumstances it may be appropriate for your normal business practice to involve more time. For engines with per-cylinder displacement below 2.5 liters, if new emission standards start to apply in a given year, we would consider an engine not to be covered by a certificate of conformity for the preceding model year if the engine is not assembled in a compliant configuration within 30 days after the end of the model year for that engine family. (**Note:** an engine is considered “in a compliant configuration” without being fully assembled if § 1068.260(a) or (b) authorizes shipment of the engine without certain components.) For example, in the case where new standards apply in the 2010 model year, and your normal production period is based on the calendar year, you must complete the assembly of all your 2009 model year engines before January 31, 2010, or an earlier date consistent with your normal production and inventory practices. For engines with per-cylinder displacement at or above 2.5 liters, this



time may not exceed 60 days. Note that for the purposes of this paragraph (g), an engine shipped under § 1068.261 is deemed to be a complete engine. Note also that § 1068.245 allows flexibility for additional time in unusual circumstances. Note finally that disassembly of complete engines and reassembly (such as for shipment) does not affect the determination of model year; the provisions of this paragraph (g) apply based on the date on which initial assembly is complete.

(h) This paragraph (h) describes the effect of suspending, revoking, or voiding a certificate of conformity. See the definitions of “suspend,” “revoke,” and “void” in § 1068.30. Engines/equipment produced at a time when the otherwise applicable certificate of conformity has been suspended or revoked are not covered by a certificate of conformity. Where a certificate of conformity is void, all engines/equipment produced under that certificate of conformity are not and were not covered by a certificate of conformity. In cases of suspension, engines/equipment will be covered by a certificate only if they are produced after the certificate is reinstated or a new certificate is issued. In cases of revocation and voiding, engines/equipment will be covered by a certificate only if they are produced after we issue a new certificate. 42 U.S.C. 7522(a)(1) and § 1068.101(a)(1) prohibit selling, offering for sale, introducing into commerce, delivering for introduction into commerce, and importing engines/equipment that are not covered by a certificate of conformity, and they prohibit anyone from causing another to violate these prohibitions.

(i) You may transfer a certificate to another entity only in the following cases:

(1) You may transfer a certificate to a parent company, including a parent company that purchases your company after we have issued your certificate.

(2) You may transfer a certificate to a subsidiary including a subsidiary you purchase after we have issued your certificate.

(3) You may transfer a certificate to a subsidiary of your parent company.

■ 332. Section 1068.105 is amended by revising paragraphs (a) and (c)(2) to read as follows:

**§ 1068.105 What other provisions apply to me specifically if I manufacture equipment needing certified engines?**

\* \* \* \* \*

(a) *Transitioning to new engine-based standards.* If new engine-based emission standards apply in a given model year,

your equipment produced in that calendar year (or later) must have engines that are certified to the new standards, except that you may continue to use up normal inventories of engines that were built before the date of the new or changed standards. For purposes of this paragraph (a), normal inventory applies for engines you possess and engines from your engine supplier's normal inventory. (Note: this paragraph (a) does not apply in the case of new remanufacturing standards.) We may require you and your engine suppliers to provide us routine production and/or inventory records that document your normal practices for the preceding eight years. For example, if you have records documenting that your normal inventory practice is to keep on hand a one-month supply of engines based on your upcoming production schedules, and a new tier of standards starts to apply for the 2015 model year, you may order engines consistent with your normal inventory requirements late in the engine manufacturer's 2014 model year and install those engines in your equipment consistent with your normal production schedule. Also, if your model year starts before the end of the calendar year preceding new standards, you may use engines from the previous model year for those units you completely assemble before January 1 of the year that new standards apply. If emission standards for the engine do not change in a given model year, you may continue to install engines from the previous model year without restriction (or any earlier model year for which the same standards apply). You may not circumvent the provisions of § 1068.101(a)(1) by stockpiling engines that were built before new or changed standards take effect. Similarly, you may not circumvent the provisions of § 1068.101(a)(1) by knowingly installing engines that were stockpiled by engine suppliers in violation of § 1068.103(f). Note that this allowance does not apply for equipment subject to equipment-based standards. See 40 CFR 1060.601 for similar provisions that apply for equipment subject to evaporative emission standards. Note that the standard-setting part may impose further restrictions on using up inventories of engines from an earlier model year under this paragraph (a).

\* \* \* \* \*

(c) \* \* \*

(2) Permanently attach the duplicate label to your equipment by securing it to a part needed for normal operation and not normally requiring replacement. Make sure an average person can easily read it. Note that attaching an inaccurate

duplicate label may be a violation of § 1068.101(b)(7).

\* \* \* \* \*

■ 333. Section 1068.110 is amended by revising the section heading and paragraph (d) to read as follows:

**§ 1068.110 Other provisions for engines/equipment in service.**

\* \* \* \* \*

(d) *Defeat devices.* We may test components, engines, and equipment to investigate potential defeat devices. We may also require the manufacturer to do this testing. If we choose to investigate one of your designs, we may require you to show us that a component is not a defeat device, and that an engine/equipment does not have a defeat device. To do this, you may have to share with us information regarding test programs, engineering evaluations, design specifications, calibrations, on-board computer algorithms, and design strategies. It is a violation of the Clean Air Act for anyone to make, install or use defeat devices as described in § 1068.101(b)(2) and the standard-setting part.

\* \* \* \* \*

■ 334. Section 1068.115 is amended by revising the section heading to read as follows:

**§ 1068.115 What are manufacturers' emission-related warranty requirements?**

\* \* \* \* \*

■ 335. Section 1068.120 is amended by revising the section heading and paragraph (f) to read as follows:

**§ 1068.120 Requirements for rebuilding engines.**

\* \* \* \* \*

(f) A rebuilt engine or other used engine may replace a certified engine in a piece of equipment only if the engine was built and/or rebuilt to a certified configuration meeting equivalent or more stringent emission standards. Note that a certified configuration would generally include more than one model year. A rebuilt engine being installed that is from the same model year or a newer model year than the engine being replaced meets this requirement. The following examples illustrate the provisions of this paragraph (f):

(1) In most cases, you may use a rebuilt Tier 2 engine to replace a Tier 1 engine or another Tier 2 engine.

(2) You may use a rebuilt Tier 1 engine to replace a Tier 2 engine if the two engines differ only with respect to model year or other characteristics unrelated to emissions since such engines would be considered to be in the same configuration. This may occur if the Tier 1 engine had emission levels



below the Tier 2 standards or if the Tier 2 engine was certified with a Family Emission Limit for calculating emission credits.

(3) You may use a rebuilt engine that originally met the Tier 1 standards without certification, as provided under § 1068.265, to replace a certified Tier 1 engine. This may occur for engines produced under a Transition Program for Equipment Manufacturers such as that described in 40 CFR 1039.625.

(4) You may never replace a certified engine with an engine rebuilt to a configuration that does not meet EPA emission standards. Note that, for purposes of this paragraph (f)(4), a configuration is considered to meet EPA emission standards if it was previously certified or was otherwise shown to meet emission standards (see § 1068.265).

(5) The standard-setting part may apply further restrictions to situations involving installation of used engines to repower equipment. For example, see 40 CFR part 1037 for provisions that apply for glider vehicles.

\* \* \* \* \*

■ 336. Section 1068.125 is amended by revising paragraph (b) introductory text to read as follows:

**§ 1068.125 What happens if I violate the regulations?**

\* \* \* \* \*

(b) *Administrative penalties.* Instead of bringing a civil action, we may assess administrative penalties if the total is less than \$356,312 against you individually. This maximum penalty may be greater if the Administrator and the Attorney General jointly determine that a greater administrative penalty assessment is appropriate, or if the limit is adjusted under 40 CFR part 19. No court may review this determination. Before we assess an administrative penalty, you may ask for a hearing as described in subpart G of this part. The Administrator may compromise or remit, with or without conditions, any administrative penalty that may be imposed under this section.

\* \* \* \* \*

**Subpart C—Exemptions and Exclusions**

■ 337. Section 1068.201 is amended by revising the section heading, introductory text, and paragraphs (a) and (c) to read as follows:

**§ 1068.201 General exemption and exclusion provisions.**

We may exempt new engines/equipment from some or all of the prohibited acts or requirements of this

part under provisions described in this subpart. We may exempt nonroad engines/equipment already placed in service in the United States from the prohibition in § 1068.101(b)(1) if the exemption for nonroad engines/equipment used solely for competition applies (see § 1068.235). In addition, see § 1068.1 and the standard-setting parts to determine if other engines/equipment are excluded from some or all of the regulations in this chapter.

(a) This subpart identifies which engines/equipment qualify for exemptions and what information we need. We may require more information.

\* \* \* \* \*

(c) If you use an exemption under this subpart, we may require you to add a permanent or removable label to your exempted engines/equipment. You may ask us to modify these labeling requirements if it is appropriate for your engine/equipment.

\* \* \* \* \*

■ 338. Section 1068.210 is amended by revising the section heading and paragraph (e) to read as follows:

**§ 1068.210 Exempting test engines/equipment.**

\* \* \* \* \*

(e) If we approve your request for a testing exemption, we will send you a letter or a memorandum describing the basis and scope of the exemption. It will also include any necessary terms and conditions, which normally require you to do the following:

- (1) Stay within the scope of the exemption.
- (2) Create and maintain adequate records that we may inspect.
- (3) Add a permanent label to all engines/equipment exempted under this section, consistent with § 1068.45, with at least the following items:
  - (i) The label heading “EMISSION CONTROL INFORMATION”.
  - (ii) Your corporate name and trademark.
  - (iii) Engine displacement, family identification, and model year of the engine/equipment (as applicable), or whom to contact for further information.
  - (iv) The statement: “THIS [engine, equipment, vehicle, etc.] IS EXEMPT UNDER 40 CFR 1068.210 OR 1068.215 FROM EMISSION STANDARDS AND RELATED REQUIREMENTS.”

(4) Tell us when the test program is finished.

(5) Tell us the final disposition of the engines/equipment.

■ 339. Section 1068.215 is amended by revising the section heading and paragraphs (a) and (c)(3)(iv) to read as follows:

**§ 1068.215 Exempting manufacturer-owned engines/equipment.**

(a) You are eligible for this exemption for manufacturer-owned engines/equipment only if you are a certificate holder. Any engine for which you meet all applicable requirements under this section is exempt without request.

\* \* \* \* \*

(c) \* \* \*

(3) \* \* \*

(iv) The statement: “THIS [engine, equipment, vehicle, etc.] IS EXEMPT UNDER 40 CFR 1068.210 OR 1068.215 FROM EMISSION STANDARDS AND RELATED REQUIREMENTS.”

■ 340. Section 1068.220 is revised to read as follows:

**§ 1068.220 Exempting display engines/equipment.**

(a) Anyone may request an exemption for display engines/equipment.

(b) Nonconforming display engines/equipment will be exempted if they are used only for displays in the interest of a business or the general public. This exemption does not apply to engines/equipment displayed for private use, private collections, or any other purpose we determine is inappropriate for a display exemption.

(c) You may operate the exempted engine/equipment, but only if we approve specific operation that is part of the display, or is necessary for the display (possibly including operation that is indirectly necessary for the display). We may consider any relevant factor in our approval process, including the extent of the operation, the overall emission impact, and whether the engine/equipment meets emission requirements of another country.

(d) You may sell or lease the exempted engine/equipment only with our advance approval.

(e) To use this exemption, you must add a permanent label to all engines/equipment exempted under this section, consistent with § 1068.45, with at least the following items:

- (1) The label heading “EMISSION CONTROL INFORMATION”.
- (2) Your corporate name and trademark.
- (3) Engine displacement, family identification, and model year of the engine/equipment (as applicable), or whom to contact for further information.

(4) The statement: “THIS [engine, equipment, vehicle, etc.] IS EXEMPT UNDER 40 CFR 1068.220 FROM EMISSION STANDARDS AND RELATED REQUIREMENTS.”

(f) We may set other conditions for approval of this exemption.

■ 341. Section 1068.225 is revised to read as follows:

**§ 1068.225 Exempting engines/equipment for national security.**

The standards and requirements of the standard-setting part and the prohibitions in § 1068.101(a)(1) and (b) do not apply to engines exempted under this section.

(a) An engine/equipment is exempt without a request if it will be owned by an agency of the Federal Government responsible for national defense and it meets at least one of the following criteria:

(1) An engine is automatically exempt in cases where the equipment in which it will be installed has armor, permanently attached weaponry, or other substantial features typical of military combat. Similarly, equipment subject to equipment-based standards is automatically exempt if it has any of these same features.

(2) In the case of marine vessels with compression-ignition engines, an engine is automatically exempt if the vessel in which it will be installed has specialized electronic warfare systems, unique stealth performance requirements, or unique combat maneuverability requirements.

(3) Gas turbine engines installed in marine vessels are automatically exempt.

(4) An engine/equipment is automatically exempt if it would need sulfur-sensitive technology to comply with emission standards, and it is intended to be used in areas outside the United States where ultra low-sulfur fuel is unavailable.

(b) For the circumstances described in paragraphs (a)(1) and (2) of this section, an engine/equipment is also exempt without a request if it will be used, but not owned, by an agency of the Federal Government responsible for national defense.

(c) Manufacturers may produce and ship engines/equipment under an automatic exemption as described in paragraph (a) or (b) of this section if they receive a written request for such engines/equipment from the appropriate federal agency.

(d) Manufacturers may request a national security exemption for engines/equipment not meeting the conditions of paragraphs (a) and (b) of this section as long as the request is endorsed by an agency of the Federal Government responsible for national defense. In your request, explain why you need the exemption.

(e) Add a permanent label to all engines/equipment exempted under this

section, consistent with § 1068.45, with at least the following items:

(1) The label heading "EMISSION CONTROL INFORMATION".

(2) Your corporate name and trademark.

(3) Engine displacement, family identification, and model year of the engine/equipment (as applicable), or whom to contact for further information.

(4) The statement: "THIS [engine, equipment, vehicle, etc.] HAS AN EXEMPTION FOR NATIONAL SECURITY UNDER 40 CFR 1068.225."

■ 342. Section 1068.230 is amended by revising the section heading and paragraphs (b) and (c) to read as follows:

**§ 1068.230 Exempting engines/equipment for export.**

\* \* \* \* \*

(b) Engines/equipment exported to a country not covered by paragraph (a) of this section are exempt from the prohibited acts in this part without a request. If you produce exempt engines/equipment for export and any of them are sold or offered for sale to an ultimate purchaser in the United States, the exemption is automatically void for those engines/equipment, except as specified in § 1068.201(i). You may operate engines/equipment in the United States only as needed to prepare and deliver them for export.

(c) Except as specified in paragraph (d) of this section, label exempted engines/equipment (including shipping containers if the label on the engine/equipment will be obscured by the container) with a label showing that they are not certified for sale or use in the United States. This label may be permanent or removable. See § 1068.45 for provisions related to the use of removable labels and applying labels to containers without labeling individual engines/equipment. The label must include your corporate name and trademark and the following statement: "THIS [engine, equipment, vehicle, etc.] IS SOLELY FOR EXPORT AND IS THEREFORE EXEMPT UNDER 40 CFR 1068.230 FROM U.S. EMISSION STANDARDS AND RELATED REQUIREMENTS."

\* \* \* \* \*

■ 343. Section 1068.235 is revised to read as follows:

**§ 1068.235 Exempting nonroad engines/equipment used solely for competition.**

The following provisions apply for nonroad engines/equipment, but not for motor vehicles or for stationary applications:

(a) New nonroad engines/equipment you produce that are used solely for competition are excluded from emission

standards. We may exempt (rather than exclude) new nonroad engines/equipment you produce that you intend to be used solely for competition, where we determine that such engines/equipment are unlikely to be used contrary to your intent. See the standard-setting parts for specific provisions where applicable. Note that the definitions in the standard-setting part may deem uncertified engines/equipment to be new upon importation.

(b) If you modify any nonroad engines/equipment after they have been placed into service in the United States so they will be used solely for competition, they are exempt without request. This exemption applies only to the prohibitions in § 1068.101(b)(1) and (2) and are valid only as long as the engine/equipment is used solely for competition. You may not use the provisions of this paragraph (b) to circumvent the requirements that apply to the sale of new competition engines under the standard-setting part.

(c) If you modify any nonroad engines/equipment under paragraph (b) of this section, you must destroy the original emission labels. If you loan, lease, sell, or give any of these engines/equipment to someone else, you must tell the new owner (or operator, if applicable) in writing that they may be used only for competition.

■ 344. Section 1068.240 is amended by revising the section heading and paragraphs (b)(3), (c)(1), (c)(3), (d)(2)(ii), and (e) introductory text to read as follows:

**§ 1068.240 Exempting new replacement engines.**

\* \* \* \* \*

(b) \* \* \*  
(3) An old engine block replaced by a new engine exempted under this paragraph (b) may be reintroduced into U.S. commerce as part of an engine that meets either the current standards for new engines, the provisions for new replacement engines in this section, or another valid exemption. Otherwise, you must destroy the old engine block (or confirm that it has been destroyed), or export the engine block without its emission label.

\* \* \* \* \*

(c) \* \* \*  
(1) You may produce a limited number of replacement engines under this paragraph (c) representing 0.5 percent of your annual production volumes for each category and subcategory of engines identified in Table 1 to this section (1.0 percent through 2013). Calculate this number by multiplying your annual U.S.-directed production volume by 0.005 (or 0.01

through 2013) and rounding to the nearest whole number. Determine the appropriate production volume by identifying the highest total annual U.S.-directed production volume of engines from the previous three model years for all your certified engines from each category or subcategory identified in Table 1 to this section, as applicable. In unusual circumstances, you may ask us to base your production limits on U.S.-directed production volume for a model year more than three years prior. You may include stationary engines and exempted engines as part of your U.S.-directed production volume. Include U.S.-directed engines produced by any affiliated companies and those from any other companies you license to produce engines for you.

\* \* \* \* \*

(3) Send the Designated Compliance Officer a report by September 30 of the year following any year in which you produced exempted replacement engines under this paragraph (c). In your report include the total number of replacement engines you produce under this paragraph (c) for each category or subcategory, as appropriate, and the corresponding total production volumes determined under paragraph (c)(1) of this section. If you send us a report under this paragraph (c)(3), you must also include the total number of replacement engines you produced under paragraphs (b), (d), and (e) of this section (including any replacement marine engines subject to reporting under 40 CFR 1042.615). Count exempt engines as tracked under paragraph (b) of this section only if you meet all the requirements and conditions that apply under paragraph (b) of this section by the due date for the annual report. You may include the information required under this paragraph (c)(3) in production reports required under the standard-setting part.

\* \* \* \* \*

(d) \* \* \*  
(2) \* \* \*

(ii) If you do not qualify for using a removable label in paragraph (d)(2)(i) of this section, you must add a permanent label in a readily visible location, though it may be obscured after installation in a piece of equipment. Include on the permanent label your corporate name and trademark, the engine's part number (or other identifying information), and the statement: "THIS REPLACEMENT ENGINE IS EXEMPT UNDER 40 CFR 1068.240. THIS ENGINE MAY NOT BE INSTALLED IN EQUIPMENT THAT IS MORE THAN 40 YEARS OLD AT THE TIME OF INSTALLATION." If there is

not enough space for this statement, you may alternatively add: "REPLACEMENT" or "SERVICE ENGINE." For purposes of this paragraph (d)(2), engine part numbers permanently stamped or engraved on the engine are considered to be included on the label.

(e) *Partially complete current-tier replacement engines.* The provisions of paragraph (d) of this section apply for engines you produce from a current line of certified engines or vehicles if you ship them as partially complete engines for replacement purposes. This applies for engine-based and equipment-based standards as follows:

\* \* \* \* \*

■ 345. Section 1068.245 is amended by revising the section heading and paragraph (g)(4) to read as follows:

**§ 1068.245 Temporary provisions addressing hardship due to unusual circumstances.**

\* \* \* \* \*

(g) \* \* \*

(4) A statement describing the engine's status as an exempted engine:

(i) If the engine/equipment does not meet any emission standards, add the following statement: "THIS [engine, equipment, vehicle, etc.] IS EXEMPT UNDER 40 CFR 1068.245 FROM EMISSION STANDARDS AND RELATED REQUIREMENTS."

(ii) If the engines/equipment meet alternate emission standards as a condition of an exemption under this section, we may specify a different statement to identify the alternate emission standards.

■ 346. Section 1068.250 is amended by revising the section heading and paragraphs (c) introductory text and (k)(4) and removing and reserving paragraph (h).

The revisions read as follows:

**§ 1068.250 Extending compliance deadlines for small businesses under hardship.**

\* \* \* \* \*

(c) Send the Designated Compliance Officer a written request for an extension as soon as possible before you are in violation. In your request, show that all the following conditions and requirements apply:

\* \* \* \* \*

(k) \* \* \*

(4) A statement describing the engine's status as an exempted engine:

(i) If the engine/equipment does not meet any emission standards, add the following statement: "THIS [engine, equipment, vehicle, etc.] IS EXEMPT UNDER 40 CFR 1068.250 FROM

**EMISSION STANDARDS AND RELATED REQUIREMENTS."**

(ii) If the engine/equipment meets alternate emission standards as a condition of an exemption under this section, we may specify a different statement to identify the alternate emission standards.

■ 347. Section 1068.255 is amended by revising the section heading and paragraph (a) introductory text to read as follows:

**§ 1068.255 Exempting engines and fuel-system components for hardship for equipment manufacturers and secondary engine manufacturers.**

\* \* \* \* \*

(a) *Equipment exemption.* As an equipment manufacturer, you may ask for approval to produce exempted equipment for up to 12 months. We will generally limit this to a single interval up to 12 months in the first year that new or revised emission standards apply. Exemptions under this section are not limited to small businesses.

Send the Designated Compliance Officer a written request for an exemption before you are in violation. In your request, you must show you are not at fault for the impending violation and that you would face serious economic hardship if we do not grant the exemption. This exemption is not available under this paragraph (a) if you manufacture the engine or fuel-system components you need for your own equipment, or if complying engines or fuel-system components are available from other manufacturers that could be used in your equipment, unless we allow it elsewhere in this chapter. We may impose other conditions, including provisions to use products meeting less stringent emission standards or to recover the lost environmental benefit. In determining whether to grant the exemptions, we will consider all relevant factors, including the following:

\* \* \* \* \*

■ 348. Section 1068.260 is revised to read as follows:

**§ 1068.260 General provisions for selling or shipping engines that are not yet in their certified configuration.**

Except as specified in paragraph (e) of this section, all new engines in the United States are presumed to be subject to the prohibitions of § 1068.101, which generally require that all new engines be in a certified configuration before being sold, offered for sale, or introduced or delivered into commerce in the United States or imported into the United States. All emission-related components generally need to be installed on an

engine for such an engine to be in its certified configuration. This section specifies clarifications and exemptions related to these requirements for engines. Except for paragraph (c) of this section, the provisions of this section generally apply for engine-based standards but not for equipment-based exhaust emission standards.

(a) The provisions of this paragraph (a) apply for emission-related components that cannot practically be assembled before shipment because they depend on equipment design parameters.

(1) You do not need an exemption to ship an engine that does not include installation or assembly of certain emission-related components if those components are shipped along with the engine. For example, you may generally ship aftertreatment devices along with engines rather than installing them on the engine before shipment. We may require you to describe how you plan to use this provision.

(2) You may ask us at the time of certification for an exemption to allow you to ship your engines without emission-related components. If we allow this, we may specify conditions that we determine are needed to ensure that shipping the engine without such components will not result in the engine being operated outside of its certified configuration. You must identify unshipped parts by specific part numbers if they cannot be properly characterized by performance specification. For example, electronic control units, turbochargers, and EGR coolers must generally be identified by part number. Parts that we believe can be properly characterized by performance specification include air filters, noncatalyzed mufflers, and charge air coolers. See paragraph (d) of this section for additional provisions that apply in certain circumstances.

(b) You do not need an exemption to ship engines without specific components if they are not emission-related components identified in Appendix I of this part. For example, you may generally ship engines without the following parts:

(1) Radiators needed to cool the engine.

(2) Exhaust piping between the engine and an aftertreatment device, between two aftertreatment devices, or downstream of the last aftertreatment device.

(c) If you are a certificate holder, partially complete engines/equipment shipped between two of your facilities are exempt, subject to the provisions of this paragraph (c), as long as you maintain ownership and control of the

engines/equipment until they reach their destination. We may also allow this where you do not maintain actual ownership and control of the engines/equipment (such as hiring a shipping company to transport the engines) but only if you demonstrate that the engines/equipment will be transported only according to your specifications. See § 1068.261(b) for the provisions that apply instead of this paragraph (c) for the special case of integrated manufacturers using the delegated-assembly exemption. Notify us of your intent to use this exemption in your application for certification, if applicable. Your exemption is effective when we grant your certificate. You may alternatively request an exemption in a separate submission; for example, this would be necessary if you will not be the certificate holder for the engines in question. We may require you to take specific steps to ensure that such engines/equipment are in a certified configuration before reaching the ultimate purchaser. Note that since this is a temporary exemption, it does not allow you to sell or otherwise distribute to ultimate purchasers an engine/equipment in an uncertified configuration with respect to exhaust emissions. Note also that the exempted engine/equipment remains new and subject to emission standards (see definition of “exempted” in § 1068.30) until its title is transferred to the ultimate purchaser or it otherwise ceases to be new.

(d) See § 1068.261 for delegated-assembly provisions in which certificate-holding manufacturers ship engines that are not yet equipped with certain emission-related components. See § 1068.262 for provisions related to manufacturers shipping partially complete engines for which a secondary engine manufacturer holds the certificate of conformity.

(e) Engines used in hobby vehicles are not presumed to be engines subject to the prohibitions of § 1068.101. Hobby vehicles are reduced-scale models of vehicles that are not capable of transporting a person. Some gas turbine engines are subject to the prohibitions of § 1068.101, but we do not presume that all gas turbine engines are subject to these prohibitions. Other engines that do not have a valid certificate of conformity or exemption when sold, offered for sale, or introduced or delivered into commerce in the United States or imported into the United States are presumed to be engines subject to the prohibitions of § 1068.101 unless we determine that such engines are excluded from the prohibitions of § 1068.101.

(f) While we presume that new non-hobby engines are subject to the prohibitions of § 1068.101, we may determine that a specific engine is not subject to these prohibitions based on information you provide or other information that is available to us. For example, the provisions of this part 1068 and the standard-setting parts provide for exemptions in certain circumstances. Also, some engines may be subject to separate prohibitions under subchapter C instead of the prohibitions of § 1068.101.

■ 349. Section 1068.261 is amended by revising the section heading and paragraph (a) to read as follows:

**§ 1068.261 Delegated assembly and other provisions related to engines not yet in the certified configuration.**

\* \* \* \* \*

(a) Shipping an engine separately from an aftertreatment component that you have specified as part of its certified configuration will not be a violation of the prohibitions in § 1068.101(a)(1) subject to the provisions in this section. We may also require that you apply some or all of the provisions of this section for other components if we determine it is necessary to ensure that shipping the engine without such components will not result in the engine being operated outside of its certified configuration. In making this determination, we will consider the importance of the component for controlling emissions and the likelihood that equipment manufacturers will have an incentive to disregard your emission-related installation instructions based on any relevant factors, such as the cost of the component and any real or perceived expectation of a negative impact on engine or equipment performance.

\* \* \* \* \*

■ 350. Section 1068.262 is revised to read as follows:

**§ 1068.262 Shipment of engines to secondary engine manufacturers.**

This section specifies how manufacturers may introduce into U.S. commerce partially complete engines that have an exemption or a certificate of conformity held by a secondary engine manufacturer and are not yet in a certified configuration. See the standard-setting part to determine whether and how the provisions of this section apply. (Note: See § 1068.261 for provisions related to manufacturers introducing into U.S. commerce partially complete engines for which they hold the certificate of conformity.) This exemption is temporary as

described in paragraph (g) of this section.

(a) The provisions of this section generally apply where the secondary engine manufacturer has substantial control over the design and assembly of emission controls. In unusual circumstances we may allow other secondary engine manufacturers to use these provisions. In determining whether a manufacturer has substantial control over the design and assembly of emission controls, we would consider the degree to which the secondary engine manufacturer would be able to ensure that the engine will conform to the regulations in its final configuration. Such secondary engine manufacturers may finish assembly of partially complete engines in the following cases:

(1) You obtain an engine that is not fully assembled with the intent to manufacture a complete engine.

(2) You obtain an engine with the intent to modify it before it reaches the ultimate purchaser.

(3) You obtain an engine with the intent to install it in equipment that will be subject to equipment-based standards.

(b) Manufacturers may introduce into U.S. commerce partially complete engines as described in this section if they have a written request for such engines from a secondary engine manufacturer that has certified the engine and will finish the engine assembly. The written request must include a statement that the secondary engine manufacturer has a certificate of conformity for the engine and identify a valid engine family name associated with each engine model ordered (or the basis for an exemption if applicable, as specified in paragraph (e) of this section). The original engine manufacturer must apply a removable label meeting the requirements of § 1068.45 that identifies the corporate name of the original manufacturer and states that the engine is exempt under the provisions of § 1068.262. The name of the certifying manufacturer must also be on the label or, alternatively, on the bill of lading that accompanies the engines during shipment. The original engine manufacturer may not apply a permanent emission control information label identifying the engine's eventual status as a certified engine.

(c) If you are the secondary engine manufacturer and you will hold the certificate, you must include the following information in your application for certification:

(1) Identify the original engine manufacturer of the partially complete engine or of the complete engine you will modify.

(2) Describe briefly how and where final assembly will be completed. Specify how you have the ability to ensure that the engines will conform to the regulations in their final configuration. (Note: Paragraph (a) of this section prohibits using the provisions of this section unless you have substantial control over the design and assembly of emission controls.)

(3) State unconditionally that you will not distribute the engines without conforming to all applicable regulations.

(d) If you are a secondary engine manufacturer and you are already a certificate holder for other families, you may receive shipment of partially complete engines after you apply for a certificate of conformity but before the certificate's effective date. In this case, all the provisions of § 1068.103(c)(1) through (3) apply. This exemption allows the original manufacturer to ship engines after you have applied for a certificate of conformity. Manufacturers may introduce into U.S. commerce partially complete engines as described in this paragraph (d) if they have a written request for such engines from a secondary engine manufacturer stating that the application for certification has been submitted (instead of the information we specify in paragraph (b) of this section). We may set additional conditions under this paragraph (d) to prevent circumvention of regulatory requirements. Consistent with § 1068.103(c), we may also revoke an exemption under this paragraph (d) if we have reason to believe that the application for certification will not be approved or that the engines will otherwise not reach a certified configuration before reaching the ultimate purchaser. This may require that you export the engines.

(e) The provisions of this section also apply for shipping partially complete engines if the engine is covered by a valid exemption and there is no valid engine family name that could be used to represent the engine model. Unless we approve otherwise in advance, you may do this only when shipping engines to secondary engine manufacturers that are certificate holders. In this case, the secondary engine manufacturer must identify the regulatory cite identifying the applicable exemption instead of a valid engine family name when ordering engines from the original engine manufacturer.

(f) If secondary engine manufacturers determine after receiving an engine under this section that the engine will not be covered by a certificate or exemption as planned, they may ask us to allow for shipment of the engines back to the original engine manufacturer

or to another secondary engine manufacturer. This might occur in the case of an incorrect shipment or excess inventory. We may modify the provisions of this section as appropriate to address these cases.

(g) Both original and secondary engine manufacturers must keep the records described in this section for at least five years, including the written request for engines and the bill of lading for each shipment (if applicable). The written request is deemed to be a submission to EPA and is thus subject to the reporting requirements of § 1068.101(a)(2).

(h) These provisions are intended only to allow secondary engine manufacturers to obtain or transport engines in the specific circumstances identified in this section so any exemption under this section expires when the engine reaches the point of final assembly identified in paragraph (c)(2) of this section.

(i) For purposes of this section, an allowance to introduce partially complete engines into U.S. commerce includes a conditional allowance to sell, introduce, or deliver such engines into commerce in the United States or import them into the United States. It does not include a general allowance to offer such partially complete engines for sale because this exemption is intended to apply only for cases in which the certificate holder already has an arrangement to purchase the engines from the original engine manufacturer. This exemption does not allow the original engine manufacturer to subsequently offer the engines for sale to a different manufacturer who will hold the certificate unless that second manufacturer has also complied with the requirements of this part. The exemption does not apply for any individual engines that are not labeled as specified in this section or which are shipped to someone who is not a certificate holder.

(j) We may suspend, revoke, or void an exemption under this section, as follows:

(1) We may suspend or revoke your exemption if you fail to meet the requirements of this section. We may suspend or revoke an exemption related to a specific secondary engine manufacturer if that manufacturer sells engines that are in not in a certified configuration in violation of the regulations. We may disallow this exemption for future shipments to the affected secondary engine manufacturer or set additional conditions to ensure that engines will be assembled in the certified configuration.

(2) We may void an exemption for all the affected engines if you intentionally submit false or incomplete information or fail to keep and provide to EPA the records required by this section.

(3) The exemption is void for an engine that is shipped to a company that is not a certificate holder or for an engine that is shipped to a secondary engine manufacturer that is not in compliance with the requirements of this section.

(4) The secondary engine manufacturer may be liable for causing a prohibited act if voiding the exemption is due to its own actions.

(k) No exemption is needed to import equipment that does not include an engine. No exemption from exhaust emission standards is available under this section for equipment subject to equipment-based standards if the engine has been installed.

■ 351. Section 1068.265 is amended by revising the section heading to read as follows:

**§ 1068.265 Provisions for engines/equipment conditionally exempted from certification.**

\* \* \* \* \*

**Subpart D—Imports**

■ 352. Section 1068.301 is amended by revising the section heading and paragraphs (b) and (d) and adding paragraph (e) to read as follows:

**§ 1068.301 General provisions for importing engines/equipment.**

\* \* \* \* \*

(b) In general, engines/equipment that you import must be covered by a certificate of conformity unless they were built before emission standards started to apply. This subpart describes the limited cases where we allow importation of exempt or excluded engines/equipment. If an engine has an exemption from exhaust emission standards, this allows you to import the equipment under the same exemption.

\* \* \* \* \*

(d) Complete the appropriate EPA declaration before importing any engines or equipment. These forms may be submitted and stored electronically and are available on the Internet at <http://www.epa.gov/OTAQ/imports/> or by phone at 734-214-4100. Importers must keep these records for five years and make them available promptly upon request.

(e) The standard-setting part may define uncertified engines/equipment to be “new” upon importation, whether or not they have already been placed into service. This may affect how the

provisions of this subpart apply for your engines/equipment. (See the definition of “new” and other relevant terms in the standard-setting part.)

■ 353. Section 1068.305 is amended by revising paragraphs (b)(1) and (2) to read as follows:

**§ 1068.305 How do I get an exemption or exclusion for imported engines/equipment?**

\* \* \* \* \*

(b) \* \* \*

(1) Give your name, address, and telephone number.

(2) Give the engine/equipment owner’s name, address, and telephone number.

\* \* \* \* \*

■ 354. Section 1068.310 is amended by revising the section heading and paragraph (a) to read as follows:

**§ 1068.310 Exclusions for imported engines/equipment.**

\* \* \* \* \*

(a) *Nonroad engines/equipment used solely for competition.* Nonroad engines/equipment that you demonstrate will be used solely for competition are excluded from the restrictions on imports in § 1068.301(b), but only if they are properly labeled. See the standard-setting part for provisions related to this demonstration that may apply. Section 1068.101(b)(4) prohibits anyone from using these excluded engines/equipment for purposes other than competition. We may waive the labeling requirement or allow a removable label for engines/equipment that are being temporarily imported for one or more specific competition events.

\* \* \* \* \*

■ 355. Section 1068.315 is amended by revising the section heading and paragraph (i) to read as follows:

**§ 1068.315 Permanent exemptions for imported engines/equipment.**

\* \* \* \* \*

(i) *Ancient engine/equipment exemption.* If you are not the original engine/equipment manufacturer, you may import nonconforming engines/equipment that are subject to a standard-setting part and were first manufactured at least 21 years earlier, as long as they are still substantially in their original configurations.

■ 356. Section 1068.325 is amended by revising the section heading, introductory text, and paragraphs (a), (c), (d), and (j)(5) to read as follows:

**§ 1068.325 Temporary exemptions for imported engines/equipment.**

You may import engines/equipment under certain temporary exemptions,

subject to the conditions in this section. We may ask U.S. Customs and Border Protection to require a specific bond amount to make sure you comply with the requirements of this subpart. You may not sell or lease one of these engines/equipment while it is in the United States except as specified in this section or § 1068.201(i). You must eventually export the engine/equipment as we describe in this section unless it conforms to a certificate of conformity or it qualifies for one of the permanent exemptions in § 1068.315 or the standard-setting part.

(a) *Exemption for repairs or alterations.* You may temporarily import nonconforming engines/equipment under bond solely for repair or alteration, subject to our advance approval as described in paragraph (j) of this section. You may operate the engine/equipment in the United States only as necessary to repair it, alter it, or ship it to or from the service location. Export the engine/equipment directly after servicing is complete, or confirm that it has been destroyed.

\* \* \* \* \*

(c) *Display exemption.* You may temporarily import nonconforming engines/equipment under bond for display if you follow the requirements of § 1068.220, subject to our advance approval as described in paragraph (j) of this section. This exemption expires one year after you import the engine/equipment, unless we approve your request for an extension. The engine/equipment must be exported (or destroyed) by the time the exemption expires or directly after the display concludes, whichever comes first.

(d) *Export exemption.* You may temporarily import nonconforming engines/equipment to export them, as described in § 1068.230. Label the engine/equipment as described in § 1068.230. You may sell or lease the engines/equipment for operation outside the United States consistent with the provisions of § 1068.230.

\* \* \* \* \*

(j) \* \* \*

(5) Acknowledge that EPA enforcement officers may conduct inspections or testing as allowed under the Clean Air Act.

\* \* \* \* \*

■ 357. Section 1068.335 is amended by revising the section heading to read as follows:

**§ 1068.335 Penalties for violations.**

\* \* \* \* \*

■ 358. Section 1068.360 is amended by revising the section heading and paragraph (b) to read as follows:

**§ 1068.360 Restrictions for assigning a model year to imported engines and equipment.**

\* \* \* \* \*

(b) This paragraph (b) applies for the importation of engines and equipment that have not been placed into service, where the importation occurs in any calendar year that is more than one year after the named model year of the engine or equipment when emission control requirements applying to current engines are different than for engines or equipment in the named model year, unless they are imported under special provisions for Independent Commercial Importers as allowed under the standard-setting part. Regardless of what other provisions of this subchapter U specify for the model year of the engine or equipment, such engines and equipment are deemed to have an applicable model year no more than one year earlier than the calendar year in which they are imported. For example, a new engine identified as a 2007 model-year product that is imported on January 31, 2010 will be treated as a 2009 model-year engine; the same engine will be treated as a 2010 model-year engine if it is imported any time in calendar year 2011.

\* \* \* \* \*

**Subpart E—Selective Enforcement Auditing**

■ 359. Section 1068.401 is revised to read as follows:

**§ 1068.401 What is a selective enforcement audit?**

(a) We may conduct or require you as a certificate holder to conduct emission tests on production engines/equipment in a selective enforcement audit. This requirement is independent of any requirement for you to routinely test production-line engines/equipment. Where there are multiple entities meeting the definition of manufacturer, we may require manufacturers other than the certificate holder to conduct or participate in the audit as necessary. For products subject to equipment-based standards, but tested using engine-based test procedures, this subpart applies to the engines and/or the equipment, as applicable. Otherwise this subpart applies to engines for products subject to engine-based standards and to equipment for products subject to equipment-based standards.

(b) If we send you a signed test order, you must follow its directions and the provisions of this subpart. We may tell you where to test the engines/equipment. This may be where you produce the engines/equipment or any

other emission testing facility. You are responsible for all testing costs whether the testing is conducted at your facility or another facility.

(c) If we select one or more of your families for a selective enforcement audit, we will send the test order to the person who signed the application for certification or we will deliver it in person.

(d) If we do not select a testing facility, notify the Designated Compliance Officer within one working day of receiving the test order where you will test your engines/equipment.

(e) You must do everything we require in the audit without delay. We may suspend or revoke your certificate of conformity for the affected engine families if you do not fulfill your obligations under this subpart.

■ 360. Section 1068.405 is amended by revising paragraph (a)(1) to read as follows:

**§ 1068.405 What is in a test order?**

(a) \* \* \*

(1) The family we have identified for testing. We may also specify individual configurations.

\* \* \* \* \*

■ 361. Section 1068.415 is amended by revising paragraphs (c) and (d) to read as follows:

**§ 1068.415 How do I test my engines/equipment?**

\* \* \* \* \*

(c) Test at least two engines/equipment in each 24-hour period (including void tests). However, for engines with maximum engine power above 560 kW, you may test one engine per 24-hour period. If you request and justify it, we may approve a lower testing rate.

(d) For exhaust emissions, accumulate service on test engines/equipment at a minimum rate of 6 hours per engine or piece of equipment during each 24-hour period; however, service accumulation to stabilize an engine's emission levels may not take longer than eight days. The first 24-hour period for service accumulation begins when you finish preparing an engine or piece of equipment for testing. The minimum service accumulation rate does not apply on weekends or holidays. We may approve a longer stabilization period or a lower service accumulation rate if you request and justify it. We may require you to accumulate hours more rapidly than the minimum rate, as appropriate. Plan your service accumulation to allow testing at the rate specified in paragraph (c) of this section. Select operation for accumulating operating hours on your

test engines/equipment to represent normal in-use operation for the family.

\* \* \* \* \*

■ 362. Section 1068.420 is amended by revising paragraphs (b) and (e) to read as follows:

**§ 1068.420 How do I know when my engine family fails an SEA?**

\* \* \* \* \*

(b) Continue testing engines/equipment until you reach a pass decision for all pollutants or a fail decision for one pollutant, as described in paragraph (c) of this section.

\* \* \* \* \*

(e) If you reach a pass decision for one pollutant, but need to continue testing for another pollutant, we will not use these later test results for the pollutant with the pass decision as part of the SEA.

\* \* \* \* \*

■ 363. Section 1068.425 is amended by revising paragraph (b) to read as follows:

**§ 1068.425 What happens if one of my production-line engines/equipment exceeds the emission standards?**

\* \* \* \* \*

(b) You may ask for a hearing relative to the suspended certificate of conformity for the failing engine/equipment as specified in subpart G of this part.

■ 364. Section 1068.430 is amended by revising paragraph (c) to read as follows:

**§ 1068.430 What happens if a family fails an SEA?**

\* \* \* \* \*

(c) You may ask for a hearing as described in subpart G of this part up to 15 days after we suspend the certificate for a family. If we agree that we used erroneous information in deciding to suspend the certificate before a hearing is held, we will reinstate the certificate.

■ 365. Section 1068.450 is amended by revising paragraph (b) to read as follows:

**§ 1068.450 What records must I send to EPA?**

\* \* \* \* \*

(b) We may ask you to add information to your written report, so we can determine whether your new engines/equipment conform to the requirements of this subpart.

\* \* \* \* \*

**Subpart F—Reporting Defects and Recalling Engines/Equipment**

■ 366. Section 1068.501 is amended by revising paragraphs (a)(1)(iv), (a)(8), and (b)(1)(iii) to read as follows:



**§ 1068.501 How do I report emission-related defects?**

\* \* \* \* \*

(a) \* \* \*

(1) \* \* \*

(iv) Any other component whose failure would commonly increase emissions of any regulated pollutant without significantly degrading engine/equipment performance.

\* \* \* \* \*

(8) Send all reports required by this section to the Designated Compliance Officer.

\* \* \* \* \*

(b) \* \* \*

(1) \* \* \*

(iii) You receive any other information for which good engineering judgment would indicate the component or system may be defective, such as information from dealers, field-service personnel, equipment manufacturers, hotline complaints, in-use testing, or engine diagnostic systems.

\* \* \* \* \*

■ 367. Section 1068.505 is amended by revising paragraphs (a), (c), and (g) to read as follows:

**§ 1068.505 How does the recall program work?**

(a) If we make a determination that a substantial number of properly maintained and used engines/equipment within a given class or category do not conform to the regulations of this chapter during their useful life, you must submit a plan to remedy the nonconformity of your engines/equipment. We will notify you of our determination in writing. Our notice will identify the class or category of engines/equipment affected and describe how we reached our conclusion. If this happens, you must meet the requirements and follow the instructions in this subpart. You must remedy at your expense all engines/equipment that experienced the nonconformity during the useful life in spite of being properly maintained and used, as described in § 1068.510(a)(7), regardless of their age or extent of service accumulation at the time of repair. You may not transfer this expense to a dealer (or equipment manufacturer for engine-based standards) through a franchise or other agreement.

\* \* \* \* \*

(c) Unless we withdraw the determination of noncompliance, you must respond to it by sending a remedial plan to the Designated Compliance Officer. We will designate a date by which you must send us the

remedial plan; the designated date will be no sooner than 45 days after we notify you, and no sooner than 30 days after a hearing.

\* \* \* \* \*

(g) For purposes of recall, “owner” means someone who owns an engine or piece of equipment affected by a remedial plan.

■ 368. Section 1068.510 is amended by revising paragraphs (a)(6), (b), and (h) to read as follows:

**§ 1068.510 How do I prepare and apply my remedial plan?**

(a) \* \* \*

(6) How you will notify owners; include a copy of any notification letters.

\* \* \* \* \*

(b) We may require you to add information if it is needed to evaluate your remedial plan.

\* \* \* \* \*

(h) Begin notifying owners within 15 days after we approve your remedial plan. If we hold a hearing, but do not change our position about the noncompliance, you must begin notifying owners within 60 days after we complete the hearing unless we specify a later deadline.

■ 369. Section 1068.515 is amended by revising paragraphs (a) and (c) to read as follows:

**§ 1068.515 How do I mark or label repaired engines/equipment?**

(a) Attach a label to engines/equipment you repair under the remedial plan. At your discretion, you may label or mark engines/equipment you inspect but do not repair. Designate the specific recall campaign on the label.

\* \* \* \* \*

(c) Identify the facility where you repaired or inspected the engine/equipment on the label, or keep records of this information for each vehicle and give it to us if we ask for it.

\* \* \* \* \*

■ 370. Section 1068.520 is amended by revising paragraph (b) to read as follows:

**§ 1068.520 How do I notify affected owners?**

\* \* \* \* \*

(b) We may require you to add information to your notice or to send more notices if we determine this is reasonable and necessary to ensure an effective recall.

\* \* \* \* \*

■ 371. Section 1068.530 is amended by revising the introductory text to read as follows:

**§ 1068.530 What records must I keep?**

We may review your records at any time so it is important that you keep required information readily available. Keep records associated with your recall campaign for five years after you send the last report we require under § 1068.525(b). Organize and maintain your records as described in this section.

\* \* \* \* \*

■ 372. Subpart G is revised to read as follows:

**Subpart G—Hearings**

Sec.

1068.601 Overview.

1068.610 Request for hearing—suspending, revoking, or voiding a certificate of conformity.

1068.615 Request for hearing—denied application for certification, automatically suspended certificate, and determinations related to certification.

1068.620 Request for hearing—recall.

1068.625 Request for hearing—nonconformance penalties.

1068.650 Procedures for informal hearings.

**Subpart G—Hearings****§ 1068.601 Overview.**

The regulations of this chapter involve numerous provisions that may result in EPA making a decision or judgment that you may consider adverse to your interests and that either limits your business activities or requires you to pay penalties. As specified in the regulations in this chapter, this might involve an opportunity for an informal hearing or a formal hearing that follows specific procedures and is directed by a Presiding Officer. The regulations in this chapter generally specify when we would hold a hearing. In limited circumstances, we may grant a request for a hearing related to adverse decisions regarding regulatory provisions for which we do not specifically describe the possibility of asking for a hearing.

(a) If you request a hearing regarding our decision to assess administrative penalties under § 1068.125, we will hold a formal hearing according to the provisions of 40 CFR 22.1 through 22.32 and 22.34.

(b) For other issues where the regulation allows for a hearing in response to an adverse decision, you may request an informal hearing as described in § 1068.650. Sections 1068.610 through 1068.625 describe when and how to request an informal hearing under various circumstances.

(c) The time limits we specify are calendar days and include weekends and holidays, except that a deadline falling on a Saturday, Sunday, or a



federal holiday is understood to move to the next business day. Your filing will be considered timely based on the following criteria relative to the specified deadline:

(1) The postmarked date for items sent by U.S. mail must be on or before the specified date.

(2) The ship date for items sent from any location within the United States by commercial carriers must be on or before the specified date.

(3) Items sent by mail or courier from outside the United States must be received by the specified date.

(4) The time and date stamp on an email message must be at or before 5:00 p.m. on the specified date (in either the source or destination time zone).

(5) The time and date stamp on faxed pages must be at or before 5:00 p.m. on the specified date (in either the source or destination time zone).

(6) Hand-delivered items must be received by the appropriate personnel by 3:00 p.m. on the specified date.

(d) See the standard-setting part for additional information. If the standard-setting part specifies any provisions that are contrary to those described in this subpart, the provisions of the standard-setting part apply instead of those described in this subpart.

**§ 1068.610 Request for hearing—suspending, revoking, or voiding a certificate of conformity.**

(a) You may request an informal hearing as described in § 1068.650 if you disagree with our decision to suspend, revoke, or void a certificate of conformity.

(b) If you request a hearing regarding the outcome of a testing regimen with established evaluation criteria, such as selective enforcement audits or routine production-line testing, we will hold a hearing limited to the following issues that are relevant to your circumstances:

(1) Whether tests were conducted in accordance with applicable regulations.

(2) Whether test equipment was properly calibrated and functioning.

(3) Whether specified sampling procedures were followed to select engines/equipment for testing.

(4) Whether there is a basis for determining that the problems identified do not apply for engines/equipment produced at plants other than the one from which engines/equipment were selected for testing.

(c) You must send your hearing request in writing to the Designated Compliance Officer no later than 30 days after we notify you of our decision to suspend, revoke, or void your certificate, or by some later deadline we specify. If the deadline passes, we may

nevertheless grant you a hearing at our discretion.

(d) Your hearing request must include the following information:

(1) Identify the classes or categories of engines/equipment that will be the subject of the hearing.

(2) State briefly which issues you will raise at the hearing for each affected class or category of engines/equipment.

(3) Specify why you believe the hearing will conclude in your favor for each of the issues you will raise.

(4) Summarize the evidence supporting your position on each of the issues you will raise and include any supporting data.

(e) We will approve your request for an informal hearing if we find that your request raises a substantial factual issue in the decision we made that, if addressed differently, could alter the outcome of that decision.

**§ 1068.615 Request for hearing—denied application for certification, automatically suspended certificate, and determinations related to certification.**

(a) You may request an informal hearing as described in § 1068.650 if we deny your application for a certificate of conformity, if your certificate of conformity is automatically suspended under the regulations, or if you disagree with determinations we make as part of the certification process. For example, you might disagree with our determinations regarding adjustable parameters under § 1068.50 or regarding your good engineering judgment under § 1068.5.

(b) You must send your hearing request in writing to the Designated Compliance Officer no later than 30 days after we notify you of our decision, or by some later deadline we specify. If the specified deadline passes, we may nevertheless grant you a hearing at our discretion.

(c) Your hearing request must include the information specified in § 1068.610(d).

(d) We will approve your request for an informal hearing if we find that your request raises a substantial factual issue in the decision we made that, if addressed differently, could alter the outcome of that decision.

**§ 1068.620 Request for hearing—recall.**

(a) You may request an informal hearing as described in § 1068.650 if you disagree with our decision to order a recall.

(b) You must send your hearing request in writing to the Designated Compliance Officer no later than 45 days after we notify you of our decision, or by some later deadline we specify. If

the specified deadline passes, we may nevertheless grant you a hearing at our discretion.

(c) Your hearing request must include the information specified in § 1068.610(d).

(d) We will approve your request for an informal hearing if we find that your request raises a substantial factual issue in the decision we made that, if addressed differently, could alter the outcome of that decision.

**§ 1068.625 Request for hearing—nonconformance penalties.**

(a) You may request an informal hearing as described in § 1068.650 if you disagree with our determination of compliance level or penalty calculation or both. The hearing will address only whether the compliance level or penalty was determined in accordance with the regulations.

(b) Send a request for a hearing in writing to the Designated Compliance Officer within the following time frame, as applicable:

(1) No later than 15 days after we notify you that we have approved a nonconformance penalty under this subpart if the compliance level is in the allowable range of nonconformity.

(2) No later than 15 days after completion of the Production Compliance Audit if the compliance level exceeds the upper limit.

(3) No later than 15 days after we notify you of an adverse decision for all other cases.

(c) If you miss the specified deadline in paragraph (b) of this section, we may nevertheless grant you a hearing at our discretion.

(d) Your hearing request must include the information specified in § 1068.610(d).

(e) We will approve your request for an informal hearing if we find that your request raises a substantial factual issue in the decision we made that, if addressed differently, could alter the outcome of that decision.

**§ 1068.650 Procedures for informal hearings.**

(a) The following provisions apply for arranging the hearing:

(1) After granting your request for an informal hearing, we will designate a Presiding Officer for the hearing.

(2) The Presiding Officer will select the time and place for the hearing. The hearing must be held as soon as practicable for all parties involved.

(3) The Presiding Officer may require that all argument and presentation of evidence be concluded by a certain date after commencement of the hearing.

(b) The Presiding Officer will establish a paper or electronic hearing

record, which may be made available for inspection. The hearing record includes, but is not limited to, the following materials:

- (1) All documents relating to the application for certification, including the certificate of conformity itself, if applicable.
  - (2) Your request for a hearing and the accompanying supporting data.
  - (3) Correspondence and other data relevant to the hearing.
  - (4) The Presiding Officer's written decision regarding the subject of the hearing, together with any accompanying material.
- (c) You may appear in person or you may be represented by counsel or by any other representative you designate.
- (d) The Presiding Officer may arrange for a prehearing conference, either in response to a request from any party or at his or her own discretion. The Presiding Officer will select the time and place for the prehearing conference. The Presiding Officer will summarize the results of the conference and include the written summary as part of the record. The prehearing conference may involve consideration of the following items:
- (1) Simplification of the issues.
  - (2) Stipulations, admissions of fact, and the introduction of documents.
  - (3) Limitation of the number of expert witnesses.
  - (4) Possibility of reaching an agreement to resolve any or all of the issues in dispute.
  - (5) Any other matters that may aid in expeditiously and successfully concluding the hearing.
- (e) Hearings will be conducted as follows:
- (1) The Presiding Officer will conduct informal hearings in an orderly and expeditious manner. The parties may offer oral or written evidence; however, the Presiding Officer may exclude evidence that is irrelevant, immaterial, or repetitious.
  - (2) Witnesses will not be required to testify under oath; however, the Presiding Officer must make clear that 18 U.S.C. 1001 specifies civil and criminal penalties for knowingly making false statements or representations or using false documents in any matter within the jurisdiction of EPA or any other department or agency of the United States.
  - (3) Any witness may be examined or cross-examined by the Presiding Officer, by you, or by any other parties.
  - (4) Written transcripts must be made for all hearings. Anyone may purchase copies of transcripts from the reporter.
  - (f) The Presiding Officer will make a final decision with written findings,

conclusions and supporting rationale on all the substantial factual issues presented in the record. The findings, conclusions, and written decision must be provided to the parties and made a part of the record.

■ 373. Appendix I to part 1068 is amended by revising paragraph IV to read as follows:

**Appendix I to Part 1068—Emission-Related Components**

\* \* \* \* \*

IV. Emission-related components also include any other part whose primary purpose is to reduce emissions or whose failure would commonly increase emissions without significantly degrading engine/equipment performance.

**Department of Transportation**

*National Highway Traffic Safety Administration*

**49 CFR Chapter V**

In consideration of the foregoing, under the authority of 49 U.S.C. 322, 5 U.S.C. 552, 49 U.S.C. 30166, 49 U.S.C. 30167, 49 U.S.C. 32307, 49 U.S.C. 32505, 49 U.S.C. 32708, 49 U.S.C. 32910, 49 U.S.C. 33116, 49 U.S.C. 32901, 49 U.S.C. 32902, 49 U.S.C. 30101, 49 U.S.C. 32905, 49 U.S.C. 32906, and delegation of authority at 49 CFR 1.95, NHTSA amends 49 CFR chapter V as follows:

**PART 523—VEHICLE CLASSIFICATION**

■ 374. Revise the authority citation for part 523 to read as follows:

**Authority:** 49 U.S.C. 32901; delegation of authority at 49 CFR 1.95.

■ 375. Revise § 523.2 to read as follows:

**§ 523.2 Definitions.**

As used in this part:

*Ambulance* has the meaning given in 40 CFR 86.1803.

*Approach angle* means the smallest angle, in a plane side view of an automobile, formed by the level surface on which the automobile is standing and a line tangent to the front tire static loaded radius arc and touching the underside of the automobile forward of the front tire.

*Axle clearance* means the vertical distance from the level surface on which an automobile is standing to the lowest point on the axle differential of the automobile.

*Base tire (for passenger automobiles, light trucks, and medium duty passenger vehicles)* means the tire size specified as standard equipment by the manufacturer on each unique combination of a vehicle's footprint and model type. Standard equipment is defined in 40 CFR 86.1803.

*Basic vehicle frontal area* is used as defined in 40 CFR 86.1803 for passenger automobiles, light trucks, medium duty passenger vehicles and Class 2b through 3 pickup trucks and vans. For heavy-duty tracts and vocational vehicles, it has the meaning given in 40 CFR 1037.801.

*Breakover angle* means the supplement of the largest angle, in the plan side view of an automobile that can be formed by two lines tangent to the front and rear static loaded radii arcs and intersecting at a point on the underside of the automobile.

*Bus* has the meaning given in 49 CFR 571.3.

*Cab-complete vehicle* means a vehicle that is first sold as an incomplete vehicle that substantially includes the vehicle cab section as defined in 40 CFR 1037.801. For example, vehicles known commercially as chassis-cabs, cab-chassis, box-deletes, bed-deletes, and cut-away vans are considered cab-complete vehicles. A cab includes a steering column and a passenger compartment. Note that a vehicle lacking some components of the cab is a cab-complete vehicle if it substantially includes the cab.

*Cargo-carrying volume* means the luggage capacity or cargo volume index, as appropriate, and as those terms are defined in 40 CFR 600.315–08, in the case of automobiles to which either of these terms apply. With respect to automobiles to which neither of these terms apply, "cargo-carrying volume" means the total volume in cubic feet, rounded to the nearest 0.1 cubic feet, of either an automobile's enclosed nonseating space that is intended primarily for carrying cargo and is not accessible from the passenger compartment, or the space intended primarily for carrying cargo bounded in the front by a vertical plane that is perpendicular to the longitudinal centerline of the automobile and passes through the rearmost point on the rearmost seat and elsewhere by the automobile's interior surfaces.

*Class 2b vehicles* are vehicles with a gross vehicle weight rating (GVWR) ranging from 8,501 to 10,000 pounds.

*Class 3 through Class 8 vehicles* are vehicles with a gross vehicle weight rating (GVWR) of 10,001 pounds or more as defined in 49 CFR 565.15.

*Coach bus* has the meaning given in 40 CFR 1037.801.

*Commercial medium- and heavy-duty on-highway vehicle* means an on-highway vehicle with a gross vehicle weight rating of 10,000 pounds or more as defined in 49 U.S.C. 32901(a)(7).

*Complete vehicle* has the meaning given to *completed vehicle* as defined in 49 CFR 567.3.

*Concrete mixer* has the meaning given in 40 CFR 1037.801.

*Curb weight* has the meaning given in 49 CFR 571.3.

*Dedicated vehicle* has the same meaning as *dedicated automobile* as defined in 49 U.S.C. 32901(a)(8).

*Departure angle* means the smallest angle, in a plane side view of an automobile, formed by the level surface on which the automobile is standing and a line tangent to the rear tire static loaded radius arc and touching the underside of the automobile rearward of the rear tire.

*Dual-fueled vehicle (multi-fuel, or flexible-fuel vehicle)* has the same meaning as *dual fueled automobile* as defined in 49 U.S.C. 32901(a)(9).

*Electric vehicle* means a vehicle that does not include an engine, and is powered solely by an external source of electricity and/or solar power. Note that this does not include electric hybrid or fuel-cell vehicles that use a chemical fuel such as gasoline, diesel fuel, or hydrogen. Electric vehicles may also be referred to as all-electric vehicles to distinguish them from hybrid vehicles.

*Emergency vehicle* means one of the following:

(1) For passenger cars, light trucks and medium duty passenger vehicles, emergency vehicle has the meaning given in 49 U.S.C. 32902(e).

(2) For heavy-duty vehicles, emergency vehicle has the meaning given in 40 CFR 1037.801.

*Engine code* has the meaning given in 40 CFR 86.1803.

*Final stage manufacturer* has the meaning given in 49 CFR 567.3.

*Fire truck* has the meaning given in 40 CFR 86.1803.

*Footprint* is defined as the product of track width (measured in inches, calculated as the average of front and rear track widths, and rounded to the nearest tenth of an inch) times wheelbase (measured in inches and rounded to the nearest tenth of an inch), divided by 144 and then rounded to the nearest tenth of a square foot. For purposes of this definition, track width is the lateral distance between the centerlines of the base tires at ground, including the camber angle. For purposes of this definition, wheelbase is the longitudinal distance between front and rear wheel centerlines.

*Full-size pickup truck* means a light truck or medium duty passenger vehicle that meets the requirements specified in 40 CFR 86.1866–12(e).

*Gross axle weight rating (GAWR)* has the meaning given in 49 CFR 571.3.

*Gross combination weight rating (GCWR)* has the meaning given in 49 CFR 571.3.

*Gross vehicle weight rating (GVWR)* has the meaning given in 49 CFR 571.3.

*Heavy-duty engine* means any engine used for (or for which the engine manufacturer could reasonably expect to be used for) motive power in a heavy-duty vehicle. For purposes of this definition in this part, the term “engine” includes internal combustion engines and other devices that convert chemical fuel into motive power. For example, a fuel cell and motor used in a heavy-duty vehicle is a heavy-duty engine. Heavy-duty-engines include those engines subject to the standards in 49 CFR part 535.

*Heavy-duty vehicle* means a vehicle as defined in § 523.6.

*Hitch* means a device attached to the chassis of a vehicle for towing.

*Incomplete vehicle* has the meaning given in 49 CFR 567.3.

*Light truck* means a non-passenger automobile meeting the criteria in § 523.5.

*Manufacturer* has the meaning given in 49 U.S.C. 32901(a)(14).

*Medium duty passenger vehicle* means a vehicle which would satisfy the criteria in § 523.5 (relating to light trucks) but for its gross vehicle weight rating or its curb weight, which is rated at more than 8,500 lbs GVWR or has a vehicle curb weight of more than 6,000 pounds or has a basic vehicle frontal area in excess of 45 square feet, and which is designed primarily to transport passengers, but does not include a vehicle that—

(1) Is an “incomplete vehicle” as defined in this subpart; or

(2) Has a seating capacity of more than 12 persons; or

(3) Is designed for more than 9 persons in seating rearward of the driver’s seat; or

(4) Is equipped with an open cargo area (for example, a pick-up truck box or bed) of 72.0 inches in interior length or more. A covered box not readily accessible from the passenger compartment will be considered an open cargo area for purposes of this definition.

*Mild hybrid gasoline-electric vehicle* means a vehicle as defined by EPA in 40 CFR 86.1866–12(e).

*Motor home* has the meaning given in 49 CFR 571.3.

*Motor vehicle* has the meaning given in 49 U.S.C. 30102.

*Passenger-carrying volume* means the sum of the front seat volume and, if any, rear seat volume, as defined in 40 CFR 600.315–08, in the case of automobiles to which that term applies. With respect

to automobiles to which that term does not apply, “passenger-carrying volume” means the sum in cubic feet, rounded to the nearest 0.1 cubic feet, of the volume of a vehicle’s front seat and seats to the rear of the front seat, as applicable, calculated as follows with the head room, shoulder room, and leg room dimensions determined in accordance with the procedures outlined in Society of Automotive Engineers Recommended Practice J1100, Motor Vehicle Dimensions (Report of Human Factors Engineering Committee, Society of Automotive Engineers, approved November 2009).

(1) For front seat volume, divide 1,728 into the product of the following SAE dimensions, measured in inches to the nearest 0.1 inches, and round the quotient to the nearest 0.001 cubic feet.

(i) H61-Effective head room—front.

(ii) W3-Shoulder room—front.

(iii) L34-Maximum effective leg room—accelerator.

(2) For the volume of seats to the rear of the front seat, divide 1,728 into the product of the following SAE dimensions, measured in inches to the nearest 0.1 inches, and rounded the quotient to the nearest 0.001 cubic feet.

(i) H63-Effective head room—second.

(ii) W4-Shoulder room—second.

(iii) L51-Minimum effective leg room—second.

*Pickup truck* means a non-passenger automobile which has a passenger compartment and an open cargo area (bed).

*Pintle hooks* means a type of towing hitch that uses a tow ring configuration to secure to a hook or a ball combination for the purpose of towing.

*Recreational vehicle or RV* means a motor vehicle equipped with living space and amenities found in a motor home.

*Refuse hauler* has the meaning given in 40 CFR 1037.801.

*Running clearance* means the distance from the surface on which an automobile is standing to the lowest point on the automobile, excluding unsprung weight.

*School bus* has the meaning given in 49 CFR 571.3.

*Static loaded radius arc* means a portion of a circle whose center is the center of a standard tire-rim combination of an automobile and whose radius is the distance from that center to the level surface on which the automobile is standing, measured with the automobile at curb weight, the wheel parallel to the vehicle’s longitudinal centerline, and the tire inflated to the manufacturer’s recommended pressure.

*Strong hybrid gasoline-electric vehicle* means a vehicle as defined by EPA in 40 CFR 86.1866–12(e).

*Temporary living quarters* means a space in the interior of an automobile in which people may temporarily live and which includes sleeping surfaces, such as beds, and household conveniences, such as a sink, stove, refrigerator, or toilet.

*Transmission class* has the meaning given in 40 CFR 600.002.

*Transmission configuration* has the meaning given in 40 CFR 600.002.

*Transmission type* has the meaning given in 40 CFR 86.1803.

*Truck tractor* has the meaning given in 49 CFR 571.3 and 49 CFR 535.5(c). This includes most heavy-duty vehicles specifically designed for the primary purpose of pulling trailers, but does not include vehicles designed to carry other loads. For purposes of this definition “other loads” would not include loads carried in the cab, sleeper compartment, or toolboxes. Examples of vehicles that are similar to tractors but that are not tractors under this part include dromedary tractors, automobile haulers, straight trucks with trailers hitches, and tow trucks.

*Van* means a vehicle with a body that fully encloses the driver and a cargo carrying or work performing compartment. The distance from the leading edge of the windshield to the foremost body section of vans is typically shorter than that of pickup trucks and sport utility vehicles.

*Vocational tractor* means a tractor that is classified as a vocational vehicle according to 40 CFR 1037.630

*Vocational vehicle (or heavy-duty vocational vehicle)* has the meaning given in § 523.8 and 49 CFR 535.5(b). This includes any vehicle that is equipped for a particular industry, trade or occupation such as construction, heavy hauling, mining, logging, oil fields, refuse and includes vehicles such as school buses, motorcoaches and RVs.

*Work truck* means a vehicle that is rated at more than 8,500 pounds and less than or equal to 10,000 pounds gross vehicle weight, and is not a medium-duty passenger vehicle as defined in 49 U.S.C. 32901(a)(19).

■ 376. Revise § 523.6 to read as follows:

**§ 523.6 Heavy-duty vehicle.**

(a) A heavy-duty vehicle is any commercial medium or heavy-duty on-highway vehicle or a work truck, as defined in 49 U.S.C. 32901(a)(7) and (19). For the purpose of this section, heavy-duty vehicles are divided into four regulatory categories as follows:

(1) Heavy-duty pickup trucks and vans;

(2) Heavy-duty vocational vehicles;

(3) Truck tractors with a GVWR above 26,000 pounds; and

(4) Heavy-duty trailers.

(b) The heavy-duty vehicle classification does not include vehicles excluded as specified in 49 CFR 535.3.

■ 377. Revise § 523.7 to read as follows:

**§ 523.7 Heavy-duty pickup trucks and vans.**

(a) Heavy-duty pickup trucks and vans are pickup trucks and vans with a gross vehicle weight rating between 8,501 pounds and 14,000 pounds (Class 2b through 3 vehicles) manufactured as complete vehicles by a single or final stage manufacturer or manufactured as incomplete vehicles as designated by a manufacturer. See references in 40 CFR 86.1801–12, 40 CFR 86.1819–17, 40 CFR 1037.150, and 49 CFR 535.5(a).

(b) Heavy duty vehicles above 14,000 pounds GVWR may be optionally certified as heavy-duty pickup trucks and vans and comply with fuel consumption standards in 49 CFR 535.5(a), if properly included in a test group with similar vehicles at or below 14,000 pounds GVWR. Fuel consumption standards apply to these vehicles as if they were Class 3 heavy-duty vehicles. The work factor for these vehicles may not be greater than the largest work factor that applies for vehicles in the test group that are at or below 14,000 pounds GVWR (see 40 CFR 86.1819–14).

(c) Incomplete heavy-duty vehicles at or below 14,000 pounds GVWR may be optionally certified as heavy-duty pickup trucks and vans and comply with to the fuel consumption standards in 49 CFR 535.5(a).

■ 378. Add § 523.10 to read as follows:

**§ 523.10 Heavy-duty trailers.**

(a) A trailer means a motor vehicle with or without motive power, designed for carrying cargo and for being drawn by another motor vehicle as defined in 49 CFR 571.3. For the purpose of this part, heavy-duty trailers include only those trailers designed to be drawn by a truck tractor excluding non-box trailers other than flatbed trailer, tanker trailers and container chassis and those that are coupled to vehicles exclusively by pintle hooks or hitches instead of a fifth wheel. Heavy-duty trailers may be divided into different types and categories as follows:

(1) Box vans are trailers with enclosed cargo space that is permanently attached to the chassis, with fixed sides, nose, and roof. Tank trailers are not box vans.

(2) Box van with front-mounted HVAC systems are refrigerated vans. Note that this includes systems that

provide cooling, heating, or both. All other box vans are dry vans.

(3) Trailers that are not box vans are non-box trailers. Note that the standards for non-box trailers in 49 CFR 535.5(e)(2) apply only to flatbed trailers, tank trailers, and container chassis.

(4) Box van with a length greater than 50 feet are long box vans. Other box vans are short box vans.

(5) The following types of equipment are not trailers:

(i) Containers that are not permanently mounted on chassis.

(ii) Dollies used to connect tandem trailers.

(iii) Equipment that serves similar purposes but are not intended to be pulled by a tractor.

(b) Heavy-duty trailers do not include trailers excluded in 49 CFR 535.3.

**PART 534—RIGHTS AND RESPONSIBILITIES OF MANUFACTURERS IN THE CONTEXT OF CHANGES IN CORPORATE RELATIONSHIPS**

■ 379. Revise the authority citation for part 534 to read as follows:

**Authority:** 49 U.S.C. 32901; delegation of authority at 49 CFR 1.95.

■ 380. Add § 534.8 to read as follows:

**§ 534.8 Shared corporate relationships.**

(a) Vehicles and engines built by multiple manufacturers can share responsibility for complying with fuel consumption standards in 49 CFR part 535, by following the EPA requirements in 40 CFR 1037.620 and by sending a joint agreement between the parties to EPA and NHTSA before submitting any certificates of conformity for the applicable vehicles or engines in accordance with 40 CFR part 1036, subpart C, and 40 CFR part 1037, subpart C.

(1) Each joint agreement must—

(i) Define how each manufacturer shares responsibility for the planned vehicles or engines.

(ii) Specify which manufacturer(s) will be responsible for the EPA certificates of conformity;

(iii) Describe the planned vehicles and engines in terms of the model types, production volumes, and model years (if known);

(iv) Describe which manufacturer(s) have engineering and design control and sale distribution ownership over the vehicles and/or engines; and

(v) Include signatures from all parties involved in the shared corporate relationship.

(2) After defining the shared relationship between the manufacturers, any contractual changes must be

notified to EPA and NHTSA before the next model year's production of the applicable vehicles or engines begins.

(3) Multiple manufacturers must designate the same shared responsibility for complying with fuel consumption standards as selected for GHG standards unless otherwise allowed by EPA and NHTSA.

(b) NHTSA and EPA reserve the right to reject the joint agreement.

■ 381. Revise part 535 to read as follows:

**PART 535 MEDIUM-AND HEAVY-DUTY VEHICLE FUEL EFFICIENCY PROGRAM**

Sec.

535.1 Scope.

535.2 Purpose.

535.3 Applicability.

535.4 Definitions.

535.5 Standards.

535.6 Measurement and calculation procedures.

535.7 Averaging, banking, and trading (ABT) credit program.

535.8 Reporting and recordkeeping requirements.

535.9 Enforcement approach.

535.10 How do manufacturers comply with fuel consumption standards?

**Authority:** 49 U.S.C. 32902 and 30101; delegation of authority at 49 CFR 1.95.

**§ 535.1 Scope.**

This part establishes fuel consumption standards pursuant to 49 U.S.C. 32902(k) for work trucks and commercial medium- and heavy-duty on-highway vehicles, including trailers (hereafter referenced as heavy-duty vehicles), and engines manufactured for sale in the United States. This part establishes a credit program manufacturers may use to comply with standards and requirements for manufacturers to provide reports to the National Highway Traffic Safety Administration regarding their efforts to reduce the fuel consumption of heavy-duty vehicles and engines.

**§ 535.2 Purpose.**

The purpose of this part is to reduce the fuel consumption of new heavy-duty vehicles and engines by establishing maximum levels for fuel consumption standards while providing a flexible credit program to assist manufacturers in complying with standards.

**§ 535.3 Applicability.**

(a) This part applies to manufacturers that produce complete and incomplete heavy-duty vehicles as defined in 49 CFR part 523, and to the manufacturers of all heavy-duty engines manufactured for use in the applicable vehicles for each given model year.

(b) This part also applies to alterers, final stage manufacturers, and intermediate manufacturers producing vehicles and engines or assembling motor vehicles or motor vehicle equipment under special conditions. Manufacturers comply with this part by following the special conditions in 40 CFR 1037.620, 1037.621, and 1037.622 in which EPA allows manufacturer to:

(1) Share responsibility for the vehicles they produce. Manufacturers sharing responsibility for complying with emissions and fuel consumption standards must submit to the agencies a joint agreement as specified in 49 CFR 534.8(a);

(2) Have certificate holders sell or ship vehicles that are missing certain emission-related components to be installed by secondary vehicle manufacturers;

(3) Ship partially complete vehicles to secondary manufacturers;

(4) Build electric vehicles; and

(5) Build alternative fueled vehicles from all types of heavy duty engine conversions. The conversion manufacturer must:

(i) Install alternative fuel conversion systems into vehicles acquired from vehicle manufacturers prior to first retail sale or prior to the vehicle's introduction into interstate commerce.

(ii) Be designated by the vehicle manufacturer and EPA to be the certificate holder.

(iii) Omit alternative fueled vehicles from compliance with vehicle fuel consumption standards, if—

(A) Excluded from EPA emissions standards; and

(B) A reasonable technical basis exist that the modified vehicle continues to meet emissions and fuel consumption vehicle standards.

(c) Vehicle and engine manufacturers that must comply with this part include manufacturers required to have approved certificates of conformity from EPA as specified in 40 CFR parts 86, 1036, and 1037.

(d) The following heavy-duty vehicles and engines are excluded from the requirements of this part:

(1) Vehicles and engines manufactured prior to January 1, 2014, unless certified early under NHTSA's voluntary provisions in § 535.5.

(2) Medium-duty passenger vehicles and other vehicles subject to the light-duty corporate average fuel economy standards in 49 CFR parts 531 and 533.

(3) Recreational vehicles, including motor homes manufactured before January 1, 2021, except those produced by manufacturers voluntarily complying with NHTSA's early vocational

standards for model years 2013 through 2020.

(4) Aircraft vehicles meeting the definition of "motor vehicle". For example, this would include certain convertible aircraft that can be adjusted to operate on public roads.

(5) Heavy-duty trailers as defined in 49 CFR 523.10 meeting one or more of the following criteria are excluded from trailer standards in § 535.5(e):

(i) Trailers with four or more axles and trailers less than 35 feet long with three axles (*i.e.*, trailers intended for hauling very heavy loads).

(ii) Trailers intended for temporary or permanent residence, office space, or other work space, such as campers, mobile homes, and carnival trailers.

(iii) Trailers with a gap of at least 120 inches between adjacent axle centerlines. In the case of adjustable axle spacing, this refers to the closest possible axle positioning.

(iv) Trailers built before January 1, 2021, except those trailers built by manufacturers after January 1, 2018, and voluntarily complying with NHTSA's early trailer standards for model years 2018 through 2020.

(v) Note that the definition of "heavy-duty trailer" in 49 CFR 523.10 excludes equipment that serves similar purposes but are not intended to be pulled by a tractor. This exclusion applies to such equipment whether or not they are known commercially as trailers. For example, any equipment pulled by a heavy-duty vehicle with a pintle hook or hitch instead of a fifth wheel does not qualify as a trailer under this part.

(6) Engines installed in heavy-duty vehicles that are not used to propel vehicles. Note, this includes engines used to indirectly propel vehicles (such as electrical generator engines that power to batteries for propulsion).

(7) The provisions of this part do not apply to engines that are not internal combustion engines. For example, the provisions of this part do not apply to fuel cells. Note that gas turbine engines are internal combustion engines.

(e) The following heavy-duty vehicles and engines are exempted from the requirements of this part:

(1) *Off-road vehicles.* Vehicle manufacturers producing vehicles intended for off-road may exempt vehicles without requesting approval from the agencies subject to the criteria in § 535.5(b)(9)(i) and 40 CFR 1037.631(a). If unusual circumstances exist and a manufacturer is uncertain as to whether its vehicles qualify, the manufacturer should ask for a preliminary determination from the agencies before submitting its application for certification in

accordance with 40 CFR 1037.205 for the applicable vehicles. Send the request with supporting information to EPA and the agencies will coordinate in making a preliminary determination as specified in 40 CFR 1037.210. These decisions are considered to be preliminary approvals and subject to final review and approval.

(2) *Small business manufacturers.* (i) For Phase 1, small business manufacturers are exempted from the vehicle and engine standards of § 535.5, but must comply with the reporting requirements of § 535.8(g).

(ii) For Phase 2, fuel consumption standards apply on a delayed schedule for manufacturers meeting the small business criteria specified in 13 CFR 121.201 and in 40 CFR 86.1819–14(k)(5), 40 CFR 1036.150, and 40 CFR 1037.150. Qualifying manufacturers of truck tractors, vocational vehicles, heavy duty pickups and vans, and engines are not subject to the fuel consumption standards for vehicles built before January 1, 2022 and engines (such as those engines built by small alternative fuel engine converters) with a date of manufacturer on or after November 14, 2011 and before January 1, 2022. Qualifying manufacturers may choose to voluntarily comply early.

(iii) Small business manufacturers producing vehicles and engines that run on any fuel other than gasoline, E85, or diesel fuel meeting the criteria specified in 13 CFR 121.201 and in 40 CFR 86.1819–14(k)(5), 40 CFR 1036.150, and 40 CFR 1037.150 may delay complying with every new mandatory standard under this part by one model year.

(3) *Transitional allowances for trailers.* Through model year 2026, trailer manufacturers may calculate a number of trailers that are exempt from the fuel consumption standards of this part. Calculate the number of exempt box vans in a given model year by multiplying the manufacturer's total U.S.-directed production volume of certified box vans by 0.20 and rounding to the nearest whole number; however, in no case may the number of exempted box vans be greater than 350 units in any given model year. Repeat this calculation to determine the number of non-box trailers, up to 250 annual units, that are exempt from standards and certification requirements.

Manufacturers perform the calculation based on their projected production volumes in the first year that standards apply; in later years, use actual production volumes from the preceding model year. Manufacturers must include these calculated values and the production volumes of exempt trailers

in their annual production reports required under § 535.8(g)(12).

(4) *Engines for specialty vehicles.* Engines certified to the alternative standards specified in 40 CFR 86.007–11 and 86.008–10 for use in specialty vehicles as described in 40 CFR 1037.605. Compliance with the vehicle provisions in 40 CFR 1037.605 satisfies compliance for NHTSA under this part. (f) For model year 2021 and later, vocational vehicle manufacturers building custom chassis vehicles (e.g. emergency vehicles) may be exempted from standards in § 535.5(b)(4) and may comply with alternative fuel consumption standards as specified in § 535.5(b)(6). Manufacturers complying with alternative fuel consumption standards in § 535.5(b)(6) are restricted in using fuel consumption credits as specified in § 535.7(c).

(g) The fuel consumption standards in some cases apply differently for spark-ignition and compression-ignition engines or vehicles as specified in 40 CFR parts 1036 and 1037. Engine requirements are similarly differentiated by engine type and by primary intended service class, as described in 40 CFR 1036.140.

(h) NHTSA may exclude or exempt vehicles and engines under special conditions allowed by EPA in accordance with 40 CFR parts 85, 86, 1036, 1037, 1039, and 1068. Manufacturers should consult the agencies if uncertain how to apply any EPA provision under the NHTSA fuel consumption program. It is recommended that manufacturers seek clarification before producing a vehicle. Upon notification by EPA of a fraudulent use of an exemption, NHTSA reserves that right to suspend or revoke any exemption or exclusion.

(i) In cases where there are differences between the application of this part and the corresponding EPA program regarding whether a vehicle is regulated or not (such as due to differences in applicability resulting from differing agency definitions, etc.), manufacturers should contact the agencies to identify these vehicles and assess the applicability of the agencies' standards. The agencies will provide guidance on how the vehicles can comply. Manufacturers are required to identify these vehicles in their final reports submitted in accordance with § 535.8.

#### § 535.4 Definitions.

The terms manufacture and manufacturer are used as defined in section 501 of the Act and the terms commercial medium-duty and heavy-duty on highway vehicle, fuel and work truck are used as defined in 49 U.S.C.

32901. See 49 CFR 523.2 for general definitions related to NHTSA's fuel efficiency programs.

*Act* means the Motor Vehicle Information and Cost Savings Act, as amended by Pub. L. 94–163 and 96–425.

*Administrator* means the Administrator of the National Highway Traffic Safety Administration (NHTSA) or the Administrator's delegate.

*Advanced technology* means vehicle technology under this fuel consumption program in §§ 535.6 and 535.7 and by EPA under 40 CFR 86.1819–14(d)(7), 1036.615, or 1037.615.

*Alterers* means a manufacturer that modifies an altered vehicle as defined in 49 CFR 567.3

*Alternative fuel conversion* has the meaning given for clean alternative fuel conversion in 40 CFR 85.502.

*A to B testing* has the meaning given in 40 CFR 1037.801.

*Automated manual transmission* has the meaning given in 40 CFR 1037.801.

*Automatic tire inflation system* has the meaning given in 40 CFR 1037.801.

*Automatic transmission (AT)* has the meaning given in 40 CFR 1037.801.

*Auxiliary power unit* has the meaning given in 40 CFR 1037.801.

*Averaging set* means, a set of engines or vehicles in which fuel consumption credits may be exchanged. Credits generated by one engine or vehicle family may only be used by other respective engine or vehicle families in the same averaging set as specified in § 535.7. Note that an averaging set may comprise more than one regulatory subcategory. The averaging sets for this HD program are defined as follows:

- (1) Heavy-duty pickup trucks and vans.
- (2) Light heavy-duty (LHD) vehicles.
- (3) Medium heavy-duty (MHD) vehicles.
- (4) Heavy heavy-duty (HHD) vehicles.
- (5) Light heavy-duty engines subject to compression-ignition standards.
- (6) Medium heavy-duty engines subject to compression-ignition standards.
- (7) Heavy heavy-duty engines subject to compression-ignition standards.
- (8) Engines subject to spark-ignition standards.
- (9) Long trailers.
- (10) Short trailers.
- (11) Vehicle types certifying to optional custom chassis standards as specified in § 535.5(b)(6) form separate averaging sets for each vehicle type as specified in § 535.7(c).

*Axle ratio or Drive axle ratio,  $k_a$*  has the meaning given in 40 CFR 1037.801.

*Basic vehicle frontal area* has the meaning given in 40 CFR 1037.801.

*Cab-complete vehicle* has the meaning given in 49 CFR 523.2.

*Carryover* has the meaning given in 40 CFR 1037.801.

*Certificate holder* means the manufacturer who holds the certificate of conformity for the vehicle or engine and that assigns the model year based on the date when its manufacturing operations are completed relative to its annual model year period.

*Certificate of Conformity* means an approval document granted by EPA to a manufacturer that submits an application for a vehicle or engine emissions family in 40 CFR 1036.205 and 1037.205. A certificate of conformity is valid from the indicated effective date until December 31 of the model year for which it is issued. The certificate must be renewed annually for any vehicle a manufacturer continues to produce.

*Certification* has the meaning given in 40 CFR 1037.801.

*Certified emission level* has the meaning given in 40 CFR 1036.801.

*Chassis-cab* means the incomplete part of a vehicle that includes a frame, a completed occupant compartment and that requires only the addition of cargo-carrying, work-performing, or load-bearing components to perform its intended functions.

*Chief Counsel* means the NHTSA Chief Counsel, or his or her designee.

*Class* means relating to GVWR classes for vehicles other than trailers, as follows:

(1) *Class 2b vehicles* are vehicles with a gross vehicle weight rating (GVWR) ranging from 8,501 to 10,000 pounds.

(2) *Class 3 through Class 8 vehicles* are vehicles with a gross vehicle weight rating (GVWR) of 10,001 pounds or more as defined in 49 CFR 565.15.

*Complete sister vehicle* is a complete vehicle of the same configuration as a cab-complete vehicle.

*Complete vehicle* has the meaning given in 49 CFR part 523.

*Compression-ignition (CI)* means relating to a type of reciprocating, internal-combustion engine, such as a diesel engine, that is not a spark-ignition engine. Note, in accordance with 40 CFR 1036.1, gas turbine engines and other engines not meeting the definition of compression-ignition are deemed to be compression-ignition engines for complying with fuel consumption standards.

*Configuration* means a subclassification within a test group for passenger cars, light trucks and medium-duty passenger vehicles and heavy-duty pickup trucks and vans which is based on basic engine, engine code, transmission type and gear ratios, and final drive ratio.

*Container chassis trailer* has the same meaning as container chassis in 40 CFR 1037.801.

*Curb weight* has the meaning given in 40 CFR 86.1803.

*Custom chassis vehicle* means a vocational vehicle that is a motor home, school bus, refuse hauler, concrete mixer, emergency vehicle, mixed-use vehicle or other buses that are not school buses or motor coaches. These vehicle types are defined in 49 CFR 523.3. A "mixed-use vehicle" is one that meets at least one of the criteria specified in 40 CFR 1037.631(a)(1) or at least one of the criteria in 40 CFR 1037.631(a)(2), but not both.

*Date of manufacture* means the date on which the certifying vehicle manufacturer completes its manufacturing operations, except as follows:

(1) Where the certificate holder is an engine manufacturer that does not manufacture the complete or incomplete vehicle, the date of manufacture of the vehicle is based on the date assembly of the vehicle is completed.

(2) EPA and NHTSA may approve an alternate date of manufacture based on the date on which the certifying (or primary) vehicle manufacturer completes assembly at the place of main assembly, consistent with the provisions of 40 CFR 1037.601 and 49 CFR 567.4.

(3) A vehicle manufacturer that completes assembly of a vehicle at two or more facilities may ask to use as the month and year of manufacture, for that vehicle, the month and year in which manufacturing is completed at the place of main assembly, consistent with provisions of 49 CFR 567.4, as the model year. Note that such staged assembly is subject to the provisions of 40 CFR 1068.260(c). NHTSA's allowance of this provision is effective when EPA approves the manufacturer's certificates of conformity for these vehicles.

*Day cab* has the meaning given in 40 CFR 1037.801.

*Drayage tractor* has the meaning given in 40 CFR 1037.801.

*Dual-clutch transmission (DCT)* means a transmission has the meaning given in 40 CFR 1037.801.

*Dual-fuel* has the meaning given in 40 CFR 1037.801.

*Electric vehicle* has the meaning given in 40 CFR 1037.801.

*Emergency vehicle* means a vehicle that meets one of the criteria in 40 CFR 1037.801.

*Engine family* has the meaning given in 40 CFR 1036.230. Manufacturers designate families in accordance with EPA provisions and may not choose

different families between the NHTSA and EPA programs.

*Excluded* means a vehicle or engine manufacturer or component is not required to comply with any aspects with the NHTSA fuel consumption program.

*Exempted* means a vehicle or engine manufacturer or component is not required to comply with certain provisions of the NHTSA fuel consumption program.

*Family certification level (FCL)* has the meaning given in 40 CFR 1036.801.

*Family emission limit (FEL)* has the meaning given in 40 CFR 1037.801.

*Final drive ratio* has the meaning given in 40 CFR 1037.801.

*Final-stage manufacturer* has the meaning given in 49 CFR 567.3 and includes secondary vehicle manufacturers as defined in 40 CFR 1037.801.

*Flatbed trailer* has the meaning given in 40 CFR 1037.801.

*Fleet* in this part means all the heavy-duty vehicles or engines within each of the regulatory sub-categories that are manufactured by a manufacturer in a particular model year and that are subject to fuel consumption standards under § 535.5.

*Fleet average fuel consumption* is the calculated average fuel consumption performance value for a manufacturer's fleet derived from the production weighted fuel consumption values of the unique vehicle configurations within each vehicle model type that makes up that manufacturer's vehicle fleet in a given model year. In this part, the fleet average fuel consumption value is determined for each manufacturer's fleet of heavy-duty pickup trucks and vans.

*Fleet average fuel consumption standard* is the actual average fuel consumption standard for a manufacturer's fleet derived from the production weighted fuel consumption standards of each unique vehicle configuration, based on payload, tow capacity and drive configuration (2, 4 or all-wheel drive), of the model types that makes up that manufacturer's vehicle fleet in a given model year. In this part, the fleet average fuel consumption standard is determined for each manufacturer's fleet of heavy-duty pickup trucks and vans.

*Fuel cell* means an electrochemical cell that produces electricity via the non-combustion reaction of a consumable fuel, typically hydrogen.

*Fuel cell electric vehicle* means a motor vehicle propelled solely by an electric motor where energy for the motor is supplied by a fuel cell.



*Fuel efficiency* means the amount of work performed for each gallon of fuel consumed.

*Gaseous fuel* has the meaning given in 40 CFR 1037.801.

*Greenhouse gas Emissions Model (GEM)* has the meaning given in 40 CFR 1037.801.

*Gross axle weight rating (GAWR)* has the meaning given in 49 CFR 571.3.

*Gross combination weight rating (GCWR)* has the meaning given in 49 CFR 571.3.

*Gross vehicle weight rating (GVWR)* has the meaning given in 49 CFR 571.3.

*Good engineering judgment* has the meaning given in 40 CFR 1068.30. See 40 CFR 1068.5 for the administrative process used to evaluate good engineering judgment.

*Heavy-duty off-road vehicle* means a heavy-duty vocational vehicle or vocational tractor that is intended for off-road use.

*Heavy-duty vehicle* has the meaning given in 49 CFR part 523.

*Heavy-haul tractor* has the meaning given in 40 CFR 1037.801.

*Heavy heavy-duty (HHD) vehicle* has the meaning given in vehicle service class.

*Hybrid engine or hybrid powertrain* means an engine or powertrain that includes energy storage features other than a conventional battery system or conventional flywheel. Supplemental electrical batteries and hydraulic accumulators are examples of hybrid energy storage systems. Note that certain provisions in this part treat hybrid engines and powertrains intended for vehicles that include regenerative braking different than those intended for vehicles that do not include regenerative braking.

*Hybrid vehicle* means a vehicle that includes energy storage features (other than a conventional battery system or conventional flywheel) in addition to an internal combustion engine or other engine using consumable chemical fuel. Supplemental electrical batteries and hydraulic accumulators are examples of hybrid energy storage systems. Note that certain provisions in this part treat hybrid vehicles that include regenerative braking different than those that do not include regenerative braking.

*Idle operation* has the meaning given in 40 CFR 1037.801.

*Incomplete vehicle* has the meaning given in 49 CFR part 523. For the purpose of this regulation, a manufacturer may request EPA and NHTSA to allow the certification of a vehicle as an incomplete vehicle if it manufactures the engine and sells the unassembled chassis components, provided it does not produce and sell

the body components necessary to complete the vehicle.

*Innovative technology* means technology certified under § 535.7 and by EPA under 40 CFR 86.1819–14(d)(13), 1036.610, and 1037.610 in the Phase 1 program.

*Intermediate manufacturer* has the meaning given in 49 CFR 567.3.

*Light heavy-duty (LHD) vehicle* has the meaning given in vehicle service class.

*Liquefied petroleum gas (LPG)* has the meaning given in 40 CFR 1036.801.

*Low rolling resistance tire* means a tire on a vocational vehicle with a tire rolling resistance level (TRRL) of 7.7 kg/metric ton or lower, a steer tire on a tractor with a TRRL of 7.7 kg/metric ton or lower, or a drive tire on a tractor with a TRRL of 8.1 kg/metric ton or lower.

*Manual transmission (MT)* has the meaning given in 40 CFR 1037.801.

*Medium heavy-duty (MHD) vehicle* has the meaning given in vehicle service class.

*Model type* has the meaning given in 40 CFR 600.002.

*Model year* as it applies to vehicles means:

(1) For tractors and vocational vehicles with a date of manufacture on or after January 1, 2021, the vehicle's *model year* is the calendar year corresponding to the date of manufacture; however, the vehicle's model year may be designated to be the year before the calendar year corresponding to the date of manufacture if the engine's model year is also from an earlier year. Note that subparagraph (2) of this definition limits the extent to which vehicle manufacturers may install engines built in earlier calendar years. Note that 40 CFR 1037.601(a)(2) limits the extent to which vehicle manufacturers may install engines built in earlier calendar years.

(2) For trailers and for Phase 1 tractors and vocational vehicles with a date of manufacture before January 1, 2021, *model year* means the manufacturer's annual new model production period, except as restricted under this definition. It must include January 1 of the calendar year for which the model year is named, may not begin before January 2 of the previous calendar year, and it must end by December 31 of the named calendar year. The model year may be set to match the calendar year corresponding to the date of manufacture.

(i) The manufacturer who holds the certificate of conformity for the vehicle must assign the model year based on the date when its manufacturing operations are completed relative to its annual

model year period. In unusual circumstances where completion of your assembly is delayed, we may allow you to assign a model year one year earlier, provided it does not affect which regulatory requirements will apply.

(ii) Unless a vehicle is being shipped to a secondary manufacturer that will hold the certificate of conformity, the model year must be assigned prior to introduction of the vehicle into U.S. commerce. The certifying manufacturer must redesignate the model year if it does not complete its manufacturing operations within the originally identified model year. A vehicle introduced into U.S. commerce without a model year is deemed to have a model year equal to the calendar year of its introduction into U.S. commerce unless the certifying manufacturer assigns a later date.

*Model year* as it applies to engines means the manufacturer's annual new model production period, except as restricted under this definition. It must include January 1 of the calendar year for which the model year is named, may not begin before January 2 of the previous calendar year, and it must end by December 31 of the named calendar year. Manufacturers may not adjust model years to circumvent or delay compliance with emission standards or to avoid the obligation to certify annually.

*Natural gas* has the meaning given in 40 CFR 1036.801. Vehicles that use a pilot-ignited natural gas engine (which uses a small diesel fuel ignition system), are still considered natural gas vehicles.

*NHTSA Enforcement* means the NHTSA Associate Administrator for Enforcement, or his or her designee.

*Neutral coasting* has the meaning given in 40 CFR 1037.801.

*Off-cycle technology* means technology certified under § 535.7 and by EPA under 40 CFR 86.1819–14(d)(13), 1036.610, and 1037.610 in the Phase 2 program.

*Party* means the person alleged to have committed a violation of § 535.9, and includes manufacturers of vehicles and manufacturers of engines.

*Payload* means in this part the resultant of subtracting the curb weight from the gross vehicle weight rating.

*Petroleum* has the meaning given in 40 CFR 1037.801.

*Phase 1* means the joint NHTSA and EPA program established in 2011 for fuel efficiency standards and greenhouse gas emissions standards regulating medium- and heavy-duty engines and vehicles. See § 535.5 for the specific model years that standards apply to vehicles and engines.



*Phase 2* means the joint NHTSA and EPA program established in 2016 for fuel efficiency standards and greenhouse gas emissions standards regulating medium- and heavy-duty vehicles including trailers, and engines. See § 535.5 for the specific model years that standards apply to vehicles and engines.

*Pickup truck* has the meaning given in 49 CFR part 523.

*Plug-in hybrid electric vehicle (PHEV)* means a hybrid electric vehicle that has the capability to charge the battery or batteries used for vehicle propulsion from an off-vehicle electric source, such that the off-vehicle source cannot be connected to the vehicle while the vehicle is in motion.

*Power take-off (PTO)* means a secondary engine shaft or other system on a vehicle that provides substantial auxiliary power for purposes unrelated to vehicle propulsion or normal vehicle accessories such as air conditioning, power steering, and basic electrical accessories. A typical PTO uses a secondary shaft on the engine to transmit power to a hydraulic pump that powers auxiliary equipment such as a boom on a bucket truck.

*Powertrain family* has the meaning given in 40 CFR 1037.231. Manufacturers choosing to perform powertrain testing as specified in 40 CFR 1037.550, divide product lines into powertrain families that are expected to have similar fuel consumptions and CO<sub>2</sub> emission characteristics throughout the useful life.

*Preliminary approval* means approval granted by an authorized EPA representative prior to submission of an application for certification, consistent with the provisions of 40 CFR 1037.210. For requirements involving NHTSA, EPA will ensure decisions are jointly made and will convey the decision to the manufacturer.

*Primary intended service class* has the same meaning for engines as specified in 40 CFR 1036.140. Manufacturers must identify a single primary intended service class for each engine family that best describes vehicles for which it designs and markets the engine, as follows:

(1) Divide compression-ignition engines into primary intended service classes based on the following engine and vehicle characteristics:

(i) Light heavy-duty “LHD” engines usually are not designed for rebuild and do not have cylinder liners. Vehicle body types in this group might include any heavy-duty vehicle built from a light-duty truck chassis, van trucks, multi-stop vans, and some straight trucks with a single rear axle. Typical applications would include personal transportation, light-load commercial delivery, passenger service, agriculture, and construction. The GVWR of these vehicles is normally below 19,500 pounds.

(ii) Medium heavy-duty “MHD” engines may be designed for rebuild and may have cylinder liners. Vehicle body types in this group would typically include school buses, straight trucks with single rear axles, city tractors, and a variety of special purpose vehicles such as small dump trucks, and refuse trucks. Typical applications would include commercial short haul and intra-city delivery and pickup. Engines in this group are normally used in vehicles whose GVWR ranges from 19,500 to 33,000 pounds.

(iii) Heavy heavy-duty “HHD” engines are designed for multiple rebuilds and have cylinder liners. Vehicles in this group are normally tractors, trucks, straight trucks with dual rear axles, and buses used in inter-city, long-haul applications. These vehicles normally exceed 33,000 pounds GVWR.

(2) Divide spark-ignition engines into primary intended service classes as follows:

(i) Spark-ignition engines that are best characterized by paragraph (1)(i) or (ii) of this definition are in a separate “spark-ignition” primary intended service class.

(ii) Spark-ignition engines that are best characterized by paragraph (1)(iii) of this definition share a primary intended service class with compression-ignition heavy heavy-duty engines. Gasoline-fueled engines are presumed not to be characterized by paragraph (1)(iii) of this definition; for example, vehicle manufacturers may install some number of gasoline-fueled engines in Class 8 trucks without causing the engine manufacturer to consider those to be heavy heavy-duty engines.

(iii) References to “spark-ignition standards” in this part relate only to the spark-ignition engines identified in

paragraph (b)(1) of this section. References to “compression-ignition standards” in this part relate to compression-ignition engines, to spark-ignition engines optionally certified to standards that apply to compression-ignition engines, and to all engines identified under paragraph (b)(2) of this section as heavy heavy-duty engines.

*Rechargeable Energy Storage System (RESS)* means the component(s) of a hybrid engine or vehicle that store recovered energy for later use, such as the battery system in a electric hybrid vehicle.

*Refuse hauler* has the meaning given in 40 CFR 1037.801.

*Regional* has the meaning relating to the Regional duty cycle as specified in 40 CFR 1037.510.

*Regulatory category* means each of the four types of heavy-duty vehicles defined in 49 CFR 523.6 and the heavy-duty engines used in these heavy-duty vehicles.

*Regulatory subcategory* means the sub-groups in each regulatory category to which mandatory fuel consumption standards and requirements apply as specified in 40 CFR 1036.230 and 1037.230 and are defined as follows:

(1) Heavy-duty pick-up trucks and vans.

(2) Vocational vehicle subcategories have 18 separate vehicle service classes as shown in Tables 1 and 2 below and include vocational tractors. Table 1 includes vehicles complying with Phase 1 standards. Phase 2 vehicles are included in Table 2 which have separate subcategories to account for engine characteristics, GVWR, and the selection of duty cycle for vocational vehicles as specified in 40 CFR 1037.510; vehicles may additionally fall into one of the subcategories defined by the custom-chassis standards in § 535.5(b)(6) and 40 CFR 1037.105(h). Manufacturers using the alternate standards in § 535.5(b)(6) and 40 CFR 1037.105(h) should treat each vehicle type as a separate vehicle subcategory.

TABLE 1—PHASE 1 VOCATIONAL VEHICLE SUBCATEGORIES

Vocational LHD vehicles.  
Vocational MHD vehicles.  
Vocational HHD vehicles.

TABLE 2—PHASE 2 VOCATIONAL VEHICLE SUBCATEGORIES

Engine type	Vocational LHD vehicles	Vocational MHD vehicles	Vocational HHD vehicles
CI .....	Urban .....	Urban .....	Urban.
CI .....	Multi-Purpose .....	Multi-Purpose .....	Multi-Purpose.
CI .....	Regional .....	Regional .....	Regional.

TABLE 2—PHASE 2 VOCATIONAL VEHICLE SUBCATEGORIES—Continued

Engine type	Vocational LHD vehicles	Vocational MHD vehicles	Vocational HHD vehicles
SI .....	Urban .....	Urban .....	NA.
SI .....	Multi-Purpose .....	Multi-Purpose .....	NA.
SI .....	Regional .....	Regional .....	NA.

(3) Tractor subcategories are shown in Table 3 below for Phase 1 and 2. Table 3 includes 10 separate subcategories for tractors complying with Phase 1 and 2 standards. The heavy-haul tractor subcategory only applies for Phase 2.

TABLE 3—PHASE 1 AND 2 TRUCK TRACTOR SUBCATEGORIES

Class 7	Class 8 day cabs	Class 8 sleeper cabs
Low-roof tractors .....	Low-roof day cab tractors .....	Low-roof sleeper cab tractors.
Mid-roof tractors .....	Mid-roof day cab tractors .....	Mid-roof sleeper cab tractors.
High-roof tractors .....	High-roof day cab tractors .....	High-roof sleeper cab tractors.
NA .....	Heavy-haul tractors (applies only to Phase 2 program).	

(4) Trailer subcategories are shown in Table 4 of this section for the Phase 2 program. Trailers do not comply under the Phase 1 program. Table 4 includes 10 separate subcategories for trailers, which are only subject to Phase 2 only standards.

TABLE 4—TRAILER SUBCATEGORIES

Full-aero trailers	Partial-aero trailers	Other trailers
Long box dry vans .....	Long box dry vans .....	Non-aero box vans.
Short box dry vans .....	Short box dry vans .....	Non-box trailers.
Long box refrigerated vans .....	Long box refrigerated vans .....	NA.
Short box refrigerated vans .....	Short box refrigerated vans .....	NA.

(5) Engine subcategories are shown for each primary intended service class in Table 5 below. Table 5 includes 6 separate subcategories for engines which are the same for Phase 1 and 2 standards.

TABLE 5—ENGINE SUBCATEGORIES

LHD engines	MHD engines	HHD engines
CI engines for vocational vehicles .....	CI engines for vocational vehicles .....	CI engines for vocational vehicles.
NA .....	CI engines for truck tractors .....	CI engines for truck tractors.
All spark-ignition engines .....		NA.

*Revoke* has the same meaning given in 40 CFR 1068.30.

*Roof height* means the maximum height of a vehicle (rounded to the nearest inch), excluding narrow accessories such as exhaust pipes and antennas, but including any wide accessories such as roof fairings. Measure roof height of the vehicle configured to have its maximum height that will occur during actual use, with properly inflated tires and no driver, passengers, or cargo onboard. Determine the base roof height on fully inflated tires having a static loaded radius equal to the arithmetic mean of the largest and smallest static loaded radius of tires a manufacturer offers or a standard tire EPA approves. If a vehicle is equipped with an adjustable roof fairing, measure the roof height with the fairing in its

lowest setting. Once the maximum height is determined, roof heights are divided into the following categories:

- (1) Low-roof means a vehicle with a roof height of 120 inches or less.
- (2) Mid-roof means a vehicle with a roof height between 121 and 147 inches.
- (3) High-roof means a vehicle with a roof height of 148 inches or more.

*Secondary vehicle manufacturer* has the same meaning as final-stage manufacturer in 49 CFR part 567.

*Service class group* means a group of engine and vehicle averaging sets defined as follows:

- (1) Spark-ignition engines, light heavy-duty compression-ignition engines, light heavy-duty vocational vehicles and heavy-duty pickup trucks and vans.

(2) Medium heavy-duty compression-ignition engines and medium heavy-duty vocational vehicles and tractors.

(3) Heavy heavy-duty compression-ignition engines and heavy heavy-duty vocational vehicles and tractors.

*Sleeper cab* means a type of truck cab that has a compartment behind the driver's seat intended to be used by the driver for sleeping. This includes both cabs accessible from the driver's compartment and those accessible from outside the vehicle.

*Small business manufacturer* means a manufacturer meeting the criteria specified in 13 CFR 121.201. For manufacturers owned by a parent company, the employee and revenue limits apply to the total number employees and total revenue of the parent company and all its subsidiaries.

*Spark-ignition (SI)* means relating to a gasoline-fueled engine or any other type of engine with a spark plug (or other sparking device) and with operating characteristics significantly similar to the theoretical Otto combustion cycle. Spark-ignition engines usually use a throttle to regulate intake air flow to control power during normal operation. Note that some spark-ignition engines are subject to requirements that apply for compression-ignition engines as described in 40 CFR 1036.140.

*Standard payload* means the payload assumed for each vehicle, in tons, for modeling and calculating emission credits, as follows:

- (1) For vocational vehicles:
  - (i) 2.85 tons for light heavy-duty vehicles.
  - (ii) 5.6 tons for medium heavy-duty vehicles.
  - (iii) 7.5 tons for heavy heavy-duty vocational vehicles.
- (2) For tractors:
  - (i) 12.5 tons for Class 7.
  - (ii) 19 tons for Class 8.
  - (iii) 43 tons for heavy-haul tractors.
- (3) For trailers:
  - (i) 10 tons for short box vans.
  - (ii) 19 tons for other trailers.

*Standard tractor* has the meaning given in 40 CFR 1037.501.

*Standard trailer* has the meaning given in 40 CFR 1037.501.

*Subconfiguration* means a unique combination within a vehicle configuration of equivalent test weight, road-load horsepower, and any other operational characteristics or parameters that EPA determines may significantly affect CO<sub>2</sub> emissions within a vehicle configuration as defined in 40 CFR 600.002.

*Tank trailer* has the meaning given in 40 CFR 1037.801.

*Test group* means the multiple vehicle lines and model types that share critical emissions and fuel consumption related features and that are certified as a group by a common certificate of conformity issued by EPA and is used collectively with other test groups within an averaging set or regulatory subcategory and is used by NHTSA for determining the fleet average fuel consumption.

*The agencies* means the National Highway Traffic Safety Administration (NHTSA) and the Environmental Protection Agency (EPA) in this part.

*Tire pressure monitoring system (TPMS)* has the meaning given in section S3 of 49 CFR 571.138.

*Tire rolling resistance level (TRRL)* means a value with units of kg/metric ton that represents that rolling resistance of a tire configuration. TRRLs are used as inputs to the GEM model under 40 CFR 1037.520. Note that a

manufacturer may assign a value higher than a measured rolling resistance of a tire configuration.

*Towing capacity* in this part is equal to the resultant of subtracting the gross vehicle weight rating from the gross combined weight rating.

*Trade* means to exchange fuel consumption credits, either as a buyer or a seller.

*U.S.-directed production volume* means the number of vehicle units, subject to the requirements of this part, produced by a manufacturer for which the manufacturer has a reasonable assurance that sale was or will be made to ultimate purchasers in the United States.

*Useful life* has the meaning given in 40 CFR 1036.801 and 1037.801.

*Vehicle configuration* means a unique combination of vehicle hardware and calibration (related to measured or modeled emissions) within a vehicle family as specified in 40 CFR 1037.801. Vehicles with hardware or software differences, but that have no hardware or software differences related to measured or modeled emissions or fuel consumption can be included in the same vehicle configuration. Note that vehicles with hardware or software differences related to measured or modeled emissions or fuel consumption are considered to be different configurations even if they have the same GEM inputs and FEL. Vehicles within a vehicle configuration differ only with respect to normal production variability or factors unrelated to measured or modeled emissions and fuel consumption for EPA and NHTSA.

*Vehicle family* has the meaning given in 40 CFR 1037.230. Manufacturers designate families in accordance with EPA provisions and may not choose different families between the NHTSA and EPA programs. If a manufacturer is certifying vehicles within a vehicle family to more than one FEL, it must subdivide its greenhouse gas and fuel consumption vehicle families into subfamilies that include vehicles with identical FELs. Note that a manufacturer may add subfamilies at any time during the model year.

*Vehicle service class* has the same meaning for vehicles as specified in 40 CFR 1037.140. Fuel consumption standards and other provisions of this part apply to specific vehicle service classes for tractors and vocational vehicles as follows:

- (1) Phase 1 and Phase 2 tractors are divided based on GVWR into Class 7 tractors and Class 8 tractors. Where provisions apply to both tractors and vocational vehicles, Class 7 tractors are considered medium heavy-duty "MHD"

vehicles and Class 8 tractors are considered heavy heavy-duty "HHD" vehicles.

(2) Phase 1 vocational vehicles are divided based on GVWR. Light heavy-duty "LHD" vehicles includes Class 2b through Class 5 vehicles; medium heavy-duty "MHD" vehicles includes Class 6 and Class 7 vehicles; and heavy heavy-duty "HHD" vehicles includes Class 8 vehicles.

(3) Phase 2 vocational vehicles with spark-ignition engines are divided based on GVWR. Light heavy-duty "LHD" vehicles includes Class 2b through Class 5 vehicles, and medium heavy-duty "MHD" vehicles includes Class 6 through Class 8 vehicles.

(4) Phase 2 vocational vehicles with compression-ignition engines are divided as follows:

(i) Class 2b through Class 5 vehicles are considered light heavy-duty "LHD" vehicles.

(ii) Class 6 through 8 vehicles are considered heavy heavy-duty "HHD" vehicles if the installed engine's primary intended service class is heavy heavy-duty (see 40 CFR 1036.140). All other Class 6 through Class 8 vehicles are considered medium heavy-duty "MHD" vehicles.

(5) In certain circumstances, manufacturers may certify vehicles to standards that apply for a different vehicle service class such as allowed in § 535.5(b)(6) and (c)(7). If manufacturers optionally certify vehicles to different standards, those vehicles are subject to all the regulatory requirements as if the standards were mandatory.

*Vehicle subfamily or subfamily* means a subset of a vehicle family including vehicles subject to the same FEL(s).

*Vocational tractor* has the meaning given in 40 CFR 1037.801.

*Zero emissions vehicle* means an electric vehicle or a fuel cell vehicle.

#### § 535.5 Standards.

(a) *Heavy-duty pickup trucks and vans.* Each manufacturer's fleet of heavy-duty pickup trucks and vans shall comply with the fuel consumption standards in this paragraph (a) expressed in gallons per 100 miles. Each vehicle must be manufactured to comply for its full useful life. For the Phase 1 program, if the manufacturer's fleet includes conventional vehicles (gasoline, diesel and alternative fueled vehicles) and advanced technology vehicles (hybrids with powertrain designs that include energy storage systems, vehicles with waste heat recovery, electric vehicles and fuel cell vehicles), it may divide its fleet into two separate fleets each with its own separate fleet average fuel consumption

standard which the manufacturer must comply with the requirements of this paragraph (a). For Phase 2, manufacturers may calculate their fleet average fuel consumption standard for a conventional fleet and multiple advanced technology vehicle fleets. Advanced technology vehicle fleets should be separated into plug-in hybrid electric vehicles, electric vehicles and fuel cell vehicles. NHTSA standards correspond to the same requirements for EPA as specified in 40 CFR 86.1819–14.

(1) *Mandatory standards.* For model years 2016 and later, each manufacturer must comply with the fleet average standard derived from the unique subconfiguration target standards (or groups of subconfigurations approved by EPA in accordance with 40 CFR 86.1819) of the model types that make up the manufacturer’s fleet in a given model year. Each subconfiguration has a unique attribute-based target standard, defined by each group of vehicles having the same payload, towing

capacity and whether the vehicles are equipped with a 2-wheel or 4-wheel drive configuration. Phase 1 target standards apply for model years 2016 through 2020. Phase 2 target standards apply for model year 2021 and afterwards.

(2) *Subconfiguration target standards.*

(i) Two alternatives exist for determining the subconfiguration target standards for Phase 1. For each alternative, separate standards exist for compression-ignition and spark-ignition vehicles:

(A) The first alternative allows manufacturers to determine a fixed fuel consumption standard that is constant over the model years; and

(B) The second alternative allows manufacturers to determine standards that are phased-in gradually each year.

(ii) Calculate the subconfiguration target standards as specified in this paragraph (a)(2)(ii), using the appropriate coefficients from Table 6 choosing between the alternatives in paragraph (a)(2)(i) of this section. For

electric or fuel cell heavy-duty vehicles, use compression-ignition vehicle coefficients “c” and “d” and for hybrid (including plug-in hybrid), dedicated and dual-fueled vehicles, use coefficients “c” and “d” appropriate for the engine type used. Round each standard to the nearest 0.001 gallons per 100 miles and specify all weights in pounds rounded to the nearest pound. Calculate the subconfiguration target standards using the following equation:

$$\text{Subconfiguration Target Standard (gallons per 100 miles)} = [c \times (\text{WF})] + d$$

Where:

$$\text{WF} = \text{Work Factor} = [0.75 \times (\text{Payload Capacity} + \text{Xwd})] + [0.25 \times \text{Towing Capacity}]$$

$$\text{Xwd} = \text{4wd Adjustment} = 500 \text{ lbs if the vehicle group is equipped with 4wd and all-wheel drive, otherwise equals 0 lbs for 2wd.}$$

$$\text{Payload Capacity} = \text{GVWR (lbs)} - \text{Curb Weight (lbs) (for each vehicle group)}$$

$$\text{Towing Capacity} = \text{GCWR (lbs)} - \text{GVWR (lbs) (for each vehicle group)}$$

TABLE 6—COEFFICIENTS FOR MANDATORY SUBCONFIGURATION TARGET STANDARDS

Model Year(s)	c	d
<b>Phase 1 Alternative 1—Fixed Target Standards</b>		
<b>CI Vehicle Coefficients</b>		
2016 to 2018 .....	0.0004322	3.330
2019 to 2020 .....	0.0004086	3.143
<b>SI Vehicle Coefficients</b>		
2016 to 2017 .....	0.0005131	3.961
2018 to 2020 .....	0.0004086	3.143
<b>Phase 1 Alternative 2—Phased-in Target Standards</b>		
<b>CI Vehicle Coefficients</b>		
2016 .....	0.0004519	3.477
2017 .....	0.0004371	3.369
2018 to 2020 .....	0.0004086	3.143
<b>SI Vehicle Coefficients</b>		
2016 .....	0.0005277	4.073
2017 .....	0.0005176	3.983
2018 to 2020 .....	0.0004951	3.815
<b>Phase 2—Fixed Target Standards</b>		
<b>CI Vehicle Coefficients</b>		
2021 .....	0.0003988	3.065
2022 .....	0.0003880	2.986
2023 .....	0.0003792	2.917
2024 .....	0.0003694	2.839
2025 .....	0.0003605	2.770
2026 .....	0.0003507	2.701
2027 and later .....	0.0003418	2.633
<b>SI Vehicle Coefficients</b>		
2021 .....	0.0004827	3.725
2022 .....	0.0004703	3.623

TABLE 6—COEFFICIENTS FOR MANDATORY SUBCONFIGURATION TARGET STANDARDS—Continued

Model Year(s)	c	d
2023 .....	0.0004591	3.533
2024 .....	0.0004478	3.443
2025 .....	0.0004366	3.364
2026 .....	0.0004253	3.274
2027 and later .....	0.0004152	3.196

(3) *Fleet average fuel consumption standard.* (i) For the Phase 1 program, calculate each manufacturer's fleet average fuel consumption standard for a conventional fleet and a combined advanced technology fleet separately

based on the subconfiguration target standards specified in paragraph (a)(2) of this section, weighted to production volumes and averaged using the following equation combining all the applicable vehicles in a manufacturer's

U.S.-directed fleet (compression-ignition, spark-ignition and advanced technology vehicles) for a given model year, rounded to the nearest 0.001 gallons per 100 miles:

$$\text{Fleet Average Standard} = \frac{\sum [\text{Subconfiguration Target Standard}_i \times \text{Volume}_i]}{\sum [\text{Volume}_i]}$$

Where:

Subconfiguration Target Standard<sub>i</sub> = fuel consumption standard for each group of vehicles with same payload, towing capacity and drive configuration (gallons per 100 miles).

Volume<sub>i</sub> = production volume of each unique subconfiguration of a model type based upon payload, towing capacity and drive configuration.

(A) A manufacturer may group together subconfigurations that have the same test weight (ETW), GVWR, and GCWR. Calculate work factor and target value assuming a curb weight equal to two times ETW minus GVWR.

(B) A manufacturer may group together other subconfigurations if it uses the lowest target value calculated for any of the subconfigurations.

(ii) For Phase 1, manufacturers must select an alternative for

subconfiguration target standards at the same time they submit the model year 2016 pre-model year Report, specified in § 535.8. Once selected, the decision cannot be reversed and the manufacturer must continue to comply with the same alternative for subsequent model years.

(4) *Voluntary standards.* (i) Manufacturers may choose voluntarily to comply early with fuel consumption standards for model years 2013 through 2015, as determined in paragraphs (a)(4)(iii) and (iv) of this section, for example, in order to begin accumulating credits through over-compliance with the applicable standard. A manufacturer choosing early compliance must comply with all the vehicles and engines it manufactures in each regulatory category for a given model year.

(ii) A manufacturer must declare its intent to voluntarily comply with fuel consumption standards at the same time it submits a Pre-Model Report, prior to the compliance model year beginning as specified in § 535.8; and, once selected, the decision cannot be reversed and the manufacturer must continue to comply for each subsequent model year for all the vehicles and engines it manufactures in each regulatory category for a given model year.

(iii) Calculate separate subconfiguration target standards for compression-ignition and spark-ignition vehicles for model years 2013 through 2015 using the equation in paragraph (a)(2)(ii) of this section, substituting the appropriate values for the coefficients in the following table as appropriate:

TABLE 7—COEFFICIENTS FOR VOLUNTARY SUBCONFIGURATION TARGET STANDARDS

Model Year(s)	c	d
<b>CI Vehicle Coefficients</b>		
2013 and 14 .....	0.0004695	3.615
2015 .....	0.0004656	3.595
<b>SI Vehicle Coefficients</b>		
2013 and 14 .....	0.0005424	4.175
2015 .....	0.0005390	4.152

(iv) Calculate the fleet average fuel consumption standards for model years 2013 through 2015 using the equation in paragraph (a)(3) of this section.

(5) *Exclusion of vehicles not certified as complete vehicles.* The vehicle standards in paragraph (a) of this section do not apply for vehicles that are chassis-certified with respect to

EPA's criteria pollutant test procedure in 40 CFR part 86, subpart S. Any chassis-certified vehicles must comply with the vehicle standards and requirements of paragraph (b) of this section and the engine standards of paragraph (d) of this section for engines used in these vehicles. A vehicle manufacturer choosing to comply with

this paragraph and that is not the engine manufacturer is required to notify the engine manufacturers that their engines are subject to paragraph (d) of this section and that it intends to use their engines in excluded vehicles.

(6) *Optional certification under this section.* Manufacturers may certify certain complete or cab-complete

vehicles to the fuel consumption standards of this section. All vehicles optionally certified under this paragraph (6) are deemed to be subject to the fuel consumption standards of this section given the following conditions:

(i) For fuel consumption compliance, manufacturers may certify any complete or cab-complete spark-ignition vehicles above 14,000 pounds GVWR and at or below 26,000 pounds GVWR to the fuel consumption standards of this section.

(ii) Manufacturers may apply the provisions of this section to cab-complete vehicles based on a complete sister vehicle. In unusual circumstances, manufacturers may ask the agencies to apply these provisions to Class 2b or Class 3 incomplete vehicles that do not meet the definition of cab-complete.

(A) Except as specified in paragraph (a)(6)(iii) of this section, for purposes of this section, a complete sister vehicle is a complete vehicle of the same vehicle configuration as the cab-complete vehicle. A manufacturer may not apply the provisions of this paragraph (6) to any vehicle configuration that has a four-wheel rear axle if the complete sister vehicle has a two-wheel rear axle.

(B) Calculate the target value for the fleet-average fuel consumption standard under paragraph (a)(3) of this section based on the work factor value that applies for the complete sister vehicle.

(C) Test these cab-complete vehicles using the same equivalent test weight and other dynamometer settings that apply for the complete vehicle from which you used the work factor value (the complete sister vehicle). For fuel consumption certification, manufacturers may submit the test data from that complete sister vehicle instead of performing the test on the cab-complete vehicle.

(D) Manufacturers are not required to produce the complete sister vehicle for sale to use the provisions of this paragraph (a)(6)(ii). This means the complete sister vehicle may be a carryover vehicle from a prior model year or a vehicle created solely for the purpose of testing.

(iii) For fuel consumption purposes, if a cab-complete vehicle is not of the same vehicle configuration as a complete sister vehicle due only to certain factors unrelated to coastdown performance, manufacturers may use the road-load coefficients from the complete sister vehicle for certification testing of the cab-complete vehicle, but it may not use fuel consumption data from the complete sister vehicle for certifying the cab-complete vehicle.

(7) *Loose engines.* For model year 2023 and earlier spark-ignition engines

with identical hardware compared with engines used in vehicles certified to the standards of this section, where such engines are sold as loose engines or as engines installed in incomplete vehicles that are not cab-complete vehicles.

Manufacturers may certify such engines to the standards of this section, subject to the following provisions:

(i) For 2020 and earlier model years, the maximum allowable U.S.-directed production volume of engines manufacturers may sell under this paragraph (7) in any given model year is ten percent of the total U.S.-directed production volume of engines of that design that the manufacturer produces for heavy-duty applications for that model year, including engines it produces for complete vehicles, cab-complete vehicles, and other incomplete vehicles. The total number of engines a manufacturer may certify under this paragraph (7), of all engine designs, may not exceed 15,000 in any model year. Engines produced in excess of either of these limits are not covered by your certificate. For example, a manufacturer produces 80,000 complete model year 2017 Class 2b pickup trucks with a certain engine and 10,000 incomplete model year 2017 Class 3 vehicles with that same engine, and the manufacturer did not apply the provisions of this paragraph (a)(7) to any other engine designs, it may produce up to 10,000 engines of that design for sale as loose engines under this paragraph (a)(7). If a manufacturer produced 11,000 engines of that design for sale as loose engines, the last 1,000 of them that it produced in that model year 2017 would be considered uncertified.

(ii) For model years 2021 through 2023, the U.S.-directed production volume of engines manufacturers sell under this paragraph (a)(7) in any given model year may not exceed 10,000 units. This paragraph (a)(7) does not apply for engines certified to the standards of paragraph (d) of this section and 40 CFR 1036.108.

(iii) Vehicles using engines certified under this paragraph (a)(7) are subject to the fuel consumption and emission standards of paragraph (b) of this section and 40 CFR 1037.105 and engine standards in 40 CFR 1036.150(j).

(iv) For certification purposes, engines are deemed to have a fuel consumption target values and test result equal to the fuel consumption target value and test result for the complete vehicle in the applicable test group with the highest equivalent test weight, except as specified in paragraph (a)(7)(iv)(B) of this section.

Manufacturers use these values to calculate target values and the fleet-

average fuel consumption rate. Where there are multiple complete vehicles with the same highest equivalent test weight, select the fuel consumption target value and test result as follows:

(A) If one or more of the fuel consumption test results exceed the applicable target value, use the fuel consumption target value and test result of the vehicle that exceeds its target value by the greatest amount.

(B) If none of the fuel consumption test results exceed the applicable target value, select the highest target value and set the test result equal to it. This means that the manufacturer may not generate fuel consumption credits from vehicles certified under this paragraph (a)(7).

(8) *Alternative fuel vehicle conversions.* Alternative fuel vehicle conversions may demonstrate compliance with the standards of this part or other alternative compliance approaches allowed by EPA in 40 CFR 85.525.

(9) *Advanced, innovative and off-cycle technologies.* For vehicles subject to Phase 1 standards, manufacturers may generate separate credit allowances for advanced and innovative technologies as specified in § 535.7(f)(1) and (2). For vehicles subject to Phase 2 standards, manufacturers may generate separate credits allowance for off-cycle technologies in accordance with § 535.7(f)(2). Separate credit allowances for advanced technology vehicles cannot be generated; instead manufacturers may use the credit multipliers specified in § 535.7(f)(1)(iv) through model year 2026.

(10) *Useful life.* The following useful life values apply for the standards of this section:

(i) 120,000 miles or 10 years, whichever comes first, for Class 2b through Class 3 heavy-duty pickup trucks and vans certified to Phase 1 standards.

(ii) 150,000 miles or 15 years, whichever comes first, for Class 2b through Class 3 heavy-duty pickup trucks and vans certified to Phase 2 standards.

(iii) For Phase 1 credits that you calculate based on a useful life of 120,000 miles, multiply any banked credits that you carry forward for use into the Phase 2 program by 1.25. For Phase 1 credit deficits that you generate based on a useful life of 120,000 miles multiply the credit deficit by 1.25 if offsetting the shortfall with Phase 2 credits.

(11) *Compliance with standards.* A manufacturer complies with the standards of this part as described in § 535.10.

(b) *Heavy-duty vocational vehicles.* Each manufacturer building complete or incomplete heavy-duty vocational vehicles shall comply with the fuel consumption standards in this paragraph (b) expressed in gallons per 1000 ton-miles. Engines used in heavy-duty vocational vehicles shall comply with the standards in paragraph (d) of this section. Each vehicle must be manufactured to comply for its full useful life. Standards apply to the vehicle subfamilies based upon the vehicle service classes within each of the vocational vehicle regulatory subcategories in accordance with § 535.4 and based upon the applicable modeling and testing specified in § 535.6. Determine the duty cycles that apply to vocational vehicles according to 40 CFR 1037.140 and 1037.150(z).

(1) *Mandatory standards.* Heavy-duty vocational vehicle subfamilies produced for Phase 1 must comply with the fuel consumption standards in paragraph (b)(3) of this section. For Phase 2, each vehicle manufacturer of heavy-duty vocational vehicle subfamilies must comply with the fuel consumption standards in paragraph (b)(4) of this section.

(i) For model years 2016 to 2020, the heavy-duty vocational vehicle category is subdivided by GVWR into three regulatory subcategories as defined in

§ 535.4, each with its own assigned standard.

(ii) For model years 2021 and later, the heavy-duty vocational vehicle category is subdivided into 15 regulatory subcategories depending upon whether vehicles are equipped with a compression or spark-ignition engine, as defined in § 535.4. Standards also differ based upon vehicle service class and intended vehicle duty cycles. See 40 CFR 1037.140 and 1037.150(z).

(iii) For purposes of certifying vehicles to fuel consumption standards, manufacturers must divide their product lines in each regulatory subcategory into vehicle families that have similar emissions and fuel consumption features, as specified by EPA in 40 CFR 1037.230. These families will be subject to the applicable standards. Each vehicle family is limited to a single model year.

(A) Vocational vehicles including custom chassis vehicles must use qualified automatic tire inflation systems or tire pressure monitoring systems for wheels on all axles.

(B) Tire pressure monitoring systems must use low pressure warning and malfunction telltales in clear view of the driver as specified in S4.3 and S4.4 of 49 CFR 571.138.

(2) *Voluntary compliance.* (i) For model years 2013 through 2015, a

manufacturer may choose voluntarily to comply early with the fuel consumption standards provided in paragraph (b)(3) of this section. For example, a manufacturer may choose to comply early in order to begin accumulating credits through over-compliance with the applicable standards. A manufacturer choosing early compliance must comply with all the vehicles and engines it manufacturers in each regulatory category for a given model year.

(ii) A manufacturer must declare its intent to voluntarily comply with fuel consumption standards and identify its plans to comply before it submits its first application for a certificate of conformity for the respective model year as specified in § 535.8; and, once selected, the decision cannot be reversed and the manufacturer must continue to comply for each subsequent model year for all the vehicles and engines it manufacturers in each regulatory category for a given model year.

(3) *Regulatory subcategory standards for model years 2013 to 2020.* The mandatory and voluntary fuel consumption standards for heavy-duty vocational vehicles are given in the following table:

TABLE 8—PHASE 1 VOCATIONAL VEHICLE FUEL CONSUMPTION STANDARDS  
[Gallons per 1000 ton-miles]

Regulatory subcategories	Vocational LHD vehicles	Vocational MHD vehicles	Vocational HHD vehicles
<b>Model Years 2013 to 2016 Voluntary Standards</b>			
Standard .....	38.1139	22.9862	22.2004
<b>Model Years 2017 to 2020 Mandatory Standards</b>			
Standard .....	36.6405	22.1022	21.8075

(4) *Regulatory subcategory standards for model years 2021 and later.* The mandatory fuel consumption standards for heavy-duty vocational vehicles are given in the following table:

TABLE 9—PHASE 2 VOCATIONAL VEHICLE FUEL CONSUMPTION STANDARDS  
[Gallons per 1,000 ton-miles]

Duty cycle	LHD Vocational vehicles	MHD Vocational vehicles	Vocational HHD vehicles
<b>Model Years 2021 to 2023 Standards for CI Vehicles</b>			
Urban .....	41.6503	29.0766	30.2554
Multi-Purpose .....	36.6405	26.0314	25.6385
Regional .....	30.5501	22.9862	20.2358
<b>Model Years 2021 to 2023 Standards for SI Vehicles</b>			
Urban .....	51.8735	36.9078	NA

TABLE 9—PHASE 2 VOCATIONAL VEHICLE FUEL CONSUMPTION STANDARDS—Continued  
[Gallons per 1,000 ton-miles]

Duty cycle	LHD Vocational vehicles	MHD Vocational vehicles	Vocational HHD vehicles
Multi-Purpose .....	45.7972	32.9695	NA
Regional .....	37.6955	29.3687	NA
<b>Model Years 2024 to 2026 Standards for CI Vehicles</b>			
Urban .....	37.8193	26.6208	27.7996
Multi-Purpose .....	33.7917	24.1650	23.7721
Regional .....	29.0766	21.7092	19.0570
<b>Model Years 2024 to 2026 Standards for SI Vehicles</b>			
Urban .....	48.6103	34.8824	NA
Multi-Purpose .....	43.3217	31.3942	NA
Regional .....	36.4577	28.2435	NA
<b>Model Years 2027 and later Standards for CI Vehicles</b>			
Urban .....	36.0511	25.3438	26.4244
Multi-Purpose .....	32.4165	23.0845	22.5933
Regional .....	28.5855	21.4145	18.5658
<b>Model Years 2027 and later Standards for SI Vehicles</b>			
Urban .....	46.4724	33.4196	NA
Multi-Purpose .....	41.8589	30.1564	NA
Regional .....	35.8951	27.7934	NA

(5) *Subfamily standards.* Manufacturers may specify a family emission limit (FEL) in terms of fuel consumption for each vehicle subfamily. The FEL may not be less than the result of fuel consumption modeling from 40 CFR 1037.520. The FELs is the fuel consumption standards for the vehicle subfamily instead of the standards specified in paragraph (b)(3) and (4) of this section and can be used for calculating fuel consumption credits in accordance with § 535.7.

(6) *Alternate standards for custom chassis vehicles for model years 2021 and later.* Manufacturers may elect to certify certain vocational vehicles to the alternate standards for custom chassis vehicles specified in this paragraph

(b)(6) instead of the standards specified in paragraph (b)(4) of this section. Note that, although these standards were established for custom chassis vehicles, manufacturers may apply these provisions to any qualifying vehicle even though these standards were established for custom chassis vehicles. For example, large diversified vehicle manufacturers may certify vehicles to the refuse hauler standards of this section as long as the manufacturer ensures that those vehicles qualify as refuse haulers when placed into service. GEM simulates vehicle operation for each type of vehicle based on an assigned vehicle service class, independent of the vehicle's actual characteristics, as shown in Table 10 of

this section; however, standards apply for the vehicle's useful life based on its actual characteristics as specified in paragraph (b)(10) of this section. Vehicles certified to these alternative standards must use engines certified to requirements under paragraph (d) of this section and 40 CFR part 1036 for the appropriate model year, except that motor homes and emergency vehicles may use engines certified with the loose-engine provisions of paragraph (a)(7) of this section and 40 CFR 1037.150(m). This also applies for vehicles meeting standards under paragraphs (b)(6)(iv) through (vi) of this section. The fuel consumption standards for custom chassis vehicles are given in the following table:

TABLE 10—PHASE 2 CUSTOM CHASSIS FUEL CONSUMPTION STANDARDS  
[Gallon per 1,000 ton-mile]

Vehicle type <sup>1</sup>	Assigned vehicle service class	MY 2021	MY 2027
Coach Bus .....	HHD Vehicle .....	20.6287	20.1375
Motor Home .....	MDH Vehicle .....	22.3969	22.2004
School Bus .....	MHD Vehicle .....	28.5855	26.6208
Other bus .....	HHD Vehicle .....	29.4695	28.0943
Refuse hauler .....	HHD Vehicle .....	30.7466	29.2731
Concrete mixer .....	HHD Vehicle .....	31.3360	31.0413
Mixed-use vehicle .....	HHD Vehicle .....	31.3360	31.0413
Emergency Vehicle .....	HHD Vehicle .....	31.8271	31.3360

<sup>1</sup> Vehicle types are generally defined in § 535.3. "Other bus" includes any bus that is not a school bus or a coach bus. A "mixed-use vehicle" is one that meets at least one of the criteria specified in 40 CFR 1037.631(a)(1) or at least one of the criteria in 40 CFR 1037.631(a)(2), but not both.



(j) Manufacturers may generate or use fuel consumption credits for averaging to demonstrate compliance with the alternative standards as described in § 535.7(c). This requires that manufacturers specify a Family Emission Limit (FEL) for fuel consumption for each vehicle subfamily. The FEL may not be less than the result of emission modeling as described in this paragraph (b). These FELs serve as the fuel consumption standards for the vehicle subfamily instead of the standards specified in this paragraph (b)(6). Manufacturers may only use fuel consumption credits for vehicles certified to the optional standards in this paragraph (b)(6) as specified in § 535.7(c)(6) through (8) and you may not bank or trade fuel consumption credits from any vehicles certified under this paragraph (b)(6).

(ii) For purposes of this paragraph (b)(6), each separate vehicle type identified in Table 10 of this section is in a separate averaging set.

(iii) For purposes of emission and fuel consumption modeling under 40 CFR 1037.520, consider motor homes and coach buses to be subject to the Regional duty cycle, and consider all other vehicles to be subject to the Urban duty cycle.

(iv) Emergency vehicles are deemed to comply with the standards of this paragraph (6) if manufacturers use tires with TRRL at or below 8.4 kg/ton (8.7 g/ton for model years 2021 through 2026).

(v) Concrete mixers are deemed to comply with the standards of this paragraph (6) if manufacturers use tires with TRRL at or below 7.1 kg/ton (7.6 g/ton for model years 2021 through 2026).

(vi) Motor homes are deemed to comply with the standards of this paragraph (b)(6) if manufacturers use the following technologies:

(A) Tires with TRRL at or below 6.0 kg/ton (6.7 g/ton for model years 2021 through 2026).

(B) Automatic tire inflation systems or tire pressure monitoring systems with wheels on all axles.

(C) Tire pressure monitoring systems must use low pressure warning and malfunction telltales in clear view of the driver as specified in S4.3 and S4.4 of 49 CFR 571.138.

(vii) Small business manufacturers using the alternative standards for custom chassis vehicles under this paragraph (b)(6) may use fuel consumption credits subject to the unique provisions in § 535.7(a)(9).

(7) *Advanced, innovative and off-cycle technologies.* For vocational vehicles subfamilies subject to Phase 1

standards, manufacturers must create separate vehicle subfamilies for vehicles that contain advanced or innovative technologies and group those vehicles together in a vehicle subfamily if they use the same advanced or innovative technologies. Manufacturers may generate separate credit allowances for advanced and innovative technologies as specified in § 535.7(f)(1) and (2). For vehicles subfamilies subject to Phase 2 standards, manufacturers may generate separate credit allowances for off-cycle technologies in accordance with § 535.7(f)(2). Separate credit allowances for advanced technology vehicles cannot be generated but instead manufacturers may use the credit multipliers specified in § 535.7(f)(1)(iv) through model year 2026.

(8) *Certifying across service classes.* A manufacturer may optionally certify a vocational vehicle subfamilies to the standards and useful life applicable to a heavier vehicle service class (such as MHD vocational vehicles instead of LHD vocational vehicles). Provisions related to generating fuel consumption credits apply as follows:

(i) If a manufacturer certifies all its vehicles from a given vehicle service class in a given model year to the standards and useful life that applies for a heavier vehicle service class, it may generate credits as appropriate for the heavier service class.

(ii) Class 8 hybrid vehicles with light or medium heavy-duty engines may be certified to compression-ignition standards for the Heavy HDV service class. A manufacturer may generate and use credits as allowed for the Heavy HDV service class.

(iii) Except as specified in paragraphs (b)(8)(i) and (ii) of this section, a manufacturer may not generate credits with the vehicle. If you include lighter vehicles in a subfamily of heavier vehicles with an FEL below the standard, exclude the production volume of lighter vehicles from the credit calculation. Conversely, if a manufacturer includes lighter vehicles in a subfamily with an FEL above the standard, it must include the production volume of lighter vehicles in the credit calculation.

(9) *Off-road exemptions.* This section provides an exemption for heavy-duty vocational vehicle subfamilies, including vocational tractors that are intended to be used extensively in off-road environments such as forests, oil fields, and construction sites from the fuel consumption standards in this paragraph (b). Vehicle exempted by this part do not comply with vehicle standards in this paragraph (b), but the engines in these vehicles must meet the

engine requirements of paragraph (d) of this section. Note that manufacturers may not include these exempted vehicles in any credit calculations under this part.

(i) *Qualifying criteria.* Vocational vehicles intended for off-road use are exempt without request, subject to the provisions of this section, if they are primarily designed to perform work off-road (such as in oil fields, mining, forests, or construction sites), and they meet at least one of the criteria of paragraph (b)(9)(i)(A) of this section and at least one of the criteria of paragraph (b)(9)(i)(B) of this section. See paragraph (b)(6) of this section for alternate standards that apply for vehicles meeting only one of these sets of criteria.

(A) The vehicle must have affixed components designed to work inherently in an off-road environment (such as hazardous material equipment or off-road drill equipment) or be designed to operate at low speeds such that it is unsuitable for normal highway operation.

(B) The vehicle must meet one of the following criteria:

(1) Have an axle that has a gross axle weight rating (GAWR) at or above 29,000 pounds.

(2) Have a speed attainable in 2.0 miles of not more than 33 mi/hr.

(3) Have a speed attainable in 2.0 miles of not more than 45 mi/hr, an unloaded vehicle weight that is not less than 95 percent of its gross vehicle weight rating, and no capacity to carry occupants other than the driver and operating crew.

(4) Have a maximum speed at or below 54 mi/hr. A manufacturer may consider the vehicle to be appropriately speed-limited if engine speed at 54 mi/hr is at or above 95 percent of the engine's maximum test speed in the highest available gear. A manufacturer may alternatively limit vehicle speed by programming the engine or vehicle's electronic control module in a way that is tamper-resistant.

(ii) *Tractors.* The provisions of this section may apply for tractors only if each tractor qualifies as a vocational tractor under paragraph (c)(9) of this section or is granted approval for the exemption as specified in paragraph (b)(9)(iii) of this section.

(iii) *Preliminary approval before certification.* If a manufacturer has unusual circumstances where it may be questionable whether its vehicles qualify for the off-road exemption of this part, the manufacturer may send the agencies information before finishing its application for certification (see 40 CFR 1037.205) for the applicable vehicles

and ask for a preliminary informal approval. The agencies will review the request and make an appropriate determination in accordance with 40 CFR 1037.210. The agencies will generally not reverse a decision where they have given a manufacturer preliminary approval, unless the agencies find new information supporting a different decision. However, the agencies will normally not grant relief in cases where the vehicle manufacturer has credits or can otherwise comply with the applicable standards.

(iv) *Recordkeeping and reporting.* (A) A manufacturer must keep records to document that its exempted vehicle configurations meet all applicable requirements of this section. Keep these records for at least eight years after you stop producing the exempted vehicle model. The agencies may review these records at any time.

(B) A manufacturer must also keep records of the individual exempted vehicles you produce, including the vehicle identification number and a description of the vehicle configuration.

(C) Within 90 days after the end of each model year, manufacturers must send to EPA a report as specified in § 535.8(g)(7) and EPA will make the report available to NHTSA.

(v) *Compliance.* (A) Manufacturers producing vehicles meeting the off-road exemption criteria in paragraph (b)(9)(i) of this section or that are granted a preliminary approval comply with the standards of this part.

(B) In situations where a manufacturer would normally ask for a preliminary approval subject to paragraph (b)(9)(iii) of this section but introduces its vehicle into U.S. commerce without seeking approval first from the agencies, those vehicles violate compliance with the fuel consumption standards of this part and the EPA provisions under 40 CFR 1068.101(a)(1).

(C) If at any time, the agencies find new information that contradicts a manufacturer's use of the off-road exemption of this part, the manufacturer's vehicles will be determined to be non-compliant with the regulations of this part and the manufacturer may be liable for civil penalties.

(10) *Useful life.* The following useful life values apply for the standards of this section:

(i) 110,000 miles or 10 years, whichever comes first, for vocational LHD vehicles certified to Phase 1 standards.

(ii) 150,000 miles or 15 years, whichever comes first, for vocational LHD vehicles certified to Phase 2 standards.

(iii) 185,000 miles or 10 years, whichever comes first, for vocational MHD vehicles for Phase 1 and 2.

(iv) 435,000 miles or 10 years, whichever comes first, for vocational HHD vehicles for Phase 1 and 2.

(v) For Phase 1 credits calculated based on a useful life of 110,000 miles, multiply any banked credits carried forward for use into the Phase 2 program by 1.36. For Phase 1 credit deficits generated based on a useful life of 110,000 miles multiply the credit deficit by 1.36, if offsetting the shortfall with Phase 2 credits.

(11) *Recreational vehicles.* Recreational vehicles manufactured after model year 2020 must comply with the fuel consumption standards of this section. Manufacturers producing these vehicles may also certify to fuel consumption standards from 2014 through model year 2020.

Manufacturers may earn credits retroactively for early compliance with fuel consumption standards. Once selected, a manufacturer cannot reverse the decision and the manufacturer must continue to comply for each subsequent model year for all the vehicles it manufactures in each regulatory subcategory for a given model year.

(12) *Loose engines.* Manufacturers may certify certain spark-ignition engines along with chassis-certified heavy-duty vehicles where there are identical engines used in those vehicles as described in 40 CFR 86.1819(k)(8) and 40 CFR 1037.150(m). Vehicles in which those engines are installed are subject to standards under this part.

(13) *Compliance with Standards.* A manufacturer complies with the standards of this part as described in § 535.10.

(c) *Truck tractors.* Each manufacturer building truck tractors, except vocational tractors or vehicle constructed in accordance with § 571.7(e), with a GVWR above 26,000 pounds shall comply with the fuel consumption standards in this paragraph (c) expressed in gallons per 1000 ton-miles. Engines used in heavy-duty truck tractors vehicles shall comply with the standards in paragraph (d) of this section. Each vehicle must be manufactured to comply for its full useful life. Standards apply to the vehicle subfamilies within each of the tractor vehicle regulatory subcategories in accordance with § 535.4 and 40 CFR 1037.230 and based upon the applicable

modeling and testing specified in § 535.6. Determine the vehicles in each regulatory subcategory in accordance with 40 CFR 1037.140.

(1) *Mandatory standards.* For model years 2016 and later, each manufacturer's truck tractor subfamilies must comply with the fuel consumption standards in paragraph (c)(3) of this section.

(i) Based on the roof height and the design of the cab, the truck tractor category is divided into subcategories as described in § 535.4. The standards that apply to each regulatory subcategory are shown in paragraphs (c)(2) and (3) of this section, each with its own assigned standard.

(ii) For purposes of certifying vehicles to fuel consumption standards, manufacturers must divide their product lines in each regulatory subcategory into vehicles subfamilies that have similar emissions and fuel consumption features, as specified by EPA in 40 CFR 1037.230, and these subfamilies will be subject to the applicable standards. Each vehicle subfamily is limited to a single model year.

(iii) Standards for truck tractor engines are given in paragraph (d) of this section.

(2) *Voluntary compliance.* (i) For model years 2013 through 2015, a manufacturer may choose voluntarily to comply early with the fuel consumption standards provided in paragraph (c)(3) of this section. For example, a manufacturer may choose to comply early in order to begin accumulating credits through over-compliance with the applicable standards. A manufacturer choosing early compliance must comply with all the vehicles and engines it manufactures in each regulatory category for a given model year.

(ii) A manufacturer must declare its intent to voluntarily comply with fuel consumption standards and identify its plans to comply before it submits its first application for a certificate of conformity for the respective model year as specified in § 535.8; and, once selected, the decision cannot be reversed and the manufacturer must continue to comply for each subsequent model year for all the vehicles and engines it manufactures in each regulatory category for a given model year.

(3) *Regulatory subcategory standards.* The fuel consumption standards for truck tractors, except for vocational tractors, are given in the following table:

TABLE 11—TRUCK TRACTOR FUEL CONSUMPTION STANDARDS  
[Gallons per 1,000 ton-miles]

Regulatory subcategories	Day cab		Sleeper cab	Heavy-Haul
	Class 7	Class 8	Class 8	
<b>Phase 1—Model Years 2013 to 2015 Voluntary Standards</b>				
Low Roof .....	10.5108	7.9568	6.6798	
Mid Roof .....	11.6896	8.6444	7.4656	
High Roof .....	12.1807	9.0373	7.3674	
<b>Phase 1—Model Year 2016 Mandatory Standard</b>				
Low Roof .....	10.5108	7.9568	6.6798	NA
Mid Roof .....	11.6896	8.6444	7.4656	
High Roof .....	12.1807	9.0373	7.3674	
<b>Phase 1—Model Years 2017 to 2020 Mandatory Standards</b>				
Low Roof .....	10.2161	7.8585	6.4833	NA
Mid Roof .....	11.2967	8.4479	7.1709	
High Roof .....	11.7878	8.7426	7.0727	
<b>Phase 2—Model Years 2021 to 2023 Mandatory Standards</b>				
Low Roof .....	10.36346	7.90766	7.10216	5.14735
Mid Roof .....	11.11984	8.38900	7.66208	
High Roof .....	11.14931	8.40864	7.43615	
<b>Phase 2—Model Years 2024 to 2026 Mandatory Standards</b>				
Low Roof .....	9.80354	7.48527	6.67976	4.93124
Mid Roof .....	10.52063	7.94695	7.22004	
High Roof .....	10.47151	7.89784	6.94499	
<b>Phase 2—Model Years 2027 and later Mandatory Standards</b>				
Low Roof .....	9.44990	7.21022	6.29666	4.74460
Mid Roof .....	10.15717	7.66208	6.83694	
High Roof .....	9.82318	7.43615	6.31631	

(4) *Subfamily standards.* Manufacturers may generate or use fuel consumption credits for averaging, banking, and trading as described in § 535.7(c). This requires that manufacturers calculate a credit quantity if they specify a Family Emission Limit (FEL) that is different

than the standard specified in this section. The FEL may not be less than the result of emission and fuel consumption modeling from 40 CFR 1037.520. These FELs serve as the emission standards for the specific vehicle subfamily instead of the

standards specified in paragraph (2) of this section.

(5) *Alternate standards for tractors at or above 120,000 pounds GCWR.* Manufacturers may certify tractors at or above 120,000 pounds GCWR to the following fuel consumption standards in the following table:

TABLE 12—ALTERNATE FUEL CONSUMPTION STANDARDS FOR TRACTORS ABOVE 120,000 POUNDS GCWR FOR 2021 MY AND LATER FUEL CONSUMPTION  
[Gallons per 1,000 ton-miles]

Low roof day cab	Mid roof day cab	High roof day cab	Low roof sleeper cab	Mid roof sleeper cab	High roof sleeper cab
3.59528	3.82122	3.84086	3.26130	3.52652	3.43811

(6) *Advanced, innovative and off-cycle technologies.* For tractors subject to Phase 1 standards, manufacturers must create separate vehicle subfamilies for vehicles that contain advanced or innovative technologies and group those vehicles together in a vehicle subfamilies if they use the same advanced or innovative technologies.

Manufacturers may generate separate credit allowances for advanced and innovative technologies as specified in § 535.7(f)(1) and (2). For vehicles subject to Phase 2 standards, manufacturers may generate separate credits allowance for off-cycle technologies in accordance with § 535.7(f)(2). Separate credit allowances for advanced technology

vehicles cannot be generated but instead manufacturers may use the credit multipliers specified in § 535.7(f)(1)(iv) through model year 2026.

(7) *Certifying across service classes.* Manufacturers may certify Class 7 tractors to Class 8 tractors standards as follows:

(i) A manufacturer may optionally certify 4x2 tractors with heavy-duty engines to the standards and useful life for Class 8 tractors, with no restriction on generating or using fuel consumption credits within the Class 8 averaging set.

(ii) A manufacturer may optionally certify a Class 7 tractor to the standards and useful life applicable to Class 8 tractors. Credit provisions apply as follows:

(A) If a manufacturer certifies all of its Class 7 tractors to Class 8 standards, it may use these Heavy HDV credits without restriction.

(B) This paragraph (c)(7)(ii)(B) applies if a manufacturer certifies some Class 7 tractors to Class 8 standards under this paragraph (c)(7)(ii) but not all of them. If a manufacturer includes Class 7 tractors in a subfamily of Class 8 tractors with an FEL below the standard, exclude the production volume of Class 7 tractors from the credit calculation. Conversely, if a manufacturer includes Class 7 tractors in a subfamily of Class 8 tractors with an FEL above the standard, it must include the production volume of Class 7 tractors in the credit calculation.

(8) *Expanded families.* Manufacturers may combine dissimilar vehicles into a single vehicle subfamilies for applying standards and for testing in special circumstances as follows:

(i) For a Phase 1 vehicle model that straddles a roof-height, cab type, or GVWR division, manufacturers can include all the vehicles in the same vehicle family if it certifies the vehicle family to the more stringent standard. For roof height, the manufacturer must certify to the taller roof standard. For cab-type and GVWR, the manufacturers must certify to the numerically lower standard.

(ii) For a Phase 2 vehicle model that includes a range of GVWR values that straddle weight classes, manufacturers may include all the vehicles in the same vehicle family if it certifies the vehicle family to the numerically lower fuel consumption standard from the affected service classes. Vehicles that are optionally certified to a more stringent standard under this paragraph are subject to useful-life and all other provisions corresponding to the weight class with the numerically lower fuel consumption standard. For a Phase 2 tractor model that includes a range of roof heights that straddle subcategories, a manufacturer may include all the vehicles in the same vehicle family if it certifies the vehicle family to the appropriate subcategory as follows:

(A) A manufacturer may certify mid-roof tractors as high-roof tractors, but it

may not certify high-roof tractors as mid-roof tractors.

(B) For tractor families straddling the low-roof/mid-roof division, a manufacturer may certify the family based on the primary roof-height as long as no more than 10 percent of the tractors are certified to the otherwise inapplicable subcategory. For example, if 95 percent of the tractors in the family are less than 120 inches tall, and the other 5 percent are 122 inches tall, a manufacturer may certify the tractors as a single family in the low-roof subcategory.

(C) Determine the appropriate aerodynamic bin number based on the actual roof height if the  $C_dA$  value is measured. However, use the GEM input for the bin based on the standards to which the manufacturer certifies. For example, if a manufacturer certifies as mid roof tractors some low-roof tractors with a measured  $C_dA$  value of 4.2 m<sup>2</sup>, it qualifies as Bin IV; and must input into GEM the mid-roof Bin IV value of 5.85 m<sup>2</sup>.

(9) *Vocational tractors.* Tractors meeting the definition of vocational tractors in 49 CFR 523.2 must comply with requirements for heavy-duty vocational vehicles specified in paragraphs (b) and (d) of this section. For Phase 1, Class 7 and Class 8 tractors certified or exempted as vocational tractors are limited in production to no more than 21,000 vehicles in any three consecutive model years. If a manufacturer is determined as not applying this allowance in good faith by EPA in its applications for certification in accordance with 40 CFR 1037.205 and 1037.610, a manufacturer must comply with the tractor fuel consumption standards in paragraph (c)(3) of this section. No production limit applies for vocational tractors subject to Phase 2 standards.

(10) *Small business manufacturers converting to mid roof or high roof configurations.* Small manufacturers are to allowed convert low and mid roof tractors to high roof configurations without recertification, provided it is for the purpose of building a custom sleeper tractor or conversion to a natural gas tractor as specified in 40 CFR 1037.150(r).

(11) *Useful life.* The following useful life values apply for the standards of this section:

(i) 185,000 miles or 10 years, whichever comes first, for vehicles at or below 33,000 pounds GVWR.

(ii) 435,000 miles or 10 years, whichever comes first, for vehicles above 33,000 pounds GVWR.

(12) *Conversion to high-roof configurations.* Secondary vehicle

manufacturers that qualify as small manufacturers may convert low- and mid-roof tractors to high-roof configurations without recertification for the purpose of building a custom sleeper tractor or converting it to run on natural gas, as follows:

(i) The original low- or mid-roof tractor must be covered by a valid certificate of conformity by EPA.

(ii) The modifications may not increase the frontal area of the tractor beyond the frontal area of the equivalent high-roof tractor with the corresponding standard trailer. If a manufacturer cannot use the original manufacturer's roof fairing for the high-roof tractor, use good engineering judgment to achieve similar or better aerodynamic performance.

(iii) The agencies may require that these manufacturers submit annual production reports as described in § 535.8 and 40 CFR 1037.250 indicating the original roof height for requalified vehicles.

(13) *Compliance with standards.* A manufacturer complies with the standards of this part as described in § 535.10.

(d) *Heavy-duty engines.* Each manufacturer of heavy-duty engines shall comply with the fuel consumption standards in this paragraph (d) of this section expressed in gallons per 100 horsepower-hour. Each engine must be manufactured to comply for its full useful life, expressed in service miles, operating hours, or calendar years, whatever comes first. The provisions of this part apply to all new 2014 model year and later heavy-duty engines fueled by conventional and alternative fuels and manufactured for use in heavy-duty tractors or vocational vehicles. Standards apply to the engine families based upon the primary intended service classes within each of the engine regulatory subcategories as described in § 535.4 and based upon the applicable modeling and testing specified in § 535.6.

(1) *Mandatory standards.* Manufacturers of heavy-duty engine families shall comply with the mandatory fuel consumption standards in paragraphs (d)(3) through (6) of this section for model years 2017 and later for compression-ignition engines and for model years 2016 and later for spark-ignition engines.

(i) The heavy-duty engine regulatory category is divided into six regulatory subcategories, five compression-ignition subcategories and one spark-ignition subcategory, as shown in Table 14 of this section.

(ii) Separate standards exist for engine families manufactured for use in heavy-

duty vocational vehicles and in truck tractors.

(iii) For purposes of certifying engines to fuel consumption standards, manufacturers must divide their product lines in each regulatory subcategory into engine families. Fuel consumption standards apply each model year to the same engine families used to comply with EPA standards in 40 CFR 1036.108 and 40 CFR 1037.230. An engine family is designated under the EPA program based upon testing specified in 40 CFR part 1036, subpart F, and the engine family's primary intended service class. Each engine family manufactured for use in a heavy-duty tractor or vocational vehicle must be certified to the primary intended service class that it is designed for in

accordance with 40 CFR 1036.108 and 1036.140.

(2) *Voluntary compliance.* (i) For model years 2013 through 2016 for compression-ignition engine families, and for model year 2015 for spark-ignition engine families, a manufacturer may choose voluntarily to comply with the fuel consumption standards provided in paragraphs (d)(3) through (5) of this section. For example, a manufacturer may choose to comply early in order to begin accumulating credits through over-compliance with the applicable standards. A manufacturer choosing early compliance must comply with all the vehicles and engines it manufactures in each regulatory category for a given model year except in model year 2013 the manufacturer may comply with

individual engine families as specified in 40 CFR 1036.150(a)(2).

(ii) A manufacturer must declare its intent to voluntarily comply with fuel consumption standards and identify its plans to comply before it submits its first application for a certificate of conformity for the respective model year as specified in § 535.8; and, once selected, the decision cannot be reversed and the manufacturer must continue to comply for each subsequent model year for all the vehicles and engines it manufactures in each regulatory category for a given model year.

(3) *Regulatory subcategory standards.* The primary fuel consumption standards for heavy-duty engine families are given in the following table:

TABLE 13—PRIMARY HEAVY-DUTY ENGINE FUEL CONSUMPTION STANDARDS  
[Gallons per 100 hp-hr]

Regulatory subcategory	CI LHD engines and all other engines	CI MHD engines and all other engines		HHD CI engines and all other engines		SI engines
		Vocational	Vocational	Tractor	Vocational	Tractor
<b>Phase 1—Voluntary Standards</b>						
2015 .....	.....	.....	.....	.....	.....	7.0552
2013 to 2016 .....	5.8939	5.8939	4.9312	5.5697	4.666	
<b>Phase 1—Mandatory Standards</b>						
2016 .....	.....	.....	.....	.....	.....	7.0552
2017 to 2020 .....	5.6582	5.6582	4.6660	5.4519	4.4401	7.0552
<b>Phase 2—Mandatory Standards</b>						
2021 to 2023 .....	5.5305	5.3536	4.6464	5.0393	4.3910	7.0552
2024 to 2026 .....	5.4519	5.2849	4.5285	4.9705	4.2829	7.0552
2027 and later .....	5.4224	5.2554	4.4892	4.9411	4.2436	7.0552

(4) *Alternate subcategory standards.* The alternative fuel consumption standards for heavy-duty compression-ignition engine families are as follows:

(i) Manufacturers entering the voluntary program in model years 2014 through 2016, may choose to certify compression-ignition engine families unable to meet standards provided in paragraph (d)(3) of this section to the alternative fuel consumption standards of this paragraph (d)(4).

(ii) Manufacturers may not certify engines to these alternate standards if they are part of an averaging set in which they carry a balance of banked credits. For purposes of this section,

manufacturers are deemed to carry credits in an averaging set if they carry credits from advance technology that are allowed to be used in that averaging set in accordance with § 535.7(d)(12).

(iii) The emission standards of this section are determined as specified by EPA in 40 CFR 1036.620(a) through (c) and should be converted to equivalent fuel consumption values.

(5) *Alternate phase-in standards.* Manufacturers have the option to comply with EPA emissions standards for compression-ignition engine families using an alternative phase-in schedule that correlates with EPA's OBD standards. If a manufacturer chooses to

use the alternative phase-in schedule for meeting EPA standards and optionally chooses to comply early with the NHTSA fuel consumption program, it must use the same phase-in schedule beginning in model year 2013 for fuel consumption standards and must remain in the program for each model year thereafter until model year 2020. The fuel consumption standard for each model year of the alternative phase-in schedule is provided in Table 15 of this section. Note that engine families certified to these standards are not eligible for early credits under § 535.7.

TABLE 14—PHASE 1 ALTERNATIVE PHASE-IN CI ENGINE FUEL CONSUMPTION STANDARDS

[Gallons per 100 hp-hr]

Tractors	LHD engines	MHD engines	HHD engines
Model Years 2013 to 2015 .....	NA	5.0295	4.7642
Model Years 2016 to 2020 † .....	NA	4.7839	4.5187
Vocational	LHD engines	MHD engines	HHD engines
Model Years 2013 to 2015 .....	6.0707	6.0707	5.6680
Model Years 2016 to 2020 † .....	5.6582	5.6582	5.4519

† **Note:** These alternate standards for 2016 and later are the same as the otherwise applicable standards for 2017 through 2020.

(6) *Alternative fuel conversions.* Engines that have been converted to operate on alternative fuels may demonstrate compliance with the standards of this part or other alternative compliance approaches allowed by EPA in 40 CFR 85.525.

(7) *Optional certification under this section.* Manufacturers certifying spark-ignition engines to the compression-ignition standards for EPA must treat those engines as compression-ignition engines for all the provisions of this part.

(8) *Advanced, innovative and off-cycle technologies.* For engines subject to Phase 1 standards, manufacturers must create separate engine families for engines that contain advanced or innovative technologies and group those engines together in an engine family if they use the same advanced or innovative technologies. Manufacturers may generate separate credit allowances for advanced and innovative technologies as specified in § 535.7(f)(1) and (2). For engines subject to Phase 2 standards, manufacturers may generate separate credits allowance for off-cycle technologies in accordance with § 535.7(f)(2). Credit incentives for advanced technology engines do not apply during the Phase 2 period.

(9) *Useful life.* The exhaust emission standards of this section apply for the full useful life, expressed in service miles, operating hours, or calendar years, whichever comes first. The following useful life values apply for the standards of this section:

(i) 120,000 miles or 11 years, whichever comes first, for CI and SI LHD engines certified to Phase 1 standards.

(ii) 150,000 miles or 15 years, whichever comes first, for CI and SI LHD and spark-ignition engines certified to Phase 2 standards.

(iii) 185,000 miles or 10 years, whichever comes first, for CI MHD engines certified to Phase 1 and for Phase 2.

(iv) 435,000 miles or 10 years, whichever comes first, for CI HHD

engines certified to Phase 1 and for Phase 2.

(v) For Phase 1 credits that manufacturers calculate based on a useful life of 110,000 miles, multiply any banked credits that it carries forward for use into the Phase 2 program by 1.36. For Phase 1 credit deficits that manufacturers generate based on a useful life of 110,000 miles multiply the credit deficit by 1.36, if offsetting the shortfall with Phase 2 credits.

(10) *Loose engines.* This paragraph (10) describes alternate emission and fuel consumption standards for loose engines certified under. The standards of this paragraph (d) and 1036.108 do not apply for loose engines certified under paragraph (a) of this section and 40 CFR 86.1819–14(k)(8). The standards in 40 CFR 1036.150(j) apply for the emissions and equivalent fuel consumption measured with the engine installed in a complete vehicle consistent with the provisions of 40 CFR 86.1819–14(k)(8)(vi).

(11) *Alternate transition option for Phase 2 engine standards.* (i) Manufacturers may optionally elect to comply with the model year 2021 primary (Phase 2) vocational vehicle and tractor engine standards in paragraph (d)(3) of this section beginning in model year 2020 (e.g. comply with the more stringent standards one year early). The model year 2021 standard would apply to these manufacturers for model years 2020 through 2023. Manufacturers that voluntarily certify their engines to model year 2021 standards early would then be eligible for less stringent engine tractor standards in model years 2024 through 2026, as follows:

(A) 5.2849 gallons per 100 hp-hr for MHD vocational vehicle engines.

(B) 4.5874 gallons per 100 hp-hr for MHD tractor engines.

(C) 4.9705 gallons per 100 hp-hr for HHD vocational vehicle engines.

(D) 4.3418 gallons per 100 hp-hr for HHD tractor engines.

(ii) The primary standard in paragraph (d)(3) applies for all manufacturers in model year 2027 and later years.

(iii) Manufacturers may apply these provisions separately for medium heavy-duty engines and heavy heavy-duty engines. This election applies to all engines in each segment. For example, if a manufacturer elects this alternate option for its medium heavy-duty engines, all of the manufacturer's medium heavy-duty vocational and tractor engines must comply. Engine fuel consumption credits generated under § 535.7(d) for manufacturers complying early with the model year 2021 standards follow the temporary extended credit life allowance in § 535.7(d)(9).

(12) *Compliance with Standards.* A manufacturer complies with the standards of this part as described in § 535.10.

(e) *Heavy-duty Trailers.* Each manufacturer of heavy-duty trailers as specified in 49 CFR 523.10, except trailers constructed in accordance with 49 CFR 571.7(f), shall comply with the fuel consumption standards in paragraph (e)(1) of this section expressed in gallons per 1000 ton-miles. Each vehicle must be manufactured to comply for its full useful life. There are no Phase 1 standards for trailers. Different levels of stringency apply for box vans depending on features that may affect aerodynamic performance. Standards apply to the trailer vehicle families within each of the trailer regulatory subcategories in accordance with § 535.4 and 40 CFR 1037.230 and based upon the applicable modeling and testing specified in § 535.6.

(1) *Fuel consumption standards for Box-Vans.* Box van trailer families manufactured in model year 2021 and later must comply with the fuel consumption standards of this section. For model years 2018 through 2020, box van trailer manufacturers have the option to voluntarily comply with the fuel consumption standards of this section. Different levels of stringency

apply for box vans depending on features that may affect aerodynamic performance. A manufacturer may optionally meet less stringent standards for different trailer types, which are characterized as follows:

(i) For trailers 35 feet or longer, a manufacturer may designate as “non-aero box vans” those box vans that have a rear lift gate or rear hinged ramp, and at least one of the following side features: Side lift gate, side-mounted pull-out platform, steps for side-door access, a drop-deck design, or belly

boxes that occupy at least half the length of both sides of the trailer between the centerline of the landing gear and the leading edge of the front wheels. For trailers less than 35 feet long, manufacturers may designate as “non-aero box vans” any refrigerated box vans with at least one of the side features identified for longer trailers.

(ii) A manufacturer may designate as “partial-aero box vans” those box vans that have at least one of the side features identified in paragraph (a)(1)(i) of this section. Long box vans may also qualify

as partial-aero box vans if they have a rear lift gate or rear hinged ramp. Note that this paragraph (e)(1)(ii) does not apply for box vans designated as “non-aero box vans” under paragraph (e)(1)(i) of this section.

(iii) “Full-aero box vans” are box vans that are not designated as non-aero box vans or partial-aero box vans under this paragraph (e)(1).

(iv) Fuel consumption standards apply for full-aero box vans as specified in the following table:

TABLE 15—PHASE 2 FULL AERO BOX VAN FUEL CONSUMPTION STANDARDS

[Gallons per 1,000 ton-miles]

Model years	Dry van		Refrigerated van	
	Long	Short	Long	Short
<b>Voluntary Standards</b>				
2018 to 2020 .....	7.98625	12.31827	8.15324	12.68173
<b>Mandatory Standards</b>				
2021 to 2023 .....	7.75049	12.15128	7.91749	12.52456
2024 to 2026 .....	7.58350	11.87623	7.75049	12.24951
2027 and later .....	7.43615	11.72888	7.60314	12.10216

(v) Fuel consumption standards apply for partial-aero box vans as specified in the following table:

TABLE 16—PHASE 2 FUEL CONSUMPTION STANDARDS FOR PARTIAL-AERO BOX VANS

[Gallons per 1,000 ton-mile]

Model year	Dry van		Refrigerated van	
	Short	Long	Short	Long
2018–2020 .....	12.31827	7.98625	12.68173	8.15324
2021 and later .....	12.15128	7.91749	12.52456	8.08448

(2) *Fuel consumption standards for Non-aero Box Vans and Non-box Trailers.* (i) Non-aero box van and non-box trailer families manufactured in model year 2021 and later must comply with the fuel consumption standards of this section. For model years 2018 through 2020, trailer manufacturers have the option to voluntarily comply with the fuel consumption standards of this section.

(ii) Non-aero box vans and non-box vans must meet the following standards:

(A) Trailers must use automatic tire inflation systems or tire pressure monitoring systems with wheels on all axles. Tire pressure monitoring systems must use low pressure warning and malfunction telltales in clear view of the driver as specified in S4.3 and S4.4 of 49 CFR 571.138.

(B) Non-box trailers must use tires with a TRRL at or below 5.1 kg/tonne. Through model year 2020, non-box trailers may instead use tires with a TRRL at or below 6.0 kg/tonne.

(C) Non-aero box vans must use tires with a TRRL at or below 4.7 kg/tonne. Through model year 2020, non-aero box vans may instead use tires with a TRRL at or below 5.1 kg/tonne.

(3) *Subfamily standards.* Starting in model year 2027, manufacturers may generate or use fuel consumption credits for averaging to demonstrate compliance with the standards specified in paragraph (e)(1)(iii) of this section as described in § 535.7(e). This requires that manufacturers specify a Family Emission Limit (FEL) for fuel consumption for each vehicle subfamily. The FEL may not be less than the result of the emission and fuel

consumption calculation in 40 CFR 1037.515. The FEL may not be greater than the appropriate standard for model year 2021 trailers. These FELs serve as the fuel consumption standards for the specific vehicle subfamily instead of the standards specified in paragraph (e)(1) of this section. Manufacturers may not use averaging for non-box trailers, partial-aero box vans, or non-aero box vans that meet standards under paragraph (e)(1)(i) or (e)(1)(ii) of this section, and manufacturers may not use fuel consumption credits for banking or trading for any trailers.

(4) *Useful life.* The fuel consumption standards of this section apply for a useful life equal to 10 years.

(5) *Transitional allowances for trailers.* Through model year 2026, trailer manufacturers may calculate a number of trailers that are exempt from

the standards and certification requirements of this part. Calculate the number of exempt box vans in a given model year by multiplying the manufacturer's total U.S.-directed production volume of certified box vans by 0.20 and rounding to the nearest whole number; however, in no case may the number of exempted box vans be greater than 350 units in any given model year. Repeat this calculation to determine the number of non-box trailers, up to 250 annual units, that are exempt from standards and certification requirements. Perform the calculation based on the manufacturer's projected production volumes in the first year that standards apply; in later years, use actual production volumes from the preceding model year. Manufacturers include these calculated values of the production volumes of exempt trailers in their annual production report under § 535.8 and 40 CFR 1037.250.

(6) *Roll-up doors for non-aero box vans.* Through model year 2023, box vans may qualify for non-aero or partial-aero standards under this paragraph (e) by treating roll-up rear doors as being equivalent to rear lift gates.

(7) *Expanded families.* A manufacturer may include refrigerated box vans in a vehicle family with dry box vans by treating them all as dry box vans for demonstrating compliance with fuel consumption standards. A manufacturer may include certain other types of trailers in a vehicle family with a different type of trailer, such that the combined set of trailers are all subject to the more stringent standards, as follows:

(i) Standards for long trailers are more stringent than standards for short trailers.

(ii) Standards for long dry box vans are more stringent than standards for short refrigerated box vans.

(iii) Standards for non-aero box vans are more stringent than standards for non-box trailers.

(8) *Compliance with standards.* A manufacturer complies with the standards of this part as described in § 535.10.

#### **§ 535.6 Measurement and calculation procedures.**

This part describes the measurement and calculation procedures manufacturers use to determine annual fuel consumption performance results. Manufacturers use the fuel consumption results determined in this part for calculating credit balances specified in

§ 535.7 and then determine whether they comply with standards as specified in § 535.10. Manufacturers must use EPA emissions test results for deriving NHTSA's fuel consumption performance rates. Consequently, manufacturers conducting testing for certification or annual demonstration testing and providing CO<sub>2</sub> emissions data to EPA must also provide equivalent fuel consumption results to NHTSA for all values. NHTSA and EPA reserve the right to verify separately or in coordination the results of any testing and measurement established by manufacturers in complying with the provisions of this program and as specified in 40 CFR 1037.301 and § 535.9. Any carry over data from the Phase 1 program may be carried into the Phase 2 only with approval from EPA and by using good engineering judgment considering differences in testing protocols between test procedures.

(a) *Heavy-duty pickup trucks and vans.* This section describes the method for determining the fuel consumption performance rates for test groups and for fleets of complete heavy-duty pickup trucks and vans each model year. The NHTSA heavy-duty pickup truck and van fuel consumption performance rates correspond to the same requirements for EPA as specified in 40 CFR 86.1819–14.

(1) For the Phase 1 program, if the manufacturer's fleet includes conventional vehicles (gasoline, diesel and alternative fueled vehicles) and advanced technology vehicles (hybrids with powertrain designs that include energy storage systems, vehicles with waste heat recovery, electric vehicles and fuel cell vehicles), it may divide its fleet into two separate fleets each with its own separate fleet average fuel consumption performance rate. For Phase 2, manufacturers may calculate their fleet average fuel consumption rates for a conventional fleet and separate advanced technology vehicle fleets. Advanced technology vehicle fleets should be separated into plug-in hybrid electric vehicles, electric vehicles and fuel cell vehicles.

(2) Vehicles in each fleet should be selected and divided into test groups or subconfigurations according to EPA in 40 CFR 86.1819–14(d).

(3) Use the EPA CO<sub>2</sub> emissions test results for each test group, in grams per mile, for the selected vehicles.

(i) Use CO<sub>2</sub> emissions test results for vehicles fueled by conventional and alternative fuels, including dedicated and dual-fueled (multi-fuel and flexible-

fuel) vehicles using each fuel type as specified in 40 CFR 86.1819–14(d)(10).

(ii) Use CO<sub>2</sub> emissions test results for dual-fueled vehicles using a weighted average of the manufacturer's emission results as specified in 40 CFR 600.510–12(k) for light-duty trucks.

(iii) All electric vehicles are deemed to have zero emissions of CO<sub>2</sub>, CH<sub>4</sub>, and N<sub>2</sub>O. No emission testing is required for such electric vehicles. Assign the fuel consumption test group result to a value of zero gallons per 100 miles in paragraph (a)(4) of this section.

(iv) Use CO<sub>2</sub> emissions test results for cab-complete and incomplete vehicles based upon the applicable complete sister vehicles as determined in 40 CFR 1819–14(j)(2).

(v) Use CO<sub>2</sub> emissions test results for loose engines using applicable complete vehicles as determined in 40 CFR 86.1819–14(k)(8).

(vi) Manufacturers can choose to analytically derive CO<sub>2</sub> emission rates (ADCs) for test groups or subconfigurations. Use ADCs for test groups or subconfigurations in accordance with 40 CFR 86.1819–14 (d) and (g).

(4) Calculate equivalent fuel consumption results for all test groups, in gallons per 100 miles, from CO<sub>2</sub> emissions test group results, in grams per miles, and round to the nearest 0.001 gallon per 100 miles.

(i) Calculate the equivalent fuel consumption test group results as follows for compression-ignition vehicles and alternative fuel compression-ignition vehicles. CO<sub>2</sub> emissions test group result (grams per mile)/10,180 grams per gallon of diesel fuel) × (10<sup>2</sup>) = Fuel consumption test group result (gallons per 100 mile).

(ii) Calculate the equivalent fuel consumption test group results as follows for spark-ignition vehicles and alternative fuel spark-ignition vehicles. CO<sub>2</sub> emissions test group result (grams per mile)/8,877 grams per gallon of gasoline fuel) × (10<sup>2</sup>) = Fuel consumption test group result (gallons per 100 mile).

(5) Calculate the fleet average fuel consumption result, in gallons per 100 miles, from the equivalent fuel consumption test group results and round the fuel consumption result to the nearest 0.001 gallon per 100 miles. Calculate the fleet average fuel consumption result using the following equation.



$$\text{Fleet Average Fuel Consumption} = \frac{\sum [\text{Fuel Consumption Test Group Result}_i \times \text{Volume}_i]}{\sum [\text{Volume}_i]}$$

Where:

Fuel Consumption Test Group Result<sub>i</sub> = fuel consumption performance for each test group as defined in 49 CFR 523.4.

Volume<sub>i</sub> = production volume of each test group.

(6) Compare the fleet average fuel consumption standard to the fleet average fuel consumption performance. The fleet average fuel consumption performance must be less than or equal to the fleet fuel consumption standard to comply with standards in § 535.5(a).

(b) *Heavy-duty vocational vehicles and tractors.* This section describes the method for determining the fuel consumption performance rates for vehicle families of heavy-duty vocational vehicles and tractors. The NHTSA heavy-duty vocational vehicle and tractor fuel consumption performance rates correspond to the same requirements for EPA as specified in 40 CFR 1037, subpart F.

(1) Select vehicles and vehicle family configurations to test as specified in 40 CFR 1037.230 for vehicles that make up each of the manufacturer's regulatory subcategories of vocational vehicles and tractors. For the Phase 2 program, select powertrain, axle and transmission families in accordance with 40 CFR 1037.231 and 1037.232.

(2) Follow the EPA testing requirements in 40 CFR 1037.230 and 1037.501 to derive inputs for the Greenhouse gas Emissions Model (GEM).

(3) Enter inputs into GEM, in accordance with 40 CFR 1037.520, to derive the emissions and fuel consumption performance results for all vehicles (conventional, alternative fueled and advanced technology vehicles).

(4) For Phase 1 and 2, all of the following GEM inputs apply for vocational vehicles and other tractor regulatory subcategories, as follows:

(i) Model year and regulatory subcategory (see § 535.3 and 40 CFR 1037.230).

(ii) Coefficient of aerodynamic drag or drag area, as described in 40 CFR 1037.520(b) (tractors only for Phase 1).

(iii) Steer and drive tire rolling resistance, as described in 40 CFR 1037.520(c).

(iv) Vehicle speed limit, as described in 40 CFR 1037.520(d) (tractors only).

(v) Vehicle weight reduction, as described in 40 CFR 1037.520(e) (tractors only for Phase 1).

(vi) Automatic engine shutdown systems, as described in 40 CFR 1037.660 (only for Phase 1 Class 8 sleeper cabs). For Phase 1, enter a GEM input value of 5.0 g/ton-mile, or an adjusted value as specified in 40 CFR 1037.660.

(5) For Phase 2 vehicles, the GEM inputs described in paragraphs (b)(4)(i) through (v) of this section continue to apply. Note that the provisions related to vehicle speed limiters and automatic engine shutdown systems are available for vocational vehicles in Phase 2. The additional GEM inputs that apply for vocational vehicles and other tractor regulatory subcategories for demonstrating compliance with Phase 2 standards are as follows:

(i) *Engine characteristics.* Enter information from the engine manufacturer to describe the installed engine and its operating parameters as described in 40 CFR 1036.510 and 1037.520(f).

(ii) *Vehicle information.* Enter information in accordance with 40 CFR 1037.520(g) for the vehicle and its operating parameters including:

(A) Transmission make, model and type;

(B) Drive axle configuration;

(C) Drive axle ratio,  $k_a$ ;

(D) GEM inputs associated with powertrain testing include powertrain family, transmission calibration identifier, test data from 40 CFR 1037.550, and the powertrain test configuration (dynamometer connected to transmission output or wheel hub).

(iii) *Idle-reduction technologies.*

Identify whether the manufacturer's vehicle has qualifying idle-reduction technologies, subject to the qualifying criteria in 40 and 1037.660 and enter values for stop start and neutral idle technologies as specified in 40 CFR 1037.520(h).

(iv) *Axle and transmission efficiency.* Manufacturers may use axle efficiency maps as described in 40 CFR 1037.560 and transmission efficiency maps as described in 40 CFR 1037.565 to replace the default values in GEM.

(v) *Additional reduction technologies.* Enter input values in GEM as follows to characterize the percentage CO<sub>2</sub> emission reduction corresponding to certain technologies and vehicle configurations, or enter 0 as specified in 40 CFR 1037.520(j):

(A) Intelligent controls

(B) Accessory load

(C) Tire-pressure systems  
(D) Extended-idle reduction

(E) Additional GEM inputs may apply as follows:

(1) Enter 1.7 and 0.9, respectively, for school buses and coach buses that have at least seven available forward gears.

(2) If the agencies approve an off-cycle technology under § 535.7(f) and 40 CFR 1037.610 in the form of an improvement factor, enter the improvement factor expressed as a percentage reduction in CO<sub>2</sub> emissions. (Note: In the case of approved off-cycle technologies whose benefit is quantified as a g/ton-mile credit, apply the credit to the GEM result, not as a GEM input value.)

(vi) *Vehicles with hybrid power take-off (PTO).* For vocational vehicles, determine the delta PTO emission result of the manufacturer's engine and hybrid power take-off system as described in 40 CFR 1037.540.

(vii) *Aerodynamic improvements for vocational vehicles.* For vocational vehicles certified using the Regional duty cycle, enter  $\Delta C_d A$  values to account for using rear fairings and a reduced minimum frontal area as specified in 40 CFR 1037.520(m) and 1037.527.

(viii) *Alternate fuels.* For fuels other than those identified in GEM, perform the simulation by identifying the vehicle as being diesel-fueled if the engine is subject to the compression-ignition standard, or as being gasoline-fueled if the engine is subject to the spark-ignition standards. Correct the engine or powertrain fuel map for mass-specific net energy content as described in 40 CFR 1036.535(b).

(ix) *Custom chassis vehicles.* A simplified version of GEM applies for custom chassis vehicle subject § 535.5(b)(6) in accordance with 40 CFR 1037.520(a)(2)(ii).

(6) In unusual circumstances, manufacturers may ask EPA to use weighted average results of multiple GEM runs to represent special technologies for which no single GEM run can accurately reflect.

(7) From the GEM results, select the CO<sub>2</sub> family emissions level (FEL) and equivalent fuel consumption values for vocational vehicle and tractor families in each regulatory subcategory for each model year. Equivalent fuel consumption FELs are derived in GEM and expressed to the nearest 0.0001 gallons per 1000 ton-mile. For families containing multiple subfamilies, identify the FELs for each subfamily.

(c) [Reserved]

(d) *Heavy-duty engines*. This section describes the method for determining equivalent fuel consumption family certification level (FCL) values for engine families of heavy-duty truck tractors and vocational vehicles. The NHTSA heavy-duty engine fuel consumption FCLs are determined from the EPA FCLs tested in accordance with 40 CFR 1036, subpart F. Each engine family must use the same primary intended service class as designated for EPA in accordance with 40 CFR 1036.140.

(1) Manufacturers must select emission-data engines representing the tested configuration of each engine family specified in 40 CFR part 86 and 40 CFR 1036.235 for engines in heavy-duty truck tractors and vocational vehicles that make up each of the manufacturer's regulatory subcategories.

(2) Standards in § 535.5(d) apply to the CO<sub>2</sub> emissions rates for each emissions-data engine in an engine family subject to the procedures and equipment specified in 40 CFR part 1036, subpart F. Determine equivalent fuel consumption rates using CO<sub>2</sub> emissions rates in grams per hp-hr measured to at least one more decimal place than that of the applicable EPA standard in 40 CFR 1036.108.

(i) Use the CO<sub>2</sub> emissions test results for engines running on each fuel type for conventional, dedicated, multi-fueled (dual-fuel, and flexible-fuel) engines as specified in 40 CFR part 1036, subpart F.

(ii) Use the CO<sub>2</sub> emissions result for multi-fueled engines using the same weighted fuel mixture emission results as specified in 40 CFR 1036.235 and 40 CFR part 1036, subpart F.

(iii) Use the CO<sub>2</sub> emissions test results for hybrid engines as described in 40 CFR 1036.525.

(iv) All electric vehicles are deemed to have zero emissions of CO<sub>2</sub> and zero fuel consumption. No emission or fuel consumption testing is required for such electric vehicles.

(3) Use the CO<sub>2</sub> emissions test results for tractor engine families in accordance with 40 CFR 1036.501 and for vocational vehicle engine families in accordance with 40 CFR part 86, subpart N, for each heavy-duty engine regulatory subcategory for each model year.

(i) If a manufacturer certifies an engine family for use both as a vocational engine and as a tractor engine, the manufacturer must split the family into two separate subfamilies in accordance with 40 CFR 1036.230. The manufacturer may assign the numbers and configurations of engines within the

respective subfamilies at any time prior to the submission of the end-of-year report required by 40 CFR 1036.730 and § 535.8. The manufacturer must track into which type of vehicle each engine is installed, although EPA may allow the manufacturer to use statistical methods to determine this for a fraction of its engines.

(ii) The following engines are excluded from the engine families used to determine fuel consumption FCL values and the benefit for these engines is determined as an advanced technology credit under the ABT provisions provided in § 535.7(e); these provisions apply only for the Phase 1 program:

(A) Engines certified as hybrid engines or power packs.

(B) Engines certified as hybrid engines designed with PTO capability and that are sold with the engine coupled to a transmission.

(C) Engines with Rankine cycle waste heat recovery.

(4) Manufacturers generating CO<sub>2</sub> emissions rates to demonstrate compliance to EPA vehicle standards for model years 2021 and later, using engine fuel maps determined in accordance with 40 CFR 1036.535 and 1036.540 or engine powertrain results in accordance with 40 CFR 1036.630 and 40 CFR 1037.550 for each engine configuration, must use the same compliance pathway and model years for certifying under the NHTSA program. Manufacturers may omit providing equivalent fuel consumption FCLs under this section if all of its engines will be installed in vehicles that are certified based on powertrain testing as described in 40 CFR 1037.550.

(5) Calculate equivalent fuel consumption values from the emissions CO<sub>2</sub> FCLs levels for certified engines, in gallons per 100 hp-hr and round each fuel consumption value to the nearest 0.0001 gallon per 100 hp-hr.

(i) Calculate equivalent fuel consumption FCL values for compression-ignition engines and alternative fuel compression-ignition engines. CO<sub>2</sub> FCL value (grams per hp-hr)/10,180 grams per gallon of diesel fuel  $\times (10^2) =$  Fuel consumption FCL value (gallons per 100 hp-hr).

(ii) Calculate equivalent fuel consumption FCL values for spark-ignition engines and alternative fuel spark-ignition engines. CO<sub>2</sub> FCL value (grams per hp-hr)/8,877 grams per gallon of gasoline fuel  $\times (10^2) =$  Fuel consumption FCL value (gallons per 100 hp-hr).

(iii) Manufacturers may carryover fuel consumption data from a previous model year if allowed to carry over

emissions data for EPA in accordance with 40 CFR 1036.235.

(iv) If a manufacturer uses an alternate test procedure under 40 CFR 1065.10 and subsequently the data is rejected by EPA, NHTSA will also reject the data.

(e) *Heavy-duty trailers*. This section describes the method for determining the fuel consumption performance rates for trailers. The NHTSA heavy-duty trailers fuel consumption performance rates correspond to the same requirements for EPA as specified in 40 CFR part 1037, subpart F.

(1) Select trailer family configurations that make up each of the manufacturer's regulatory subcategories of heavy-duty trailers in 40 CFR 1037.230 and § 535.4.

(2) Obtain preliminary approvals for trailer aerodynamic devices from EPA in accordance with 40 CFR 1037.150.

(3) For manufacturers voluntarily complying in model years 2018 through 2020, and for trailers complying with mandatory standards in model years 2021 and later, determine the CO<sub>2</sub> emissions and fuel consumption results for partial- and full-aero trailers using the equations and technologies specified in 40 CFR part 1037, subpart F. Use testing to determine input values in accordance with 40 CFR 1037.515.

(4) From the equation results, use the CO<sub>2</sub> family emissions level (FEL) to calculate equivalent fuel consumption FELs are expressed to the nearest 0.0001 gallons per 1000 ton-mile.

(i) For families containing multiple subfamilies, identify the FELs for each subfamily.

(ii) Calculate equivalent fuel consumption FEL values for trailer families. CO<sub>2</sub> FEL value (grams per 1000 ton-mile)/10,180 grams per 1000 ton-mile of diesel fuel  $\times (10^3) =$  Fuel consumption FEL value. The equivalent fuel consumption FELs are expressed to the nearest 0.0001 gallons per 1000 ton-mile.

#### **§ 535.7 Averaging, banking, and trading (ABT) credit program.**

(a) *General provisions*. After the end of each model year, manufacturers must comply with the fuel consumption standards in § 535.5 for averaging, banking and trading credits. Trailer manufacturers are excluded from this section except for those producing full-aero box trailers, which may comply with special provisions in paragraph (e) of this section. Manufacturers comply with standards if the sum of averaged, banked and traded credits generate a "zero" credit balance or a credit surplus within an averaging set of vehicles or engines. Manufacturers fail to comply with standards if the sum of the credit flexibilities generate a credit deficit (or

shortfall) in an averaging set. Credit shortfalls must be offset by banked or traded credits within three model years after the shortfall is incurred. These processes are hereafter referenced as the NHTSA ABT credit program. The following provisions apply to all fuel consumption credits.

(1) *Credits (or fuel consumption credits (FCCs))*. Credits in this part mean a calculated weighted value representing the difference between the fuel consumption performance and the standard of a vehicle or engine family or fleet within a particular averaging set. Positive credits represent cases where a vehicle or engine family or fleets perform better than the applicable standard (the fuel consumption performance is less than the standard) whereas negative credits represent underperforming cases. The value of a credit is calculated according to paragraphs (b) through (e) of this section. FCCs are only considered earned or useable for averaging, banking or trading after EPA and NHTSA have verified the information in a manufacturer's final reports required in § 535.8. Types of FCCs include the following:

(i) *Conventional credits*. Credits generated by vehicle or engine families or fleets containing conventional vehicles (*i.e.*, gasoline, diesel and alternative fueled vehicles).

(ii) *Early credits*. Credits generated by vehicle or engine families or fleets produced for model year 2013. Early credits are multiplied by an incentive factor of 1.5 times.

(iii) *Advanced technology credits*. Credits generated by vehicle or engine families or subconfigurations containing vehicles with advanced technologies (*i.e.*, hybrids with regenerative braking, vehicles equipped with Rankine-cycle engines, electric and fuel cell vehicles) and incentivized under this ABT credit program in paragraph (f)(1) of this section and by EPA under 40 CFR 86.1819–14(d)(7), 1036.615, and 1037.615.

(iv) *Innovative and off-cycle technology credits*. Credits can be generated by vehicle or engine families or subconfigurations having fuel consumption reductions resulting from technologies not reflected in the GEM simulation tool or in the FTP chassis dynamometer and that were not in common use with heavy-duty vehicles or engines before model year 2010 that are not reflected in the specified test procedure. Manufacturers should prove that these technologies were not in common use in heavy-duty vehicles or engines before model year 2010 by demonstrating factors such as the

penetration rates of the technology in the market. NHTSA will not approve any request if it determines that these technologies do not qualify. The approach for determining innovative and off-cycle technology credits under this fuel consumption program is described in paragraph (f)(2) of this section and by EPA under 40 CFR 86.1819–14(d)(13), 1036.610, and 1037.610.

(2) *Averaging*. Averaging is the summing of a manufacturer's positive and negative FCCs for engines or vehicle families or fleets within an averaging set. The principle averaging sets are defined in § 535.4.

(i) A credit surplus occurs when the net sum of the manufacturer's generated credits for engines or vehicle families or fleets within an averaging set is positive (a zero credit balance is when the sum equals zero).

(ii) A credit deficit occurs when the net sum of the manufacturer's generated credits for engines or vehicle families or fleets within an averaging set is negative.

(iii) Positive credits, other than advanced technology credits, generated and calculated within an averaging set may only be used to offset negative credits within the same averaging set.

(iv) Manufacturers may certify one or more vehicle families (or subfamilies) to an FEL above the applicable fuel consumption standard, subject to any applicable FEL caps and other provisions allowed by EPA in 40 CFR parts 1036 and 1037, if the manufacturer shows in its application for certification to EPA that its projected balance of all FCC transactions in that model year is greater than or equal to zero or that a negative balance is allowed by EPA under 40 CFR 1036.745 and 1037.745.

(v) If a manufacturer certifies a vehicle family to an FEL that exceeds the otherwise applicable standard, it must obtain enough FCC to offset the vehicle family's deficit by the due date of its final report required in § 535.8. The emission credits used to address the deficit may come from other vehicle families that generate FCCs in the same model year (or from the next three subsequent model years), from banked FCCs from previous model years, or from FCCs generated in the same or previous model years that it obtained through trading. Note that the option for using banked or traded credits does not apply for trailers.

(vi) Manufacturers may certify a vehicle or engine family using an FEL (as described in § 535.6) below the fuel consumption standard (as described in § 535.5) and choose not to generate conventional fuel consumption credits

for that family. Manufacturers do not need to calculate fuel consumption credits for those families and do not need to submit or keep the associated records described in § 535.8 for these families. Manufacturers participating in NHTSA's FCC program must provide reports as specified in § 535.8.

(3) *Banking*. Banking is the retention of surplus FCC in an averaging set by the manufacturer for use in future model years for the purpose of averaging or trading.

(i) Surplus credits may be banked by the manufacturer for use in future model years, or traded, given the restriction that the credits have an expiration date of five model years after the year in which the credits are generated. For example, banked credits earned in model year 2014 may be utilized through model year 2019. Surplus credits will become banked credits unless a manufacturer contacts NHTSA to expire its credits.

(ii) Surplus credits become earned or usable banked FCCs when the manufacturer's final report is approved by both agencies. However, the agencies may revoke these FCCs at any time if they are unable to verify them after reviewing the manufacturer's reports or auditing its records.

(iii) Banked FCC retain the designation from the averaging set and model year in which they were generated.

(iv) Banked credits retain the designation of the averaging set in which they were generated.

(v) Trailer manufacturers generating credits in paragraph (e) of this section may not bank credits except to resolve credit deficits in the same model year or from up to three prior model years.

(4) *Trading*. Trading is a transaction that transfers banked FCCs between manufacturers or other entities in the same averaging set. A manufacturer may use traded FCCs for averaging, banking, or further trading transactions.

(i) Manufacturers may only trade banked credits to other manufacturers to use for compliance with fuel consumption standards. Traded FCCs, other than advanced technology credits, may be used only within the averaging set in which they were generated. Manufacturers may only trade credits to other entities for the purpose of expiring credits.

(ii) Advanced technology credits can be traded across different averaging sets.

(iii) The agencies may revoke traded FCCs at any time if they are unable to verify them after reviewing the manufacturer's reports or auditing its records.

(iv) If a negative FCC balance results from a transaction, both the buyer and seller are liable, except in cases the agencies deem to involve fraud. See § 535.9 for cases involving fraud. EPA also may void the certificates of all vehicle families participating in a trade that results in a manufacturer having a negative balance of emission credits. See 40 CFR 1037.745.

(v) Trailer manufacturers generating credits in paragraph (e) of this section starting in model year 2027 may not bank or trade credits. These manufacturers may only use credits for the purpose of averaging.

(vi) Manufacturers with deficits or projecting deficits before or during a production model year may not trade credits until its available credits exceed the deficit. Manufacturers with a deficit may not trade credits if the deadline to offset that credit deficit has passed.

(5) *Credit deficit (or credit shortfall)*. A credit shortfall or deficit occurs when the sum of the manufacturer's generated credits for engines or vehicle families or fleets within an averaging set is negative. Credit shortfalls must be offset by an available credit surplus within three model years after the shortfall was incurred. If the shortfall cannot be offset, the manufacturer is liable for civil penalties as discussed in § 535.9.

(6) *FCC credit plan*. (i) Each model year manufacturers submit credit plan in their certificates of conformity as required in 40 CFR 1036.725(b)(2) and 40 CFR 1037.725(b)(2). The plan is required to contain equivalent fuel consumption information in accordance § 535.8(c). The plan must include:

(A) Detailed calculations of projected emission and fuel consumption credits (positive or negative) based on projected U.S.-directed production volumes. The agencies may require a manufacturer to include similar calculations from its other engine or vehicle families to project its net credit balances for the model year. If a manufacturer projects negative emission and/or fuel consumption credits for a family, it must state the source of positive emission and/or fuel consumption credits it expects to use to offset the negative credits demonstrating how it plans to resolve any credit deficits that might occur for a model year within a period of up to three model years after that deficit has occurred.

(B) Actual emissions and fuel consumption credit balances, credit transactions, and credit trades.

(ii) Manufacturers are required to provide updated credit plans after receiving their final verified reports from EPA and NHTSA after the end of each model year.

(iii) The agencies may determine that a manufacturer's plan is unreasonable or unrealistic based on a consideration of past and projected use of specific technologies, the historical sales mix of its vehicle models, subsequent failure to follow any submitted plans, and limited expected access to traded credits.

(iv) The agencies may also consider the plan unreasonable if the manufacturer's credit deficit increases from one model year to the next. The agencies may require that the manufacturers must send interim reports describing its progress toward resolving its credit deficit over the course of a model year.

(v) If NHTSA determines that a manufacturer's plan is unreasonable or unrealistic, the manufacturer is deemed as not comply with fuel consumption standards as specified in § 535.10(c) and the manufacturer may be liable for civil penalties.

(7) *Revoked credits*. NHTSA may revoke fuel consumption credits if unable to verify any information after auditing reports or records or conducting confirmatory testing. In the cases where EPA revokes emissions CO<sub>2</sub> credits, NHTSA will revoke the equivalent amount of fuel consumption credits.

(8) *Transition to Phase 2 standards*. The following provisions allow for enhanced use of fuel consumption credits from Phase 1 tractors and vocational vehicles for meeting the Phase 2 standards:

(i) Fuel consumption credits a manufacturer generates for light and medium heavy-duty vocational vehicles in model years 2018 through 2021 may be used through model year 2027, instead of being limited to a five-year credit life as specified in this part.

(ii) The manufacturer may use the off-cycle provisions of paragraph (f) of this section to apply technologies to Phase 1 vehicles as follows:

(A) A manufacturer may apply an improvement factor of 0.988 for tractors and vocational vehicles with automatic tire inflation systems on all axles.

(B) For vocational vehicles with automatic engine shutdown systems that conform with 40 CFR 1037.660, a manufacturer may apply an improvement factor of 0.95.

(C) For vocational vehicles with stop-start systems that conform with 40 CFR 1037.660, a manufacturer may apply an improvement factor of 0.92.

(D) For vocational vehicles with neutral-idle systems conforming with 40 CFR 1037.660, manufacturers may apply an improvement factor of 0.98. Manufacturers may adjust this improvement factor if we approve a

partial reduction under 40 CFR 1037.660(a)(2); for example, if the manufacturer's design reduces fuel consumption by half as much as shifting to neutral, it may apply an improvement factor of 0.99.

(9) *Credits for small business manufacturers*. Small manufacturers may generate fuel consumption credits for natural gas-fueled vocational vehicles as follows:

(i) Small manufacturers may certify their vehicles instead of relying on the exemption of § 535.3.

(ii) Use Phase 1 GEM to determine a fuel consumption level for vehicle, then multiply this value by the engine's FCL for fuel consumption and divide by the engine's applicable fuel consumption standard.

(iii) Use the value determined in paragraph (ii) in the credit equation specified in part (c) of this section in place of the term (Std - FEL).

(iv) The following provisions apply uniquely to small businesses under the custom-chassis standards of § 535.5(b)(6):

(A) Manufacturers may use fuel consumption credits generated under paragraph (c) of this section, including banked or traded credits from any averaging set. Such credits remain subject to other limitations that apply under this part.

(B) Manufacturers may produce up to 200 drayage tractors in a given model year to the standards described in § 535.5(b)(6) for "other buses". Treat these drayage tractors as being in their own averaging set.

(10) *Certifying non-gasoline engines*. A manufacturer producing non-gasoline engines complying with model year 2021 or later medium heavy-duty spark-ignition standards may not generate fuel consumption credits. Only manufacturers producing gasoline engines certifying to spark-ignition standards can generate fuel consumption credits under paragraph (d) of this part.

(b) *ABT provisions for heavy-duty pickup trucks and vans*. (1) Calculate fuel consumption credits in a model year for one fleet of conventional heavy-duty pickup trucks and vans and if designated by the manufacturer another consisting of advance technology vehicles for the averaging set as defined in § 535.4. Calculate credits for each fleet separately using the following equation:

$$\text{Total MY Fleet FCC (gallons)} = (\text{Std} - \text{Act}) \times (\text{Volume}) \times (\text{UL}) \times (10^2)$$

Where:

Std = Fleet average fuel consumption standard (gal/100 mile).

Act = Fleet average actual fuel consumption value (gal/100 mile).  
 Volume = the total U.S.-directed production of vehicles in the regulatory subcategory.  
 UL = the useful life for the regulatory subcategory. The useful life value for heavy-pickup trucks and vans manufactured for model years 2013 through 2020 is equal to the 120,000 miles. The useful life for model years 2021 and later is equal to 150,000 miles.

(2) Adjust the fuel consumption performance of subconfigurations with advanced technology for determining the fleet average actual fuel consumption value as specified in paragraph (f)(1) of this section and 40 CFR 86.1819–14(d)(7). Advanced technology vehicles can be separated in a different fleet for the purpose of applying credit incentives as described in paragraph (f)(1) of this section.

(3) Adjust the fuel consumption performance for subconfigurations with innovative technology. A manufacturer is eligible to increase the fuel consumption performance of heavy-duty pickup trucks and vans in accordance with procedures established by EPA set forth in 40 CFR part 600. The eligibility of a manufacturer to increase its fuel consumption performance through use of an off-cycle technology requires an application request made to EPA and NHTSA in accordance with 40 CFR 86.1869–12 and an approval granted by the agencies. For off-cycle technologies that are covered under 40 CFR 86.1869–12, NHTSA will collaborate with EPA regarding NHTSA’s evaluation of the specific off-cycle technology to ensure its impact on fuel consumption and the suitability of using the off-cycle technology to adjust fuel consumption performance. NHTSA will provide its views on the suitability of the technology for that purpose to EPA. NHTSA will apply the criteria in section (f) of this section in granting or denying off-cycle requests.

(4) Fuel consumption credits may be generated for vehicles certified in model year 2013 to the model year 2014 standards in § 535.5(a). If a manufacturer chooses to generate CO<sub>2</sub> emission credits under EPA’s provisions in 40 CFR part 86, it may also voluntarily generate early credits under the NHTSA fuel consumption program. To do so, a manufacturer must certify its entire U.S.-directed production volume of vehicles in its fleet. The same production volume restrictions specified in 40 CFR 1037.150(a)(2) relating to when test groups are certified apply to the NHTSA early credit provisions. Credits are calculated as specified in paragraph (b)(3) of this section relative to the fleet standard that

would apply for model year 2014 using the model year 2013 production volumes. Surplus credits generated under this paragraph (b)(4) are available for banking or trading. Credit deficits for an averaging set prior to model year 2014 do not carry over to model year 2014. These credits may be used to show compliance with the standards of this part for 2014 and later model years. Once a manufacturer opts into the NHTSA program they must stay in the program for all of the optional model years and remain standardized with the same implementation approach being followed to meet the EPA CO<sub>2</sub> emission program.

(5) Calculate the averaging set credit value by summing together the fleet credits for conventional and advanced technology vehicles including any adjustments for innovative technologies. Manufacturers may sum conventional and innovative technology credits before adding any advanced technology credits in each averaging set.

(6) For credits that manufacturers calculate based on a useful life of 120,000 miles, multiply any banked credits carried forward for use in model year 2021 and later by 1.25. For credit deficits that a manufacturer calculates based on a useful life of 120,000 miles and that it offsets with credits originally earned in model year 2021 and later, it multiplies the credit deficit by 1.25.

(c) *ABT provisions for vocational vehicles and tractors.* (1) Calculate the fuel consumption credits in a model year for each participating family or subfamily consisting of conventional vehicles in each averaging set (as defined in § 535.4) using the equation in this section. Each designated vehicle family or subfamily has a “family emissions limit” (FEL) that is compared to the associated regulatory subcategory standard. An FEL that falls below the regulatory subcategory standard creates “positive credits,” while fuel consumption level of a family group above the standard creates a “negative credits.” The value of credits generated for each family or subfamily in a model year is calculated as follows and must be rounded to nearest whole number:

$$\text{Vehicle Family FCC (gallons)} = (\text{Std} - \text{FEL}) \times (\text{Payload}) \times (\text{Volume}) \times (\text{UL}) \times (10^3)$$

Where:

Std = the standard for the respective vehicle family regulatory subcategory (gal/1000 ton-mile).

FEL = family emissions limit for the vehicle family (gal/1000 ton-mile).

Payload = the prescribed payload in tons for each regulatory subcategory as shown in the following table:

Regulatory subcategory	Payload (tons)
Vocational LHD Vehicles .....	2.85
Vocational MHD Vehicles .....	5.60
Vocational HHD Vehicles .....	7.5
MDH Tractors .....	12.50
HHD Tractors, other than heavy-haul Tractors .....	19.00
Heavy-haul Tractors .....	43.00

Volume = the number of U.S.-directed production volume of vehicles in the corresponding vehicle family.

UL = the useful life for the regulatory subcategory (miles) as shown in the following table:

Regulatory subcategory	UL (miles)
LHD Vehicles .....	110,000 (Phase 1). 150,000 (Phase 2). 185,000.
Vocational MHD Vehicles and tractors at or below 33,000 pounds GVWR.	435,000.
Vocation HHD Vehicles and tractors at or above 33,000 pounds GVWR.	

(i) Calculate the value of credits generated in a model year for each family or subfamily consisting of vehicles with advanced technology vehicles in each averaging set using the equation above and the guidelines provided in paragraph (f)(1) of this section. Manufacturers may generate credits for advanced technology vehicles using incentives specified in paragraph (f)(1) of this section.

(ii) Calculate the value of credits generated in a model year for each family or subfamily consisting of vehicles with off-cycle technology vehicles in each averaging set using the equation above and the guidelines provided in paragraph (f)(2) of this section.

(2) Manufacturers must sum all negative and positive credits for each vehicle family within each applicable averaging set to obtain the total credit balance for the model year before rounding. The sum of fuel consumptions credits must be rounded to the nearest gallon. Calculate the total credits generated in a model year for each averaging set using the following equation:

$$\text{Total averaging set MY credits} = \sum \text{Vehicle family credits within each averaging set}$$

(3) Manufacturers can sum conventional and innovative technology credits before adding any advanced technology credits in each averaging set.

(4) If a manufacturer chooses to generate CO<sub>2</sub> emission credits under

EPA provisions of 40 CFR 1037.150(a), it may also voluntarily generate early credits under the NHTSA fuel consumption program as follows:

(i) Fuel consumption credits may be generated for vehicles certified in model year 2013 to the model year 2014 standards in § 535.5(b) and (c). To do so, a manufacturer must certify its entire U.S.-directed production volume of vehicles. The same production volume restrictions specified in 40 CFR 1037.150(a)(1) relating to when test groups are certified apply to the NHTSA early credit provisions. Credits are calculated as specified in paragraph (c)(11) of this section relative to the standards that would apply for model year 2014. Surplus credits generated under this paragraph (c)(4) may be increased by a factor of 1.5 for determining total available credits for banking or trading. For example, if a manufacturer has 10 gallons of surplus credits for model year 2013, it may bank 15 gallons of credits. Credit deficits for an averaging set prior to model year 2014 do not carry over to model year 2014. These credits may be used to show compliance with the standards of this part for 2014 and later model years. Once a manufacturer opts into the NHTSA program they must stay in the program for all of the optional model years and remain standardized with the same implementation approach being followed to meet the EPA CO<sub>2</sub> emission program.

(ii) A tractor manufacturer may generate fuel consumption credits for the number of additional SmartWay designated tractors (relative to its MY 2012 production), provided that credits are not generated for those vehicles under paragraph (c)(4)(i) of this section. Calculate credits for each regulatory sub-category relative to the standard that would apply in model year 2014 using the equations in paragraph (c)(2) of this section. Use a production volume equal to the number of verified model year 2013 SmartWay tractors minus the number of verified model year 2012 SmartWay tractors. A manufacturer may bank credits equal to the surplus credits generated under this paragraph multiplied by 1.50. A manufacturer's 2012 and 2013 model years must be equivalent in length. Once a manufacturer opts into the NHTSA program they must stay in the program for all of the optional model years and remain standardized with the same implementation approach being followed to meet the EPA CO<sub>2</sub> emission program.

(5) If a manufacturer generates credits from vehicles certified for advanced technology in accordance with

paragraph (e)(1) of this section, a multiplier of 1.5 can be used, but this multiplier cannot be used on the same credits for which the early credit multiplier is used.

(6) For model years 2012 and later, manufacturers may generate or use fuel consumption credits for averaging to demonstrate compliance with the alternative standards as described in § 535.5(b)(6) of this part. Manufacturers can specify a Family Emission Limit (FEL) for fuel consumption for each vehicle subfamily. The FEL may not be less than the result of emissions and fuel consumption modeling as described in 40 CFR 1037.520 and § 535.6. These FELs serve as the fuel consumption standards for the vehicle subfamily instead of the standards specified in this § 535.5(b)(6). Manufacturers may not use averaging for motor homes, coach buses, emergency vehicles or concrete mixers meeting standards under § 535.5(b)(5).

(7) Manufacturers may not use averaging for vehicles meeting standards § 535.5(b)(6)(iv) through (vi), and manufacturers may not use fuel consumption credits for banking or trading for any vehicles certified under § 535.5(b)(6).

(8) Manufacturers certifying any vehicles under § 535.5(b)(6) must consider each separate vehicle type (or group of vehicle types) as a separate averaging set.

(d) *ABT provisions for heavy-duty engines.* (1) Calculate the fuel consumption credits in a model year for each participating family or subfamily consisting of engines in each averaging set (as defined in § 535.4) using the equation in this section. Each designated engine family has a "family certification level" (FCL) which is compared to the associated regulatory subcategory standard. A FCL that falls below the regulatory subcategory standard creates "positive credits," while fuel consumption level of a family group above the standard creates a "credit shortfall." The value of credits generated in a model year for each engine family or subfamily is calculated as follows and must be rounded to nearest whole number:

$$\text{Engine Family FCC (gallons)} = (\text{Std} - \text{FCL}) \times (\text{CF}) \times (\text{Volume}) \times (\text{UL}) \times (10^2)$$

Where:

Std = the standard for the respective engine regulatory subcategory (gal/100 hp-hr).

FCL = family certification level for the engine family (gal/100 hp-hr).

CF = a transient cycle conversion factor in hp-hr/mile which is the integrated total cycle horsepower-hour divided by the equivalent mileage of the applicable test

cycle. For engines subject to spark-ignition heavy-duty standards, the equivalent mileage is 6.3 miles. For engines subject to compression-ignition heavy-duty standards, the equivalent mileage is 6.5 miles.

Volume = the number of engines in the corresponding engine family.

UL = the useful life of the given engine family (miles) as shown in the following table:

Regulatory subcategory	UL (miles)
SI and CI LHD Engines .....	120,000 (Phase 1). 150,000 (Phase 2).
CI MHD Engines .....	185,000.
CI HHD Engines .....	435,000.

(i) Calculate the value of credits generated in a model year for each family or subfamily consisting of engines with advanced technology vehicles in each averaging set using the equation above and the guidelines provided in paragraph (f)(1) of this section. Manufacturers may generate credits for advanced technology vehicles using incentives specified in paragraph (f)(1) of this section.

(ii) Calculate the value of credits generated in a model year for each family or subfamily consisting of engines with off-cycle technology vehicles in each averaging set using the equation above and the guidelines provided in paragraph (f)(2) of this section.

(2) Manufacturers shall sum all negative and positive credits for each engine family within the applicable averaging set to obtain the total credit balance for the model year before rounding. The sum of fuel consumptions credits should be rounded to the nearest gallon.

Calculate the total credits generated in a model year for each averaging set using the following equation:

$$\text{Total averaging set MY credits} = \Sigma \text{ Engine family credits within each averaging set}$$

(3) The provisions of this section apply to manufacturers utilizing the compression-ignition engine voluntary alternate standard provisions specified in § 535.5(d)(4) as follows:

(i) Manufacturers may not certify engines to the alternate standards if they are part of an averaging set in which they carry a balance of banked credits.

For purposes of this section, manufacturers are deemed to carry credits in an averaging set if they carry credits from advance technology that are allowed to be used in that averaging set.

(ii) Manufacturers may not bank fuel consumption credits for any engine

family in the same averaging set and model year in which it certifies engines to the alternate standards. This means a manufacturer may not bank advanced technology credits in a model year it certifies any engines to the alternate standards.

(iii) Note that the provisions of paragraph (d)(10) of this section apply with respect to credit deficits generated while utilizing alternate standards.

(4) Where a manufacturer has chosen to comply with the EPA alternative compression-ignition engine phase-in standard provisions in 40 CFR 1036.150(e), and has optionally decided to follow the same path under the NHTSA fuel consumption program, it must certify all of its model year 2013 compression-ignition engines within a given averaging set to the applicable alternative standards in § 535.5(d)(5). Engines certified to these standards are not eligible for early credits under paragraph (d)(14) of this section. Credits are calculated using the same equation provided in paragraph (d)(11) of this section.

(5) If a manufacturer chooses to generate early CO<sub>2</sub> emission credits under EPA provisions of 40 CFR 1036.150, it may also voluntarily generate early credits under the NHTSA fuel consumption program. Fuel consumption credits may be generated for engines certified in model year 2013 (2015 for spark-ignition engines) to the standards in § 535.5(d). To do so, a manufacturer must certify its entire U.S.-directed production volume of engines except as specified in 40 CFR 1036.150(a)(2). Credits are calculated as specified in paragraph (d)(11) of this section relative to the standards that would apply for model year 2014 (2016 for spark-ignition engines). Surplus credits generated under this paragraph (d)(3) may be increased by a factor of 1.5 for determining total available credits for banking or trading. For example, if a manufacturer has 10 gallons of surplus credits for model year 2013, it may bank 15 gallons of credits. Credit deficits for an averaging set prior to model year 2014 (2016 for spark-ignition engines) do not carry over to model year 2014 (2016 for spark-ignition engines). These credits may be used to show compliance with the standards of this part for 2014 and later model years. Once a manufacturer opts into the NHTSA program they must stay in the program for all of the optional model years and remain standardized with the same implementation approach being followed to meet the EPA CO<sub>2</sub> emission program.

(6) Manufacturers may generate fuel consumption credits from an engine

family subject to spark-ignition standards for exchanging with other engine families only if the engines in the family are gasoline-fueled.

(7) Engine credits generated for compression-ignition engines in the 2020 and earlier model years may be used in model year 2021 and later only if the credit-generating engines were certified to the tractor standards in § 535.5(d) and 40 CFR 1036.108. Manufacturers may otherwise use fuel consumption credits generated in one model year without adjustment for certifying vehicles in a later model year, even if fuel consumption standards are different.

(8) Engine families manufacturers certify with a nonconformance penalty under 40 CFR part 86, subpart L, and may not generate fuel consumption credits.

(9) *Alternate transition option for Phase 2 engine standards.* The following provisions allow for enhanced generation and use of fuel consumption credits for manufacturers complying with engines standards in accordance with § 535.7(d)(11):

(i) If a manufacturer is eligible to certify all of its model year 2020 engines within the averaging set to the tractor and vocational vehicle engine standards in § 535.5(d)(11) and the requirements applicable to model year 2021 engines, the banked and traded fuel consumption credits generated for model year 2018 through 2024 engines may be used through model year 2030 as specified in paragraph (d)(9)(ii) of this section or through a five-year credit life, whichever is later.

(ii) Banked and traded fuel consumption credits generated under this paragraph (d)(9) for model year 2018 through 2024 engines may be used through model year 2030 with the extended credit life values shown in the table:

Model year	Credit life for transition option for phase 2 engine standards (years)
2018 .....	12
2019 .....	11
2020 .....	10
2021 .....	9
2022 .....	8
2023 .....	7
2024 .....	6
2025 and later .....	5

(e) *ABT provisions for trailers.* (1) Manufacturers cannot use averaging for non-box trailers, partial-aero trailers, or non-aero trailers or cannot use fuel consumption credits for banking or

trading. Starting in model year 2027, full aero box van manufactures may average, credits.

(2) Calculate the fuel consumption credits in a model year for each participating family or subfamily consisting of full aero box trailers (vehicles) in each averaging set (as defined in § 535.4) using the equation in this section. Each designated vehicle family or subfamily has a “family emissions limit” (FEL) which is compared to the associated regulatory subcategory standard. An FEL that falls below the regulatory subcategory standard creates “positive credits,” while fuel consumption level of a family group above the standard creates a “negative credits.” The value of credits generated for each family or subfamily in a model year is calculated as follows and must be rounded to nearest whole number:

$$\text{Vehicle Family FCC (gallons)} = (\text{Std} - \text{FEL}) \times (\text{Payload}) \times (\text{Volume}) \times (\text{UL}) \times (10^3)$$

Where:

Std = the standard for the respective vehicle family regulatory subcategory (gal/1000 ton-mile).

FEL = family emissions limit for the vehicle family (gal/1000 ton-mile).

Payload = 10 tons for short box vans and 19 tons for other trailers.

Volume = the number of U.S.-directed production volume of vehicles in the corresponding vehicle family.

UL = the useful life for the regulatory subcategory. The useful life value for heavy-duty trailers is equal to the 250,000 miles.

(3) Trailer manufacturers may not generate advanced technology credits.

(4) Manufacturers shall sum all negative and positive credits for each vehicle family within the applicable averaging set to obtain the total credit balance for the model year before rounding. Calculate the total credits generated in a model year for each averaging set using the following equation:

$$\text{Total averaging set MY credits} = \Sigma \text{ Vehicle family credits within each averaging set}$$

(5) Trailer manufacturers may not bank credits within an averaging set but surplus fuel consumption credits from a given model year may be used to offset deficits from earlier model years.

(f) *Additional credit provisions—(1) Advanced technology credits.* (i) For the Phase 1 program, manufacturers of heavy-duty pickup trucks and vans, vocational vehicles, tractors and the associated engines showing improvements in CO<sub>2</sub> emissions and fuel consumption using hybrid vehicles



with regenerative braking, vehicles equipped with Rankine-cycle engines, electric vehicles and fuel cell vehicles are eligible for advanced technology credits. Manufacturers shall use sound engineering judgment to determine the performance of the vehicle or engine with advanced technology. Advanced technology credits for vehicles or engines complying with Phase 1 standards may be increased by a 1.5 multiplier. Manufacturers may not apply this multiplier in addition to any early-credit multipliers. The maximum amount of credits a manufacturer may bring into the service class group that contains the heavy-duty pickup and van averaging set is  $5.89 \cdot 10^6$  gallons (for advanced technology credits based upon compression-ignition engines) or  $6.76 \cdot 10^6$  gallons (for advanced technology credits based upon spark-ignition engines) per model year as specified in 40 CFR part 86 for heavy-duty pickup trucks and vans, 40 CFR 1036.740 for engines and 40 CFR 1037.740 for tractors and vocational vehicles. The specified limit does not cap the amount of advanced technology credits that can be used across averaging sets within the same service class group. Advanced technology credits can be used to offset negative credits in the same averaging set or other averaging sets. A manufacturer must first apply advanced technology credits to any deficits in the same averaging set before applying them to other averaging.

(A) *Heavy-duty pickup trucks and vans.* For advanced technology systems (hybrid vehicles with regenerative braking, vehicles equipped with Rankine-cycle engines and fuel cell vehicles), calculate fleet-average performance rates consistent with good engineering judgment and the provisions of 40 CFR 86.1819–14 and 86.1865.

(B) *Tractors and vocational vehicles.* For advanced technology system (hybrid vehicles with regenerative braking, vehicles equipped with Rankine-cycle engines and fuel cell vehicles), calculate the advanced technology credits as follows:

(1) Measure the effectiveness of the advanced system by conducting A to B testing a vehicle equipped with the advanced system and an equivalent conventional system in accordance with 40 CFR 1037.615.

(2) For purposes of this paragraph (f), a conventional vehicle is considered to be equivalent if it has the same footprint, intended vehicle service class, aerodynamic drag, and other relevant factors not directly related to the advanced system powertrain. If there is no equivalent vehicle, the manufacturer

may create and test a prototype equivalent vehicle. The conventional vehicle is considered Vehicle A, and the advanced technology vehicle is considered Vehicle B.

(3) The benefit associated with the advanced system for fuel consumption is determined from the weighted fuel consumption results from the chassis tests of each vehicle using the following equation:

$$\text{Benefit (gallon/1000 ton mile)} = \text{Improvement Factor} \times \text{GEM Fuel Consumption Result}_B$$

Where:

$$\text{Improvement Factor} = (\text{Fuel Consumption}_A - \text{Fuel Consumption}_B) / (\text{Fuel Consumption}_A)$$

Fuel Consumption Rates A and B are the gallons per 1000 ton-mile of the conventional and advanced vehicles, respectively as measured under the test procedures specified by EPA. GEM Fuel Consumption Result B is the estimated gallons per 1000 ton-mile rate resulting from emission modeling of the advanced vehicle as specified in 40 CFR 1037.520 and § 535.6(b).

(4) Calculate the benefit in credits using the equation in paragraph (c) of this section and replacing the term (Std-FEL) with the benefit.

(5) For electric vehicles calculate the fuel consumption credits using an FEL of 0 g/1000 ton-mile.

(C) *Heavy-duty engines.* This section specifies how to generate advanced technology-specific fuel consumption credits for hybrid powertrains that include energy storage systems and regenerative braking (including regenerative engine braking) and for engines that include Rankine-cycle (or other bottoming cycle) exhaust energy recovery systems.

(1) Pre-transmission hybrid powertrains are those engine systems that include features that recover and store energy during engine motoring operation but not from the vehicle wheels. These powertrains are tested using the hybrid engine test procedures of 40 CFR part 1065 or using the post-transmission test procedures.

(2) Post-transmission hybrid powertrains are those powertrains that include features that recover and store energy from braking at the vehicle wheels. These powertrains are tested by simulating the chassis test procedure applicable for hybrid vehicles under 40 CFR 1037.550.

(3) Test engines that include Rankine-cycle exhaust energy recovery systems according to the test procedures specified in 40 CFR part 1036, subpart F, unless EPA approves the manufacturer's alternate procedures.

(D) *Credit calculation.* Calculate credits as specified in paragraph (c) of this section. Credits generated from engines and powertrains certified under this section may be used in other averaging sets as described in 40 CFR 1036.740(d).

(ii) There are no separate credit allowances for advanced technology vehicles in the Phase 2 program. Instead, vehicle families containing plug-in battery electric hybrids, all-electric, and fuel cell vehicles certifying to Phase 2 vocational and tractor standards may multiply credits by a multiplier of:

(A) 3.5 times for plug-in hybrid electric vehicles;

(B) 4.5 times for all-electric vehicles; and

(C) 5.5 times for fuel cell vehicles.

(D) Incentivized credits for vehicles equipped with advanced technologies maintain the same credit flexibilities and restrictions as conventional credits specified in paragraph (a) of this section during the Phase 2 program.

(E) For vocational vehicles and tractors subject to Phase 2 standards, create separate vehicle families if there is a credit multiplier for advanced technology; group those vehicles together in a vehicle family if they use the same multiplier.

(F) For Phase 2 plug-in hybrid electric vehicles and for fuel cells powered by any fuel other than hydrogen, calculate fuel consumption credits using an FEL based on equivalent emission measurements from powertrain testing. Phase 2 advanced-technology credits do not apply for hybrid vehicles that have no plug-in capability.

(2) *Innovative and off-cycle technology credits.* This provision allows fuel saving innovative and off-cycle engine and vehicle technologies to generate fuel consumption credits comparable to CO<sub>2</sub> emission credits consistent with the provisions of 40 CFR 86.1819–14(d)(13) (for heavy-duty pickup trucks and vans), 40 CFR 1036.610 (for engines), and 40 CFR 1037.610 (for vocational vehicles and tractors).

(i) For model years 2013 through 2020, manufacturers may generate innovative technology credits for introducing technologies that were not in-common use for heavy-duty tractor, vocational vehicles or engines before model year 2010 and that are not reflected in the EPA specified test procedures. Upon identification and joint approval with EPA, NHTSA will allow equivalent fuel consumption credits into its program to those allowed by EPA for manufacturers seeking to obtain innovative technology credits in



a given model year. Such credits must remain within the same regulatory subcategory in which the credits were generated. NHTSA will adopt fuel consumption credits depending upon whether—

(A) The technology has a direct impact upon reducing fuel consumption performance; and

(B) The manufacturer has provided sufficient information to make sound engineering judgments on the impact of the technology in reducing fuel consumption performance.

(ii) For model years 2021 and later, manufacturers may generate off-cycle technology credits for introducing technologies that are not reflected in the EPA specified test procedures. Upon identification and joint approval with EPA, NHTSA will allow equivalent fuel consumption credits into its program to those allowed by EPA for manufacturers seeking to obtain innovative technology credits in a given model year. Such credits must remain within the same regulatory subcategory in which the credits were generated. NHTSA will adopt fuel consumption credits depending upon whether—

(A) The technology meets paragraph (f)(2)(i)(A) and (B) of this section.

(B) For heavy-duty pickup trucks and vans, manufacturers using the 5-cycle test to quantify the benefit of a technology are not required to obtain approval from the agencies to generate results.

(iii) The following provisions apply to all innovative and off-cycle technologies:

(A) Technologies found to be defective, or identified as a part of NHTSA's safety defects program, and technologies that are not performing as intended will have the values of approved off-cycle credits removed from the manufacturer's credit balance.

(B) Approval granted for innovative and off-cycle technology credits under NHTSA's fuel efficiency program does not affect or relieve the obligation to comply with the Vehicle Safety Act (49 U.S.C. Chapter 301), including the "make inoperative" prohibition (49 U.S.C. 30122), and all applicable Federal motor vehicle safety standards issued thereunder (FMVSSs) (49 CFR part 571). In order to generate off-cycle or innovative technology credits manufacturers must state—

(1) That each vehicle equipped with the technology for which they are seeking credits will comply with all applicable FMVSS(s); and

(2) Whether or not the technology has a fail-safe provision. If no fail-safe provision exists, the manufacturer must explain why not and whether a failure

of the innovative technology would affect the safety of the vehicle.

(C) Manufacturers requesting approval for innovative technology credits are required to provide documentation in accordance with 40 CFR 86.1869–12, 1036.610, and 1037.610.

(D) Credits will be accepted on a one-for-one basis expressed in terms of gallons in comparison to those approved by EPA.

(E) For the heavy-duty pickup trucks and vans, the average fuel consumption will be calculated as a separate credit amount (rounded to the nearest whole number) using the following equation:

$$\text{Off-cycle FC credits} = (\text{CO}_2 \text{ Credit/CF}) \times 100 \times \text{Production} \times \text{VLM}$$

Where:

CO<sub>2</sub> Credits = the credit value in grams per mile determined in 40 CFR 86.1869–12(c)(3), (d)(1), (d)(2) or (d)(3).

CF = conversion factor, which for spark-ignition engines is 8,887 and for compression-ignition engines is 10,180.

Production = the total production volume for the applicable category of vehicles.

VLM = vehicle lifetime miles, which for 2b–3 vehicles shall be 150,000 for the Phase 2 program.

The term (CO<sub>2</sub> Credit/CF) should be rounded to the nearest 0.0001.

(F) NHTSA will not approve innovative technology credits for technology that is related to crash-avoidance technologies, safety critical systems or systems affecting safety-critical functions, or technologies designed for the purpose of reducing the frequency of vehicle crashes.

(iv) Manufacturers normally may not calculate off-cycle credits or improvement factors under this section for technologies represented by GEM, but the agencies may allow a manufacturer to do so by averaging multiple GEM runs for special technologies for which a single GEM run cannot accurately reflect in-use performance. For example, if a manufacturer use an idle-reduction technology that is effective 80 percent of the time, the agencies may allow a manufacturer to run GEM with the technology active and with it inactive, and then apply an 80% weighting factor to calculate the off-cycle credit or improvement factor. A may need to perform testing to establish proper weighting factors or otherwise quantify the benefits of the special technologies.

(v) A manufacturer may apply the off-cycle provisions of this paragraph (2) and 40 CFR 1037.610 to trailers as early as model year 2018 as follows:

(A) A manufacturer may account for weight reduction based on measured values instead of using the weight reductions specified in 40 CFR

1037.515. Quantify the weight reduction by measuring the weight of a trailer in a certified configuration and comparing it to the weight of an equivalent trailer without weight-reduction technologies. This qualifies as A to B testing this part. Use good engineering judgment to select an equivalent trailer representing a baseline configuration. Use the calculated weight reduction in the equation specified in 40 CFR 1037.515 to calculate the trailer's CO<sub>2</sub> emission rate and calculate an equivalent fuel consumption rate.

(B) If a manufacturer's off-cycle technology reduces emissions and fuel consumption in a way that is proportional to measured rates as described in 40 CFR 1037.610(b)(1), multiply the trailer's CO<sub>2</sub> fuel consumption rate by the appropriate improvement factor.

(C) If a manufacturer's off-cycle technology does not yield emission and fuel consumption reductions that are proportional to measured rates, as described in 40 CFR 1037.610(b)(2), calculate an adjusted CO<sub>2</sub> fuel consumption rate for trailers by subtracting the appropriate off-cycle credit.

(vi) *Carry-over Approval.*

Manufacturers may carry-over these credits into future model years as described below:

(A) For model years before 2021, manufacturers may continue to use an approved improvement factor or credit for any appropriate engine or vehicle family in future model years through 2020.

(B) For model years 2021 and later, manufacturers may not rely on an approval for model years before 2021. Manufacturers must separately request the agencies approval before applying an improvement factor or credit under this section for 2021 and later engines and vehicle, even if the agencies approve the improvement factor or credit for similar engine and vehicle models before model year 2021.

(C) The following restrictions also apply to manufacturers seeking to continue to carryover the improvement factor (not the credit value) if—

(1) The FEL is generated by GEM or 5-cycle testing;

(2) The technology is not changed or paired with any other off-cycle technology;

(3) The improvement factor only applies to approved vehicle or engine families;

(4) The agencies do not expect the technology to be incorporated into GEM at any point during the Phase 2 program; and

(D) The documentation to carryover credits that would primarily justify the difference in fuel efficiency between real world and compliance protocols is the same for both Phase 1 and Phase 2 compliance protocols. The agencies must approve the justification. If the agencies do not approve the justification, the manufacturer must recertify.

**§ 535.8 Reporting and recordkeeping requirements.**

(a) *General requirements.*

Manufacturers producing heavy-duty vehicles and engines applicable to fuel consumption standards in § 535.5, for each given model year, must submit the required information as specified in paragraphs (b) through (h) of this section.

(1) The information required by this part must be submitted by the deadlines specified in this section and must be based upon all the information and data available to the manufacturer 30 days before submitting information.

(2) Manufacturers must submit information electronically through the EPA database system as the single point of entry for all information required for this national program and both agencies will have access to the information. In special circumstances, data may not be able to be received electronically (*i.e.*, during database system development work). The agencies will inform manufacturer of the alternatives can be used for submitting information. The format for the required information will be specified by EPA in coordination with NHTSA.

(3) Manufacturers providing incomplete reports missing any of the required information or providing untimely reports are considered as not complying with standards (*i.e.*, if good-faith estimates of U.S.-directed production volumes for EPA certificates of conformity are not provided) and are liable to pay civil penalties in accordance with 49 U.S.C. 32912.

(4) Manufacturers certifying a vehicle or engine family using an FEL or FCL below the applicable fuel consumption standard as described in § 535.5 may choose not to generate fuel consumption credits for that family. In which case, the manufacturer is not required to submit reporting or keep the associated records described in this part for that family.

(5) Manufacturers must use good engineering judgment and provide comparable fuel consumption information to that of the information or data provided to EPA under 40 CFR 86.1865, 1036.250, 1036.730, 1036.825 1037.250, 1037.730, and 1037.825.

(6) Any information that must be sent directly to NHTSA. In instances in which EPA has not created an electronic pathway to receive the information, the information should be sent through an electronic portal identified by NHTSA or through the NHTSA CAFE database (*i.e.*, information on fuel consumption credit transactions). If hardcopy documents must be sent, the information should be sent to the Associate Administrator of Enforcement at 1200 New Jersey Avenue, NVS-200, Office W45-306, SW., Washington, DC 20590.

(b) *Pre-model year reports.* Manufacturers producing heavy-duty pickup trucks and vans must submit reports in advance of the model year providing early estimates demonstrating how their fleet(s) would comply with GHG emissions and fuel consumption standards. Note, the agencies understand that early model year reports contain estimates that may change over the course of a model year and that compliance information manufacturers submit prior to the beginning of a new model year may not represent the final compliance outcome. The agencies view the necessity for requiring early model reports as a manufacturer's good faith projection for demonstrating compliance with emission and fuel consumption standards.

(1) *Report deadlines.* For model years 2013 and later, manufacturer of heavy-duty pickup trucks and vans complying with voluntary and mandatory standards must submit a pre-model year report for the given model year as early as the date of the manufacturer's annual certification preview meeting with EPA and NHTSA, or prior to submitting its first application for a certificate of conformity to EPA in accordance with 40 CFR 86.1819-14(d). For example, a manufacturer choosing to comply in model year 2014 could submit its pre-model year report during its precertification meeting which could occur before January 2, 2013, or could provide its pre-model year report any time prior to submitting its first application for certification for the given model year.

(2) *Contents.* Each pre-model year report must be submitted including the following information for each model year.

(i) A list of each unique subconfiguration in the manufacturer's fleet describing the make and model designations, attribute based-values (*i.e.*, GVWR, GCWR, Curb Weight and drive configurations) and standards;

(ii) The emission and fuel consumption fleet average standard

derived from the unique vehicle configurations;

(iii) The estimated vehicle configuration, test group and fleet production volumes;

(iv) The expected emissions and fuel consumption test group results and fleet average performance;

(v) If complying with MY 2013 fuel consumption standards, a statement must be provided declaring that the manufacturer is voluntarily choosing to comply early with the EPA and NHTSA programs. The manufacturers must also acknowledge that once selected, the decision cannot be reversed and the manufacturer will continue to comply with the fuel consumption standards for subsequent model years for all the vehicles it manufacturers in each regulatory category for a given model year;

(vi) If complying with MYs 2014, 2015 or 2016 fuel consumption standards, a statement must be provided declaring whether the manufacturer will use fixed or increasing standards in accordance with § 535.5(a). The manufacturer must also acknowledge that once selected, the decision cannot be reversed and the manufacturer must continue to comply with the same alternative for subsequent model years for all the vehicles it manufacturers in each regulatory category for a given model year;

(vii) If complying with MYs 2014 or 2015 fuel consumption standards, a statement must be provided declaring that the manufacturer is voluntarily choosing to comply with NHTSA's voluntary fuel consumption standards in accordance with § 535.5(a)(4). The manufacturers must also acknowledge that once selected, the decision cannot be reversed and the manufacturer will continue to comply with the fuel consumption standards for subsequent model years for all the vehicles it manufacturers in each regulatory category for a given model year;

(viii) The list of Class 2b and 3 incomplete vehicles (cab-complete or chassis complete vehicles) and the method used to certify these vehicles as complete pickups and vans identifying the most similar complete sister- or other complete vehicles used to derive the target standards and performance test results;

(ix) The list of Class 4 and 5 incomplete and complete vehicles and the method use to certify these vehicles as complete pickups and vans identifying the most similar complete or sister vehicles used to derive the target standards and performance test results;

(x) List of loose engines included in the heavy-duty pickup and van category

and the list of vehicles used to derive target standards and performance test results;

(xi) Copy of any notices a vehicle manufacturer sends to the engine manufacturer to notify the engine manufacturers that their engines are subject to emissions and fuel consumption standards and that it intends to use their engines in excluded vehicles;

(xii) A fuel consumption credit plan as specified § 535.7(a) identifying the manufacturers estimated credit balances, planned credit flexibilities (*i.e.*, credit balances, planned credit trading, innovative, advanced and early credits and etc.) and if needed a credit deficit plan demonstrating how it plans to resolve any credit deficits that might occur for a model year within a period of up to three model years after that deficit has occurred; and

(xiii) The supplemental information specified in paragraph (h) of this section.

**Note to paragraph (b):** NHTSA may also ask a manufacturer to provide additional information if necessary to verify compliance with the fuel consumption requirements of this section.

(c) *Applications for certificate of conformity.* Manufacturers producing vocational vehicles, tractors and heavy-duty engines are required to submit applications for certificates of conformity to EPA in accordance with 40 CFR 1036.205 and 1037.205 in advance of introducing vehicles for commercial sale. Applications contain early model year information demonstrating how manufacturers plan to comply with GHG emissions. For model years 2013 and later, manufacturers of vocational vehicles, tractors and engine complying with NHTSA's voluntary and mandatory standards must submit applications for certificates of conformity in accordance through the EPA database including both GHG emissions and fuel consumption information for each given model year.

(1) *Submission deadlines.* Applications are primarily submitted in advance of the given model year to EPA but cannot be submitted any later than December 31 of the given model year.

(2) *Contents.* Each application for certificates of conformity submitted to EPA must include the following equivalent fuel consumption.

(i) Equivalent fuel consumption values for emissions CO<sub>2</sub> FCLs values used to certify each engine family in accordance with 40 CFR 1036.205(e). This provision applies only to manufacturers producing heavy-duty engines.

(ii) Equivalent fuel consumption values for emission CO<sub>2</sub> data engines used to comply with emission standards in 40 CFR 1036.108. This provision applies only to manufacturers producing heavy-duty engines.

(iii) Equivalent fuel consumption values for emissions CO<sub>2</sub> FELs values used to certify each vehicle families or subfamilies in accordance with 40 CFR 1037.205(k). This provision applies only to manufacturers producing vocational vehicles and tractors.

(iv) Report modeling results for ten configurations in terms of CO<sub>2</sub> emissions and equivalent fuel consumption results in accordance with 40 CFR 1037.205(o). Include modeling inputs and detailed descriptions of how they were derived. This provision applies only to manufacturers producing vocational vehicles and tractors.

(v) Credit plans including the fuel consumption credit plan described in § 535.7(a).

(3) *Additional supplemental information.* Manufacturers are required to submit additional information as specified in paragraph (h) of this section for the NHTSA program before or at the same time it submits its first application for a certificate of conformity to EPA. Under limited conditions, NHTSA may also ask a manufacturer to provide additional information directly to the Administrator if necessary to verify the fuel consumption requirements of this regulation.

(d) *End of the Year (EOY) and Final reports.* Heavy-duty vehicle and engine manufacturers participating in the ABT program are required to submit EOY and final reports containing information for NHTSA as specified in paragraph (d)(2) of this section and in accordance with 40 CFR 86.1865, 1036.730, and 1037.730. Only manufacturers without credit deficits may decide not to participate in the ABT or may waive the requirement to send an EOY report. The EOY and final reports are used to review a manufacturer's preliminary or final compliance information and to identify manufacturers that might have a credit deficit for the given model year. For model years 2013 and later, heavy-duty vehicle and engine manufacturers complying with NHTSA's voluntary and mandatory standards must submit EOY and final reports through the EPA database including both GHG emissions and fuel consumption information for each given model year.

(1) *Report deadlines.* (i) For model year 2013 and later, heavy-duty vehicle and engine manufacturers complying with NHTSA voluntary and mandatory standards must submit EOY reports

through the EPA database including both GHG emissions and fuel consumption information within 90 days after the end of the given model year and no later than March 31 of the next calendar year.

(ii) For model year 2013 and later, heavy-duty vehicle and engine manufacturers complying with NHTSA voluntary and mandatory standards must submit final reports through the EPA database including both GHG emissions and fuel consumption information within 270 days after the end of the given model year and no later than September 30 of the next calendar year.

(iii) A manufacturer may ask NHTSA and EPA to extend the deadline of a final report by up to 30 days. A manufacturer unable to provide, and requesting to omit an emissions rate or fuel consumption value from a final report must obtain approval from the agencies prior to the submission deadline of its final report.

(iv) If a manufacturer expects differences in the information reported between the EOY and the final year report specified in 40 CFR 1036.730 and 1037.730, it must provide the most up-to-date fuel consumption projections in its final report and identify the information as preliminary.

(v) If the manufacturer cannot provide any of the required fuel consumption information, it must state the specific reason for the insufficiency and identify the additional testing needed or explain what analytical methods are believed by the manufacturer will be necessary to eliminate the insufficiency and certify that the results will be available for the final report.

(2) *Contents.* Each EOY and final report must be submitted including the following fuel consumption information for each model year. EOY reports contain preliminary final estimates and final reports must include the manufacturer's final compliance information.

(i) Engine and vehicle family designations and averaging sets.

(ii) Engine and vehicle regulatory subcategory and fuel consumption standards including any alternative standards used.

(iii) Engine and vehicle family FCLs and FELs in terms of fuel consumption.

(iv) Production volumes for engines and vehicles.

(v) A summary as specified in paragraph (g)(7) of this section describing the vocational vehicles and vocational tractors that were exempted as heavy-duty off-road vehicles. This applies to manufacturers participating

and not participating in the ABT program.

(vi) A summary describing any advanced or innovative technology engines or vehicles including alternative fueled vehicles that were produced for the model year identifying the approaches used to determine compliance and the production volumes.

(vii) A list of each unique subconfiguration included in a manufacturer's fleet of heavy-duty pickup trucks and vans identifying the attribute based-values (GVWR, GCWR, Curb Weight, and drive configurations) and standards. This provision applies only to manufacturers producing heavy-duty pickup trucks and vans.

(viii) The fuel consumption fleet average standard derived from the unique vehicle configurations. This provision applies only to manufacturers producing heavy-duty pickup trucks and vans.

(ix) The subconfiguration and test group production volumes. This provision applies only to manufacturers producing heavy-duty pickup trucks and vans.

(x) The fuel consumption test group results and fleet average performance. This provision applies only to manufacturers producing heavy-duty pickup trucks and vans.

(xi) Manufacturers may correct errors in EOY and final reports as follows:

(A) Manufacturers may correct any errors in their end-of-year report when preparing the final report, as long as manufacturers send us the final report by the time it is due.

(B) If manufacturers or the agencies determine within 270 days after the end of the model year that errors mistakenly decreased the manufacturer's balance of fuel consumption credits, manufacturers may correct the errors and recalculate the balance of its fuel consumption credits. Manufacturers may not make any corrections for errors that are determined more than 270 days after the end of the model year. If manufacturers report a negative balance of fuel consumption credits, NHTSA may disallow corrections under this paragraph (d)(2)(xi)(B).

(C) If manufacturers or the agencies determine any time that errors mistakenly increased its balance of fuel consumption credits, manufacturers must correct the errors and recalculate the balance of fuel consumption credits.

(xii) Under limited conditions, NHTSA may also ask a manufacturer to provide additional information directly to the Administrator if necessary to verify the fuel consumption requirements of this regulation.

(e) *Amendments to applications for certification.* At any time, a manufacturer modifies an application for certification in accordance with 40 CFR 1036.225 and 1037.225, it must submit GHG emissions changes with equivalent fuel consumption values for the information required in paragraphs (b) through (e) and (h) of this section.

(f) *Confidential information.* Manufacturers must submit a request for confidentiality with each electronic submission specifying any part of the for information or data in a report that it believes should be withheld from public disclosure as trade secret or other confidential business information.

Information submitted to EPA should follow EPA guidelines for treatment of confidentiality. Requests for confidential treatment for information submitted to NHTSA must be filed in accordance with the requirements of 49 CFR part 512, including submission of a request for confidential treatment and the information for which confidential treatment is requested as specified by part 512. For any information or data requested by the manufacturer to be withheld under 5 U.S.C. 552(b)(4) and 49 U.S.C. 32910(c), the manufacturer shall present arguments and provide evidence in its request for confidentiality demonstrating that—

(1) The item is within the scope of 5 U.S.C. 552(b)(4) and 49 U.S.C. 32910(c);

(2) The disclosure of the information at issue would cause significant competitive damage;

(3) The period during which the item must be withheld to avoid that damage; and

(4) How earlier disclosure would result in that damage.

(g) *Additional required information.* The following additional information is required to be submitted through the EPA database. NHTSA reserves the right to ask a manufacturer to provide additional information if necessary to verify the fuel consumption requirements of this regulation.

(1) *Small businesses.* For model years 2013 through 2020, vehicles and engines produced by small business manufacturers meeting the criteria in 13 CFR 121.201 are exempted from the requirements of this part. Qualifying small business manufacturers must notify EPA and NHTSA Administrators before importing or introducing into U.S. commerce exempted vehicles or engines. This notification must include a description of the manufacturer's qualification as a small business under 13 CFR 121.201. Manufacturers must submit this notification to EPA, and EPA will provide the notification to NHTSA. The agencies may review a

manufacturer's qualification as a small business manufacturer under 13 CFR 121.201.

(2) *Emergency vehicles.* For model years 2021 and later, emergency vehicles produced by heavy-duty pickup truck and van manufacturers are exempted except those produced by manufacturers voluntarily complying with standards in § 535.5(a). Manufacturers must notify the agencies in writing if using the provisions in § 535.5(a) to produce exempted emergency vehicles in a given model year, either in the report specified in 40 CFR 86.1865 or in a separate submission.

(3) *Early introduction.* The provision applies to manufacturers seeking to comply early with the NHTSA's fuel consumption program prior to model year 2014. The manufacturer must send the request to EPA before submitting its first application for a certificate of conformity.

(4) *NHTSA voluntary compliance model years.* Manufacturers must submit a statement declaring whether the manufacturer chooses to comply voluntarily with NHTSA's fuel consumption standards for model years 2014 through 2015. The manufacturers must acknowledge that once selected, the decision cannot be reversed and the manufacturer will continue to comply with the fuel consumption standards for subsequent model years. The manufacturer must send the statement to EPA before submitting its first application for a certificate of conformity.

(5) *Alternative engine standards.* Manufacturers choosing to comply with the alternative engine standards must notify EPA and NHTSA of their choice and include in that notification a demonstration that it has exhausted all available credits and credit opportunities. The manufacturer must send the statement to EPA before submitting its EOY report.

(6) *Alternate phase-in.* Manufacturers choosing to comply with the alternative engine phase-in must notify EPA and NHTSA of their choice. The manufacturer must send the statement to EPA before submitting its first application for a certificate of conformity.

(7) *Off-road exclusion (tractors and vocational vehicles only).* (i) Tractors and vocational vehicles primarily designed to perform work in off-road environments such as forests, oil fields, and construction sites may be exempted without request from the requirements of this regulation as specified in 49 CFR 523.2 and § 535.5(b). Within 90 days after the end of each model year,

manufacturers must send EPA and NHTSA through the EPA database a report with the following information:

(A) A description of each excluded vehicle configuration, including an explanation of why it qualifies for this exclusion.

(B) The number of vehicles excluded for each vehicle configuration.

(ii) A manufacturer having an off-road vehicle failing to meet the criteria under the agencies' off-road exclusions will be allowed to request an exclusion of such a vehicle from EPA and NHTSA. The approval will be granted through the certification process for the vehicle family and will be done in collaboration between EPA and NHTSA in accordance with the provisions in 40 CFR 1037.150, 1037.210, and 1037.631.

(8) *Vocational tractors*. Tractors intended to be used as vocational tractors may comply with vocational vehicle standards in § 535.5(b). Manufacturers classifying tractors as vocational tractors must provide a description of how they meet the qualifications in their applications for certificates of conformity as specified in 40 CFR 1037.205.

(9) *Approval of alternate methods to determine drag coefficients (tractors only)*. Manufacturers seeking to use alternative methods to determine aerodynamic drag coefficients must provide a request and gain approval by EPA in accordance with 40 CFR 1037.525. The manufacturer must send the request to EPA before submitting its first application for a certificate of conformity.

(10) *Innovative and off-cycle technology credits*. Manufacturers pursuing innovative and off-cycle technology credits must submit information to the agencies and may be subject to a public evaluation process in which the public would have opportunity for comment if the manufacturer is not using a test procedure in accordance with 40 CFR 1037.610(c). Whether the approach involves on-road testing, modeling, or some other analytical approach, the manufacturer would be required to present a final methodology to EPA and NHTSA. EPA and NHTSA would approve the methodology and credits only if certain criteria were met. Baseline emissions and fuel consumption and control emissions and fuel consumption would need to be clearly demonstrated over a wide range of real world driving conditions and over a sufficient number of vehicles to address issues of uncertainty with the data. Data would need to be on a vehicle model-specific basis unless a manufacturer demonstrated model-

specific data was not necessary. The agencies may publish a notice of availability in the **Federal Register** notifying the public of a manufacturer's proposed alternative off-cycle credit calculation methodology and provide opportunity for comment. Any notice will include details regarding the methodology, but not include any Confidential Business Information.

(11) *Credit trades*. If a manufacturer trades fuel consumption credits, it must send EPA and NHTSA a fuel consumption credit plan as specified in § 535.7(a) and provide the following additional information:

(i) As the seller, the manufacturer must include the following information:

(A) The corporate names of the buyer and any brokers.

(B) A copy of any contracts related to the trade.

(C) The averaging set corresponding to the engine families that generated fuel consumption credits for the trade, including the number of fuel consumption credits from each averaging set.

(ii) As the buyer, the manufacturer or entity must include the following information in its report:

(A) The corporate names of the seller and any brokers.

(B) A copy of any contracts related to the trade.

(C) How the manufacturer or entity intends to use the fuel consumption credits, including the number of fuel consumption credits it intends to apply for each averaging set.

(D) A copy of the contract with signatures from both the buyer and the seller.

(12) *Production reports*. Within 90 days after the end of the model year and no later than March 31st, manufacturers participating and not-participating in the ABT program must send to EPA and NHTSA a report including the total U.S.-directed production volume of vehicles it produced in each vehicle and engine family during the model year (based on information available at the time of the report) as required by 40 CFR 1036.250 and 1037.250. Trailer manufacturers must include a separate report including the total U.S.-directed production volume of excluded trailers as allowed by § 535.3(e). Each manufacturer shall report by vehicle or engine identification number and by configuration and identify the subfamily identifier. Report uncertified vehicles sold to secondary vehicle manufacturers. Small business manufacturers may omit reporting. Identify any differences between volumes included for EPA but excluded for NHTSA.

(13) *Transition to engine-based model years*. The following provisions apply for production and ABT reports during the transition to engine-based model year determinations for tractors and vocational vehicles in 2020 and 2021:

(i) If a manufacturer installs model year 2020 or earlier engines in the manufacturer's vehicles in calendar year 2020, include all those Phase 1 vehicles in its production and ABT reports related to model year 2020 compliance, although the agencies may require the manufacturer to identify these separately from vehicles produced in calendar year 2019.

(ii) If a manufacturer installs model year 2020 engines in its vehicles in calendar year 2021, submit production and ABT reports for those Phase 1 vehicles separate from the reports it submits for Phase 2 vehicles with model year 2021 engines.

(h) *Public information*. Based upon information submitted by manufacturers and EPA, NHTSA will publish fuel consumption standards and performance results.

(i) *Information received from EPA*. NHTSA will receive information from EPA as specified in 40 CFR 1036.755 and 1037.755.

(j) *Recordkeeping*. NHTSA has the same recordkeeping requirements as the EPA, specified in 40 CFR 86.1865–12(k), 1036.250, 1036.735, 1036.825, 1037.250, 1037.735, and 1037.825. The agencies each reserve the right to request information contained in reports separately.

(1) Manufacturers must organize and maintain records for NHTSA as described in this section. NHTSA in conjunction or separately from EPA may review a manufacturers records at any time.

(2) Keep the records required by this section for at least eight years after the due date for the end-of-year report. Manufacturers may not use fuel consumption credits for any engines if it does not keep all the records required under this section. Manufacturers must therefore keep these records to continue to bank valid credits. Store these records in any electronic format and on any media, as long as the manufacturer can promptly send the agencies organized records in English if the agencies ask for them. Manufacturers must keep these records readily available. NHTSA may review them at any time.

(3) Keep a copy of the reports required in § 535.8 and 40 CFR 1036.725, 1036.730, 1037.725 and 1037.730.

(4) Keep records of the vehicles and engine identification number (usually the serial number) for each vehicle and

engine produced that generates or uses fuel consumption credits under the ABT program. Manufacturers may identify these numbers as a range. If manufacturers change the FEL after the start of production, identify the date started using each FEL/FCL and the range of vehicles or engine identification numbers associated with each FEL/FCL. Manufacturers must also identify the purchaser and destination for each vehicle and engine produced to the extent this information is available.

(5) The agencies may require manufacturers to keep additional records or to send relevant information not required by this section in accordance with each agency's authority.

(6) If collected separately and NHTSA finds that information is provided fraudulent or grossly negligent or otherwise provided in bad faith, the manufacturer may be liable to civil penalties in accordance with each agency's authority.

#### **§ 535.9 Enforcement approach.**

(a) *Compliance.* (1) Each year NHTSA will assess compliance with fuel consumption standards as specified in § 535.10.

(i) NHTSA may conduct audits or verification testing prior to first sale throughout a given model year or after the model year in order to validate data received from manufacturers and will discuss any potential issues with EPA and the manufacturer. Audits may periodically be performed to confirm manufacturers credit balances or other credit transactions.

(ii) NHTSA may also conduct field inspections either at manufacturing plants or at new vehicle dealerships to validate data received from manufacturers. Field inspections will be carried out in order to validate the condition of vehicles, engines or technology prior to first commercial sale to verify each component's certified configuration as initially built. NHTSA reserves the right to conduct inspections at other locations but will target only those components for which a violation would apply to OEMs and not the fleets or vehicle owners. Compliance inspections could be carried out through a number of approaches including during safety inspections or during compliance safety testing.

(iii) NHTSA will conduct audits and inspections in the same manner and, when possible, in conjunction with EPA. NHTSA will also attempt to coordinate inspections with EPA and share results.

(iv) Documents collected under NHTSA safety authority may be used to

support fuel efficiency audits and inspections.

(2) At the end of each model year NHTSA will confirm a manufacturer's fleet or family performance values against the applicable standards and, if a manufacturer uses a credit flexibility, the amount of credits in each averaging set. The averaging set balance is based upon the engines or vehicles performance above or below the applicable regulatory subcategory standards in each respective averaging set and any credits that are traded into or out of an averaging set during the model year.

(i) If the balance is positive, the manufacturer is designated as having a credit surplus.

(ii) If the balance is negative, the manufacturer is designated as having a credit deficit.

(iii) NHTSA will provide notification to each manufacturer confirming its credit balance(s) after the end of each model year directly or through EPA.

(3) Manufacturer are required to confirm the negative balance and submit a fuel consumption credit plan as specified in § 535.7(a) along with supporting documentation indicating how it will allocate existing credits or earn (providing information on future vehicles, engines or technologies), and/or acquire credits, or else be liable for a civil penalty as determined in paragraph (b) of this section. The manufacturer must submit the information within 60 days of receiving agency notification.

(4) Credit shortfall within an averaging set may be carried forward only three years, and if not offset by earned or traded credits, the manufacturer may be liable for a civil penalty as described in paragraph (b) of this section.

(5) Credit allocation plans received from a manufacturer will be reviewed and approved by NHTSA. NHTSA will approve a credit allocation plan unless it determines that the proposed credits are unavailable or that it is unlikely that the plan will result in the manufacturer earning or acquiring sufficient credits to offset the subject credit shortfall. In the case where a manufacturer submits a plan to acquire future model year credits earned by another manufacturer, NHTSA will require a signed agreement by both manufacturers to initiate a review of the plan. If a plan is approved, NHTSA will revise the respective manufacturer's credit account accordingly by identifying which existing or traded credits are being used to address the credit shortfall, or by identifying the manufacturer's plan to earn future credits for addressing the

respective credit shortfall. If a plan is rejected, NHTSA will notify the respective manufacturer and request a revised plan. The manufacturer must submit a revised plan within 14 days of receiving agency notification. The agency will provide a manufacturer one opportunity to submit a revised credit allocation plan before it initiates civil penalty proceedings.

(6) For purposes of this regulation, NHTSA will treat the use of future credits for compliance, as through a credit allocation plan, as a deferral of civil penalties for non-compliance with an applicable fuel consumption standard.

(7) If NHTSA receives and approves a manufacturer's credit allocation plan to earn future credits within the following three model years in order to comply with regulatory obligations, NHTSA will defer levying civil penalties for non-compliance until the date(s) when the manufacturer's approved plan indicates that credits will be earned or acquired to achieve compliance, and upon receiving confirmed CO<sub>2</sub> emissions and fuel consumption data from EPA. If the manufacturer fails to acquire or earn sufficient credits by the plan dates, NHTSA will initiate civil penalty proceedings.

(8) In the event that NHTSA fails to receive or is unable to approve a plan for a non-compliant manufacturer due to insufficiency or untimeliness, NHTSA may initiate civil penalty proceedings.

(9) In the event that a manufacturer fails to report accurate fuel consumption data for vehicles or engines covered under this rule, noncompliance will be assumed until corrected by submission of the required data, and NHTSA may initiate civil penalty proceedings.

(10) If EPA suspends or revoke a certificate of conformity as specified in 40 CFR 1036.255 or 1037.255, and a manufacturer is unable to take a corrective action allowed by EPA, noncompliance will be assumed, and NHTSA may initiate civil penalty proceedings or revoke fuel consumption credits.

(b) *Civil penalties*—(1) *Generally.* NHTSA may assess a civil penalty for any violation of this part under 49 U.S.C. 32902(k). This section states the procedures for assessing civil penalties for violations of § 535.3(h). The provisions of 5 U.S.C. 554, 556, and 557 do not apply to any proceedings conducted pursuant to this section.

(2) *Initial determination of noncompliance.* An action for civil penalties is commenced by the execution of a Notice of Violation. A determination by NHTSA's Office of

Enforcement of noncompliance with applicable fuel consumption standards utilizing the certified and reported CO<sub>2</sub> emissions and fuel consumption data provided by the Environmental Protection Agency as described in this part, and after considering all the flexibilities available under § 535.7, underlies a Notice of Violation. If NHTSA Enforcement determines that a manufacturer's averaging set of vehicles or engines fails to comply with the applicable fuel consumption standard(s) by generating a credit shortfall, the incomplete vehicle, complete vehicle or engine manufacturer, as relevant, shall be subject to a civil penalty.

(3) *Numbers of violations and maximum civil penalties.* Any violation shall constitute a separate violation with respect to each vehicle or engine within the applicable regulatory averaging set. The maximum civil penalty is not more than \$37,500.00 per vehicle or engine. The maximum civil penalty under this section for a related series of violations shall be determined by multiplying \$37,500.00 times the vehicle or engine production volume for the model year in question within the regulatory averaging set. NHTSA may adjust this civil penalty amount to account for inflation.

(4) *Factors for determining penalty amount.* In determining the amount of any civil penalty proposed to be assessed or assessed under this section, NHTSA shall take into account the gravity of the violation, the size of the violator's business, the violator's history of compliance with applicable fuel consumption standards, the actual fuel consumption performance related to the applicable standards, the estimated cost to comply with the regulation and applicable standards, the quantity of vehicles or engines not complying, and the effect of the penalty on the violator's ability to continue in business. The "estimated cost to comply with the regulation and applicable standards," will be used to ensure that penalties for non-compliance will not be less than the cost of compliance.

(5) *NHTSA enforcement report of determination of non-compliance.* (i) If NHTSA Enforcement determines that a violation has occurred, NHTSA Enforcement may prepare a report and send the report to the NHTSA Chief Counsel.

(ii) The NHTSA Chief Counsel will review the report prepared by NHTSA Enforcement to determine if there is sufficient information to establish a likely violation.

(iii) If the Chief Counsel determines that a violation has likely occurred, the

Chief Counsel may issue a Notice of Violation to the party.

(iv) If the Chief Counsel issues a Notice of Violation, he or she will prepare a case file with recommended actions. A record of any prior violations by the same party shall be forwarded with the case file.

(6) *Notice of violation.* (i) The Notice of Violation will contain the following information:

(A) The name and address of the party;

(B) The alleged violation(s) and the applicable fuel consumption standard(s) violated;

(C) The amount of the proposed penalty and basis for that amount;

(D) The place to which, and the manner in which, payment is to be made;

(E) A statement that the party may decline the Notice of Violation and that if the Notice of Violation is declined within 30 days of the date shown on the Notice of Violation, the party has the right to a hearing, if requested within 30 days of the date shown on the Notice of Violation, prior to a final assessment of a penalty by a Hearing Officer; and

(F) A statement that failure to either pay the proposed penalty or to decline the Notice of Violation and request a hearing within 30 days of the date shown on the Notice of Violation will result in a finding of violation by default and that NHTSA will proceed with the civil penalty in the amount proposed on the Notice of Violation without processing the violation under the hearing procedures set forth in this subpart.

(ii) The Notice of Violation may be delivered to the party by—

(A) Mailing to the party (certified mail is not required);

(B) Use of an overnight or express courier service; or

(C) Facsimile transmission or electronic mail (with or without attachments) to the party or an employee of the party.

(iii) At any time after the Notice of Violation is issued, NHTSA and the party may agree to reach a compromise on the payment amount.

(iv) Once a penalty amount is paid in full, a finding of "resolved with payment" will be entered into the case file.

(v) If the party agrees to pay the proposed penalty, but has not made payment within 30 days of the date shown on the Notice of Violation, NHTSA will enter a finding of violation by default in the matter and NHTSA will proceed with the civil penalty in the amount proposed on the Notice of Violation without processing the

violation under the hearing procedures set forth in this subpart.

(vi) If within 30 days of the date shown on the Notice of Violation a party fails to pay the proposed penalty on the Notice of Violation, and fails to request a hearing, then NHTSA will enter a finding of violation by default in the case file, and will assess the civil penalty in the amount set forth on the Notice of Violation without processing the violation under the hearing procedures set forth in this subpart.

(vii) NHTSA's order assessing the civil penalty following a party's default is a final agency action.

(7) *Hearing Officer.* (i) If a party timely requests a hearing after receiving a Notice of Violation, a Hearing Officer shall hear the case.

(ii) The Hearing Officer will be appointed by the NHTSA Administrator, and is solely responsible for the case referred to him or her. The Hearing Officer shall have no other responsibility, direct or supervisory, for the investigation of cases referred for the assessment of civil penalties. The Hearing Officer shall have no duties related to the light-duty fuel economy or medium- and heavy-duty fuel efficiency programs.

(iii) The Hearing Officer decides each case on the basis of the information before him or her.

(8) *Initiation of action before the Hearing Officer.* (i) After the Hearing Officer receives the case file from the Chief Counsel, the Hearing Officer notifies the party in writing of—

(A) The date, time, and location of the hearing and whether the hearing will be conducted telephonically or at the DOT Headquarters building in Washington, DC;

(B) The right to be represented at all stages of the proceeding by counsel as set forth in paragraph (b)(9) of this section; and

(C) The right to a free copy of all written evidence in the case file.

(ii) On the request of a party, or at the Hearing Officer's direction, multiple proceedings may be consolidated if at any time it appears that such consolidation is necessary or desirable.

(9) *Counsel.* A party has the right to be represented at all stages of the proceeding by counsel. A party electing to be represented by counsel must notify the Hearing Officer of this election in writing, after which point the Hearing Officer will direct all further communications to that counsel. A party represented by counsel bears all of its own attorneys' fees and costs.

(10) *Hearing location and costs.* (i) Unless the party requests a hearing at which the party appears before the



Hearing Officer in Washington, DC, the hearing may be held telephonically. In Washington, DC, the hearing is held at the headquarters of the U.S. Department of Transportation.

(ii) The Hearing Officer may transfer a case to another Hearing Officer at a party's request or at the Hearing Officer's direction.

(iii) A party is responsible for all fees and costs (including attorneys' fees and costs, and costs that may be associated with travel or accommodations) associated with attending a hearing.

(11) *Hearing procedures.* (i) There is no right to discovery in any proceedings conducted pursuant to this subpart.

(ii) The material in the case file pertinent to the issues to be determined by the Hearing Officer is presented by the Chief Counsel or his or her designee.

(iii) The Chief Counsel may supplement the case file with information prior to the hearing. A copy of such information will be provided to the party no later than three business days before the hearing.

(iv) At the close of the Chief Counsel's presentation of evidence, the party has the right to examine, respond to and rebut material in the case file and other information presented by the Chief Counsel. In the case of witness testimony, both parties have the right of cross-examination.

(v) In receiving evidence, the Hearing Officer is not bound by strict rules of evidence. In evaluating the evidence presented, the Hearing Officer must give due consideration to the reliability and relevance of each item of evidence.

(vi) At the close of the party's presentation of evidence, the Hearing Officer may allow the introduction of rebuttal evidence that may be presented by the Chief Counsel.

(vii) The Hearing Officer may allow the party to respond to any rebuttal evidence submitted.

(viii) After the evidence in the case has been presented, the Chief Counsel and the party may present arguments on the issues in the case. The party may also request an opportunity to submit a written statement for consideration by the Hearing Officer and for further review. If granted, the Hearing Officer shall allow a reasonable time for submission of the statement and shall specify the date by which it must be received. If the statement is not received within the time prescribed, or within the limits of any extension of time granted by the Hearing Officer, it need not be considered by the Hearing Officer.

(ix) A verbatim transcript of the hearing will not normally be prepared. A party may, solely at its own expense,

cause a verbatim transcript to be made. If a verbatim transcript is made, the party shall submit two copies to the Hearing Officer not later than 15 days after the hearing. The Hearing Officer shall include such transcript in the record.

(12) *Determination of violations and assessment of civil penalties.* (i) Not later than 30 days following the close of the hearing, the Hearing Officer shall issue a written decision on the Notice of Violation, based on the hearing record. This may be extended by the Hearing officer if the submissions by the Chief Counsel or the party are voluminous. The decision shall address each alleged violation, and may do so collectively. For each alleged violation, the decision shall find a violation or no violation and provide a basis for the finding. The decision shall set forth the basis for the Hearing Officer's assessment of a civil penalty, or decision not to assess a civil penalty. In determining the amount of the civil penalty, the gravity of the violation, the size of the violator's business, the violator's history of compliance with applicable fuel consumption standards, the actual fuel consumption performance related to the applicable standard, the estimated cost to comply with the regulation and applicable standard, the quantity of vehicles or engines not complying, and the effect of the penalty on the violator's ability to continue in business. The assessment of a civil penalty by the Hearing Officer shall be set forth in an accompanying final order. The Hearing Officer's written final order is a final agency action.

(ii) If the Hearing Officer assesses civil penalties in excess of \$1,000,000, the Hearing Officer's decision shall contain a statement advising the party of the right to an administrative appeal to the Administrator within a specified period of time. The party is advised that failure to submit an appeal within the prescribed time will bar its consideration and that failure to appeal on the basis of a particular issue will constitute a waiver of that issue in its appeal before the Administrator.

(iii) The filing of a timely and complete appeal to the Administrator of a Hearing Officer's order assessing a civil penalty shall suspend the operation of the Hearing Officer's penalty, which shall no longer be a final agency action.

(iv) There shall be no administrative appeals of civil penalties assessed by a Hearing Officer of less than \$1,000,000.

(13) *Appeals of civil penalties in excess of \$1,000,000.* (i) A party may appeal the Hearing Officer's order assessing civil penalties over \$1,000,000

to the Administrator within 21 days of the date of the issuance of the Hearing Officer's order.

(ii) The Administrator will review the decision of the Hearing Officer de novo, and may affirm the decision of the hearing officer and assess a civil penalty, or

(iii) The Administrator may—

(A) Modify a civil penalty; (B) Rescind the Notice of Violation; or (C) Remand the case back to the Hearing Officer for new or additional proceedings.

(iv) In the absence of a remand, the decision of the Administrator in an appeal is a final agency action.

(14) *Collection of assessed or compromised civil penalties.* (i) Payment of a civil penalty, whether assessed or compromised, shall be made by check, postal money order, or electronic transfer of funds, as provided in instructions by the agency. A payment of civil penalties shall not be considered a request for a hearing.

(ii) The party must remit payment of any assessed civil penalty to NHTSA within 30 days after receipt of the Hearing Officer's order assessing civil penalties, or, in the case of an appeal to the Administrator, within 30 days after receipt of the Administrator's decision on the appeal.

(iii) The party must remit payment of any compromised civil penalty to NHTSA on the date and under such terms and conditions as agreed to by the party and NHTSA. Failure to pay may result in NHTSA entering a finding of violation by default and assessing a civil penalty in the amount proposed in the Notice of Violation without processing the violation under the hearing procedures set forth in this part.

(c) *Changes in corporate ownership and control.* Manufacturers must inform NHTSA of corporate relationship changes to ensure that credit accounts are identified correctly and credits are assigned and allocated properly.

(1) In general, if two manufacturers merge in any way, they must inform NHTSA how they plan to merge their credit accounts. NHTSA will subsequently assess corporate fuel consumption and compliance status of the merged fleet instead of the original separate fleets.

(2) If a manufacturer divides or divests itself of a portion of its automobile manufacturing business, it must inform NHTSA how it plans to divide the manufacturer's credit holdings into two or more accounts. NHTSA will subsequently distribute holdings as directed by the manufacturer, subject to provision for



reasonably anticipated compliance obligations.

(3) If a manufacturer is a successor to another manufacturer's business, it must inform NHTSA how it plans to allocate credits and resolve liabilities per 49 CFR part 534.

**§ 535.10 How do manufacturers comply with fuel consumption standards?**

(a) *Pre-certification process.* (1) Regulated manufacturers determine eligibility to use exemptions or exclusions in accordance with § 535.3.

(2) Manufacturers may seek preliminary approvals as specified in 40 CFR 1036.210 and 40 CFR 1037.210 from EPA and NHTSA, if needed. Manufacturers may request to schedule pre-certification meetings with EPA and NHTSA prior to submitting approval requests for certificates of conformity to address any joint compliance issues and gain informal feedback from the agencies.

(3) The requirements and prohibitions required by EPA in special circumstances in accordance with 40 CFR 1037.601 and 40 CFR part 1068 apply to manufacturers for the purpose of complying with fuel consumption standards. Manufacturers should use good judgment when determining how EPA requirements apply in complying with the NHTSA program. Manufacturers may contact NHTSA and EPA for clarification about how these requirements apply to them.

(4) In circumstances in which EPA provides multiple compliance approaches manufacturers must choose the same compliance path to comply with NHTSA's fuel consumption standards that they choose to comply with EPA's greenhouse gas emission standards.

(5) Manufacturers may not introduce new vehicles into commerce without a certificate of conformity from EPA. Manufacturers must attest to several compliance standards in order to obtain a certificate of conformity. This includes stating comparable fuel consumption results for all required CO<sub>2</sub> emissions rates. Manufacturers not completing these steps do not comply with the NHTSA fuel consumption standards.

(6) Manufacturers apply the fuel consumption standards specified in § 535.5 to vehicles, engines and components that represent production units and components for vehicle and engine families, sub-families and configurations consistent with the EPA specifications in 40 CFR 86.1819, 1036.230, and 1037.230.

(7) Only certain vehicles and engines are allowed to comply differently between the NHTSA and EPA programs

as detailed in this section. These vehicles and engines must be identified by manufacturers in the ABT and production reports required in § 535.8.

(b) *Model year compliance.* Manufacturers are required to conduct testing to demonstrate compliance with CO<sub>2</sub> exhaust emissions standards in accordance with EPA's provisions in 40 CFR part 600, subpart B, 40 CFR 1036, subpart F, 40 CFR part 1037, subpart R, and 40 CFR part 1066. Manufacturers determine equivalent fuel consumption performance values for CO<sub>2</sub> results as specified in § 535.6 and demonstrate compliance by comparing equivalent results to the applicable fuel consumption standards in § 535.5.

(c) *End-of-the-year process.* Manufacturers comply with fuel consumption standards after the end of each model year, if—

(1) For heavy-duty pickup trucks and vans, the manufacturer's fleet average performance, as determined in § 535.6, is less than the fleet average standard; or

(2) For truck tractors, vocational vehicles, engines and box trailers the manufacturer's fuel consumption performance for each vehicle or engine family (or sub-family), as determined in § 535.6, is lower than the applicable regulatory subcategory standards in § 535.5.

(3) For non-box and non-aero trailers, a manufacturer is considered in compliance with fuel consumption standards if all trailers meet the specified standards in § 535.5(e)(1)(i).

(4) NHTSA will use the EPA final verified values as specified in 40 CFR 86.1819, 40 CFR 1036.755, and 1037.755 for making final determinations on whether vehicles and engines comply with fuel consumption standards.

(5) A manufacturer fails to comply with fuel consumption standards if its final reports are not provided in accordance with § 535.8 and 40 CFR 86.1865, 1036.730, and 1037.730. Manufacturers not providing complete or accurate final reports or any plans by the required deadlines do not comply with fuel consumption standards. A manufacturer that is unable to provide any emissions results along with comparable fuel consumption values must obtain permission for EPA to exclude the results prior to the deadline for submitting final reports.

(6) A manufacturer that would otherwise fail to directly comply with fuel consumption standards as described in paragraphs (c)(1) through (3) of this section may use one or more of the credit flexibilities provided under the NHTSA averaging, banking and trading program, as specified in § 535.7,

but must offset all credit deficits in its averaging sets to achieve compliance.

(7) A manufacturer failing to comply with the provisions specified in this part may be liable to pay civil penalties in accordance with § 535.9.

(8) A manufacturer may also be liable to pay civil penalties if found by EPA or NHTSA to have provided false information as identified through NHTSA or EPA enforcement audits or new vehicle verification testing as specified in § 535.9 and 40 CFR parts 86, 1036, and 1037.

**PART 538—MANUFACTURING INCENTIVES FOR ALTERNATIVE FUEL VEHICLES**

■ 382. Revise the authority citation for part 538 to read as follows:

**Authority:** 49 U.S.C. 32901, 32905, and 32906; delegation of authority at 49 CFR 1.95.

■ 383. Revise § 538.5 to read as follows:

**§ 538.5 Minimum driving range.**

(a) The minimum driving range that a passenger automobile must have in order to be treated as a dual fueled automobile pursuant to 49 U.S.C. 32901(c) is 200 miles when operating on its nominal useable fuel tank capacity of the alternative fuel, except when the alternative fuel is electricity or compressed natural gas. Beginning model year 2016, a natural gas passenger automobile must have a minimum driving range of 150 miles when operating on its nominal useable fuel tank capacity of the alternative fuel to be treated as a dual fueled automobile, pursuant to 49 U.S.C. 32901(c)(2).

(b) The minimum driving range that a passenger automobile using electricity as an alternative fuel must have in order to be treated as a dual fueled automobile pursuant to 49 U.S.C. 32901(c) is 7.5 miles on its nominal storage capacity of electricity when operated on the EPA urban test cycle and 10.2 miles on its nominal storage capacity of electricity when operated on the EPA highway test cycle.

Dated: August 16, 2016.

**Anthony Foxx,**  
Secretary, Department of Transportation.

Dated: August 16, 2016.

**Gina McCarthy,**  
Administrator, Environmental Protection Agency.

[FR Doc. 2016-21203 Filed 10-24-16; 8:45 am]

**BILLING CODE 6560-50-P**