

**RIO BEND SPECIFIC PLAN
AMENDMENT**

Prepared for:

Imperial County Department of Planning/Building
939 Main Street
El Centro, California 92243

Prepared by:

Mooney & Associates
9903 Businesspark Avenue
San Diego, California 92131

August 2001

RECEIVED

FEB 11 2002

IMPERIAL COUNTY
PLANNING, BUILDING

TABLE OF CONTENTS

<u>Section</u>	<u>Page</u>
<u>EXPLANATION OF AMENDED SPECIFIC PLAN</u>	I-1
I. INTRODUCTION	I-2
A. Purpose of Specific Plan	I-2
B. Issues Addressed in Specific Plan	I-2
C. Overview of Project	I-3
D. Background	I-3
E. Adoption of Specific Plan	I-4
II. PROJECT LOCATION AND EXISTING SETTING	II-1
A. Project Location	II-1
B. Project Setting	II-1
III. PROJECT DESCRIPTION	III-1
A. Goals and Objectives	III-1
B. Design Principles	III-3
C. Land Uses	III-4
IV. DEVELOPMENT STANDARDS AND MITIGATION	IV-1
MEASURES	IV-1
A. Development Standards	IV-1
B. Project Conformance With EIR Mitigation Measures	IV-2
V. PROJECT CONSISTENCY WITH GENERAL PLAN	V-1
A. Relationship With General Plan	V-1
B. Agriculture	V-1
C. Circulation and Scenic Highway	V-3
D. Conservation & Open Space	V-3
E. Geothermal Transmission	V-6
F. Land Use	V-6
G. Housing	V-8
H. Noise	V-9
I. Seismic & Public Safety	V-9
J. Water	V-10
VI. IMPLEMENTATION	VI-1
A. Administration/Enforcement/Amendments	VI-1

Appendices

A - LEGAL DESCRIPTION

B - GENERAL PLAN AMENDMENT

C- TITLE 9 SECTION 90505

LIST OF FIGURES

<u>No.</u>	<u>Name</u>	<u>Page</u>
1	Regional Location Map	II-2
2	Vicinity Map	II-3
3	Site Plan	II-4
4	Land Use Plan	III-5

LIST OF TABLES

<u>No.</u>	<u>Name</u>	<u>Page</u>
1	Land Use	III-6

EXPLANATION OF AMENDED SPECIFIC PLAN

This revision proposes certain limited changes to the original project and the approved Rio Bend Specific Plan. The original project and General Plan Amendments were approved in 1984 for a RV Resort. The RV Resort was approved for 1,400 spaces and initially 206 were developed. A 9-hole golf course was also constructed adjacent to the New River in the western portion of the site. In 1992, the project plans were changed to expand overall project acreage and include a new mobile home park, single family residential, and commercial land uses.

In 1992, the site consisted of the Rio Bend RV Ranch and the Lakeview Golf Course. The 1992 approved Specific Plan outlined a phased development with varying land uses. Phase I consisted of adding a Mobile Home Park and an additional RV space area along with necessary infrastructure improvements. Phase II was to consist of a 165-lot single-family residential subdivision, two commercial areas, recreation open space, and any necessary infrastructure improvements. Phase I was developed in 1993 and included a 68-space Mobile Home Park and 23 additional RV spaces.

This Specific Plan Amendment shall modify the Rio Bend Specific Plan project. The amendment is in response to the alteration in Phase 2 of the original project. This Specific Plan Amendment includes altering Phase 2 to include only "Additional RV Spaces." An additional 674 RV spaces, on approximately 38 acres, are planned in the Specific Plan Amendment. The total available RV spaces at Rio Bend will total 900, which is similar to the original project approved in 1984.

I. INTRODUCTION

A. Purpose of Specific Plan

The purpose of the Rio Bend Specific Plan is to provide a comprehensive set of land use plans, regulations, guidelines and implementation programs to insure the appropriate development of the project site in conformance with the Imperial County General Plan. The Specific Plan was prepared in recognition of the desirability of creating the project specific regulations needed to develop the variety of land uses on the unique project site.

The preparation of this Specific Plan was initiated by the property owner/developer with the encouragement and agreement of the Imperial County Planning Department that a specific plan would assure a comprehensive approach to the development of the project site. This project is particularly suited for the specific planning process because of the several unique characteristics of the project site.

A total of 674 additional RV spaces is proposed to be added to the existing RV park, mobile home park, and 9-hole golf course. The unique characteristics of the site include the existing Recreation land use designation with the existing RV park, mobile home park and golf course land uses; the existing drinking water supply and sewage disposal infrastructure; the excellent road access; and the natural buffer areas between the project site and adjacent agricultural areas created by the New River open space.

B. Issues Addressed in Specific Plan

Development of the proposed land uses on the project site requires that a wide variety of development and conservation issues be addressed. The issues include:

- integrating the variety of existing and proposed residential and recreational land uses;
- minimizing the impacts of development to agriculture;
- providing public services to the residents and guests of the project;
- maximizing the use and enjoyment of the existing recreation and view amenities;
- providing safe and adequate access for both private and emergency vehicles;
- protecting the existing and future guests and residents from health hazards associated with the New River;

C. Overview of Project

The Rio Bend Specific Plan Amendment is a proposed mixed-use development of a 110.4 acre site containing the Rio Bend RV Resort Ranch, Storm's Crossing Mobile Home Park and the 9-hole Lakeview Golf Course. Certification of an addendum to the environmental impact report and adoption of this specific plan amendment, will authorize development of the site in conformance with the requirements of this specific plan, Imperial County, and the State of California.

The project site is located in the southwestern portion of Imperial County, approximately 7 miles west of the incorporated city of El Centro and one and one half miles south of the unincorporated community of Seeley. Primary access to the site is from Interstate 8 via Drew Road. A legal description of the project site is included in Appendix A.

The project site is bordered on the south and west by the New River. The designation in the 1996 Imperial County General Plan is "Recreation/Open Space" and the site is zoned "S1-Open Space/Recreational" and "SPA-Specific Plan Area." The adjacent property is designated as Agriculture and also zoned A-2 General Agricultural and A-3 Heavy Agricultural.

The Rio Bend project proposes to expand the existing 229-space Rio Bend RV Resort Ranch, the 9-hole Lakeview Golf Course, and the 68-space mobile home park, to include an additional 674 additional RV spaces.

Implementation of the Rio Bend Specific Plan Amendment does not require changes to existing land use designation or zoning.

D. Background

On May 8, 1984, the Imperial County Board of Supervisors unanimously certified the Rio Bend RV Resort Ranch Environmental Impact Report (EIR) and adopted findings of fact for the Rio Bend RV Resort Ranch, approved a General Plan Amendment changing the land use designation from General Agriculture to Recreation, and adopted Ordinance No. 866 changing the zone from A-2 General Agricultural and A-3 Heavy Agricultural to F Recreation. A majority of the proposed project site is included within the boundaries of the Rio Bend RV Resort Ranch project approved in 1984. The General Plan Amendment and Ordinance No. 866 are included in Appendix B and C.

The Final Environmental Impact Report for the Rio Bend RV Resort Ranch (Graves Engineering 1984) describes the development of up to 1,400 RV units on the project site. Issues analyzed in the 1984 EIR included Land Use, Water Quality/Public Health, Public Services, Hydrology, Soils, Biology, and Air Quality. All environmental impacts were found to be mitigated.

The subsequent EIR and the Rio Bend Specific Plan approved in 1992 was necessitated by the proposal to add area to the project that was not included within the area previously reviewed, and add the new mobile home park, single family residential, and commercial land uses, rather than implement the already approved 1,194 additional RV spaces on the original site.

E. Adoption of Specific Plan

Specific Plans are defined by California Government Code - Title 7, Chapter 3, Article 8, Section 65450 et seq. The purpose of a specific plan is to accomplish "the systematic implementation of the general plan" by bringing together detailed development standards and regulations to regulate the development of a specific area.

Adoption of the Rio Bend Specific Plan will include both this text, which establishes conformance of the project with existing plans, policies and ordinances, and a Land Use Plan, which graphically identifies the various land use areas. The Rio Bend Specific Plan is regulatory in nature and shall be enacted by ordinance. Existing regulations and ordinances that are in conflict with the Specific Plan shall be modified or amended to be compatible with the Specific Plan.

In the event that any regulation, condition, program or portion of this specific plan is held invalid or unconstitutional by a California or Federal Court of competent jurisdiction, such portions shall be deemed separate, distinct and independent provisions, and the invalidity of such provisions shall not affect the validity of the remaining provisions.

II. PROJECT LOCATION AND EXISTING SETTING

A. Project Location

The project site is located in the unincorporated southwestern portion of Imperial County, approximately 7 miles west of the incorporated city of El Centro and one and one half miles south of the unincorporated community of Seeley. More specifically, the project site is located west of Drew Road, approximately 1,000 feet south of Interstate 8 (I-8) and abuts the New River at the western and southern boundary of the site.

The Rio Bend project site contains 110.4 acres. The boundaries of the site are Drew Road to the east, Elder Canal drain to the north, and the New River to the west and south. The project site includes the existing Rio Bend RV Resort Ranch, Storm's Crossing Mobile Home Park and Lakeview Golf Course. Access to the existing and proposed land uses is from Drew Road. A Regional Location Map and Vicinity Map are shown in Figures 1 and 2.

B. Project Setting

1. Site Description

The easterly 65.7 acres of the 110.4 acre site are relatively level. The Rio Bend RV Resort Ranch, which includes the 3-acre Rio Bend Lake, occupies about 23.3 of the easterly 65.7 acres. Storm's Crossing Mobile Home Park and the water treatment plant occupy an additional 9.6 acres in the easterly portion of the site. A 32.8 acre portion of the Additional RV spaces will occupy the remainder of the easterly level portion of the site. The remaining 44.7 acres of the site are approximately 25 feet lower in elevation and located adjacent to the New River in the western portion of the site. The remaining 4.4 acre portion of the Additional RV Spaces will be located in the lower western portion of the site. The Lakeview Golf Course, which includes the 10 acres of Drew Lake, occupies 37.1 acres of this lower terrace of the site. The remaining 3.2 acres of the lower terrace is Preservation Open Space.

Almost the entire site has been disturbed due to past or current activities associated with development of the RV Resort Ranch and Golf Course, agricultural production, Storm's Crossing Mobile Home Park, or storage of materials associated with these activities and uses. The Site Plan is shown in Figure 3.

2. Surrounding Land Uses

This area of Imperial County can be characterized as primarily agricultural, interspersed with several incorporated cities, several unincorporated communities, and a variety of isolated recreational, open space, industrial and governmental land uses. The predominant land use in the area surrounding the project site is agricultural, however, the land uses immediately adjacent to project site include rural residential to the east across Drew Road and preservation open space to the south and west.

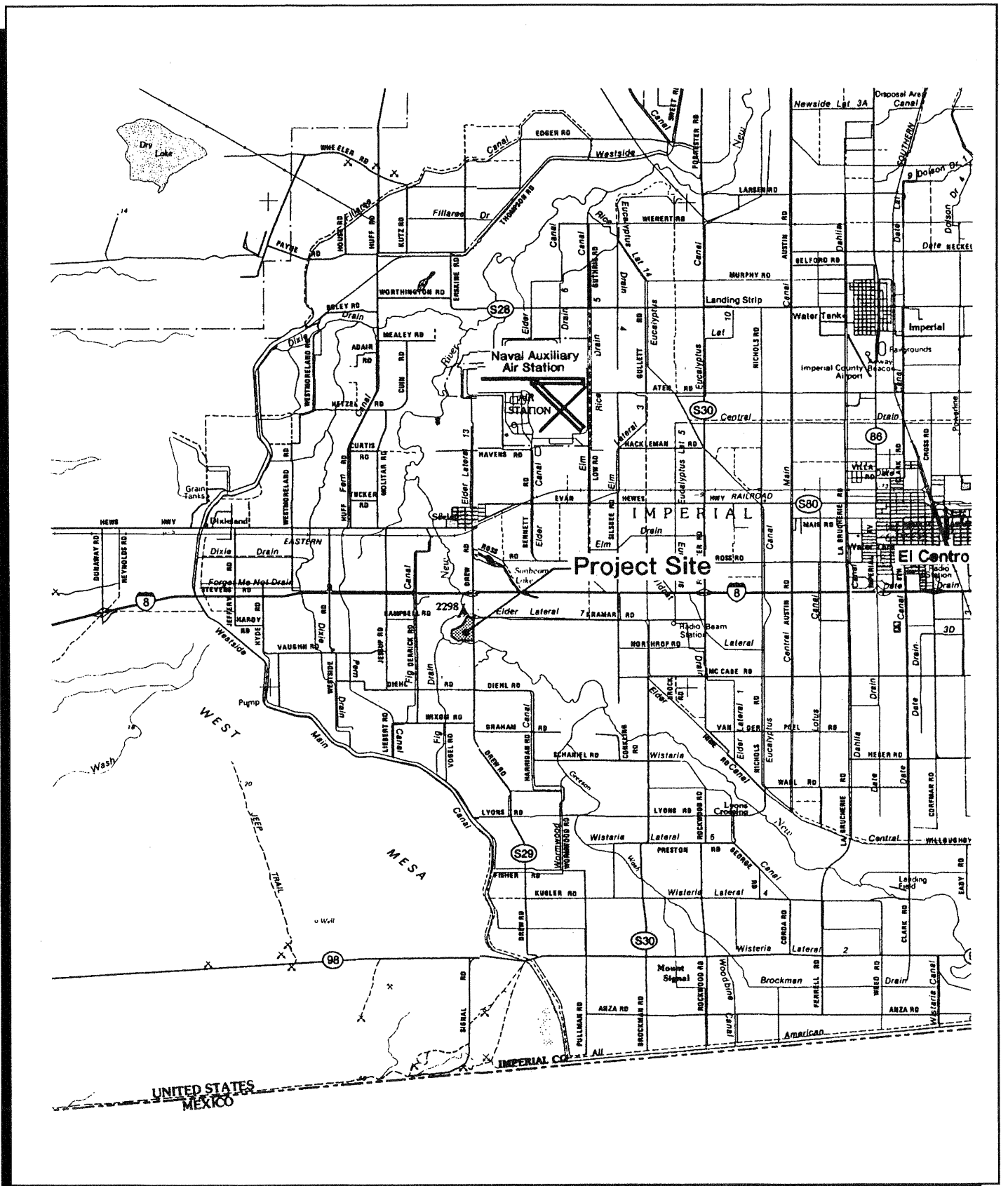

SOURCE: DeLorme Atlas



0 1 2 miles

Regional Location Map
Figure 1

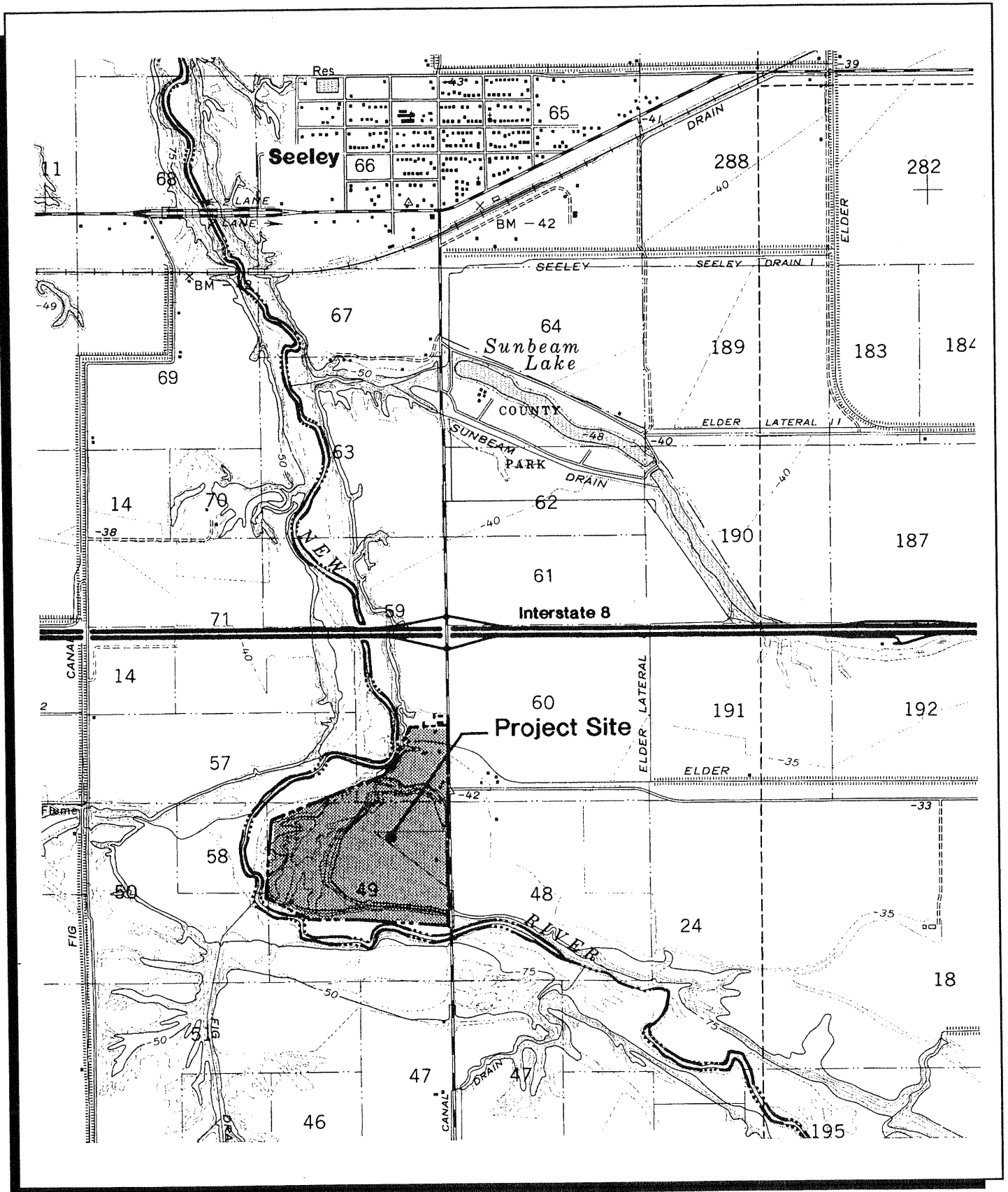

SOURCE: USGS 7.5' Quad - Seeley, CA

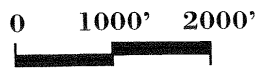
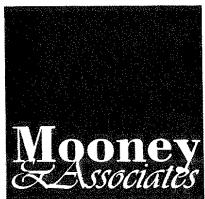

Vicinity Map
Figure 2

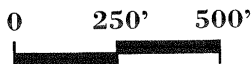
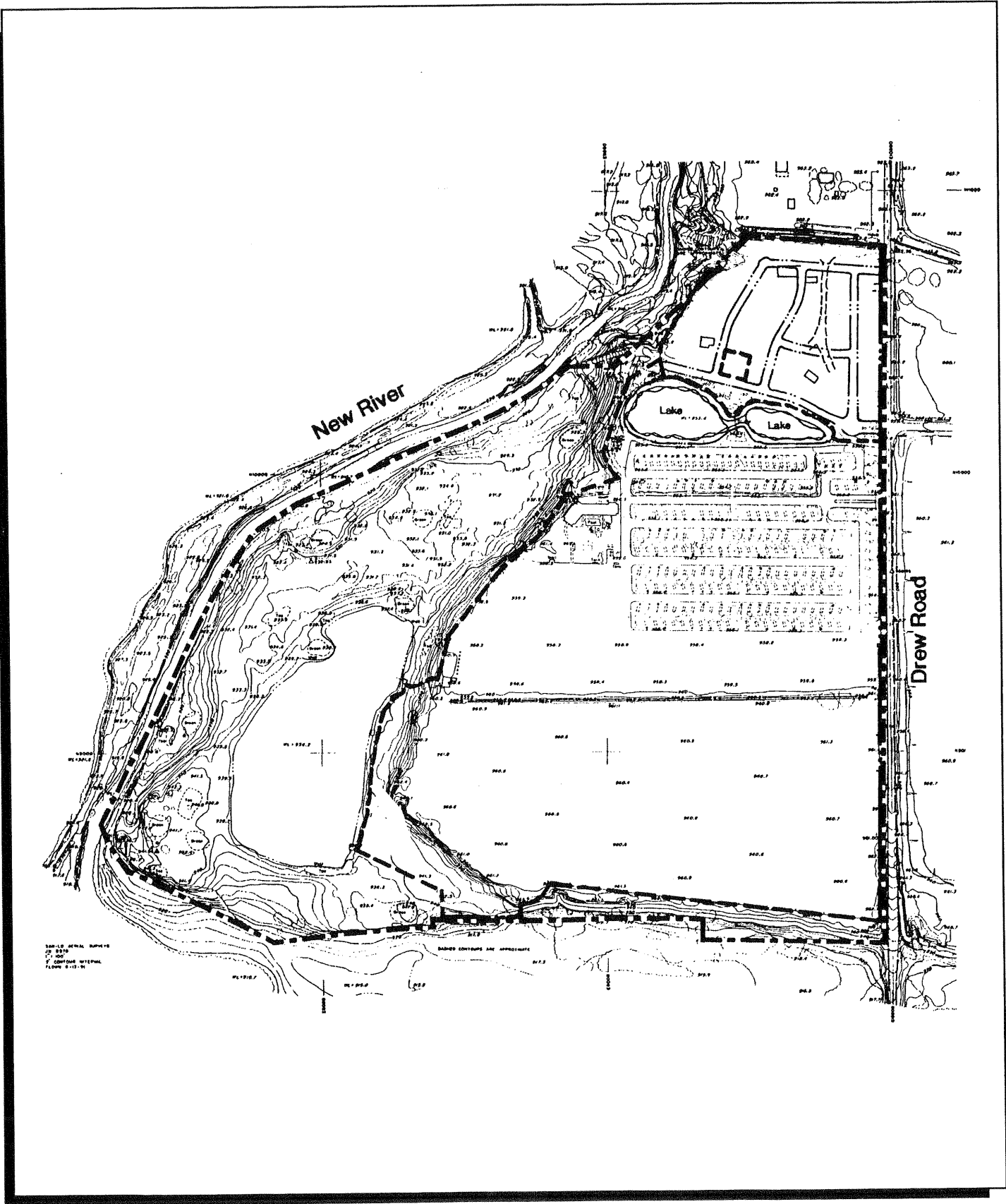

Site Plan
Figure 3

The nearest unincorporated community is Seeley, located approximately one and one half miles to the north. Interstate 8 is located approximately 1,000 feet to the north.

Drew Road creates the easterly boundary of the site. It is currently a two lane paved road with graded shoulders. The Circulation Element designates Drew Road as a Minor Arterial with an 84-foot right of way. A 230 kv electrical transmission line runs along the westerly side of Drew Road south of Kramer Road.

The land use on the east side of Drew Road is rural residential and agricultural. The property is currently in alfalfa production and also contains a single family residence.

The westerly terminus and drain of the Elder Canal creates the northerly boundary of the site. Elder Canal flows from east to west as it passes under Drew Road. The canal improvements end immediately west of Drew Road. Excess water is allowed to drain westerly to the New River in an unimproved channel. The land use north of the canal is a hay compaction and distribution facility.

The New River creates the westerly and southerly boundary of the project site. The New River makes a sharp turn which created a wide channel in the vicinity of the project site during the flood of 1903-1905. An impoundment area encompassing approximately 80 acres has been created by the Imperial Irrigation District in a portion of the wide river channel. The purpose of this impoundment, known as Fig Lagoon, is to increase the surface area of irrigation runoff to maximize evaporation of the runoff prior to draining into the Salton Sea via the New River. The remaining riverine area is open space. The land use beyond the riverine open space to both the west and south is agricultural.

3. Infrastructure

a. Transportation

Regional access to Rio Bend is provided from Interstate 8 via Drew Road. Direct access to the Rio Bend project site will be taken from several points along Drew Road. Drew Road is designated as a Minor Arterial on the Circulation Element and is maintained by the County. Kramer Road terminates at Drew Road approximately 600 feet south of the northeastern corner of the site. Kramer Road is designated as a Minor Arterial on the Circulation Element and is maintained by the County.

Access to the existing Rio Bend RV Resort Ranch is currently taken from a divided driveway located 270 feet south of Kramer Road. Access to the Storm's Crossing Mobile Home Park located in the north portion of the project site is taken from a driveway located opposite Kramer Road.

b. Water Supply

The Rio Bend project site is located within the Imperial Irrigation District (IID). The IID provides untreated irrigation water obtained from the Colorado River to the entire Imperial Valley.

The water supply for the Rio Bend RV Resort Ranch is provided by the IID via the Elder Canal. Irrigation water that would otherwise drain unused into the New River is diverted into Rio Bend Lake. Untreated water is stored in the lake for use as both untreated irrigation water and to supply water for the water treatment facility. The untreated water stored in Rio Bend Lake also serves as water storage for fire protection.

Drinking water for the Rio Bend RV Resort Ranch is provided by an on-site treatment facility that treats irrigation water stored in the 3-acre Rio Bend Lake. The existing treatment facility is capable of treating 75,000 gallons per day and has storage capacity of 130,000 gallons.

The overflow from Rio Bend Lake is further diverted into Drew Lake. This lake is 10 acres in surface area and is located within the Lakeview Golf Course. The untreated water in Drew Lake is used to irrigate the golf course. Overflow from Drew Lake finally drains into the New River.

c. Sewage Treatment

Sewage generated by Rio Bend RV Resort Ranch and Storm's Crossing Mobile Home Park is treated through two on-site subsurface disposal systems composed of multiple septic tanks and leach lines. A waste discharge permit, pursuant to Board Order No. 85-051, has been obtained from the Regional Water Quality Control Board to discharge up to 88,000 gallons per day.

d. Schools

Rio Bend is located within the Seeley School District which provides elementary and middle school educational services for students in grades K - 8. Current enrollment is 520 students. The elementary school is located in Seeley and, including two relocatable classrooms, has facilities for 600 students.

The Central Union High School District provides educational services for the Rio Bend project site. The District serves grades 9-12 as well as adult education. A new high school, Southwest, opened in 1993-1994, and would serve the Rio Bend project. Current enrollment is 1,743 students with a capacity of 2,100 students.

e. Solid Waste Disposal

Solid waste generated at Rio Bend is collected by private contract and transported to any of several landfill sites. The nearest landfill site is located in Calexico and has 2.9 million cubic yards of capacity available and is anticipated to operate until 2014. Approximately 8 pounds per capita of solid waste per day is generated by the existing land uses on the project site.

f. Emergency Services

Fire protection is currently provided by the Imperial County Fire Department. Water storage for fighting fires is provided in Rio Bend Lake and can be pumped from the lake with a pumper fire engine into a distribution system that supplies water to fire hydrants located throughout the existing land uses. The response time from the County Fire Department Station III is 3 to 5 minutes. The Department also provides first response medical aid with emergency medical technicians.

The Imperial County Sheriff provides police protection for this area of the County. Response time is approximately 10 minutes, depending upon the location of the patrol car at the time of the call.

Emergency medical services are provided by the El Centro Regional Medical Center located in El Centro. Emergency patients are transported to the Center by Gold Cross Ambulance service which is activated by the 911 emergency telephone system. Transport time from Rio Bend back to El Centro Regional Medical Center is less than 10 minutes.

g. Parks and Recreation

Imperial County maintains several facilities within the County. The closest recreation facility to Rio Bend is Sunbeam Lake, located on the north side of I-8. The existing land uses provide the guests and residents with a variety of recreational opportunities including golf, swimming, horse shoes, shuffle board, bird watching, and other organized activities sponsored by Rio Bend RV Resort Ranch.

III. PROJECT DESCRIPTION

A. Goals and Objectives

The overall goal in proposing the development of the Rio Bend property is to create a comprehensively planned multi-use community that provides a variety of residential, recreational, and public facilities in harmony with the natural setting of the project site as well as the existing and surrounding land uses.

The following specific goals are a response to expressions of concerns and desire from a variety of private citizens and public agencies.

1. Community Character

Provide a well-designed project that is sensitive to the resources of the project site as well as the existing and surrounding land uses.

Objective

Determine the land uses and locate them on the site based on a site specific analysis of the existing land uses as well as the surrounding land uses.

Objective

Design land uses that will maximize enjoyment of visual amenities, including Rio Bend Lake, Drew Lake, Lakeview Golf Course, New River open space, Fig Lagoon (evaporation pond), and Signal Mountain.

2. Recreational Vehicle Park Development

Provide optimum number of RV spaces on the project site to utilize existing infrastructure and recreational opportunities.

Objective

Maintain adequate buffer areas to separate proposed land uses from incompatible land uses, including New River, agriculture, Drew Road, and Kuhn Farm.

Objective

Add RV spaces in the south portion of the site and use existing access and recreation amenities.

3. Community Recreation

Assure the opportunity to utilize existing recreation amenities and provide additional recreational opportunities.

Objective

Furnish access to existing recreation facilities such as the existing lakes, golf course, and recreational open space areas.

4. Circulation

Plan a circulation system that will provide safe and adequate access for residents, guests, customers and emergency vehicles.

Objective

Provide access points to Drew Road that will preclude mixing of the seasonal and transient recreational vehicle traffic associated with the RV park from the year round resident traffic of the mobile home park.

Objective

Use the existing access driveway from Drew Road to Rio Bend RV Resort for the Additional RV Spaces.

Objective

Offer a variety of emergency access points for the use of emergency vehicles.

Objective

Prohibit the placement of access control gates or barriers on private streets to assure access to emergency vehicles.

5. Public Facilities

Public facilities, including sewage treatment, water treatment, and fire protection shall be designed and operated to provide adequate services at a reasonable cost to future residents and guests.

Objective

Make efficient use of the existing water delivery, storage and treatment facilities.

Objective

Design a dual water system to utilize untreated irrigation water for irrigation and fire protection and restrict use of treated water for human contact and consumption uses.

Objective

Expand existing septic systems or create a new septic system to provide sewage treatment services for Additional RV Spaces.

6. Landscaping and Walls

Provide attractive physical, acoustic, security and visual separation between on-site and off-site land uses.

Objective

Design visually pleasing solid walls using a variety of earthen berms and walls to provide for the effective separation of mobile home park from Drew Road and the adjacent hay operation.

Objective

Design fencing adjacent to the New River bluff that will both provide physical separation for public safety and preserve the existing view amenity.

7. Public Safety

Protect visitors and residents from health dangers from proximity to the New River.

Objective

Provide security fencing to protect visitors and residents from access to the polluted New River.

Objective

Reduce the exposure of residents and guests to illness spread by mosquitos by expanding the mosquito abatement monitoring and control program, requiring amber exterior lighting, and providing educational information for minimizing exposure to health hazards.

B. Design Principles

The following design principles are intended to describe how the Rio Bend project is designed to achieve compatibility with the natural setting, existing land uses, and adjacent land uses.

1. Natural Setting

- a. Grading will be minimized to retain existing topographic features.
- b. Storm water runoff will be controlled with drainage improvements to minimize soil and bluff erosion.
- c. Existing trees and vegetation will be retained to the maximum feasible extent.

2. Existing Land Uses

- a. Separate access points will be provided for the proposed land uses to preclude mixing of the seasonal and transient recreational vehicle traffic associated with the RV Park with the year round resident traffic of the mobile home residents.
- b. The mobile home park is separated from the RV Park by the 3-acre Rio Bend Lake.
- c. Continue development patten of Rio Bend RV Ranch with additional RV spaces.

3. Adjacent Land Uses

- a. The mobile home park is separated from the adjacent hay compaction and distribution operation. A solid barrier built along the northern boundary of the RV Park creates an effective physical and noise barrier.
- b. The mobile home park is separated from Drew Road by a berm enhanced with additional dirt, landscaping and solid walls to create an effective visual and noise barrier.
- c. Preservation of the existing vertical elevation difference adjacent to the New River will be retained and physical barriers will be constructed to separate both the mobile home park and additional RV spaces from the health hazards and sensitive biological habitat of the New River, Fig Lagoon (evaporation pond) and adjacent open space.
- d. The mobile home park spaces and additional RV spaces shall be designed to take advantage of distant views of Signal Mountain, intermediate views of the New River Valley and Fig Lagoon, and near views of Rio Bend Lake, Drew Lake, and Lakeview Golf Course.

C. Land Uses

The development program for Rio Bend proposes adding the following land uses to the existing land uses on the 110.4 acre project site. These land uses are shown in Figure 4 and in the large scale map included in an envelope at the end of this text, and summarized in Table 1.

Table 1. Land Use

Land Use		Units	Acres	Percent
Existing				
A.	Rio Bend RV Resort Ranch	229	23.3	21.1
B.	Water Treatment Facility	-	0.2	0.2
C.	Lakeview Golf Course	-	37.1	33.6
D.	Storm's Crossing Mobile Home Park	68	9.4	8.5
E.	Preservation Open Space	-	0.2	0.2
Subtotal		297	70.2	63.6
Amendment				
F.	Additional RV Spaces	674	37.2	33.7
G.	Preservation Open Space	-	3.0	2.7
Subtotal		674	40.2	36.4
Total		971	110.4	100.0

Existing Land Uses

A. Rio Bend RV Resort Ranch

The existing RV Park contains 229 spaces and 42 group camp spaces on 23.3 acres located in the central portion of the project site. This land use is supported by a potable water treatment facility, subsurface sewage disposal system, group camp, laundry facilities, convenience store, managers office, outdoor storage area, and various recreational amenities.

B. Water Treatment Facility

This facility provides drinking water for the RV and Mobile Home Park and is located on a 0.2 acre site north of Rio Bend Lake, within the area of the mobile home park. The facility treats up to 75,000 gallons of water per day and has a storage capacity of 130,000 gallons. The existing facility is adequate, but would need to be expanded within the existing site for the additional RV spaces.

C. Lakeview Golf Course

Lakeview Golf Course is a 9-hole public golf course occupying 37.1 acres in the western portion of the project site adjacent to the New River. The golf course is designed around Drew Lake, which occupies about 10 acres of the golf course. The water for Drew Lake is supplied from the outlet of

Rio Bend Lake and is used to supply water for irrigation of the golf course. The outlet for Drew Lake drains into the New River.

D. Storm's Crossing Mobile Home Park

A 68-space mobile home park is located on 9.4 acres in the northeast portion of the site. Primary access to the mobile home park is from Drew Road. Two emergency access points are provided, one to Drew Road and another to the existing RV Park.

The existing earthen berm supporting the irrigation canal parallel to Drew Road is retained and enhanced to provide for attenuation of noise impacts from traffic on Drew Road. Similarly, a solid 6 foot high wall, or combination of wall and earthen berm, was constructed along the northern boundary of the mobile home park.

The mobile home park was constructed to conform with the design standards required in Title 25 of California Code of Regulations (CCR Title 25). A majority of the spaces accommodate double wide coaches. One-half parking space per mobile home is provided for guest parking.

Sewage treatment for the mobile home park was accomplished by constructing a subsurface sewage disposal system in the golf course area of the site. All sewage collection and disposal facilities are either within the same ownership as the mobile home park or within dedicated easements for the purpose of providing sewage collection and disposal.

E. Preservation Open Space

The 0.2 acre portion of the steep bluff within the mobile home park adjacent to the New River will be preserved in open space.

Amendment Land Uses

F. Additional RV Spaces

The primary land use in the Amendment Phase adds an additional 674 RV spaces located on 37.2 acres. This includes the conversion of the existing 42 group camp spaces to Additional RV Spaces. Primary access will be provided from the existing entrance into the RV Ranch from Drew Road. An additional emergency access point will be provided to Drew Road.

G. Preservation Open Space

The 3.0 acre portion of the steep bluff within the additional RV space area adjacent to the New River will be preserved in open space.

IV. DEVELOPMENT STANDARDS AND MITIGATION MEASURES

A. Development Standards

The purpose of these standards is to guide the future development of the Rio Bend Specific Plan in a manner that will protect the public health, safety, comfort, convenience and general welfare of the present and future residents of Imperial County. This section describes the specific manner in which the Rio Bend project will be developed in conformance with the EIR and have a compatible relationship with the natural setting, existing land uses on the site, adjacent land uses and the goals and objectives of the Imperial County General Plan.

1. Specific Zoning Ordinance

The 1996 Zoning Ordinance that sets forth the allowed land uses and development regulations within the various zones in Imperial County shall remain in effect within the Rio Bend Specific Plan with the following specific amendments;

a. Section 90505, R-4 (High Density Residential and Mobile Home Park/Subdivision Zone)

The regulations contained in the Specific Zoning Ordinance shall apply in the R-4 Mobile Home Park Zone unless otherwise provided in this Specific Plan:

Sections 90505.01 through 90505.16 are applicable. (See Appendix C)

In addition to the regulations addressed in the Specific Zoning Ordinance, the following regulations shall apply in the R-4 zone within the Rio Bend Specific Plan:

- (1) **BLUFF SETBACK:** All habitable structures shall be setback from the river bluff adjacent to the New River. The setback distance shall be measured from the base of the bluff and shall be 2.6 times the bluff height. Soils studies may reduce the minimum setback distance if local soil conditions warrant. The height of the bluff shall be measured from the base of the bluff, at the lowest elevation where the slope steepness first exceeds a slope ratio of 2:1, to the top of the foundation of the dwelling or habitable structure.

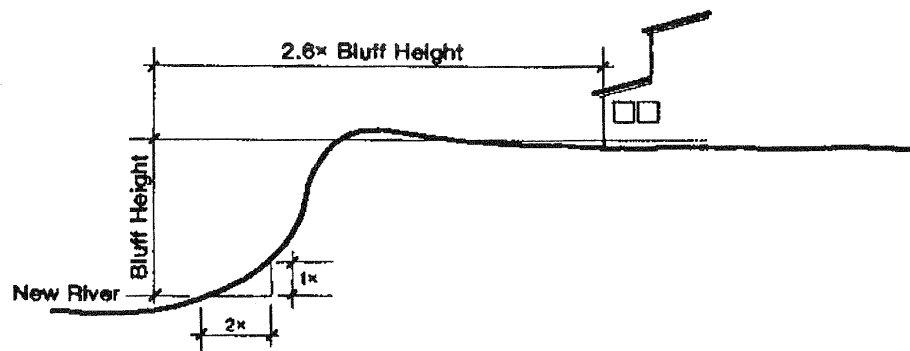

- (2) **FENCING:** Fencing to prevent access to the bluff face and the New River shall be constructed along the top of the bluff adjacent to the New River. The fencing shall be a minimum of 5 feet high and may be constructed with materials that will preserve views. A solid 6 foot high barrier to separate the mobile home park from the adjacent land use shall be constructed along the northerly boundary of the R-4 Zone.

B. Project Conformance With EIR Mitigation Measures

All development within the area regulated by the Rio Bend Specific Plan shall be consistent with the Rio Bend Specific Plan EIR and shall conform with all of the mitigation measures described in the EIR.

1. Public Health

- a. The existing mosquito abatement program shall be expanded to protect the mobile home park and additional RV spaces. The property owner shall be responsible for administering the program in the mobile home park and RV spaces.
- b. Residents of the Rio Bend project shall be annually informed about mosquito-borne diseases and measures to minimize contact with mosquitos and about the health hazards associated with body contact with the New River. An educational pamphlet, prepared by the owner/developer and approved by the Imperial County Department of Health Services, shall be distributed during the month of April. The property owner shall be responsible for pamphlet distribution in the mobile home park and RV spaces.
- c. All outdoor lighting in the mobile home park and RV spaces shall consist of amber lights.
- d. All runoff in the mobile home park and RV spaces shall be directed to the New River to prevent ponding of stagnant water.
- e. Fencing to prevent access to the bluff face and the New River from the mobile home park and RV spaces shall be constructed along the top of the bluff adjacent to the New River. The fencing shall be a minimum of 5 feet high and may be constructed with materials that will preserve views. Signage warning of the health hazards related to the New River shall be posted at 150-foot intervals along the fence. Fences in residential back yards are exempt from warning signage requirements.
- f. The non-potable water system shall be installed under the supervision of a certified water treatment plant operator. The actual work shall be performed under the direct supervision of a California licensed plumbing contractor.
- g. All non-potable water lines shall be clearly differentiated from the potable water lines. The two types of water lines shall be constructed from different material and/or painted different colors. The paint must be resistant to soil conditions and above-ground exposure. The non-potable water lines shall be also be identified by a warning message,

(i.e., "WARNING: NON-POTABLE WATER"). The message shall be marked every 12 inches on the non-potable water lines.

- h. All valves, including hose bibs, in the non-potable water system shall be individually marked with a similar warning message.
- i. The non-potable water system shall be designed to prevent back flow. A back flow prevention plan shall be submitted to the County Department of Health for approval.
- j. The potable water system shall be equipped with hose bibs with standard threaded hose connections. The non-potable water system shall be equipped with hose bibs that require a special key to operate or non-threaded hose bibs such as the "quick coupler."
- k. Only exterior irrigation systems shall be connected to the non-potable water system.
- l. All mobile home park residents and RV guests shall be notified that the project contains a dual water system. Notification will include an explanation of the dual water system, the source of the non-potable water, and location of non-potable water system pipes and valves. The water service district shall be responsible for notifying new residents in the mobile home park. If the mobile home park is operating before the water service district has been formed, the mobile home park management shall be responsible for notifying residents. New residents shall be notified immediately upon moving into the development.
- m. Residents shall be prohibited from modifying the non-potable water system without approval of the water service district. All connections to the non-potable water system shall be supervised directly by water service district personnel. If the mobile home park is operating before the water service district is formed, the mobile home park management shall obtain a licensed plumbing contractor to supervise all modifications to the non-potable water system, including new connections.

2. Public Services

a. Sewage Treatment

- 1. A subsurface sewage disposal system to treat the sewage generated from the mobile home park and Additional RV Spaces shall be approved prior to the construction of the mobile home park, or addition of RV spaces and shall be installed prior to occupancy.

b. Drinking Water Supply

- 1. The existing dual water system in the Rio Bend RV Resort Ranch shall be connected to the irrigation water supply and a dual water system shall be constructed and connected to both the drinking water and irrigation water supply for the mobile home park. Drinking water shall be used for drinking and domestic uses only and irrigation water shall be used for landscaping, fire protection, and recreational uses.

2. The water treatment facility shall be expanded to increase filtering capacity to 195,000 gallons per day and a dual water system shall be constructed and connected to both the drinking water and irrigation water supply. Drinking water shall be used for drinking and domestic uses only and irrigation water shall be used for landscaping, fire protection, and recreational uses.

c. Fire Protection

Additional pumps, generators, distribution lines and fire hydrants shall be installed as required by the Imperial County Fire Department for each phase and subphase of the Rio Bend project.

3. Schools

Impact fees shall be paid to the Seeley Union School District and the Central Union High School District as required.

4. Police Protection

No specific mitigation measures are required.

5. Solid Waste

No specific mitigation measures are required.

6. Parks and Recreation

No specific mitigation measures are required.

7. Emergency Medical Care

No specific mitigation measures are required.

8. Hydrology

Drainage improvements shall be constructed as required by Imperial County Department of Public Works. Storm water runoff shall be discharged to the New River as rapidly and directly as possible to reduce peak river flows. Energy dissipators to reduce runoff to nonerosive velocities shall be placed so as to minimize impact to biological resources.

9. Traffic/Circulation

- a. Southbound right-turn lanes shall be created on Drew Road at the existing entrance to Rio Bend RV Resort Ranch and at the entrance to the mobile home park.
- b. Both entrance road intersections with Drew Road and all internal private street intersections with public streets shall be controlled with a STOP sign when the right-turn lanes are constructed.

- c. Landscaping shall be maintained in order to enhance sight distance at both entrances.

10. Noise

A 6-foot high solid barrier shall be constructed along the eastern boundary of the mobile home park to create an acoustic barrier between the residential areas and Drew Road. The barrier shall wrap around the entrance roads to both areas.

11. Geotechnical

All mobile homes and habitable structures shall be setback from the river bluff adjacent to the New River. The setback distance shall be measured from the base of the bluff and shall be 2.6 times the bluff height. Soils studies may reduce the minimum setback distance if local soil conditions warrant. The height of the bluff shall be measured from the base of the bluff, at the lowest elevation where the slope steepness first exceeds a slope ratio of 2:1, to the top of the foundation of the dwelling or habitable structure.

V. PROJECT CONSISTENCY WITH GENERAL PLAN

This section will describe the relationship of the Rio Bend Specific Plan with the 1996 Imperial County General Plan. The goals and objectives of the various elements of the General Plan that are applicable to the Rio Bend project are listed below along with a statement of how the project conforms to each goal or objective. While all adopted elements of the General Plan were analyzed, it was determined that no goals or objectives of either the Scenic Highway Element or the Geothermal/Transmission Plan were applicable to the proposed project.

A. Relationship With General Plan

The Rio Bend Specific Plan is consistent with the Imperial County General Plan in that it will further the goals and objectives of the General Plan. In summary, the goals and objectives of the General Plan are furthered in the following elements:

B. Agriculture

The project site is surrounded by agriculture uses; however, it is not suitable for agricultural production due to its size, topography and relationship to existing land uses. The project does not conflict with surrounding agricultural production since the project site is separated by the New River Open Space, golf course, and electrical transmission line along Drew Road.

Goal 1: All Important Farmland, including the categories of Prime Farmland, Farmland of Statewide Importance, Unique Farmland, and Farmland of Local Importance, as defined by Federal and State agencies, should be reserved for agricultural uses.

Objective 1.1 Maintain existing agricultural land uses outside of urbanizing areas and allow only those land uses in agricultural areas that are compatible with agricultural activities.

The Rio Bend project site is located where some types of urban services are already existing and other types of urban services can be efficiently and easily provided by the developer and turned over to an operational entity.

Objective 1.4 Discourage the location of development adjacent to productive agricultural lands.

The Rio Bend project possesses several characteristics that decrease its usefulness for agriculture use while increasing its usefulness for residential and recreational development. The marginal soil quality, small parcel size, various elevation differences, and existing recreation land uses decrease its usefulness for agriculture. The natural separation of the site from agricultural land uses provided by the New River open space, the existing recreational land uses and supporting infrastructure systems, and the excellent road access increase the site's usefulness for residential and recreational development.

Objective 1.5 Direct development to less valuable farmland (i.e., Unique Farmland and Farmland of Local Importance rather than Prime Farmland or Farmland of Statewide Importance) when conversion of agricultural land is justified.

The Rio Bend project site possesses several characteristics that decrease its suitability for agricultural uses. The marginal soil quality, small parcel size and existing recreation land uses decrease its usefulness for agriculture.

Goal 2: Adopt policies that prohibit "leapfrogging" or "checkerboard" patterns of non-agricultural development in agricultural areas and confine future urbanization to adopted Sphere of Influence areas.

Objective 2.1 Do not allow the placement of new non-agricultural land uses such that agricultural fields or parcels become isolated or more difficult to economically and conveniently farm.

The Rio Bend project possesses several characteristics that decrease its usefulness for agricultural use while increasing its usefulness for residential and recreational development. The marginal soil quality, small parcel size, various elevation differences, and existing recreation land uses decrease its usefulness for agriculture. The natural separation of the site from agricultural land uses provided by the New River open space, the existing recreational land uses and supporting infrastructure systems, and the excellent road access increase the site's usefulness for residential and recreational development.

Objective 2.6 Discourage the development of new residential or other non-agricultural areas outside of city "spheres of influence" unless designated for non-agricultural use on the County General Plan, or for necessary public facilities.

The proposed changes are within the Recreation/Open Space 1996 General Plan Land Use Designation. The changes are within or adjacent to existing development that already requires urban levels of service.

Goal 3: Limit the introduction of conflicting uses into farming areas, including residential development of existing parcels, which may create the potential for conflict with continued agricultural use of adjacent property.

Objective 3.1 The primary use of any parcel designated "Agriculture" on the Land Use Plan shall be agricultural production. Residential uses in such areas must recognize that this primary use of the land may create nuisances such as flies, odors, dust, noise, night light, and chemical spraying.

Appropriate buffers are planned to shield the residents from agricultural production. The New River, the sloping New River bluff, fencing, landscaping and a golf course, buffers the residential units from agriculture uses.

Objective 3.6 Where a development permit is sought adjacent to agricultural land use, protect agricultural operations by requiring appropriate buffer zones between agricultural land and new developments, and then keep these zones aesthetically pleasing and free of pests by cleaning them of all garbage and noxious vegetation. Vegetation for the purpose of dust control shall be planted and maintained in an attractive manner. The buffer shall occur on the parcel for which the development permit is sought and shall favor protection of the maximum amount of farmland.

The New River, the sloping New River bluff, fencing, landscaping and a golf course, provides an adequate buffer zone between adjacent agriculture land and the Rio Bend project.

C. Circulation and Scenic Highway

The Rio Bend Site is located south of Interstate 8, off of Drew Road. Drew Road is a collector street with ramp access to Interstate 8. No policies related to Scenic Highways are applicable to the Rio Bend Project.

Goal 1: The County will provide an integrated transportation system for the safe and efficient movement of people and goods within and through the County of Imperial with minimum disruption to the environment.

Objective 1.2 Require a traffic analysis for any new development which may have a significant impact on County roads. In general, a traffic analysis should be required for projects which generate more than 500 ADT.

The Rio Bend Specific Plan was anticipated to generate more than 500 ADT. A traffic analysis was completed for the Rio Bend Specific Plan and impacts to traffic circulation were mitigated. The proposed Amendment will generate slightly more than 500 ADT if standard trip generation factors are used. The additional trips may be reduced to less than 500 ADT if the on-site recreational amenities and programs, and the on-site convenience store are considered.

Objective 1.9 Identify busy agricultural roads to create special crossings for farm equipment.

Drew Road, located adjacent to the Rio Bend project, is a busy agricultural road. Farm equipment crossings along Drew Road are not required along this section of Drew Road.

D. Conservation & Open Space

No natural resources were identified on the project site and no natural resources are impacted by the Rio Bend project. An extensive variety of recreational opportunities and facilities currently exist on the project site. The Rio Bend project recognizes the natural constraints of the site by not proposing development within hazardous areas such as flood plains or steep slopes.

Goal 1: Environmental resources shall be conserved for future generations by minimizing environmental impacts in all land use decisions.

Objective 1.2 Encourage only those uses and activities that are compatible with the fragile desert, aquatic, and marshland environment.

No development or disturbance of the New River riverine area is proposed. Access to the New River riverine area will be restricted by the placement of physical barriers and signs designed to discourage contact with the New River due to public health concerns.

Objective 1.5 Provide for the most beneficial use of land based upon recognition of natural constraints.

The Rio Bend site has unique characteristics including the natural buffer provided by the curvature of the New River, steeply sloping bluff created by the river, and floodway areas located near the river. These constraints make it unsuitable for agriculture, however Rio Bend has planned around these natural constraints. The golf course is located in the floodway as a buffer from agricultural uses and as protection to the residents. The mobile homes and RV locations are situated on higher elevations and buffered from agricultural and traffic uses.

Objective 1.6 Ensure the conservation, development and utilization of the County's natural resources.

No natural resources were identified on the Rio Bend project site.

Objective 1.8 Encourage the acquisition of scientific knowledge by encouraging the preservation of important ecological, archaeological, and other scientific sites.

No sites of ecological, archaeological or other scientific importance was identified on the Rio Bend project site.

Goal 2: The County will preserve the integrity, function, productivity, and long-term viability of environmentally sensitive habitats, and plant and animal species.

Objective 2.1 Conserve wetlands, fresh water marshes, and riparian vegetation.

No development is proposed within the riparian habitat of the New River or within Fig Lagoon. Fencing shall be placed between the developed areas and wildlife habitat to discourage human or domestic animal intrusion.

Objective 2.2 Protect significant fish, wildlife, plant species, and their habitats.

No rare or endangered flora or fauna have been identified on the Rio Bend project site.

Objective 2.3 Protect unique, rare, and endangered plants and animals and their habitats.

No unique, rare or endangered species have been identified on the Rio Bend project site.

Objective 2.4 Use the environmental impact report process to identify, conserve and enhance unique vegetation and wildlife resources.

An environmental impact report was conducted as part of the specific plan process. No unique vegetation or wildlife resources were identified.

Goal 3: Important prehistoric and historic resources shall be preserved to advance scientific knowledge and maintain the traditional historic element of the Imperial Valley landscape.

Objective 3.1 Protect and preserve sites of archaeological, ecological, historical, and scientific value, and/or cultural significance.

No sites of ecological, archaeological or other scientific importance was identified on the Rio Bend project site.

Goal 7: The aesthetic character of the region shall be protected and enhanced to provide a pleasing environment for residential, commercial, recreational, and tourist activity.

Objective 7.1 Encourage the preservation and enhancement of the natural beauty of the desert and mountain landscape.

The Rio Bend project provides housing and recreation opportunities within the area of Imperial County that is neither a desert nor mountain area.

Goals 8: The County will conserve, protect, and enhance the water resources in the planning area.

Objective 8.4 Ensure the use and protection of the rivers and other waterways in the County. Ensure proper drainage and provide accommodation for storm runoff from urban and other developed areas in manners compatible with requirements to provide necessary agricultural drainage.

The project design includes efficient runoff directly to the New River as rapidly and directly as possible to reduce peak river flows.

Objective 8.8 Ensure protection of water bodies that are important for recreational fishing.

The New River is not deemed as an important water body for recreational fishing.

Objective 8.9 Prohibit the inappropriate siting of solid or hazardous waste facilities next to water bodies or over sources of potable groundwater or recharge basins. In association with the clean up of the New River, all existing landfills in or near the river should eventually be closed.

No solid or hazardous waste facilities are included as part of the Rio Bend project.

Objective 8.13 Encourage water conservation and efficient water use among municipal and industrial water users, as well as reclamation and reuse of wastewater.

Irrigation water that would otherwise drain unused into the New River is diverted into Rio Bend Lake. Untreated water is stored in the lake for use as both untreated irrigation water and to supply water for the water treatment facility.

Goal 10: Open space shall be maintained to protect the aesthetic character of the region, protect natural resources, provide recreational opportunities, and minimize hazards to human activity.

Objective 10.1 Confine future urbanization within adopted Sphere of Influence areas.

The Rio Bend project already includes existing development that provided some types of urban services.

Objective 10.2 Recognize the regional significance of the development and conservation of recreational opportunities in Imperial County.

The Rio Bend project will provide for the development of several types of recreational opportunities including additional recreational vehicle spaces, and golf.

Objective 10.3 Provide a broad range of recreational facilities for all ages and economic groups emphasizing family-oriented opportunities.

Recreation facilities include golf and other activity areas a part of the Rio Bend project.

Objective 10.9 Conserve desert lands, within the county's jurisdiction for wildlife protection, recreation, and aesthetic purposes.

The Rio Bend Specific Plan is not located in any desert lands.

E. Geothermal Transmission

No policies are applicable to the Rio Bend Project.

F. Land Use

The Rio Bend project site is suited for the proposed Additional RV Spaces because it makes use of the existing capital improvements such as roads, drinking water supply, and recreation amenities. The land use is adjacent to existing development with public services and is separated from agriculture projection areas.

Goal 1: Preserve commercial agriculture as a prime economic force.

Objective 1.2 Discourage the location of incompatible development adjacent to productive agricultural lands.

The Rio Bend project site is suited for development since it is adjacent to existing development, separated from agricultural areas, has good road access, has few geologic hazards and uses existing infrastructure.

Goal 3: Achieve balanced economic and residential growth while preserving the unique natural, scenic, and agricultural resources of Imperial County.

Objective 3.9 Promote water recreation activities in Imperial County in suitable areas along the New, Alamo, and Colorado Rivers, and in the Salton Sea.

The New River is not suitable for water recreation activities at the Rio Bend location.

Objective 3.11 All zoning within the County of Imperial will be compatible with the General Plan.

The existing zoning, S1-Open Space/Recreational & SPA are compatible with the Recreation/Open Space designation in the General Plan. No changes are proposed.

Goal 4: Preserve and enhance distinctive historic desert towns and newer communities.

Objective 4.5 Specific Plan Area designation should be used for outlying proposed growth areas in order to better determine appropriate land uses and the timing and financing for needed community facilities.

Rio Bend currently has a Specific Plan Area designation.

Goal 5: Encourage the compatible development of a variety of housing types and densities to accommodate regional population projections and special housing needs.

Objective 5.1 Provide sufficient, suitable residential sites and housing supply to meet projected housing needs of all segments of the population.

The housing provided in the Rio Bend project will offer residents an additional housing choice that is anticipated to be competitive with other affordable housing in the region.

Goal 8: Coordinate local land use planning activities among all local jurisdictions and state and federal agencies.

Objective 8.2 New developments shall provide improvements to meet the added demands for parks and recreational facilities.

Rio Bend provides for several types of recreational opportunities including additional recreational vehicle spaces and golf.

Objective 8.3 Ensure that school facilities are adequate to meet the existing and projected needs of the population.

Due to the seasonal nature of the Additional RV Spaces, Rio Bend Specific Plan Amendment is not anticipated to generate additional students.

Objective 8.7 Ensure the development, improvement, timing, and location of community sewer, water, and drainage facilities will meet the needs of existing communities and new developing areas.

Implementation of the Specific Plan Amendment will ensure the development and appropriate timing of community sewer, water and drainage facilities to meet the needs of the development.

Objective 8.8 Ensure that the siting of future facilities for the transmission of electricity, gas, and telecommunications is compatible with the environment and County regulation.

An existing transmission line exists along Drew Road. No new facilities are required.

Objective 8.9 Require necessary public utility rights-of-way when appropriate.

No public utility rights-of-way are required.

G. Housing

Goal 1: Ensure the provision of housing sites in suitable locations and with adequate services which collectively accommodate a range of housing types, sizes, and prices meeting the needs of all economic segments of the County's population.

Policy 1.5 Ensure adequate housing for all persons regardless of age, race, sex, marital status, source of income, economic status, or other appropriate factors.

No persons will be discriminated against regarding the availability of housing at Rio Bend.

Goal 2: Provide the opportunity to obtain affordable housing which is safe, decent, and sanitary and within a suitable living environment with reasonable accessibility to employment.

The housing provided in the Rio Bend project would offer residents an additional housing choice that is anticipated to be competitive with other affordable housing in the region. The project site is suitable for residential development pursuant to the other elements of the general Plan and is near several significant employment opportunities.

Policy 2.4 Encourage quality housing in all residential areas compatible with the housing characteristics of the area.

Storm's Crossing Mobile Home Park and Rio Bend RV Resort Ranch exist on site. The addition of 674 RV spaces is compatible with the housing characteristics of the project site.

Goal 3: Ensure that housing opportunities are available to all income groups in all communities without discrimination on the basis of race, religion, ethnicity, sex, age, marital status, or household composition.

Objective 3.3 Ensure existing and projected housing needs of all income levels, including the County's share of the region's housing needs, are available to the greatest extent.

The Mobile Home Park will increase the number and variety of housing opportunities available to existing and future residents of Imperial County.

Objective 3.4 Reduce any effects of discrimination in housing and prevent future discrimination.

The mobile home and RV spaces will be rented, respectively without discrimination on the basis of race, religion, ethnicity, sex, age, marital status or household composition.

Goal 4: Promote the inclusion of energy conservation features in new and existing housing as required.

New mobile homes, that are meeting increasingly strict energy conservation standards, are encouraged to be placed in the mobile home park portion of the Rio Bend project.

H. Noise

Goal 1: Provide an acceptable noise environment for existing and future residents in Imperial County.

Noise from Drew Road will be reduced to acceptable levels by retaining existing topographic elevation differences and earthen berms, and constructing additional earthen berms and walls.

I. Seismic & Public Safety

Goal 1: Include public health and safety considerations in land use planning.

Objective 1.1 Ensure that data on geological hazards is incorporated into the land use review process, and future development process.

A geotechnical report was completed for the Rio Bend. The geotechnical recommendation for setbacks from the bluff created by the New River were incorporated into the Specific Plan and project design.

Objective 1.2 Regulate development within flood-way areas in accordance with Federal Emergency Management Agency (FEMA).

The Rio Bend Specific Plan does not allow for development within the flood-way. The golf course is located between the developed portion of the site and the New River.

Objective 1.4 Require, where possessing the authority, that avoidable seismic risks be avoided; and that measures, commensurate with risks, be taken to reduce injury, loss of life, destruction of property, and disruption of service.

All structures and infrastructure will be constructed to conform with all Imperial County requirements. The mobile homes been installed to conform with all Imperial County requirements.

Objective 1.7 Require developers to provide information related to geologic and seismic hazards when siting a proposed project.

A geotechnical report was completed for the Rio Bend Specific Plan. The geotechnical recommendation for setbacks from the bluff created by the New River were incorporated into the Specific Plan and project design.

Objective 1.8 Reduce fire hazards by the design of new developments.

Free draft fire hydrants and multiple points for emergency access will be provided to the satisfaction of the Imperial County Fire Department.

J. Water

Efficient use of water resources will be made through the use of a dual water system, efficient irrigation methods, water metering, and preservation of the New River floodplain. A majority of the water used at the Rio Bend project would otherwise be lost as overflow into the New River.

Goal 1: The County will secure the provision of safe and healthful sources and supplies of domestic water adequate to assure the implementation of the County General Plan and the long-term continued availability of this essential resource.

Objective 1.1 The efficient and cost-effective utilization of local and imported water resources through the development and implementation of urban use patterns.

Irrigation quality water is supplied to Rio Bend via the Elder Canal and is stored on site in Rio Bend Lake. The water treatment facility needed to supply drinking water currently exists, the facility will need to be expanded by the developer for the Additional RV Spaces.

VI. IMPLEMENTATION

The Rio Bend Specific Plan describes a series of procedures, regulations, standards and guidelines to insure that the various goals and objectives of the specific plan are implemented in an orderly and consistent manner. All future development within the Rio Bend Specific Plan shall be subject to these regulations.

A. Administration/Enforcement/Amendments

The development standards, guidelines, regulations and mitigation measures included in the Rio Bend Specific Plan and EIR shall be administered and enforced by the following public agencies:

1. Imperial County

a. Planning and Building Department

- Rio Bend Specific Plan (including amendments)
- Imperial County Zoning Ordinance
- Tentative Parcel Map
- Grading Permit
- CCR Title 25
- Building Permits

b. Department of Health Services

- mosquito abatement program
- septic system

c. Department of Public Works

- drainage improvements

d. Fire Department

- fire protection improvements and facilities

e. Sheriff

- law enforcement

2. State of California

a. Regional Water Quality Control Board

- waste discharge

b. Department of Fish and Game

- Streambed Alteration Permit

c. Drinking Water

- water treatment facility

The Rio Bend Specific Plan may be amended at any time with Planning Commission review and Board of Supervisor approval pursuant to the requirements and procedures in effect at the time of the submittal of the application for the amendment.

APPENDIX A
LEGAL DESCRIPTION

(To be supplied at a later date)

APPENDIX B
GENERAL PLAN AMENDMENT

1 RESOLUTION RECOMMENDING TO THE
2 BOARD OF SUPERVISORS AN AMENDMENT
3 OF THE GENERAL PLAN AS SUBMITTED
4 BY ED MCGREW

4 WHEREAS, there was submitted to the Imperial County Planning Commission
5 a request from Ed McGrew to change the General Plan from General Agriculture
6 to Recreation on a portion of Tracts 49 and 59, Township 16 South, Range 12
7 East, AND

8 WHEREAS, there was a public hearing held in the Board of Supervisors
9 Chambers, County Administration Center, El Centro, California, April 11,
10 1984 at 10:25 a.m., AND

11 WHEREAS, there was an Environmental Impact Report prepared and
12 circulated for this project, AND

13 WHEREAS, it was the findings of the Commission that this amendment
14 be recommended to the Board of Supervisors for approval.

15 NOW THEREFORE BE IT RESOLVED that the amendment to the Genral Plan,
16 as described above, be recommended to the Board of Supervisors for approval.

17 BE IT CERTIFIED that the Final Environmental Impact Report was
18 reviewed pursuant to the California Environmental Quality Act of 1970 and
19 subsequent amendments thereto, affecting the territory described herein
20 and directed staff to prepare findings mitigating all environmental
21 impacts and to bring the findings to the Commission at their next meeting
22 for approval and adoption.

23 Motion made by Commissioner McMahon, seconded by Commissioner
24 Manchester and carried on the affirmative roll call vote of Commissioners
25 Jones, Mendivil, Johnson, Manchester, DiMasio, McMahon, Rodia and Brown.
26 Commissioner Simon voted NO.

27 This is to certify that the foregoing is a true and correct copy
28 of a resolution passed by the Imperial County Planning Commission at a

1 regular meeting April 11, 1984 in the Board of Supervisors Chambers,
2 County Administration Center, El Centro, California.

3 Don Brown, Chairman

4 

5 RICHARD D. MITCHELL, Secretary
6 Imperial County Planning Commission

7 jt

8
9
10
11
12
13
14
15
16
17
18
19
20
21
22
23
24
25
26
27
28

FILE 1710.4

X FILE 800.866

DATE May 15, 1984

BOOK 251

PAGE 230

THE BOARD OF SUPERVISORS OF THE COUNTY OF IMPERIAL, STATE OF CALIFORNIA,

on a motion of Supervisor Legaspi Seconded by Supervisor

Blume,

and approved by the following roll call vote:

AYES: Legaspi, Blume, Seabolt

NAYES: None

ABSTAINED: None

EXCUSED OR ABSENT: Bucher, Curiel

MINUTE ORDER NO: 21.

IN REFERENCE TO:

Adopted amendment to findings for Ed McGrew's General Plan amendment approved on May 8, 1984.

cc: Clerk
Auditor
CAO

Planning 

FILE 1710.4

X FILE 800.866

DATE May 8, 1984

BOOK 251

PAGE 167

THE BOARD OF SUPERVISORS OF THE COUNTY OF IMPERIAL, STATE OF CALIFORNIA,

on a motion of Supervisor Blume Seconded by Supervisor

Bucher, and approved by the following roll call vote:

AYES: Legaspi, Blume, Bucher, Seabolt, Curiel

NAYES: None

ABSTAINED: None

EXCUSED OR ABSENT: None

MINUTE ORDER NO: 3.a.

IN REFERENCE TO:

The following actions were taken on proposal submitted by Ed McGrew:

a. General Plan Amendment

(1) Certified EIR was properly prepared and considered.

(2) Adopted findings concerning the Environmental Impacts and stating that they have either been mitigated or that there are overriding economic considerations. Planning to return on May 15, 1984, with amendments to findings to reflect additional findings of Board.

(3) Approved General Plan amendment from General Agriculture to Recreation.

cc: Clerk
Auditor
CAO

Planning
Public Works

1 RESOLUTION MAKING FINDINGS FOR
2 MITIGATION OF ENVIRONMENTAL IMPACTS
3 AS OUTLINED IN THE EIR FOR ED MCGREW

4 WHEREAS, there was submitted to the Imperial County Planning Commission
5 Findings for mitigation of environmental impacts as outlined in the Environ-
6 mental Impact Report for the General Plan Amendment and Change of Zone appli-
7 cations submitted by Ed McGrew.

8 NOW THEREFORE BE IT RESOLVED that the Commission made the attached
9 Findings in support of their previous decisions.

10 Motion made by Commissioner Johnson, seconded by Commissioner Manchester
11 and carried on the affirmative roll call vote of Commissioners Jones, Mendivil,
12 Johnson, Manchester, DiMasio, Simon, Rodia and Brown. Commissioner Merrell
13 abstained.

14 This is to certify that the foregoing is a true and correct copy of a
15 resolution passed by the Imperial County Planning Commission at a regular
16 meeting April 25, 1984 in the Board of Supervisors Chambers, County
17 Administration Center, El Centro, California.

18 Don Brown, Chairman

19 

20 RICHARD D. MITCHELL, Secretary
21 Imperial County Planning Commission

22 jt
23
24
25
26
27
28

ENVIRONMENTAL IMPACT
Mitigation Measures
Rio Bend R. V. Resort Ranch
5/1/84

The applicant shall enter into an agreement requiring implementation of the following actions. This agreement shall be recorded and shall provide that these measures shall run with the land and be binding on all successors in interest. The applicant shall agree that if he fails to carryout any part of this agreement, the County may accomplish such measures and attach a lien against the property. This lien shall be in the same form and shall be pursuant to the same provision of Revenue and Taxation Code as pertains to secured real property taxes that are unpaid. These liens shall be paid when the project's property taxes are due and if not paid they may be collected under the same provisions of the Revenue and Taxation Code used for collecting unpaid secured property taxes.

1. The applicant shall provide and operate a mosquito abatement plan as approved by the Health Department of the County. This plan shall include measures to control the larvae and adult mosquitoes.
2. The applicant shall provide a detailed layout to the Planning Department prior to construction.
3. The applicant shall fence the project to prevent human and/or pet access to the New River. Conspicuous signs shall be placed on the fence warning of the potential hazards. The applicant shall plant shrubbery along the fence.
4. The applicant shall install sewer and water systems to County and State standards. The water system shall include a generator and an emergency pump for fire fighting purposes. The applicant shall provide and install fire hydrants to Fire Marshall standards.
5. The applicant shall dedicate 42 feet right of way from the center line of Drew Road for the length of the project. The applicant shall secure an encroachment permit for driveways entering into Drew Road from the Public Works Department.
6. The applicant shall widen Drew Road for the length of the project as requested by the Department of Public Works.
7. The applicant shall prohibit any construction activities within 500 feet of the river channel from March 1 to June 30.
8. The applicant shall comply with all State and County permit requirements.

1 RESOLUTION DETERMINING CHANGE OF ZONE
2 FROM A-2 AND A-3 AS SUBMITTED BY ED
3 MCGREW IS CONSISTENT WITH THE GENERAL
4 PLAN AND RECOMMENDING TO THE BOARD OF
5 SUPERVISORS RECOMMENDING APPROVAL

6 WHEREAS, there was submitted to the Imperial County Planning Commission
7 a request from Ed McGrew to change the zone from A-2 and A-3 to "F" -
8 Recreation - on a portion of Tracts 49 and 59, Township 16 South, Range
9 12 East, AND

10 WHEREAS, there was a public hearing held in the Board of Supervisors
11 Chambers, County Administration Center, El Centro, California on April 11,
12 1984 at 10:30 a.m., as per Section 83418 of the Imperial County Codified
13 Ordinances, AND

14 WHEREAS, it was the findings of the Commission that this change of
15 zone is consistent with the General Plan, AND

16 WHEREAS, there was an Environmental Impact Report prepared for this
17 project, AND

18 WHEREAS, it was the findings of the Commission that this change of
19 zone should be recommended to the Board of Supervisors for approval.

20 NOW THEREFORE BE IT RESOLVED that the change of zone, as described
21 above, is found to be consistent with the General Plan of Imperial County,
22 AND

23 BE IT FURTHER RESOLVED that the change of zone for Ed McGrew be
24 recommended to the Board of Supervisors for approval.

25 BE IT FURTHER RESOLVED AND CERTIFIED that the Final Environmental
26 Impact Report was reviewed and adopted pursuant to the California
27 Environmental Quality Act of 1970, and subsequent amendments thereto,
28 affecting the subject matter herein, and to have findings mitigating all
environmental impacts presented at the next meeting for approval and
adoption.

1
2
3
4
5
6
7
8
9
10
11
12
13
14
15
16
17
18
19
20
21
22
23
24
25
26
27
28

Motion made by Commissioner McMahon, seconded by Commissioner
Manchester and carried on the affirmative roll call vote of Commissioners
Jones, Mendivil, Johnson, Manchester, DiMasio, McMahon, Rodia and Brown.

This is to certify that the foregoing is a true and correct copy of
a resolution passed by the Imperial County Planning Commission at a regular
meeting April 11, 1984 in the Board of Supervisors Chambers, County
Administration Center, El Centro, California.

Don Brown, Chairman



RICHARD D. MITCHELL, Secretary
Imperial County Planning Commission

jt

FILE 800.866

X FILE 1710.4

PAGE 168

DATE May 8, 1984

BOOK 251

THE BOARD OF SUPERVISORS OF THE COUNTY OF IMPERIAL, STATE OF CALIFORNIA,

on a motion of Supervisor Blume Seconded by Supervisor

Bucher,

and approved by the following roll call vote:

AYES: Legaspi, Blume, Bucher, Seabolt, Curiel

NAYES: None

ABSTAINED: None

EXCUSED OR ABSENT: None

MINUTE ORDER NO: 3.b.

IN REFERENCE TO:

b. Zone Change

- (1) Certified that the Environmental Impact Report was properly prepared and considered.
- (2) Adopted findings indicating that all environmental impacts have been mitigated by the proposed action or that there are overriding economic considerations.
- (3) Found the zone change to be consistent with the General Plan of Imperial County.
- (4) Approved the zone change conditioned upon entering into an agreement (said agreement for mosquito control to be recorded) between the applicant and the County concerning the required environmental mitigation measures.
- (5) Adopted Ordinance No. 866 changing the zone from A-2 and A-3 to "F" Recreation.
- (6) Directed Staff to develop a County-wide mosquito plan and draft ordinance. Said plan and ordinance, when adopted by the Board of Supervisors, will supersede agreement for mosquito control under item no 4 above.

cc: Clerk
Auditor
CAO

Planning
Public Works

Zone Maps

S 83340.01 Amendment to Zoning Map No. 40 - Westside School Area

The map entitled Westside School Area is hereby amended in the following particular only:

The zone classification of those certain parcels of real property situated in the County of Imperial, State of California, and more particularly described as:

PARCEL 1: That portion of the North half of Tract 49, Township 16 South, Range 12 East, S.B.B.&M., County of Imperial, State of California, shown as Parcel "F" on License Survey Map on file in Book 10, Page 5 of License Surveys, on file in the Office of the County Recorder of Imperial County.

PARCEL 2: That portion of the North half of Tract 49, Township 16 South, Range 12 East, S.B.B.&M., County of Imperial, State of California, shown as Parcel "A" on License Survey Map on file in Book 10, Page 5 of License Surveys, on file in the Office of the County Recorder of Imperial County.

EXCEPTING that portion thereof lying Westerly on the following described line:

Beginning at a point, in the South line of said Parcel "A" which is 250.00 feet East of the Southwest corner thereof; thence North 0°05'30" West 500.00 feet; then Northeasterly to a point in the North line of said Parcel "A" which is 940.42 feet East of the Northwest corner thereof.

PARCEL 3: That portion of the East 10 acres of the North half of the South half of Tract 49, Township 16 South, Range 12 East, S.B.B.&M., County of Imperial, State of California, shown as Parcel "H" on License Survey Map on file in Book 10, Page 5 of License Surveys, on file in the Office of the County Recorder of Imperial County.

EXCEPT the South 330 feet thereof.

Zone Maps

PARCEL 4: That portion of the North half of Tract 49, Township 16 South, Range 12 East, S.B.B.&M., County of Imperial, State of California, and that part of the East 10 acres of the North half of the South half of Tract 49, Township 16 South, Range 12 East, S.B.B.&M., County of Imperial, State of California, as per Map of the Re-Survey approved March 15, 1909, and filed in the United States Land Office, and described as Parcels "B" and "C," on Licensed Survey Map recorded in Book 10, Page 5 of Licensed Surveys, on file in the Office of the County Recorder of Imperial County.

Is hereby changed from A-2 and A-3 to "F," Recreation.

(Added by Ordinance No. 866, effective June 7, 1984.)

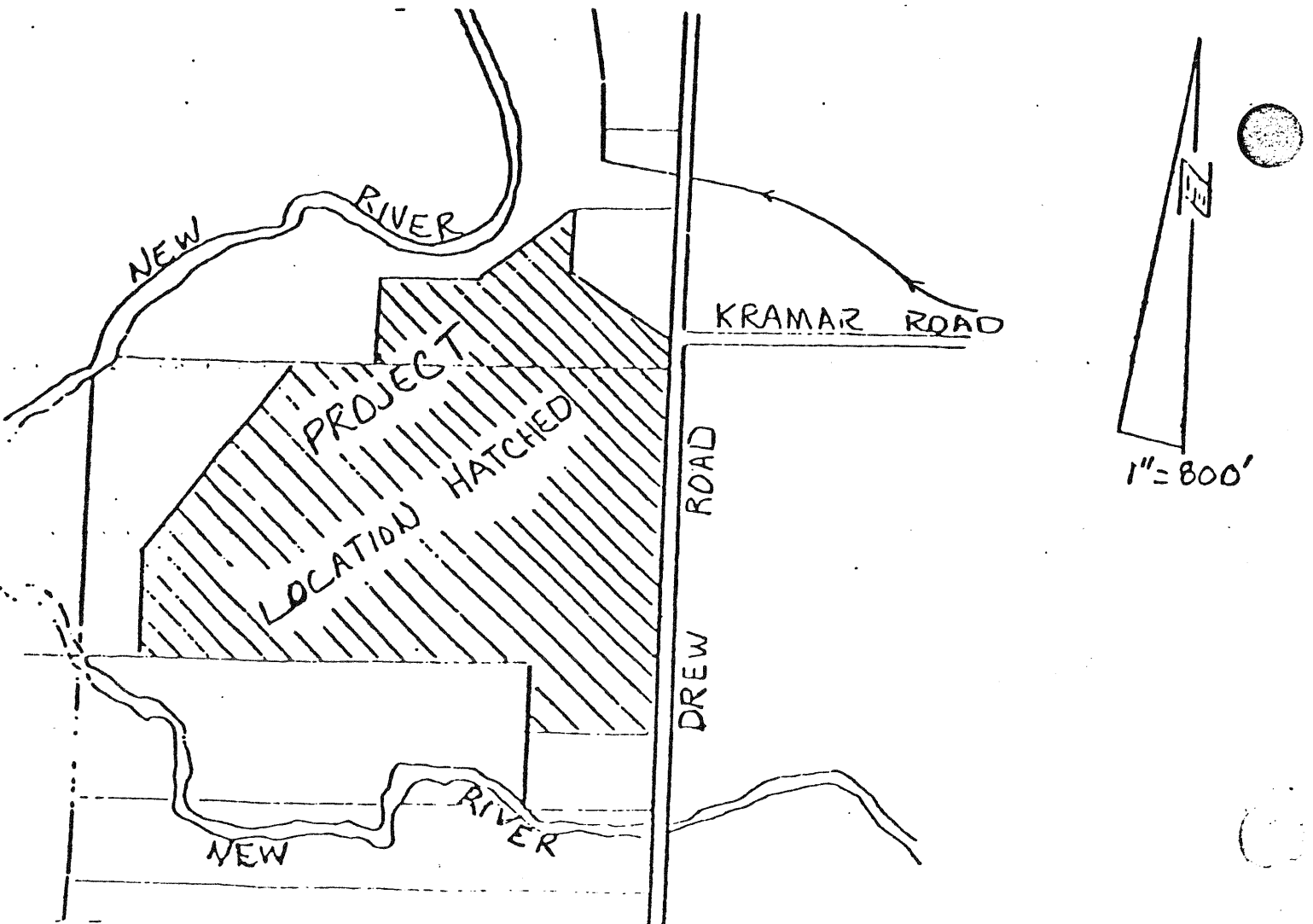

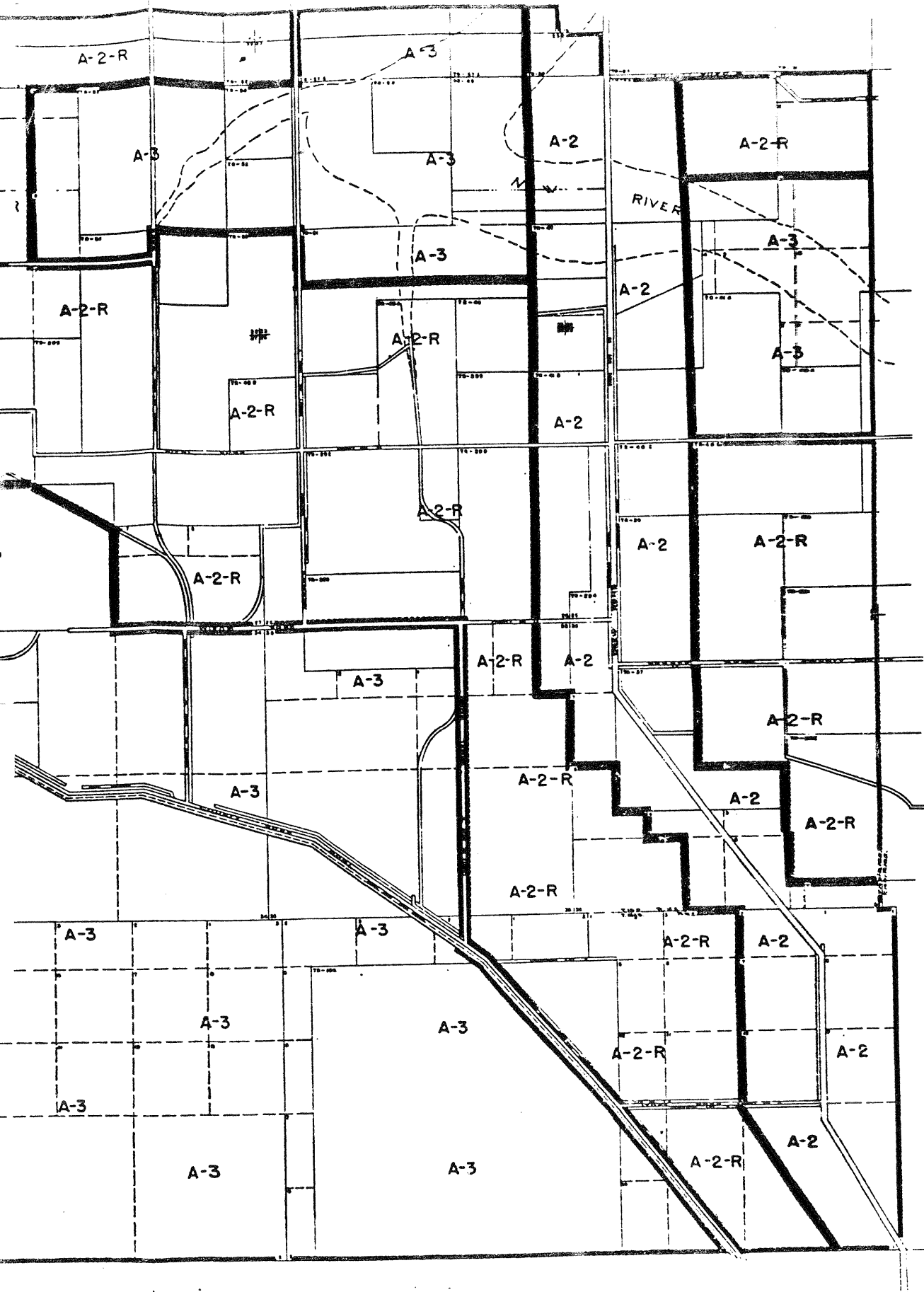

APPENDIX C

**TITLE 9
SECTION 90505**

TITLE 9

DIVISION 5: ZONING AREAS ESTABLISHED

CHAPTER 5: R-4 (HIGH DENSITY RESIDENTIAL AND MOBILE HOME PARK/SUBDIVISION ZONE)

§ 90505.00	PURPOSE & APPLICATION
§ 90505.01	PERMITTED USES IN THE R-4 ZONE
§ 90505.02	USES PERMITTED WITH CONDITIONAL USE PERMIT ONLY
§ 90505.03	PROHIBITED USES
§ 90505.04	MINIMUM LOT SIZE
§ 90505.05	MINIMUM LOT AREA
§ 90505.06	SETBACK
§ 90505.07	HEIGHT
§ 90505.08	MINIMUM DISTANCE BETWEEN STRUCTURES
§ 90505.09	PARKING
§ 90505.10	SIGNS
§ 90505.11	LANDSCAPING
§ 90505.12	YARD MAINTENANCE
§ 90505.13	SPECIAL PROCEDURES
§ 90505.14	ANIMALS
§ 90505.15	SITE DEVELOPMENT PLAN REVIEW REQUIRED
§ 90505.16	FENCING

§ 90505.00 PURPOSE & APPLICATION

The purpose of the High Density Residential and Mobile Park/Subdivision Zone, is to allow for areas that are suitable for extremely high density residential environments and mobile home (manufactured home) residential living environments and regulate development within these areas to be in compliance with California Code of Regulations (CCR) Title 25.

§ 90505.01 PERMITTED USES IN THE R-4 ZONE

The following uses are permitted in the R-4 Zone.

- Accessory facilities, such as laundry, a storage facility and a convenience store, with an RV/Mobile home park
- All R-3 uses
- Commercial Office, related to the park or subdivision
- Community Recreational Facilities
- Day Care Facility limited to one child per 3 mobile homes
- Pre-school, Elementary School, Junior High School, Senior High School, College, or University (public)
- Manager's/Caretaker or proprietor's quarters
- Mobile Home (manufactured home) (one per legal lot)
- Residential accessory structure, only after installation of a mobile home
- Temporary on-site construction office
- Temporary on-site real estate sales/rental office

§ 90505.02 USES PERMITTED WITH CONDITIONAL USE ONLY

The following uses are permitted in the R-4 (Mobile Home Park) Zone subject to first securing a conditional use permit in accordance with the standards and procedures set out within this Title.

- Community Care Facility
- Community sewage treatment facility
- Flood control facility, water storage or groundwater recharge facility
- Public agency or utility building or facility

- Utility sub-station

§ **90505.03 PROHIBITED USES**

All other uses not permitted by Section 90505.01 and 90505.02 herein are prohibited in the R-4 (Mobile Home Park) Zone, including dwellings other than manufactured homes.

§ **90505.04 MINIMUM LOT SIZE**

Except as otherwise provided within this Title, no portion of any lot within the R-4 Zone shall be less than 6,000 square feet, except that lots within a designated and permitted mobile home park shall meet the requirements of Title 25 of CCR.

§ **90505.05 MINIMUM LOT AREA**

In a mobile home park subdivision, there shall be no more than one dwelling unit per legal lot in the R-4 Zone.

§ **90505.06 SETBACK**

The following yard and setback requirements apply to the R-4 Zone.

- A. Front Yard - The front yard minimum setback for all structures shall be 20 feet from property line.
- B. Side Yard - There shall be a side yard on each side of the property or main building of not less than 5 feet and not less than 10 feet on the other side, except that on a corner lot, the side fronting on the street shall be the same as the front yard setback.
- C. Rear Yard -
 - 1. 20 foot minimum for all primary structures on lots that do not have an alley.
 - 2. 10 foot minimum for all primary structures on lots that do have a minimum width alley of 20 feet.
 - 3. 5 feet for accessory structures for lots that do not have an alley.
 - 4. 0 feet for accessory structures that abut an alley that have a minimum 20 foot width.

§ **90505.07 HEIGHT**

The following heights shall apply to all R-4 Zones.

- 1. Buildings and structures shall not exceed 2 stories or 30 feet, whichever is less.
- 2. Radio and/or television antenna, chimneys and other similar structures shall not exceed 60 feet.

§ **90505.08 MINIMUM DISTANCES BETWEEN STRUCTURES**

The following requirements apply to the minimum distances between structures in the R-4 Zone:

- A. There shall be a minimum distance of 10 feet between primary residential use structures.
- B. There shall be a minimum of 6 feet between a primary residential structure and any accessory structure.

SPECIAL NOTE: In addition to the above this zone shall comply with setback requirements of Title 25, at a minimum. Where a "park" is governed by CCR Title 25, the CCR requirements shall govern.

§ 90505.09 PARKING

Off-street parking shall be provided in the R-4 Zone according to the standards contained in Sections 90402.00 through 90402.16 of this Title.

§ 90504.10 SIGNS

The following type of signs are permitted in the R-4 Zone, in accordance with the requirements contained in Section 90401.06 through 90401.17, as applicable:

1. Temporary real estate signs, not exceeding 10 square feet, in advertising property for sale or lease and meeting the requirements of Division 4, Chapter 1.
2. Temporary construction signs related to construction on said property, again meeting requirements of Division 4, Chapter 1.
3. Temporary political, religious, civic and campaign sign not exceeding 3 months in duration and meeting the requirements of Division 4, Chapter 1.
4. Signs approved in conjunction with a conditional use permit approved for the site.

§ 90505.11 LANDSCAPING

Every R-4 lot/parcel or use shall meet the requirements of Section 90302.02.

§ 90505.12 YARD/PROPERTY MAINTENANCE

The areas within a R-4 Zone/lot shall at all times be maintained so as to not create a fire or life safety, or health hazard either to the occupants of the structures or to adjacent neighboring properties.

§ 90505.13 ANIMALS

The breeding, keeping or maintaining of large or medium size animals in the R-4 zone, used for high density residential or mobile home park are strictly prohibited in the R-4 zone except where the R-4 zone is used as a mobile home subdivision the following is allowed:

- A. R-4 lots larger than ½ but less than 1 acre net may keep two small animals per acre provided the separation distances under Section 90502.08(B) can be achieved.
- B. R-4 lots greater than 1 acre net may keep and maintain one large animal per acre up to 5 acres, and one large animal for every 5 acres of lot area thereafter (i.e. 40 acre lot equals 12 large animals). Small animals (i.e. goats, sheep, etc.) shall be allowed at the ratio of 1 large animal equals two small animals. Separation as required under Section 90502.08(B) shall be met.
- C. R-4 lots allow for the keeping of small fowl, rabbits, birds, provided they are for domestic or hobby purposes and are maintained within proper structures, are not free to leave the property and provided the number of such animals does not exceed 5 of any one or combination thereof.
- D. The keeping of small domestic pets such as cats and dogs are allowed for non-commercial uses, and provided there are less than 5.
- E. Special project animals considered to be 4H or FFA projects may allow for the keeping of one large animal or two small animals per parcel provided that they are:
 1. for the duration of the FFA/4H or agricultural fair schedule or 7 months maximum whichever is less;

2. the property owner files an affidavit with the Planning/Building Department to verify it is a legitimate special project, including the name of the club, club leader and other information required by the Planning Director.

NOTE: The keeping of animals as designated is only allowed to the extent that said animals do not constitute a nuisance or public health hazard.

§ 90504.14 SPECIAL PROCEDURES

The following special procedures, development and standards apply to the R-4 Zone.

- A. No development shall be permitted within the R-4 Zone prior to the recordation of a final subdivision map in accordance to the procedures of Imperial County or following issuance of a Permit to Operate to a permitted mobile home park.
- B. Each mobile home placed on an individual lot/parcel shall be:
 1. Placed on a permanent foundation system
 2. Be installed according to manufacturer's instructions and State requirements and either be recessed into the grounds or be otherwise enclosed so that no portion of the under carriage is visible

Note that a mobile home shall not be recessed into the ground if it is connected to liquefied petroleum gas. Any recessed mobile home shall have a finished floor elevation of a minimum of 12 inches above adjacent street and shall make provisions for proper drainage.

§ 90505.14 SITE DEVELOPMENT PLAN REVIEW REQUIRED

No mobile home park shall be established, no development shall occur and no building or grading permit shall be issued for any use or development in the mobile home park until an application for a site development plan review has been submitted and approved by the Director of Planning. At a minimum the site development plan review shall contain the following:

- A. Name and address of applicant
- B. Name and address of property owners
- C. Assessor's Parcel Number
- D. Legal description
- E. A site development plan, drawn to scale specified by the Director of Planning, include the following:
 1. Topography and proposed grading
 2. Proposed private access drive-ways and parking areas
 3. Location of all mobile home pads
 4. Location of all permanent buildings and structures
 5. Parks, open space and recreational areas
 6. Proposed landscaping
 7. North arrow
 8. Manager's office/residential location
- F. Elevation of all permanent common buildings
- G. Phasing of development
- H. A detail description of the facility improvements including:
 1. Curbs, gutter, sidewalks, and street widths
 2. Water supply system
 3. Sewage collection and disposal system
 4. Public utility system

5. Fencing

- I. Any other reports or approvals as required and/or specified as a mitigation measure by any environmental document for the implementation of a mobile home park.

§ 90505.15 SPECIFIC DEVELOPMENT STANDARDS AND CONDITIONS

Development within a mobile home park zone or within a mobile home park shall comply with the following minimum standards:

- A. The project shall be consistent with the General Plan and all development shall be consistent with the goals and policies of the County's General Plan.
- B. Access, access driveways and parking.
1. All access driveways within a mobile home park shall be not less than 25 feet in width.
 2. Guest parking shall be distributed throughout the mobile home park as required by this Title and the department.
 3. All vehicular parking areas and driveways shall be surfaced and graded in accordance with the requirements for local public streets as contained in County ordinance.
 4. All mobile home parks spaces shall have frontage on internal private/public driveways. No mobile home space shall have direct access to a public street or public alley way.
 5. All mobile home park sites shall have access from an abutting improved and dedicated County street or State highway.
- C. Public street and highway dedications.
1. Streets and highway dedications adjacent to a mobile home park may be required by the Director of Planning in conjunction with Public Works Director, according to the following standards.
 - a. If the park is adjacent to a major highway, as shown on the Imperial County's Circulation Plan, the owner shall dedicate or make an irrevocable offer of dedication of all property lying within 55 feet of the center line of such highway for public highway purposes at no cost to the County.
 - b. If the park is adjacent to a secondary highway as shown on the Imperial County's Circulation Plan, the owner shall dedicate or make an irrevocable offer of dedication of all property lying within 45 feet of the center line of such highway for public highway purposes at no cost to the County.
 - c. If the park lies adjacent to the projected alignment of a planned local street which is necessary for circulation within the general area or neighborhood, the owner shall dedicate or make an irrevocable offer of dedication of all property lying within 30 feet of the center line of such street for public street and no cost to the County.
 - d. If the park is adjacent to an adopted specific plan or official plan line, the owner shall dedicate or make an irrevocable offer of dedication of all property lying within the specified right-of-way line for public highway purposes, and no cost to the County.
 2. Required street and highway improvements shall include any necessary tie to existing pavement and shall be under permit of the County Public Works Department or the State Division of Highways (CalTrans) as appropriate.

D. Recreational areas and facilities.

1. If a mobile home park contains 10 or more mobile home spaces, or if a mobile home park combined with a recreational vehicle park contains a combination of 10 or more mobile home spaces and recreational spaces, an open area of land devoted to and landscaped for recreational uses shall be provided within the park.
2. Such recreational areas shall not be less than 5,000 square feet, plus any additional 100 square feet for each space in excess of 10.
3. Required recreational areas may be divided into more than one location, provided that no single location, however, is less than 3,000 square feet.
4. No building or mobile home shall occupy a required recreational area, except buildings and structures necessary or used and devoted to the recreational use, such as a recreational building, swimming pools, accessory buildings, saunas, playgrounds (with or without equipment), picnic areas, etc.
5. No required front yard, side, or rear yard of the park or any mobile home space, recreational vehicle space or storage area shall be counted to with the requirement for recreational space.
6. The required recreational space shall be accessible to all occupants of the park and shall not be used for any other purpose other than recreational use of the occupants of the park.

E. Enclosures.

1. Each mobile home park shall be completely enclosed within a fence, hedge or combination thereof subject to the approval of the Director of Planning.
2. Such enclosures may have driveway or pedestrian way opening subject to the approval of the Director of Planning.
3. Within the front yard a required enclosure shall be no more than 4 feet in height.
4. Within any other portion of the park required enclosures shall be a minimum of 6 feet in height.
5. When deemed necessary by the Director or the Planning Commission, in order to maintain standards compatible with an existing development, on adjacent properties, specific types of fences may be required.

F. Utility Installation.

1. All public utility transmission lines located within the park shall be underground.
2. Utility connections to each mobile home space shall be placed underground.

G. Drainage.

1. The drainage system shall be installed prior to occupancy of the park and shall be continuously maintained in accordance with the plan approved by the Department.
2. The plan shall include, but not limited to the following:
 - a. All drainage originating on the park site shall be contained on the same site, unless the plan for acceptance of such drainage to off-site canals approved by the Department of Public Works and Planning/Building Department.

- b. The method for transporting off-site drainage through and away from a mobile home park shall be in accordance with the Department of Public Works standards and accommodate a minimum of a 100-year flood.
- c. In the event that any drainage sump is located within the park, it must have a water holding capacity of more than 18 inches in depth and shall be completely enclosed with a secured fence.

H. Water Distribution and Sewage Disposal System.

- 1. A water distribution system shall be installed prior to occupancy of the park and shall be continuously maintained in accordance with the plan approved by the Imperial County Planning/Building Department and Imperial Health Department.
- 2. A sewage disposal system shall be installed prior to occupancy of the park and shall be continuously maintained in accordance with the Imperial County Health Department's standards.

I. State Permit Requirements.

- a. Mobile home park owner/operator shall secure all necessary building permits and all operating licenses as required by the State of California, through the Imperial County Planning/Building Department.

Garage or yard sales are permitted without special use permits, provided they meet the following conditions:

- a. Sales last no longer than two (2) days.
- b. Sales are held no more than two (2) times a year.
- c. Sales are contained within the property.
- d. No goods purchased for re-sale are efferent.
- e. Directional signs shall be removed immediately after sale ends.
- f. Directional signs shall not exceed 9 square feet.
- g. Directional signs may be placed on public right-of-way provided they do not interfere with traffic.
- h. Directional signs on private property shall have property owner's (not tenants) permission.
- i. Violation of one or all of items (a) through (h) is a misdemeanor and may be cited.

§ 90505.16 FENCING

Fencing, if installed, shall at a minimum meet the requirements of Section 90403 et seq. Under no conditions shall the use of barbed, razor edged, or electrified fencing be allowed within this zone.

THIS SPACE INTENTIONALLY LEFT BLANK