

PROJECT REPORT

TO: ENVIRONMENTAL EVALUATION COMMITTEE AGENDA DATE: December 12, 2024

FROM: PLANNING & DEVELOPMENT SERVICES

AGENDA TIME 1:30 PM / No.2

La Valle Sabbia Inc.

PROJECT TYPE: CUP#23-0001 / Initial Study #23-0001 SUPERVISOR DIST #3

LOCATION: 2015 Silsbee Road APN: 062-080-015-000

El Centro, CA 92243 PARCEL SIZE: 35.8 +/- acres

GENERAL PLAN (existing) Agriculture GENERAL PLAN (proposed) N/A

ZONE (existing) A-2 (General Agriculture) ZONE (proposed) N/A

GENERAL PLAN FINDINGS CONSISTENT INCONSISTENT MAY BE/FINDINGS

PLANNING COMMISSION DECISION: HEARING DATE: _____

APPROVED DENIED OTHER

PLANNING DIRECTORS DECISION: HEARING DATE: _____

APPROVED DENIED OTHER

ENVIRONMENTAL EVALUATION COMMITTEE DECISION: HEARING DATE: 12/12/24

INITIAL STUDY: #23-0001

NEGATIVE DECLARATION MITIGATED NEG. DECLARATION EIR

DEPARTMENTAL REPORTS / APPROVALS:

PUBLIC WORKS	<input type="checkbox"/>	NONE	<input checked="" type="checkbox"/>	ATTACHED
AG	<input checked="" type="checkbox"/>	NONE	<input type="checkbox"/>	ATTACHED
APCD	<input type="checkbox"/>	NONE	<input checked="" type="checkbox"/>	ATTACHED
E.H.S.	<input checked="" type="checkbox"/>	NONE	<input type="checkbox"/>	ATTACHED
FIRE / OES	<input type="checkbox"/>	NONE	<input checked="" type="checkbox"/>	ATTACHED
SHERIFF	<input checked="" type="checkbox"/>	NONE	<input type="checkbox"/>	ATTACHED
OTHER	<u>IID</u>			

REQUESTED ACTION:

(See Attached)

Planning & Development Services

801 MAIN STREET, EL CENTRO, CA, 92243 442-265-1736

(Jim Minnick, Director)

D:\NATS\AllUsers\APN\062\080\015\CUP#23-0001\EEC\CUP23-0001_IS23-0001 EEC Prj Rprt.doc

- NEGATIVE DECLARATION**
- MITIGATED NEGATIVE DECLARATION**

*Initial Study & Environmental Analysis
For:*

**Initial Study #23-0001
Conditional Use Permit #23-0001
La Valle Sabia – Grain Feed Mill**



Prepared By:

COUNTY OF IMPERIAL
Planning & Development Services Department
801 Main Street
El Centro, CA 92243
(442) 265-1736
www.icpds.com

December 2024

TABLE OF CONTENTS

	<u>PAGE</u>
<u>SECTION 1</u>	
I. INTRODUCTION	3
<u>SECTION 2</u>	
II. ENVIRONMENTAL CHECKLIST	8
PROJECT SUMMARY	10
ENVIRONMENTAL ANALYSIS	13
I. AESTHETICS.....	15
II. AGRICULTURE AND FOREST RESOURCES.....	15
III. AIR QUALITY.....	16
IV. BIOLOGICAL RESOURCES.....	17
V. CULTURAL RESOURCES.....	18
VI. ENERGY.....	18
VII. GEOLOGY AND SOILS.....	16
VIII. GREENHOUSE GAS EMISSION.....	20
IX. HAZARDS AND HAZARDOUS MATERIALS.....	20
X. HYDROLOGY AND WATER QUALITY.....	21
XI. LAND USE AND PLANNING.....	22
XII. MINERAL RESOURCES.....	22
XIII. NOISE.....	23
XIV. POPULATION AND HOUSING.....	23
XV. PUBLIC SERVICES.....	24
XVI. RECREATION.....	24
XVII. TRANSPORTATION.....	25
XVIII. TRIBAL CULTURAL RESOURCES.....	21
XIX. UTILITIES AND SERVICE SYSTEMS.....	25
XX. WILDFIRE.....	25
<u>SECTION 3</u>	
III. MANDATORY FINDINGS OF SIGNIFICANCE	23
IV. PERSONS AND ORGANIZATIONS CONSULTED	24
V. REFERENCES	25
VI. NEGATIVE DECLARATION - COUNTY OF IMPERIAL	26
27 FINDINGS	27
<u>SECTION 4</u>	
VIII. RESPONSE TO COMMENTS (IF ANY)	28
IX. MITIGATION MONITORING & REPORTING PROGRAM (MMRP) (IF ANY)	29

SECTION 1 INTRODUCTION

A. PURPOSE

This document is a policy-level, project level Initial Study for evaluation of potential environmental impacts resulting with the proposed Conditional Use Permit #23-0001 for a grain feed mill. (Refer to Exhibit "A" & "B").

B. CALIFORNIA ENVIRONMENTAL QUALITY ACT (CEQA) REQUIREMENTS AND THE IMPERIAL COUNTY'S GUIDELINES FOR IMPLEMENTING CEQA

As defined by Section 15063 of the State California Environmental Quality Act (CEQA) Guidelines and Section 7 of the County's "CEQA Regulations Guidelines for the Implementation of CEQA, as amended", an **Initial Study** is prepared primarily to provide the Lead Agency with information to use as the basis for determining whether an Environmental Impact Report (EIR), Negative Declaration, or Mitigated Negative Declaration would be appropriate for providing the necessary environmental documentation and clearance for any proposed project.

According to Section 15065, an **EIR** is deemed appropriate for a particular proposal if the following conditions occur:

- The proposal has the potential to substantially degrade quality of the environment.
- The proposal has the potential to achieve short-term environmental goals to the disadvantage of long-term environmental goals.
- The proposal has possible environmental effects that are individually limited but cumulatively considerable.
- The proposal could cause direct or indirect adverse effects on human beings.

According to Section 15070(a), a **Negative Declaration** is deemed appropriate if the proposal would not result in any significant effect on the environment.

According to Section 15070(b), a **Mitigated Negative Declaration** is deemed appropriate if it is determined that though a proposal could result in a significant effect, mitigation measures are available to reduce these significant effects to insignificant levels.

This Initial Study has determined that the proposed applications will not result in any potentially significant environmental impacts and therefore, a Negative Declaration is deemed as the appropriate document to provide necessary environmental evaluations and clearance as identified hereinafter.

This Initial Study and Negative Declaration are prepared in conformance with the California Environmental Quality Act of 1970, as amended (Public Resources Code, Section 21000 et. seq.); Section 15070 of the State & County of Imperial's Guidelines for Implementation of the California Environmental Quality Act of 1970, as amended (California Code of Regulations, Title 14, Chapter 3, Section 15000, et. seq.); applicable requirements of the County of Imperial; and the regulations, requirements, and procedures of any other responsible public agency or an agency with jurisdiction by law.

Pursuant to the County of Imperial Guidelines for Implementing CEQA, depending on the project scope, the County of Imperial Board of Supervisors, Planning Commission and/or Planning Director is designated the Lead Agency, in accordance with Section 15050 of the CEQA Guidelines. The Lead Agency is the public agency which has the

principal responsibility for approving the necessary environmental clearances and analyses for any project in the County.

C. INTENDED USES OF INITIAL STUDY AND NEGATIVE DECLARATION

This Initial Study and Negative Declaration are informational documents which are intended to inform County of Imperial decision makers, other responsible or interested agencies, and the general public of potential environmental effects of the proposed applications. The environmental review process has been established to enable public agencies to evaluate environmental consequences and to examine and implement methods of eliminating or reducing any potentially adverse impacts. While CEQA requires that consideration be given to avoiding environmental damage, the Lead Agency and other responsible public agencies must balance adverse environmental effects against other public objectives, including economic and social goals.

The Initial Study and Negative Declaration, prepared for the project will be circulated for a period of 20 days (*30-days if submitted to the State Clearinghouse for a project of area-wide significance*) for public and agency review and comments. At the conclusion, if comments are received, the County Planning & Development Services Department will prepare a document entitled "Responses to Comments" which will be forwarded to any commenting entity and be made part of the record within 10-days of any project consideration.

D. CONTENTS OF INITIAL STUDY & NEGATIVE DECLARATION

This Initial Study is organized to facilitate a basic understanding of the existing setting and environmental implications of the proposed applications.

SECTION 1

I. INTRODUCTION presents an introduction to the entire report. This section discusses the environmental process, scope of environmental review, and incorporation by reference documents.

SECTION 2

II. ENVIRONMENTAL CHECKLIST FORM contains the County's Environmental Checklist Form. The checklist form presents results of the environmental evaluation for the proposed applications and those issue areas that would have either a potentially significant impact, potentially significant unless mitigation incorporated, less than significant impact or no impact.

PROJECT SUMMARY, LOCATION AND ENVIRONMENTAL SETTINGS describes the proposed project entitlements and required applications. A description of discretionary approvals and permits required for project implementation is also included. It also identifies the location of the project and a general description of the surrounding environmental settings.

ENVIRONMENTAL ANALYSIS evaluates each response provided in the environmental checklist form. Each response checked in the checklist form is discussed and supported with sufficient data and analysis as necessary. As appropriate, each response discussion describes and identifies specific impacts anticipated with project implementation.

SECTION 3

III. MANDATORY FINDINGS presents Mandatory Findings of Significance in accordance with Section 15065 of the CEQA Guidelines.

IV. PERSONS AND ORGANIZATIONS CONSULTED identifies those persons consulted and involved in

preparation of this Initial Study and Negative Declaration.

V. REFERENCES lists bibliographical materials used in preparation of this document.

VI. NEGATIVE DECLARATION – COUNTY OF IMPERIAL

VII. FINDINGS

SECTION 4

VIII. RESPONSE TO COMMENTS (IF ANY)

IX. MITIGATION MONITORING & REPORTING PROGRAM (MMRP) (IF ANY)

E. SCOPE OF ENVIRONMENTAL ANALYSIS

For evaluation of environmental impacts, each question from the Environmental Checklist Form is summarized and responses are provided according to the analysis undertaken as part of the Initial Study. Impacts and effects will be evaluated and quantified, when appropriate. To each question, there are four possible responses, including:

1. **No Impact:** A “No Impact” response is adequately supported if the impact simply does not apply to the proposed applications.
2. **Less Than Significant Impact:** The proposed applications will have the potential to impact the environment. These impacts, however, will be less than significant; no additional analysis is required.
3. **Potentially Significant Unless Mitigation Incorporated:** This applies where incorporation of mitigation measures has reduced an effect from “Potentially Significant Impact” to a “Less Than Significant Impact”.
4. **Potentially Significant Impact:** The proposed applications could have impacts that are considered significant. Additional analyses and possibly an EIR could be required to identify mitigation measures that could reduce these impacts to less than significant levels.

F. POLICY-LEVEL or PROJECT LEVEL ENVIRONMENTAL ANALYSIS

This Initial Study and Negative Declaration will be conducted under a policy-level, project level analysis. Regarding mitigation measures, it is not the intent of this document to “overlap” or restate conditions of approval that are commonly established for future known projects or the proposed applications. Additionally, those other standard requirements and regulations that any development must comply with, that are outside the County’s jurisdiction, are also not considered mitigation measures and therefore, will not be identified in this document.

G. TIERED DOCUMENTS AND INCORPORATION BY REFERENCE

Information, findings, and conclusions contained in this document are based on incorporation by reference of tiered documentation, which are discussed in the following section.

1. Tiered Documents

As permitted in Section 15152(a) of the CEQA Guidelines, information and discussions from other documents can be included into this document. Tiering is defined as follows:

“Tiering refers to using the analysis of general matters contained in a broader EIR (such as the one prepared

for a general plan or policy statement) with later EIRs and negative declarations on narrower projects; incorporating by reference the general discussions from the broader EIR; and concentrating the later EIR or negative declaration solely on the issues specific to the later project.”

Tiering also allows this document to comply with Section 15152(b) of the CEQA Guidelines, which discourages redundant analyses, as follows:

“Agencies are encouraged to tier the environmental analyses which they prepare for separate but related projects including the general plans, zoning changes, and development projects. This approach can eliminate repetitive discussion of the same issues and focus the later EIR or negative declaration on the actual issues ripe for decision at each level of environmental review. Tiering is appropriate when the sequence of analysis is from an EIR prepared for a general plan, policy or program to an EIR or negative declaration for another plan, policy, or program of lesser scope, or to a site-specific EIR or negative declaration.”

Further, Section 15152(d) of the CEQA Guidelines states:

“Where an EIR has been prepared and certified for a program, plan, policy, or ordinance consistent with the requirements of this section, any lead agency for a later project pursuant to or consistent with the program, plan, policy, or ordinance should limit the EIR or negative declaration on the later project to effects which:

- (1) Were not examined as significant effects on the environment in the prior EIR; or
- (2) Are susceptible to substantial reduction or avoidance by the choice of specific revisions in the project, by the imposition of conditions, or other means.”

2. Incorporation By Reference

Incorporation by reference is a procedure for reducing the size of EIRs/MND and is most appropriate for including long, descriptive, or technical materials that provide general background information, but do not contribute directly to the specific analysis of the project itself. This procedure is particularly useful when an EIR or Negative Declaration relies on a broadly drafted EIR for its evaluation of cumulative impacts of related projects (*Las Virgenes Homeowners Federation v. County of Los Angeles* [1986, 177 Ca.3d 300]). If an EIR or Negative Declaration relies on information from a supporting study that is available to the public, the EIR or Negative Declaration cannot be deemed unsupported by evidence or analysis (*San Francisco Ecology Center v. City and County of San Francisco* [1975, 48 Ca.3d 584, 595]). This document incorporates by reference appropriate information from the “Final Environmental Impact Report and Environmental Assessment for the “County of Imperial General Plan EIR” prepared by Brian F. Mooney Associates in 1993 and updates.

When an EIR or Negative Declaration incorporates a document by reference, the incorporation must comply with Section 15150 of the CEQA Guidelines as follows:

- The incorporated document must be available to the public or be a matter of public record (CEQA Guidelines Section 15150[a]). The General Plan EIR and updates are available, along with this document, at the County of Imperial Planning & Development Services Department, 801 Main Street, El Centro, CA 92243 Ph. (442) 265-1736.
- This document must be available for inspection by the public at an office of the lead agency (CEQA Guidelines Section 15150[b]). These documents are available at the County of Imperial Planning & Development Services Department, 801 Main Street, El Centro, CA 92243 Ph. (442) 265-1736.
- These documents must summarize the portion of the document being incorporated by reference or briefly

describe information that cannot be summarized. Furthermore, these documents must describe the relationship between the incorporated information and the analysis in the tiered documents (CEQA Guidelines Section 15150[c]). As discussed above, the tiered EIRs address the entire project site and provide background and inventory information and data which apply to the project site. Incorporated information and/or data will be cited in the appropriate sections.

- These documents must include the State identification number of the incorporated documents (CEQA Guidelines Section 15150[d]). The State Clearinghouse Number for the County of Imperial General Plan EIR is SCH #93011023.
- The material to be incorporated in this document will include general background information (CEQA Guidelines Section 15150[f]). This has been previously discussed in this document.

II. *Environmental Checklist*

1. **Project Title:** La Valle Sabia - Conditional Use Permit #23-0001 / Initial Study #23-0001
2. **Lead Agency:** Imperial County Planning & Development Services Department
3. **Contact person and phone number:** Derek Newland, Planner III, (442)265-1736, ext. 1756
4. **Address:** 801 Main Street, El Centro CA, 92243
5. **E-mail:** dereknewland@co.imperial.ca.us
6. **Project location:** 2015 Silsbee Road, El Centro, CA 92243
7. **Project sponsor's name and address:** 2015 Silsbee Road, El Centro, CA 92243
8. **General Plan designation:** Agriculture
9. **Zoning:** A-2 (General Agriculture)

10. **Description of project:** The project proposes Conditional Use Permit #23-0001 to construct and operate a grain feed mill located within the boundaries of a fully developed parcel consisting of an existing hay storage yard, seed mill, and ground installed solar field. Ground cover consists of compacted dirt, paved areas and concrete. The mill will be located on a +/- 5,730 square foot area of a +/- 35.80 acres parcel. The proposed project consists of two (2) 500-ton grain silos that are 46 feet high and a width of 29 feet, two (2) holding tanks that are 29 feet, 2 inches high and a width of 15 feet, 4 inches, and two (2) flaking mills with steam chests that are 34 feet high and a width of 7 feet that sit on top of structural and concrete bunkers that are 11 feet, 4 inches high and a width of 34 feet. The total height of the flaking mills with the structural bunkers will be 45 feet in height. Additionally, there will be two (2) grain elevators that are 70 feet high and a width of 10 feet, a 60 feet high grain elevator with a width of 8 feet and two (2) grain holding tanks are 29 feet high and 16 feet in width. The feed produced from the mill is a flaked corn and wheat mixture that will be stored in concrete bunkers before being shipped out to the LVS Cattle Feeders Feed Yard located at 495 W. Heber Rd., El Centro, CA. The corn will be shipped in from Calipatria, CA and the wheat will come from the onsite seed mill. The grains will be stored in the 500-ton silos until processed. The proposed hours of operation for feed processing and delivery is 12 am to 6 am, Monday through Saturday. Daily traffic is expected to be 8 trucks a day entering and leaving the site along with 2 employee vehicles entering and leaving.

11. **Surrounding land uses and setting:** The proposed project site is located on an active developed parcel containing a hay press, seed mill, hay storage, ground mounted solar panels as well as agricultural vehicle storage. The project is surrounded by A-2 (general agriculture) zoned land with actively farmed agricultural fields and a house to the east of the project and housing directly west. South of the project site are actively farmed agricultural fields, and the north has actively farmed agricultural fields as well as large hay storage sites associated with the project parcel.

12. **Other public agencies whose approval is required** (e.g., permits, financing approval, or participation agreement.): Imperial County Air Pollution Control District (ICAPCD), Imperial County Fire Department (ICFD, Planning Commission

13. Have California Native American tribes traditionally and culturally affiliated with the project area requested consultation pursuant to Public Resources Code section 21080.3.1? If so, is there a plan for consultation that includes, for example, the determination of significance of impacts to tribal cultural resources, procedures regarding confidentiality, etc.?

Letters providing an opportunity for consultation per AB 52 were sent out to the Campo Band of Mission Indians and the Quechan Indian Tribe on May 3, 2023, with a no comment response received from the Quechan on May 3, 2023, and a request for consultation received from the Campo Band of Mission Indians on May 22, 2023. After communication with the Campo Band of Mission Indians' representative via phone call on June 2, 2023, a comment of no further concerns was received the same day

Note: Conducting consultation early in the CEQA process allows tribal governments, lead agencies, and project proponents to discuss the level of environmental review, identify and address potential adverse impacts to tribal cultural resources, and reduce the potential for delay and conflict in the environmental review process. (See Public Resources Code, Section 21080.3.2). Information may also be available from the California Native American Heritage Commission's Sacred Lands File per Public Resources Code, Section 5097.96 and the California Historical Resources Information System administered by the California Office of Historic Preservation. Please also note that Public Resources Code, Section 21082.3 (c) contains provisions specific to confidentiality.

ENVIRONMENTAL FACTORS POTENTIALLY AFFECTED:

The environmental factors checked below would be potentially affected by this project, involving at least one impact that is a "Potentially Significant Impact" as indicated by the checklist on the following pages.

- | | | |
|--|---|---|
| <input type="checkbox"/> Aesthetics | <input type="checkbox"/> Agriculture and Forestry Resources | <input type="checkbox"/> Air Quality |
| <input type="checkbox"/> Biological Resources | <input type="checkbox"/> Cultural Resources | <input type="checkbox"/> Energy |
| <input type="checkbox"/> Geology /Soils | <input type="checkbox"/> Greenhouse Gas Emissions | <input type="checkbox"/> Hazards & Hazardous Materials |
| <input type="checkbox"/> Hydrology / Water Quality | <input type="checkbox"/> Land Use / Planning | <input type="checkbox"/> Mineral Resources |
| <input type="checkbox"/> Noise | <input type="checkbox"/> Population / Housing | <input type="checkbox"/> Public Services |
| <input type="checkbox"/> Recreation | <input type="checkbox"/> Transportation | <input type="checkbox"/> Tribal Cultural Resources |
| <input type="checkbox"/> Utilities/Service Systems | <input type="checkbox"/> Wildfire | <input type="checkbox"/> Mandatory Findings of Significance |

ENVIRONMENTAL EVALUATION COMMITTEE (EEC) DETERMINATION

After Review of the Initial Study, the Environmental Evaluation Committee has:

- Found that the proposed project COULD NOT have a significant effect on the environment, and a NEGATIVE DECLARATION will be prepared.
- Found that although the proposed project could have a significant effect on the environment, there will not be a significant effect in this case because revisions in the project have been made by or agreed to by the project proponent. A MITIGATED NEGATIVE DECLARATION will be prepared.
- Found that the proposed project MAY have a significant effect on the environment, and an ENVIRONMENTAL IMPACT REPORT is required.
- Found that the proposed project MAY have a "potentially significant impact" or "potentially significant unless mitigated" impact on the environment, but at least one effect 1) has been adequately analyzed in an earlier document pursuant to applicable legal standards, and 2) has been addressed by mitigation measures based on the earlier analysis as described on attached sheets. An ENVIRONMENTAL IMPACT REPORT is required, but it must analyze only the effects that remain to be addressed.
- Found that although the proposed project could have a significant effect on the environment, because all potentially significant effects (a) have been analyzed adequately in an earlier EIR or NEGATIVE DECLARATION pursuant to applicable standards, and (b) have been avoided or mitigated pursuant to that earlier EIR or NEGATIVE DECLARATION, including revisions or mitigation measures that are imposed upon the proposed project, nothing further is required.

<u>EEC VOTES</u>	<u>YES</u>	<u>NO</u>	<u>ABSENT</u>
PUBLIC WORKS	<input type="checkbox"/>	<input type="checkbox"/>	<input type="checkbox"/>
ENVIRONMENTAL HEALTH SVCS	<input type="checkbox"/>	<input type="checkbox"/>	<input type="checkbox"/>
OFFICE EMERGENCY SERVICES	<input type="checkbox"/>	<input type="checkbox"/>	<input type="checkbox"/>
APCD	<input type="checkbox"/>	<input type="checkbox"/>	<input type="checkbox"/>
AG	<input type="checkbox"/>	<input type="checkbox"/>	<input type="checkbox"/>
SHERIFF DEPARTMENT	<input type="checkbox"/>	<input type="checkbox"/>	<input type="checkbox"/>
ICPDS	<input type="checkbox"/>	<input type="checkbox"/>	<input type="checkbox"/>

Jim Minnick, Director of Planning/EEC Chairman

Date:

PROJECT SUMMARY

- A. Project Location:** The project is located at 2015 Silsbee Road, El Centro, CA 92243 on Assessor's Parcel Number 062-080-015-000.
- B. Project Summary:** The project proposes to construct and operate a grain mill to process corn and wheat into a flaked cattle feed to be transported and used at the LVS Cattle Feeders Feed Yard at 495 W. Heber Road, El Centro, CA 92243.
- C. Environmental Setting:** The proposed project is located within a +/- 5,730 square foot area within a developed +/- 35.8 square foot parcel containing a hay press, hay storage yard.
- D. Analysis:** The project site is designated as A-2 General Agriculture under Imperial County's Title 9 Land Use Ordinance Zone Map #09. The proposed grain feed mill is an allowed use under Title 9, Division 5 Section 90515.02 "Uses permitted only with a conditional use permit" xx) seed mills.
- E. General Plan Consistency:** The project could be found consistent with the General Plan as the property is designated as "Agriculture" and zone A-2 (General Agriculture) where the proposed use is allowed with an approved Conditional Use Permit.

Exhibit "A"
Vicinity Map



LA VALLE SABBIA, INC
CUP #23-0001
APN 062-080-015-000





-  Project Location
-  Centerline
-  Parcels
-  Proposed Feed Mill Location



Exhibit "B"

Site Plan/Tract Map/etc.

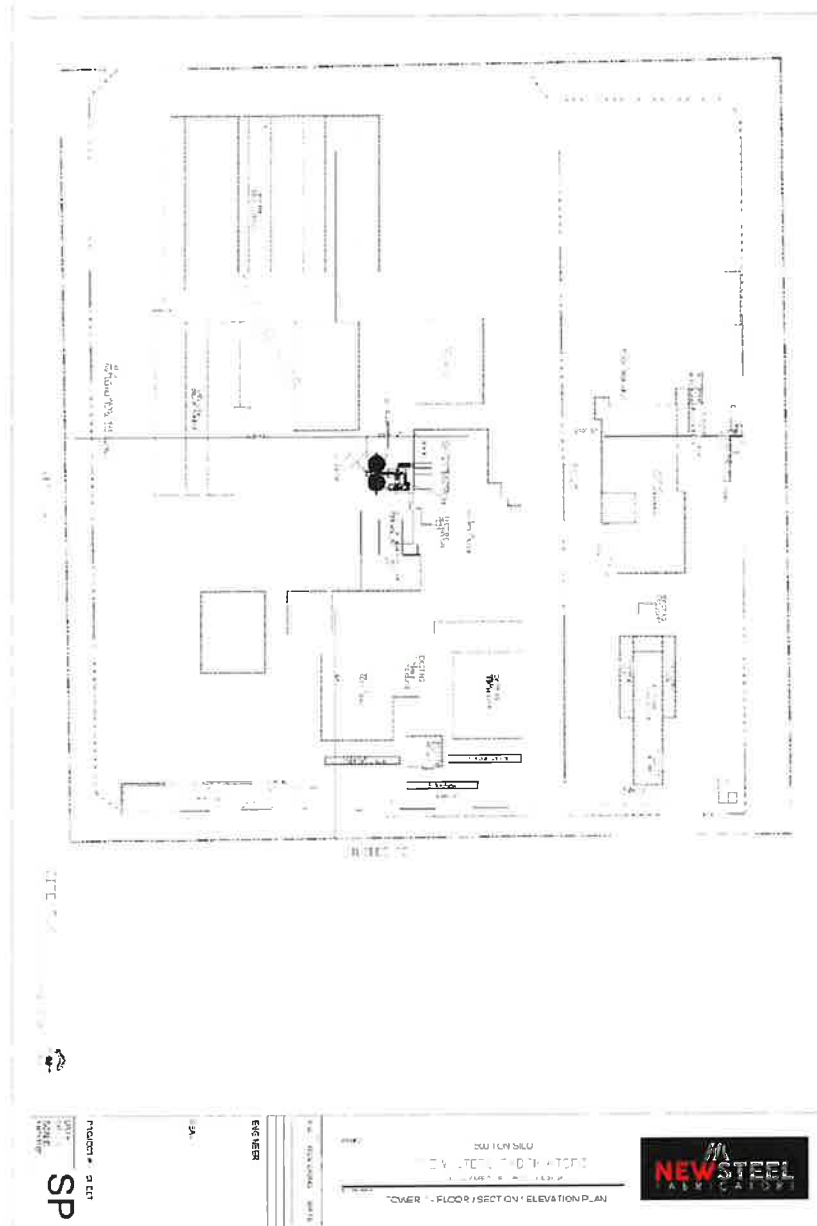

EVALUATION OF ENVIRONMENTAL IMPACTS:

- 1) A brief explanation is required for all answers except "No Impact" answers that are adequately supported by the information sources a lead agency cites in the parentheses following each question. A "No Impact" answer is adequately supported if the referenced information sources show that the impact simply does not apply to projects like the one involved (e.g., the project falls outside a fault rupture zone). A "No Impact" answer should be explained where it is based on project-specific factors as well as general standards (e.g., the project will not expose sensitive receptors to pollutants, based on a project-specific screening analysis).
- 2) All answers must take account of the whole action involved, including off-site as well as on-site, cumulative as well as project-level, indirect as well as direct, and construction as well as operational impacts.
- 3) Once the lead agency has determined that a particular physical impact may occur, then the checklist answers must indicate whether the impact is potentially significant, less than significant with mitigation, or less than significant. "Potentially Significant Impact" is appropriate if there is substantial evidence that an effect may be significant. If there are one or more "Potentially Significant Impact" entries when the determination is made, an EIR is required.
- 4) "Negative Declaration: Less Than Significant With Mitigation Incorporated" applies where the incorporation of mitigation measures has reduced an effect from "Potentially Significant Impact" to a "Less Than Significant Impact." The lead agency must describe the mitigation measures, and briefly explain how they reduce the effect to a less than significant level (mitigation measures from "Earlier Analyses," as described in (5) below, may be cross-referenced).
- 5) Earlier analyses may be used where, pursuant to the tiering, program EIR, or other CEQA process, an effect has been adequately analyzed in an earlier EIR or negative declaration. Section 15063(c)(3)(D). In this case, a brief discussion should identify the following:
 - a) Earlier Analysis Used. Identify and state where they are available for review.
 - b) Impacts Adequately Addressed. Identify which effects from the above checklist were within the scope of and adequately analyzed in an earlier document pursuant to applicable legal standards, and state whether such effects were addressed by mitigation measures based on the earlier analysis.
 - c) Mitigation Measures. For effects that are "Less than Significant with Mitigation Measures Incorporated," describe the mitigation measures which were incorporated or refined from the earlier document and the extent to which they address site-specific conditions for the project.
- 6) Lead agencies are encouraged to incorporate into the checklist references to information sources for potential impacts (e.g., general plans, zoning ordinances). Reference to a previously prepared or outside document should, where appropriate, include a reference to the page or pages where the statement is substantiated.
- 7) Supporting Information Sources: A source list should be attached, and other sources used or individuals contacted should be cited in the discussion.
- 8) This is only a suggested form, and lead agencies are free to use different formats; however, lead agencies should normally address the questions from this checklist that are relevant to a project's environmental effects in whatever format is selected.
- 9) The explanation of each issue should identify:
 - a) the significance criteria or threshold, if any, used to evaluate each question; and
 - b) the mitigation measure identified, if any, to reduce the impact to less than significance

Potentially Significant Impact (PSI)	Less Than Significant with Mitigation Incorporated (LTSMI)	Less Than Significant Impact (LTSI)	No Impact (NI)
--------------------------------------	--	-------------------------------------	----------------

I. AESTHETICS

Except as provided in Public Resources Code Section 21099, would the project:

- a) Have a substantial adverse effect on a scenic vista or scenic highway?

a) The proposed grain feed mill is not located within a scenic vista or scenic highway as shown on the Circulation and Scenic Highway Element of the Imperial County General Plan. No impacts are expected.
- b) Substantially damage scenic resources, including, but not limited to trees, rock outcroppings, and historic buildings within a state scenic highway?

b) The proposed grain feed mill location is within the boundaries of an existing hay storage yard, seed mill, and ground installed solar field and will not damage scenic resources including trees, outcropping, and historic buildings and is not within a scenic highway. No impacts are expected.
- c) In non-urbanized areas, substantially degrade the existing visual character or quality of public views of the site and its surrounding? (Public views are those that are experienced from publicly accessible vantage point.) If the project is in an urbanized area, would the project conflict with applicable zoning and other regulations governing scenic quality?

c) The proposed grain feed mill to be located in a non-urbanized area and within the boundaries of an existing active hay storage yard, seed mill, and ground installed solar field. It is not expected the proposed project will degrade the existing visual character or quality of public views of the site and its surrounding. Any impacts are considered to be less than significant.
- d) Create a new source of substantial light or glare which would adversely affect day or nighttime views in the area?

d) Any new lighting required for the proposed grain feed mill located within the boundaries of an existing hay storage yard, seed mill, and ground installed solar field will be required to be shielded from adjacent properties and roads by the conditions set out in an approved CUP. Any impacts are considered to be less than significant.

II. AGRICULTURE AND FOREST RESOURCES

In determining whether impacts to agricultural resources are significant environmental effects, lead agencies may refer to the California Agricultural Land Evaluation and Site Assessment Model (1997) prepared by the California Department of Conservation as an optional model to use in assessing impacts on agriculture and farmland. In determining whether impacts to forest resources, including timberland, are significant environmental effects, lead agencies may refer to information compiled by the California Department of Forestry and Fire Protection regarding the state's inventory of forest land, including the Forest and Range Assessment Project and the Forest Legacy Assessment project; and forest carbon measurement methodology provided in Forest Protocols adopted by the California Air Resources Board. --Would the project:

- a) Convert Prime Farmland, Unique Farmland, or Farmland of Statewide Importance (Farmland), as shown on the maps prepared pursuant to the Farmland Mapping and Monitoring Program of the California Resources Agency, to non-agricultural use?

a) The proposed grain feed mill is located within the boundaries of an existing hay storage yard, seed mill, and ground installed solar field and would not convert any farmland pursuant to the FMMP farmland map. The project area is labeled as "Urban and Built-Up Land" and therefore no impacts are expected.
- b) Conflict with existing zoning for agricultural use, or a Williamson Act Contract?

b) The project location is zoned A-2 (General Agriculture), and the proposed grain feed mill would be an allowed use with an approved Conditional Use Permit. Additionally, there are no active Williamson Act Contracts in Imperial County, therefore no impacts are expected.

	Potentially Significant Impact (PSI)	Less Than Significant with Mitigation Incorporated (LTSMI)	Less Than Significant Impact (LTSI)	No Impact (NI)
c) Conflict with existing zoning for, or cause rezoning of, forest land (as defined in Public Resources Code section 12220(g)), timberland (as defined by Public Resources Code section 4526), or timberland zoned Timberland Production (as defined by Government Code Section 51104(g))? c) The proposed grain feed mill will be located within an existing hay storage yard, seed mill, and ground installed solar field and would not conflict with existing zoning as it would be an allowed use with an approved CUP and will not cause rezoning of forest land, timberland or timberland zoned timberland production. No impacts are expected.	<input type="checkbox"/>	<input type="checkbox"/>	<input type="checkbox"/>	<input checked="" type="checkbox"/>
d) Result in the loss of forest land or conversion of forest land to non-forest use? d) The proposed grain feed mill will be located within an existing hay storage yard, seed mill, and ground installed solar field and would not result in loss of forest land or conversion of forest land. No impacts are expected.	<input type="checkbox"/>	<input type="checkbox"/>	<input type="checkbox"/>	<input checked="" type="checkbox"/>
e) Involve other changes in the existing environment which, due to their location or nature, could result in conversion of Farmland, to non-agricultural use or conversion of forest land to non-forest use? e) The proposed grain feed mill will be located within an existing hay storage yard, seed mill, and ground installed solar field and would not involve changes in existing environment which due to their location or nature, could result in conversion of farmland, to non-agricultural use or conversion of forest land to non-forest use. No impacts are expected.	<input type="checkbox"/>	<input type="checkbox"/>	<input type="checkbox"/>	<input checked="" type="checkbox"/>

III. AIR QUALITY

Where available, the significance criteria established by the applicable air quality management district or air pollution control district may be relied upon to the following determinations. Would the Project:

- | | | | | |
|--|--------------------------|--------------------------|-------------------------------------|--------------------------|
| a) Conflict with or obstruct implementation of the applicable air quality plan?
a) The proposed project would be required to adhere to the requirements of the Air Pollution Control District (APCD). The proposed project must comply with APCD's rules and regulations with emphasis on Regulation VIII – Fugitive Dust Rules. The project will also have to obtain any required permits from APCD¹. Any impacts are considered to be less than significant. | <input type="checkbox"/> | <input type="checkbox"/> | <input checked="" type="checkbox"/> | <input type="checkbox"/> |
| b) Result in a cumulatively considerable net increase of any criteria pollutant for which the project region is non-attainment under an applicable federal or state ambient air quality standard?
b) It is expected that adherence to the requirements set out above in section III a) would prevent the project from resulting in a cumulatively considerable net increase of any criteria pollutant for which the project region is non-attainment under an applicable federal or state ambient air quality standard during operation or construction of the proposed grain feed mill. Any impacts are considered to be less than significant. | <input type="checkbox"/> | <input type="checkbox"/> | <input checked="" type="checkbox"/> | <input type="checkbox"/> |
| c) Expose sensitive receptors to substantial pollutants concentrations?
c) The proposed grain feed mill will be located within the boundaries of an existing hay storage yard, seed mill, and ground installed solar field which has single family housing nearby. It is expected that adherence to the APCD requirements as explained in III a) would limit exposure to sensitive receptors to substantial pollutant concentrations during construction and operation to less than significant impacts. | <input type="checkbox"/> | <input type="checkbox"/> | <input checked="" type="checkbox"/> | <input type="checkbox"/> |
| d) Result in other emissions (such as those leading to odors adversely affecting a substantial number of people)?
d) The proposed grain feed mill will be located within an existing hay storage yard, seed mill, and ground installed solar field and will consist of processing corn and wheat into cattle feed. The project must obtain any required permits from APCD and comply with the agency's rules and regulations. Any impacts are considered to be less than significant. | <input type="checkbox"/> | <input type="checkbox"/> | <input checked="" type="checkbox"/> | <input type="checkbox"/> |

¹ Imperial County Air Pollution Control District comment letter dated May 15, 2023

Potentially Significant Impact (PSI)	Less Than Significant with Mitigation Incorporated (LTSMI)	Less Than Significant Impact (LTSI)	No Impact (NI)
--------------------------------------	--	-------------------------------------	----------------

IV. **BIOLOGICAL RESOURCES** *Would the project:*

- | | | | | | |
|----|---|--------------------------|--------------------------|-------------------------------------|--------------------------|
| a) | Have a substantial adverse effect, either directly or through habitat modifications, on any species identified as a candidate, sensitive, or special status species in local or regional plans, policies or regulations, or by the California Department of Fish and Wildlife or U.S. Fish and Wildlife Service? | <input type="checkbox"/> | <input type="checkbox"/> | <input checked="" type="checkbox"/> | <input type="checkbox"/> |
| | a) The proposed grain feed mill will be located within an existing hay storage yard, seed mill, and ground installed solar field which is disturbed land and does not appear to have a substantial adverse effect, either directly or through habitat modifications, on any species identified as a candidate, sensitive, or special status species in local or regional plans, policies or regulations, or by the California Department of Fish and Wildlife or U.S. Fish and Wildlife Service. Any impacts are considered to be less than significant. | | | | |
| b) | Have a substantial adverse effect on any riparian habitat or other sensitive natural community identified in local or regional plans, policies, regulations, or by the California Department of Fish and Wildlife or U.S. Fish and Wildlife Service? | <input type="checkbox"/> | <input type="checkbox"/> | <input checked="" type="checkbox"/> | <input type="checkbox"/> |
| | b) The proposed grain feed mill will be located within an existing hay storage yard, seed mill, and ground installed solar field which is disturbed land and does not appear to have a substantial effect on any riparian habitat or other sensitive natural community identified in local or regional plans, policies, regulations, or by the California Department of Fish and Wildlife or U.S. Fish and Wildlife Service. Any impacts are considered to be less than significant. | | | | |
| c) | Have a substantial adverse effect on state or federally protected wetlands (including, but not limited to, marsh, vernal pool, coastal, etc.) through direct removal, filling, hydrological interruption, or other means? | <input type="checkbox"/> | <input type="checkbox"/> | <input checked="" type="checkbox"/> | <input type="checkbox"/> |
| | c) The proposed project is not located on or near state or federally protected wetlands. As previously stated, the project will be located on an already developed parcel and therefore, is not anticipated to have a substantial adverse effect on state or federally protected wetlands through direct removal, filling, hydrological interruption, or other means. Any impacts are expected to be less than significant. | | | | |
| d) | Interfere substantially with the movement of any resident or migratory fish or wildlife species or with established native resident or migratory wildlife corridors, or impede the use of native wildlife nursery sites? | <input type="checkbox"/> | <input type="checkbox"/> | <input checked="" type="checkbox"/> | <input type="checkbox"/> |
| | d) The proposed project is located on a developed parcel with an active hay storage yard, seed mill, farm equipment storage and ground installed solar field and active truck traffic that utilizes established County roads. Therefore, it is not anticipated that the project would substantially interfere with the movement of any resident or migratory fish or wildlife corridors or impede the use of native wildlife species or with established native resident or migrator wildlife corridors or impede the use of native wildlife nursery sites. Any impacts would be considered less than significant. | | | | |
| e) | Conflict with any local policies or ordinance protecting biological resource, such as a tree preservation policy or ordinance? | <input type="checkbox"/> | <input type="checkbox"/> | <input checked="" type="checkbox"/> | <input type="checkbox"/> |
| | e) As previously stated in this section the proposed project is located on a developed parcel and is not expected to conflict with any local policies or ordinance protecting biological resource, such as a tree preservation policy or ordinance. Any impacts would be considered less than significant. | | | | |
| f) | Conflict with the provisions of an adopted Habitat Conservation Plan, Natural Community Conservation Plan, or other approved local, regional, or state habitat conservation plan? | <input type="checkbox"/> | <input type="checkbox"/> | <input checked="" type="checkbox"/> | <input type="checkbox"/> |
| | f) As previously stated in this section the proposed project is on a fully developed and utilized +/- 35.8 acres parcel and is not expected to conflict with the provisions of an adopted Habitat Conservation Plan, Natural Community Conservation Plan, or other approved local, regional, or state habitat conservation plan. Any impacts would be considered less than significant. | | | | |

Potentially Significant Impact (PSI)	Less Than Significant with Mitigation Incorporated (LTSMI)	Less Than Significant Impact (LTSI)	No Impact (NI)
--------------------------------------	--	-------------------------------------	----------------

V. **CULTURAL RESOURCES** *Would the project:*

- a) Cause a substantial adverse change in the significance of a historical resource pursuant to §15064.5?
a) The proposed grain feed mill is not anticipated to cause a substantial adverse change in the significance of a historical resource pursuant to §15064.5 as the project area is located within a +/- 5,730 square feet area on a +/- 35.8 acres disturbed and developed parcel with an active hay storage yard, seed mill, farm equipment storage and ground installed solar field. Additionally, letters providing an opportunity for consultation per AB 52 were sent out to the Campo Band of Mission Indians and the Quechan Indian Tribe on May 3, 2023, with a no comment response received from the Quechan on May 3, 2023, and a request for consultation received from the Campo Band of Mission Indians on May 22, 2023. After communication with the Campo Band of Mission Indians' representative via phone call on June 2, 2023, a comment of no further concerns was received the same day. Therefore, impacts are expected to less than significant.
- b) Cause a substantial adverse change in the significance of an archaeological resource pursuant to §15064.5?
b) As stated above in V-a, the project site is located within a disturbed and developed and actively used parcel and the contacted Native American Tribes per AB 52 have expressed no concerns. Therefore, the project is not expected to cause a substantial adverse change in the significance of an archaeological resource pursuant to §15064.5. Impacts are expected to be less than significant.
- c) Disturb any human remains, including those interred outside of dedicated cemeteries?
c) As stated earlier in this section, the project is located on a disturbed and developed parcel. There are no known cemeteries on or surrounding the project site and the project site is not known to have been a formal or informal cemetery or burial site. Therefore, the proposed grain feed mill is not expected to disturb any human remains and less than significant impacts are anticipated.

VI. **ENERGY** *Would the project:*

- a) Result in potentially significant environmental impact due to wasteful, inefficient, or unnecessary consumption of energy resources, during project construction or operation?
a) The proposed grain feed mill will be located within the boundaries of an existing hay storage yard, seed mill, and a ground installed solar field and roof mounted solar for onsite consumption. It is not expected that the addition of the grain feed mill to the site will result in a potentially significant environmental impact due to wasteful, inefficient, or unnecessary consumption of energy resources, during project construction or operation. Any impacts are anticipated to be less than significant.
- b) Conflict with or obstruct a state or local plan for renewable energy or energy efficiency?
b) As stated in VI-a, the proposed project is located on a developed parcel with onsite renewable energy generation and is not expected to conflict with or obstruct a state or local plan for renewable energy or energy efficiency. Any impacts are anticipated to be less than significant.

VII. **GEOLOGY AND SOILS** *Would the project:*

- a) Directly or indirectly cause potential substantial adverse effects, including risk of loss, injury, or death involving:
a) The proposed project does not appear to directly or indirectly cause potential adverse effects, including risk of loss, injury, or death as the proposed grain feed mill will be located within the boundaries of an existing hay storage yard, seed mill, and ground installed solar field and is not located near a known earthquake fault, nor does it appear that the ground the project is located on is prone to ground failure or liquefaction, and is not located in an area prone to landslides. Additionally, any construction in the property will require a building and/or grading permit to secure proper execution. Therefore, less than significant impacts are expected.
- 1) Rupture of a known earthquake fault, as delineated on the most recent Alquist-Priolo Earthquake Fault Zoning Map issued by the State Geologist for the area or based on other substantial evidence of a known fault? Refer to

Division of Mines and Geology Special Publication 42?

1) Per the California Department of Conservation CGS Seismic Hazards Program: Alquist-Priolo Fault Zones web application² the project is located about +/- 3 miles southwest of the nearest known fault zone and therefore, is not expected to directly or indirectly cause potential substantial adverse effects, including risk of loss, injury or death involving the rupture of a known earthquake fault. Impacts are expected to be less than significant.

- 2) Strong Seismic ground shaking?

2) Ground shaking is expected as the project is located in the seismically active Imperial Valley with numerous mapped faults of the San Andreas Fault System traversing the region. The project site is a developed parcel which has existing structures that have been in place for many years. The structures composing the proposed grain feed mill will be required to comply with the current California Building Codes at the time of permitting and construction. Therefore, any impacts are anticipated to be less than significant.

- 3) Seismic-related ground failure, including liquefaction and seiche/tsunami?

3) The proposed grain feed mill will be located within the boundaries of an existing hay storage yard, seed mill, and ground installed solar field. The proposed project location is next to the hay press which is under a metal structure that has been in place for many years and the ground is currently compacted dirt in which a concrete foundation will be poured for the grain feed mill structures. Due to the development on site and stability of the existing structures, it does not appear that the project is on a geologic unit or soil that is unstable or that would become unstable as a result of seismic activities, including liquefaction or seiche/tsunami. Less than significant impacts are expected.

- 4) Landslides?

4) According to the Imperial County General Plan Landslide Activity Map, Figure 2³, Seismic and Public Safety Element, the project site does not lie within a landslide activity area and therefore, no impacts are anticipated.

- b) Result in substantial soil erosion or the loss of topsoil?

b) As stated above in VII-a3, the project is on a developed parcel with the project area consisting of compacted dirt which will have concrete foundations poured for the proposed grain feed mill structures. Therefore, it is not anticipated that the project would result in substantial soil erosion or the loss of topsoil. Any impacts would be considered less than significant.

- c) Be located on a geologic unit or soil that is unstable or that would become unstable as a result of the project, and potentially result in on- or off-site landslides, lateral spreading, subsidence, liquefaction or collapse?

c) As stated in VII-a3, the project is on a developed site with existing structures and does not appear to be located on a geologic unit or soil that is unstable or that would become unstable as a result of the project and would not potentially result in on- or off-site landslides, lateral spreading, subsidence, liquefaction or collapse. Additionally, as stated in VII-a4, the project is not located in area that is subject to landslides. Therefore, any impacts would be considered less than significant.

- d) Be located on expansive soil, as defined in the latest Uniform Building Code, creating substantial direct or indirect risk to life or property?

d) As stated earlier in this section the project is located on a developed parcel that has had existing structures on it for years and multiple building permits. Any new development on the project including the proposed grain feed mill will be required to conform to the latest California Building Code. Therefore, it is not expected that the project would be located on expansive soil which would create a substantial direct or indirect risk to life or property and any impacts would be considered less than significant.

- e) Have soils incapable of adequately supporting the use of septic tanks or alternative waste water disposal systems where sewers are not available for the disposal of waste water?

e) The proposed project parcel currently has permitted septic systems in place and the addition of the grain feed mill, and 2 additional employees onsite will not necessitate the need for a new septic system or upgrade of the existing systems. Additionally, no new septic systems are proposed as part of the project. Therefore, any impacts would be considered less than significant.

² California Department of Conservation CGS Seismic Hazards Program: Alquist-Priolo Fault Hazard Zones web application

³ Imperial County General Plan Landslide Activity Map, Figure 2

	Potentially Significant Impact (PSI)	Less Than Significant with Mitigation Incorporated (LTSMI)	Less Than Significant Impact (LTSI)	No Impact (NI)
f) Directly or indirectly destroy a unique paleontological resource or site or unique geologic feature? f) The proposed grain feed mill will be located within the boundaries of an existing hay storage yard, seed mill, and ground installed solar field. The project will be located on +/- 5,730 square feet area that is compacted dirt which will have concrete foundations poured for the mill structures. It is not anticipated that the project would directly or indirectly destroy a unique paleontological resource or site or unique geologic feature, therefore, any impacts would be considered less than significant.	<input type="checkbox"/>	<input type="checkbox"/>	<input checked="" type="checkbox"/>	<input type="checkbox"/>

VIII. **GREENHOUSE GAS EMISSION** *Would the project:*

- | | | | | |
|--|--------------------------|--------------------------|-------------------------------------|--------------------------|
| a) Generate greenhouse gas emissions, either directly or indirectly, that may have a significant impact on the environment?
a) The proposed grain feed mill operation expects 8 trucks per day entering and leaving the facility for a total of 16 trips per day. While the operation of diesel trucks will generate some greenhouse gasses it is not anticipated to have a significant impact on the environment and therefore, impacts are expected to be less than significant. | <input type="checkbox"/> | <input type="checkbox"/> | <input checked="" type="checkbox"/> | <input type="checkbox"/> |
| b) Conflict with an applicable plan or policy or regulation adopted for the purpose of reducing the emissions of greenhouse gases?
b) The proposed grain feed mill is not expected to conflict with an applicable plan or policy or regulation adopted for the purpose of reducing the emissions of greenhouse gases. Any impacts are expected to be less than significant. | <input type="checkbox"/> | <input type="checkbox"/> | <input checked="" type="checkbox"/> | <input type="checkbox"/> |

IX. **HAZARDS AND HAZARDOUS MATERIALS** *Would the project:*

- | | | | | |
|---|--------------------------|--------------------------|-------------------------------------|--------------------------|
| a) Create a significant hazard to the public or the environment through the routine transport, use, or disposal of hazardous materials?
a) The proposed grain feed mill does not propose to use, handle, transport, or dispose of any hazardous materials and therefore, any impacts are expected to be less than significant. | <input type="checkbox"/> | <input type="checkbox"/> | <input checked="" type="checkbox"/> | <input type="checkbox"/> |
| b) Create a significant hazard to the public or the environment through reasonable foreseeable upset and accident conditions involving the release of hazardous materials into the environment?
b) The proposed grain feed mill does not propose to use, handle, or transport hazardous materials and therefore is not anticipated to create a significant hazard to the public or the environment through reasonably foreseeable upset and accident conditions involving the release of hazardous materials into the environment. Any impacts would be considered less than significant. | <input type="checkbox"/> | <input type="checkbox"/> | <input checked="" type="checkbox"/> | <input type="checkbox"/> |
| c) Emit hazardous emissions or handle hazardous or acutely hazardous materials, substances, or waste within one-quarter mile of an existing or proposed school?
c) The project site is located +/- 2.5 miles east of Seeley Elementary and does not propose to use, handle, or transport hazardous materials nor is the mill expected to emit hazardous emissions nor would the proposed 8 trucks per day drive near the school as the corn to be brought in is proposed to come from the Calipatria area over 20 miles away from the project site in the northeast and the feed lot which is to receive the feed produced by mill is located approximately 6.5 miles southeast of the project. Therefore, the project is not expected to emit hazardous emissions or handle hazardous or acutely hazardous materials, substances, or waste within one-quarter mile of an existing or proposed school. Any impacts would be considered less than significant. | <input type="checkbox"/> | <input type="checkbox"/> | <input checked="" type="checkbox"/> | <input type="checkbox"/> |
| d) Be located on a site, which is included on a list of hazardous materials sites compiled pursuant to Government Code Section 65962.5 and, as a result, would it create a significant hazard to the public or the environment?
d) Government Code Section 65962.5 requires the Department of Toxic Substances Control (DTSC) the DTSC EnviroStor Database⁴ to compile and update a list of hazardous waste and substances sites. After review, it was found that the project | <input type="checkbox"/> | <input type="checkbox"/> | <input checked="" type="checkbox"/> | <input type="checkbox"/> |

⁴ California Department of Toxic Substances Control: EnviroStor

Potentially Significant Impact (PSI)	Less Than Significant with Mitigation Incorporated (LTSMI)	Less Than Significant Impact (LTSI)	No Impact (NI)
--------------------------------------	--	-------------------------------------	----------------

site was not located under a listed hazardous and substances site; therefore, less than significant impacts are anticipated.

- e) For a project located within an airport land use plan or, where such a plan has not been adopted, within two miles of a public airport or public use airport, would the project result in a safety hazard or excessive noise for people residing or working in the project area?

e) The proposed grain feed mill will be located within the boundaries of an existing hay storage yard, seed mill, and ground installed solar field which lies within the B1 zone of the 1996 Imperial County Airport Land Use Compatibility Plan (ALUCP): Figure 3G Naval Air Facility El Centro. The project was heard at the Airport Land Use Commission on July 19, 2023, and was found consistent with the ALUCP. Representatives from the Navy express concerns regarding potential for bird attraction. After working with the Navy by the applicants to provide current bird mitigation methods the Navy has expressed no further issues or concerns.

- f) Impair implementation of or physically interfere with an adopted emergency response plan or emergency evacuation plan?

f) The proposed project is located on a developed parcel and is not expected to impair implementation of or physically interfere with an adopted emergency response plan or emergency evacuation plan. Less than significant impacts are expected.

- g) Expose people or structures, either directly or indirectly, to a significant risk of loss, injury or death involving wildland fires?

g) The proposed project is not expected to expose people or structures, either directly or indirectly, to a significant risk of loss, injury or death involving wildland fires as the project is not located in an area prone to or susceptible to wildland fires. Therefore, impacts are considered less than significant.

X. HYDROLOGY AND WATER QUALITY *Would the project:*

- a) Violate any water quality standards or waste discharge requirements or otherwise substantially degrade surface or ground water quality?

a) The proposed project is located on a developed parcel which has an existing water treatment plant and existing septic systems. It is not anticipated that the grain feed mill would violate any water quality standards or waste discharge requirements or otherwise substantially degrade surface or ground water quality. Any impacts are expected to be less than significant.

- b) Substantially decrease groundwater supplies or interfere substantially with groundwater recharge such that the project may impede sustainable groundwater management of the basin?

b) As stated in X-a, the project is located on a developed parcel with an existing water treatment plant and septic systems. Water is supplied to the project parcel from IID through the Elm Lateral 4 canal. It is not anticipated that the project would substantially decrease groundwater supplies or interfere substantially with groundwater recharge such that the project may impede sustainable groundwater management or the basin. Any impacts would be considered less than significant.

- c) Substantially alter the existing drainage pattern of the site or area, including through the alteration of the course of a stream or river or through the addition of impervious surfaces, in a manner which would:

c) The proposed grain feed mill will be located within the boundaries of an existing hay storage yard, seed mill, and ground installed solar field. The mill will be located in the center of the parcel next the hay press building on a +/- 5,730 square feet area that is currently compacted dirt but will be covered in concrete foundations for the mill structures which will require a building permit. It is not expected that the project would substantially alter the existing drainage pattern of the site or area, including through the alteration of the course of a stream or river, or through the addition of impervious surfaces. Any impacts would be considered less than significant.

	Potentially Significant Impact (PSI)	Less Than Significant with Mitigation Incorporated (LTSM)	Less Than Significant Impact (LTSI)	No Impact (NI)
(i) result in substantial erosion or siltation on- or off-site;	<input type="checkbox"/>	<input type="checkbox"/>	<input checked="" type="checkbox"/>	<input type="checkbox"/>
i) The proposed grain feed mill will be located within the boundaries of an existing hay storage yard, seed mill, and ground installed solar field. The project is not anticipated to result in substantial erosion or siltation on- or off-site. Any impacts would be considered less than significant.				
(ii) substantially increase the rate or amount of surface runoff in a manner which would result in flooding on- or offsite;	<input type="checkbox"/>	<input type="checkbox"/>	<input checked="" type="checkbox"/>	<input type="checkbox"/>
ii) As stated in X-c-i, the proposed grain feed mill is on a developed parcel and is not anticipated to substantially increase the rate or amount of surface runoff in a manner which would result in flooding on- or off-site. Any impacts would be considered less than significant.				
(iii) create or contribute runoff water which would exceed the capacity of existing or planned stormwater drainage systems or provide substantial additional sources of polluted runoff; or;	<input type="checkbox"/>	<input type="checkbox"/>	<input checked="" type="checkbox"/>	<input type="checkbox"/>
iii) It is not expected or anticipated that the proposed grain feed mill would create or contribute runoff water which would exceed the capacity of existing or planned stormwater drainage systems or provide substantial sources of polluted runoff. Any impacts would be considered less than significant.				
(iv) impede or redirect flood flows?	<input type="checkbox"/>	<input type="checkbox"/>	<input checked="" type="checkbox"/>	<input type="checkbox"/>
iv) The proposed grain feed mill is located on a developed parcel and is not located within a flood zone per the FEMA Flood Map Service Center⁵. Any impacts would be considered less than significant.				
d) In flood hazard, tsunami, or seiche zones, risk release of pollutants due to project inundation?	<input type="checkbox"/>	<input type="checkbox"/>	<input checked="" type="checkbox"/>	<input type="checkbox"/>
d) The proposed grain feed mill is not located in a flood hazard, tsunami, or seiche zones and therefore, is not expected to risk release of pollutants due to project inundation. Any impacts would be considered less than significant.				
e) Conflict with or obstruct implementation of a water quality control plan or sustainable groundwater management plan?	<input type="checkbox"/>	<input type="checkbox"/>	<input checked="" type="checkbox"/>	<input type="checkbox"/>
e) The proposed grain feed mill is not anticipated to conflict with or obstruct implementation of a water quality control plan or sustainable groundwater management plan. Any impacts would be considered less than significant.				

XI. **LAND USE AND PLANNING** *Would the project:*

- | | | | | |
|--|--------------------------|--------------------------|-------------------------------------|-------------------------------------|
| a) Physically divide an established community? | <input type="checkbox"/> | <input type="checkbox"/> | <input type="checkbox"/> | <input checked="" type="checkbox"/> |
| a) The proposed grain feed mill will be located within the boundaries of an existing hay storage yard, seed mill, and ground installed solar field and therefore, would not physically divide an established community. No impacts are expected. | | | | |
| b) Cause a significant environmental impact due to a conflict with any land use plan, policy, or regulation adopted for the purpose of avoiding or mitigating an environmental effect? | <input type="checkbox"/> | <input type="checkbox"/> | <input checked="" type="checkbox"/> | <input type="checkbox"/> |
| b) The proposed grain feed mill would not conflict with the County's General Plan or Land Use Ordinance and meets the requirements for a permitted use with an approved Conditional Use Permit. Also, in accordance with the Imperial County General Plan- Conservation and Open Space Element⁶, Figure 1- Sensitive Habitats, the proposed project site is not located within a habitat conservation plan or natural community conservation plan area. Less than significant impacts are anticipated. | | | | |

XII. **MINERAL RESOURCES** *Would the project:*

- | | | | | |
|---|--------------------------|--------------------------|-------------------------------------|--------------------------|
| a) Result in the loss of availability of a known mineral resource that would be of value to the region and the residents of the | <input type="checkbox"/> | <input type="checkbox"/> | <input checked="" type="checkbox"/> | <input type="checkbox"/> |
|---|--------------------------|--------------------------|-------------------------------------|--------------------------|

⁵ Federal Emergency Management Agency (FEMA) Flood Map Service Center: Flood Insurance Rate Map

⁶ Imperial County General Plan: Conservation and Open Space Element

	Potentially Significant Impact (PSI)	Less Than Significant with Mitigation Incorporated (LTSMI)	Less Than Significant Impact (LTSI)	No Impact (NI)
--	--------------------------------------	--	-------------------------------------	----------------

state?

a) The proposed grain feed mill will be located within the boundaries of an existing hay storage yard, seed mill, and ground installed solar field. The addition of the grain feed mill to the site would not result in the loss of availability of a known mineral resource that would be of value to the region and the residents of the state. Therefore, any impacts would be considered less than significant.

- b) Result in the loss of availability of a locally-important mineral resource recovery site delineated on a local general plan, specific plan or other land use plan?

b) In accordance with the Imperial County General Plan-Conservation and Open Space Element- Figure 8- Existing Mineral Resources, the project site is not located within an area known to be underlain by regionally important mineral resources or within an area that has the potential to be underlain by regionally mineral resources. Accordingly, implementation of the proposed project would not result in the loss of availability of a locally important mineral resource recovery site delineated on the local general plan, specific plan or other land use plans. Less than significant impacts are anticipated.

XIII. NOISE Would the project result in:

- a) Generation of a substantial temporary or permanent increase in ambient noise levels in the vicinity of the project in excess of standards established in the local general plan or noise ordinance, or applicable standards of other agencies?

a) The proposed grain feed mill will be located within the boundaries of an existing hay storage yard, seed mill, and ground installed solar field. The operation of mill is proposed to be a 6-hour period between 12am – 6am Monday to Saturday. The mill will be required to comply with the Imperial County Title 9 Land Use Ordinance Division 7: Noise Abatement and Control which limits the sound levels for agricultural zoned parcels to 70 decibels over a one-hour average on or beyond the property boundaries at any time during the day. Additional truck traffic to the site is proposed to be 8 trucks a day for a total of 16 trips which is not expected to create a significant noise impact to the nearby residences which abut Evan Hewes Hwy which is designated as a prime arterial roadway per the Imperial County Circulation and Scenic Highways Element⁷. It is expected that compliance with the Noise Abatement and Control ordinance would bring any potential impacts to less than significant.

- b) Generation of excessive groundborne vibration or groundborne noise levels?

b) The proposed grain feed mill is not anticipated to generate excessive ground-borne vibration or ground-borne noise. Any impacts would be expected to be less than significant.

- c) For a project located within the vicinity of a private airstrip or an airport land use plan or where such a plan has not been adopted, within two miles of a public airport or public use airport, would the project expose people residing or working in the project area to excessive noise levels?

c) As stated in IX-e, the project is located within the B1 zone of the ALUCP for NAF El Centro and was found consistent with the ALUCP at an ALUC hearing. The project location is located on a developed land that will experience some aircraft noise from aircraft originating from NAF El Centro, however, this noise is not expected to be excessive or constant. Any impacts would be considered less than significant.

XIV. POPULATION AND HOUSING Would the project:

- a) Induce substantial unplanned population growth in an area, either directly (for example, by proposing new homes and business) or indirectly (for example, through extension of roads or other infrastructure)?

a) The proposed grain feed mill will be located within the boundaries of an existing hay storage yard, seed mill, and ground installed solar field. The project proposes 2 additional employees to the site which would not induce a substantial unplanned population growth in an area, either directly or indirectly. Impacts are expected to be less than significant.

- b) Displace substantial numbers of existing people or housing, necessitating the construction of replacement housing elsewhere?

⁷ Imperial County Circulation and Scenic Highways Element

Potentially Significant Impact (PSI)	Less Than Significant with Mitigation Incorporated (LTSMI)	Less Than Significant Impact (LTSI)	No Impact (NI)
--------------------------------------	--	-------------------------------------	----------------

b) The proposed grain feed mill would be located on a developed parcel and would not displace substantial numbers of existing people or housing, necessitating the construction of replacement housing elsewhere. No impacts are expected.

XV. PUBLIC SERVICES

a) Would the project result in substantial adverse physical impacts associated with the provision of new or physically altered governmental facilities, need for new or physically altered governmental facilities, the construction of which could cause significant environmental impacts, in order to maintain acceptable service ratios, response times or other performance objectives for any of the public services:

a) The proposed grain feed mill will be located within the boundaries of an existing hay storage yard, seed mill, and ground installed solar field, and will not result in any adverse physical impacts associated with any new or altered governmental facilities or require the need for new or altered governmental facilities. Impacts are expected to be less than significant.

1) Fire Protection?

1) The proposed grain feed mill would be required to comply with the Imperial County Fire Department's comment letter dated May 22, 2023. The project would be required to have an approved water supply and draft hydrant, as well as maintain fire department access roads of at least 20 ft in width. The project would also be required to comply with all required sections of the fire code. It is expected that compliance with the Fire Departments letter would bring any potential impacts to a less than significant level.

2) Police Protection?

2) The Imperial County Sheriff's office provides police protection in the area. Any impacts are expected to be less than significant.

3) Schools?

3) The proposed project is not expected to draw a substantial number of new residents directly or indirectly to the region that would generate school-aged students requiring public education. As the project would not cause or contribute a need to construct new or physically altered public school facilities, no impacts are anticipated.

4) Parks?

4) The proposed project would not create a demand for public park facilities and would not result in the need to modify existing or construct new park facilities. Accordingly, implementation of the proposed project would not adversely affect any park facility, and no impacts would be anticipated.

5) Other Public Facilities?

5) The proposed project is not expected to result in a demand for other public facilities services. As such, implementation of the proposed project would not adversely affect other public facilities or require the construction of new or modified public facilities. Less than significant impacts are anticipated.

XVI. RECREATION

a) Would the project increase the use of the existing neighborhood and regional parks or other recreational facilities such that substantial physical deterioration of the facility would occur or be accelerated?

a) The proposed grain feed mill will be located within the boundaries of an existing hay storage yard, seed mill, and ground installed solar field. The project does not propose any residential use, nor would the project increase the use of the existing neighborhood and regional parks or other recreational facilities such that substantial physical deterioration of the facility would occur or be accelerated. Any impacts would be considered less than significant.

b) Does the project include recreational facilities or require the construction or expansion of recreational facilities which might have an adverse effect on the environment?

b) The proposed grain feed mill will be located within the boundaries of an existing hay storage yard, seed mill, and ground installed solar field and does not propose any recreational facilities or require the construction or expansion of recreational

Potentially Significant Impact (PSI)	Less Than Significant with Mitigation Incorporated (LTSMI)	Less Than Significant Impact (LTSI)	No Impact (NI)
--------------------------------------	--	-------------------------------------	----------------

facilities which might have an adverse effect on the environment. Any impacts would be considered less than significant.

XVII. **TRANSPORTATION** *Would the project:*

- | | | | | |
|---|--------------------------|--------------------------|-------------------------------------|--------------------------|
| a) Conflict with a program plan, ordinance or policy addressing the circulation system, including transit, roadway, bicycle and pedestrian facilities?
a) The proposed grain feed mill would be located on a developed parcel and does not appear to conflict with a program plan, ordinance, or policy addressing the circulation system, including transit, roadway, bicycle and pedestrian facilities. Any impacts would be considered less than significant. | <input type="checkbox"/> | <input type="checkbox"/> | <input checked="" type="checkbox"/> | <input type="checkbox"/> |
| b) Would the project conflict or be inconsistent with the CEQA Guidelines section 15064.3, subdivision (b)?
b) The grain feed mill is located along Evan Hewes Hwy which is designated as a prime arterial within the Imperial County Circulation Plan. The project proposes 8 trucks a day for 16 total daily trips. It does not appear that the project would conflict or be inconsistent with CEQA Guidelines section 15064.3, subdivision (b). Any impacts would be considered less than significant. | <input type="checkbox"/> | <input type="checkbox"/> | <input checked="" type="checkbox"/> | <input type="checkbox"/> |
| c) Substantially increases hazards due to a geometric design feature (e.g., sharp curves or dangerous intersections) or incompatible uses (e.g., farm equipment)?
c) The proposed grain feed mill does not appear to substantially increase hazards due to a geometric design feature or incompatible uses. Any impacts would be considered less than significant. | <input type="checkbox"/> | <input type="checkbox"/> | <input checked="" type="checkbox"/> | <input type="checkbox"/> |
| d) Result in inadequate emergency access?
d) The project is not expected to result in inadequate emergency access but will need to comply with any requirements from Imperial County Fire regarding emergency access. Any impacts would be considered less than significant. | <input type="checkbox"/> | <input type="checkbox"/> | <input checked="" type="checkbox"/> | <input type="checkbox"/> |

XVIII. **TRIBAL CULTURAL RESOURCES**

- | | | | | |
|--|--------------------------|--------------------------|-------------------------------------|--------------------------|
| a) Would the project cause a substantial adverse change in the significance of a tribal cultural resource, defined in Public Resources Code Section 21074 as either a site, feature, place, cultural landscape that is geographically defined in terms of the size and scope of the landscape, sacred place or object with cultural value to a California Native American tribe, and that is:
a) The proposed grain feed mill will be located within the boundaries of an existing hay storage yard, seed mill, and ground installed solar field and does not appear to cause a substantial adverse change in the significance of a tribal cultural resource. The project area is located within a +/- 5,730 square feet area on a +/- 35.8 acres disturbed and developed parcel with an active hay storage yard, seed mill, farm equipment storage and ground installed solar field. Additionally, letters providing an opportunity for consultation per AB 52 were sent out to the Campo Band of Mission Indians and the Quechan Indian Tribe on May 3, 2023, with a no comment response received from the Quechan on May 3, 2023, and a request for consultation received from the Campo Band of Mission Indians on May 22, 2023. After communication with the Campo Band of Mission Indians' representative via phone call on June 2, 2023, a comment of no further concerns was received the same day. Therefore, impacts are expected to be less than significant. | <input type="checkbox"/> | <input type="checkbox"/> | <input checked="" type="checkbox"/> | <input type="checkbox"/> |
| (i) Listed or eligible for listing in the California Register of Historical Resources, or in a local register of historical resources as define in Public Resources Code Section 5020.1(k), or
(i) The proposed project site is located on a developed parcel was not listed under the California Historical Resources in County of Imperial⁸ nor does it appear to be eligible under Public Resources Code Section 21074 or 5020.1 (k); therefore, less than significant impacts are expected. | <input type="checkbox"/> | <input type="checkbox"/> | <input checked="" type="checkbox"/> | <input type="checkbox"/> |
| 0 (ii) A resource determined by the lead agency, in its discretion and supported by substantial evidence, to be significant pursuant to criteria set forth in | <input type="checkbox"/> | <input type="checkbox"/> | <input checked="" type="checkbox"/> | <input type="checkbox"/> |

⁸ California Historical Resources in County of Imperial

Potentially Significant Impact (PSI)	Less Than Significant with Mitigation Incorporated (LTSMI)	Less Than Significant Impact (LTSI)	No Impact (NI)
--------------------------------------	--	-------------------------------------	----------------

subdivision (c) of Public Resources Code Section 5024.1. In applying the criteria set forth in subdivision (c) of Public Resource Code Section 5024.1, the lead agency shall consider the significance of the resource to a California Native American Tribe.

(ii) There appears to be no history or association in the past with any evidence of historical resources for the property to be either identified as of significance or as candidate for listing in the California Register; therefore, less than significant impacts are expected.

XIX. UTILITIES AND SERVICE SYSTEMS *Would the project:*

- | | | | | |
|--|--------------------------|--------------------------|-------------------------------------|-------------------------------------|
| <p>a) Require or result in the relocation or construction of new or expanded water, wastewater treatment or stormwater drainage, electric power, natural gas, or telecommunications facilities, the construction of which could cause significant environmental effects?</p> <p>a) The proposed project site currently has an onsite water treatment plant and permitted septic systems as well as roof top solar and ground mounted solar panels for onsite consumption. The grain feed mill does not propose new or upgrades to any of these systems nor does the project require or will result in the relocation or construction of new or expanded water, wastewater treatment or stormwater drainage, electric power, natural gas, or telecommunication facilities, the construction of which could cause significant environmental effects. Any impacts would be considered less than significant.</p> | <input type="checkbox"/> | <input type="checkbox"/> | <input checked="" type="checkbox"/> | <input type="checkbox"/> |
| <p>b) Have sufficient water supplies available to serve the project from existing and reasonably foreseeable future development during normal, dry and multiple dry years?</p> <p>b) The project receives water from IID and appears to have sufficient water supplies available to serve the project from existing and reasonably foreseeable future development during normal, dry and multiple dry years. Any impacts are expected to be less than significant.</p> | <input type="checkbox"/> | <input type="checkbox"/> | <input checked="" type="checkbox"/> | <input type="checkbox"/> |
| <p>c) Result in a determination by the wastewater treatment provider which serves or may serve the project that it has adequate capacity to serve the project's projected demand in addition to the provider's existing commitments?</p> <p>c) The project has an onsite water treatment system and permitted septic systems and does not appear to have an impact on any wastewater treatment provider. No impacts are expected.</p> | <input type="checkbox"/> | <input type="checkbox"/> | <input type="checkbox"/> | <input checked="" type="checkbox"/> |
| <p>d) Generate solid waste in excess of State or local standards, or in excess of the capacity of local infrastructure, or otherwise impair the attainment of solid waste reduction goals?</p> <p>d) The proposed project does not appear to generate solid waste in excess of State or local standards, or in excess of the capacity of local infrastructure, or otherwise impair the attainment of solid waste reduction goals. Any impacts are expected to be less than significant.</p> | <input type="checkbox"/> | <input type="checkbox"/> | <input checked="" type="checkbox"/> | <input type="checkbox"/> |
| <p>e) Comply with federal, state, and local management and reduction statutes and regulations related to solid waste?</p> <p>e) The project will be required to comply with all federal, state, and local management and reduction statutes and regulations related to solid waste. Any impacts are expected to be less than significant.</p> | <input type="checkbox"/> | <input type="checkbox"/> | <input checked="" type="checkbox"/> | <input type="checkbox"/> |

XX. WILDFIRE

If located in or near state responsibility areas or lands classified as very high fire hazard severity zones, would the Project:

- | | | | | |
|---|--------------------------|--------------------------|-------------------------------------|--------------------------|
| <p>a) Substantially impair an adopted emergency response plan or emergency evacuation plan?</p> <p>a) The proposed project is not located in a Fire Hazard Severity Zone in State Responsibility Area and is in the Outside State Responsibility Area per the Cal Fire: Fire Hazard Severity Zones web application⁹. The project is not expected to substantially</p> | <input type="checkbox"/> | <input type="checkbox"/> | <input checked="" type="checkbox"/> | <input type="checkbox"/> |
|---|--------------------------|--------------------------|-------------------------------------|--------------------------|

⁹ Cal Fire: Fire Hazard Severity Zones web application

	Potentially Significant Impact (PSI)	Less Than Significant with Mitigation Incorporated (LTSMI)	Less Than Significant Impact (LTSI)	No Impact (NI)
--	--------------------------------------	--	-------------------------------------	----------------

impair an adopted emergency response plan or emergency evacuation plan. Therefore, any impacts are expected to be less than significant.

- b) Due to slope, prevailing winds, and other factors, exacerbate wildfire risks, and thereby expose project occupants to pollutant concentrations from a wildfire or the uncontrolled spread of a wildfire?

b) The proposed project is in relatively flat area surrounded by agricultural lands and is not expected to exacerbate wildfire risks due to slope, prevailing winds, and other factors that would thereby expose project occupants to pollutant concentrations from a wildfire or the uncontrolled spread of a wildfire. Any impacts are expected to be less than significant.

- c) Require the installation or maintenance of associated infrastructure (such as roads, fuel breaks, emergency water sources, power lines or other utilities) that may exacerbate fire risk or that may result in temporary or ongoing impacts to the environment?

c) The proposed project is not expected to require the installation or maintenance of associated infrastructure that may exacerbate fire risk or that may result in temporary or ongoing impacts to the environment. The project will be required to comply with any requirements from Imperial County Fire Department regarding any fire suppression mechanisms or emergency water sources. Impacts are expected to be less than significant.

- d) Expose people or structures to significant risks, including downslope or downstream flooding or landslides, as a result of runoff, post-fire slope instability, or drainage changes?

d) The proposed project will not expose people or structures to significant risks by flooding or landslides as a result of runoff, post-fire slope instability or drainage changes. The proposed project is located on flat terrain and impacts are expected to be less than significant

Note: Authority cited: Sections 21083 and 21083.05, Public Resources Code. Reference: Section 65088.4, Gov. Code; Sections 21080(c), 21080.1, 21080.3, 21083, 21083.05, 21083.3, 21093, 21094, 21095, and 21151, Public Resources Code; Sundstrom v. County of Mendocino, (1988) 202 Cal.App.3d 296; Leonoff v. Monterey Board of Supervisors, (1990) 222 Cal.App.3d 1337; Eureka Citizens for Responsible Govt. v. City of Eureka (2007) 147 Cal.App.4th 357; Protect the Historic Amador Waterways v. Amador Water Agency (2004) 116 Cal.App.4th at 1109; San Franciscans Upholding the Downtown Plan v. City and County of San Francisco (2002) 102 Cal.App.4th 656.

Revised 2009- CEQA
 Revised 2011- ICPDS
 Revised 2016 – ICPDS
 Revised 2017 – ICPDS
 Revised 2019 – ICPDS

SECTION 3

III. MANDATORY FINDINGS OF SIGNIFICANCE

The following are Mandatory Findings of Significance in accordance with Section 15065 of the CEQA Guidelines.

- | | | | | |
|--|--------------------------|--------------------------|--------------------------|--------------------------|
| <p>a) Does the project have the potential to substantially degrade the quality of the environment, substantially reduce the habitat of a fish or wildlife species, cause a fish or wildlife population to drop below self-sustaining levels, threaten to eliminate a plant or animal community, substantially reduce the number or restrict the range of a rare or endangered plant or animal, eliminate tribal cultural resources or eliminate important examples of the major periods of California history or prehistory?</p> | <input type="checkbox"/> | <input type="checkbox"/> | <input type="checkbox"/> | <input type="checkbox"/> |
| <p>b) Does the project have impacts that are individually limited, but cumulatively considerable? (“Cumulatively considerable” means that the incremental effects of a project are considerable when viewed in connection with the effects of past projects, the effects of other current projects, and the effects of probable future projects.)</p> | <input type="checkbox"/> | <input type="checkbox"/> | <input type="checkbox"/> | <input type="checkbox"/> |
| <p>c) Does the project have environmental effects, which will cause substantial adverse effects on human beings, either directly or indirectly?</p> | <input type="checkbox"/> | <input type="checkbox"/> | <input type="checkbox"/> | <input type="checkbox"/> |

IV. PERSONS AND ORGANIZATIONS CONSULTED

This section identifies those persons who prepared or contributed to preparation of this document. This section is prepared in accordance with Section 15129 of the CEQA Guidelines.

A. COUNTY OF IMPERIAL

- Jim Minnick, Director of Planning & Development Services
- Michael Abraham, AICP, Assistant Director of Planning & Development Services
- Diana Robinson, Planning Division Manager
- Derek Newland, Project Planner
- Imperial County Air Pollution Control District
- Department of Public Works
- Fire Department
- Ag Commissioner
- Environmental Health Services
- Sheriff's Office

B. OTHER AGENCIES/ORGANIZATIONS

- Imperial Irrigation District

(Written or oral comments received on the checklist prior to circulation)

V. REFERENCES

1. Imperial County Air Pollution Control District comment letter dated May 15, 2023
2. California Department of Conservation CGS Seismic Hazards Program: Alquist-Priolo Fault Hazard Zones web application
<https://gis.data.ca.gov/maps/ee92a5f9f4ee4ec5aa731d3245ed9f53/explore?location=32.538703%2C-110.920388%2C6.00>
3. Imperial County General Plan Landslide Activity Map, Figure 2
<https://www.icpds.com/assets/planning/seismic-and-public-safety.pdf> .
4. California Department of Toxic Substances Control: EnviroStor
<https://www.envirostor.dtsc.ca.gov/public/>
5. Federal Emergency Management Agency (FEMA) Flood Map Service Center: Flood Insurance Rate Map
<https://msc.fema.gov/portal/search?AddressQuery=851%20pitzer%20road%20heber%20ca#searchresultsanchor>
6. Imperial County General Plan: Conservation and Open Space Element
<https://www.icpds.com/assets/planning/conservation-open-space-element-2016.pdf>
7. Imperial County Circulation and Scenic Highways Element
<https://www.icpds.com/assets/planning/circulation-scenic-highway-element-2008.pdf>
8. California Historical Resources in County of Imperial
<https://ohp.parks.ca.gov/ListedResources/?view=county&criteria=13>
9. Cal Fire: Fire Hazard Severity Zones web application
<https://egis.fire.ca.gov/FHSZ/>
10. "County of Imperial General Plan EIR", prepared by Brian F. Mooney & Associates in 1993; and as Amended by County in 1996, 1998, 2001, 2003, 2006 & 2008, 2015, 2016.

VI. NEGATIVE DECLARATION – County of Imperial

The following Negative Declaration is being circulated for public review in accordance with the California Environmental Quality Act Section 21091 and 21092 of the Public Resources Code.

Project Name: Conditional Use Permit #23-0001 / Initial Study #23-0001

Project Applicant: La Valle Sabbia Inc.

Project Location: 2015 Silsbee Road, El Centro, CA 92243, County of Imperial

Description of Project: The project proposes Conditional Use Permit #23-0001 to construct and operate a grain feed mill located within the boundaries of a fully developed parcel consisting of an existing hay storage yard, seed mill, and ground installed solar field. Ground cover consists of compacted dirt, paved areas and concrete. The mill will be located on a +/- 5,730 square foot area of a +/- 35.80 acres parcel. The proposed project consists of two (2) 500-ton grain silos that are 46 feet high and a width of 29 feet, two (2) holding tanks that are 29 feet, 2 inches high and a width of 15 feet, 4 inches, and two (2) flaking mills with steam chests that are 34 feet high and a width of 7 feet that sit on top of structural and concrete bunkers that are 11 feet, 4 inches high and a width of 34 feet. The total height of the flaking mills with the structural bunkers will be 45 feet in height. Additionally, there will be two (2) grain elevators that are 70 feet high and a width of 10 feet, a 60 feet high grain elevator with a width of 8 feet and two (2) grain holding tanks are 29 feet high and 16 feet in width. The feed produced from the mill is a flaked corn and wheat mixture that will be stored in concrete bunkers before being shipped out to the LVS Cattle Feeders Feed Yard located at 495 W. Heber Rd., El Centro, CA. The corn will be shipped in from Calipatria, CA and the wheat will come from the onsite seed mill. The grains will be stored in the 500-ton silos until processed. The proposed hours of operation for feed processing and delivery is 12 am to 6 am Monday through Saturday. Daily traffic is expected to be 8 trucks a day entering and leaving the site along with 2 employee vehicles entering and leaving.

VII. FINDINGS

This is to advise that the County of Imperial, acting as the lead agency, has conducted an Initial Study to determine if the project may have a significant effect on the environment and is proposing this Negative Declaration based upon the following findings:

The Initial Study shows that there is no substantial evidence that the project may have a significant effect on the environment and a NEGATIVE DECLARATION will be prepared.

The Initial Study identifies potentially significant effects but:

- (1) Proposals made or agreed to by the applicant before this proposed Mitigated Negative Declaration was released for public review would avoid the effects or mitigate the effects to a point where clearly no significant effects would occur.
- (2) There is no substantial evidence before the agency that the project may have a significant effect on the environment.
- (3) Mitigation measures are required to ensure all potentially significant impacts are reduced to levels of insignificance.

A MITIGATED NEGATIVE DECLARATION will be prepared.

If adopted, the Negative Declaration means that an Environmental Impact Report will not be required. Reasons to support this finding are included in the attached Initial Study. The project file and all related documents are available for review at the County of Imperial, Planning & Development Services Department, 801 Main Street, El Centro, CA 92243 (442) 265-1736.

NOTICE

The public is invited to comment on the proposed Negative Declaration during the review period.

Date of Determination Jim Minnick, Director of Planning & Development Services

The Applicant hereby acknowledges and accepts the results of the Environmental Evaluation Committee (EEC) and hereby agrees to implement all Mitigation Measures, if applicable, as outlined in the MMRP.

Applicant Signature

Date

SECTION 4

VIII. RESPONSE TO COMMENTS

(ATTACH DOCUMENTS, IF ANY, HERE)

IX. MITIGATION MONITORING & REPORTING PROGRAM (MMRP)

(ATTACH DOCUMENTS, IF ANY, HERE)

COMMENTS

Derek Newland

From: Ryan, Dina M CIV USN (USA) <dina.m.ryan.civ@us.navy.mil>
Sent: Monday, July 17, 2023 08:19
To: Derek Newland
Cc: Powell, Robert J CIV USN NAVFAC SW SAN CA (USA)
Subject: Proposed La Valle Sabbia grain feed mill
Signed By: dina.m.ryan.civ@us.navy.mil

Importance: High

Hello Derek – the Navy at NAF El Centro has learned of the proposed La Valle Sabbia grain feed mill at 2015 Silsbee Road, El Centro. We have two serious concerns in regards to compatibility of this project with our mission: 1) height of the structure in relationship to our active air space, and 2) an increase in bird populations resulting from available food source at the mill; an increase in birds directly in our air space will increase the danger of bird strike hazards in jet engines puts our pilots' safety at risk.

If the landowner is not able to demonstrate how the above issues would be mitigated, we may need to formally oppose construction of this mill. Have alternatives been considered? Thank you very much.

V/R,
Dina

Dina M. Ryan
Community Planning Liaison Officer
NAF El Centro CA / NOFS Flagstaff, AZ
dina.m.ryan.civ@us.navy.mil
(805) 354-3080



ABATTI COMPANIES

"We Cultivate Relationships"

September 6, 2023

Derek Newland
Planner II
Planning & Development Services Department
County of Imperial
801 Main Street
El Centro, CA 92243

Re: La Valle Sabbia, Inc. Grain Storage & Receiving Project; CUP23-001/IS23-0001
Response to NAF comments (Bird Mitigation)

We currently have two companies that come to 2 to 3xs per year to assist us in the removal of any type of birds we may have at our facility.

- We will be running 3 to 5 trucks during off hours from 12:00 a.m. to 6:00 a.m.
- Each truck carries 25 tons maximum.
- The truck driver drives into an over pit where he dumps grain into silos.
- Grain gets elevated into silos.
- The grain then is discharged into a bottom conveyor that gets discharged into a bucket elevator.
- That elevator then discharges the grain into a grain cleaner machine. After the cleaning grain is elevated into the soak tank (grain is left here overnight). The grain is being sprayed to retain some moisture where it's held into a soaking tank.
- The following day the grain is conveyed into the steam chest where the grain is cooked and then below the steam chest the grain goes through a flaking machine and turned into flakes.
- The flakes then get discharged into a bunker and loaded onto a walking floor where it is trucked out and hauled out to its destination.

For our Grain Feed mill we will be working during off hours 12:00 a.m. to 6:00 a.m. With about 3 to 5 trucks in and out deliveries. With 3 to 5 employees at the time one to two running the grain feed mill and the other will be the truck drivers. All processed grain feed will be delivered to its destination. There is no exposure of grain as all of it will be in closed silo containers from the moment it arrives until it leaves. There is no exposure of grain for any birds to want to be near and eat or contaminate.

If you have any questions or concerns, please do not hesitate to contact me at 760-482-9420.

Sincerely,

April Ochoa
Business Executive Administrative Asst.

AIR POLLUTION CONTROL DISTRICT



RECEIVED

MAY 16 2023

**IMPERIAL COUNTY
PLANNING & DEVELOPMENT SERVICES**

May 15, 2023

Jim Minnick
Planning & Development Services Director
801 Main Street
El Centro, CA 92243

SUBJECT: Conditional Use Permit 23-0001 – La Valle Sabbia, Inc.

Dear Mr. Minnick:

The Imperial County Air Pollution Control District (Air District) appreciates the opportunity to review and comment on Conditional Use Permit (CUP) 23-0001(Project) that proposes the construction and operation of a grain receiving and storage facility as well as a corn and wheat grain rolling operation to produce feed for livestock consumption. The project is located at 2015 Silsbee Rd., El Centro also identified as Assessor's Parcel Number 062-080-0015.

The Air District informs the applicant that a permit may be required for the project based on a review of the information provided. After reviewing its records the Air District identified multiple active permits associated with the project location, however, the active permits cover various different operations/equipment and none of the permits were found to cover the current proposed project. As of the writing of this letter, the Air District also does not have record of receiving a permit application for review of the project. The Air District requests the applicant contact Jesus Ramirez, Permitting and Engineering Division Manager, to discuss the permitting requirements of the project and submit a permit application for review.

The Air District reminds the applicant that the project must comply with all Air District rules and regulations and would emphasize Regulation VIII – Fugitive Dust Rules. Regulation VIII is a collection of rules designed to maintain fugitive dust emissions below 20% visual opacity.

The Air District requests a copy of the draft CUP prior to recording for its review.

The Air District's rules and regulations can be found on our website for your convenience at <https://apcd.imperialcounty.org/rules-and-regulations/>. Should you have any questions please feel free to contact the Air District for assistance at (442) 265-1800.

Respectfully,

Ismael Garcia
Environmental Coordinator I

Morica N. Soucier
APC Division Manager

Valerie Grijalva

From: Guillermo Mendoza
Sent: Monday, July 10, 2023 10:06 AM
To: Laryssa Alvarado; Rachel Garewal; Sandra Mendivil; Jolene Dessert; Margo Sanchez; Ana L Gomez; Belen Leon-Lopez; Monica Soucier; Jesus Ramirez; Eric Havens; Michael Kelley; Miguel Figueroa; Rosa Lopez; Vanessa Ramirez; Jeff Lamoure; Alphonso Andrade; Jorge Perez; Mario Salinas; Robert Menvielle; Jack Dunnam; Salvador Flores; Robert Malek; Andrew Loper; John Gay; Ryan Kelley; Fred Miramontes; Robert Benavidez; Manuel De Leon; Donald Vargas; dina.ryan@navy.mil; marcuscuero@campo-nsn.gov; jmesa@campo-nsn.gov; historicpreservation@quechantribe.com; tribalsecretary@quechantribe.com
Cc: Jim Minnick; Michael Abraham; Derek Newland; Diana Robinson; Aimee Trujillo; John Robb; Kamika Mitchell; Melina Rizo; Rosa Soto; Valerie Grijalva; Carlos Yee; Carlos Yee
Subject: RE: CUP23-0001/IS23-0001-Request for Comments

Good morning,

Please see attached below pending item in order for Public Works to complete the comment letter from our department.

The applicant shall prepare a traffic memorandum providing the following information:

- Existing traffic counts on Silsbee Road at 325/350 feet north of Evan Hewes Highway
- Existing traffic counts on Silsbee Road at 70 feet north of the railroad tracks
- Existing traffic counts on Silsbee Road at 0.4 miles north of the railroad tracks
- Number of employees for existing operations per shift and shift hours
- Number of trucks entering and exiting the site for existing operations per shift and shift hours

Traffic volumes shall be obtained 24-hours for seven days in 15-minute intervals and include direction of travel and classification.

Thanks,

Guillermo Mendoza
Permit Specialist
Imperial County
Department of Public Works
155 S. 11th Street
(442) 265 – 1818



RECEIVED
JUL 10 2023
IMPERIAL COUNTY
PLANNING & DEVELOPMENT SERVICES

From: Laryssa Alvarado <laryssaalvarado@co.imperial.ca.us>
Sent: Wednesday, May 3, 2023 10:34 AM
To: Rachel Garewal <RachelGarewal@co.imperial.ca.us>; Sandra Mendivil <SandraMendivil@co.imperial.ca.us>; Jolene

Dessert <JoleneDessert@co.imperial.ca.us>; Margo Sanchez <MargoSanchez@co.imperial.ca.us>; Ana L Gomez <analomez@co.imperial.ca.us>; Belen Leon <BelenLeon@co.imperial.ca.us>; Monica Soucier <MonicaSoucier@co.imperial.ca.us>; Jesus Ramirez <JesusRamirez@co.imperial.ca.us>; Eric Havens <EricHavens@co.imperial.ca.us>; Michael Kelley <MichaelKelley@co.imperial.ca.us>; Miguel Figueroa <miguelfigueroa@co.imperial.ca.us>; Rosa Lopez <RosaLopez@co.imperial.ca.us>; Vanessa Ramirez <VanessaRamirez@co.imperial.ca.us>; Jeff Lamoure <JeffLamoure@co.imperial.ca.us>; Alphonso Andrade <AlphonsoAndrade@co.imperial.ca.us>; Jorge Perez <JorgePerez@co.imperial.ca.us>; Mario Salinas <MarioSalinas@co.imperial.ca.us>; Robert Menvielle <RobertMenvielle@co.imperial.ca.us>; Jack Dunnam <JackDunnam@co.imperial.ca.us>; Salvador Flores <SalvadorFlores@co.imperial.ca.us>; Robert Malek <RobertMalek@co.imperial.ca.us>; Andrew Loper <AndrewLoper@co.imperial.ca.us>; Guillermo Mendoza <GuillermoMendoza@co.imperial.ca.us>; John Gay <JohnGay@co.imperial.ca.us>; Ryan Kelley <RyanKelley@co.imperial.ca.us>; Fred Miramontes <fmiramontes@icso.org>; Robert Benavidez <rbenavidez@icso.org>; Manuel De Leon <mdeleon@icso.org>; Donald Vargas <dvgargas@iid.com>; dina.ryan@navy.mil; marcuscuero@campo-nsn.gov; jmesa@campo-nsn.gov; historicpreservation@quechantribe.com; tribalsecretary@quechantribe.com
Cc: Jim Minnick <JimMinnick@co.imperial.ca.us>; Michael Abraham <MichaelAbraham@co.imperial.ca.us>; Derek Newland <DerekNewland@co.imperial.ca.us>; Diana Robinson <DianaRobinson@co.imperial.ca.us>; Aimee Trujillo <aimeetrujillo@co.imperial.ca.us>; John Robb <JohnRobb@co.imperial.ca.us>; Kamika Mitchell <kamikamitchell@co.imperial.ca.us>; Laryssa Alvarado <laryssaalvarado@co.imperial.ca.us>; Melina Rizo <melinarizo@co.imperial.ca.us>; Rosa Soto <RosaSoto@co.imperial.ca.us>; Valerie Grijalva <ValerieGrijalva@co.imperial.ca.us>
Subject: CUP23-0001/IS23-0001-Request for Comments

Good morning,

Please see attached Request for Comments packet for **CUP23-0001/IS23-0001 La Valle Sabbia Inc- Luis Haro [2015 Silsbee Road, El Centro, CA 92243; APN 062-080-015]**

Comments are due by **May 18th, 2023 at 5:00 PM**

In an effort to increase the efficiency at which information is distributed and reduce paper usage, the Request for Comments packet is being sent to you via this email.

Should you have any questions, please feel free to contact Derek Newland at (442) 265-1736 or submit your comment letters to ICPDScommentletters@co.imperial.ca.us.

Thank you,

Laryssa Alvarado

Office Assistant III
Imperial County Planning & Development Services
801 Main Street
El Centro, CA 92243
laryssaalvarado@co.imperial.ca.us





ABATTI COMPANIES

"We Cultivate Relationships"

September 5, 2023

Derek Newland
Planner II
Planning & Development Services Department
County of Imperial
801 Main Street
El Centro, CA 92243

Re: La Valle Sabbia, Inc. Grain Storage & Receiving Project; CUP23-001/IS23-0001
Response to Public Works letter date July 10, 2023

In response to:

1. Traffic will not change and will be the same traffic count.
2. Traffic will not change and will be the same traffic count.
3. Traffic will not change and will be the same traffic count.
4. The number of employees for the *existing operation* will be 128.
5. There number of trucks for our *existing operation* is about 20 to 30 in and out. This number varies throughout the year. This occurs between 7:00 a.m. and 5:30 p.m.

For our Grain Feed mill we will be working during off hours 12:00 a.m. to 6:00 a.m. With about 3 to 5 trucks in and out deliveries. With 3 to 5 employees at the time one to two running the grain feed mill and the other will be the truck drivers. All processed grain feed will be delivered to its destination.

For questions 1-4 Mr. Rick Bush and I meet with Assistant Director David Dale and where able to answer these questions in concern. Based on answers we were advised that we were not required to have a Traffic Engineer.

If you have any questions or concerns, please do not hesitate to contact me at 760-482-9420.

Sincerely,

April Ochoa
Business Executive Administrative Asst.



IID

A century of service.

www.iid.com

Since 1911

May 18, 2023

RECEIVED

MAY 18 2023

**IMPERIAL COUNTY
PLANNING & DEVELOPMENT SERVICES**

Mr. Derek Newland
Planner II
Planning & Development Services Department
County of Imperial
801 Main Street
El Centro, CA 92243

SUBJECT: La Valle Sabbia, Inc. Grain Storage & Receiving Project; CUP23-0001/IS23-0001

Dear Mr. Newland:

On May 3, 2023, the Imperial Irrigation District received a request for agency comments on the La Valle Sabbia, Inc. grain processing project; Conditional Use Permit No. 23-0001, Initial Study No. 23-0001. The applicant proposes to establish a grain storage, receiving and corn and wheat rolling operation at 2015 Silsbee Road, El Centro, CA (APN 062-080-015-000).

The IID has reviewed the application and has the following comments:

1. The site currently has electrical service, any added electrical load to the applicant's existing electrical panel will need to be reviewed. If the project requires an upgrade to the site's current electrical service, the applicant should be advised to contact Ignacio Romo, IID project development planner, at (760) 482-3426 or e-mail Mr. Romo at IGRomo@IID.com to initiate the customer service application process. In addition to submitting a formal application (available for download at the website <http://www.iid.com/home/showdocument?id=12923>), the applicant will be required to submit AutoCAD file of site plan, electrical plans, electrical panel size and panel location, operating voltage, electrical loads, project schedule, and the applicable fees, permits, easements and environmental compliance documentation pertaining to the provision of electrical service to the project. The applicant shall be responsible for all costs and mitigation measures related to providing new electrical service to the project.
2. Line items 12 and 13 of the Conditional Use Permit application are not answered. Furthermore, the existing water system is not defined in the application.
3. Line item 15 of the Conditional Use Permit application states that there will be two employees at the proposed business site. Applicant should describe if these two employees have access to a sewer system in a building located on the property or will they be utilizing portable out houses.
4. Per the State of California' Safe Drinking Water Act the proposed facility will have to have a state-approved provider deliver drinking water for the employees.

Derek Newland
May 18, 2023
Page 2

5. Any construction or operation on IID property or within its existing and proposed right of way or easements including but not limited to: surface improvements such as proposed new streets, driveways, parking lots, landscape; and all water, sewer, storm water, or any other above ground or underground utilities; will require an encroachment permit, or encroachment agreement (depending on the circumstances). A copy of the IID encroachment permit application and instructions for its completion are available at <https://www.iid.com/about-iid/department-directory/real-estate>. The IID Real Estate Section should be contacted at (760) 339-9239 for additional information regarding encroachment permits or agreements. No foundations or buildings will be allowed within IID's right of way.
6. Any new, relocated, modified or reconstructed IID facilities required for and by the project (which can include but is not limited to electrical utility substations, electrical transmission and distribution lines, water deliveries, canals, drains, etc.) need to be included as part of the project's California Environmental Quality Act (CEQA) and/or National Environmental Policy Act (NEPA) documentation, environmental impact analysis and mitigation. Failure to do so will result in postponement of any construction and/or modification of IID facilities until such time as the environmental documentation is amended and environmental impacts are fully analyzed. Any and all mitigation necessary as a result of the construction, relocation and/or upgrade of IID facilities is the responsibility of the project proponent.

Should you have any questions, please do not hesitate to contact me at 760-482-3609 or at dvargas@iid.com. Thank you for the opportunity to comment on this matter.

Respectfully,

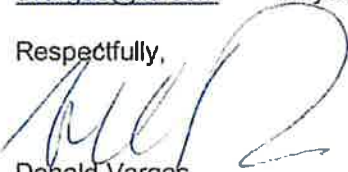

Donald Vargas
Compliance Administrator II

Enrique B. Martinez – General Manager
Mike Pacheco – Manager, Water Dept.
Jamie Asbury – Manager, Energy Dept.
Matthew H Smelser – Deputy Mgr. Energy Dept.
Geoffrey Holbrook – General Counsel
Michael P. Kemp – Superintendent, Regulatory & Environmental Compliance
Laura Cervantes – Supervisor, Real Estate
Jessica Humes – Environmental Project Mgr. Sr., Water Dept.



ABATTI COMPANIES

"We Cultivate Relationships"

September 5, 2023

Derek Newland
Planner II
Planning & Development Services Department
County of Imperial
801 Main Street
El Centro, CA 92243

Re: La Valle Sabbia, Inc. Grain Storage & Receiving Project; CUP23-001/IS23-0001
Response to IID letter date May 18, 2023

In response to:

1. We will not be adding any additional electrical load requirements. We will not need an application at this time. Our contractor's load is sufficient now.
2. #12 We currently already have an established sewer system and is accessible to employees. #13 We have an existing water system and is being serviced by Water Treatment Services, Inc. by Rocky Vandergriff with a contact number 760-427-4235. With a current permit. Please see attached with expiration date of 12/31/2023.
3. Both employees working will have access to the sewer system.
4. Our plant is certified by the state and Imperial County Public Health Department.
5. There will be no need for an encroachment permit.
6. After reviewing we will not require any additional electrical work. We will not be using any additional water. Nor will we need a right of way. Since we will not be crossing any canals or lateral or any water pipelines.

If you have any questions or concerns, please do not hesitate to contact me at 760-482-9420.

Sincerely,

April Ochoa
Business Executive Administrative Asst.

ADMINISTRATION / TRAINING

1078 Dogwood Road
Heber, CA 92249

Administration

Phone: (442) 265-6000
Fax: (760) 482-2427

Training

Phone: (442) 265-6011

**OPERATIONS/PREVENTION**

2514 La Brucherie Road
Imperial, CA 92251

Operations

Phone: (442) 265-3000
Fax: (760) 355-1482

Prevention

Phone: (442) 265-3020

RECEIVED

May 22, 2023

MAY 22 2023

RE: Condition Use Permit 23-0001
La Valle Sabbia Inc
2015 Silsbee Road, El Centro CA 92243

**IMPERIAL COUNTY
PLANNING & DEVELOPMENT SERVICES**

Imperial County Fire Department would like to thank you for the opportunity to review and comment on CUP 23-0001 for La Valle Sabbia Inc, located at 2015 Silsbee Road, El Centro CA 92243. La Valle Sabbia Inc is proposing a receiving and storage operation of corn and wheat grain with silos and grain elevators

Imperial County Fire Department has the following comments and/or requirements.

- An approved water supply connected to a Draft Hydrant(s) connection as required by Imperial County Fire Department. Water supply and draft hydrant connections shall be accessible and supply of water shall be maintained at all times.
- Fire department access roads shall be a width of a least 20 feet and all weather surface capable of supporting fire apparatus. Fire department access roads will be provided with approved turn around approved by Imperial County Fire Department. Gates will be in accordance with the current adapted fire code and the facility will maintain a Knox Box/lock for access on site.
- Combustible dust operations will need to be in accordance with the California Fire Code Chapter 22 and NFPA 61 as required.
- Secondary access shall be required and shall be kept clear of vehicle congestion and other factors that could limit access.
- All storage and handling of flammable and combustible liquids shall be in accordance with the California Fire Code and all federal, state, and local regulations, codes, and ordinances.
- Compliance with all required sections of the fire code.

The project shall be in compliance at all times with requirements in the California Fire Code and local ordinances and requirements. Imperial County Fire Department shall conduct annual fire and life safety inspections

Imperial County Fire Department reserves the right to comment and request additional requirements pertaining to this project regarding fire and life safety measures, California Building and Fire Code, and National Fire Protection Association standards at a later time as we see necessary.

AN EQUAL OPPORTUNITY/AFFIRMATIVE ACTION EMPLOYER

ADMINISTRATION / TRAINING

1078 Dogwood Road
Heber, CA 92249

Administration

Phone: (442) 265-6000

Fax: (760) 482-2427

Training

Phone: (442) 265-6011



OPERATIONS/PREVENTION

2514 La Brucherie Road
Imperial, CA 92251

Operations

Phone: (442) 265-3000

Fax: (760) 355-1482

Prevention

Phone: (442) 265-3020

If you have any questions, please contact the Imperial County Fire Prevention Bureau at 442-265-3020 or 442-265-3021.

Sincerely

Andrew Loper

A handwritten signature in black ink, appearing to be 'A. Loper', written over a horizontal line.

Lieutenant/Fire Prevention Specialist
Imperial County Fire Department
Fire Prevention Bureau

Robert Malek

Deputy Chief

Imperial County Fire Department
Fire Prevention Bureau

Valerie Grijalva

From: Jill McCormick <historicpreservation@quechantribe.com>
Sent: Wednesday, May 3, 2023 2:25 PM
To: Laryssa Alvarado; Derek Newland; ICPDSComentLetters
Subject: Re: [EXTERNAL]:CUP23-0001/IS23-0001-Request for Comments

CAUTION: This email originated outside our organization; please use caution.

This email is to inform you that we do not wish to comment on this project.

H. Jill McCormick M.A.
Ft. Yuma Quechan Indian Tribe
P.O. Box 1899
Yuma, AZ 85366-1899
Office: 760-572-2423
Cell: 928-261-0254

RECEIVED

MAY 03 2023

IMPERIAL COUNTY
PLANNING & DEVELOPMENT SERVICES



From: Laryssa Alvarado <laryssaalvarado@co.imperial.ca.us>
Sent: Wednesday, May 3, 2023 10:34 AM
To: Rachel Garewal <RachelGarewal@co.imperial.ca.us>; Sandra Mendivil <SandraMendivil@co.imperial.ca.us>; Jolene Dessert <JoleneDessert@co.imperial.ca.us>; Margo Sanchez <MargoSanchez@co.imperial.ca.us>; Ana L Gomez <analgomez@co.imperial.ca.us>; Belen Leon <BelenLeon@co.imperial.ca.us>; Monica Soucier <MonicaSoucier@co.imperial.ca.us>; Jesus Ramirez <JesusRamirez@co.imperial.ca.us>; Eric Havens <EricHavens@co.imperial.ca.us>; Michael Kelley <MichaelKelley@co.imperial.ca.us>; Miguel Figueroa <miguelfigueroa@co.imperial.ca.us>; Rosa Lopez <RosaLopez@co.imperial.ca.us>; Vanessa Ramirez <VanessaRamirez@co.imperial.ca.us>; Jeff Lamoure <JeffLamoure@co.imperial.ca.us>; Alphonso Andrade <AlphonsoAndrade@co.imperial.ca.us>; Jorge Perez <JorgePerez@co.imperial.ca.us>; Mario Salinas <MarioSalinas@co.imperial.ca.us>; Robert Menvielle <RobertMenvielle@co.imperial.ca.us>; Jack Dunnam <JackDunnam@co.imperial.ca.us>; Salvador Flores <SalvadorFlores@co.imperial.ca.us>; Robert Malek <RobertMalek@co.imperial.ca.us>; Andrew Loper <AndrewLoper@co.imperial.ca.us>; Guillermo Mendoza <GuillermoMendoza@co.imperial.ca.us>; John Gay <JohnGay@co.imperial.ca.us>; Ryan Kelley <RyanKelley@co.imperial.ca.us>; Fred Miramontes <fmiramontes@icso.org>; Robert Benavidez <rbenavidez@icso.org>; Manuel De Leon <mdeleon@icso.org>; Donald Vargas <dvargas@iid.com>; dina.ryan@navy.mil <dina.ryan@navy.mil>; marcuscuero@campo-nsn.gov <marcuscuero@campo-nsn.gov>; jmesa@campo-nsn.gov <jmesa@campo-nsn.gov>; Jill McCormick <historicpreservation@quechantribe.com>; Gabby Emerson <tribalsecretary@quechantribe.com>

Derek Newland

From: Daniel Tsosie <dtsosie@campo-nsn.gov>
Sent: Friday, June 2, 2023 09:53
To: Derek Newland
Subject: RE: Proposed Project Silsbee Rd. (APN 062-080-015-000)

CAUTION: This email originated outside our organization; please use caution.

Hello Derek, thank you for the call, and project information. At this time we do not have anymore concerns. Please give me a call if you have any questions.

From: Derek Newland <DerekNewland@co.imperial.ca.us>
Sent: Thursday, June 1, 2023 3:50 PM
To: Daniel Tsosie <dtsosie@campo-nsn.gov>
Subject: RE: Proposed Project Silsbee Rd. (APN 062-080-015-000)

Good afternoon Daniel,

In addition to speaking with you tomorrow I also wanted to provide you with an aerial of the project parcel with the project site circled in red for better reference from what was provided in the request for comments packet.



Thank you,

Derek Newland
Planner II
County of Imperial
Planning and Development Services
dereknewland@co.imperial.ca.us
(442) 265-1736

From: Daniel Tsosie <dtsosie@campo-nsn.gov>
Sent: Thursday, June 1, 2023 3:05 PM
To: Derek Newland <DerekNewland@co.imperial.ca.us>
Subject: Re: Proposed Project Silsbee Rd. (APN 062-080-015-000)

CAUTION: This email originated outside our organization; please use caution.

Yes, i ended up going out in the field, my cell is 619-760-6480. Easier to call my cell.

Best regards,

DANIEL TSOSIE
Campo Band of Mission Indians
Cultural Resource Manager

C: 619-760-6480
O: 619-478-9046 Ext. 278

Sent from my T-Mobile 5G Device
Get [Outlook for Android](#)

From: Derek Newland <DerekNewland@co.imperial.ca.us>
Sent: Thursday, June 1, 2023 9:55:17 AM
To: Daniel Tsosie <dtsosie@campo-nsn.gov>
Subject: RE: Proposed Project Silsbee Rd. (APN 062-080-015-000)

Good morning Daniel,
I have been trying to reach you on your office line. Can we set up a time for a phone call to go over the project?

Thank you,

Derek Newland
Planner II
County of Imperial
Planning and Development Services
dereknewland@co.imperial.ca.us
(442) 265-1736

From: Daniel Tsosie <dtsosie@campo-nsn.gov>
Sent: Monday, May 22, 2023 2:34 PM
To: Derek Newland <DerekNewland@co.imperial.ca.us>
Subject: Proposed Project Silsbee Rd. (APN 062-080-015-000)

CAUTION: This email originated outside our organization; please use caution.

Hello Derek, we, Campo Band of Mission Indians, have received your Notification Letter "Proposed Project Silsbee Rd. (APN 062-080-015-000)", Due to the area and pre-contact history of the El Centro are, we Campo would like to request AB 52 Consultation. If possible, can you provide any "Sacred Files" information. Feel free to give me a call if you have any questions. Thank you.

Best Regards,

Daniel Tsosie

Campo Band of Mission Indians
Cultural Resource Manager
36190 Church Road, Suite #4
Campo, CA 91906

Cell: 619-760-6480

Office: 619-478-9046 ext.278

E-mail: dtsosie@campo-nsn.gov

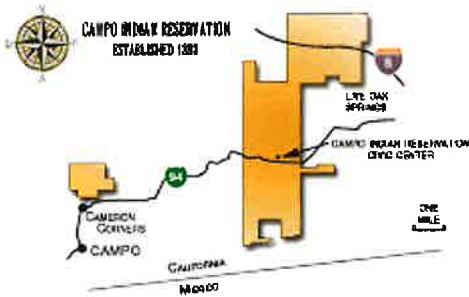

Cc: Jim Minnick <JimMinnick@co.imperial.ca.us>; Michael Abraham <MichaelAbraham@co.imperial.ca.us>; Derek Newland <DerekNewland@co.imperial.ca.us>; Diana Robinson <DianaRobinson@co.imperial.ca.us>; Aimee Trujillo <aimeetrujillo@co.imperial.ca.us>; John Robb <JohnRobb@co.imperial.ca.us>; Kamika Mitchell <kamikamitchell@co.imperial.ca.us>; Laryssa Alvarado <laryssaalvarado@co.imperial.ca.us>; Melina Rizo <melinarizo@co.imperial.ca.us>; Rosa Soto <RosaSoto@co.imperial.ca.us>; Valerie Grijalva <ValerieGrijalva@co.imperial.ca.us>

Subject: [EXTERNAL]:CUP23-0001/IS23-0001-Request for Comments

CAUTION: This email originated from outside of the organization. Do not click links or open attachments unless you recognize the sender and know the content is safe.

Good morning,

Please see attached Request for Comments packet for **CUP23-0001/IS23-0001 La Valle Sabbia Inc- Luis Haro [2015 Siisbee Road, El Centro, CA 92243; APN 062-080-015]**

Comments are due by **May 18th, 2023 at 5:00 PM**

In an effort to increase the efficiency at which information is distributed and reduce paper usage, the Request for Comments packet is being sent to you via this email.

Should you have any questions, please feel free to contact Derek Newland at (442) 265-1736 or submit your comment letters to ICPDScommentletters@co.imperial.ca.us.

Thank you,

Laryssa Alvarado

Office Assistant III

Imperial County Planning & Development Services

801 Main Street

El Centro, CA 92243

laryssaalvarado@co.imperial.ca.us



**ALUC LETTER OF
DETERMINATION /
ALUC PACKAGE**



Imperial County Planning & Development Services Planning / Building

July 27, 2023

Jim Minnick
DIRECTOR

La Valle Sabbia Inc.
ATTN: Luis Haro
2015 Silsbee Rd
El Centro, CA 92243

**SUBJECT: Airport Land Use Commission Determination for La Valle Sabbia Inc.
(CUP #23-0001/IS #23-0001)**

Dear Applicant:

The Airport Land Use Commission (ALUC) on July 19, 2023, held a public hearing on the proposed Conditional Use Permit #23-0001 for a grain feed mill for consistency or inconsistency with the 1996 Airport Land Use Compatibility Plan (ALUCP). Luis Haro and April Ochoa were present on the applicant's behalf.

After conducting a public hearing, and hearing all the opponents and proponents of the proposed grain feed mill, the Commission found it consistent with the 1996 Airport Land Use Compatibility Plan (ALUCP).

If you should have any questions, please contact Derek Newland, Planner II, at (442) 265-1736 or via email at dereknewland@co.imperial.ca.us.

Sincerely,

JIM MINNICK
ALUC Secretary

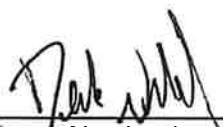
By: 
Derek Newland
Planner II

CC: Luis Haro, lharo@abbali.com
Jim Minnick, Planning & Dev. Services Director
Michael Abraham, AICP, Assistant ICPDS Director
Diana Robinson, Planning Division Manager
File: 10.102; 10.101; 10.104; 10.141
DN:ATIS:\AllUsers\APN\062\080\015\CUP#23-0001\ALUC\La Valle Sabbia CUP23-0001_IS23-0001 ALUC Determination Ltr 072723.docx



Imperial County Planning & Development Services Planning / Building

Jim Minnick
DIRECTOR

TO: Chairman Mike Goodsell
Vice-Chairman Jenell Guerrero
Commissioner Dennis Logue
Commissioner Jerry Arguelles
Commissioner Sylvia Chavez

FROM: Jim Minnick, Secretary
Planning & Development Services Director

SUBJECT: Public hearing to consider compatibility of La Valle Sabbia's requested Conditional Use Permit for a grain feed mill located within the boundaries of the existing hay press and hay storage facility. The proposed project is within the Imperial County Airport Compatibility Plan B1 Zone (Approach/Departure Zone and Adjacent to Runway). The proposed project site is located at 2015 Silsbee Road, El Centro, CA 92243 on the northwest corner of the intersection of Silsbee Road and West Evan Hewes Hwy. Parcel coordinates 115° 38' 54.8052" W, 32° 47' 53.7864" N; Assessor's Parcel Numbers 062-080-015-000 (Supervisory District #3) (ALUC 03-23) [Derek Newland, Planner II, 442-265-1736, extension 1756 or by email at dereknewland@co.imperial.ca.us].

DATE OF REPORT: July 19, 2023

AGENDA ITEM NO: 1

HEARING DATE: July 19, 2023

HEARING TIME: 6:00 P.M.

HEARING LOCATION: County Administration Center
Board of Supervisors Chambers
940 Main Street
El Centro, CA 92243

STAFF RECOMMENDATION

It is the Secretary's recommendation that the Airport Land Use Commission finds the proposed grain feed mill located at 2015 Silsbee Road, El Centro, CA 92243 to be compatible with the 1996 Airport Land Use Compatibility Plan.

SECRETARY'S REPORT

Project Location:

The proposed project site consists of a +/- 5,730 square foot structure on a +/- 35.80 acres parcel located at 2015 Silsbee Road, El Centro, CA 92243 on the northwest corner of the intersection of Silsbee Road and West Evan Hewes Hwy; Assessor's Parcel Number 062-080-015-000 (See attached Vicinity Map).

Project Description:

The project applicant La Valle Sabbia, Inc, proposes Conditional Use Permit #23-0001 to construct and operate a grain feed mill located within the boundaries of the existing hay press and hay storage facility. The mill will be located on a +/- 5,730 square foot area of a +/- 35.80 acres parcel with Assessor's Parcel Number (APN) 062-080-015-000. The proposed project consists of two (2) 500-ton grain silos that are 46 feet high and a width of 29 feet, two (2) holding tanks that are 29 feet, 2 inches high and a width of 15 feet, 4 inches, and two (2) flaking mills with steam chests that are 34 feet high and a width of 7 feet that sit on top of structural and concrete bunkers that are 11 feet, 4 inches high and a width of 34 feet. The total height of the flaking mills with the structural bunkers will be 45 feet in height. Additionally, there will be two (2) grain elevators that are 70 feet high and a width of 10 feet, a 60 feet high grain elevator with a width of 8 feet and two (2) grain holding tanks are 29 feet high and 16 feet in width

The project parcel is currently zoned A-2 (General Agriculture) and the proposed grain feed mill would allow for the proposed use under Title 9, Division 5, Section 90515.02 "Uses Permitted Only with a conditional Use Permit".

General Plan/ALUCP Analysis:

This project is being brought to the Airport Land Use Commission due to the applicant proposing to erect new structures with a maximum height of 70 feet on developed land containing a hay press and hay storage yard within the B1 Zone (Approach/Departure Zone and Adjacent to Runway) of the Imperial County Airport Land Use Compatibility Plan. The B1 zone allows for any agricultural use except ones attracting bird flocks, pg 2-17 of the ALUCP. The corn and wheat to be stored onsite for use in the mill will be held in two (2) 500-ton enclosed silos as well as two (2) grain holding tanks which is expected to mitigate attraction of bird flocks to the site. In addition, the property is an active hay press and hay storage site with truck activity that is expected to prevent flocks of birds from congregating on the premises.

The ALUCP, Chapter 2, Policies, Section 2.1.3, provides "Types of Actions Reviewed" by the Commission, which shall include:

"Any other proposed land use action, as determined by the local planning agency, involving a question of compatibility with airport activities" (Section 2.1.3.3h, pg. 2-4).

Attachments

- A - Vicinity Map
- B - Site Plan
- C - Assessor's Plat Map
- D - ALUCP Zone Map
- E - ALUC Section

ATTACHMENT "A"
Vicinity Map

PROJECT LOCATION MAP



LA VALLE SABBIA, INC
CUP #23-0001
APN 062-080-015-000

-  Project Location
-  Centerline
-  Parcels
-  Proposed Feed Mill Location



ATTACHMENT "B"
Site Plan



TOWER 1 - FLOOR / SECTION / ELEVATION PLAN

2115 SILSBEE RD, EL CENTRO, CA 92243

500 TON SILO

PROJECT:

No.	REVISIONS	DATE

ENGINEER:

SEAL:

PROJECT #:

SHEET
SP

DATE:
NOV 2022

SCALE:
1/4"=1'-0"



SCALE 1/26" x 1'-0"

SITE PLAN

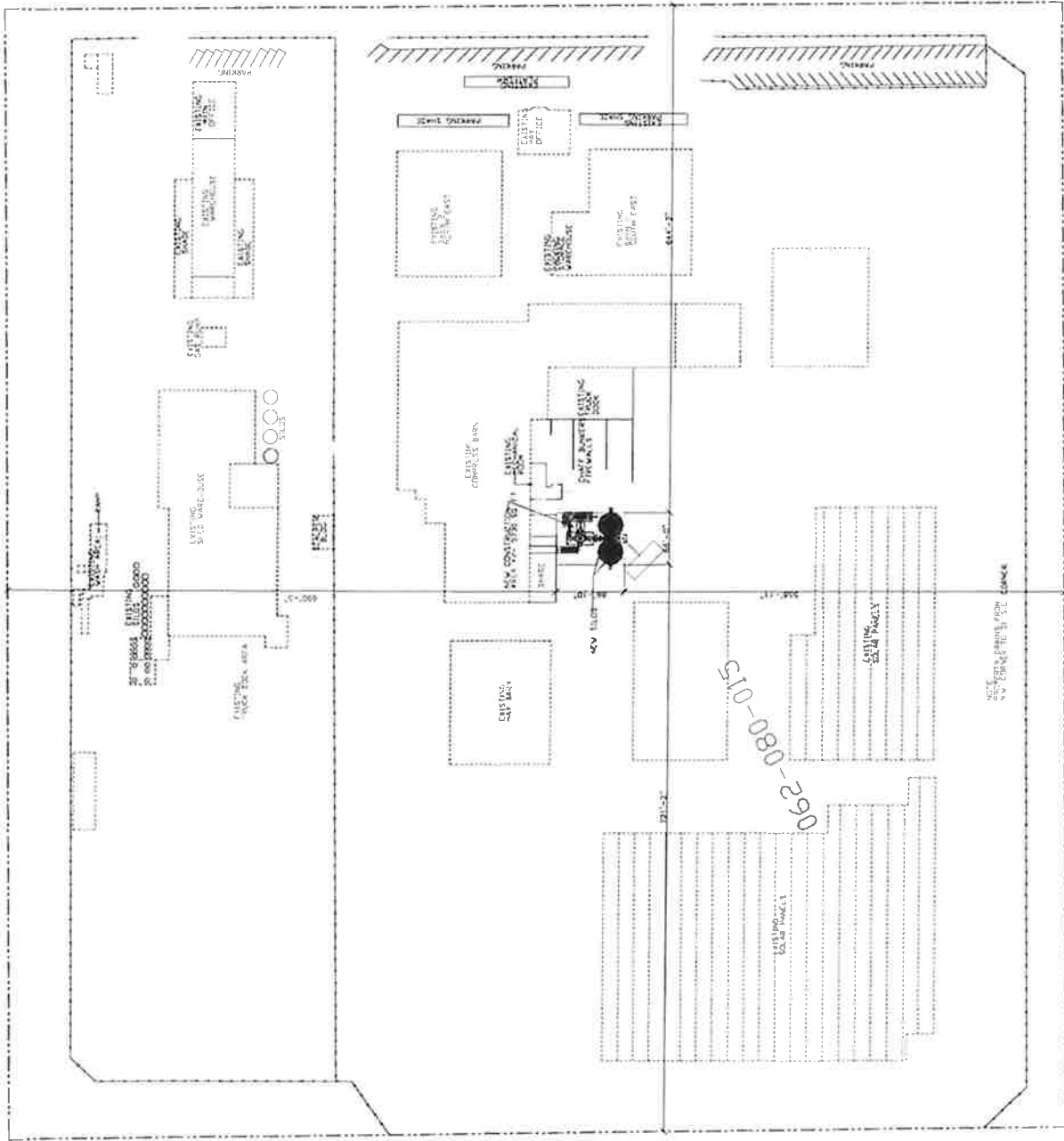

062-080-015

NOTE: SEE EXISTING APP. ZONING

ATTACHMENT "C"
Assessor's Plat Map

TRACT 123, 126, 127, 128, 153, 154, 155, 180, 182C, 182D, SEC. 1, 29 TO 32 INCL., & POR. SEC. 1, 12, 30, 31, T.15 & 16S., R.12 & 13E.

Tax Area Code 85-001

62-0E

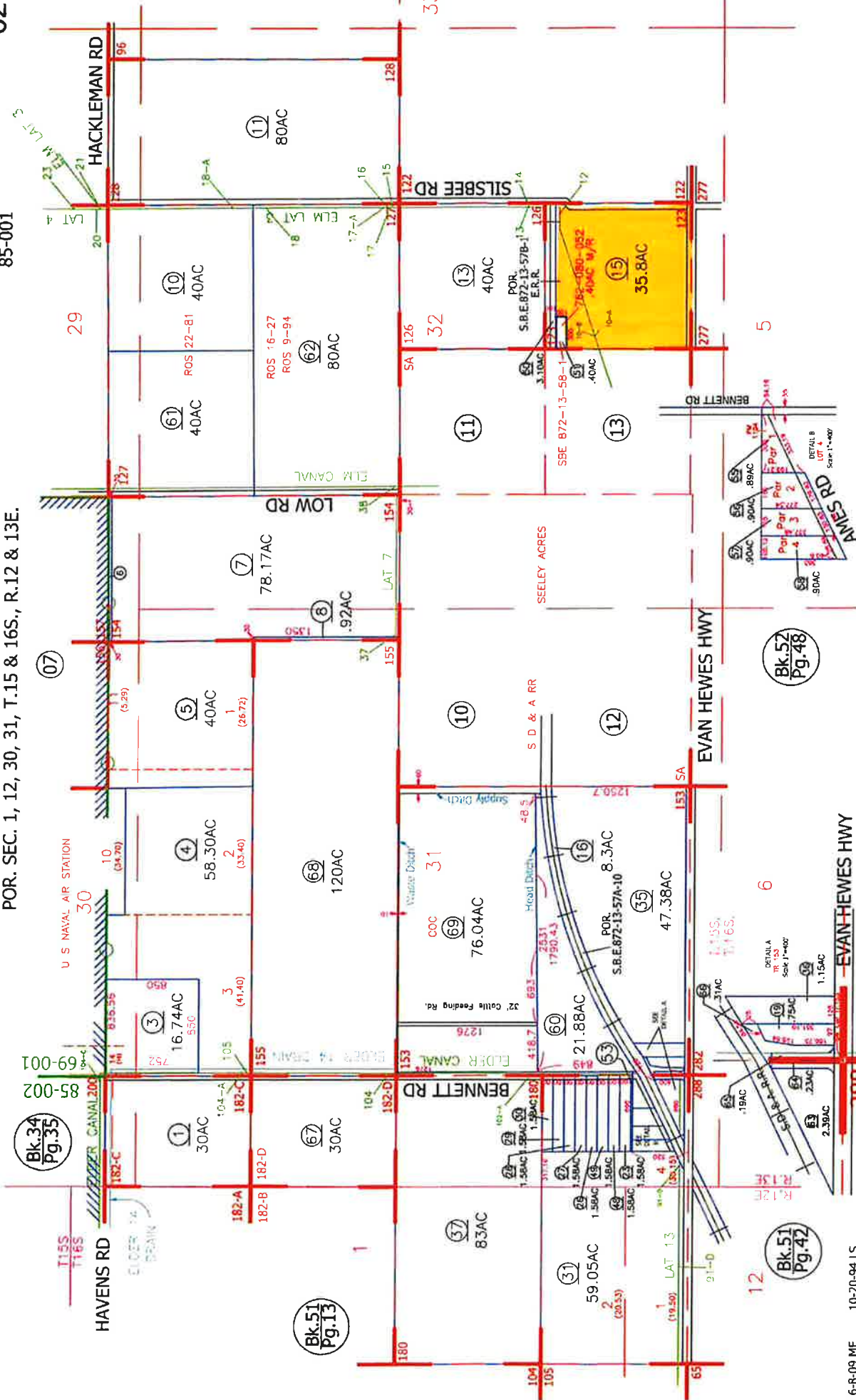
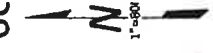

EVAN HEWES HWY

Bk.51 Pg.42

Bk.52 Pg.48

DETAIL A
Scale 1"=400'

DISCLAIMER:
THIS IS NOT AN OFFICIAL MAP.
FOR THE PURPOSES OF THIS MAP, THE COUNTY HAS CONDUCTED A VISUAL GENERAL VERIFICATION OF THE AERIAL PHOTOGRAPHY AND THE AERIAL PHOTOGRAPHY HAS BEEN CORRECTED TO REFLECT THE INFORMATION ON THE GROUND. THE COUNTY DOES NOT WARRANT THE ACCURACY OF THE INFORMATION ON THE GROUND. THE COUNTY DOES NOT WARRANT THE ACCURACY OF THE INFORMATION ON THE GROUND.

- 6-8-09 MF 10-20-94 LS
- FROM 43-36 11-6-97 RM
- 07-14-06 RM 3-31-93 DP
- 5-12-99 RM 11-4-93 LS
- 3-19-99 LS 9-1-94 LS
- 7-12-17 MF 6-16-14 MF

**ATTACHMENT “D”
ALUCP Zone Map**

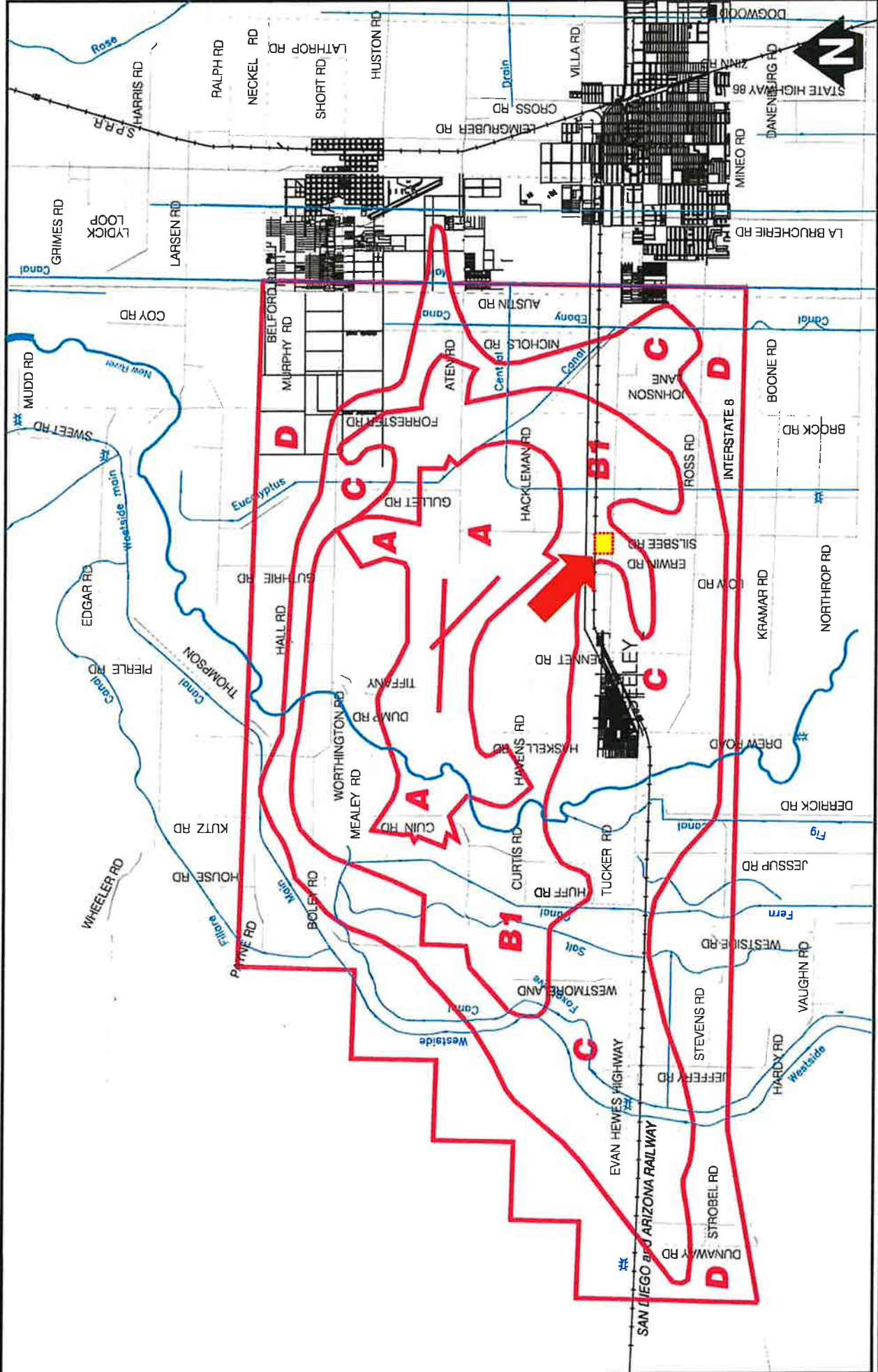

Compatibility Map
 Naval Air Facility El Centro
 K:\ALUCAP-3G.DWG

 Project Location
 2015 Silsbee Rd APN 062-080-015

FIGURE 3G

airport land use compatibility plan

**ATTACHMENT "E" ALUCP
Chapter 2 Pages 2-2, 2-3, 2-
4 and 2-17**

2. *Countywide Impacts on Flight Safety* - Those lands, regardless of their location in the County, on which the uses could adversely affect the safety of flight in the County. The specific uses of concern are identified in Paragraph 2.
3. *New Airports and Heliports* - The site and environs of any proposed new airport or heliport anywhere in the County. The Brawley Pioneers Memorial Hospital has a heliport area on-site.

2. Types of Airport Impacts

The Commission is concerned only with the potential impacts related to aircraft noise, land use safety (with respect both to people on the ground and the occupants of aircraft), airspace protection, and aircraft overflights. Other impacts sometimes created by airports (e.g., air pollution, automobile traffic, etc.) are beyond the scope of this plan. These impacts are within the authority of other local, state, and federal agencies and are addressed within the environmental review procedures for airport development.

3. Types of Actions Reviewed

1. *General Plan Consistency Review* - Within 180 days of adoption of the *Airport Land Use Compatibility Plan*, the Commission shall review the general plans and specific plans of affected local jurisdictions to determine their consistency with the Commission's policies. Until such time as (1) the Commission finds that the local general plan or specific plan is consistent with the *Airport Land Use Compatibility Plan*, or (2) the local agency has overruled the Commission's determination of inconsistency, the local jurisdiction shall refer all actions, regulations, and permits (as specified in Paragraph 3) involving the airport area of influence to the Commission for review (Section 21676.5 (a)).
2. *Statutory Requirements* -As required by state law, the following types of actions shall be referred to the Airport Land Use Commission for determination of consistency with the Commission's plan *prior to their approval* by the local jurisdiction:

- (a) The adoption or approval of any amendment to a general or specific plan affecting the Commission's geographic area of concern as indicated in Paragraph 1 (Section 21676 (b)).
- (b) The adoption or approval of a zoning ordinance or building regulation which (1) affects the Commission's geographic area of concern as indicated in Paragraph 1 and (2) involves the types of airport impact concerns listed in Paragraph 2 (Section 21676 (b)).
- (c) Adoption or modification of the master plan for an existing public-use airport (Section 21676 (c)).
- (d) Any proposal for a new airport or heliport whether for public use or private use (Section 21661.5).

3. *Other Project Review* - State law empowers the Commission to review additional types of land use "actions, regulations, and permits" involving a question of airport/land use compatibility if either: (1) the Commission and the local agency agree that these types of individual projects shall be reviewed by the Commission (Section 21676.5 (b)); or (2) the Commission finds that a local agency has not revised its general plan or specific plan or overruled the Commission and the Commission requires that the individual projects be submitted for review (Section 21676.5 (a)). For the purposes of this plan, the specific types of "actions, regulations, and permits" which the Commission shall review include:

- a) Any proposed expansion of a city's sphere of influence within an airport's planning area.
- b) Any proposed residential planned unit development consisting of five or more dwelling units within an airport's planning area.
- c) Any request for variance from a local agency's height limitation ordinance.
- d) Any proposal for construction or alteration of a structure (including antennas) taller than 150 feet above the ground anywhere within the County.

- e) Any major capital improvements (e.g., water, sewer, or roads) that would promote urban development.
- f) Proposed land acquisition by a government entity (especially, acquisition of a school site).
- g) Building permit applications for projects having a valuation greater than \$500,000.
- h) Any other proposed land use action, as determined by the local planning agency, involving a question of compatibility with airport activities.

4. Review Process

1. *Timing of Project Submittal* - Proposed actions listed in Paragraph 3.1 must be submitted to the Commission for review prior to approval by the local government entity. All projects shall be referred to the Commission at the earliest reasonable point in time so that the Commission's review can be duly considered by the local jurisdiction prior to formalizing its actions. At the local government's discretion, submittal of a project for Airport Land Use Commission review can be done before, after, or concurrently with review by the local planning commission or other local advisory bodies.
2. *Commission Action Choices* - When reviewing a land use project proposal, the Airport Land Use Commission has a choice of either of two actions: (1) find the project *consistent* with the *Airport Land Use Compatibility Plan*; or, (2) find the project *inconsistent* with the Plan. In making a finding of inconsistency, the Commission may note the conditions under which the project would be consistent with the Plan. The Commission cannot, however, find a project consistent with the Plan subject to the inclusion of certain conditions in the project.

Table 2A

Compatibility Criteria

Imperial County Airport Land Use Compatibility Plan

Zone	Location	Impact Elements	Maximum Densities		Required Open Land ³
			Residential (dw/ac) ¹	Other Uses (people/ac) ²	
A	Runway Protection Zone or within Building Restriction Line	<ul style="list-style-type: none"> High risk High noise levels 	0	10	All Remaining
B1	Approach/Departure Zone and Adjacent to Runway	<ul style="list-style-type: none"> Substantial risk - aircraft commonly below 400 ft. AGL or within 1,000 ft. of runway Substantial noise 	0.1	100	30%
B2	Extended Approach/Departure Zone	<ul style="list-style-type: none"> Significant risk - aircraft commonly below 800 ft. AGL Significant noise 	1	100	30%
C	Common Traffic Pattern	<ul style="list-style-type: none"> Limited risk - aircraft at or below 1,000 ft. AGL Frequent noise intrusion 	5	200	15%
D	Other Airport Environs	<ul style="list-style-type: none"> Negligible risk Potential for annoyance from overflights 	No Limit	No Limit	No Requirement

Zone	Additional Criteria		Examples	
	Prohibited Uses	Other Development Conditions	Normally Acceptable Uses ⁴	Uses Not Normally Acceptable ⁵
A	<ul style="list-style-type: none"> All structures except ones with location set by aeronautical function Assemblages of people Objects exceeding FAR Part 77 height limits Hazards to flight⁶ 	<ul style="list-style-type: none"> Dedication of aviation easement 	<ul style="list-style-type: none"> Aircraft tiedown apron Pastures, field crops, vineyards Automobile parking 	<ul style="list-style-type: none"> Heavy poles, signs, large trees, etc.
B1 and B2	<ul style="list-style-type: none"> Schools, day care centers, libraries Hospitals, nursing homes Highly noise-sensitive uses Above ground storage Storage of highly flammable materials Hazards to flight⁶ 	<ul style="list-style-type: none"> Locate structures maximum distance from extended runway centerline Minimum NLR⁷ of 25 dBA in residential and office buildings Dedication of aviation easement 	<ul style="list-style-type: none"> Uses in Zone A Any agricultural use except ones attracting bird flocks Warehousing, truck terminals Single-story offices 	<ul style="list-style-type: none"> Residential subdivisions Intensive retail uses Intensive manufacturing or food processing uses Multiple story offices Hotels and motels
C	<ul style="list-style-type: none"> Schools Hospitals, nursing homes Hazards to flight⁶ 	<ul style="list-style-type: none"> Dedication of overflight easement for residential uses 	<ul style="list-style-type: none"> Uses in Zone B Parks, playgrounds Low-intensity retail, offices, etc. Low-intensity manufacturing, food processing Two-story motels 	<ul style="list-style-type: none"> Large shopping malls Theaters, auditoriums Large sports stadiums Hi-rise office buildings
D	<ul style="list-style-type: none"> Hazards to flight⁶ 	<ul style="list-style-type: none"> Deed notice required for residential development 	<ul style="list-style-type: none"> All except ones hazardous to flight 	

APPLICATION

CONDITIONAL USE PERMIT

I.C. PLANNING & DEVELOPMENT SERVICES DEPT.
801 Main Street, El Centro, CA 92243 (760) 482-4236

- APPLICANT MUST COMPLETE ALL NUMBERED (black) SPACES - Please type or print -

1. PROPERTY OWNER'S NAME <i>La Valle Sabbia, Inc</i>	EMAIL ADDRESS <i>Lhoro @ abatti.com</i>	
2. MAILING ADDRESS (Street / P O Box, City, State) <i>2015 Sillsbee road, El Centro, CA</i>	ZIP CODE <i>92243</i>	PHONE NUMBER <i>760 996 6066</i>
3. APPLICANT'S NAME <i>Luis Haro</i>	EMAIL ADDRESS <i>Lhoro @ abatti.com</i>	
4. MAILING ADDRESS (Street / P O Box, City, State) <i>2015 Sillsbee road, El Centro CA</i>	ZIP CODE <i>92243</i>	PHONE NUMBER <i>760 996 6066</i>
4. ENGINEER'S NAME <i>Erafin Ruzola Limon</i>	CA. LICENSE NO. <i>C072913</i>	EMAIL ADDRESS <i>Evega@newsteelFabricators.com</i>
5. MAILING ADDRESS (Street / P O Box, City, State) <i>225 Wave Av #99, El Centro CA</i>	ZIP CODE <i>92243</i>	PHONE NUMBER <i>760 801 9301</i>

6. ASSESSOR'S PARCEL NO. <i>062-080-015</i>	SIZE OF PROPERTY (in acres or square foot) <i>35.8 acres</i>	ZONING (existing) <i>A2</i>
7. PROPERTY (site) ADDRESS <i>2015 Sillsbee road, El Centro CA 92243</i>		
8. GENERAL LOCATION (i.e. city, town, cross street) <i>Corner of Sillsbee road and Evan Hewes</i>		
9. LEGAL DESCRIPTION <i>Tract 123, section 32, Township 15 South Range 13 east 50M In an incorporated area of the County of Imperial State of California as Per official Plat thereof</i>		

PLEASE PROVIDE CLEAR & CONCISE INFORMATION (ATTACH SEPARATE SHEET IF NEEDED)

10. DESCRIBE PROPOSED USE OF PROPERTY (list and describe in detail) <i>Installed and operate Feed processing equipment and grain storage tanks</i>	
11. DESCRIBE CURRENT USE OF PROPERTY <i>Farm equipment parking</i>	
12. DESCRIBE PROPOSED SEWER SYSTEM _____	
13. DESCRIBE PROPOSED WATER SYSTEM <i>use existing water system</i>	
14. DESCRIBE PROPOSED FIRE PROTECTION SYSTEM _____	
15. IS PROPOSED USE A BUSINESS? <input checked="" type="checkbox"/> Yes <input type="checkbox"/> No	IF YES, HOW MANY EMPLOYEES WILL BE AT THIS SITE? <i>2 Employees</i>

I / WE THE LEGAL OWNER (S) OF THE ABOVE PROPERTY CERTIFY THAT THE INFORMATION SHOWN OR STATED HEREIN IS TRUE AND CORRECT.

<i>[Signature]</i> Print Name _____	<i>[Signature]</i> Date _____
Signature _____	Date _____
Print Name _____	Date _____
Signature _____	

REQUIRED SUPPORT DOCUMENTS

A. SITE PLAN	_____
B. FEE	_____
C. OTHER	_____
D. OTHER	_____

APPLICATION RECEIVED BY: <i>LV</i>	DATE <i>01/13/23</i>	REVIEW / APPROVAL BY OTHER DEPT'S required.
APPLICATION DEEMED COMPLETE BY: _____	DATE _____	<input type="checkbox"/> P. W.
APPLICATION REJECTED BY: _____	DATE _____	<input type="checkbox"/> E. H. S.
TENTATIVE HEARING BY: _____	DATE _____	<input type="checkbox"/> A. P. C. D.
FINAL ACTION: <input type="checkbox"/> APPROVED <input type="checkbox"/> DENIED	DATE _____	<input type="checkbox"/> O. E. S.
		<input type="checkbox"/> _____

CUP #
230001

Project Description for CUP #23-0001

This project consists on a grain receiving and storage operation as well as corn and wheat grain rolling operation to produce feed for livestock consumption. The grain is stored on the silos and transported with grain elevators and conveyors to the flaking mills that process the grain and turns it into flaked corn and wheat that is stored on concrete bunkers and transported daily to LVS Cattle feeders Feed yard at 495 West Heber Road, El Centro, CA.

The corn grain will be trucked in from Calipatria and the wheat grain will be provided by Allstar Seed Company at the same address as the feed processing project at 2015 Silsbee Road, El Centro.

The proposed hours of operation for feed processing and delivery to LVS Cattle Feeders feed yard are 12am to 6am Monday to Saturday.

The proposed area to be developed is +/- 5730 SQ. FT. The two 500-ton Grain Silos are 46 feet height, 29 feet width. The two holding tanks are 29 feet, 2 inches height and 15 feet and 4 inches width. The 2 flaking mills with steam chests are 34 feet height and 7 feet width and they sit on top of structural and concrete bunkers that are 34 feet width and 11 feet and 4 inches height. Two grain elevators are 70 feet height and 10 feet width. One grain elevator is 60 feet height and 8 feet width. Two grain holding tanks are 29 feet height and 16 feet width. Also, building permit number 61443 is in process for installation of this equipment.

The estimated daily traffic is 8 trucks entering and leaving the facility and 2 employee vehicles entering and leaving the parking lot.

Luis Haro

Project Manager

760-996-6066

2015 Silsbee road El Centro CA 92243

R&R MACHINE WORKS 18 X 36 CONVENTIONAL FLAKING MILL SPECIFICATIONS

WEIGHT	APPROX. 10,000 LBS.
HORSE POWER	75 HP: 1200 RPM
CAPACITY (28 - 29 LB CORN FLAKE AT 21% MOISTURE)	8-10 TPH
ROLL RPM	350
JOURNALS (SHAFTS)	4 $\frac{15}{16}$ DIA. 4140 HR HT
ROLL FRAME	13" X 50# CHANNEL IRON
ROLL COVERS	10 GA. STAINLESS STEEL
BEARING HOUSINGS	CAST IRON
HYDRAULIC ROLL CLOSURE SYSTEM	
DIRECT DRIVE PEG FEEDER BAR	
AUTOMATED CONTROL OPTION	
FEEDER CLOSURE GATE	

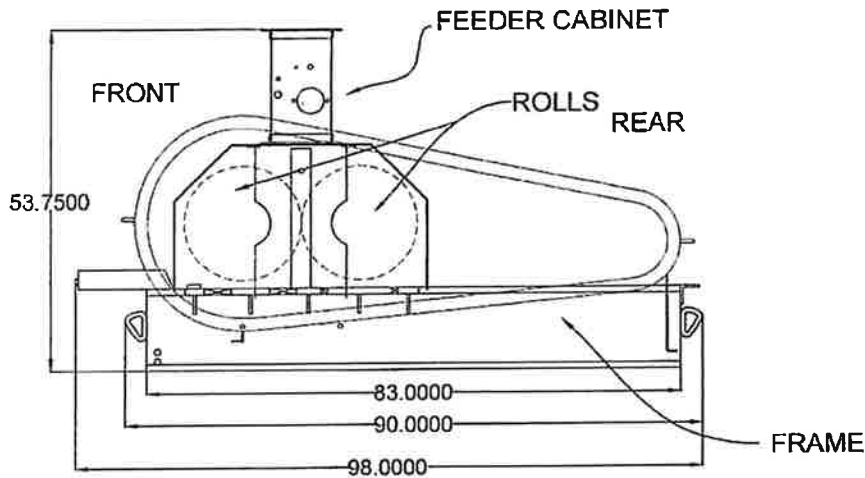
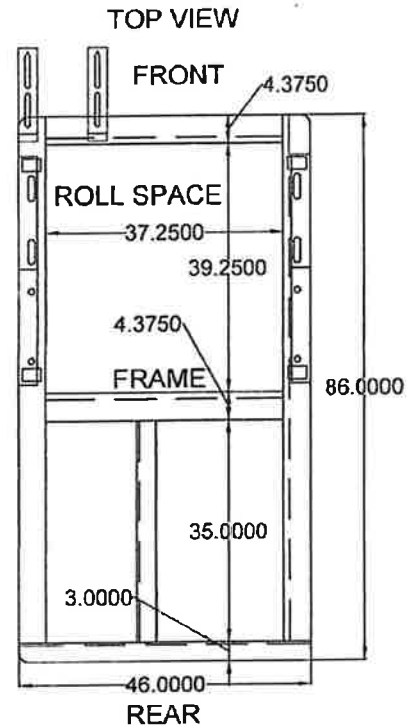
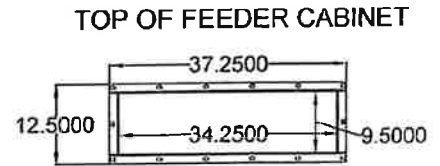
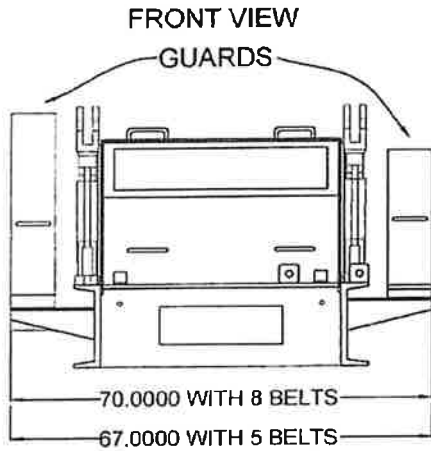

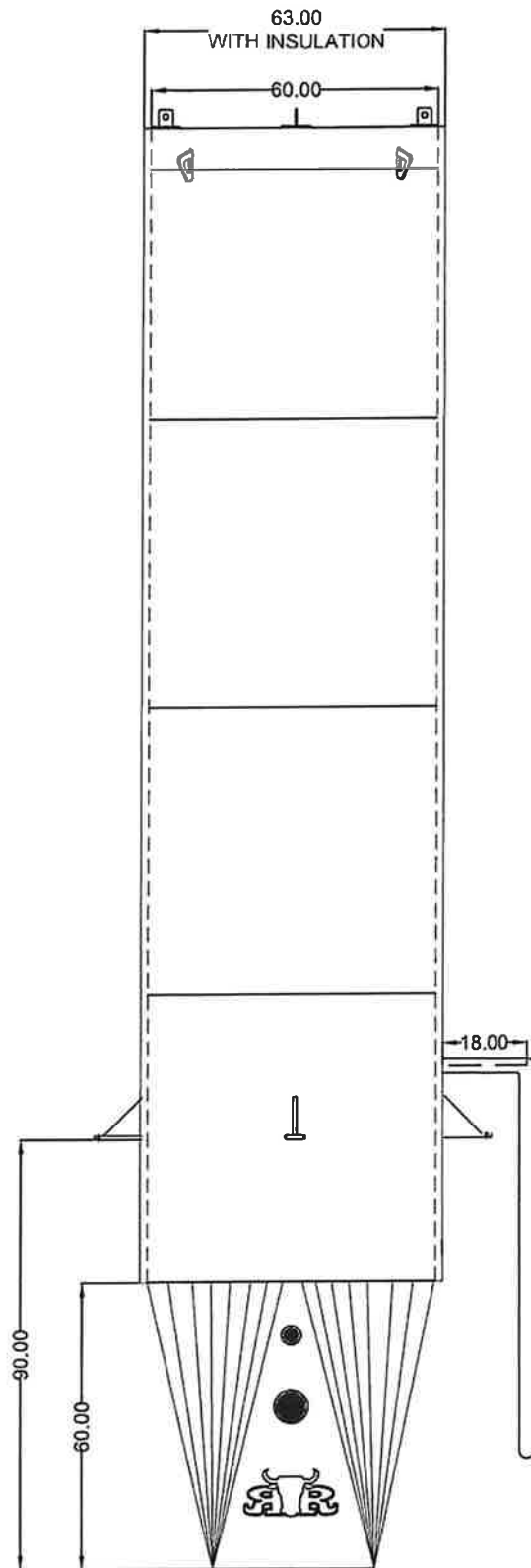
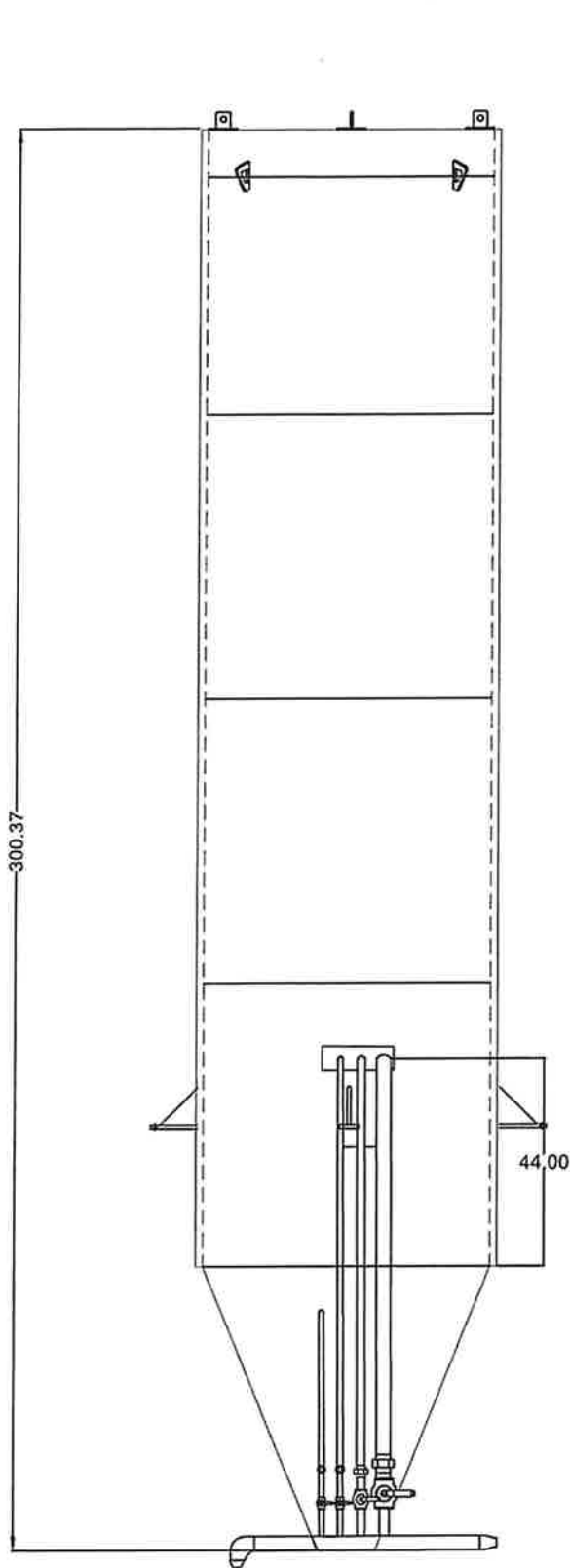

DATE: 3/14/2022

1		
2		
3		
4		
5		
6		
7		
8		
9		
10		
11		
12		
13		
14		
15		
16		
17		
18		
19		
20		
21		
22		
23		
24		
25		
26		
27		
28		
29		
30		
31		
32		
33		
34		
35		
36		
37		
38		
39		
40		
41		
42		
43		
44		
45		
46		
47		
48		
49		
50		
51		
52		
53		
54		
55		
56		
57		
58		
59		
60		
61		
62		
63		
64		
65		
66		
67		
68		
69		
70		
71		
72		
73		
74		
75		
76		
77		
78		
79		
80		
81		
82		
83		
84		
85		
86		
87		
88		
89		
90		
91		
92		
93		
94		
95		
96		
97		
98		
99		
100		

SCALE: 1:0.026

DRAWN BY: KENT BLAIN

NOTES:

ALL DIMENSIONS ARE IN INCHES - INTERPRET DIMENSIONS AND TO FINISH PER ASME Y14.5 - 2009 TOLERANCES UNLESS OTHERWISE SPECIFIED:
 FO = ± .001
 RM = ± .010
 RM2 = ± .002
 UNLESS OTHERWISE SPECIFIED
 REMOVE ALL SHARP EDGES PER SHARP EDGE RULE, 3RD

This drawing and/or any technical information contained herein are the sole property of DALHART R & R MACHINE WORKS, INC. and shall not be reproduced in whole or in part, nor used to manufacture anything illustrated or referenced without the specific written permission of DALHART R & R MACHINE WORKS, INC., 1006 LIBERAL STREET, DALHART, TEXAS 79022 USA



DALHART R & R MACHINE WORKS INC.,
 P.O. BOX 1330 • 1006 LIBERAL ST • DALHART, TX 79022 • (806) 244-6686
 60 X 25 STEAM CHEST
 60 X 25 STEAM CHEST.DWG

- NOTES:**
1. WHEN INSTALLING FLOWMORE CLEANERS OR SCALPERS ON A BRIDGE IN A STEAM FLAKING APPLICATION PLEASE INSURE THAT CONDITIONING AUGERS ARE VENTED AT OR JUST BEYOND THE STEAM CHEST TO PREVENT TRAMP STEAM FROM ENTERING & COMPROMISING THE PERFORMANCE OF THE CLEANER/SCALPER.
 2. AVOID ROUTING FINES SPOUTS INTO UNVENTED FLAKE BUNKS OR ANY OTHER AREAS WHERE STEAM MAY EXIST. THIS CONDITION ALLOWS STEAM TO VENT THROUGH THE FINES SPOUT COMPROMISING THE PERFORMANCE OF THE CLEANER/SCALPER.
 3. THE OPENING OF THE FINES PACKAGES TO REMOVE DUST & FINES WILL ELIMINATE THE NEED TO PREVENT STEAM FROM ENTERING THE CLEANER/SCALPER.
 4. INSTALLATION OF THE CLEANER/SCALPER ON A STAND NEAR GROUND LEVEL WHERE PRACTICAL CAN MINIMIZE THE POSSIBILITY OF TRAMP STEAM ENTERING THE CLEANER/SCALPER & PROVIDES READY ACCESS FOR MAINTENANCE.

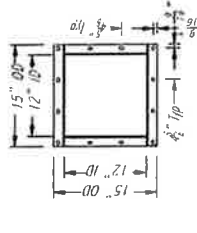

(A) DISCHARGE OUTLET
SECTION A-A
SCALE 5/64

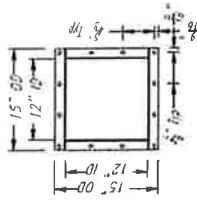

(B) INLET DETAIL
SECTION B-B
SCALE 5/64

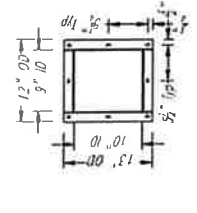

(C) TRASH OUTLET
SECTION C-C
SCALE 5/64

TOTAL ESTIMATED WEIGHT: 3769 lbmass

CUSTOMER DRAWING APPROVAL

Name: _____
 Title: _____
 Date: _____
 Signature: _____

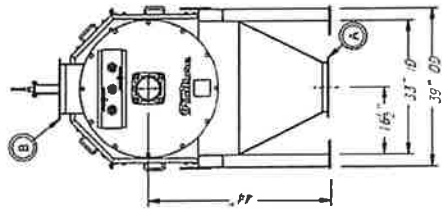
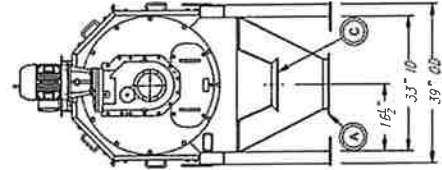
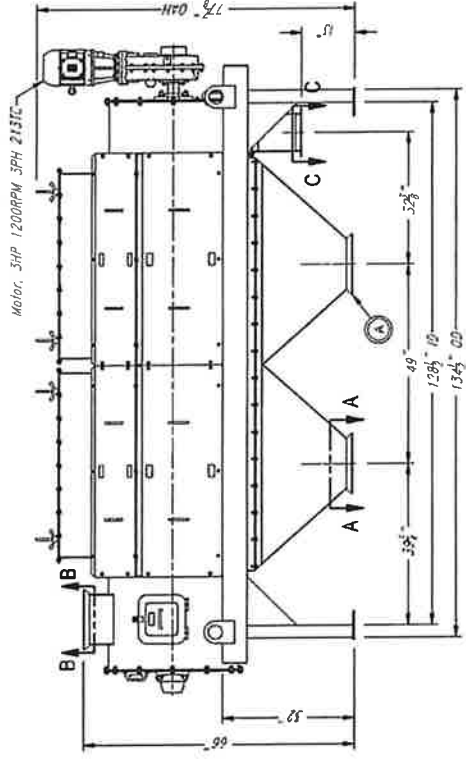
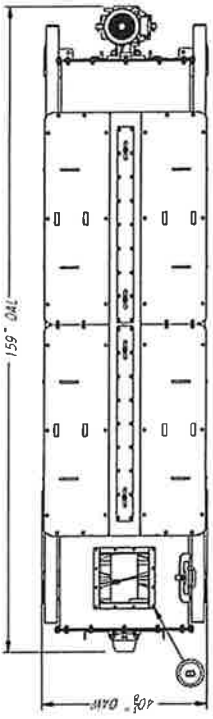

REV	DATE	INT	DESCRIPTION OF CHANGE
1	6/9/2020	AS	Released for Review/Fabrication

Ferret-Ross Roll Manufacturing Inc. Flowmore 3001 W. 10th St. #100 Fargo, ND 58103 Fax: (701) 746-2023 Email: sales@ferret-ross.com	CAD Drawing No: 6/9/2020 Drawing Date: 3/6/20 Drawing By: AS Drawing Check: AS	Fractional: 1/16" ± 1/16" Angular: 1/2° ± 1/2° Material: F155L-0.005 Part Name: RTRTY CLNR MTRZD DRV, 28" SNGL DRM - HOPPER 2 (INSTALL DWG) Drawing Scale: 1 of 1
--	---	---

This drawing is the intellectual property of the Ferret-Ross Roll Manufacturing Company, Inc and must be returned immediately upon request. No part of this drawing may be reproduced, stored in a retrieval system, or transmitted in any form or by any means without prior written consent by the Ferret-Ross Roll Manufacturing Company, Inc.

INFORMATION IS FOR YOUR INFO ONLY. IT IS NOT TO BE USED WITHOUT THE SIGNATURE OF THE DESIGNER. NOT FOR CONSTRUCTION.		SUBURBAN INDUSTRIES, INC. GEORGE WALKER	
PROJECT NO.	DATE	DRAWING NO.	SHEET NO.
4012	02/22/22	4012-02/22/22	1
DESCRIPTION	DATE	DRAWING NO.	SHEET NO.
CONY	A	4012-02/22/22	1

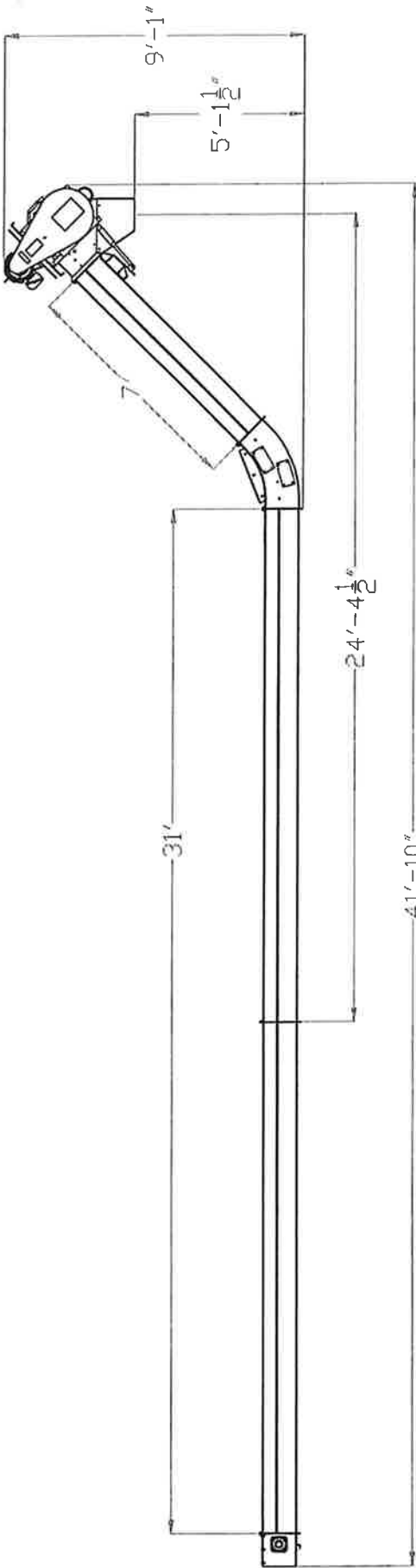



500 TON SILO
 NEW STEEL FABRICATORS
 2115 SULLICE RD. EL CENTRO, CA 92543
 SHEET TITLE: TOWER 1 - FLOOR / SECTION / ELEVATION PLAN

PROJECT:

No.	REVISIONS	DATE

ENGINEER:

SEAL:



PROJECT #:	T1
DATE:	NOV 2022
SCALE:	1/4"=1'-0"

SPECS	
I	SEC 1: L4X4X3/8
II	SEC 2: WBX40

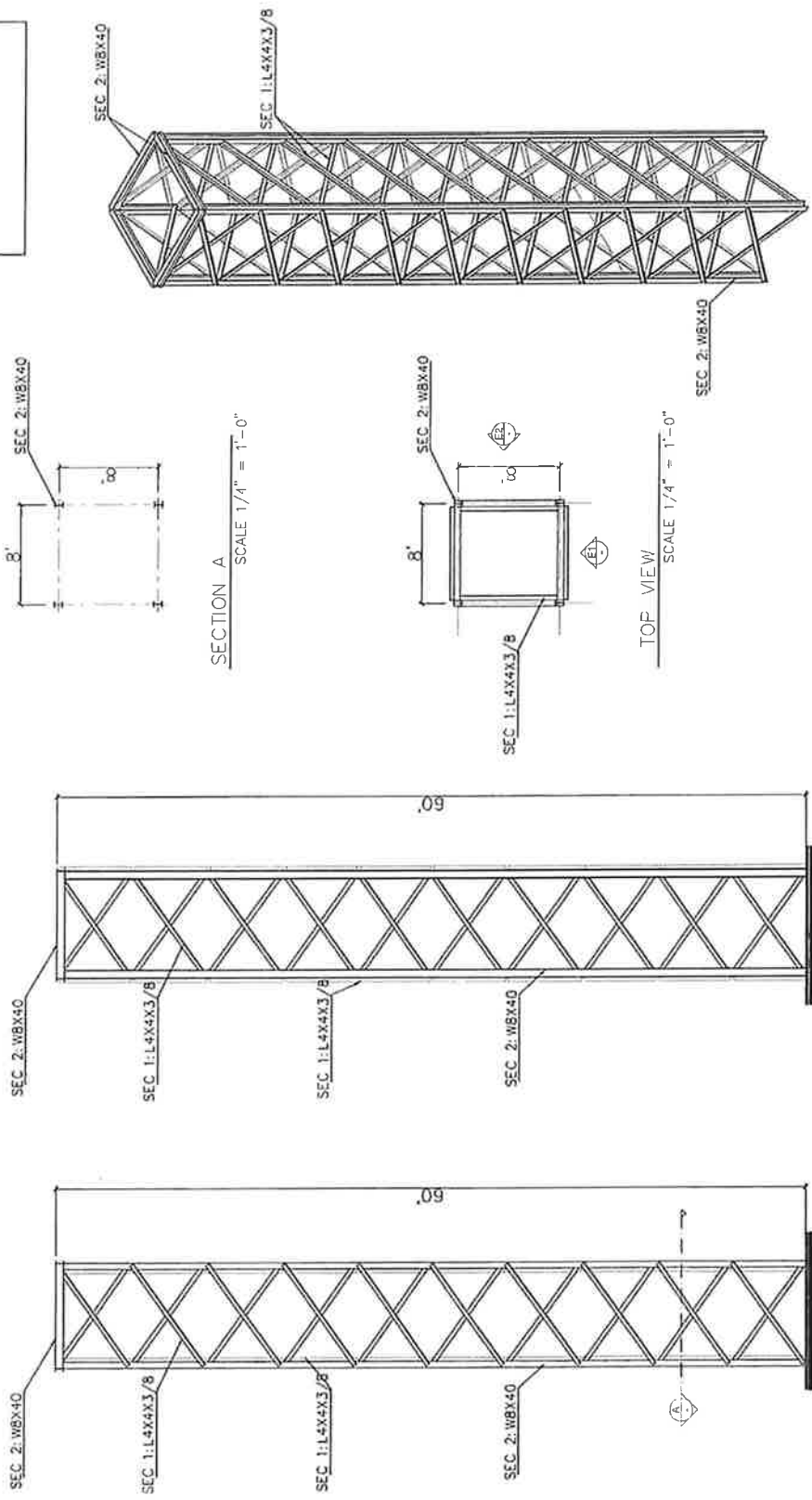

E1- ELEVATION SCALE 1/4" = 1'-0"

E2- ELEVATION SCALE 1/4" = 1'-0"

SECTION A SCALE 1/4" = 1'-0"

TOP VIEW SCALE 1/4" = 1'-0"

ISOMETRIC SCALE 1/4" = 1'-0"



PROJECT: 500 TON SILO
 NEW STEEL FABRICATORS
 2115 S. ELBERG RD. EL CENTRO, CA 92243
 TOWER 2 - FLOOR / SECTION / ELEVATION PLAN

No.	REVISIONS	DATE

ENGINEER: _____

SEAL: _____



PROJECT #: _____ SHEET: **T2**
 DATE: NOV 2022
 SCALE: 1/4"=1'-0"

SPECS	
□	SEC 1: L4X4X3/8
▤	SEC 2: WBX40

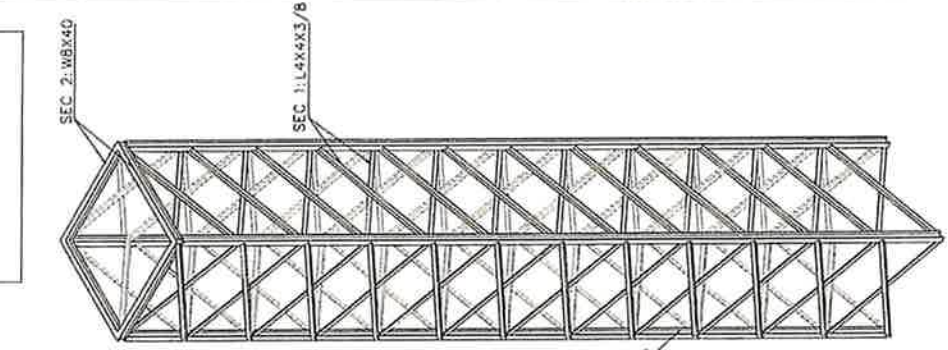

ISOMETRIC SCALE 1/4" = 1'-0"

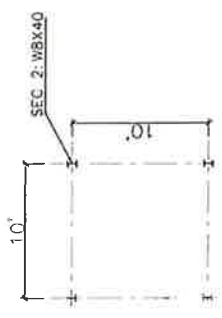

SECTION A SCALE 1/4" = 1'-0"

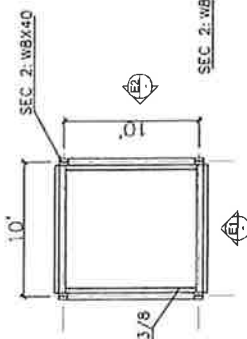

TOP VIEW SCALE 1/4" = 1'-0"

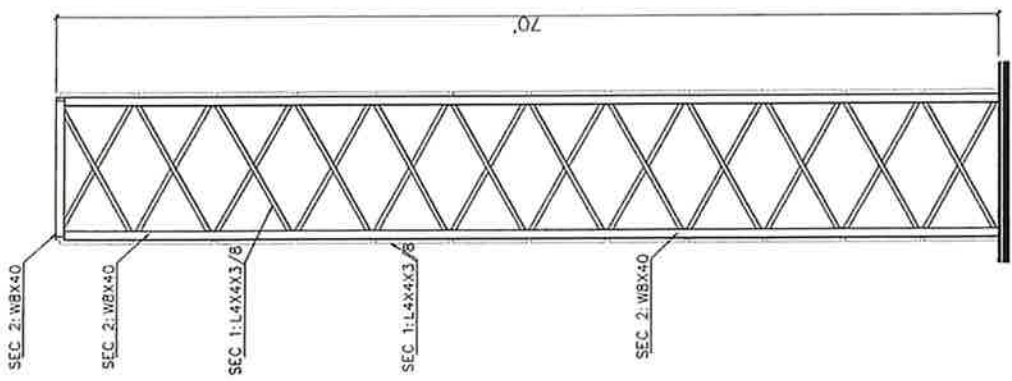

E2 - ELEVATION SCALE 1/4" = 1'-0"

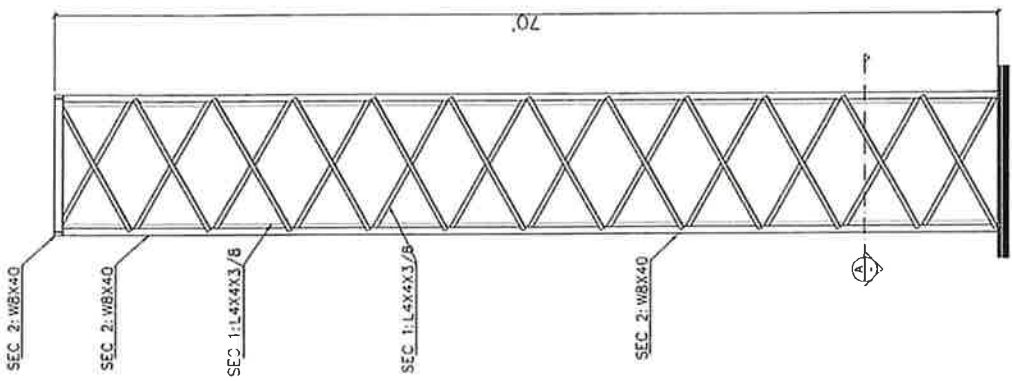

E1 - ELEVATION SCALE 1/4" = 1'-0"



500 TON SILO
 NEW STEEL FABRICATORS
 2175 SHILBEE RD. LA CENTRA CA 92231
 PROJECT SHEET
 SILO #1 - FLOOR / SECTIONS / ELEVATION PLAN

No.	REVISIONS	DATE

ENGINEER

SEAL



PROJECT #: SHEET:

S1

DATE: NOV 2022
 SCALE: 1/4" = 1'-0"

SPECS
SEC 1: W14X132
SEC 2: HSS8.625X6.500
SEC 3: W14X66

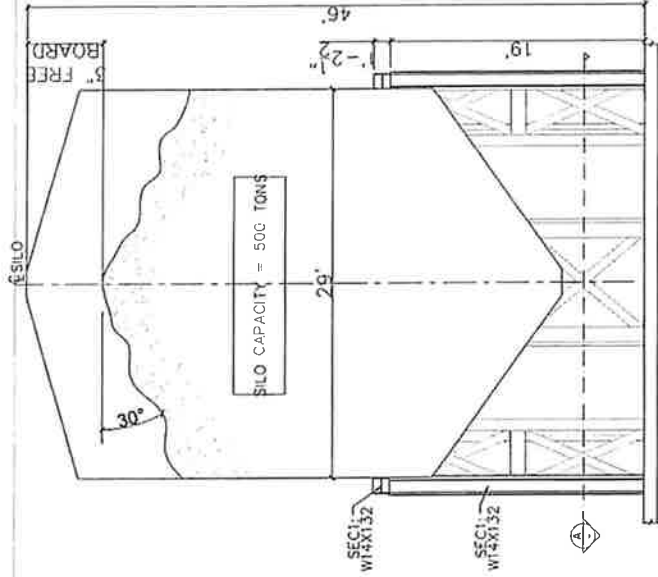

SECTION B

SCALE 1/4" = 1'-0"



SECTION A

SCALE 1/4" = 1'-0"

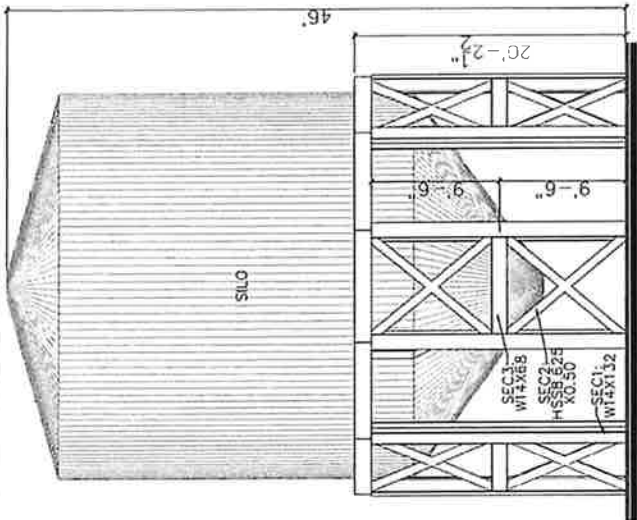

E1 - FRONT VIEW

SCALE 1/4" = 1'-0"

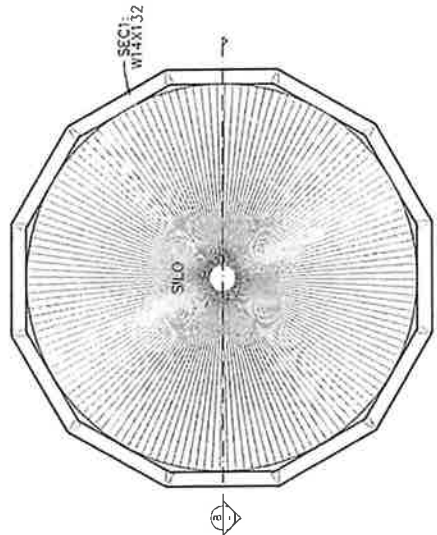

TOP VIEW

SCALE 1/4" = 1'-0"

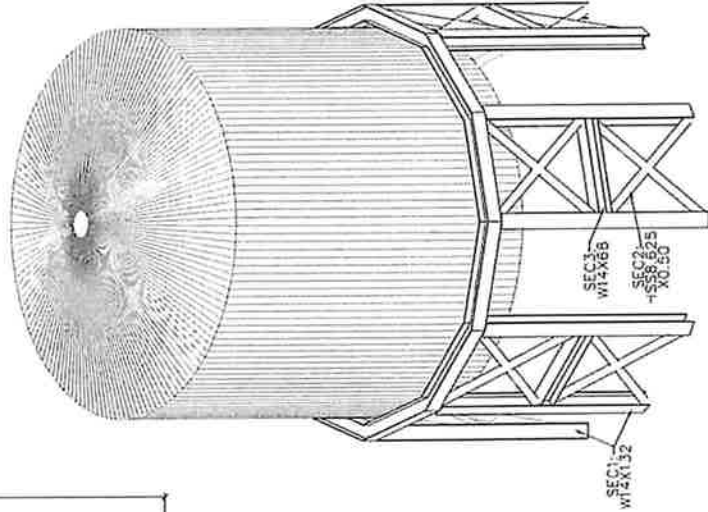

ISOMETRIC

SCALE 1/2" = 1'-0"



500 TON SILO
 NFW STEEL FABRICATORS
 2715 SILSBEE RD. CENTRO, CA 92340
 PROJECT: NFW #21
 SHEET: S2

No.	REVISIONS	DATE

ENGINEER:

SEAL:

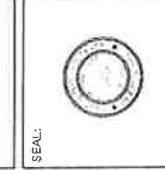

PROJECT #: SHEET: S2
 DATE: NOV 2022
 SCALE: 1/4"=1'-0"

SPECS
SEC 1: L4X4X3/8
SEC 2: L5X5X1/2
SEC 3: W10X39
SEC 4: W6X40

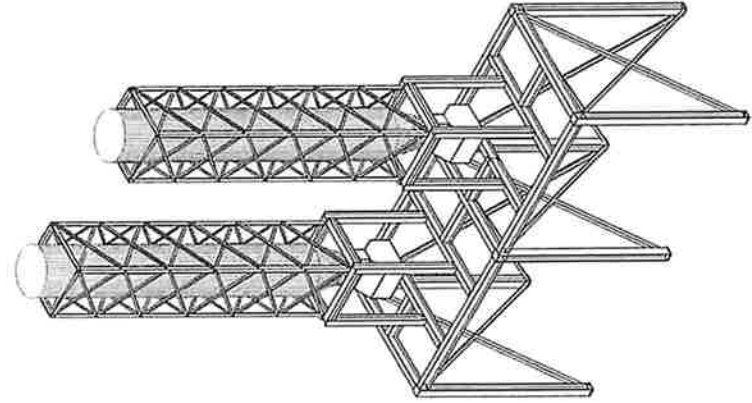

ISOMETRIC SCALE 1/4" = 1'-0"

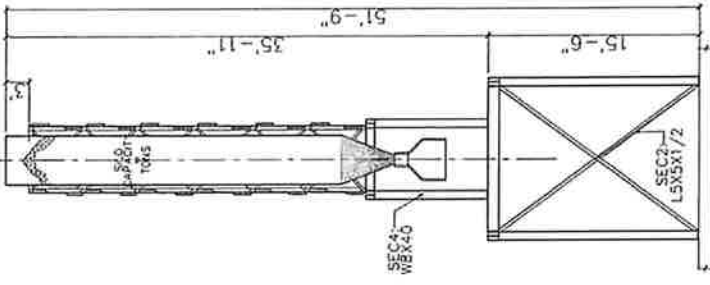

SECTION B SCALE 1/4" = 1'-0"

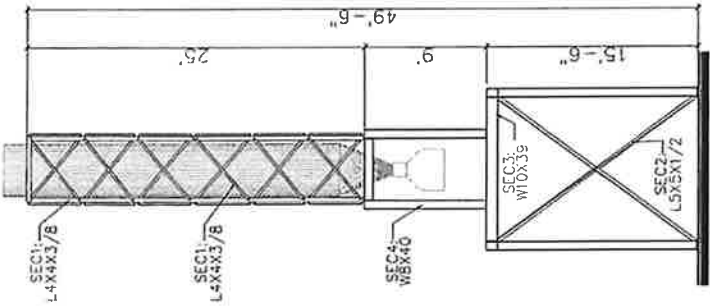

SECTION A SCALE 1/4" = 1'-0"

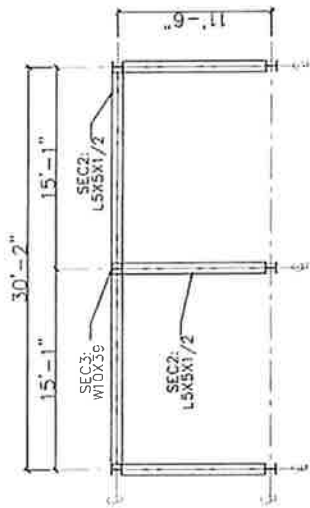

SECTION A SCALE 1/4" = 1'-0"

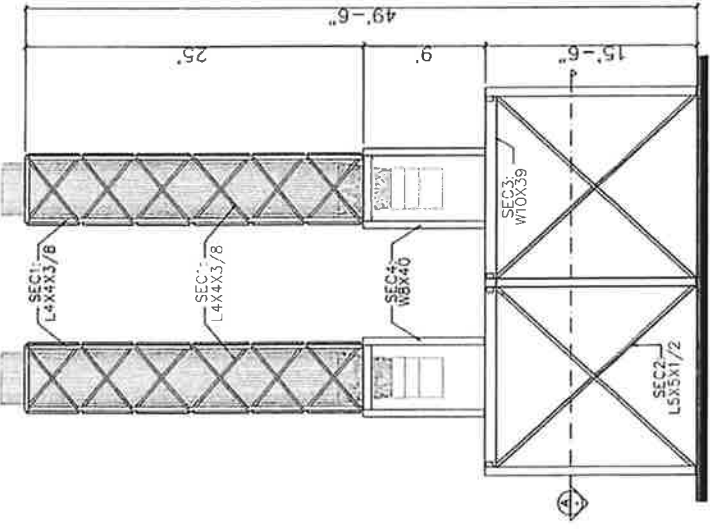

E1 - FRONT VIEW SCALE 1/4" = 1'-0"

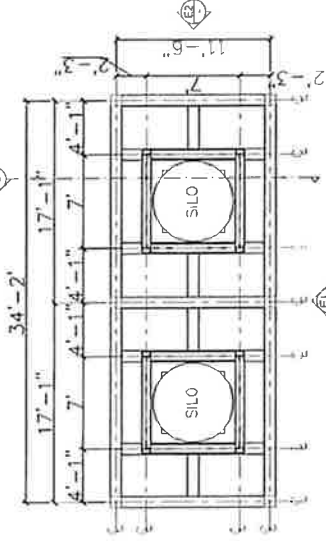

TOP VIEW SCALE 1/4" = 1'-0"



PROJECT: 500 TON SILO
 NEW STEEL FABRICATORS
 2175 SILBEE RD. EL CENTRO, CA 92543
 SHEET TITLE: SILO #3 - FLOOR / SECTIONS / SECTIONS / ELEVATION PLAN

No.	REVISIONS	DATE

ENGINEER:

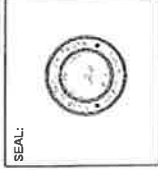

PROJECT #1: SHEET: **S3**
 DATE: NOV 2022
 SCALE: 1/4"=1'-0"

SPECS
SEC 1: W12X106
SEC 2: HSS5X0.375

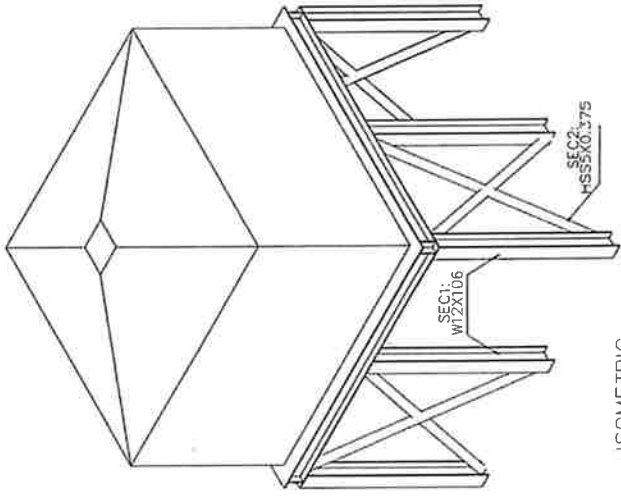
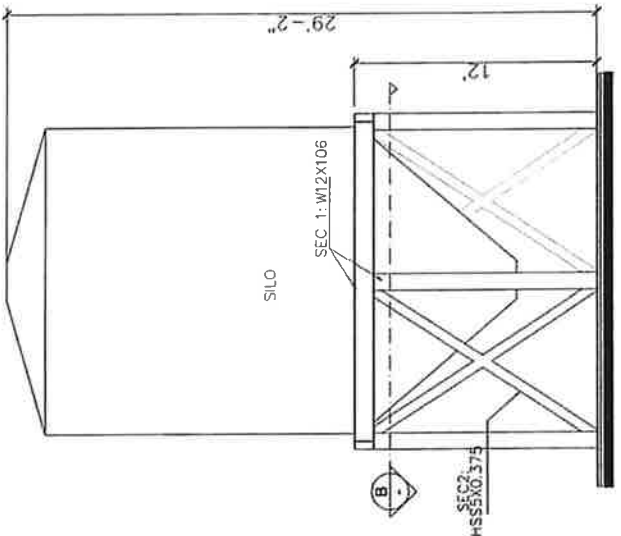
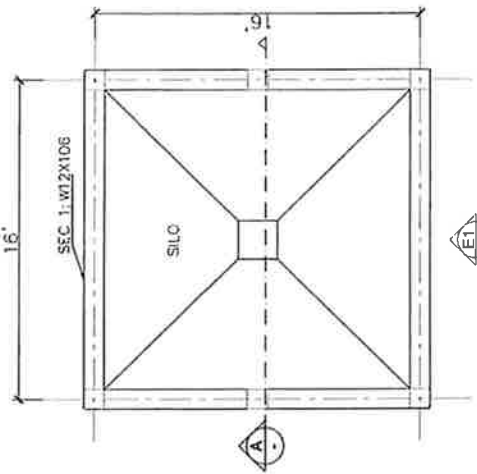
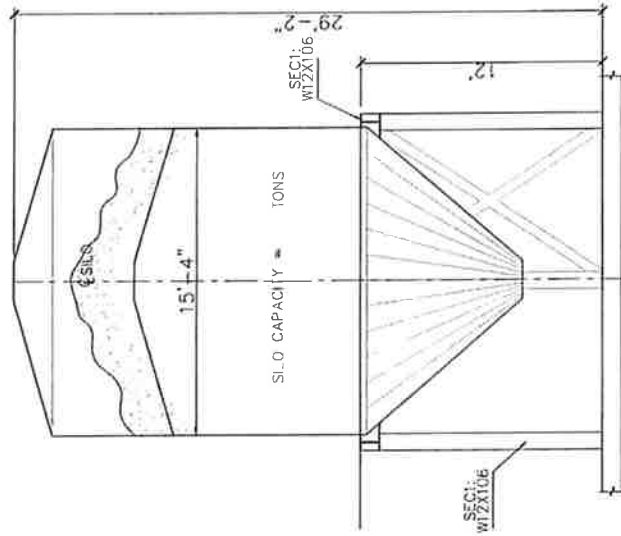
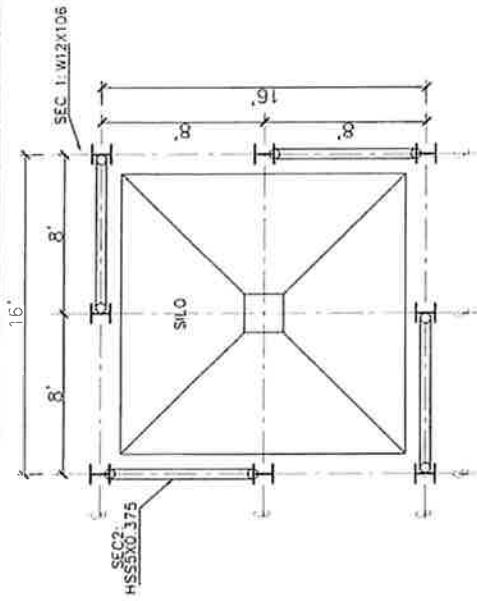



PROJECT: 500 TON SILO
 NEW STEEL FABRICATORS
 2116 SILBERG RD, EL CENTRO, CA 92543
 SHEET TITLE: CONCRETE SLAB @ 500 TONS SILOS

No.	REVISIONS	DATE

ENGINEER: _____

SEAL:

PROJECT #: _____ SHEET: **S4**
 DATE: NOV 2022
 SCALE: 1/4"=1'-0"

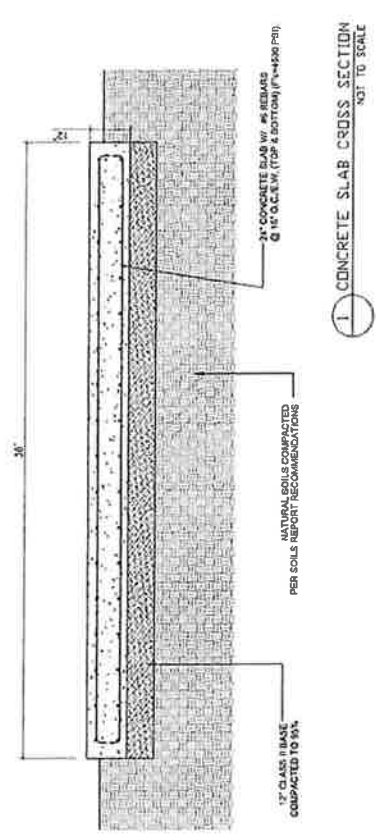
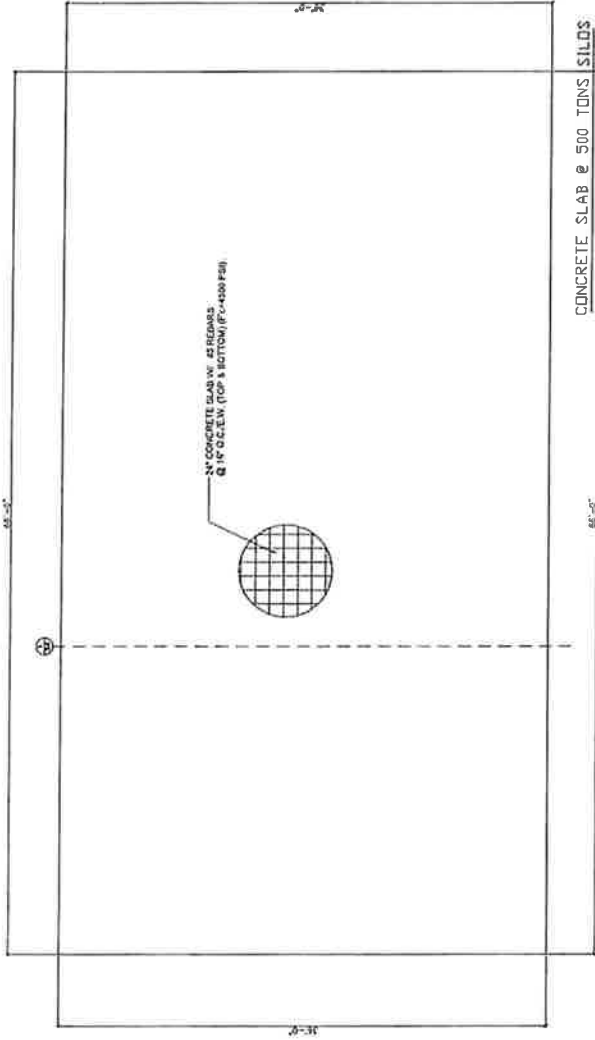



500 TON SILO
 NEW STEEL FABRICATORS
 2115 SILVER HOLE CENTER, CA 92443
 500 TON SILO FOUNDATION

PROJECT:

No.	REVISIONS	DATE

ENGINEER:

SEAL:



PROJECT #: **S5**
 DATE: NOV 2022
 SCALE: 1/4" = 1'-0"

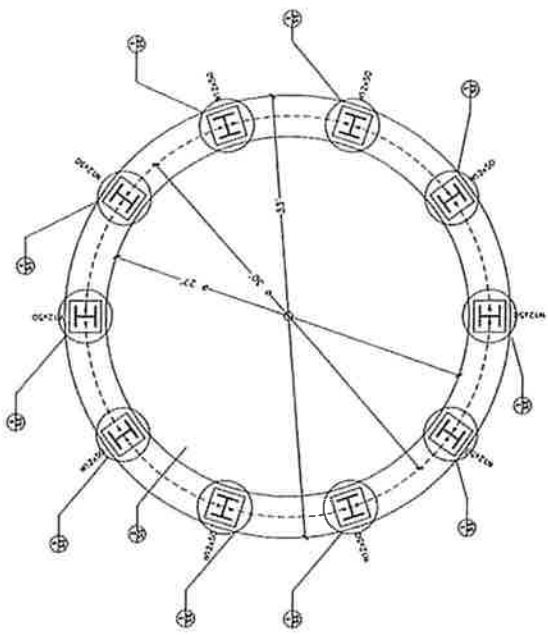

500 TON SILO FOUNDATION
 SCALE 1/4" = 1'-0"

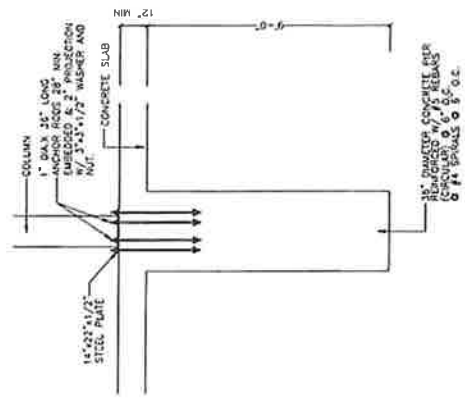

1
 SCALE 1/4" = 1'-0"

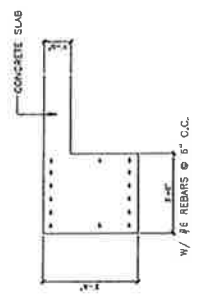

2
 SCALE 1/4" = 1'-0"



500 TON SILO
 NEW STEEL FABRICATORS
 2116 SHLISSEE RD, EL CENTRO, CA 92543
 SHEET TITLE
 60' AND 70' TOWER FOUNDATION

PROJECT

No.	REVISIONS	DATE

ENGINEER:

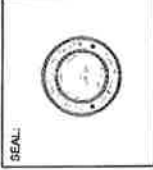

PROJECT # : SHEET:
 DATE: NOV 2022
 SCALE: 1/4"=1'-0"

S6

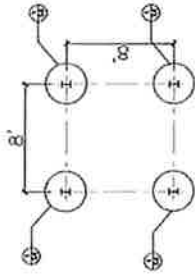
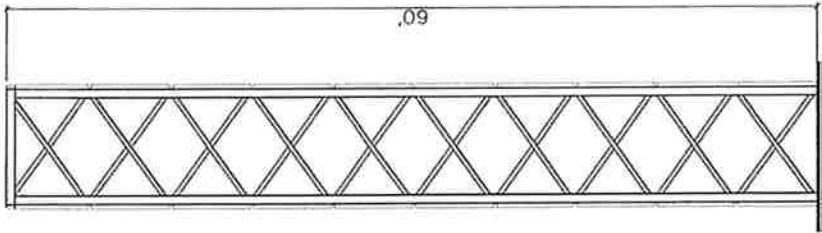

60 FT TOWER FOUNDATION
 SCALE 1/4" = 1'-0"

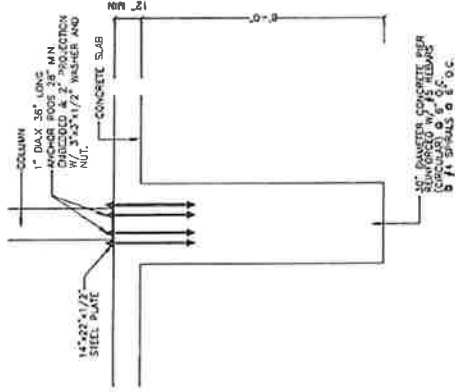

1
 SCALE 1/4" = 1'-0"



500 TON SILO
 NEW STEEL FABRICATORS
 2115 SILSBEE RD. E. CENTRO, CA 92323
 TWIN TOWERS FOUNDATION

PROJECT TITLE

No. REVISIONS DATE

ENGINEER

SEAL:



PROJECT #: SHEET: **S7**
 DATE: NOV 2022
 SCALE: 1/4"=1'-0"

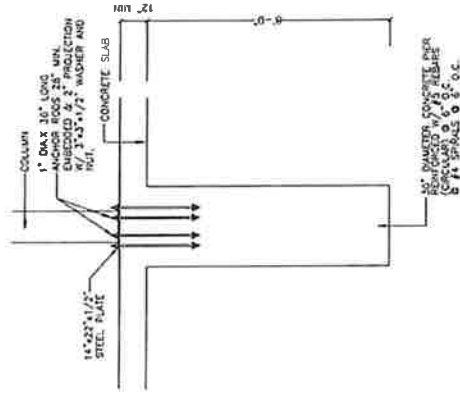

SCALE 1/4" = 1'-0"

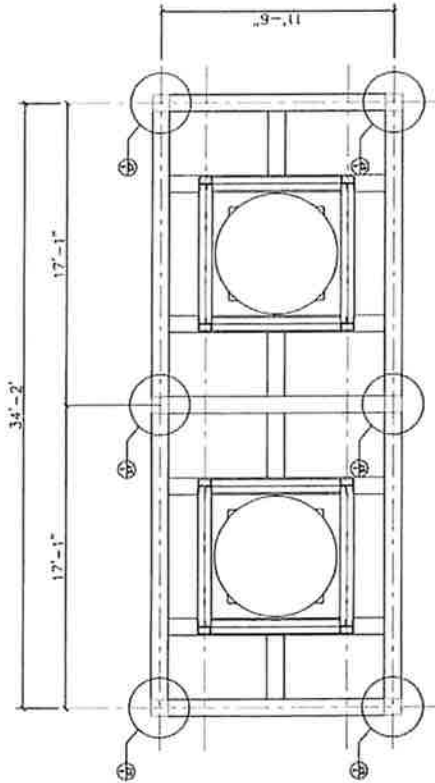

TWIN TOWERS FOUNDATION
 SCALE 1/4" = 1'-0"



← 2146 Silsbee Rd
El Centro, California
© Google Street View
Mar 2023 See more dates

far Commodities



Google



← 2146 Sishoo Rd
El Centro, California
Google Street View
Mar 2023 See more dates

1st Commodities

Google



